



FCC RADIO TEST REPORT

FCC ID : AZ489FT7151
Equipment : MSLB-MKZ920 400-512 4W LTE CBRS
GNSS BT WiFi
Brand Name : Motorola Solutions
Model Name : MSLB-MKZ920
Applicant : Motorola Solutions, Inc.
8000 West Sunrise Blvd , Ft Lauderdale,
Florida United States 33322
Manufacturer : Motorola Solutions, Inc.
8000 West Sunrise Blvd , Ft Lauderdale,
Florida United States 33322
Standard : FCC 47 CFR Part 2, 96

The product was received on Apr. 20, 2022 and testing was performed from May 25, 2022 to Jun. 06, 2022. We, Sporton International Inc. EMC & Wireless Communications Laboratory, would like to declare that the tested sample has been evaluated in accordance with the test procedures given in ANSI / TIA-603-E and has been in compliance with the applicable technical standards.

The test results in this report apply exclusively to the tested model / sample. Without written approval of Sporton International Inc. EMC & Wireless Communications Laboratory, the test report shall not be reproduced except in full.

Approved by: Louis Wu

Sporton International Inc. EMC & Wireless Communications Laboratory
No. 52, Huaya 1st Rd., Guishan Dist., Taoyuan City 333, Taiwan (R.O.C.)



Table of Contents

| | |
|---|-----------|
| History of this test report..... | 3 |
| Summary of Test Result..... | 4 |
| 1 General Description | 5 |
| 1.1 Product Feature of Equipment Under Test | 5 |
| 1.2 Product Specification of Equipment Under Test | 5 |
| 1.3 Modification of EUT | 5 |
| 1.4 Emission Designator | 6 |
| 1.5 Testing Location | 6 |
| 1.6 Applied Standards | 7 |
| 2 Test Configuration of Equipment Under Test | 8 |
| 2.1 Test Mode..... | 8 |
| 2.2 Connection Diagram of Test System | 9 |
| 2.3 Support Unit used in test configuration | 9 |
| 2.4 Measurement Results Explanation Example | 9 |
| 2.5 Frequency List of Low/Middle/High Channels | 10 |
| 3 Conducted Test Items..... | 11 |
| 3.1 Measuring Instruments..... | 11 |
| 3.2 Conducted Output Power | 12 |
| 3.3 Peak-to-Average Ratio | 13 |
| 3.4 EIRP | 14 |
| 3.5 Occupied Bandwidth | 15 |
| 3.6 Conducted Band Edge | 16 |
| 3.7 Conducted Spurious Emission | 17 |
| 3.8 Frequency Stability..... | 18 |
| 4 Radiated Test Items | 19 |
| 4.1 Measuring Instruments..... | 19 |
| 4.2 Test Setup | 19 |
| 4.3 Test Result of Radiated Test..... | 20 |
| 4.4 Radiated Spurious Emission | 21 |
| 5 List of Measuring Equipment..... | 22 |
| 6 Uncertainty of Evaluation..... | 24 |
| Appendix A. Test Results of Conducted Test | |
| Appendix B. Test Results of Radiated Test | |



Summary of Test Result

| Report Clause | Ref Std. Clause | Test Items | Result (PASS/FAIL) | Remark |
|---------------|-------------------|---|--------------------|--|
| 3.2 | §2.1046 | Conducted Output Power | Reporting only | - |
| 3.3 | §96.41 | Peak-to-Average Ratio | Pass | |
| 3.4 | §96.41 | Effective Isotropic Radiated Power | Pass | - |
| 3.5 | §2.1049 §96.41 | Occupied Bandwidth | Reporting only | - |
| 3.6 | §2.1051 §96.41 | Conducted Band Edge Measurement | Pass | - |
| 3.7 | §2.1051 §96.41 | Conducted Spurious Emission | Pass | |
| 3.8 | §2.1055 | Frequency Stability for Temperature & Voltage | Pass | - |
| 4.4 | §2.1051 §96.41 | Radiated Spurious Emission | Pass | Under limit 0.98 dB at 14205.000 MHz |

Declaration of Conformity:

1. The test results (PASS/FAIL) with all measurement uncertainty excluded are presented in accordance with the regulation limits or requirements declared by manufacturers. It's means measurement values may risk exceeding the limit of regulation standards, if measurement uncertainty is include in test results.
2. The measurement uncertainty please refer to this report "Uncertainty of Evaluation".

Comments and Explanations:

The product specifications of the EUT presented in the report are declared by the manufacturer who shall take full responsibility for the authenticity.

Reviewed by: Keven Cheng

Report Producer: Vivian Hsu

1 General Description

1.1 Product Feature of Equipment Under Test

| Product Feature | |
|---------------------------------|--|
| Equipment | MSLB-MKZ920 400-512 4W LTE CBRS GNSS BT WiFi |
| Brand Name | Motorola Solutions |
| Model Name | MSLB-MKZ920 |
| FCC ID | AZ489FT7151 |
| IMEI Code | Conducted : 350435580014334 Radiation : 350435580012478 |
| EUT supports Radios application | LTE |
| EUT Stage | Identical Prototype |

Remark: The above EUT's information was declared by manufacturer.

| Accessory List | | |
|----------------|--------------|----------|
| Battery 1 | Brand Name : | MOTOROLA |
| | Model Name : | PMNN4805 |
| Battery 2 | Brand Name : | MOTOROLA |
| | Model Name : | PMNN4803 |

1.2 Product Specification of Equipment Under Test

| Product Specification is subject to this standard | |
|---|----------------------------------|
| Tx Frequency | 3552.5 MHz ~ 3697.5 MHz |
| Rx Frequency | 3552.5 MHz ~ 3697.5 MHz |
| Bandwidth | 5 MHz / 10 MHz / 15 MHz / 20 MHz |
| Maximum Output Power to Antenna | 22.82 dBm |
| Antenna Type | FPC Antenna |
| Antenna Gain | -0.6 dBi |
| Type of Modulation | QPSK / 16QAM |

Remark: The above EUT's information was declared by manufacturer. Please refer to Comments and Explanations in report summary.

1.3 Modification of EUT

No modifications are made to the EUT during all test items.



1.4 Emission Designator

| LTE Band 48 | | QPSK | | | 16QAM | | |
|-------------|-----------------------|------------------------------|---------------------------|-----------------|------------------------------|---------------------------|-----------------|
| BW (MHz) | Frequency Range (MHz) | Emission Designator (99%OBW) | Frequency Tolerance (ppm) | Maximum EIRP(W) | Emission Designator (99%OBW) | Frequency Tolerance (ppm) | Maximum EIRP(W) |
| 5 | 3552.5~3697.5 | 4M50G7D | - | 0.1656 | 4M47W7D | - | 0.1406 |
| 10 | 3555~3695 | 9M09G7D | 0.0030 | 0.1663 | 9M03W7D | - | 0.1422 |
| 15 | 3557.5~3692.5 | 13M4G7D | - | 0.1648 | 13M5W7D | - | 0.1416 |
| 20 | 3560~3690 | 17M8G7D | - | 0.1667 | 17M8W7D | - | 0.1585 |

1.5 Testing Location

| | |
|------------------------------|--|
| Test Site | Sporton International Inc. EMC & Wireless Communications Laboratory |
| Test Site Location | No.52, Huaya 1st Rd., Guishan Dist., Taoyuan City 333, Taiwan (R.O.C.) TEL: +886-3-327-3456 FAX: +886-3-328-4978 |
| Test Site No. | Sporton Site No. TH03-HY |
| Test Engineer | HaoEn Zhang |
| Temperature (°C) | 22.3~24.1 |
| Relative Humidity (%) | 51.2~53.4 |

| | |
|------------------------------|--|
| Test Site | Sporton International Inc. Wensan Laboratory |
| Test Site Location | No.58, Aly. 75, Ln. 564, Wenhua 3rd, Rd., Guishan Dist., Taoyuan City 333010, Taiwan (R.O.C.) TEL: +886-3-327-0868 FAX: +886-3-327-0855 |
| Test Site No. | Sporton Site No. 03CH12-HY (TAF Code: 3786) |
| Test Engineer | Jack Cheng |
| Temperature (°C) | 22.3~26.4 |
| Relative Humidity (%) | 58~66 |
| Remark | The Radiated Spurious Emission test item subcontracted to Sporton International Inc. Wensan Laboratory. |

Note: The test site complies with ANSI C63.4 2014 requirement.

FCC Designation No.: TW1190 and TW3786



1.6 Applied Standards

According to the specifications of the manufacturer, the EUT must comply with the requirements of the following standards:

- ♦ ANSI C63.26-2015
- ♦ ANSI / TIA-603-E
- ♦ FCC 47 CFR Part 2, 96
- ♦ FCC KDB 971168 D01 Power Meas. License Digital Systems v03r01
- ♦ FCC KDB 940660 D01 Part 96 CBRS Eqpt v03
- ♦ FCC KDB 412172 D01 Determining ERP and EIRP v01r01
- ♦ FCC KDB 414788 D01 Radiated Test Site v01r01

Remark:

1. All test items were verified and recorded according to the standards and without any deviation during the test.
2. The TAF code is not including all the FCC KDB listed without accreditation.



2 Test Configuration of Equipment Under Test

2.1 Test Mode

Antenna port conducted and radiated test items listed below are performed according to KDB 971168 D01 Power Meas. License Digital Systems v03r01 with maximum output power.

For radiated measurement, the measured emission level of the EUT was maximized by rotating the EUT on a turntable, adjusting the orientation of the EUT and EUT antenna in three orthogonal axis (X: flat, Y: portrait, Z: landscape), and adjusting the measurement antenna orientation, following C63.26 exploratory test procedures and find Y Plane as worst plane.

| Test Items | Band | Bandwidth (MHz) | | | | Modulation | | RB # | | | Test Channel | | |
|-----------------------------|---|-----------------|----|----|----|------------|-------|------------|------|------|--------------|---|---|
| | | 5 | 10 | 15 | 20 | QPSK | 16QAM | 1 | Half | Full | L | M | H |
| Max. Output Power | 48 | v | v | v | v | v | v | v | v | v | v | v | v |
| 26dB and 99% Bandwidth | 48 | v | v | v | v | v | v | | | v | | v | |
| Conducted Band Edge | 48 | v | v | v | v | v | v | v | | v | v | v | v |
| Peak-to-Average Ratio | 48 | | | | v | v | v | | | v | | v | |
| Conducted Spurious Emission | 48 | v | v | v | v | v | | v | | | v | v | v |
| E.I.R.P | 48 | v | v | v | v | v | v | Max. Power | | | | | |
| Frequency Stability | 48 | | v | | | v | | v | | | | v | |
| Radiated Spurious Emission | 48 | Worst Case | | | | | | | | | v | v | v |
| Remark | <ol style="list-style-type: none"> The mark "v" means that this configuration is chosen for testing The mark "-" means that this bandwidth is not supported. The device is investigated from 30MHz to 10 times of fundamental signal for radiated spurious emission test under different RB size/offset and modulations in exploratory test. Subsequently, only the worst case emissions are reported. One representative bandwidth is selected to perform PAR and frequency stability. | | | | | | | | | | | | |

2.2 Connection Diagram of Test System

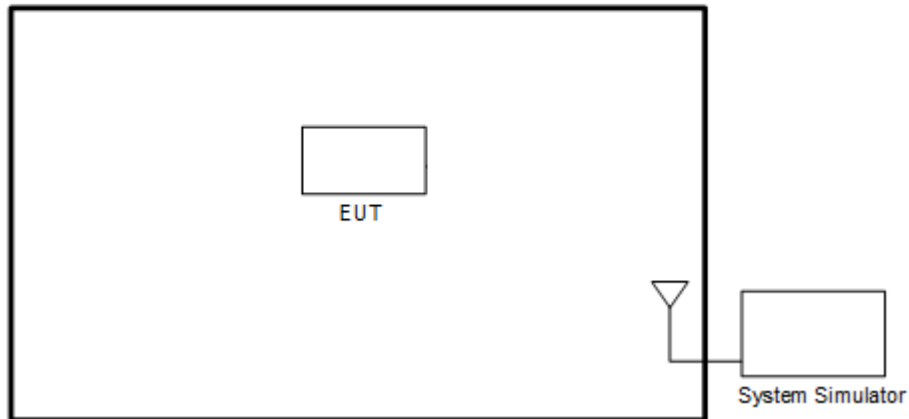

2.3 Support Unit used in test configuration

| Item | Equipment | Brand Name | Model No. | FCC ID | Data Cable | Power Cord |
|------|------------------|------------|-----------|--------|------------|-------------------|
| 1. | System Simulator | Anritsu | MT8821C | N/A | N/A | Unshielded, 1.8 m |

2.4 Measurement Results Explanation Example

For all conducted test items:

The offset level is set in the spectrum analyzer to compensate the RF cable loss and attenuator factor between EUT conducted output port and spectrum analyzer. With the offset compensation, the spectrum analyzer reading level is exactly the EUT RF output level.

The spectrum analyzer offset is derived from RF cable loss and attenuator factor.

Offset = RF cable loss + attenuator factor.

Following shows an offset computation example with cable loss 4.2 dB and 10dB attenuator.

Example :

Offset(dB) = RF cable loss(dB) + attenuator factor(dB).

$$= 4.2 + 10 = 14.2 \text{ (dB)}$$



2.5 Frequency List of Low/Middle/High Channels

| LTE Band 48 Channel and Frequency List | | | | |
|--|------------------------|--------|--------|---------|
| BW [MHz] | Channel/Frequency(MHz) | Lowest | Middle | Highest |
| 20 | Channel | 55340 | 55990 | 56640 |
| | Frequency | 3560.0 | 3625.0 | 3690.0 |
| 15 | Channel | 55315 | 55990 | 56665 |
| | Frequency | 3557.5 | 3625.0 | 3692.5 |
| 10 | Channel | 55290 | 55990 | 56690 |
| | Frequency | 3555.0 | 3625.0 | 3695.0 |
| 5 | Channel | 55265 | 55990 | 56715 |
| | Frequency | 3552.5 | 3625.0 | 3697.5 |

3 Conducted Test Items

3.1 Measuring Instruments

See list of measuring instruments of this test report.

3.1.1 Test Setup

3.1.2 Conducted Output Power



3.1.3 Peak-to-Average Ratio, Occupied Bandwidth, Conducted Band Edge and Conducted Spurious Emission

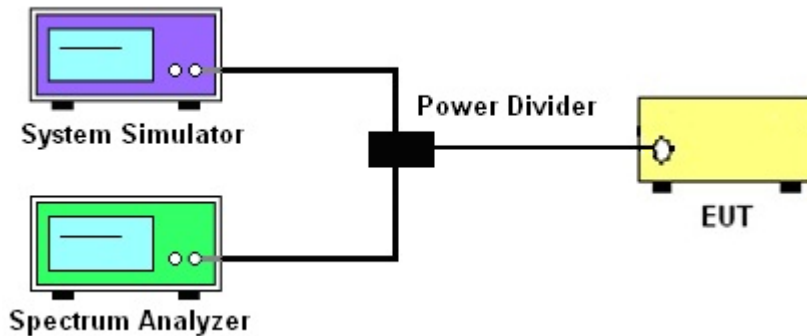

3.1.4 Frequency Stability

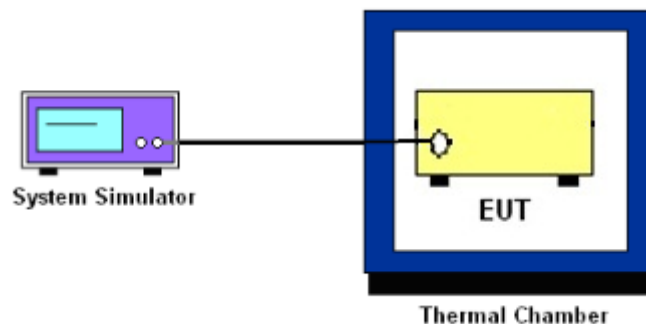

3.1.5 Test Result of Conducted Test

Please refer to Appendix A.



3.2 Conducted Output Power

3.2.1 Description of the Conducted Output Power Measurement

A system simulator was used to establish communication with the EUT. Its parameters were set to force the EUT transmitting at maximum output power. The measured power in the radio frequency on the transmitter output terminals shall be reported.

3.2.2 Test Procedures

1. The transmitter output port was connected to the system simulator.
2. Set EUT at maximum power through the system simulator.
3. Select lowest, middle, and highest channels for each band and different modulation.
4. Measure and record the power level from the system simulator.



3.3 Peak-to-Average Ratio

3.3.1 Description of the PAR Measurement

Power Complementary Cumulative Distribution Function (CCDF) curves provide a means for characterizing the power peaks of a digitally modulated signal on a statistical basis. A CCDF curve depicts the probability of the peak signal amplitude exceeding the average power level. Most contemporary measurement instrumentation include the capability to produce CCDF curves for an input signal provided that the instrument's resolution bandwidth can be set wide enough to accommodate the entire input signal bandwidth. In measuring transmissions in this band using an average power technique, the peak-to-average ratio (PAR) of the transmission may not exceed 13 dB.

3.3.2 Test Procedures

The testing follows ANSI C63.26-2015 Section 5.2.6

1. The EUT was connected to spectrum and system simulator via a power divider.
2. Set the CCDF (Complementary Cumulative Distribution Function) option in spectrum analyzer.
3. The highest RF powers were measured and recorded the maximum PAPR level associated with a probability of 0.1 %.
4. Record the deviation as Peak to Average Ratio



3.4 EIRP

3.4.1 Description of the EIRP Measurement

The EIRP of mobile transmitters must not exceed 23 dBm /10 megahertz for LTE Band 48.

The testing follows ANSI C63.26-2015 Section 5.2.5.5

According to KDB 412172 D01 Power Approach,

$EIRP = P_T + G_T - LC$, where

P_T = transmitter output power in dBm

G_T = gain of the transmitting antenna in dBi

LC = signal attenuation in the connecting cable between the transmitter and antenna in dB

| Device | Maximum EIRP (dBm/10 MHz) | Maximum PSD (dBm/MHz) |
|-----------------|------------------------------|--------------------------|
| End User Device | 23 | n/a |

Remark: Total channel power is complied with EIRP limit 23dBm/10MHz.

3.4.2 Test Procedures

The testing follows procedure in Section 5.2 of ANSI C63.26-2015 and KDB 940660 D01 Part 96 CBRS Eqpt v03 Section 3.2(b)(2)

Determine the EIRP by adding the effective antenna gain to the measured average conducted power level.



3.5 Occupied Bandwidth

3.5.1 Description of Occupied Bandwidth Measurement

The occupied bandwidth is the width of a frequency band such that, below the lower and above the upper frequency limits, the mean powers emitted are each equal to a specified percentage 0.5% of the total mean transmitted power.

The 26 dB emission bandwidth is defined as the frequency range between two points, one above and one below the carrier frequency, at which the spectral density of the emission is attenuated 26 dB below the maximum in-band spectral density of the modulated signal. Spectral density (power per unit bandwidth) is to be measured with a detector of resolution bandwidth equal to approximately 1.0% of the emission bandwidth.

3.5.2 Test Procedures

The testing follows ANSI C63.26-2015 Section 5.4.3 (26dB) and Section 5.4.4 (99OB)

1. The EUT was connected to spectrum analyzer and system simulator via a power divider.
2. The spectrum analyzer center frequency is set to the nominal EUT channel center frequency. The span range for the spectrum analyzer shall be between two and five times the anticipated OBW.
3. The nominal resolution bandwidth (RBW) shall be in the range of 1 to 5 % of the anticipated OBW, and the VBW shall be at least 3 times the RBW.
4. Set the detection mode to peak, and the trace mode to max hold.
5. Determine the reference value: Set the EUT to transmit a modulated signal. Allow the trace to stabilize. Set the spectrum analyzer marker to the highest level of the displayed trace.
(this is the reference value)
6. Determine the “-26 dB down amplitude” as equal to (Reference Value – X).
7. Place two markers, one at the lowest and the other at the highest frequency of the envelope of the spectral display such that each marker is at or slightly below the “-X dB down amplitude” determined in step 6. If a marker is below this “-X dB down amplitude” value it shall be placed as close as possible to this value. The OBW is the positive frequency difference between the two markers.
8. Use the 99 % power bandwidth function of the spectrum analyzer and report the measured bandwidth.



3.6 Conducted Band Edge

3.6.1 Description of Conducted Band Edge Measurement

The conducted power of any End User Device emission outside the fundamental emission (whether in or outside of the authorized band) shall not exceed -13 dBm/MHz within 0 to B megahertz (where B is the bandwidth in megahertz of the assigned channel or multiple contiguous channels of the End User Device) above the upper CBSD-assigned channel edge and within 0 to B megahertz below the lower CBSD-assigned channel edge. At all frequencies greater than B megahertz above the upper CBSD assigned channel edge and less than B megahertz below the lower CBSD-assigned channel edge, the conducted power of any End User Device emission shall not exceed -25 dBm/MHz. Notwithstanding the emission limits in this paragraph, the Adjacent Channel Leakage Ratio for End User Devices shall be at least 30 dB.

3.6.2 Test Procedures

The testing follows FCC KDB 971168 D01 v03r01 Section 6.1.

1. The EUT was connected to spectrum analyzer and system simulator via a power divider.
2. The band edges of low and high channels for the highest RF powers were measured.
3. Set RBW $\geq 1\%$ EBW in the 1MHz band immediately outside and adjacent to the band edge.
4. Beyond the 1 MHz band from the band edge, RBW=1MHz was used
5. Set spectrum analyzer with RMS detector.
6. The RF fundamental frequency should be excluded against the limit line in the operating frequency band.

For Adjacent Channel Leakage Ratio (ACLR) measurement,

1. The Adjacent Channel Leakage Ratio (ACLR) is the ratio of the average power in the assigned aggregated channel bandwidth to the average power over the equivalent adjacent channel bandwidth.
2. The option ACLR of spectrum analyzer is used and measures the ACLR ratio by setting equivalent channel bandwidth.
3. The measured ACLR ratio shall be at least 30 dB.



3.7 Conducted Spurious Emission

3.7.1 Description of Conducted Spurious Emission Measurement

96.41 (e)(2)

The conducted power of any emissions below 3530 MHz or above 3720 MHz shall not exceed -40dBm/MHz.

3.7.2 Test Procedures

The testing follows FCC KDB 971168 D01 v03r01 Section 6.1.

1. The EUT was connected to spectrum analyzer and system simulator via a power divider.
2. The RF output of EUT was connected to the spectrum analyzer by RF cable and attenuator. The path loss was compensated to the results for each measurement.
3. The middle channel for the highest RF power within the transmitting frequency was measured.
4. The conducted spurious emission for the whole frequency range was taken.
5. Make the measurement with the spectrum analyzer's RBW = 1MHz, VBW = 3MHz.
6. Set spectrum analyzer with RMS detector.
7. Taking the record of maximum spurious emission.
8. The RF fundamental frequency should be excluded against the limit line in the operating frequency band.
9. The limit line is -40dBm/MHz.



3.8 Frequency Stability

3.8.1 Description of Frequency Stability Measurement

The frequency stability shall be measured by variation of ambient temperature and variation of primary supply voltage to ensure that the fundamental emission stays within the authorized frequency block. The frequency stability of the transmitter shall be maintained within product's specification $\pm 0.00001\%$ ($\pm 0.1\text{ppm}$) of the center frequency.

3.8.2 Test Procedures for Temperature Variation

The testing follows FCC KDB 971168 D01 v03r01 Section 9.0.

1. The EUT was set up in the thermal chamber and connected with the system simulator.
2. With power OFF, the temperature was decreased to -30°C and the EUT was stabilized before testing. Power was applied and the maximum change in frequency was recorded within one minute.
3. With power OFF, the temperature was raised in 10°C step up to 50°C . The EUT was stabilized at each step for at least half an hour. Power was applied and the maximum frequency change was recorded within one minute.

3.8.3 Test Procedures for Voltage Variation

The testing follows FCC KDB 971168 D01 v03r01 Section 9.0.

1. The EUT was placed in a temperature chamber at $25\pm 5^{\circ}\text{C}$ and connected with the system simulator.
2. The power supply voltage to the EUT was varied from 85% to 115% of the nominal value measured at the input to the EUT.
3. The variation in frequency was measured for the worst case.

4 Radiated Test Items

4.1 Measuring Instruments

See list of measuring instruments of this test report.

4.2 Test Setup

For radiated emissions below 30MHz

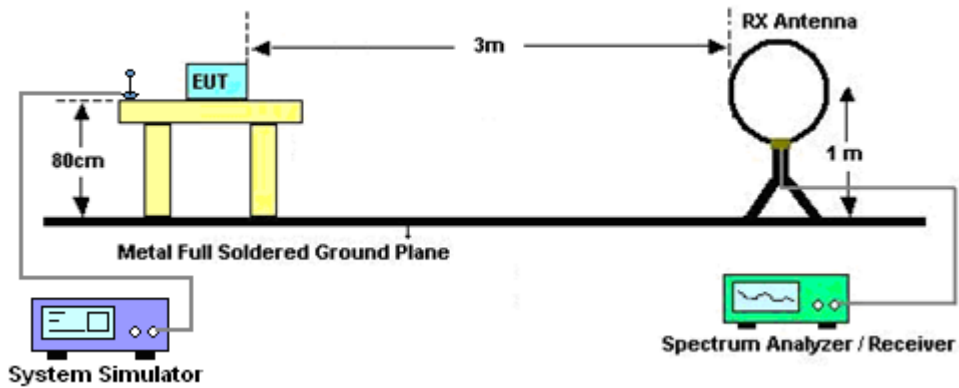

For radiated emissions from 30MHz to 1GHz

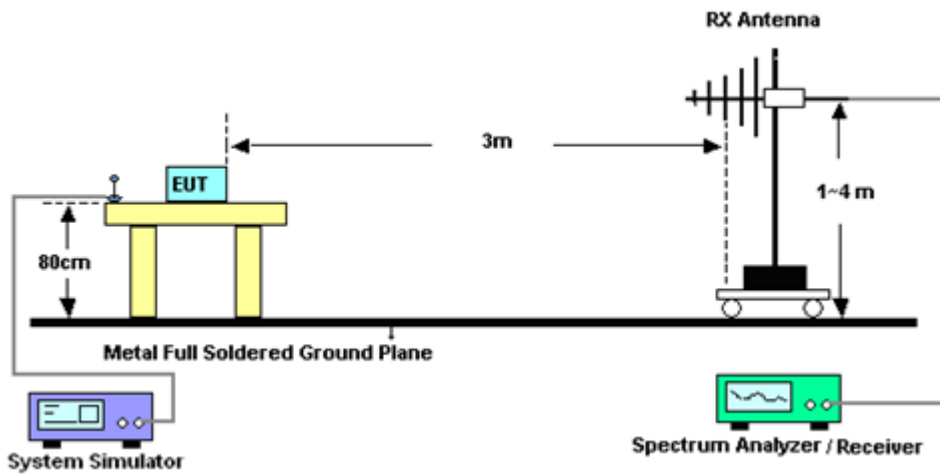

For radiated emissions from 1GHz to 18GHz

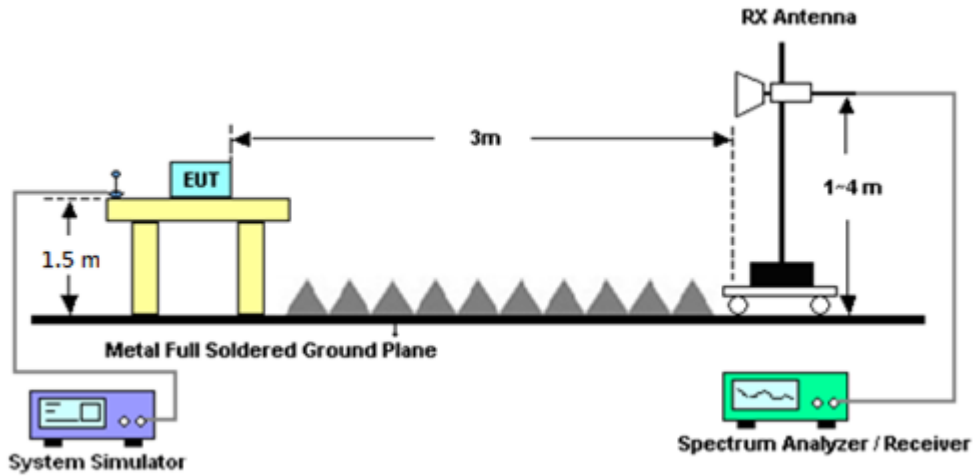

For radiated emissions above 18GHz

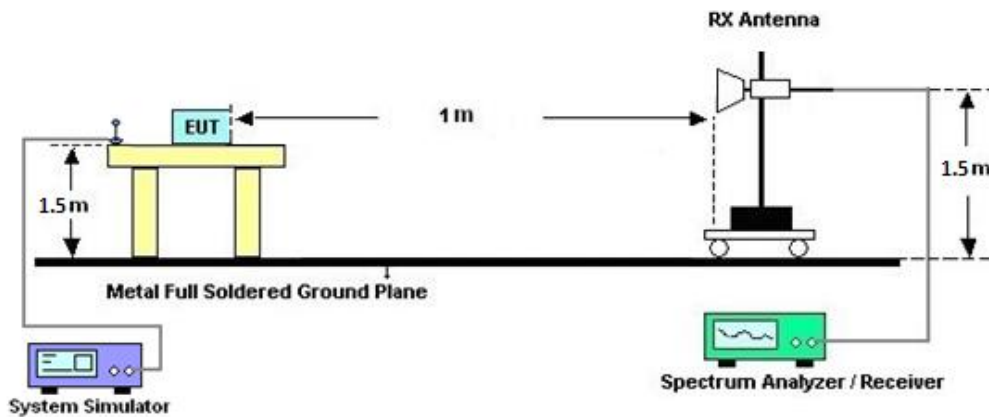

4.3 Test Result of Radiated Test

Please refer to Appendix B.

Note:

The low frequency, which started from 9 kHz to 30MHz, was pre-scanned and the result which was 20dB lower than the limit line was not reported.

There is adequate comparison measurement of both open-field test site and alternative test site - semi-Anechoic chamber according to 414788 D01 Radiated Test Site v01r01, and the result came out very similar.



4.4 Radiated Spurious Emission

4.4.1 Description of Radiated Spurious Emission Measurement

The radiated spurious emission was measured by substitution method according to ANSI / TIA-603-E. The power of any emission outside of the authorized operating frequency ranges must be attenuated below the transmitter power (P) by a factor of at least -40dBm / MHz .

The spectrum is scanned from 30 MHz up to a frequency including its 10th harmonic.

4.4.2 Test Procedures

The testing follows FCC KDB 971168 D01 v03r01 Section 7 and ANSI / TIA-603-E Section 2.2.12.

1. The EUT was placed on a turntable with 0.8 meter height for frequency below 1GHz and 1.5 meter height for frequency above 1GHz respectively above ground.
2. The EUT was set 3 meters from the receiving antenna mounted on the antenna tower.
3. The table was rotated 360 degrees to determine the position of the highest spurious emission.
4. The height of the receiving antenna is varied between 1m to 4m to search the maximum spurious emission for both horizontal and vertical polarizations.
5. During the measurement, the system simulator parameters were set to force the EUT transmitting at maximum output power.
6. Make the measurement with the spectrum analyzer's RBW = 1MHz, VBW = 3MHz, taking the record of maximum spurious emission.
7. A horn antenna was substituted in place of the EUT and was driven by a signal generator. Tune the output power of signal generator to the same emission level with EUT maximum spurious emission.
EIRP (dBm) = S.G. Power – Tx Cable Loss + Tx Antenna Gain
ERP (dBm) = EIRP - 2.15
8. The RF fundamental frequency should be excluded against the limit line in the operating frequency band.



5 List of Measuring Equipment

| Instrument | Brand Name | Model No. | Serial No. | Characteristics | Calibration Date | Test Date | Due Date | Remark |
|-------------------------|-------------------------------|--------------------------------------|---------------------|----------------------------------|------------------|---------------------------------|---------------|--------------------------|
| Loop Antenna | Rohde & Schwarz | HFH2-Z2 | 100488 | 9 kHz~30 MHz | Sep. 07, 2021 | Jun. 02, 2022~ Jun. 06, 2022 | Sep. 06, 2022 | Radiation (03CH12-HY) |
| Bilog Antenna | TESEQ | CBL 6111D & 00800N1D01N -06 | 37059 & 01 | 30MHz~1GHz | Oct. 09, 2021 | Jun. 02, 2022~ Jun. 06, 2022 | Oct. 08, 2022 | Radiation (03CH12-HY) |
| Bilog Antenna | TESEQ | CBL 6111D & N-6-06 | 35414 & AT-N0602 | 30MHz~1GHz | Oct. 09, 2021 | Jun. 02, 2022~ Jun. 06, 2022 | Oct. 08, 2022 | Radiation (03CH12-HY) |
| Horn Antenna | SCHWARZBE CK | BBHA 9120 D | 9120D-1328 | 1GHz~18GHz | Dec. 03, 2021 | Jun. 02, 2022~ Jun. 06, 2022 | Dec. 02, 2022 | Radiation (03CH12-HY) |
| Horn Antenna | SCHWARZBE CK | BBHA 9120 D | 9120D-1212 | 1GHz~18GHz | Mar. 10, 2022 | Jun. 02, 2022~ Jun. 06, 2022 | Mar. 09, 2023 | Radiation (03CH12-HY) |
| SHF-EHF Horn Antenna | SCHWARZBE CK | BBHA 9170 | BBHA91702 51 | 18GHz~40GHz | Nov. 30, 2021 | Jun. 02, 2022~ Jun. 06, 2022 | Nov. 29, 2022 | Radiation (03CH12-HY) |
| SHF-EHF Horn Antenna | SCHWARZBE CK | BBHA 9170 | BBHA91705 76 | 18GHz~40GHz | May 14, 2022 | Jun. 02, 2022~ Jun. 06, 2022 | May 13, 2023 | Radiation (03CH12-HY) |
| Preamplifier | COM-POWER | PA-103 | 161075 | 10MHz~1GHz | Mar. 23, 2022 | Jun. 02, 2022~ Jun. 06, 2022 | Mar. 22, 2023 | Radiation (03CH12-HY) |
| Preamplifier | Aglient | 8449B | 3008A02375 | 1GHz~26.5GHz | May 24, 2022 | Jun. 02, 2022~ Jun. 06, 2022 | May 23, 2023 | Radiation (03CH12-HY) |
| Preamplifier | E-INSTRUME NT TECH LTD. | ERA-100M-18 G-56-01-A70 | EC1900270 | 1GHz-18GHz | Dec. 27, 2021 | Jun. 02, 2022~ Jun. 06, 2022 | Dec. 26, 2022 | Radiation (03CH12-HY) |
| Preamplifier | EMEC | EM18G40G | 060715 | 18GHz~40GHz | Dec. 24, 2021 | Jun. 02, 2022~ Jun. 06, 2022 | Dec. 23, 2022 | Radiation (03CH12-HY) |
| Spectrum Analyzer | Keysight | N9010A | MY53470118 | 10Hz~44GHz | Jan. 12, 2022 | Jun. 02, 2022~ Jun. 06, 2022 | Jan. 11, 2023 | Radiation (03CH12-HY) |
| RF Cable | HUBER + SUHNER | SUCOFLEX 104 | MY9837/4PE | 9kHz~30MHz | Mar. 10, 2022 | Jun. 02, 2022~ Jun. 06, 2022 | Mar. 09, 2023 | Radiation (03CH12-HY) |
| RF Cable | HUBER + SUHNER | SUCOFLEX 126E | 0058/126E | 30MHz~18GHz | Dec. 10, 2021 | Jun. 02, 2022~ Jun. 06, 2022 | Dec. 09, 2022 | Radiation (03CH12-HY) |
| RF Cable | HUBER + SUHNER | SUCOFLEX 102 | 505134/2 | 30MHz~40GHz | Feb. 21, 2022 | Jun. 02, 2022~ Jun. 06, 2022 | Feb. 20, 2023 | Radiation (03CH12-HY) |
| RF Cable | HUBER + SUHNER | SUCOFLEX 102 | 803953/2 | 30MHz~40GHz | Mar. 08, 2022 | Jun. 02, 2022~ Jun. 06, 2022 | Mar. 07, 2023 | Radiation (03CH12-HY) |
| Filter | Wainwright | WHKX8-5872. 5-6750-18000- 40ST | SN2 | 6.75GHz High Pass Filter | Mar. 16, 2022 | Jun. 02, 2022~ Jun. 06, 2022 | Mar. 15, 2023 | Radiation (03CH12-HY) |
| Hygrometer | TECPEL | DTM-303B | TP140349 | N/A | Sep. 30, 2021 | Jun. 02, 2022~ Jun. 06, 2022 | Sep. 29, 2022 | Radiation (03CH12-HY) |
| Controller | EMEC | EM1000 | N/A | Control Turn table & Ant Mast | N/A | Jun. 02, 2022~ Jun. 06, 2022 | N/A | Radiation (03CH12-HY) |
| Antenna Mast | EMEC | AM-BS-4500-B | N/A | 1m~4m | N/A | Jun. 02, 2022~ Jun. 06, 2022 | N/A | Radiation (03CH12-HY) |
| Turn Table | EMEC | TT2000 | N/A | 0~360 Degree | N/A | Jun. 02, 2022~ Jun. 06, 2022 | N/A | Radiation (03CH12-HY) |
| Software | Audix | E3 6.2009-8-24 | RK-000989 | N/A | N/A | Jun. 02, 2022~ Jun. 06, 2022 | N/A | Radiation (03CH12-HY) |



| Instrument | Brand Name | Model No. | Serial No. | Characteristics | Calibration Date | Test Date | Due Date | Remark |
|------------------------------|-----------------|----------------------------------|------------|---|------------------|----------------------------|---------------|---------------------|
| Radio Communication Analyzer | Anritsu | MT8821C | 6201664755 | 2/3/4G/LTE FDD/TDD with44)/LTE-3CC DLCA/2CC ULCA, CatM1/NB1/NB2 | Jul. 21, 2021 | May 25, 2022~ May 26, 2022 | Jul. 20, 2022 | Conducted (TH03-HY) |
| Spectrum Analyzer | Rohde & Schwarz | FSV40 | 101908 | 10Hz~40GHz | Oct. 01, 2021 | May 25, 2022~ May 26, 2022 | Sep. 30, 2022 | Conducted (TH03-HY) |
| Thermal Chamber | ESPEC | SH-641 | 92013720 | -40°C ~90°C | Sep. 09, 2021 | May 25, 2022~ May 26, 2022 | Sep. 08, 2022 | Conducted (TH03-HY) |
| DC Power Supply | GW Instek | GPP-2323 | GES906037 | 0V~64V : 0A~6A | Jan. 06, 2022 | May 25, 2022~ May 26, 2022 | Jan. 05, 2023 | Conducted (TH03-HY) |
| Coupler | Warison | 20dB 25W SMA Directional Coupler | #B | 1-18GHz | Jan. 07, 2022 | May 25, 2022~ May 26, 2022 | Jan. 06, 2023 | Conducted (TH03-HY) |



6 Uncertainty of Evaluation

Uncertainty of Radiated Emission Measurement (30 MHz ~ 1000 MHz)

| | |
|---|---------|
| Measuring Uncertainty for a Level of Confidence of 95% ($U = 2Uc(y)$) | 3.10 dB |
|---|---------|

Uncertainty of Radiated Emission Measurement (1 GHz ~ 18 GHz)

| | |
|---|---------|
| Measuring Uncertainty for a Level of Confidence of 95% ($U = 2Uc(y)$) | 3.39 dB |
|---|---------|

Uncertainty of Radiated Emission Measurement (18 GHz ~ 40 GHz)

| | |
|---|---------|
| Measuring Uncertainty for a Level of Confidence of 95% ($U = 2Uc(y)$) | 4.34 dB |
|---|---------|



Appendix A. Test Results of Conducted Test

Conducted Output Power (Average power & EIRP)

| LTE Band 48 Maximum Average Power [dBm] (GT - LC = -0.6 dB) | | | | | | | | |
|---|--------------------|-----------|--------|--------|--------|---------|------------|----------|
| BW [MHz] | RB Size | RB Offset | Mod | Lowest | Middle | Highest | EIRP (dBm) | EIRP (W) |
| 20 | 1 | 0 | QPSK | 20.16 | 22.82 | 22.31 | 22.22 | 0.1667 |
| 20 | 1 | 99 | | 20.31 | 22.71 | 22.44 | | |
| 20 | 100 | 0 | | 20.73 | 20.50 | 20.73 | | |
| 20 | 1 | 0 | 16-QAM | 19.47 | 21.95 | 22.60 | 22.00 | 0.1585 |
| 20 | 1 | 99 | | 19.61 | 22.06 | 21.76 | | |
| 20 | 100 | 0 | | 19.85 | 19.55 | 19.85 | | |
| Limit | EIRP < 23dBm/10MHz | | | Result | | | Pass | |

Total EIRP power is less than partial EIRP limit 23 dBm/10MHz.

| LTE Band 48 Maximum Average Power [dBm] (GT - LC = -0.6 dB) | | | | | | | | |
|---|--------------------|-----------|--------|--------|--------|---------|------------|----------|
| BW [MHz] | RB Size | RB Offset | Mod | Lowest | Middle | Highest | EIRP (dBm) | EIRP (W) |
| 15 | 1 | 0 | QPSK | 20.17 | 22.76 | 22.43 | 22.17 | 0.1648 |
| 15 | 1 | 74 | | 20.38 | 22.77 | 22.57 | | |
| 15 | 75 | 0 | | 20.30 | 20.52 | 20.08 | | |
| 15 | 1 | 0 | 16-QAM | 19.54 | 22.07 | 21.71 | 21.51 | 0.1416 |
| 15 | 1 | 74 | | 19.72 | 22.11 | 21.89 | | |
| 15 | 75 | 0 | | 19.42 | 19.59 | 19.15 | | |
| Limit | EIRP < 23dBm/10MHz | | | Result | | | Pass | |

Total EIRP power is less than partial EIRP limit 23 dBm/10MHz.

| LTE Band 48 Maximum Average Power [dBm] (GT - LC = -0.6 dB) | | | | | | | | |
|---|--------------------|-----------|--------|--------|--------|---------|------------|----------|
| BW [MHz] | RB Size | RB Offset | Mod | Lowest | Middle | Highest | EIRP (dBm) | EIRP (W) |
| 10 | 1 | 0 | QPSK | 20.19 | 22.72 | 22.32 | 22.21 | 0.1663 |
| 10 | 1 | 49 | | 20.29 | 22.81 | 22.46 | | |
| 10 | 50 | 0 | | 20.32 | 22.00 | 22.21 | | |
| 10 | 1 | 0 | 16-QAM | 19.52 | 22.08 | 21.67 | 21.53 | 0.1422 |
| 10 | 1 | 49 | | 19.69 | 22.13 | 21.83 | | |
| 10 | 50 | 0 | | 19.44 | 21.11 | 21.32 | | |
| Limit | EIRP < 23dBm/10MHz | | | Result | | | Pass | |

Total EIRP power is less than partial EIRP limit 23 dBm/10MHz.

| LTE Band 48 Maximum Average Power [dBm] (GT - LC = -0.6 dB) | | | | | | | | |
|---|--------------------|-----------|--------|--------|--------|---------|------------|----------|
| BW [MHz] | RB Size | RB Offset | Mod | Lowest | Middle | Highest | EIRP (dBm) | EIRP (W) |
| 5 | 1 | 0 | QPSK | 20.29 | 22.69 | 22.46 | 22.19 | 0.1656 |
| 5 | 1 | 24 | | 20.28 | 22.79 | 22.44 | | |
| 5 | 25 | 0 | | 20.31 | 21.97 | 22.21 | | |
| 5 | 1 | 0 | 16-QAM | 19.55 | 22.08 | 21.72 | 21.48 | 0.1406 |
| 5 | 1 | 24 | | 19.61 | 22.07 | 21.76 | | |
| 5 | 25 | 0 | | 19.39 | 21.08 | 21.31 | | |
| Limit | EIRP < 23dBm/10MHz | | | Result | | | Pass | |

Total EIRP power is less than partial EIRP limit 23 dBm/10MHz.



LTE Band 48

Peak-to-Average Ratio

| Mode | LTE Band 48 / 20MHz | | |
|-----------|---------------------|---------|-------------|
| Mod. | QPSK | 16QAM | Limit: 13dB |
| RB Size | Full RB | Full RB | Result |
| Middle CH | 4.67 | 6.06 | PASS |

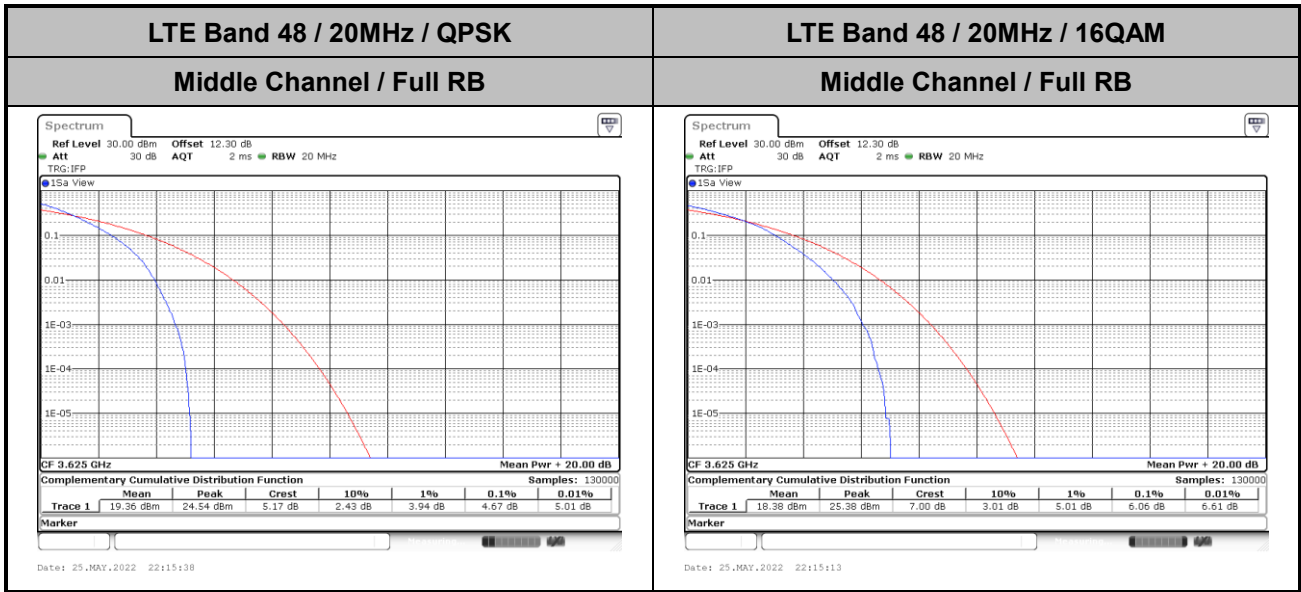



26dB Bandwidth

| Mode | LTE Band 48 : 26dB BW(MHz) | | | | | | | | | | | |
|-----------|----------------------------|---------|-------|---------|-------|---------|-------|---------|-------|---------|-------|---------|
| BW | 1.4MHz | | 3MHz | | 5MHz | | 10MHz | | 15MHz | | 20MHz | |
| Mod. | QPSK | 16QAM | QPSK | 16QAM | QPSK | 16QAM | QPSK | 16QAM | QPSK | 16QAM | QPSK | 16QAM |
| Middle CH | - | - | - | - | 4.83 | 5.10 | 9.69 | 9.69 | 14.36 | 14.15 | 18.62 | 18.66 |
| Mode | LTE Band 48 : 26dB BW(MHz) | | | | | | | | | | | |
| BW | 1.4MHz | | 3MHz | | 5MHz | | 10MHz | | 15MHz | | 20MHz | |
| Mod. | 64QAM | 256 QAM | 64QAM | 256 QAM | 64QAM | 256 QAM | 64QAM | 256 QAM | 64QAM | 256 QAM | 64QAM | 256 QAM |
| Middle CH | - | - | - | - | - | - | - | - | - | - | - | - |



LTE Band 48

Middle Channel / 5MHz / QPSK

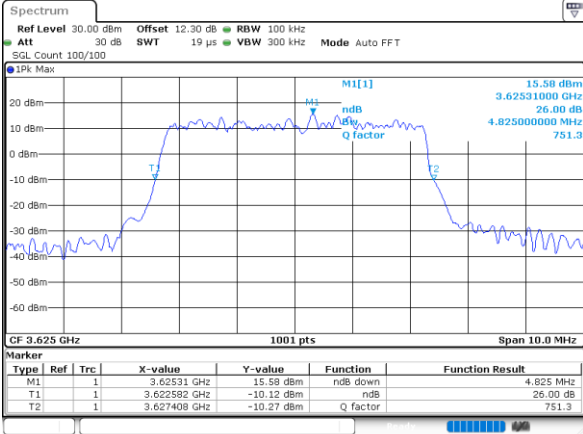

Date: 25.MAY.2022 22:09:39

Middle Channel / 5MHz / 16QAM

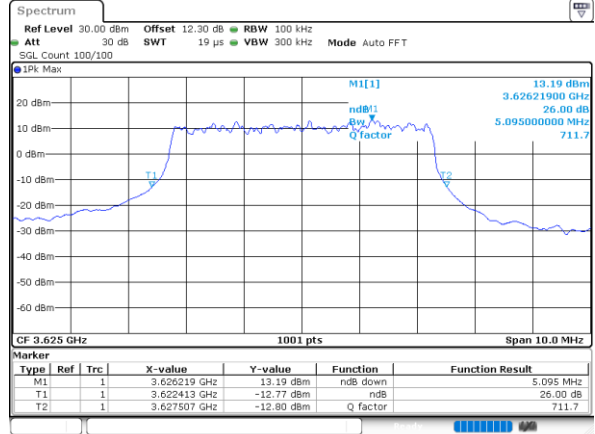

Date: 25.MAY.2022 22:10:02

Middle Channel / 10MHz / QPSK

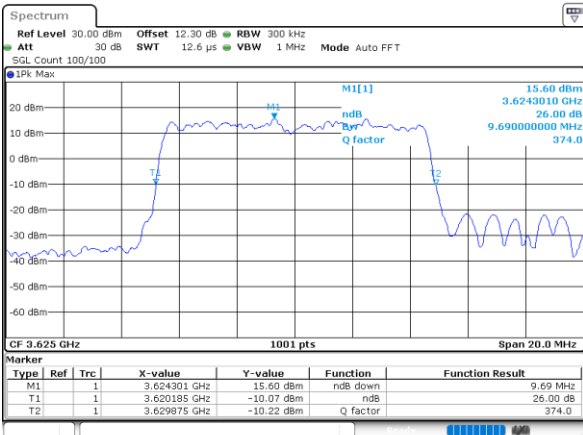

Date: 25.MAY.2022 22:11:14

Middle Channel / 10MHz / 16QAM

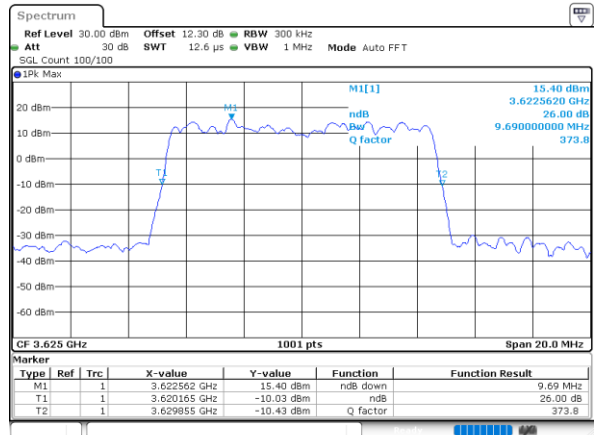

Date: 25.MAY.2022 22:11:38

Middle Channel / 15MHz / QPSK

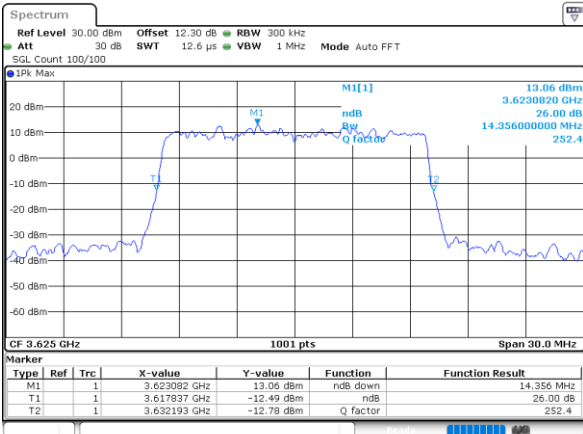

Date: 25.MAY.2022 22:12:49

Middle Channel / 15MHz / 16QAM

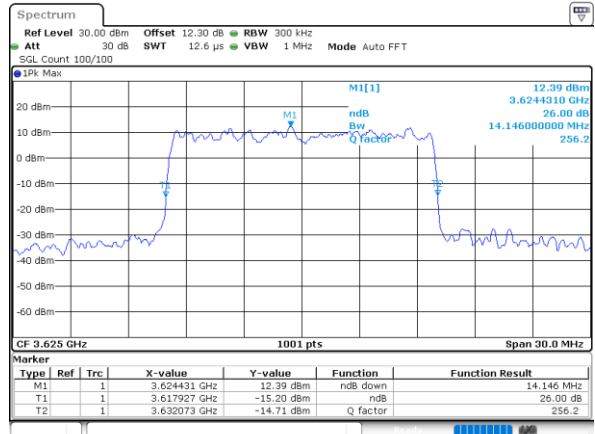

Date: 25.MAY.2022 22:13:13



LTE Band 48

Middle Channel / 20MHz / QPSK

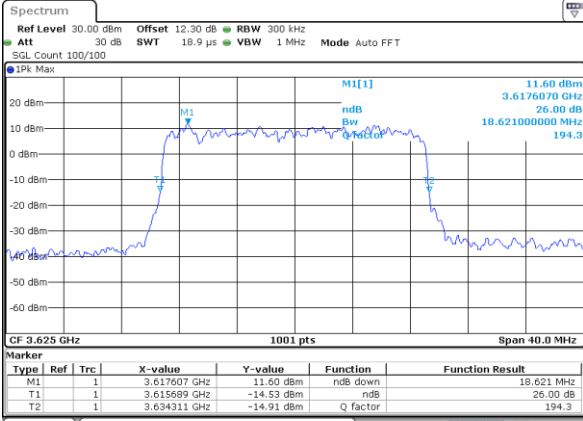

Middle Channel / 20MHz / 16QAM

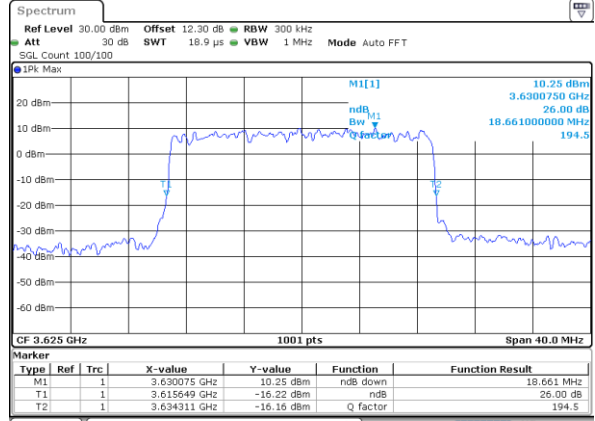



Occupied Bandwidth

| Mode | LTE Band 48 : 99%OBW(MHz) | | | | | | | | | | | |
|-----------|---------------------------|---------|-------|---------|-------|---------|-------|---------|-------|---------|-------|---------|
| BW | 1.4MHz | | 3MHz | | 5MHz | | 10MHz | | 15MHz | | 20MHz | |
| Mod. | QPSK | 16QAM | QPSK | 16QAM | QPSK | 16QAM | QPSK | 16QAM | QPSK | 16QAM | QPSK | 16QAM |
| Middle CH | - | - | - | - | 4.50 | 4.47 | 9.09 | 9.03 | 13.40 | 13.46 | 17.78 | 17.82 |
| Mode | LTE Band 48 : 99%OBW(MHz) | | | | | | | | | | | |
| BW | 1.4MHz | | 3MHz | | 5MHz | | 10MHz | | 15MHz | | 20MHz | |
| Mod. | 64QAM | 256 QAM | 64QAM | 256 QAM | 64QAM | 256 QAM | 64QAM | 256 QAM | 64QAM | 256 QAM | 64QAM | 256 QAM |
| Middle CH | - | - | - | - | - | - | - | - | - | - | - | - |



LTE Band 48

Middle Channel / 5MHz / QPSK

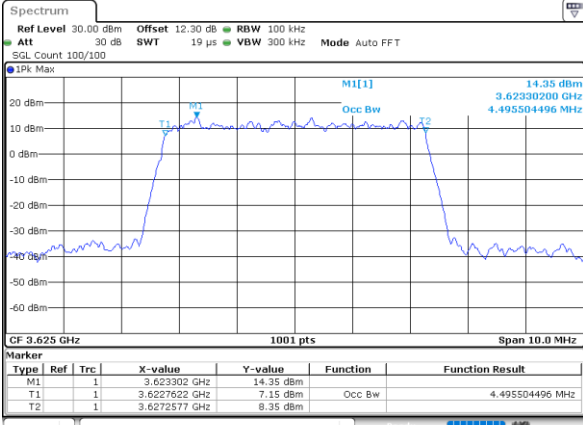

Date: 25.MAY.2022 22:08:51

Middle Channel / 5MHz / 16QAM

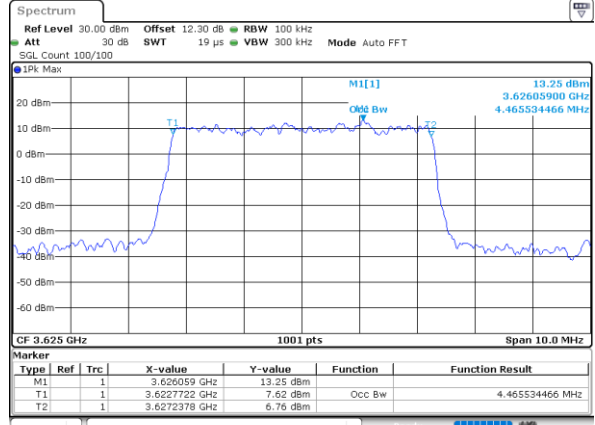

Date: 25.MAY.2022 22:09:15

Middle Channel / 10MHz / QPSK

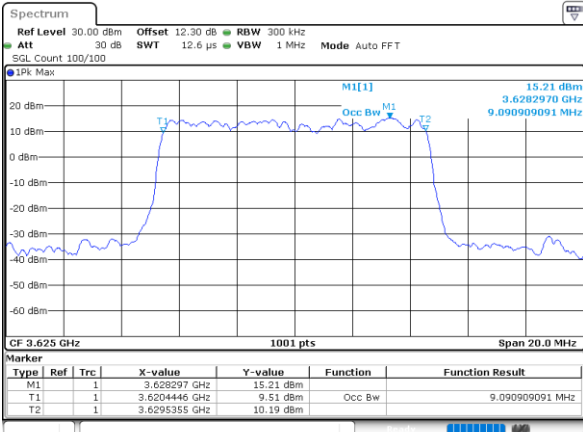

Date: 25.MAY.2022 22:10:27

Middle Channel / 10MHz / 16QAM

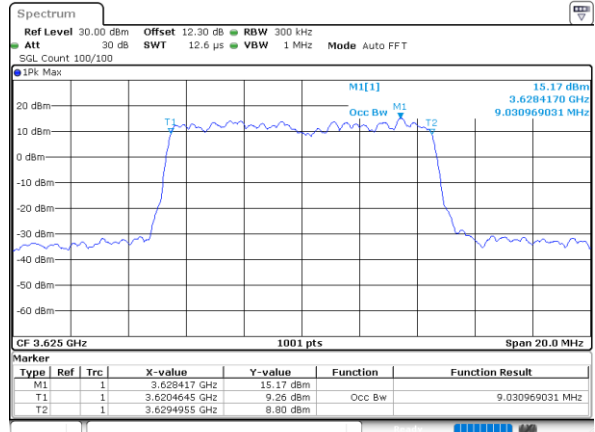

Date: 25.MAY.2022 22:10:50

Middle Channel / 15MHz / QPSK

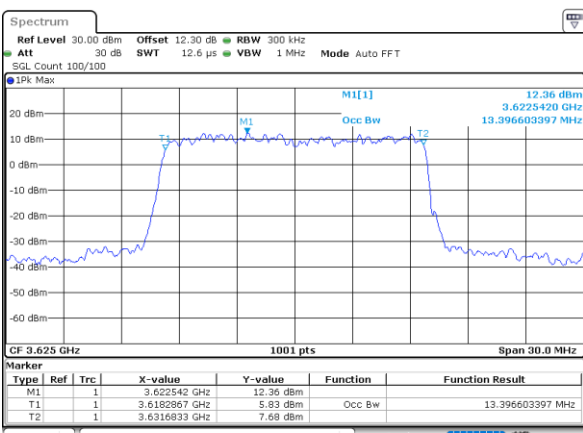

Date: 25.MAY.2022 22:12:02

Middle Channel / 15MHz / 16QAM

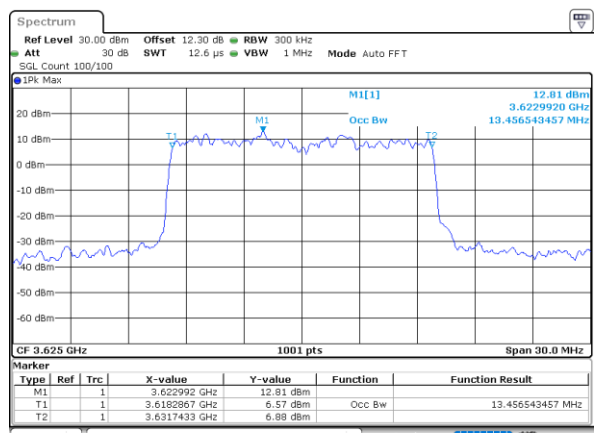

Date: 25.MAY.2022 22:12:26



LTE Band 48

Middle Channel / 20MHz / QPSK

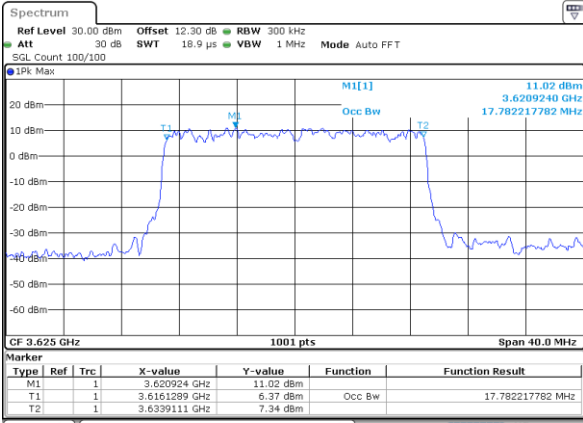

Date: 25.MAY.2022 22:13:38

Middle Channel / 20MHz / 16QAM

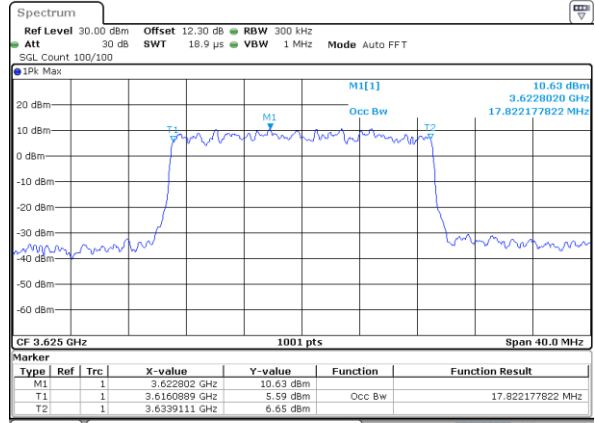

Date: 25.MAY.2022 22:14:02



ACLR

LTE Band 48 / 5MHz

QPSK

Lowest Channel / 1RB0

Lowest Channel / 1RBmax

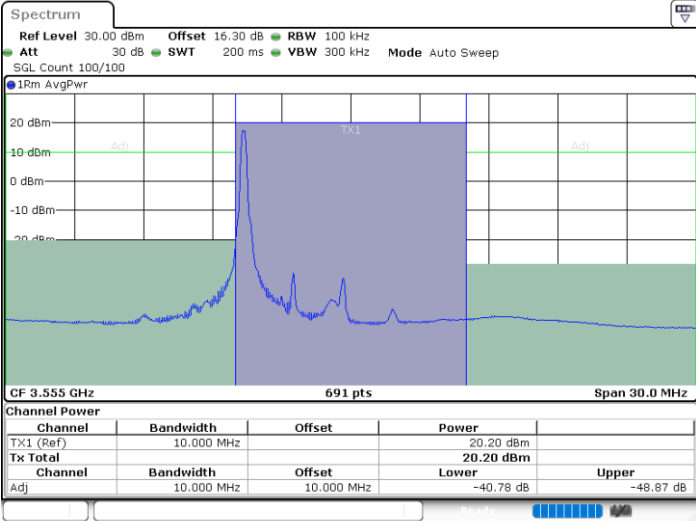

Date: 25.MAY.2022 19:38:40

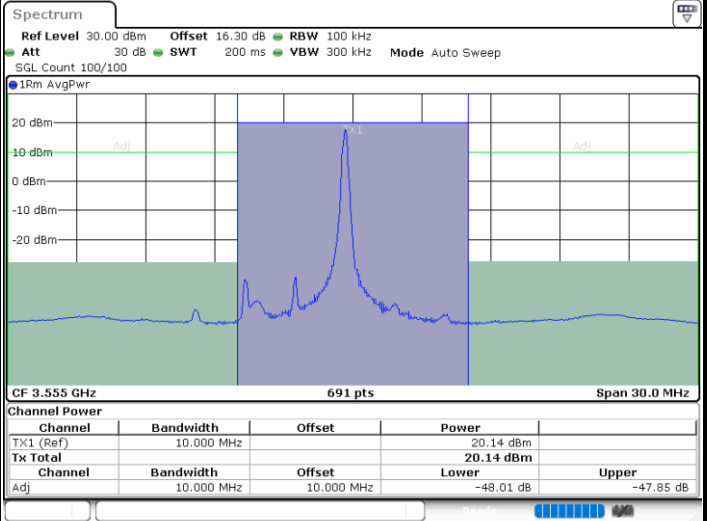

Date: 25.MAY.2022 19:47:33

Lowest Channel / FullIRB

N/A

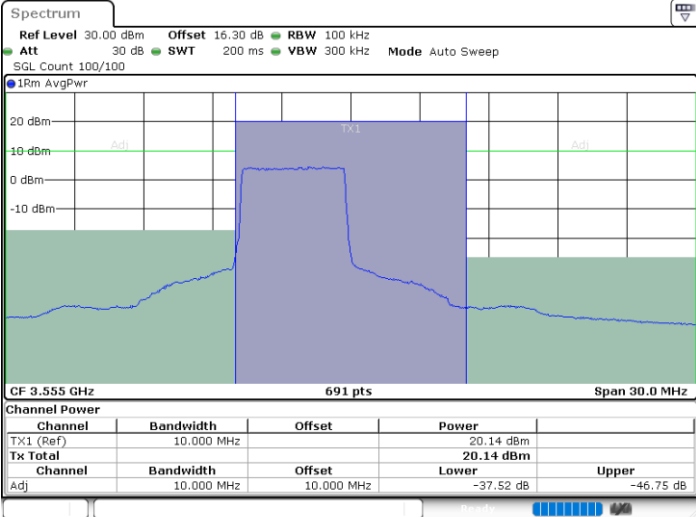

Date: 25.MAY.2022 19:43:07



LTE Band 48 / 5MHz

QPSK

Middle Channel / 1RB0

Middle Channel / 1RBmax

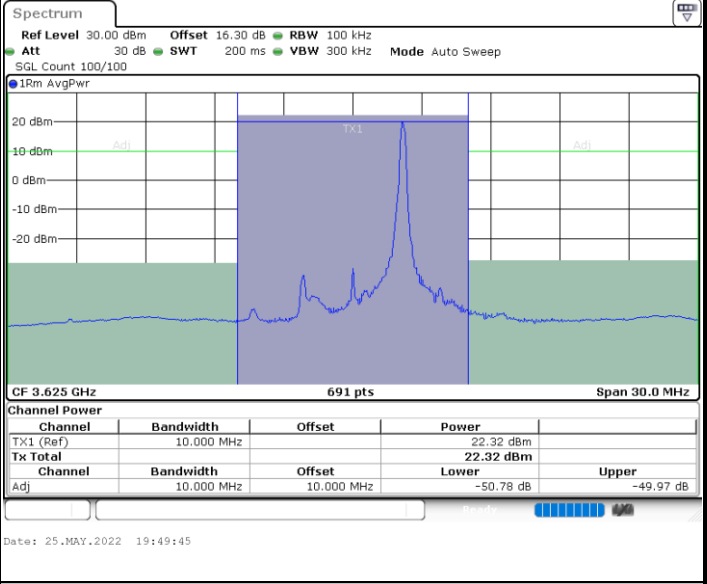
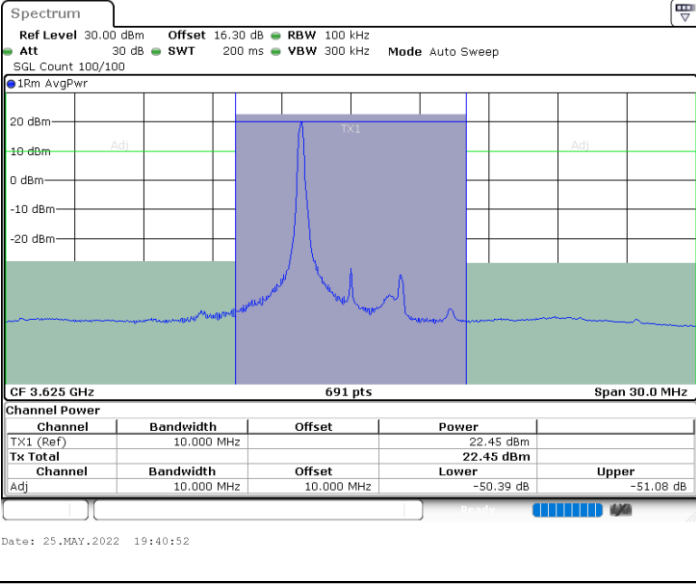

Middle Channel / FullIRB

N/A

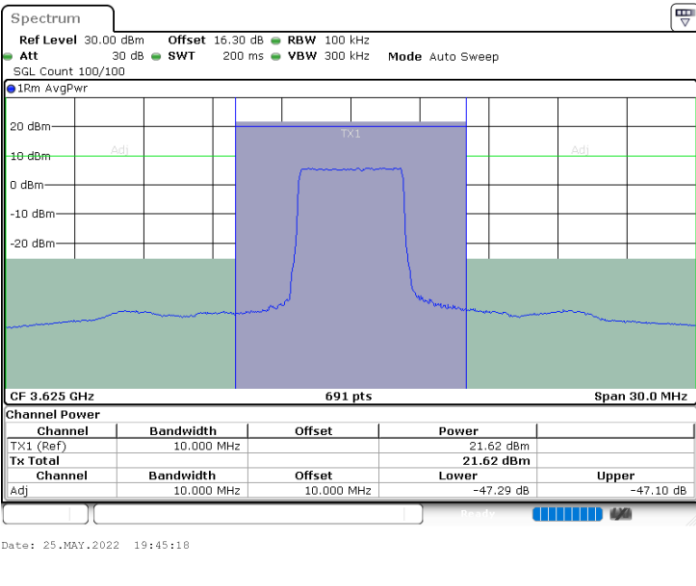

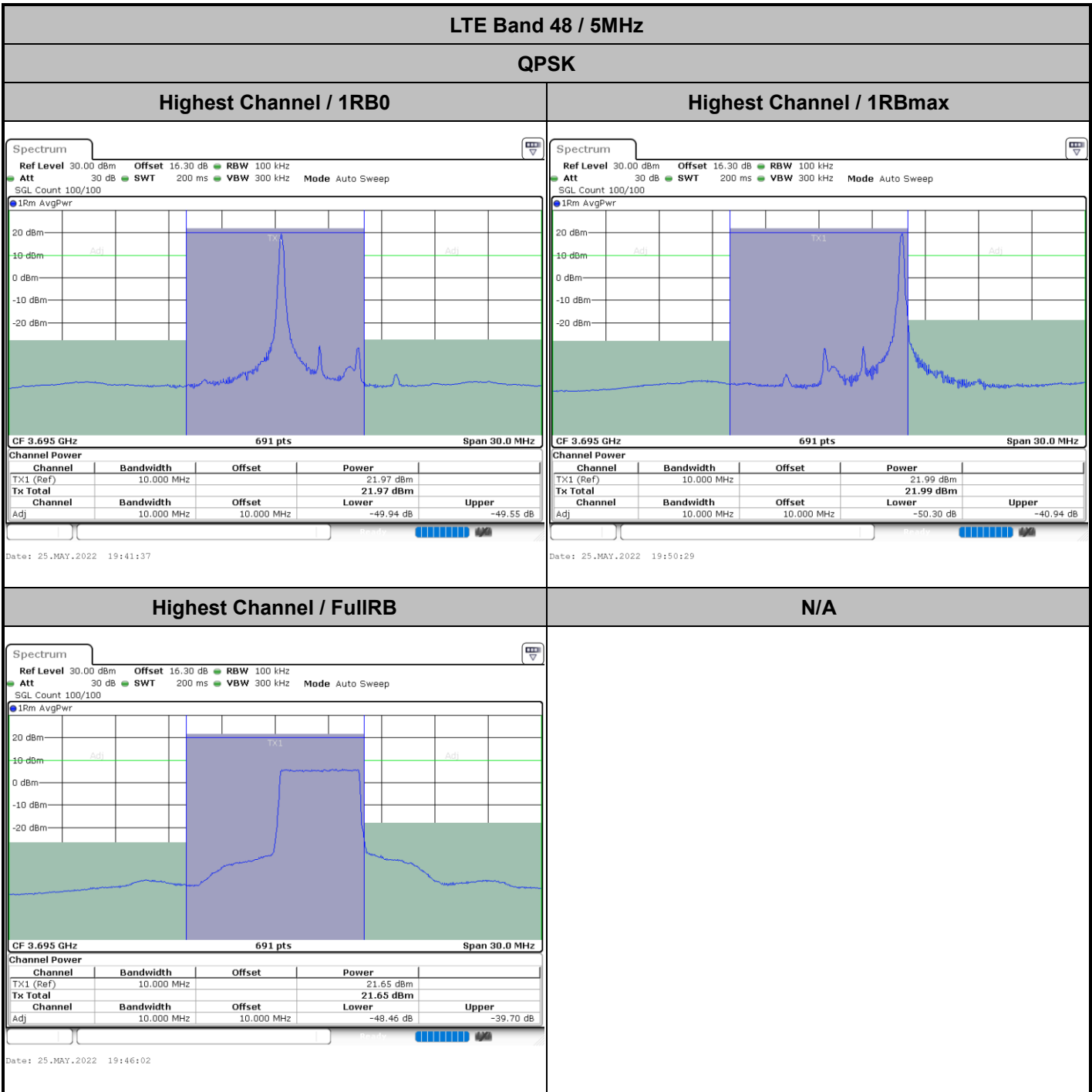

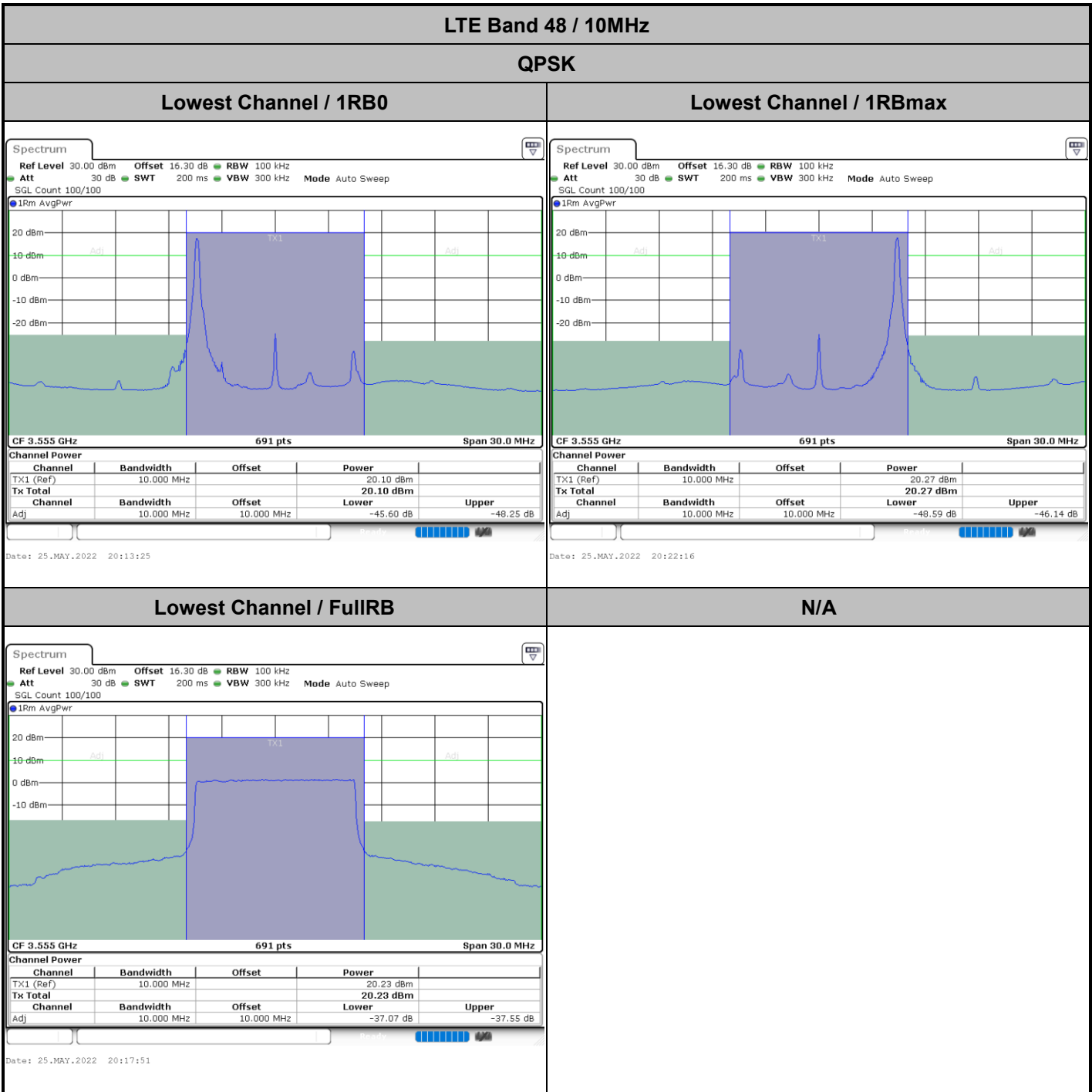

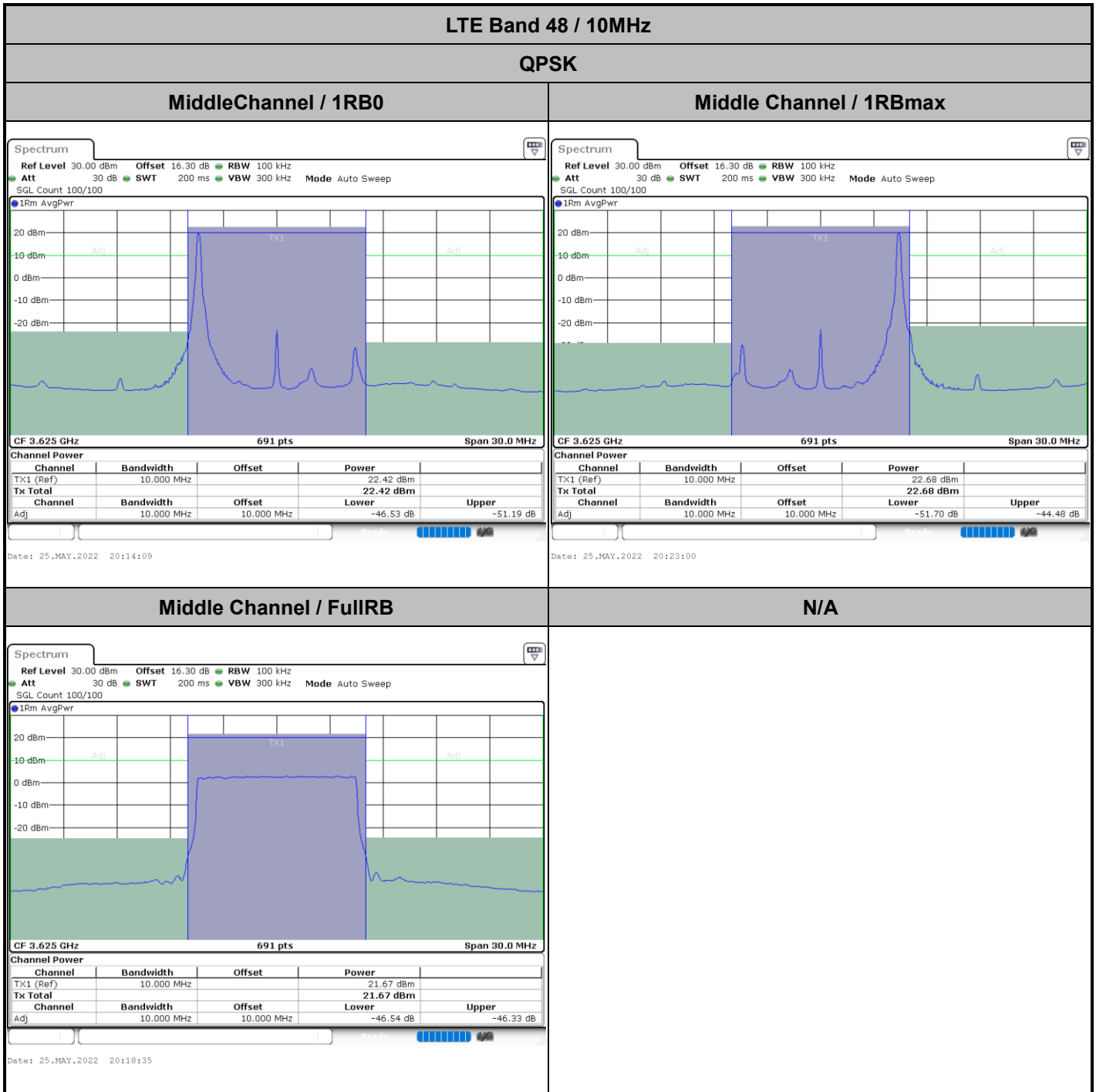

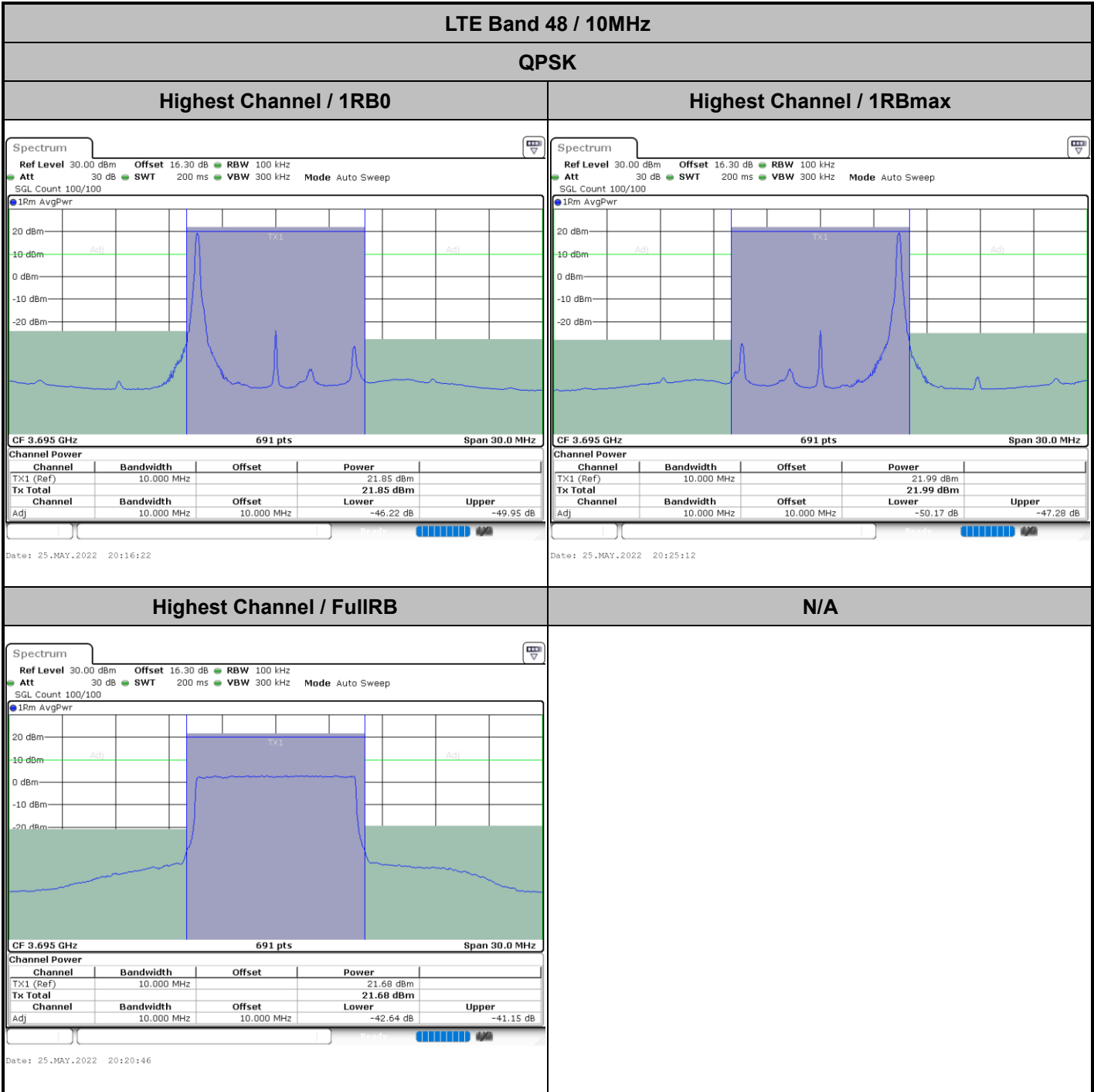

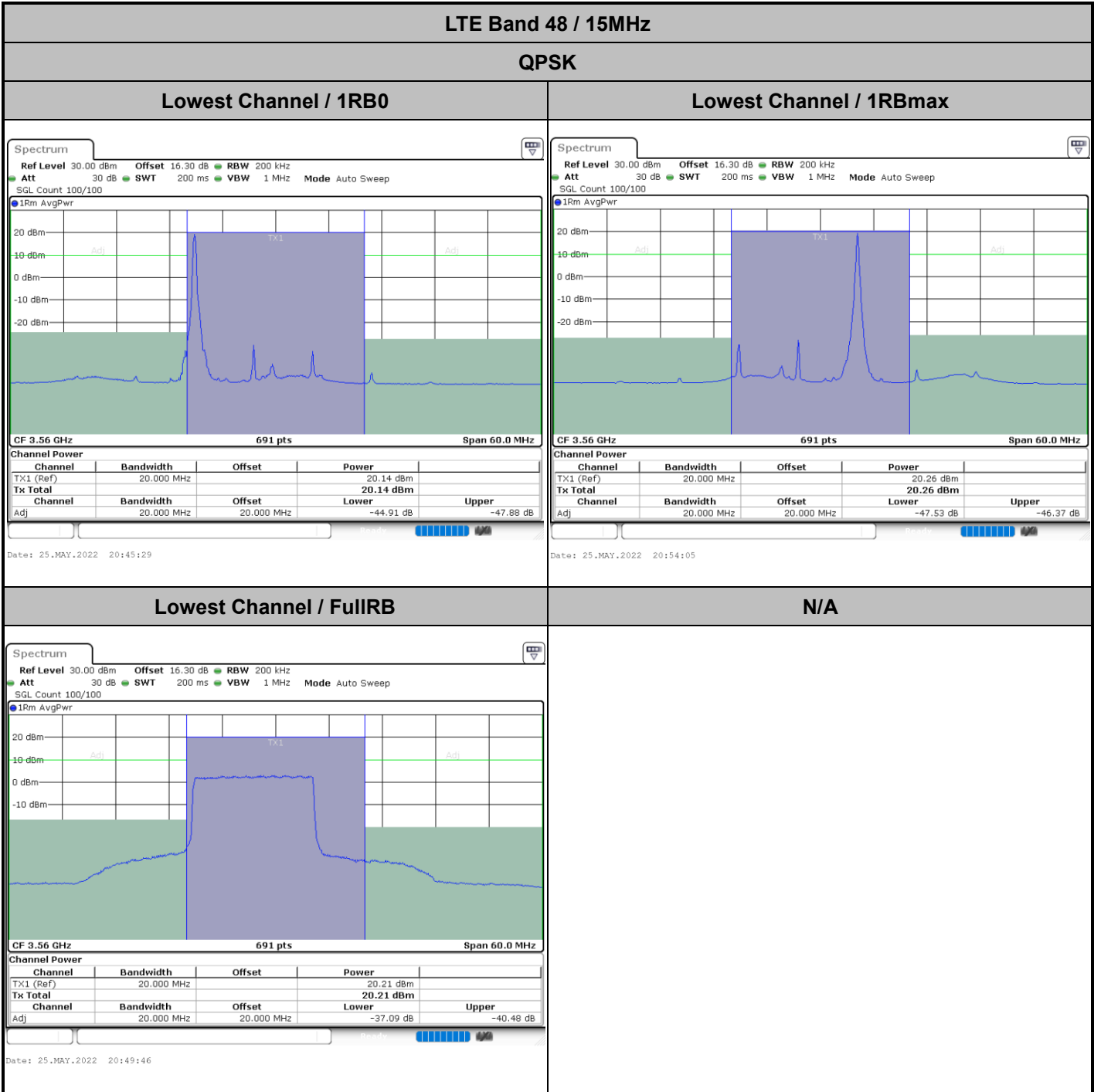

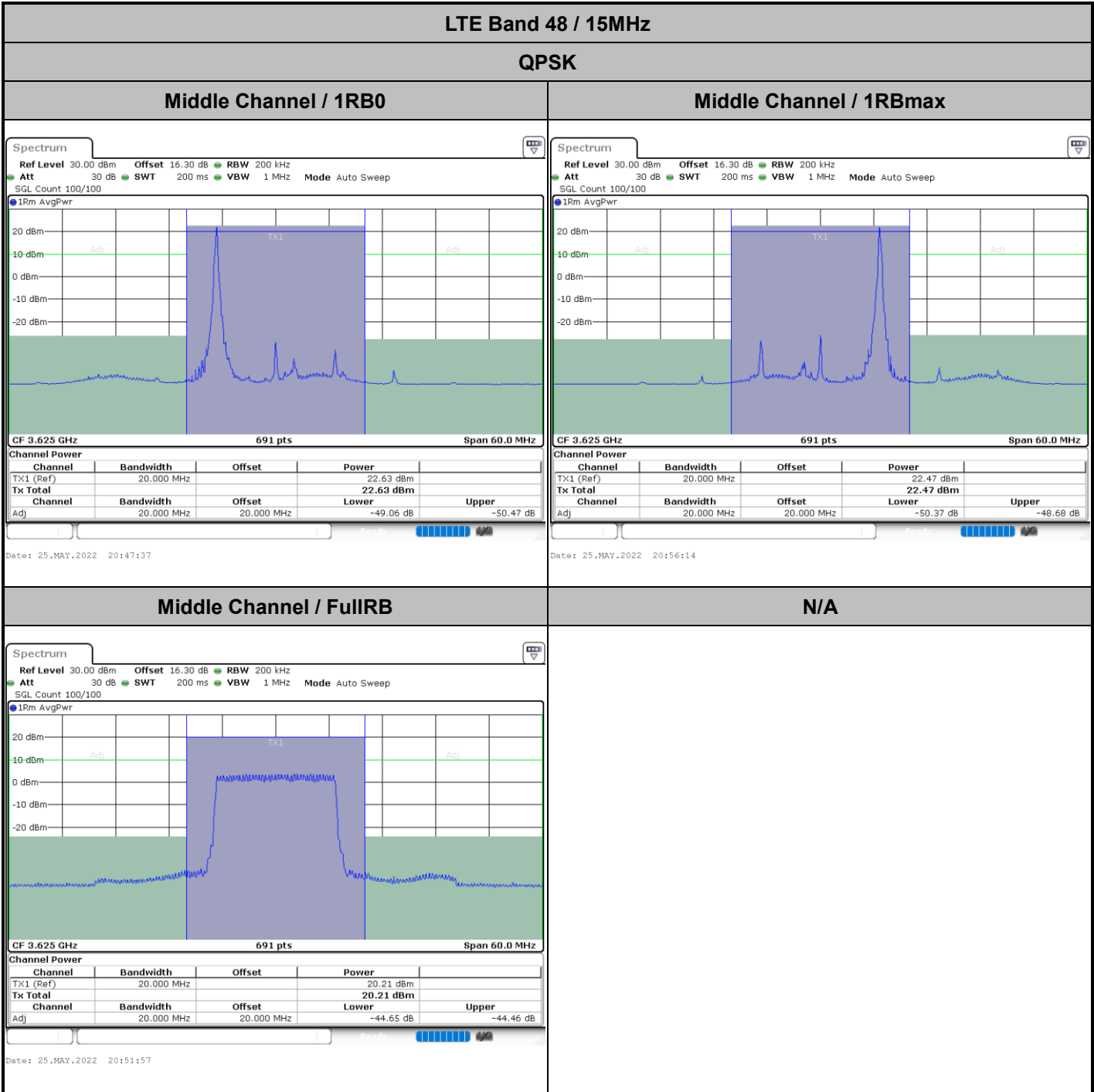



LTE Band 48 / 15MHz

QPSK

Highest Channel / 1RB0

Highest Channel / 1RBmax

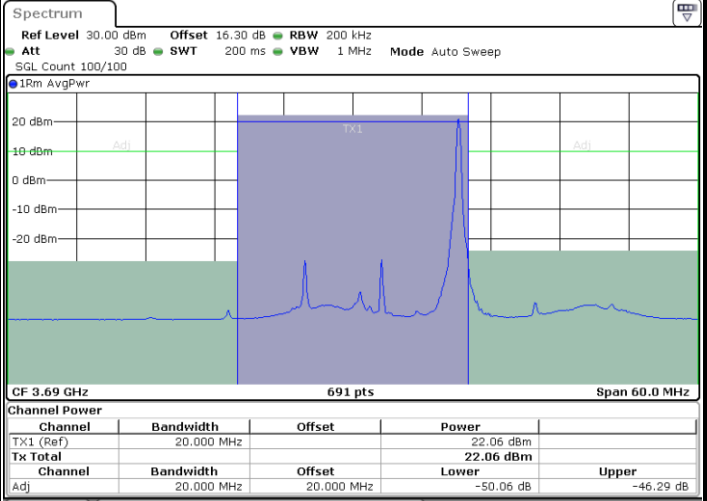
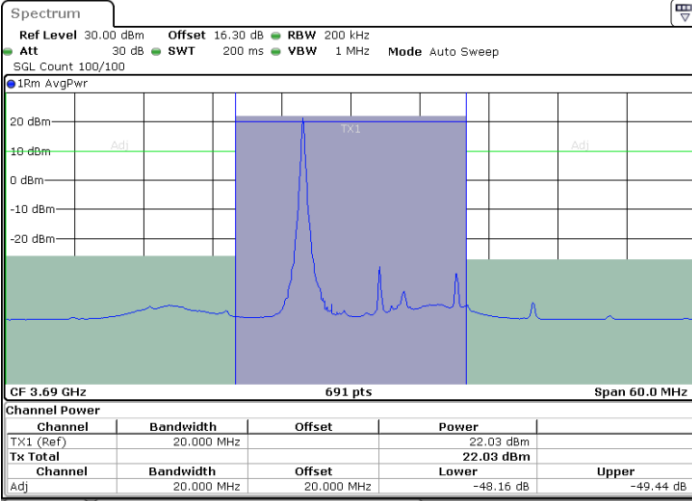

Date: 25.MAY.2022 20:48:19

Date: 25.MAY.2022 20:56:57

Highest Channel / FullIRB

N/A

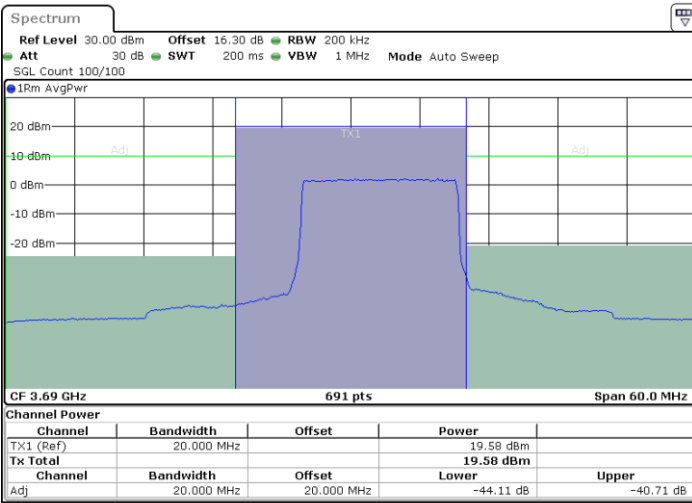

Date: 25.MAY.2022 20:52:39



LTE Band 48 / 20MHz

QPSK

Lowest Channel / 1RB0

Lowest Channel / 1RBmax

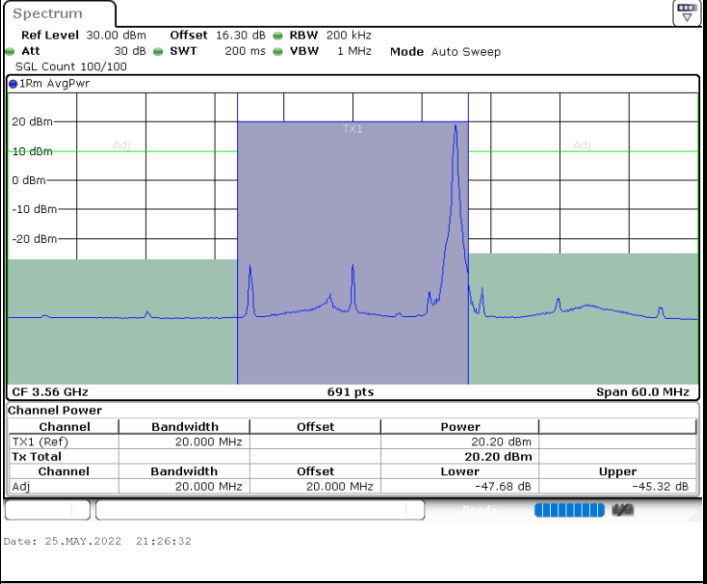
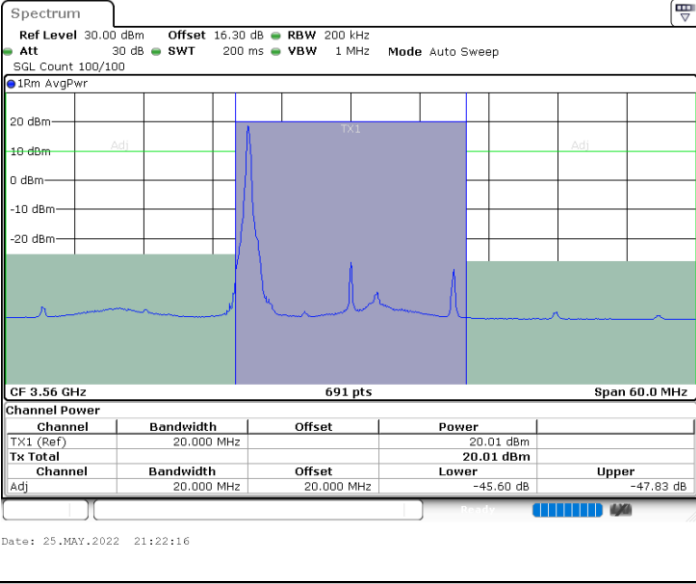

Lowest Channel / FullIRB

N/A

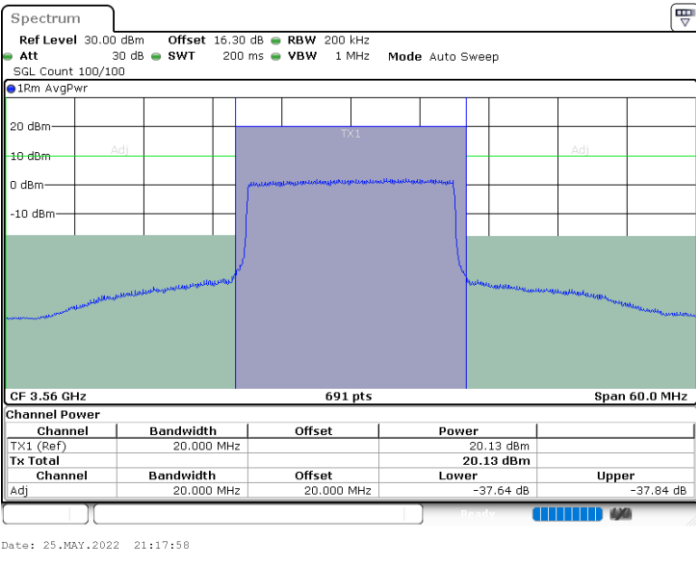

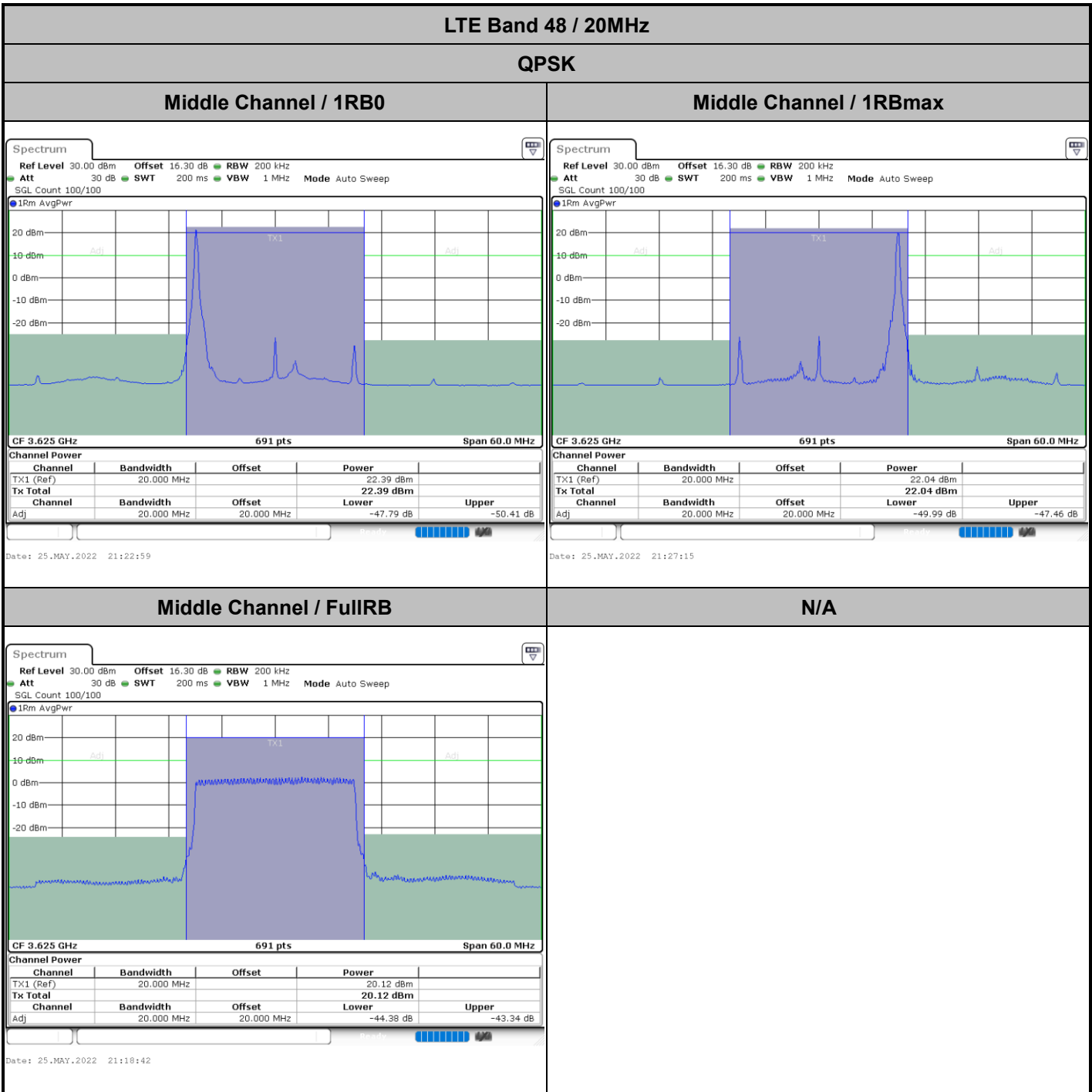



LTE Band 48 / 20MHz

QPSK

Highest Channel / 1RB0

Highest Channel / 1RBmax

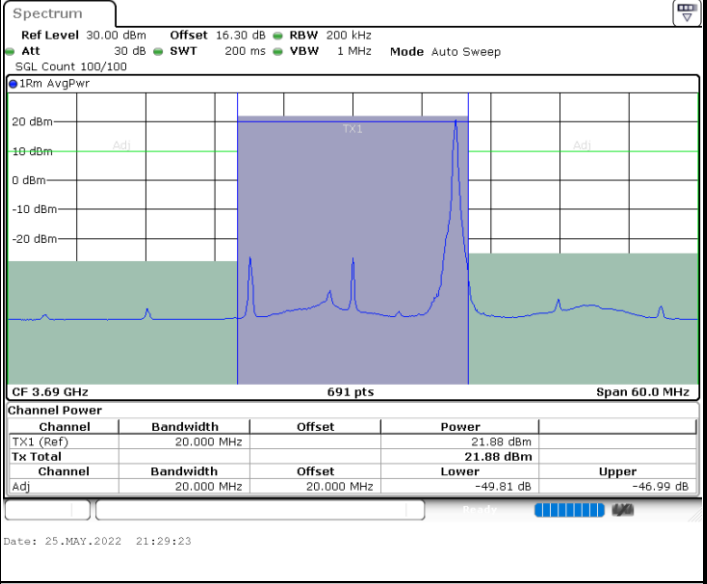
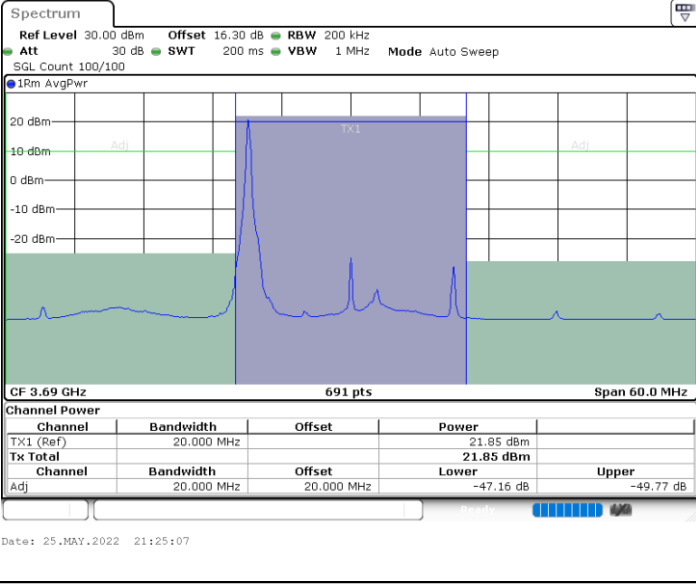

Highest Channel / FullIRB

N/A

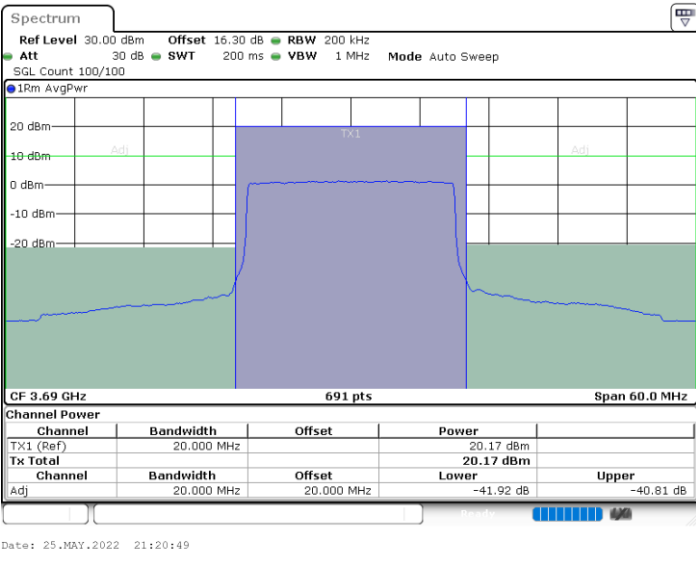



LTE Band 48 / 5MHz

16QAM

Lowest Channel / 1RB0

Lowest Channel / 1RBmax

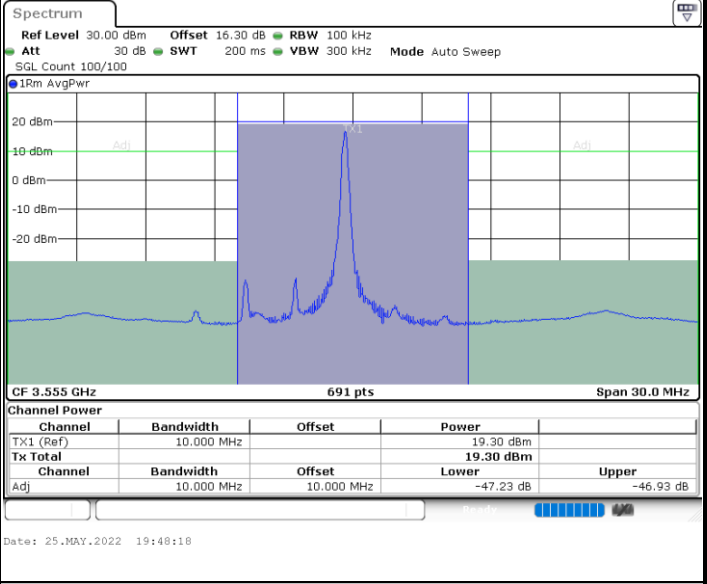
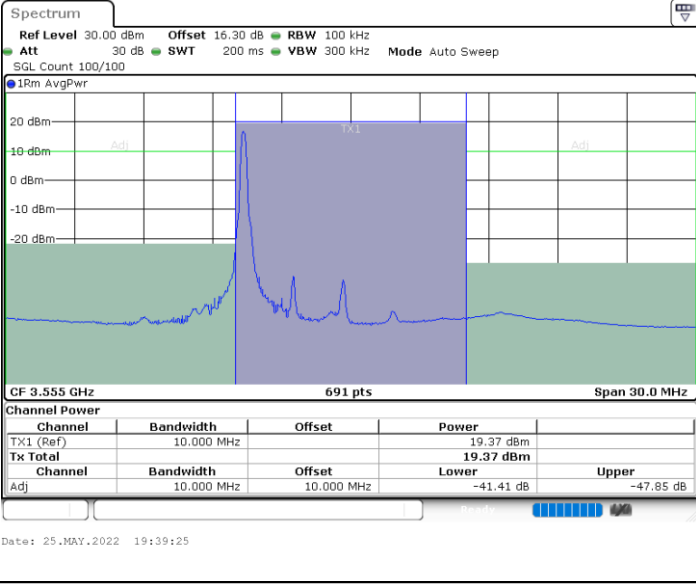

Lowest Channel / FullIRB

N/A

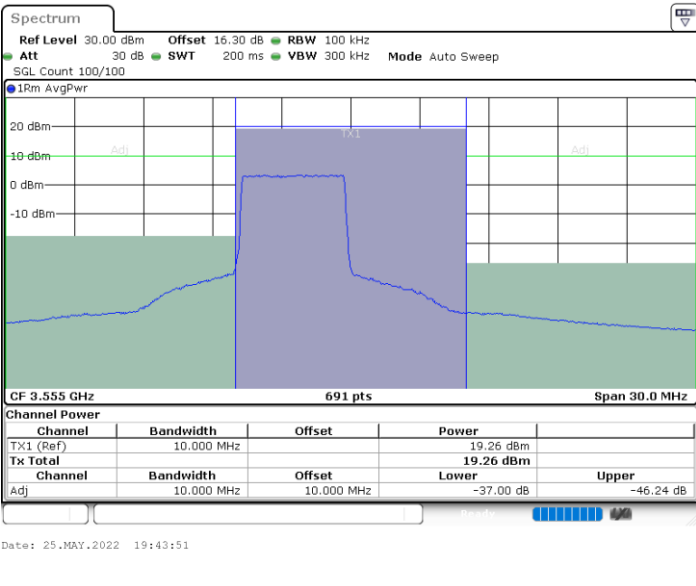



LTE Band 48 / 5MHz

16QAM

Middle Channel / 1RB0

Middle Channel / 1RBmax

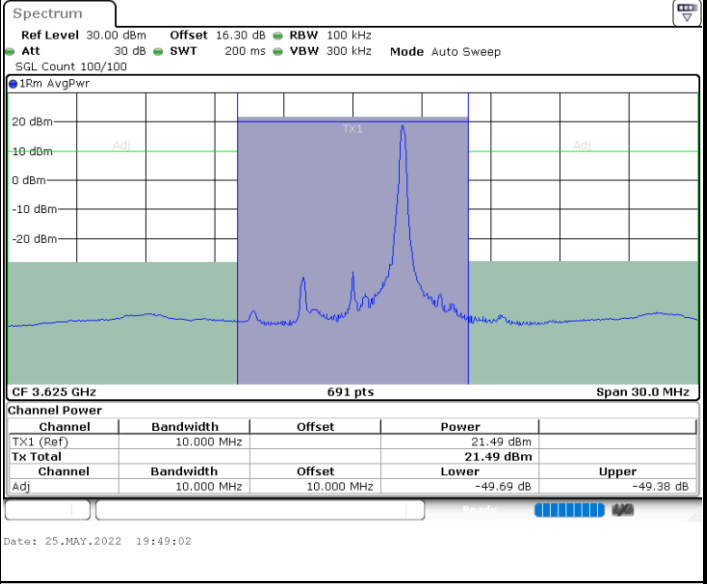
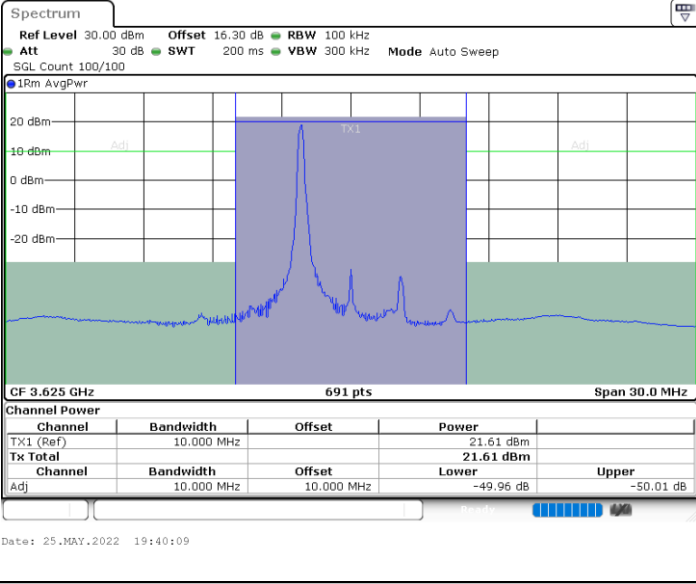

Middle Channel / FullIRB

N/A

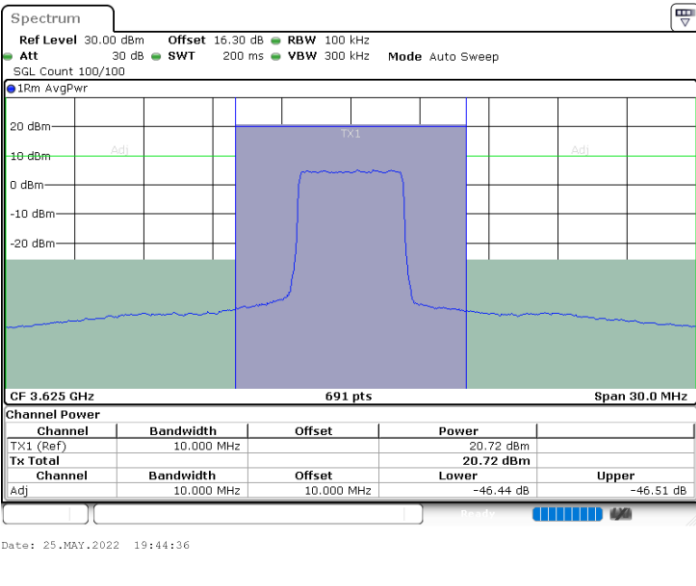

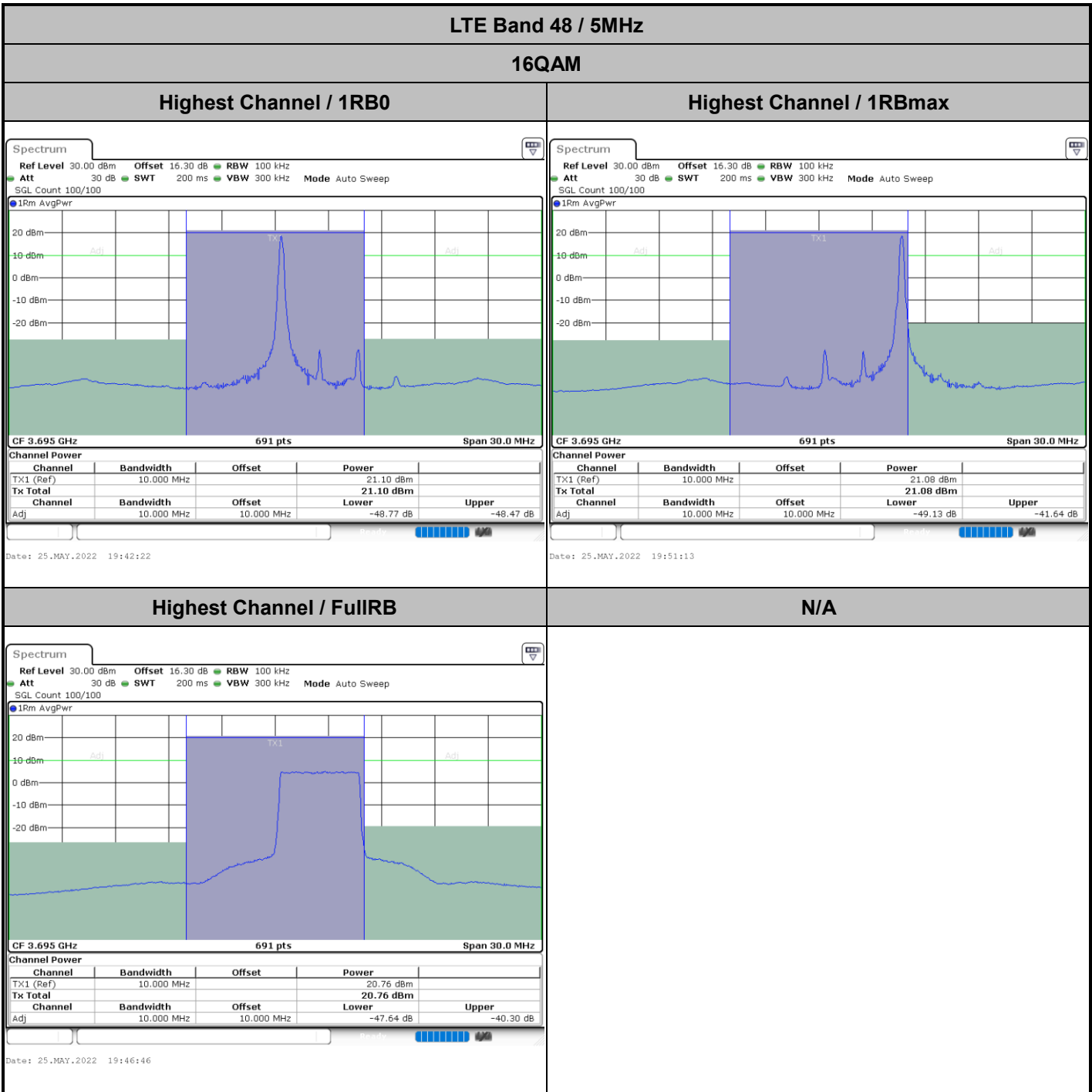

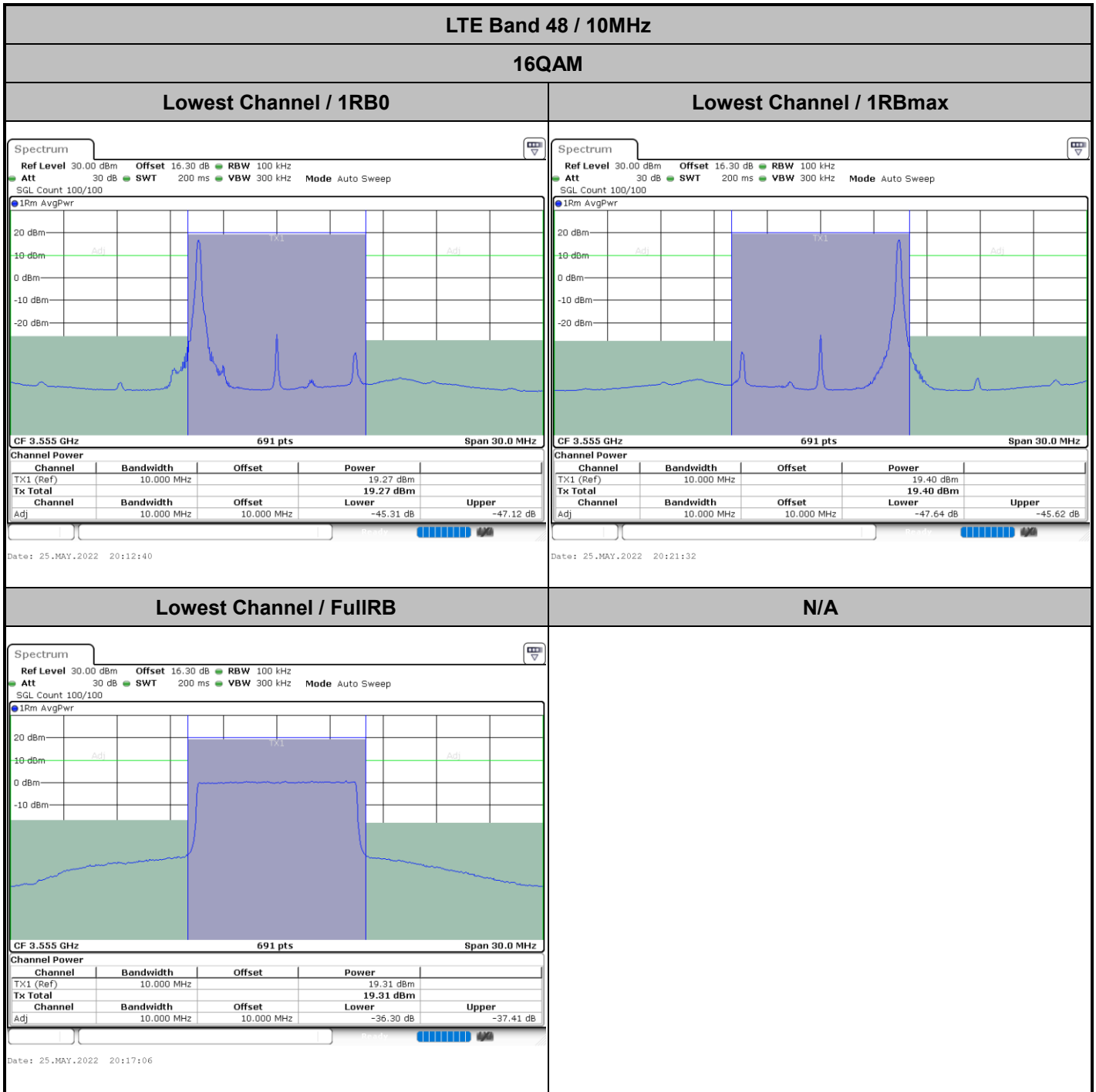

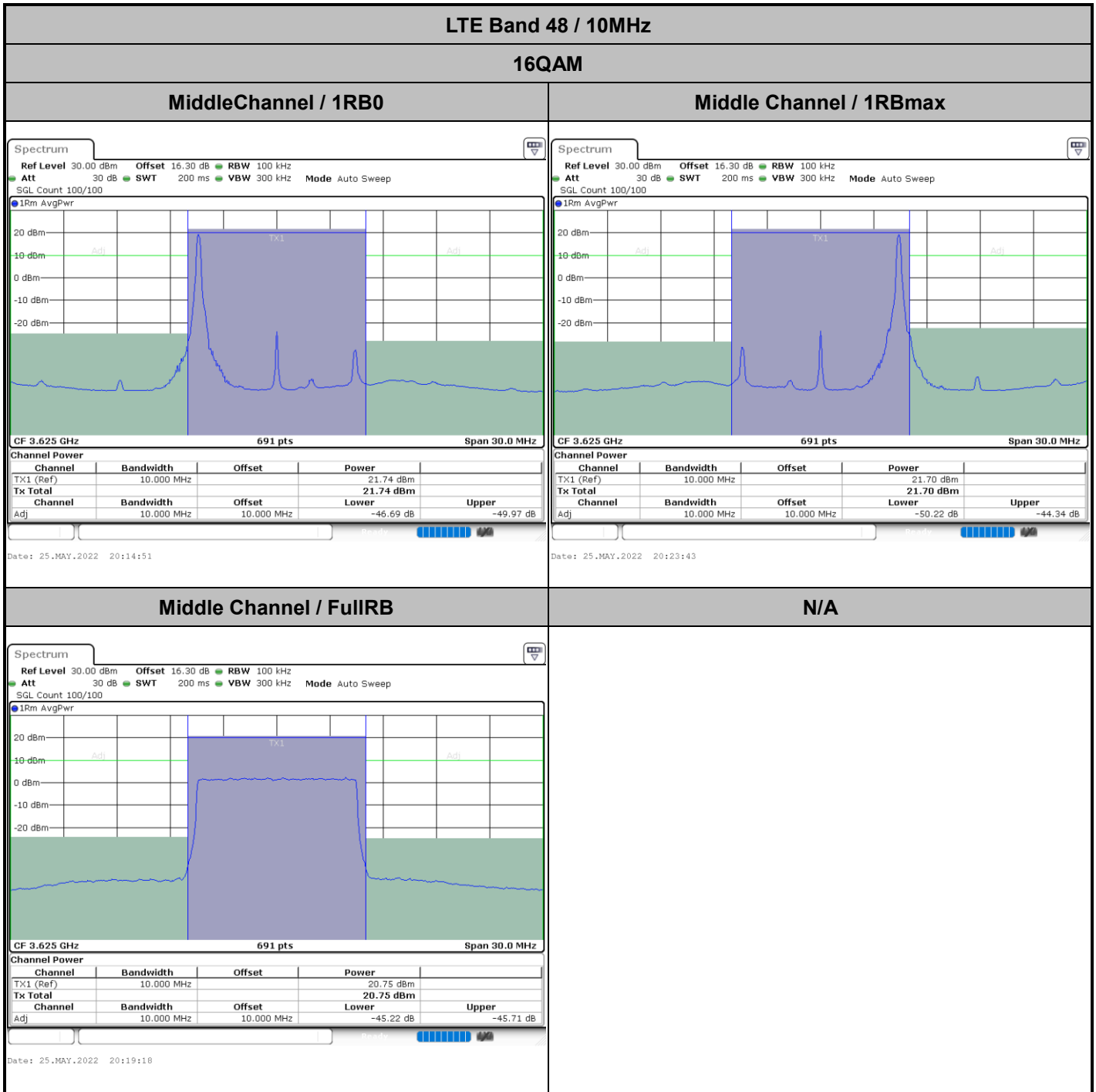

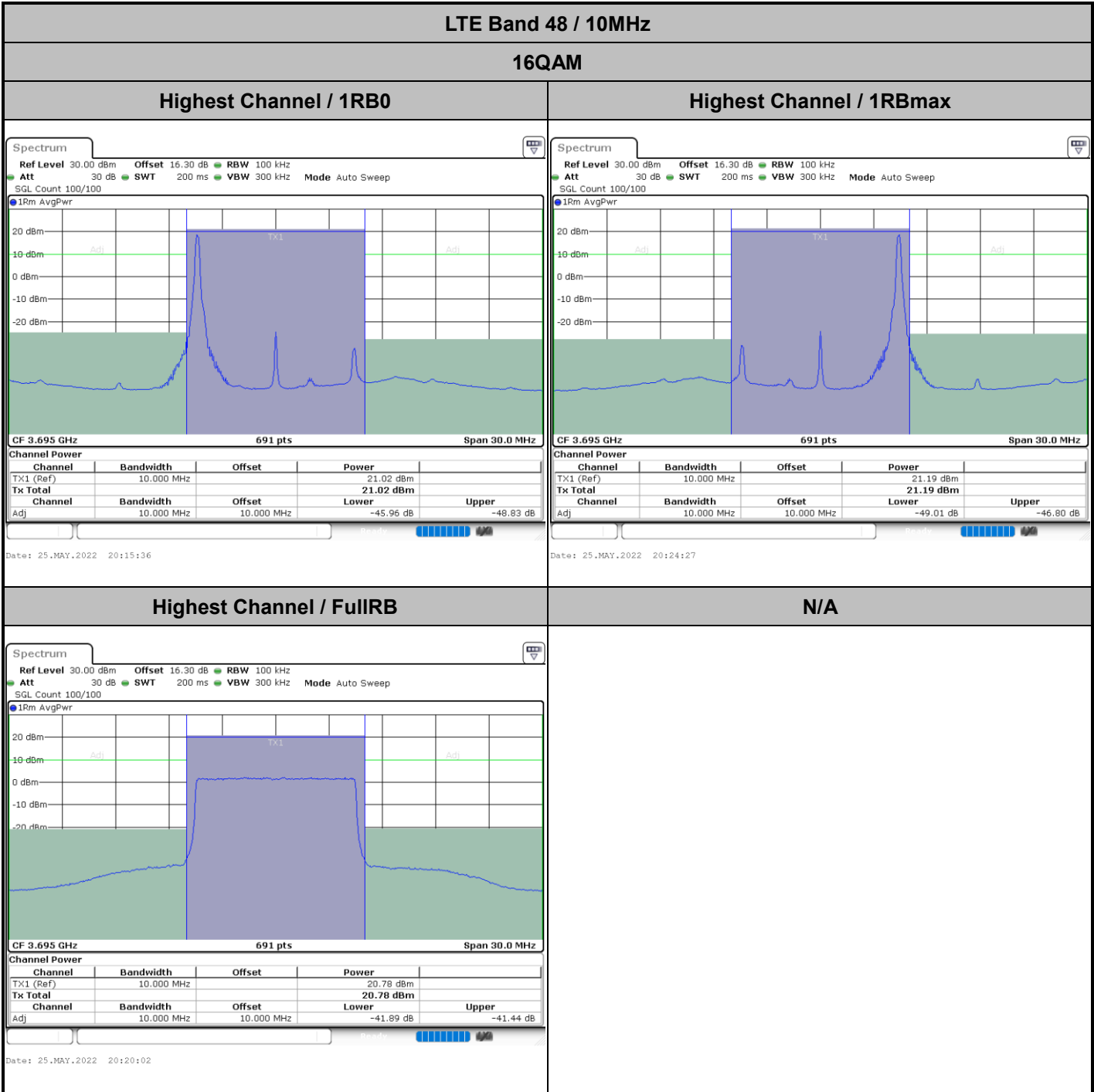



LTE Band 48 / 15MHz

16QAM

Lowest Channel / 1RB0

Lowest Channel / 1RBmax

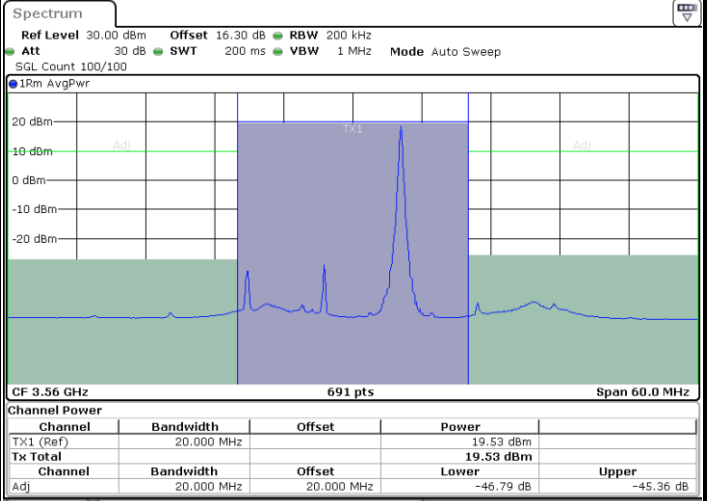
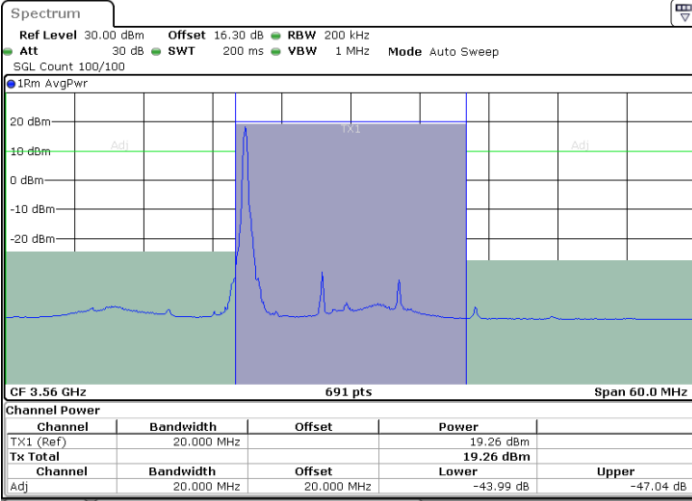

Date: 25.MAY.2022 20:46:13

Date: 25.MAY.2022 20:54:49

Lowest Channel / FullIRB

N/A

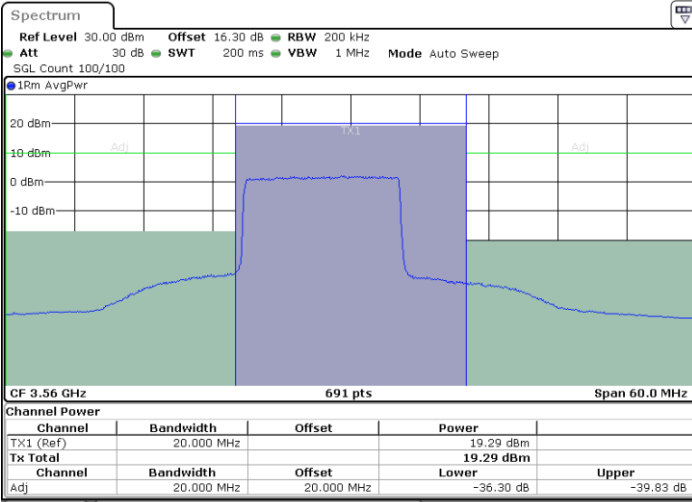

Date: 25.MAY.2022 20:50:32



LTE Band 48 / 15MHz

16QAM

Middle Channel / 1RB0

Middle Channel / 1RBmax

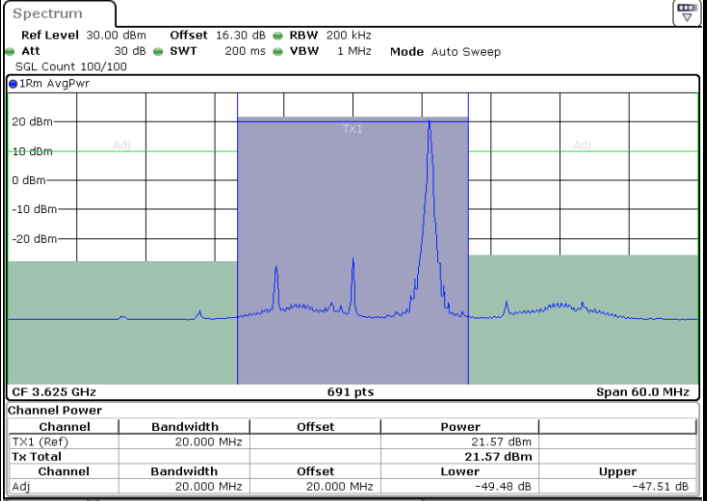
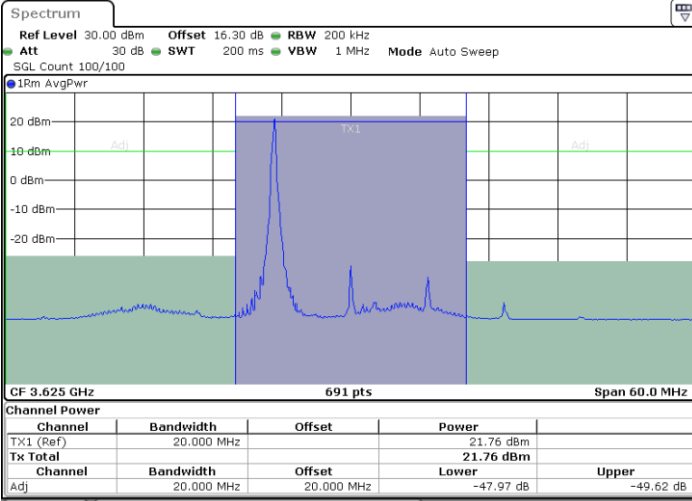

Date: 25.MAY.2022 20:46:55

Date: 25.MAY.2022 20:55:32

Middle Channel / FullRB

N/A

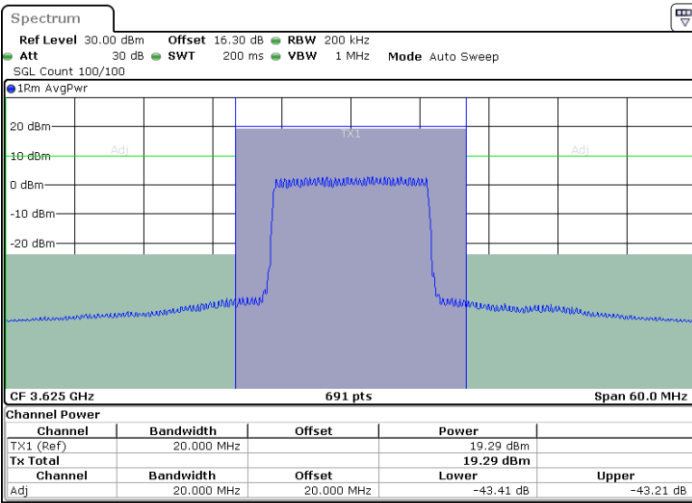

Date: 25.MAY.2022 20:51:14



LTE Band 48 / 15MHz

16QAM

Highest Channel / 1RB0

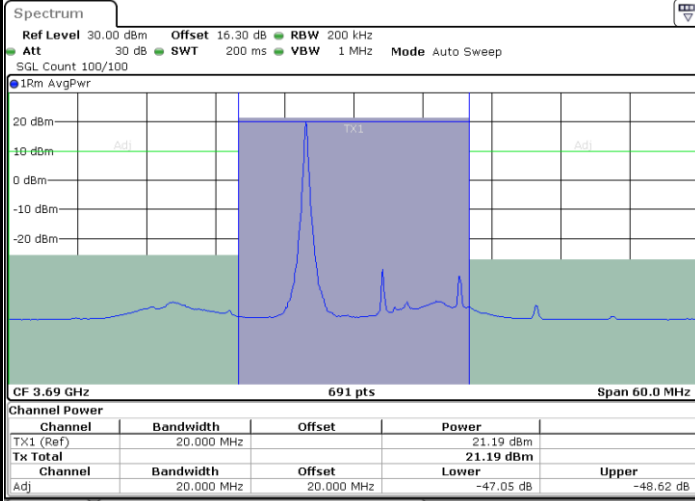

Date: 25.MAY.2022 20:49:02

Highest Channel / 1RBmax

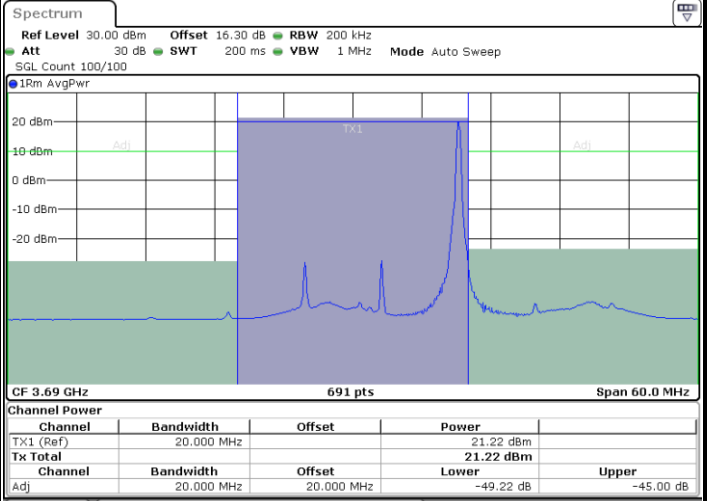

Date: 25.MAY.2022 20:57:41

Highest Channel / FullIRB

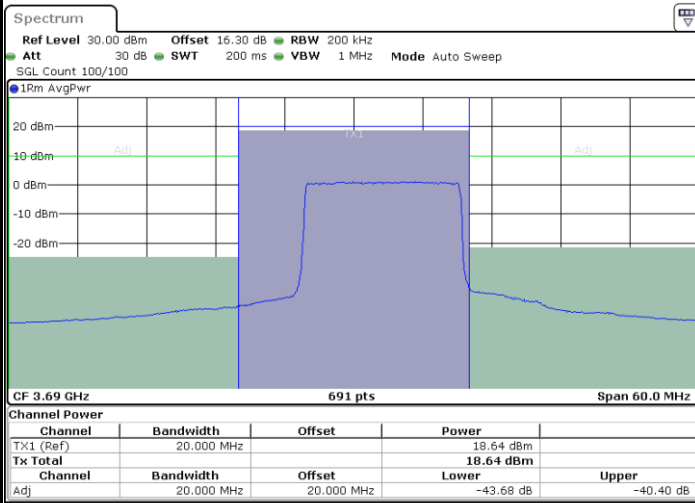

Date: 25.MAY.2022 20:53:22

N/A



LTE Band 48 / 20MHz

16QAM

Lowest Channel / 1RB0

Lowest Channel / 1RBmax

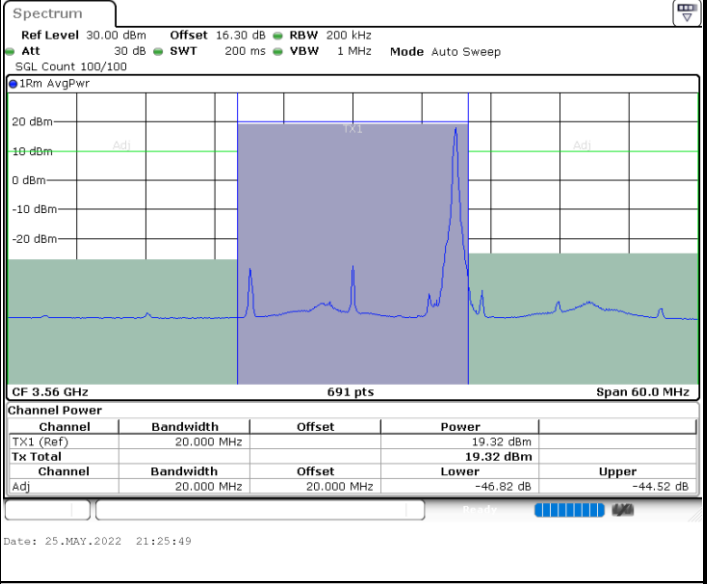
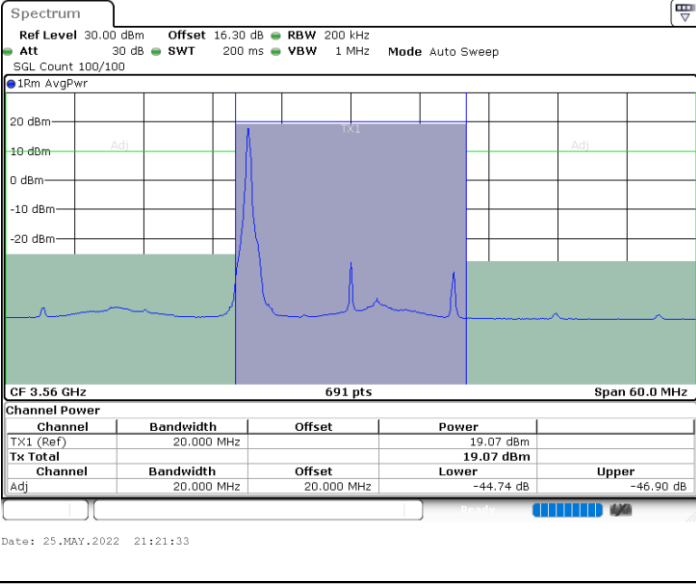

Lowest Channel / FullIRB

N/A

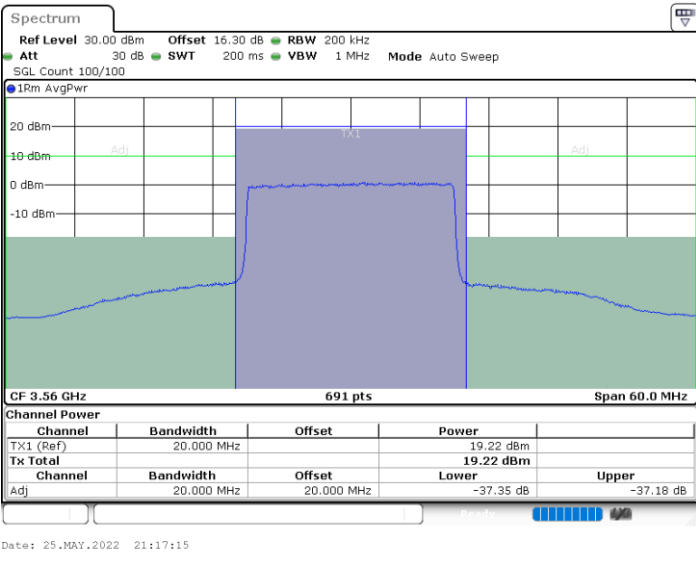



LTE Band 48 / 20MHz

16QAM

Middle Channel / 1RB0

Middle Channel / 1RBmax

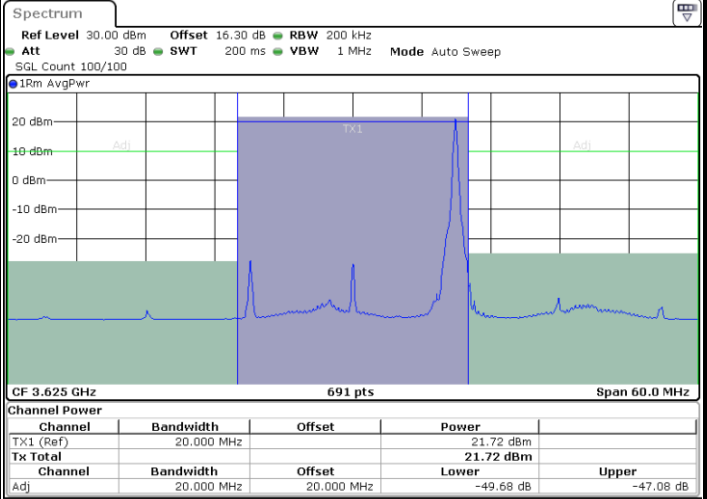
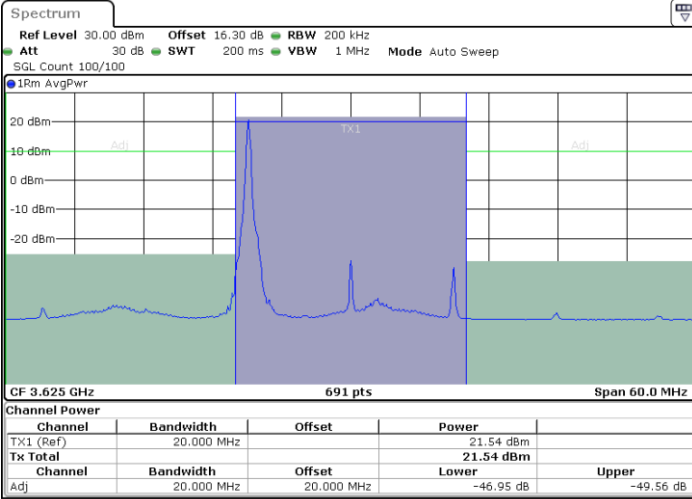

Date: 25.MAY.2022 21:23:41

Date: 25.MAY.2022 21:27:57

Middle Channel / FullIRB

N/A

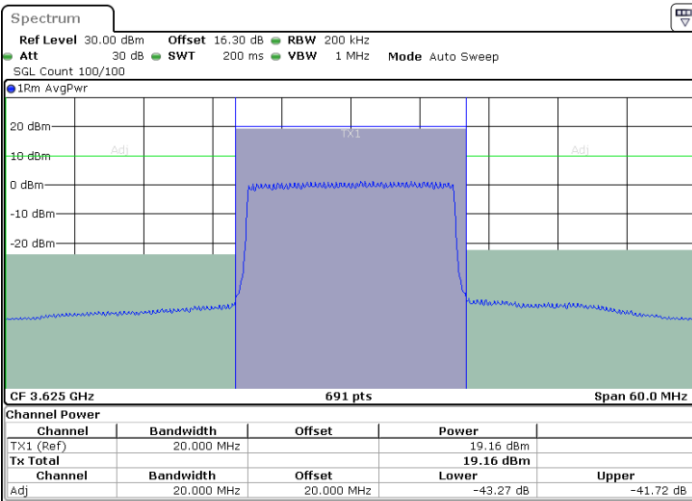

Date: 25.MAY.2022 21:19:24



LTE Band 48 / 20MHz

16QAM

Highest Channel / 1RB0

Highest Channel / 1RBmax

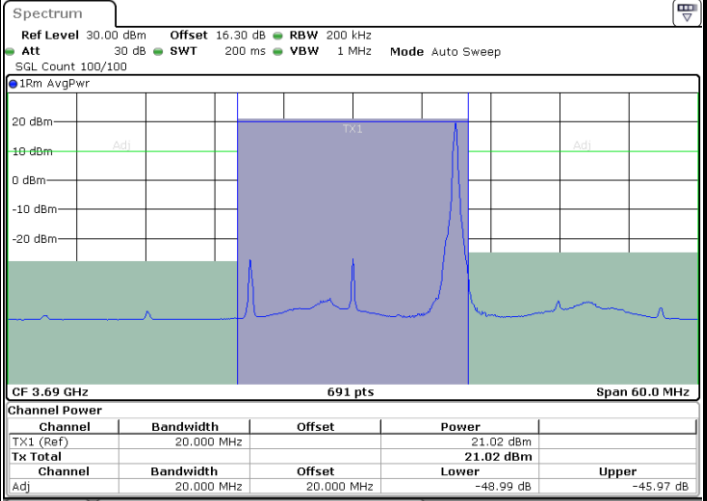
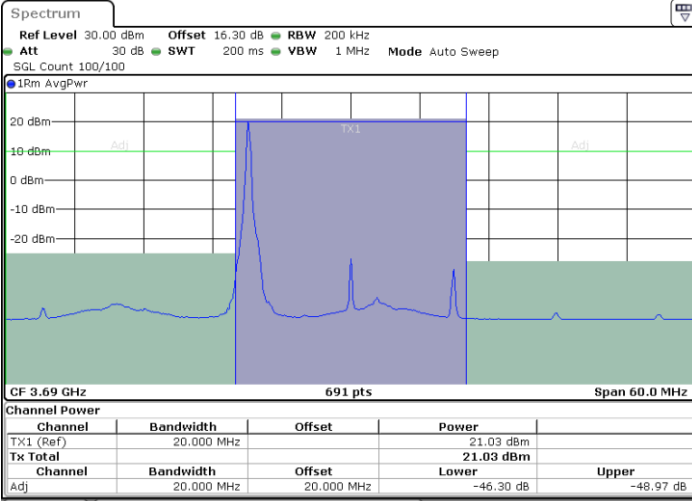

Date: 25.MAY.2022 21:24:23

Date: 25.MAY.2022 21:28:40

Highest Channel / FullIRB

N/A

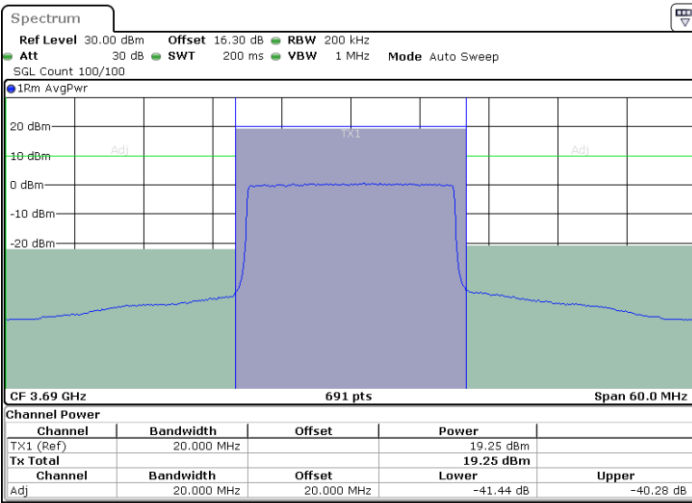

Date: 25.MAY.2022 21:20:07



Conducted Band Edge

LTE Band 48 / 5MHz

QPSK

Lowest Channel / 1RB0

Lowest Channel / 1RBmax

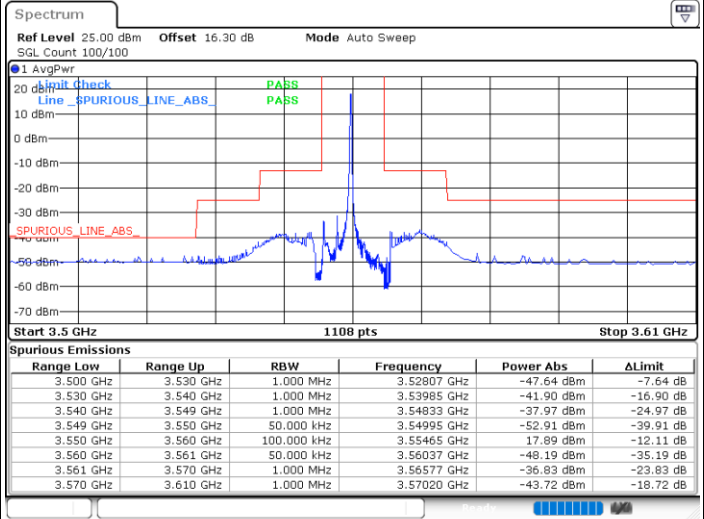
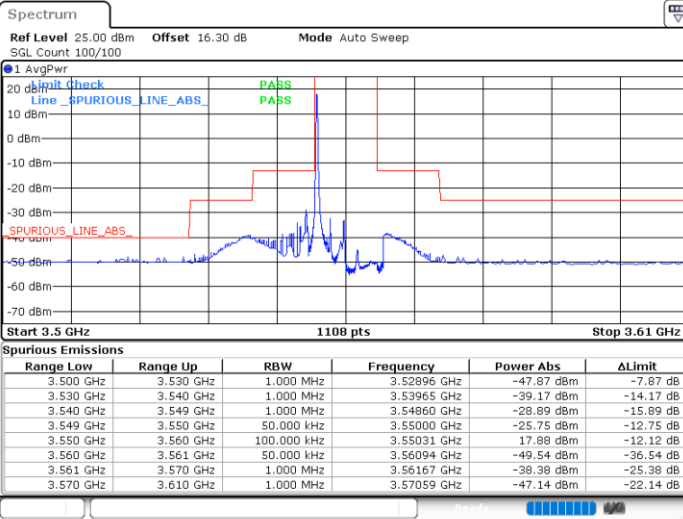

Date: 25.MAY.2022 19:20:02

Date: 25.MAY.2022 19:32:40

Lowest Channel / FullIRB

N/A

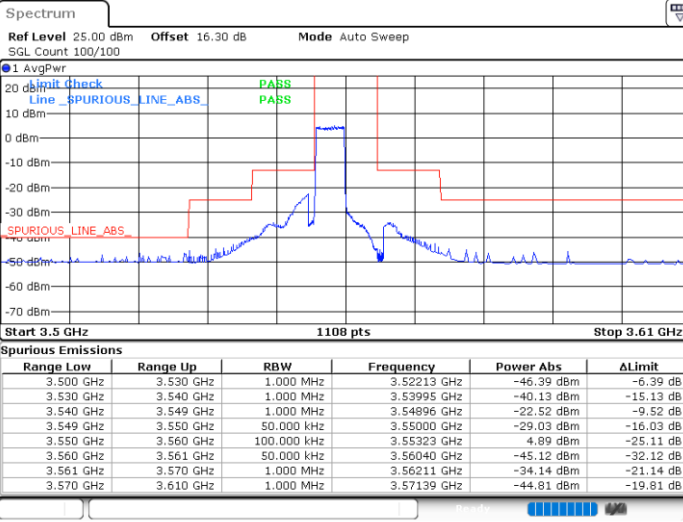

Date: 25.MAY.2022 19:26:21



LTE Band 48 / 5MHz

QPSK

Middle Channel / 1RB0

Middle Channel / 1RBmax

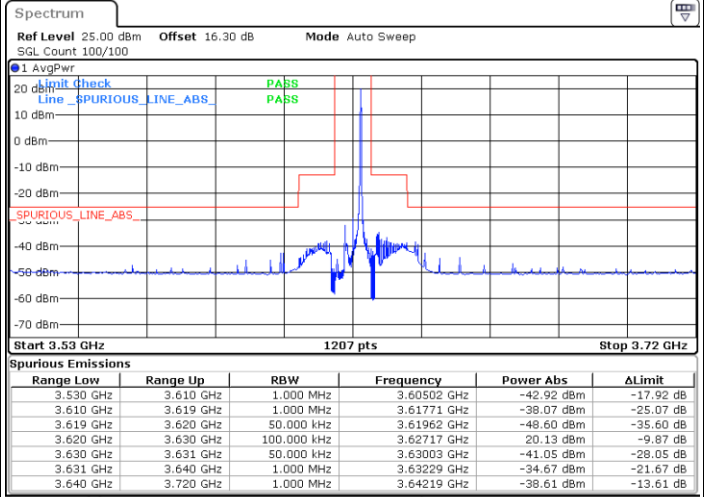
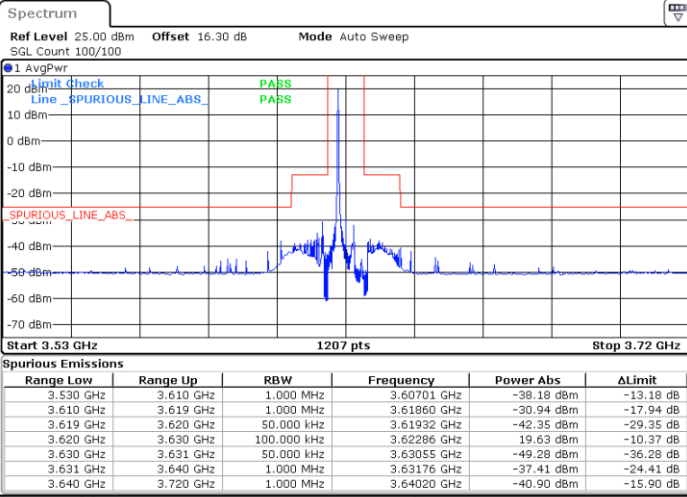

Date: 25.MAY.2022 19:23:11

Date: 25.MAY.2022 19:35:49

Middle Channel / FullIRB

N/A

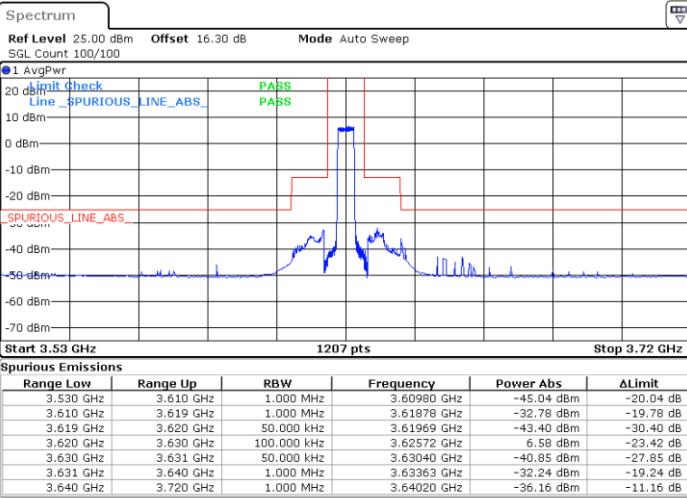

Date: 25.MAY.2022 19:29:30



LTE Band 48 / 5MHz

QPSK

Highest Channel / 1RB0

Highest Channel / 1RBmax

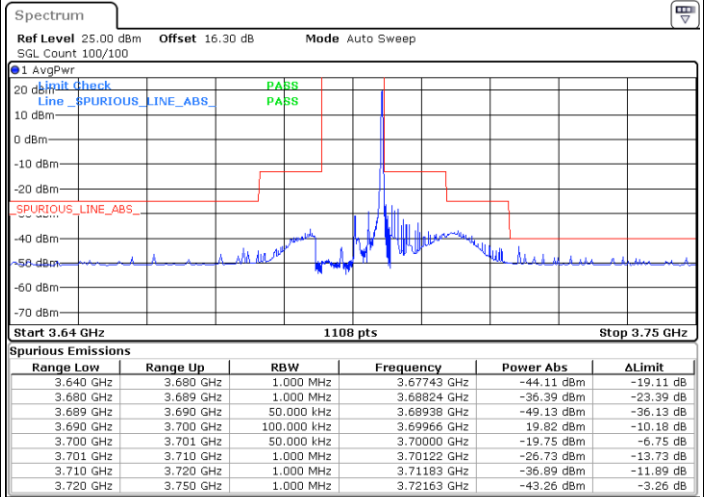
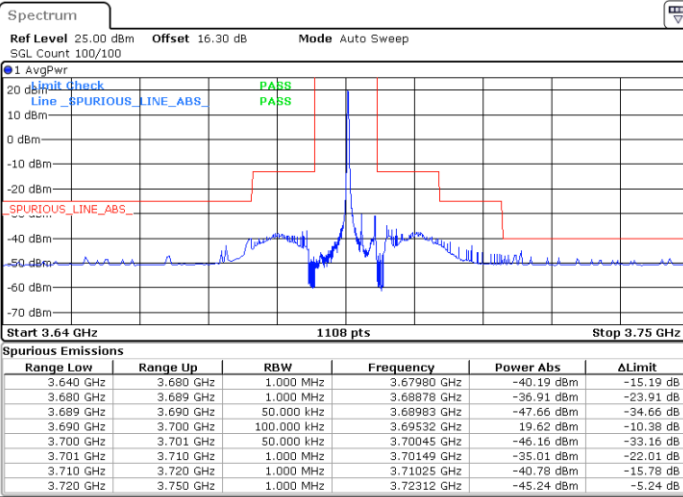

Date: 25.MAY.2022 19:24:14

Date: 25.MAY.2022 19:36:52

Highest Channel / FullIRB

N/A

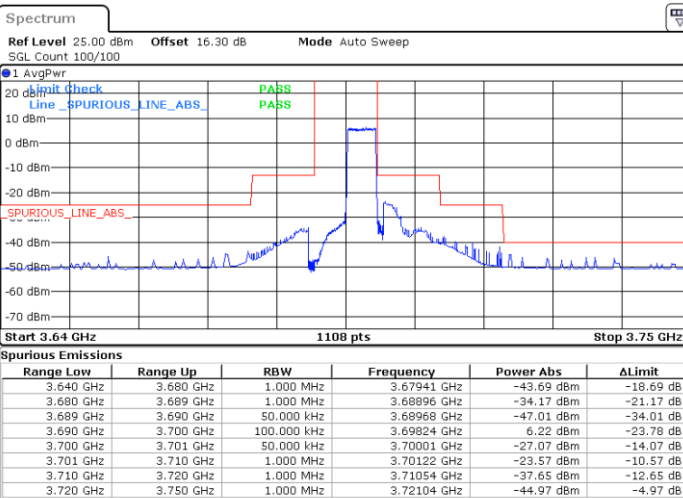

Date: 25.MAY.2022 19:30:32