 <p>CERTIFICATE 2518.08</p> <p>MS ISO/IEC 17025 TESTING SAMM NO. 0825</p>
<p>MOTOROLA PENANG ADV. COMM. LABORATORY Motorola Solutions Malaysia SDN BHD, Plot 2A, Medan Bayan Lepas, Mukim 12 S.W.D, 11900 Bayan Lepas, Penang, Malaysia.</p>	<p>FCC/ISED TEST REPORT Report Revision : Rev.B</p>
<p>Date/s Tested : 24-MAR-2022 - 30-MAR-2022 Report Issue Date : 16-Jun-2022 Manufacturer : Motorola Solutions Malaysia SDN BHD Manufacturer Address : Plot 2A, Medan Bayan Lepas, Mukim 12 SWD, 11900 Bayan Lepas, Penang, Malaysia Requestor : SIEW KHENG TAN Product Type : Hand-held Product Version (PMN) : MSLB-MKZ920 Model Number (HVIN) : AAH90UCU9RH1AN Frequency Band : 806-870MHz Max RF Output Power : 3 Watts Applicant Name : Motorola Solutions Inc Applicant Address : 8000 West Sunrise Boulevard, Fort Lauderdale, Florida 33322</p> <p>ISED Registrations : MY0001 FCC Registrations : 461337 Firmware Version (FVIN) : D00.01.86_D02.22.01.0103</p> <p>The equipment was tested accordance to the requirement listed below:</p> <p>(LMR) FCC 47 CFR Part 2/ 90 PASS ISED RSS- Gen Issue 5 / 119 Issue 12</p>	
<p>This report shall not be reproduced without written approval from an officially designated representative of the Motorola Penang Adv. Comm. Laboratory. The results and statements contained in this report pertain only to the device(s) evaluated.</p>	
<p>Prepared By:</p>  <hr/> <p>Putri Nur Sarah Sofia Test Personnel</p>	<p>Approved Signatory:</p> <hr/> <p>Soon Oi May Responsible Engineer</p>

Table of Contents

Report Revision History	3
1.0 General Information.....	4
2.0 Summary of Test Results.....	5
3.0 Measurement Uncertainty.....	6
4.0 Equipment List.....	7
5.0 Test Condition.....	10
5.1. Transmitter Test Conditions	10
6.0 Transmitter Test Parameters	11
6.1. RF Output Power	11
6.1.1. Test Setup.....	11
6.1.2. Test Result	11
6.2. Frequency Stability	12
6.2.1. Test Setup.....	12
6.2.2. Test Result	13
6.2.3. Test Limit.....	14
6.3. Modulation Characteristics	15
6.3.1. Test Setup.....	15
6.3.2. Test Result	16
6.3.3. Test Limit.....	17
6.4. Modulation Limiting.....	18
6.4.1. Test Setup.....	18
6.4.2. Test Result	19
6.4.3. Test Limit.....	19
6.5. Occupied Bandwidth.....	20
6.5.1. Test Setup (Analog)	20
6.5.2. Test Result (Analog).....	21
6.5.3. Test Setup (Digital).....	30
6.5.4. Test Result (Digital).....	31
6.5.5. Test Limit.....	47
6.6. Band Edge Conducted Spurious Emission (Part 22)	48
6.6.1. Test Setup (Analog)	48
6.6.2. Test Result (Analog).....	48
6.6.3. Test Setup (Digital).....	49
6.6.4. Test Result (Digital).....	49
6.6.5. Test Limit.....	49
6.7. Transient Frequency Behavior.....	50
6.7.1. Test Setup.....	50
6.7.2. Test Result	50
6.7.3. Test Limit.....	51
6.8. Adjacent Channel Power.....	52
6.8.1. Test Setup (Analog)	52
6.8.2. Test Result	52
6.8.3. Test Setup (Digital).....	53

6.8.4. Test Result 53
 6.8.5. Test Limit..... 54
 6.9. Conducted Spurious Emission 56
 6.9.1. Test Setup..... 56
 6.9.2. Test Result (Analog)..... 57
 6.9.3. Test Result (Digital)..... 63
 6.9.4. Test Limit..... 69
 6.10. Radiated Spurious Emission 70
 6.10.1. Test Setup..... 70
 6.10.2. Test Result (Analog)..... 71
 6.10.3. Test Result (Digital)..... 77
 6.10.4. Test Limit..... 83
 6.11. Effective Radiated Power (ERP) 84
 6.11.1. Test Setup..... 84
 6.11.2. Test Result 84
 6.11.3. Test Limit..... 84
 6.12. GNSS (EIRP for 1559 - 1610MHz)..... 85
 6.12.1. Test Setup..... 85
 6.12.1. Test Result 85
 6.12.2. Test Limit..... 85

Report Revision History

Revision History	Description	Date	Originator
Rev. A	Initial Report	31-Mar-2022	Putri
Rev. B	Updated section 1.0 modulation type update from C4FM to 4FSK.	2-Aug-2022	Putri

1.0 General Information

EUT Description:

Technologies	Land Mobile Radio (LMR)
Modulation Type	Analog, 4FSK

The EUT contains following accessory devices and data cable:

Item	Brand	Model or P/N
BATTERY PACK,BATTERY PACK,IMPRES GEN2, LIION,IP68, 2900T, TIA4950	MOTOROLA	PMNN4805A

General Description of Applied Standards

The EUT is a RF Product. According to the specifications of the manufacturer, the EUT is to comply with the requirements of the following standards:

ANSI C63.26-2015

No modifications were done to the UUT to facilitate the tests in this report.

Deviation from standard

Not applicable as no deviation from standard test method

Antenna gain disclaimer

Antenna gain information is provided by customer. The validity of the results is dependent upon this information. The lab will not be held accountable in the event the supplied information affects compliance.

Test configuration of EUT

All relevant configurations involving radio models and accessories (including chargers, batteries, and antennas) were assessed. Only worst case configurations will be included in this report.

2.0 Summary of Test Results

FCC General Rules Part (47CFR)	ISED General Rules Part	Test Item	Result	Remarks	Serial number tested
2.1046, 90541	RSS-Gen, RSS-119	RF Power Output	Pass		734TYF0017
2.1055, 90.213	-	Frequency Stability	Pass		734TYF0017
2.1047	-	Audio Frequency Response	Pass		734TYF0017
2.1047	-	Audio Low Pass Filter Response	Pass		734TYF0017
2.1047	-	Modulation limiting	Pass		734TYF0017
2.1049, 90.210	RSS-119	Occupied Bandwidth	Pass	16K0F3E- 15.0134kHz 11K0F3E- 9.8740kHz 7K60F1D- 7.4218kHz 7K60F1E- 7.0683kHz 7K60F1W- 7.5485kHz	734TYF0017
-	-	Band Edge Conducted Spurious Emission	NA		
-	-	Transient Frequency Behavior	NA		
-	-	Adjacent Channel Power	NA		
2.1051, 90.210	RSS-Gen, RSS-119	Conducted Spurious Emissions	Pass	Worst Case – -31.46dBm	734TYF0017
2.1051, 90.210	RSS-Gen, RSS-119	Radiated Spurious Emission	Pass	Worst Case - -40.9229dBm margin: 20.9229dB (Noise Floor)	734TYF0065
-	-	GNSS (EIRP for 1559 – 1610MHz)	NA		
-	-	Effective Radiated Power (ERP)	NA		

NA → Not Applicable

3.0 Measurement Uncertainty

Measurement	Frequency	Expanded Uncertainty (k=1.96) (±)
AC Power Line Conducted Spurious Emission	150KHz ~ 30MHz	3.48 dB
Radiated Emissions up to 1 GHz dB μ V/m (Field Strength)	30MHz ~ 1000MHz	5.88 dB
Radiated Emissions above 1 GHz dB μ V/m (Field Strength)	1GHz ~ 18GHz	5.84 dB
	18GHz ~ 40GHz	6.02 dB
Radiated Emissions dBm (ERP/EiRP)	30MHz ~ 18GHz	4.03 dB
Conducted Spurious Emissions	9kHz ~ 12.75GHz	2.82 dB
Frequency Stability	9kHz ~ 12.75GHz	0.0085 ppm
Audio Frequency Response / Low Pass Filter Response	300Hz – 20kHz	4.09 %
Modulation Limiting	300Hz – 3kHz	1.15 %
Occupied Bandwidth	9kHz ~ 12.75GHz	2.82 dB
Band Edge Conducted Spurious Emission	9kHz ~ 12.75GHz	2.82 dB
Transient Frequency Behavior	9kHz ~ 12.75GHz	5.4 ms
Adjacent Channel Power	9kHz ~ 12.75GHz	2.82 dB

4.0 Equipment List

FCC Analog ATE#1: (SW version: FCC_Analog_v2.5.0)

Description	Model	Serial Number	Calibration Date	Calibration Due Date
CHAMBER	SH-641	92009188	21-Mar-22	21-Mar-23
POWER SENSOR	E4412A	MY41502652	09-Sep-21	09-Sep-22
POWER SUPPLY	6032A	3232A08203	14-Jun-21	14-Jun-22
POWER METER	E4416A	MY45101705	04-Mar-22	04-Mar-23
MODULATION ANALYZER	8901B	3403A04974	06-Sep-21	06-Sep-22
AUDIO ANALYZER	U8903B	MY61060002	6-May-21	6-May-22
CXA SIGNAL ANALYZER	N9000B	MY60250530	18-Apr-21	18-Apr-22
N to N RF Cable # 1	M17/128-RG400	NA	NA	NA
BNC to N RF Cable # 1	RG 58	NA	NA	NA
BNC to BNC RF Cable # 1	RG 58	NA	NA	NA
BNC to BNC RF Cable # 2	RG 58	NA	NA	NA
BNC to BNC RF Cable # 3	RG 58	NA	NA	NA
BNC to BNC RF Cable # 4	RG 58	NA	NA	NA
BNC to BNC RF Cable # 5	RG 58	NA	NA	NA
BNC to BNC RF Cable # 6	RG 58	NA	NA	NA
BNC to BNC RF Cable # 7	RG 58	NA	NA	NA
N to SMA RF Cable # 1	RG 58	NA	NA	NA
N to SMA RF Cable # 2	RG 58	NA	NA	NA
N to SMA RF Cable # 3	RG 58	NA	NA	NA
Aeroflex Attenuator 30dB	49-30-34-LIM	NA	NA	NA

FCC Transient ATE #1: (SW version: FCC Transient ATE_R1.1.4)

Description	Model	Serial Number	Calibration Date	Calibration Due Date
SWITCH CONTROL UNIT	3488A	2719A36210	CNR	CNR
ATTENUATOR / SWITCH DRIVER	11713A	2508A10141	CNR	CNR
POWER SENSOR	E9301B	MY41495393	15-May-21	15-May-22
SIGNAL GENERATOR	8657A	3039A02769	11-Jun-21	11-Jun-22
AUDIO ANALYZER	8903B	3011A10318	01-Nov-21	01-Nov-22
POWER METER	E4416A	MY45101448	21-Jun-21	21-Jun-22
STEP ATTENUATOR	8494G	MY52300967	17-Jun-21	17-Jun-22
POWER SUPPLY	6033A	3004A04987	08-Jul-21	08-Jul-22
ANALYZER SPECTRUM	E4445A	MY46181732	29-Jun-21	29-Jun-22
ATTENUATOR/110DB	8496G	MY52300176	22-Aug-21	22-Aug-22
AUDIO ANALYZER	8903B	3413A14586	13-Sep-21	13-Sep-22
ANALYZER MODULATION	8901B	2619A00845	30-Sep-21	30-Sep-22
AUDIO ANALYZER	8903B	3011A12488	13-Sep-21	13-Sep-22
N to N RF Cable # 1	SF126/11N/11N	NA	NA	NA
N to N RF Cable # 1	SF126/11N/11N	NA	NA	NA
N to N RF Cable # 2	M17/128-RG400	NA	NA	NA
N to N RF Cable # 3	M17/128-RG400	NA	NA	NA
N to N RF Cable # 4	M17/128-RG400	NA	NA	NA
N to N RF Cable # 5	M17/128-RG400	NA	NA	NA
N to N RF Cable # 6	M17/128-RG400	NA	NA	NA
N to N RF Cable # 7	M17/128-RG400	NA	NA	NA
N to N RF Cable # 8	M17/128-RG400	NA	NA	NA
N to N RF Cable # 9	M17/128-RG400	NA	NA	NA
BNC to BNC RF Cable # 1	RG 58	NA	NA	NA
BNC to BNC RF Cable # 2	RG 58	NA	NA	NA
BNC to BNC RF Cable # 3	RG 58	NA	NA	NA
BNC to BNC RF Cable # 4	RG 58	NA	NA	NA
BNC to BNC RF Cable # 5	RG 58	NA	NA	NA
BNC to BNC RF Cable # 6	RG 58	NA	NA	NA
BNC to N RF Cable # 1	RG 58	NA	NA	NA
Aeroflex Attenuator 10dB	49-10-43-LIM	NA	NA	NA
Aeroflex Attenuator 10dB	33-10-34-LIM	NA	NA	NA

FCC CONDUCTED SPUR EMISSION ATE # 1 (SW version: Conducted Spur ATE_rev 1.23.03)

Description	Model	Serial Number	Calibration Date	Calibration Due Date
SWITCH CONTROL UNIT	3488A	2719A32735	CNR	CNR
ANALYZER SPECTRUM	E4440A	MY48250517	21-Dec-21	21-Dec-22
POWER SUPPLY	6031A	3221A02613	25-May-21	25-May-22
INTERFACE BOX - FILTER	CNR	CS001	06-Jul-21	06-Jul-22
N to N RF Cable # 1	SF126/11N/11N	NA	NA	NA
N to N RF Cable # 2	SF126/11N/11N	NA	NA	NA
BNC to BNC RF Cable # 1	RG 58	NA	NA	NA
Aeroflex Attenuator 30dB	49-30-43-LIM	NA	NA	NA
Aeroflex Attenuator 10dB	33-10-34-LIM	NA	NA	NA

DESCRIPTION	MODEL	SERIAL NUMBER	CALIBRATION DATE	CALIBRATION DUE DATE
3M SEMI-ANECHOIC CHAMBER	NA	888032	No Cal. Req'd	No Cal. Req'd
TURNTABLE FLUSH MOUNT 2M	T-200-S	N/A	No Cal. Req'd	No Cal. Req'd
BORE SIGHT ANTENNA MAST	MBS-500	N/A	No Cal. Req'd	No Cal. Req'd
PROGRAMMING CONTROLLER	MF-7802BS	N/A	No Cal. Req'd	No Cal. Req'd
POWER SUPPLY (0-60V/0-50A, 1000W)	6032A	41001736	28-Jun-21	28-Jun-22
SIGNAL ANALYZER	FSV40	101103	26-Jun-20	26-Jun-22
DATA LOGGER	SDL500	A.016776	17-Jun-21	17-Jun-22
BICONILOG ANTENNA	3142E	00143249	15-Jul-21	15-Jul-22
BILOG ANTENNA	CBL6112B	2964	04-May-21	04-May-22
DRG HORN FREQ.	SAS-571	1143	24-Feb-21	24-Feb-23
DRG HORN FREQ.	SAS-571	719	13-Sept-21	13-Sept-22
PREAMPLIFIER	PAM-0118P	574	02-Sep-21	02-Sep-22
SIGNAL GENERATOR	SMB100A	180683	13-Apr-21	13-Apr-24

5.0 Test Condition

5.1. Transmitter Test Conditions

Test Item, (Channel Spacing)	Power (W)	Modulation	Test Frequency (MHz)	Tested By	Environmental conditions
RF Output Power	Low & Max	Analog	806.0125, 814.9875, 823.9875, 851.0125, 860.0125, 868.8875	Putri	23.4°C, 50%RH
Frequency Stability	Max	Analog	823.9875	Putri	25.1°C, 54.3%RH, 60.3°C, 50%RH, -30.1°C, 51.2%RH
Modulation Characteristic (12.5kHz / 25kHz)	Max	Analog	823.9875	Putri	23.4°C, 50%RH
Modulation limiting (12.5kHz / 25kHz)	Max	Analog	823.9875	Putri	23.4°C, 50%RH
Occupied Bandwidth (12.5kHz / 20kHz / 25kHz)	Max	Analog, 4FSK	806.0125, 814.9875, 823.9875, 851.0125, 853.9875, 860.0125, 868.8875	Putri	23.4°C, 50%RH
Band Edge Conducted Spurious Emissions (Part 22) (12.5kHz / 20kHz / 25kHz)	Max	Analog, 4FSK	NA		
Transient Frequency Behavior (UHF & VHF Band) (12.5kHz / 25kHz)	Max	Analog, 4FSK	NA		
Adjacent Channel Power (700MHz Band) (12.5kHz / 25kHz)	Max	Analog, 4FSK	NA		
Conducted Spurious Emissions- (12.5kHz / 25kHz)	Low / Max	Analog, 4FSK	806.0125, 814.9875, 823.9875, 851.0125, 860.0125, 868.8875	Putri	23.4°C, 50%RH
Radiated Spurious Emission (12.5kHz / 25kHz)	Low / Max	Analog, 4FSK	806.0125, 814.9875, 823.9875, 851.0125, 860.0125, 868.8875	Aiman & Azil	22.1°C, 53.4%RH
GNSS (EIRP for 1559 - 1610MHz) (12.5kHz / 25kHz)	Max	Analog	NA		
Effective Radiated Power (ERP) (12.5kHz / 25kHz)	Max	Analog	NA		

NA → Not Applicable

6.0 Transmitter Test Parameters

6.1. RF Output Power

6.1.1. Test Setup

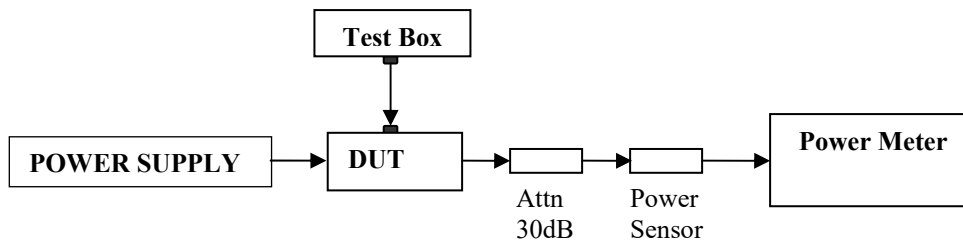

- 1) The DUT transmitter connected to Power Meter using the 30 dB attenuator and power sensor with above setup.
- 2) Path loss for the measurement included.
- 3) All the measurement was done at low, mid, high frequency for each band.
- 4) Record the power into the test report.

6.1.2. Test Result

Temperature	25°C			
Voltage (V)	7.5V			
Frequency (MHz)	Low Power (W)	Current (A)	Max Power (W)	Current (A)
806.01250	0.98	1.24	2.86	1.96
814.98750	0.96	1.23	2.88	1.83
823.98750	0.97	1.28	2.86	1.89
851.01250	1.00	1.14	2.90	1.68
860.01250	0.98	1.28	2.91	1.65
868.88750	0.95	1.13	2.88	1.65

6.2. Frequency Stability

6.2.1. Test Setup

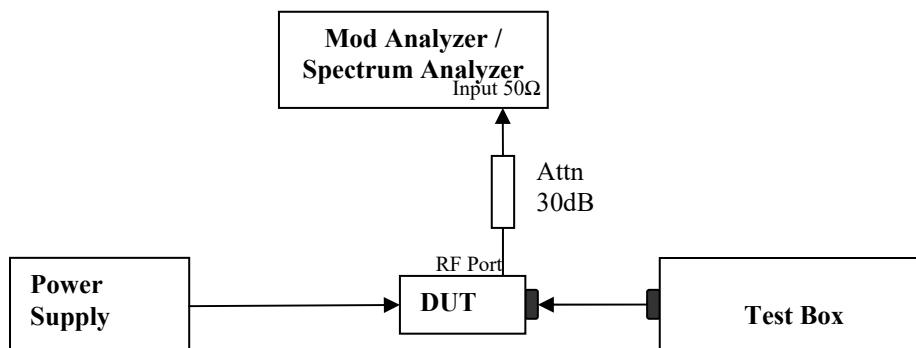

- 1) The DUT transmitter output port was connected to Modulation / Spectrum Analyzer.
- 2) Path loss for the measurement included.
- 3) Transmit the DUT and record the freq in MCF_{MHz} .
- 4) Test in 2 conditions:
 - Temperature: The frequency of the transmitter was measured from $-30^{\circ}C$ to $50^{\circ}C$.
 - Supply Voltage:
 - Mobile: The frequency of the transmitter was measured from 85% to 115% of the nominal operating input voltage.
 - Portable: The frequency of the transmitter was measured from nominal $\pm x\%$ as specified by the manufacturer
- 5) Calculate the ppm frequency error by the following:

$$ppm\ error = \left(\frac{MCF_{MHz}}{ACF_{MHz}} - 1 \right) * 10^6$$

Where: MCF_{MHz} is the Measured Carrier Frequency in MHz
 ACF_{MHz} is the Assigned Carrier Frequency in MHz

6.2.2. Test Result

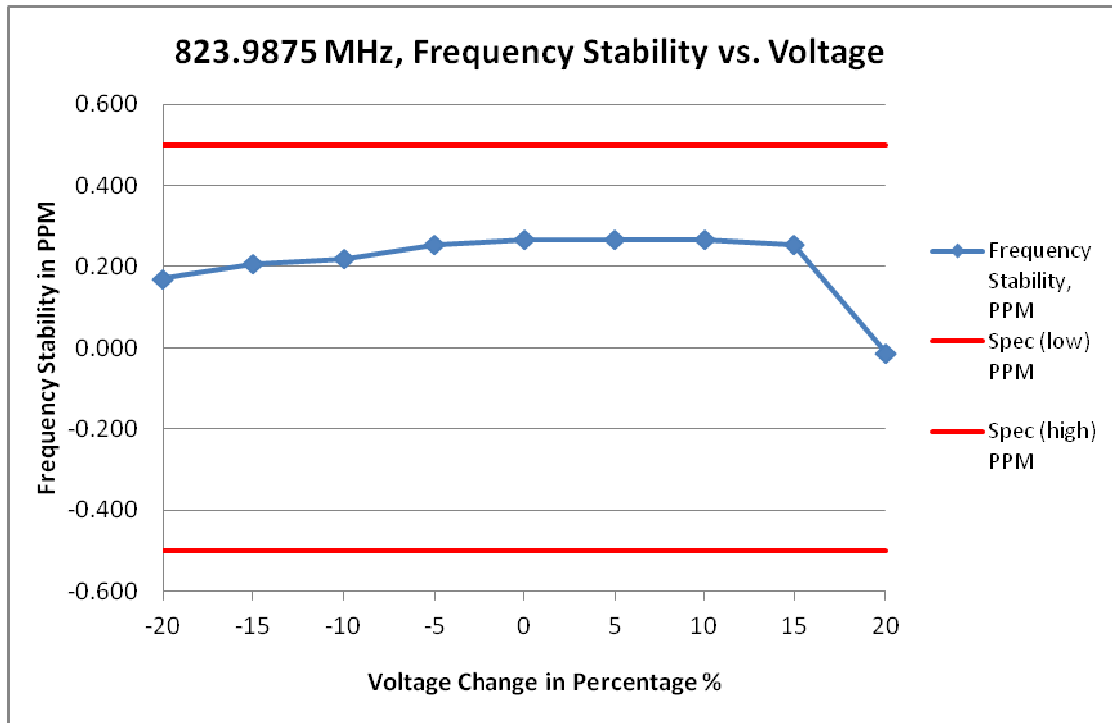

(i) Frequency Stability VS Voltage

Frequency / Channel Spacing	823.9875 MHz / 12.5 kHz				
Temperature, °C	25				
Voltage %	Voltage, V	Frequency, MHz	Frequency Stability, PPM	Spec (low) PPM	Spec (high) PPM
-20	6.000	823.987640	0.170	-0.500	0.500
-15	6.370	823.987670	0.206	-0.500	0.500
-10	6.750	823.987680	0.218	-0.500	0.500
-5	7.120	823.987710	0.255	-0.500	0.500
0	7.500	823.987720	0.267	-0.500	0.500
5	7.870	823.987720	0.267	-0.500	0.500
10	8.250	823.987720	0.267	-0.500	0.500
15	8.620	823.987710	0.255	-0.500	0.500
20	9.000	823.987490	-0.012	-0.500	0.500

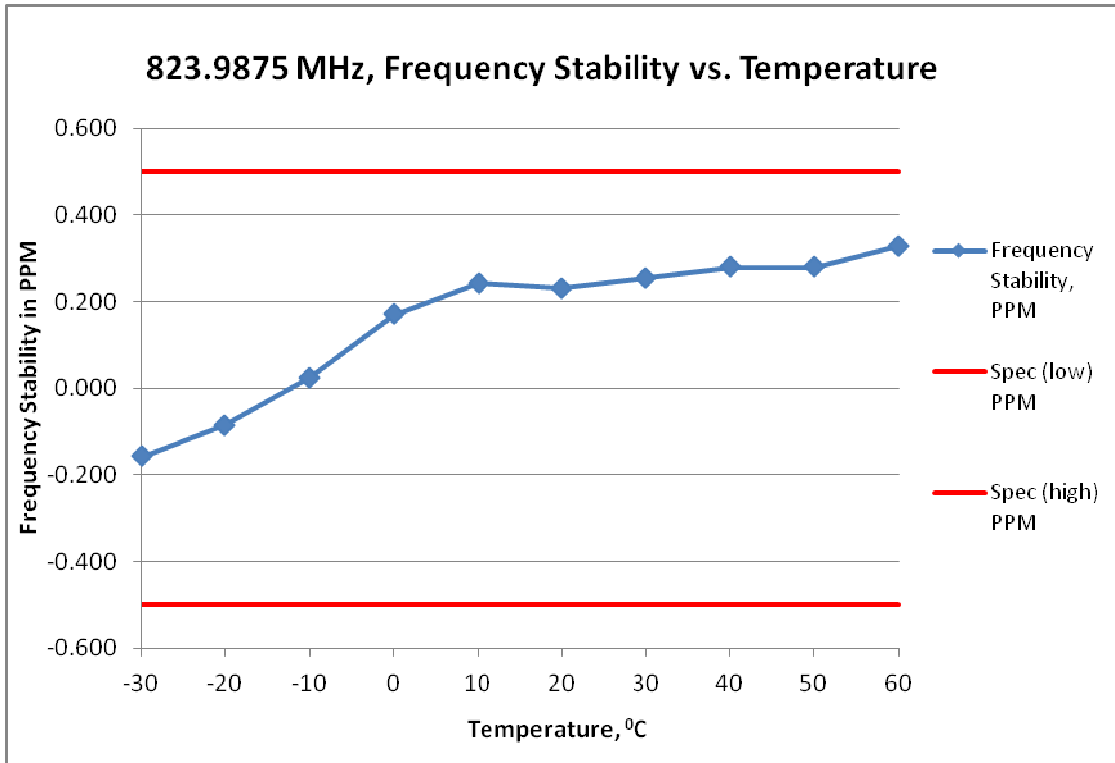

(ii) Frequency Stability VS temperature

Frequency / Channel Spacing	823.9875 MHz / 12.5 kHz			
Voltage, V	7.5			
Temperature, °C	Frequency, MHz	Frequency Stability, PPM	Spec (low) PPM	Spec (high) PPM
-30	823.987370	-0.158	-0.500	0.500
-20	823.987430	-0.085	-0.500	0.500
-10	823.987520	0.024	-0.500	0.500
0	823.987640	0.170	-0.500	0.500
10	823.987700	0.243	-0.500	0.500
20	823.987690	0.231	-0.500	0.500
30	823.987710	0.255	-0.500	0.500
40	823.987730	0.279	-0.500	0.500
50	823.987730	0.279	-0.500	0.500
60	823.987770	0.328	-0.500	0.500

6.2.3. Test Limit

As per manufacturer declared spec +/- 0.5ppm

6.3. Modulation Characteristics

6.3.1. Test Setup

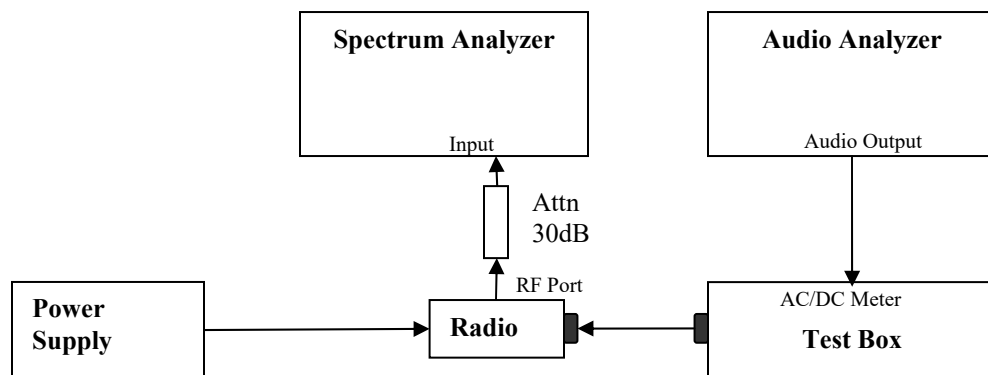

- 1) The DUT transmitter output port was connected to Modulation Analyzer.
- 2) Path loss for the measurement included.
- 3) Set the audio bandwidth filter to 15 kHz and 50 kHz.
- 4) Transmit the radio and set the audio analyzer to 1 kHz audio frequency and 20% of the Full rated system deviation.
- 5) On audio analyzer, set the rated level as 0dB reference
- 6) Vary the audio frequency from 300 Hz to 20 kHz. Record the change in modulation in reference to step 5.

6.3.2. Test Result

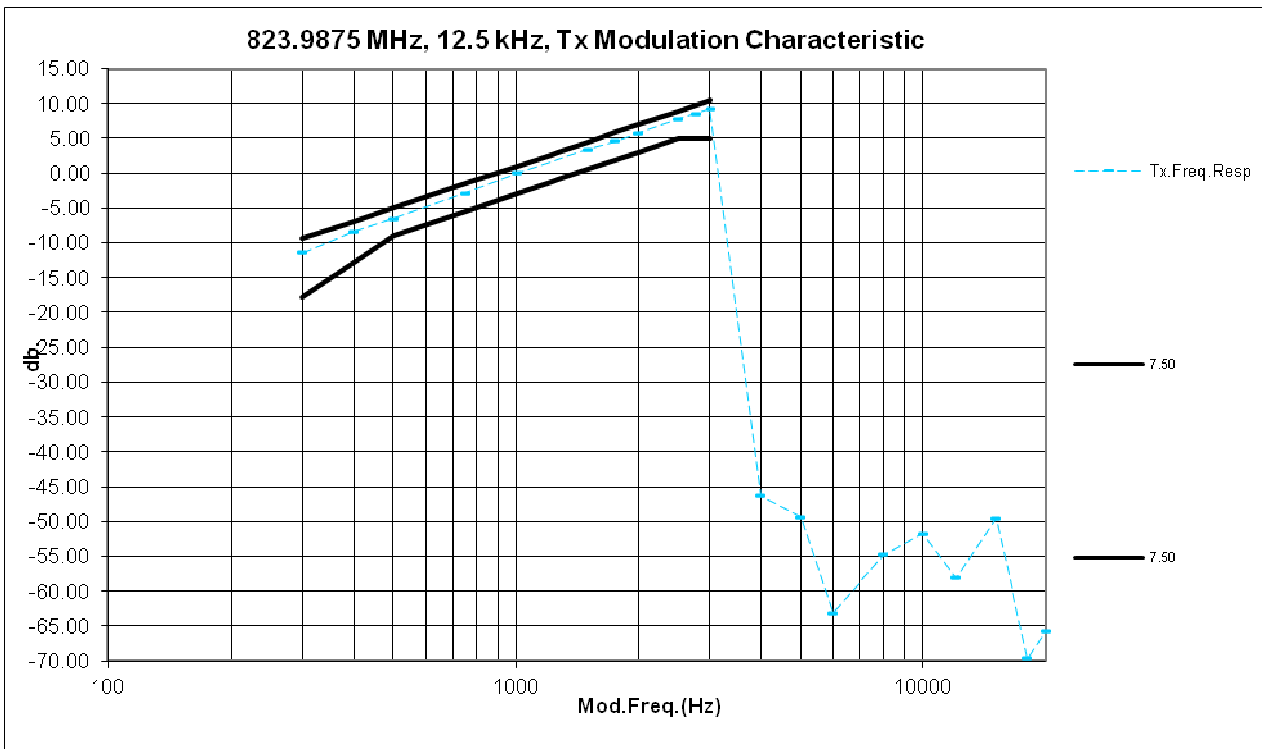
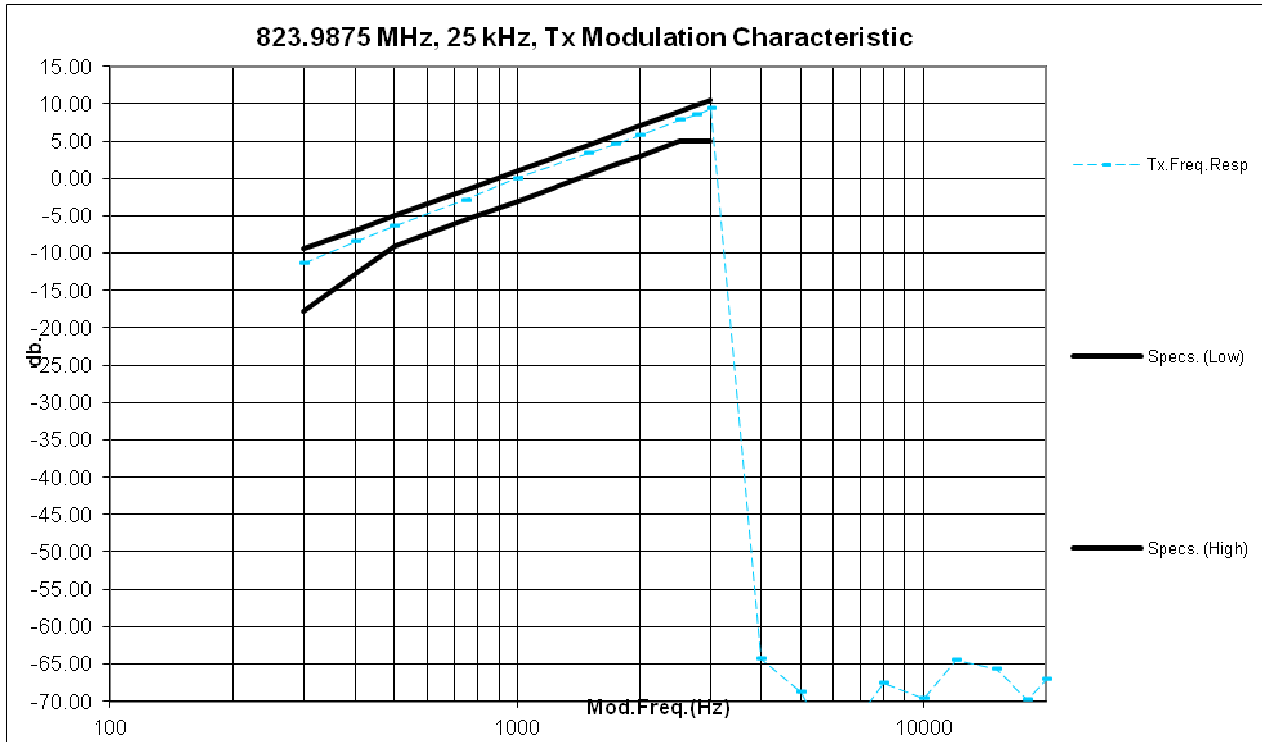

6.3.3. Test Limit

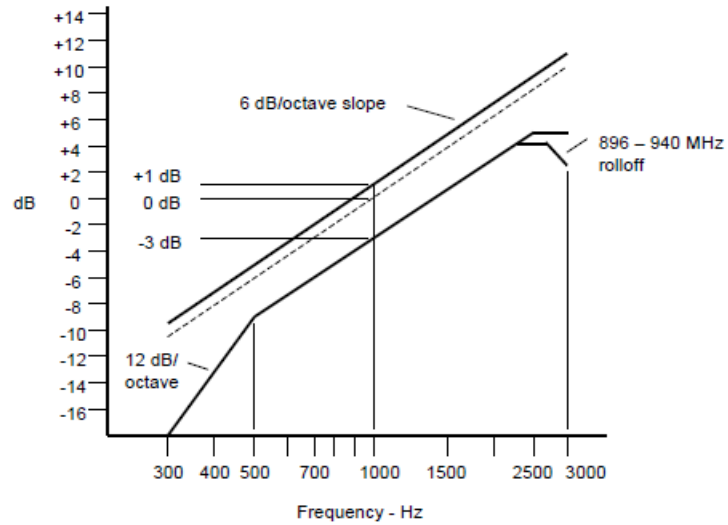

Note:

- o There are additional 6 dB per octave attenuation is allowed from 2.5KHz to 3KHz in equipment 25MHz to 869MHz radio.
- o Additional 6 dB per octave attenuation is allowed from 2.3KHz to 2.7KHz & additional 12 dB per octave attenuation is allowed from 2.7KHz to 3KHz in equipment 896MHz to 940MHz radio.

6.4. Modulation Limiting

6.4.1. Test Setup

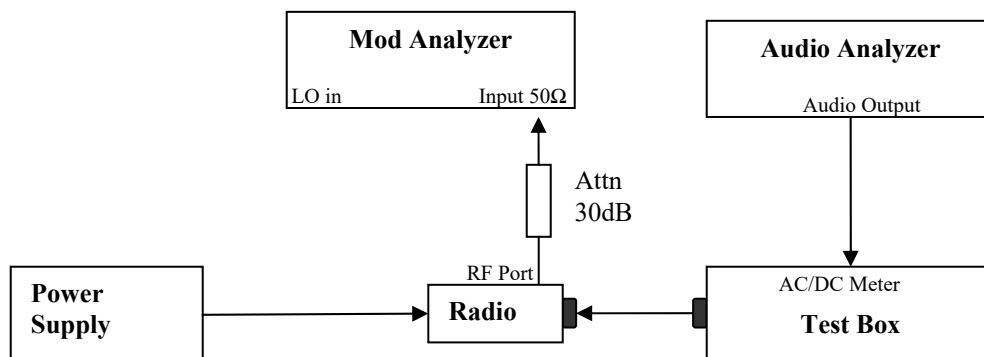

- 1) The DUT transmitter output port was connected to Modulation Analyzer.
- 2) Path loss for the measurement included.
- 3) Set the audio bandwidth filter to 15 kHz.
- 4) Transmit the radio and set the audio analyzer to 1 kHz audio frequency and 60% of the Full rated system deviation.
- 5) Record the frequency deviation as 0dB input level at 1kHz audio frequency.
- 6) Repeat the step and record the frequency deviation from -20 dB to 20dB by 5 dB increments and different audio freq 300 Hz, 2.5 kHz and 3 kHz.

6.4.2. Test Result

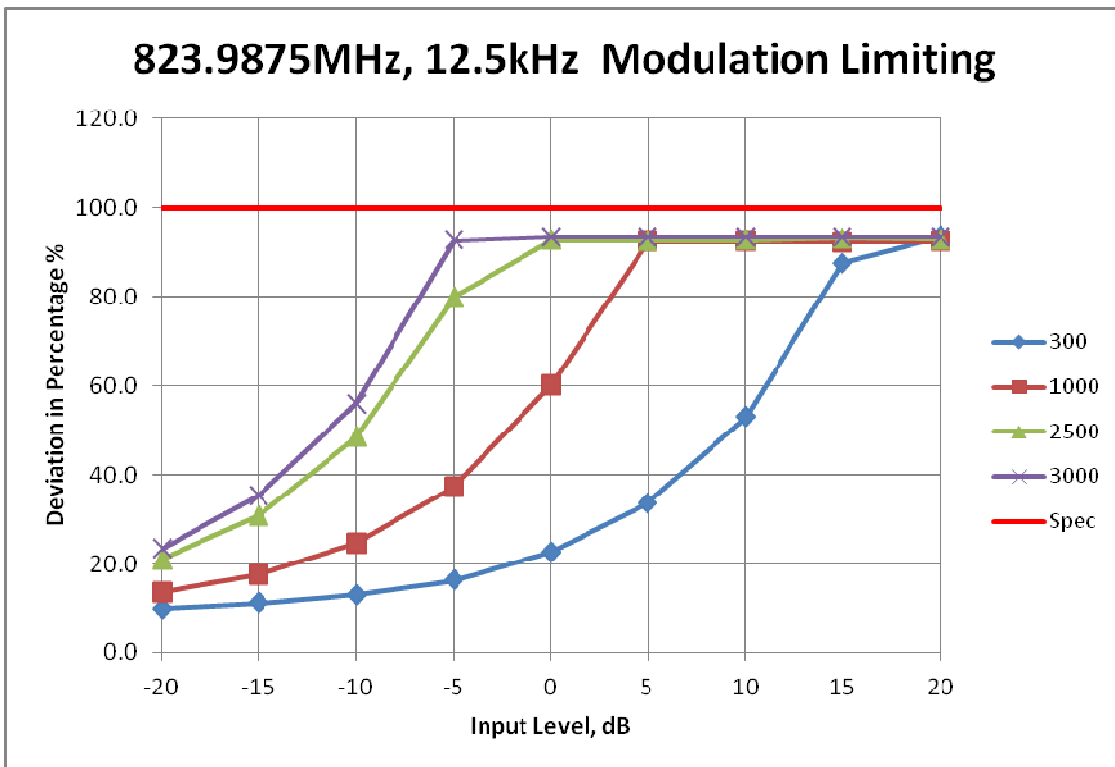
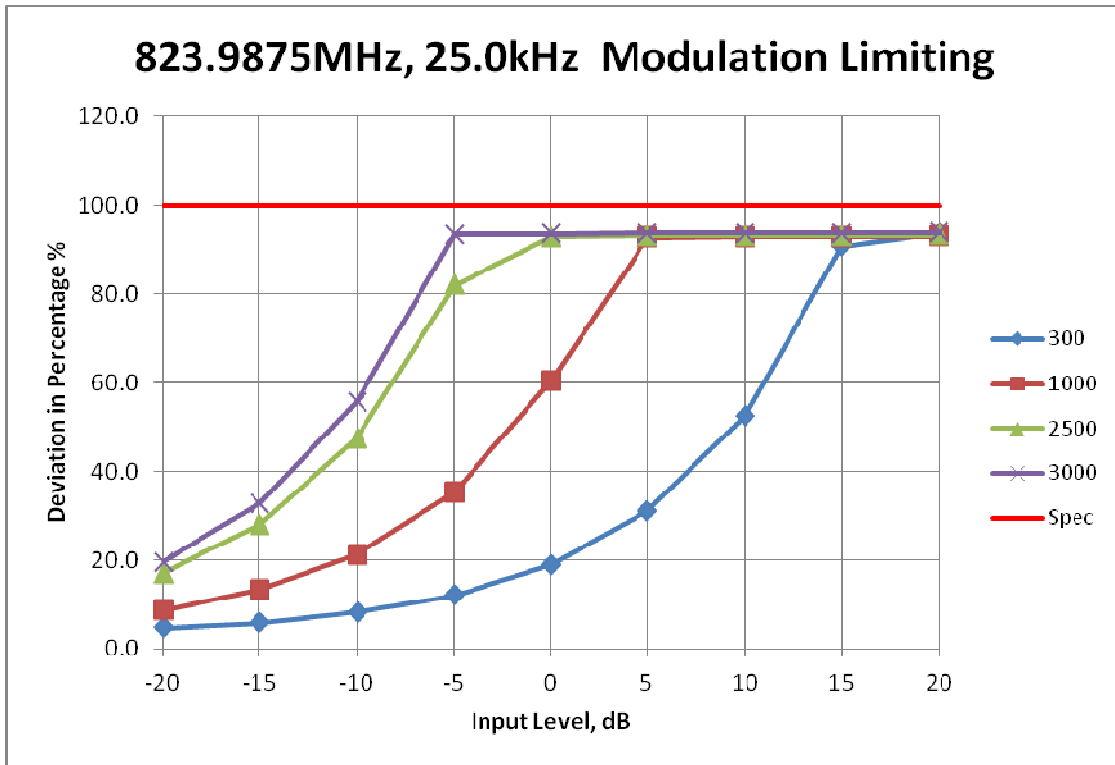

6.4.3. Test Limit

Modulation Limiting shall not exceed 100 percent.

6.5. Occupied Bandwidth

6.5.1. Test Setup (Analog)

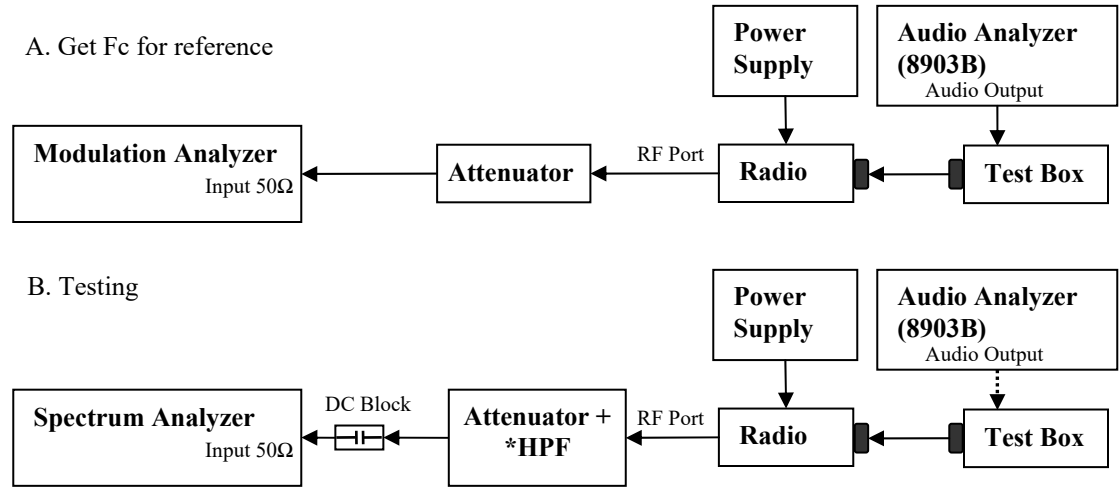

- 1) The DUT transmitter output port was connected to Modulation Analyzer.
- 2) Set the audio bandwidth filter to 15 kHz low pass filter and 50 kHz high pass filter.
- 3) Transmit the radio and set the audio analyzer to 2.5 kHz audio frequency and 50% of the rated deviation. Up the amplitude by 16 dB. Dekey the DUT.
- 4) Path loss for the measurement included.
- 5) Select the Occupied Bandwidth measurement for 99% Emissions Bandwidth Measurement.
- 6) Key in the Fc and Resolution Bandwidth (1 ~ 5 % of emission designator).
- 7) Transmit the DUT and record the occupied Bandwidth frequency.
- 8) Preset the spectrum analyzer for sideband spectrum measurement.
- 9) Set the span and Resolution Bandwidth (according to FCC/ ISED standard).
- 10) Save the screen shot as modulated signal
- 11) Remove the audio tone from audio analyzer to capture unmodulated signal.

* Only HPF added for Mask 80.211 measurement with attenuator.

* 99% Bandwidth measurement is computed by the spectrum analyzer and is consistent with the C63.26 5.4.4 method.

6.5.2. Test Result (Analog)

Standard Audio Modulation (25 kHz Channelization, Analog Voice):
Emission Designator 16K0F3E

In this case, the maximum modulating frequency is 3 kHz with a 5 kHz deviation.

$BW = 2(M+D) = 2*(3 \text{ kHz} + 5 \text{ kHz}) = 16 \text{ kHz} = 16K0$
F3E portion of the designator indicates voice.

Therefore, the entire designator for 25 kHz channelization analog voice is 16K0F3E.

Standard Audio Modulation (12.5 kHz Channelization, Analog Voice):
Emission Designator 11K0F3E

In this case, the maximum modulating frequency is 3.0 kHz with a 2.5 kHz deviation.

$BW = 2(M+D) = 2*(3.0 \text{ kHz} + 2.5 \text{ kHz}) = 11 \text{ kHz} = 11K0$
F3E portion of the designator indicates voice.

Therefore, the entire designator for 12.5 kHz channelization analog voice is 11K0F3E.

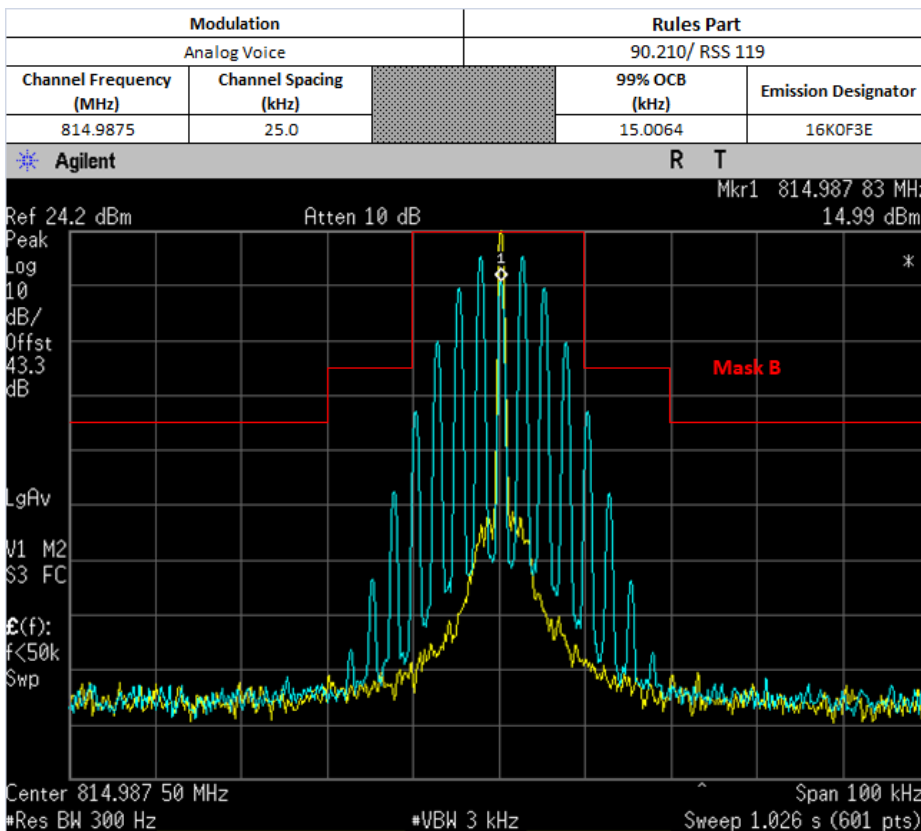
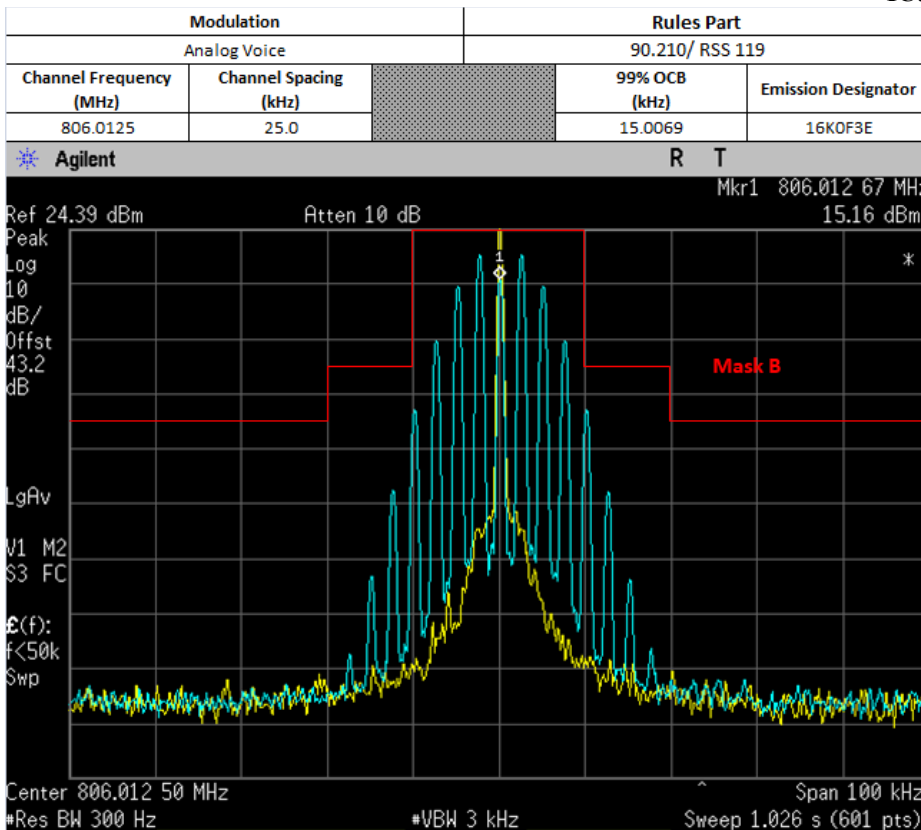

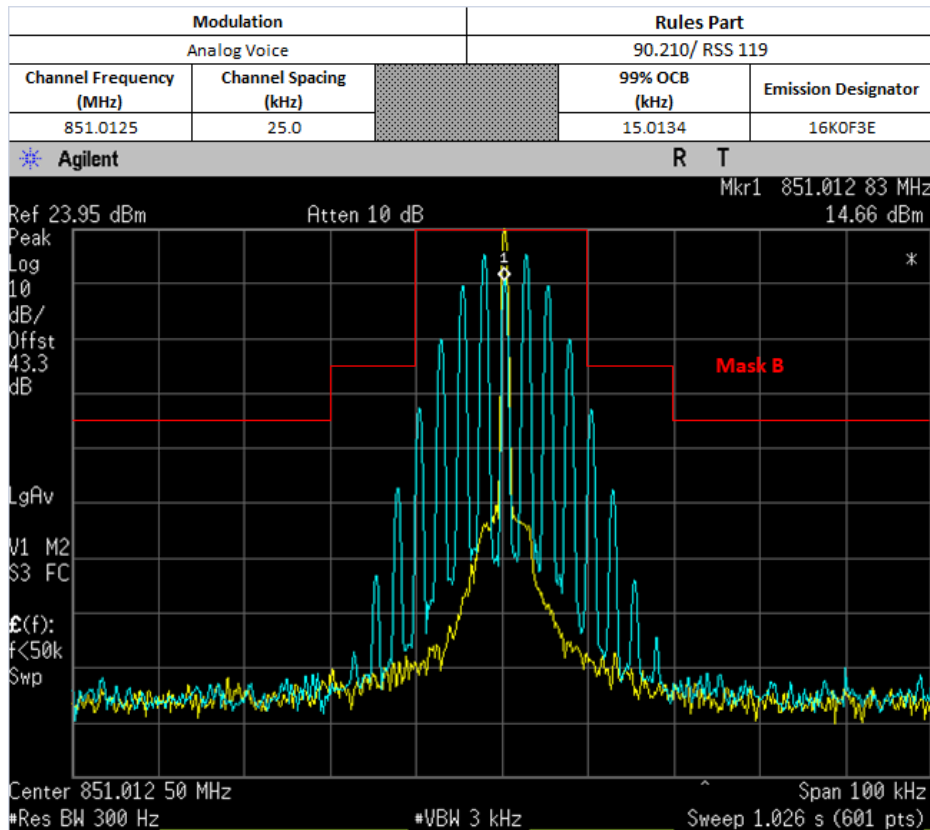
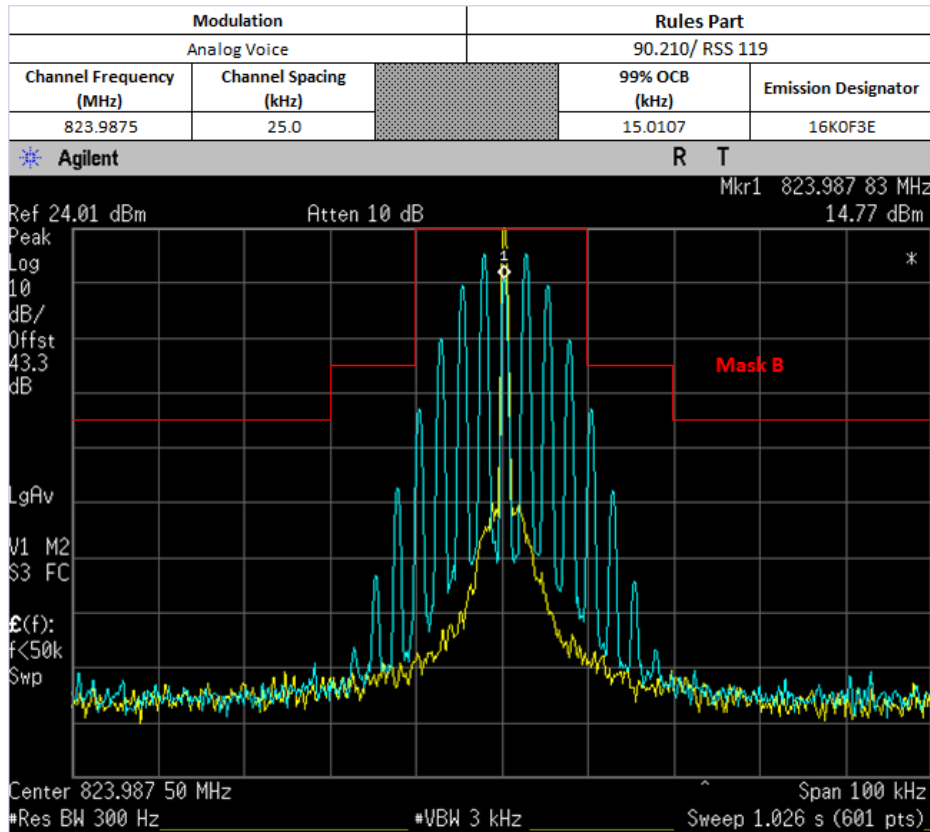

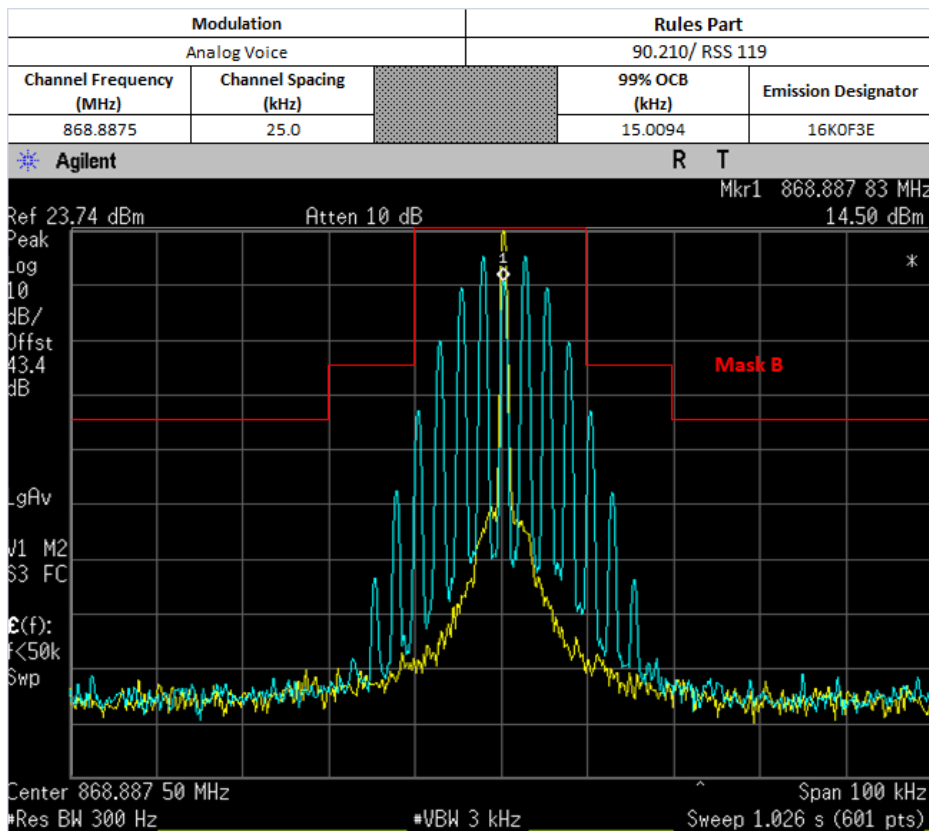
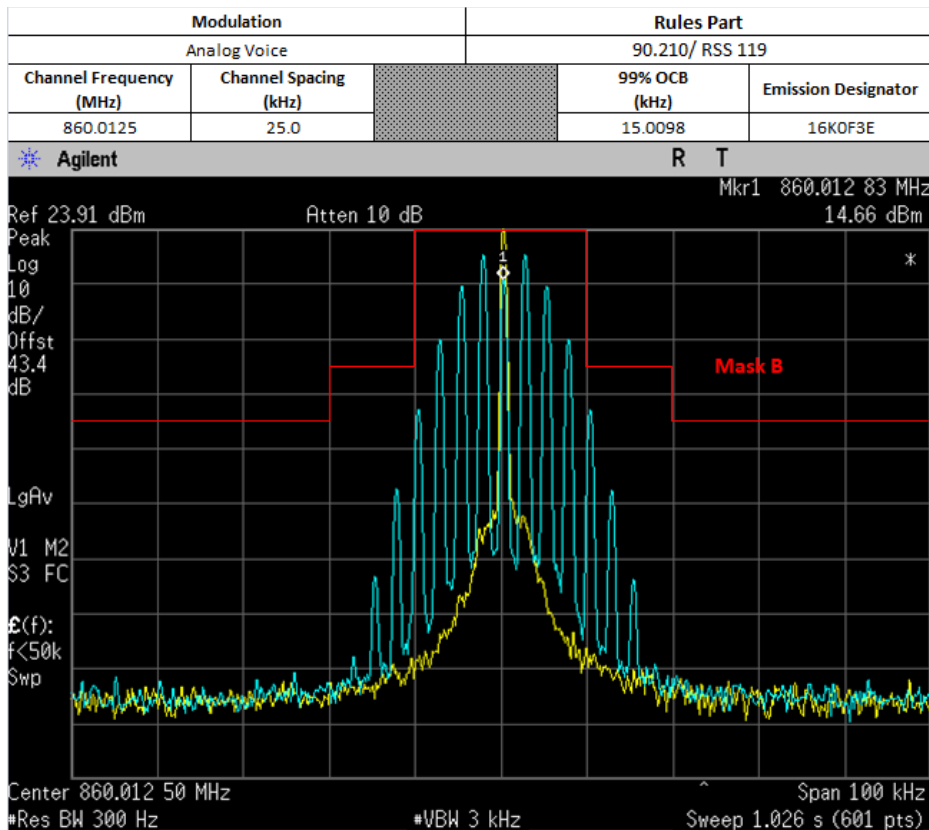

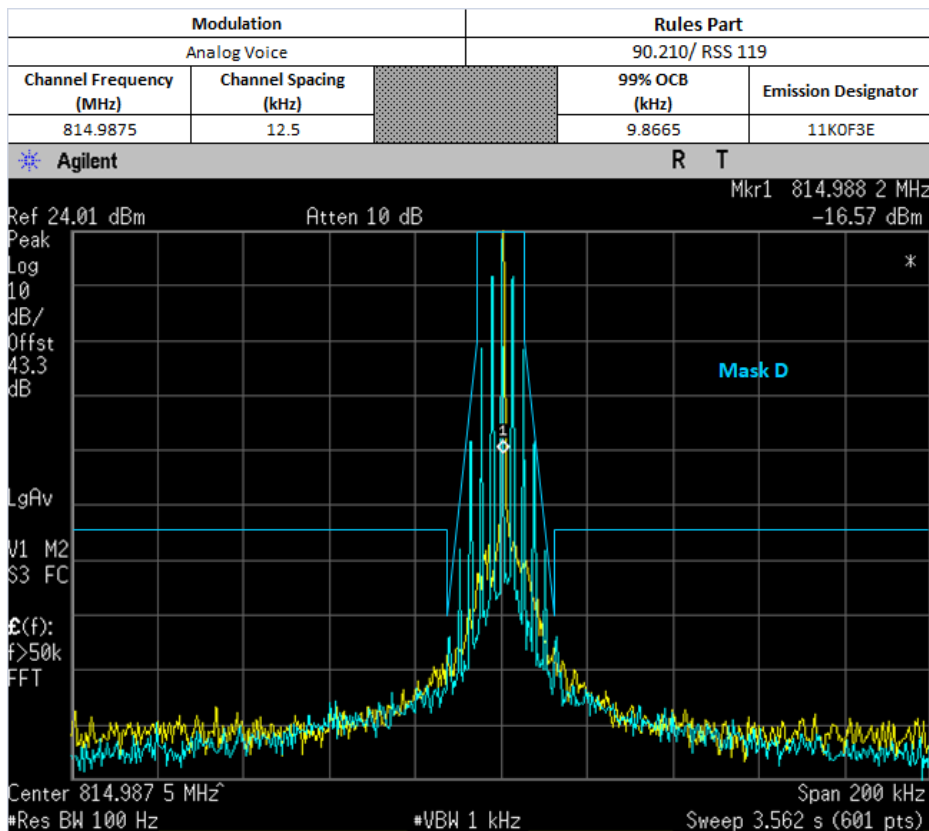
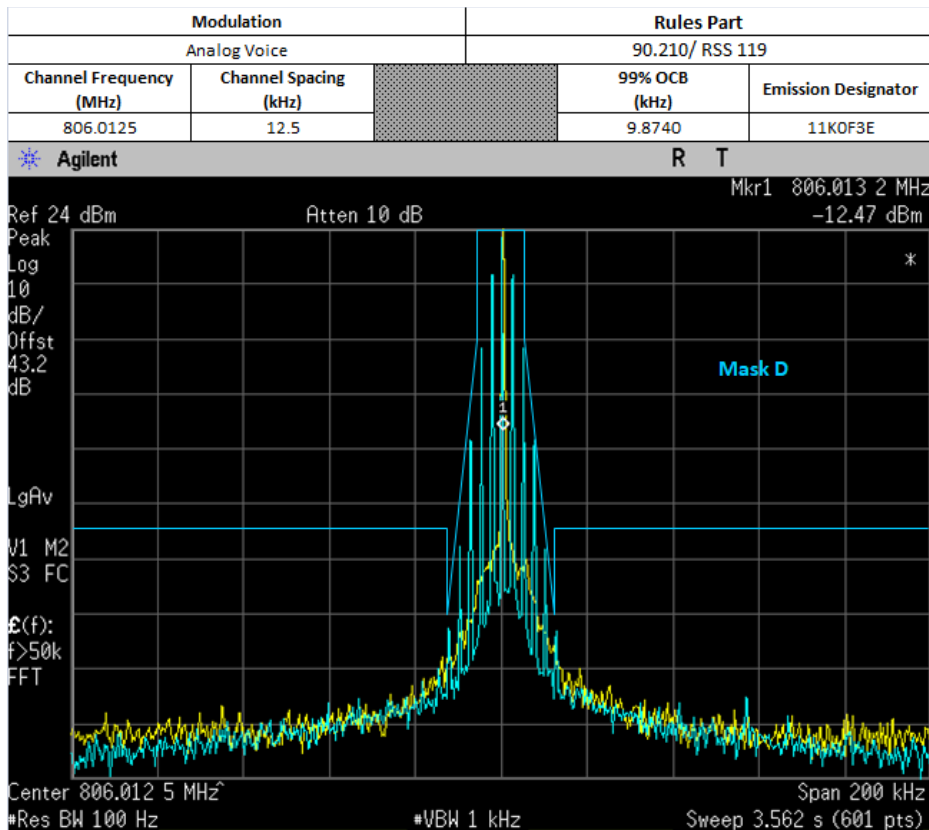

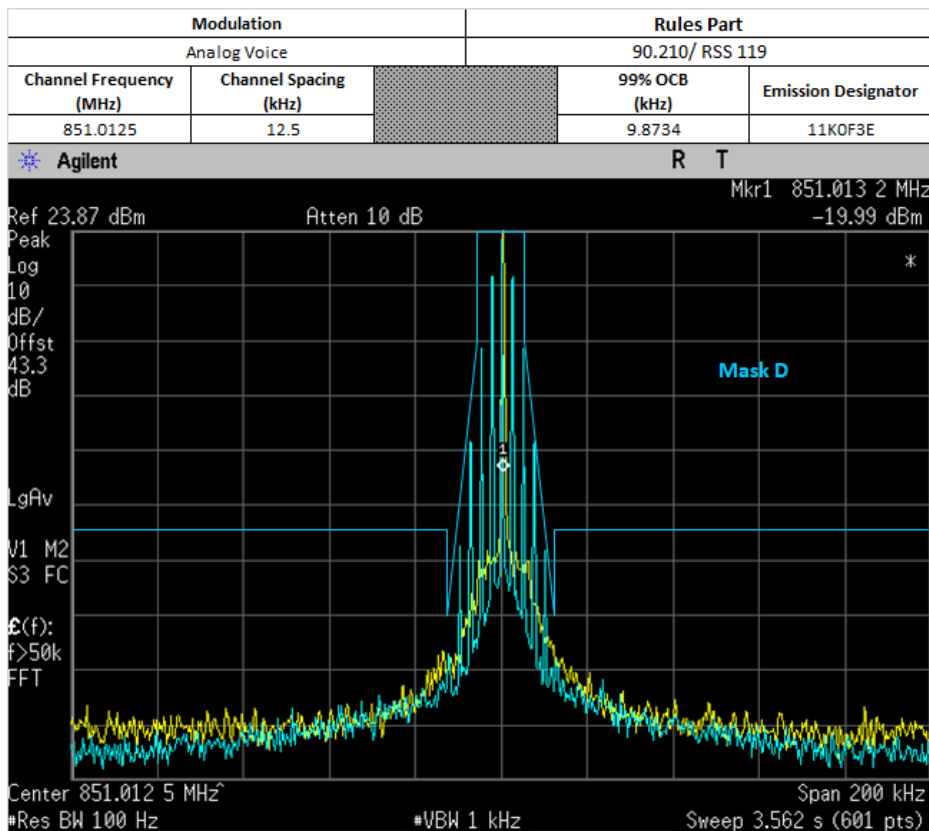
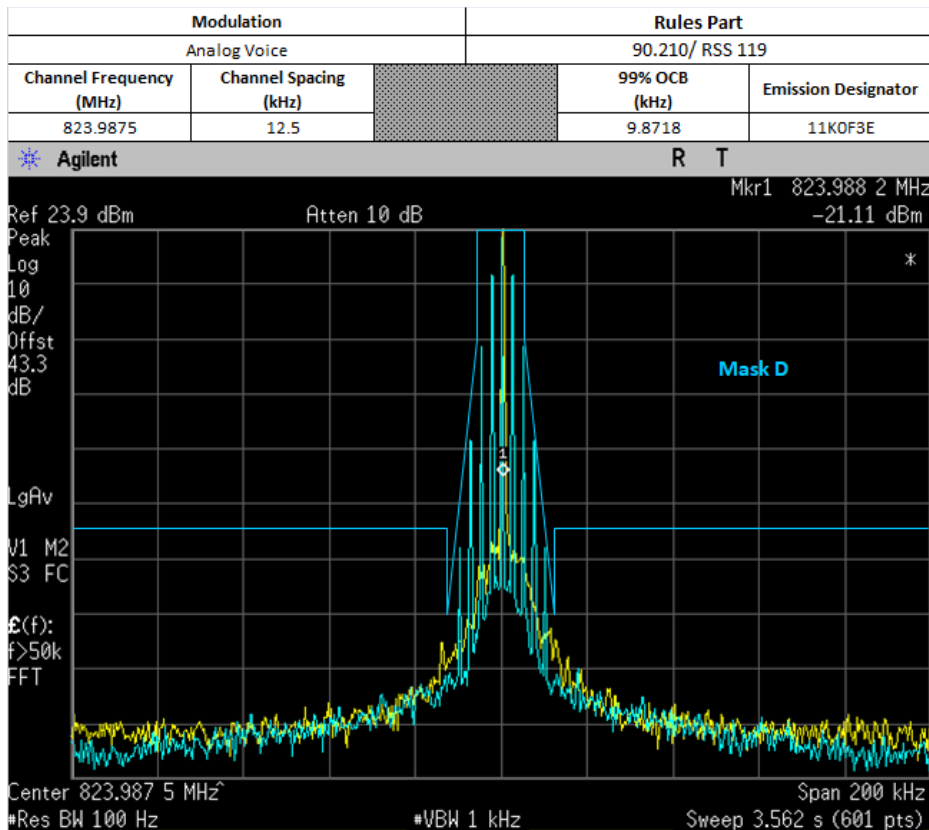

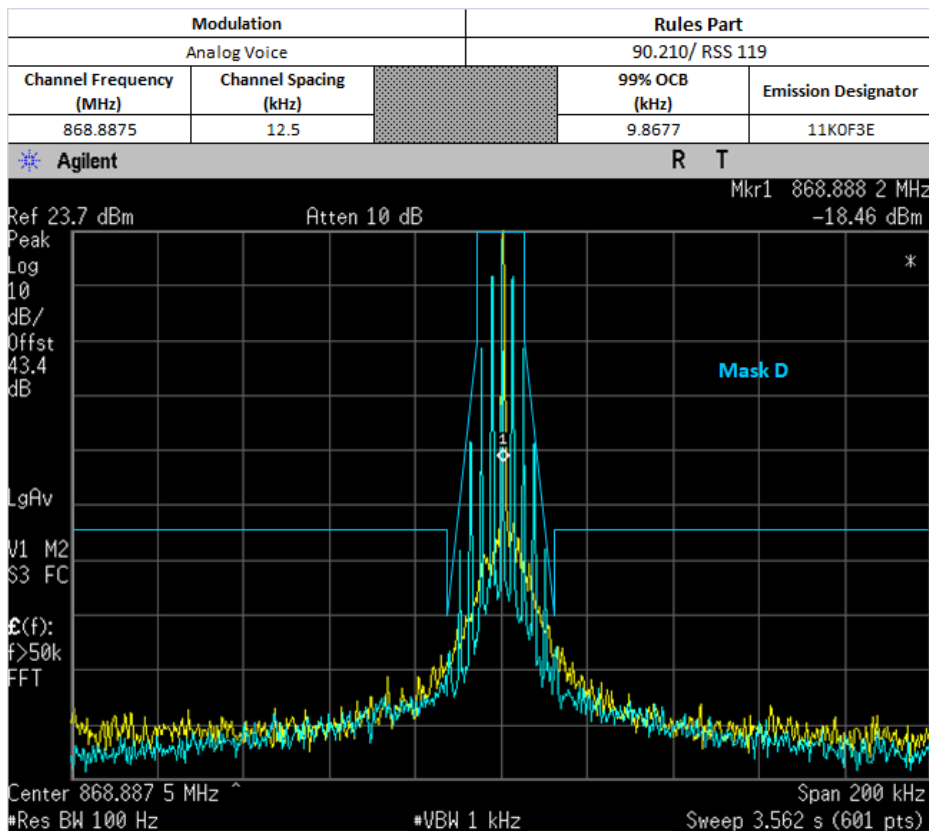
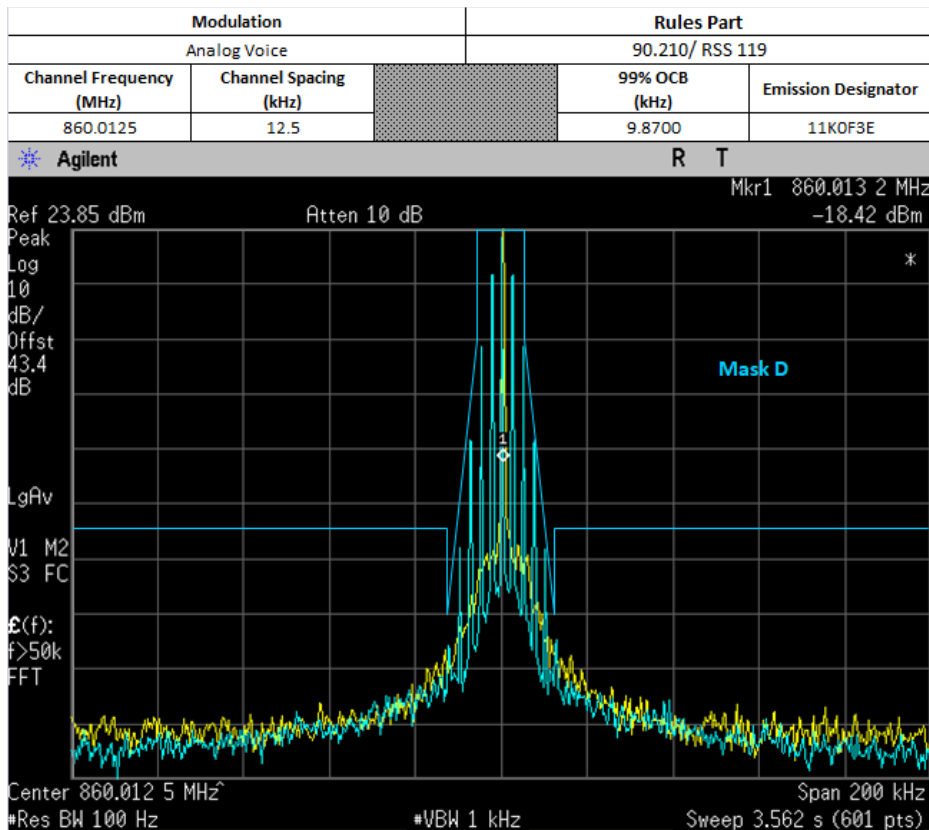

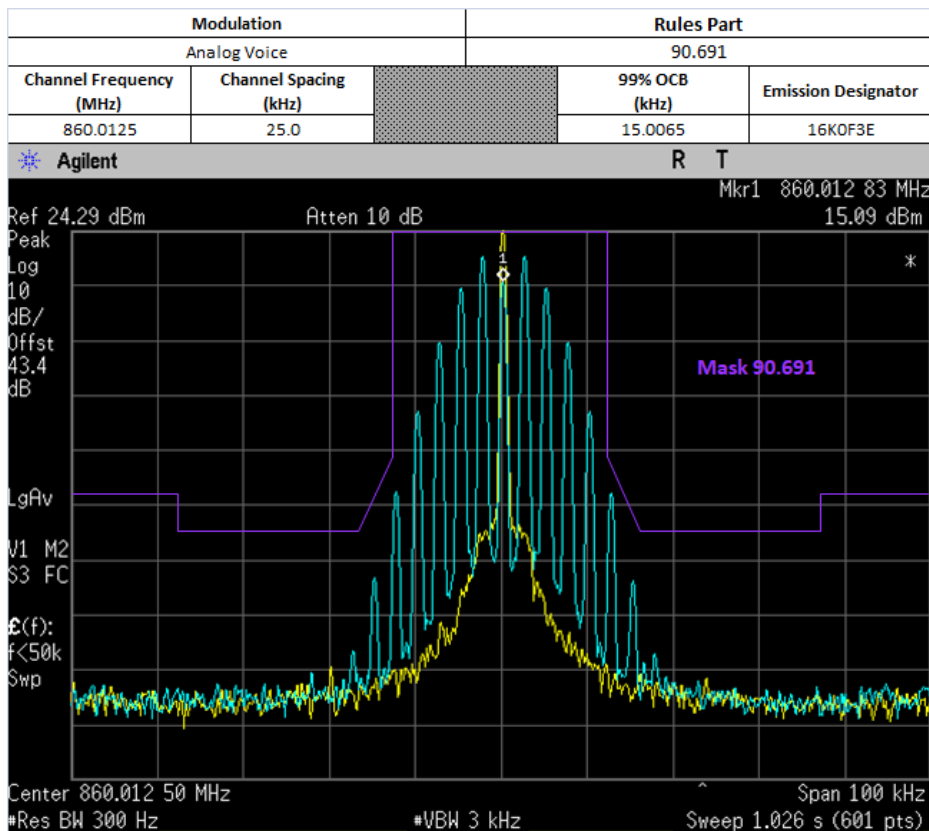
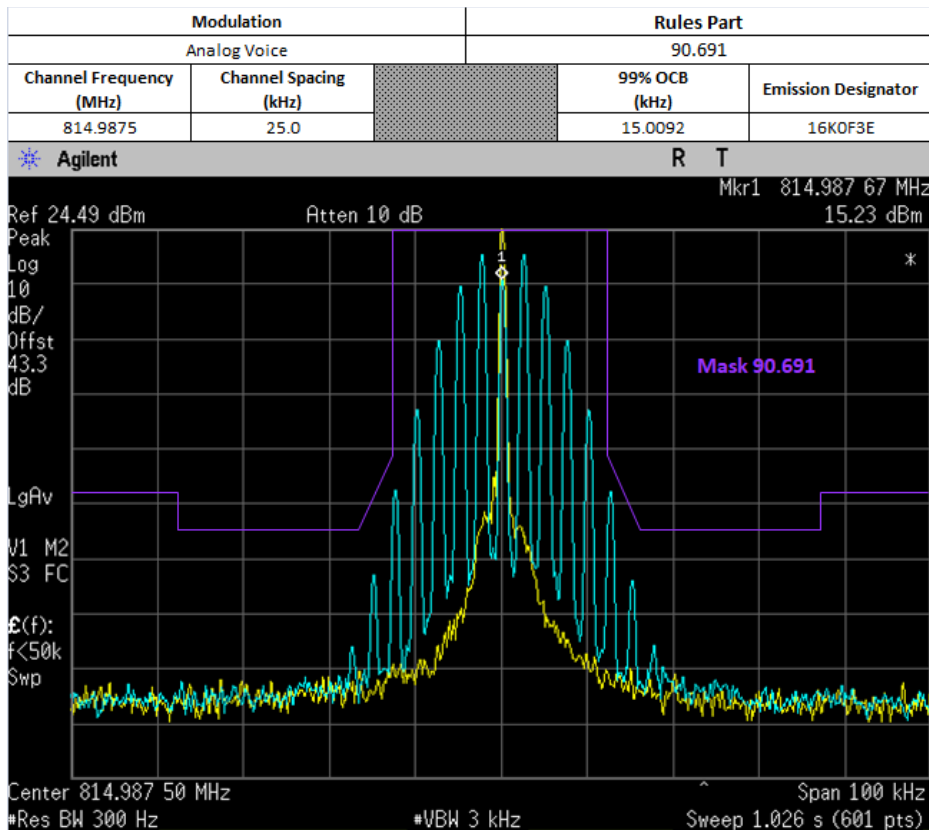

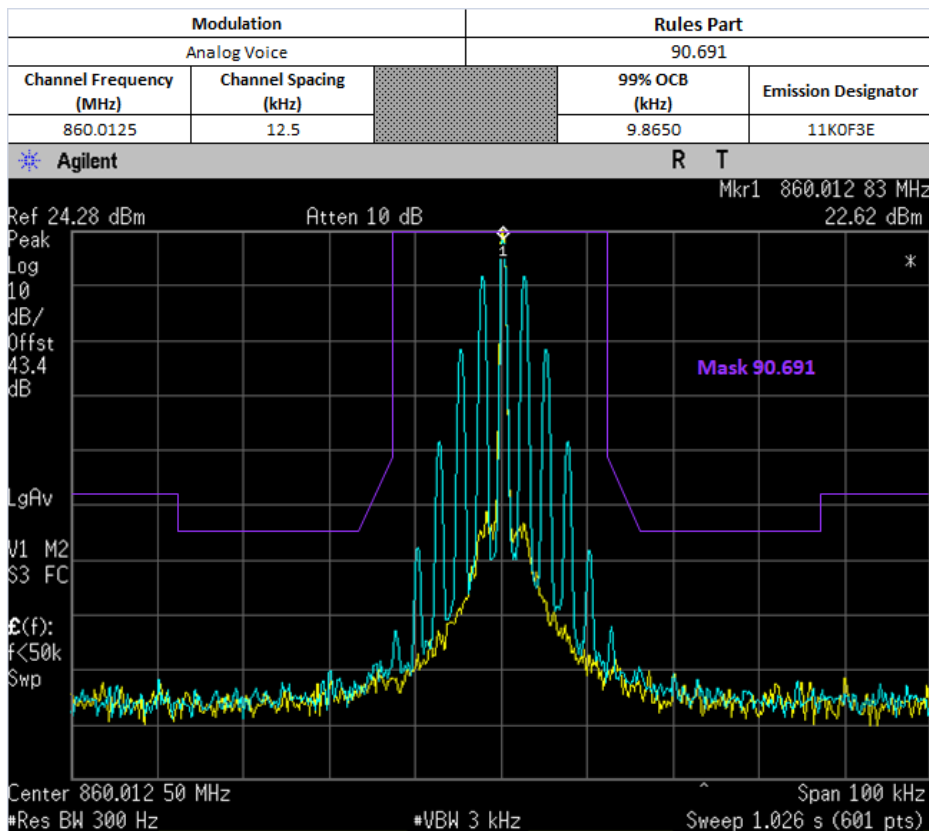
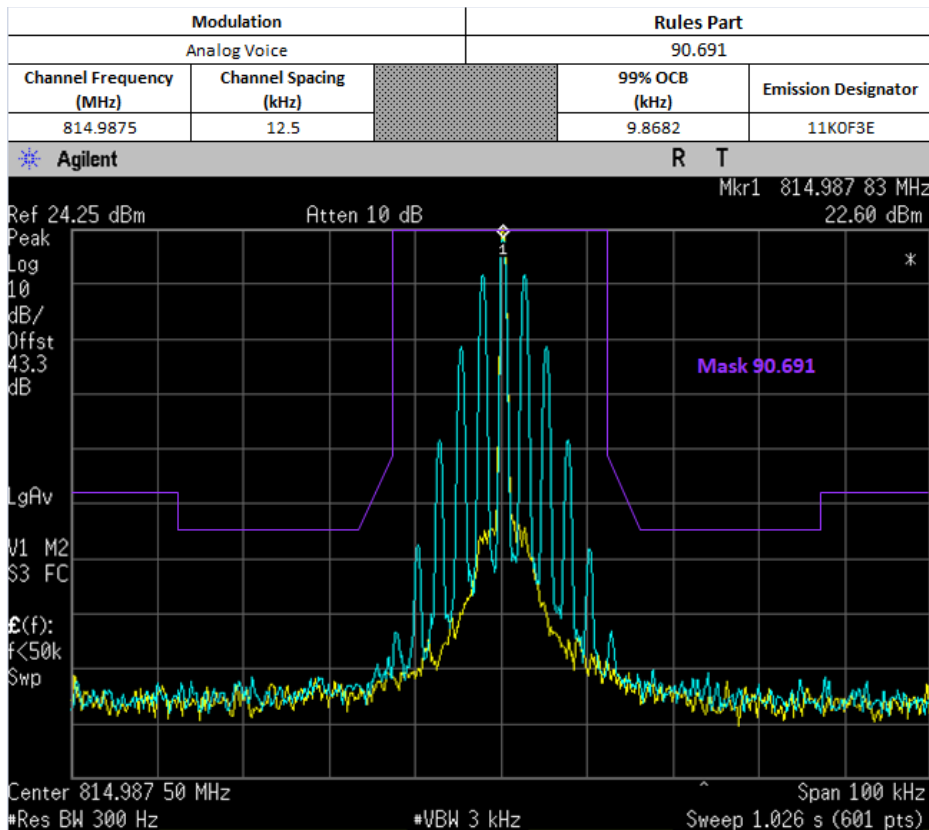

6.5.3. Test Setup (Digital)

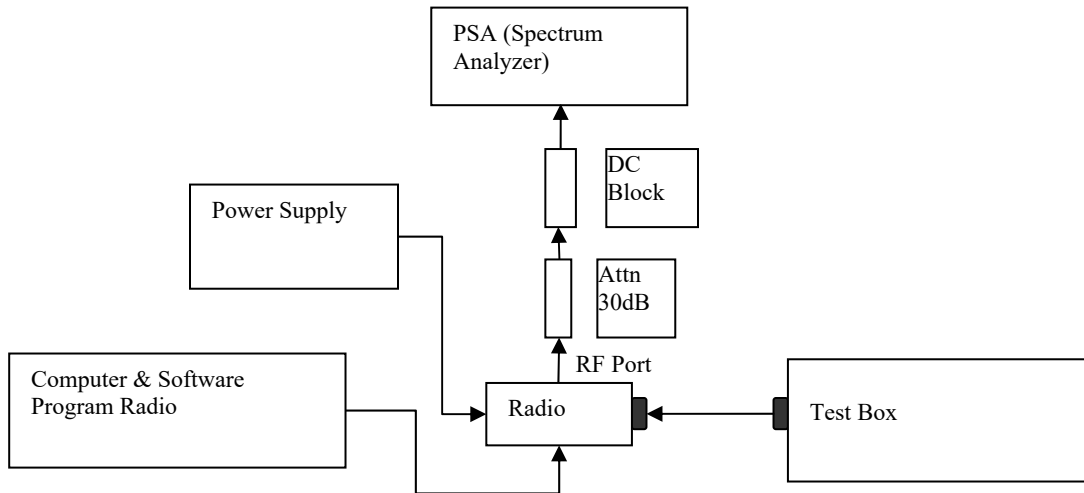

- 1) Program and set radio to operate in desire test frequency and digital mode with modulation. (*4FSK, C4FM or other digital modulation form).
- 2) Path loss for the measurement included.
- 3) Select the Occupied Bandwidth measurement for 99% Emissions Bandwidth Measurement.
- 4) Key in the Fc and Resolution Bandwidth (1 ~ 5 % of emission designator).
- 5) Transmit the DUT and record the occupied Bandwidth frequency.
- 6) Preset the spectrum analyzer for modulation emission spectrum measurement.
- 7) Set the span and Resolution Bandwidth (according to FCC/ ISED standard).
- 8) Capture the screen shot as modulated signal.

* 99% Bandwidth measurement is computed by the spectrum analyzer and is consistent with the C63.26 5.4.4 method.

*Note:

- For Digital Modulation, 12.5 kHz Data F1D & FXD would be the same. Therefore only measurements with F1D modulation shown below.
- For Digital Modulation, 12.5 kHz Data F1E & FXE would be the same. Therefore only measurements with F1E modulation shown below.

6.5.4. Test Result (Digital)

Digital (12.5 kHz Channelization, Digital Voice/Data/Voice+Data):
Emission Designator 7K60F1E/D/W

The 99% energy rule (title 47CFR 2.989) was used for digital mode and is more accurate than Carson's rule. It basically states that 99% of the modulation energy falls within X kHz, in this case, 7.60 kHz. Measurements were performed in accordance with TIA/EIA TSB102.CAAB Section 2.2.5.2. The emission mask was obtained from 47CFR 90.210(d).

F1E/D/W portion of the designator indicates digital voice/data/voice+data.

Therefore, the entire designator for 12.5 kHz channelization digital voice is 7K60F1E/D/W.

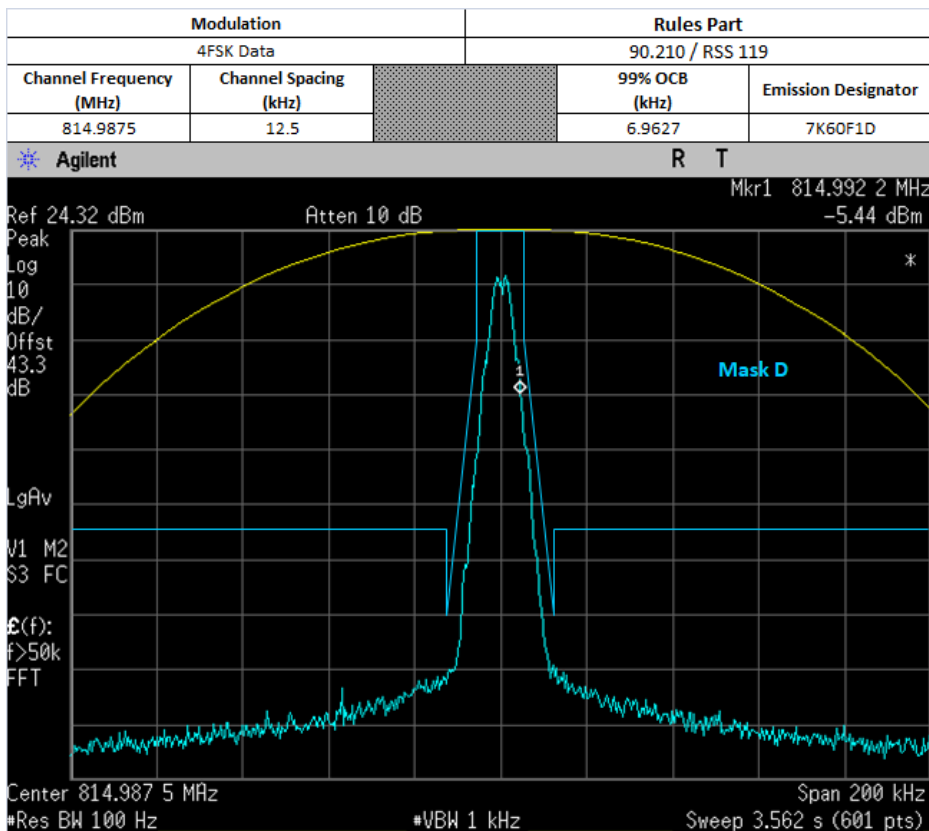
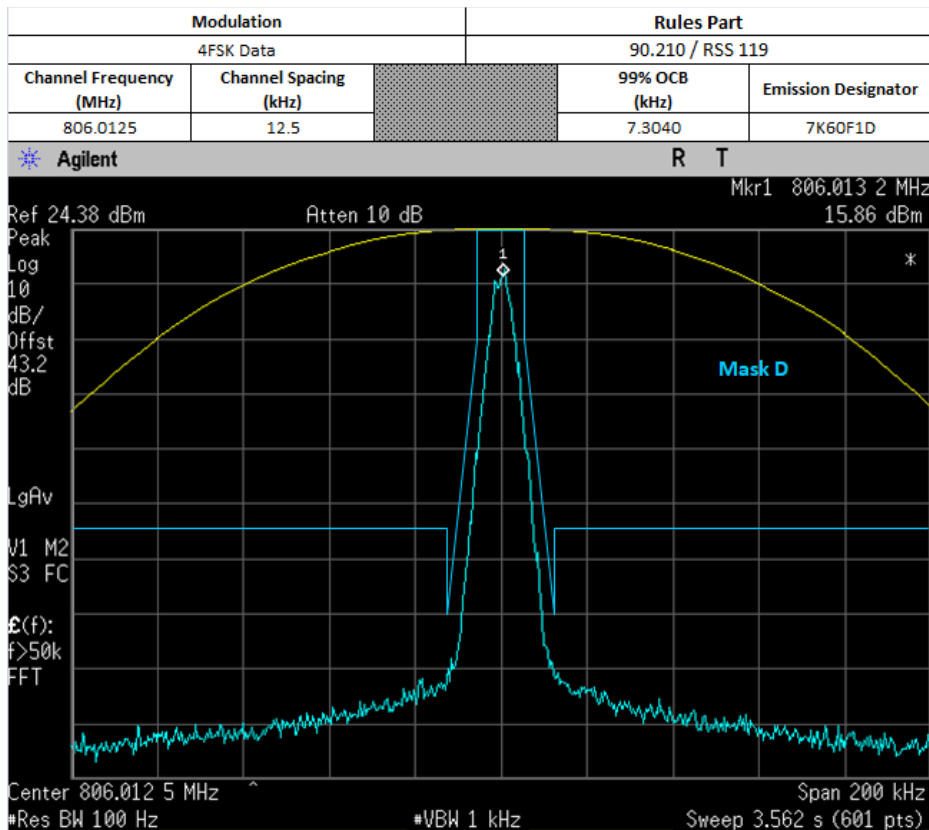

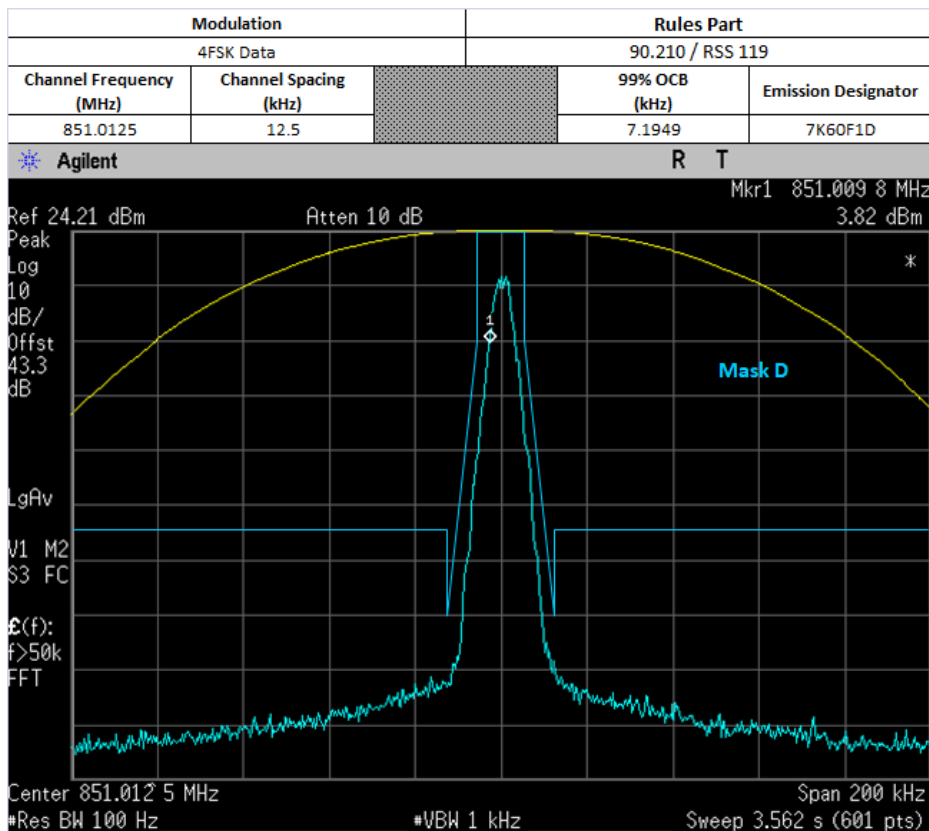
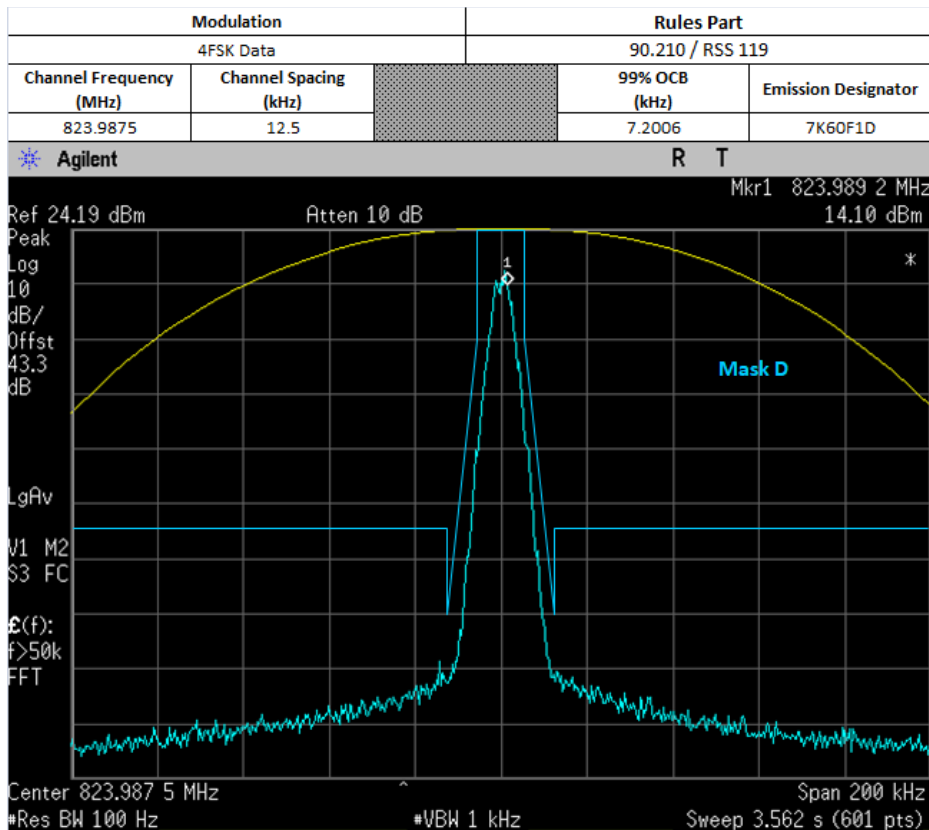

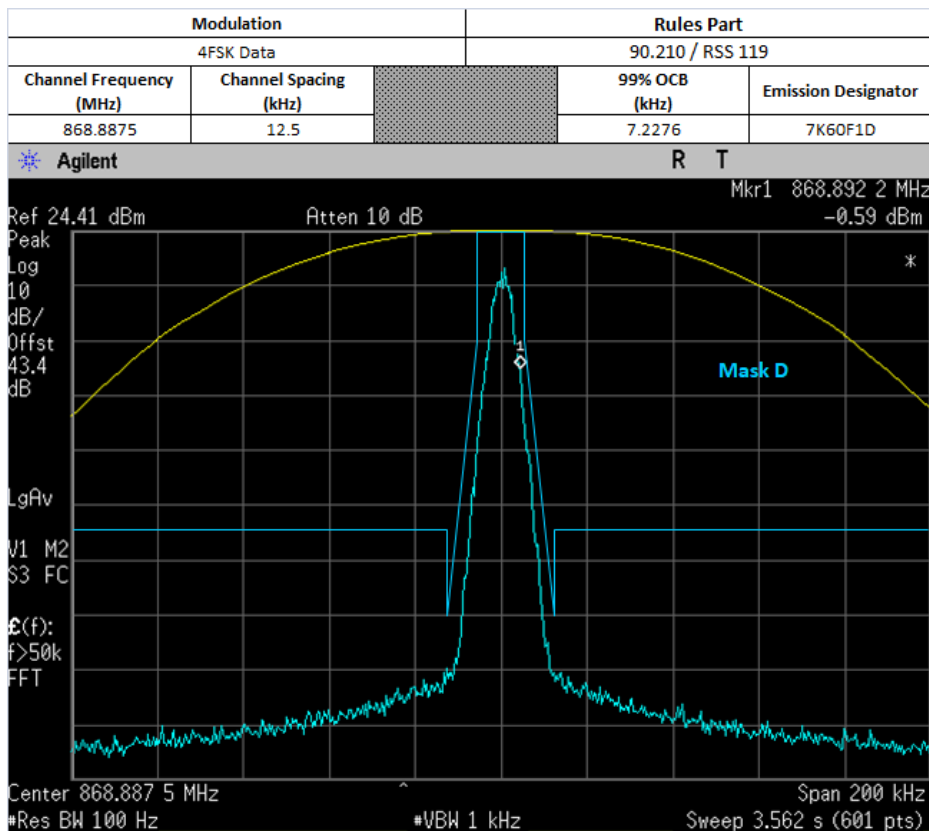
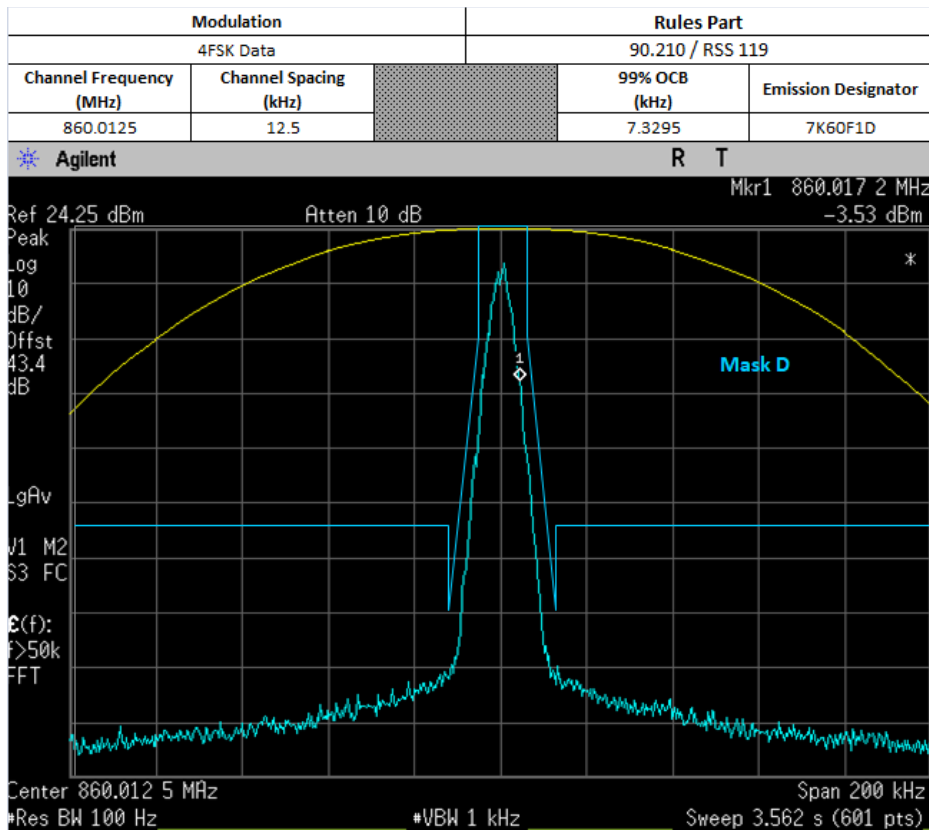

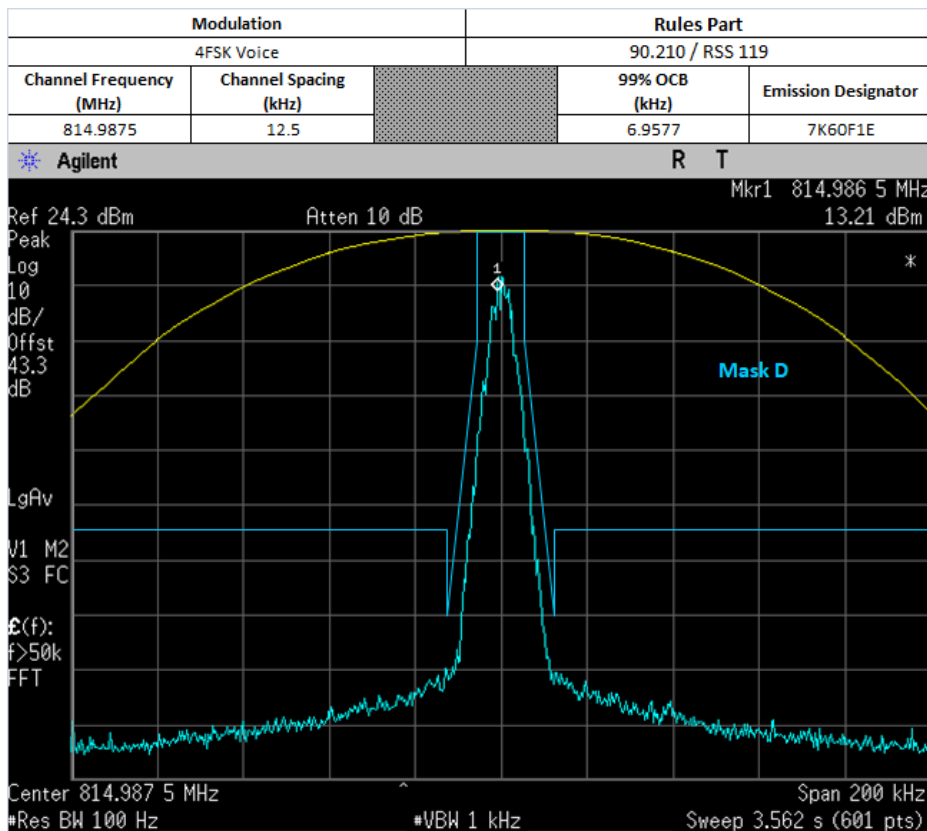
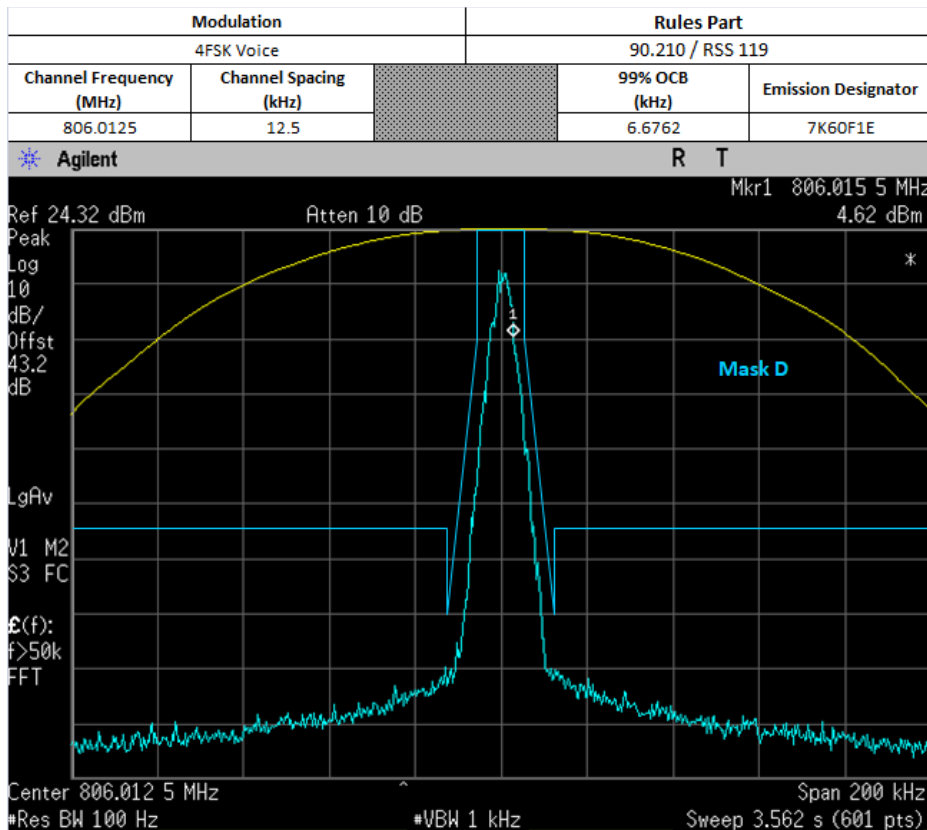

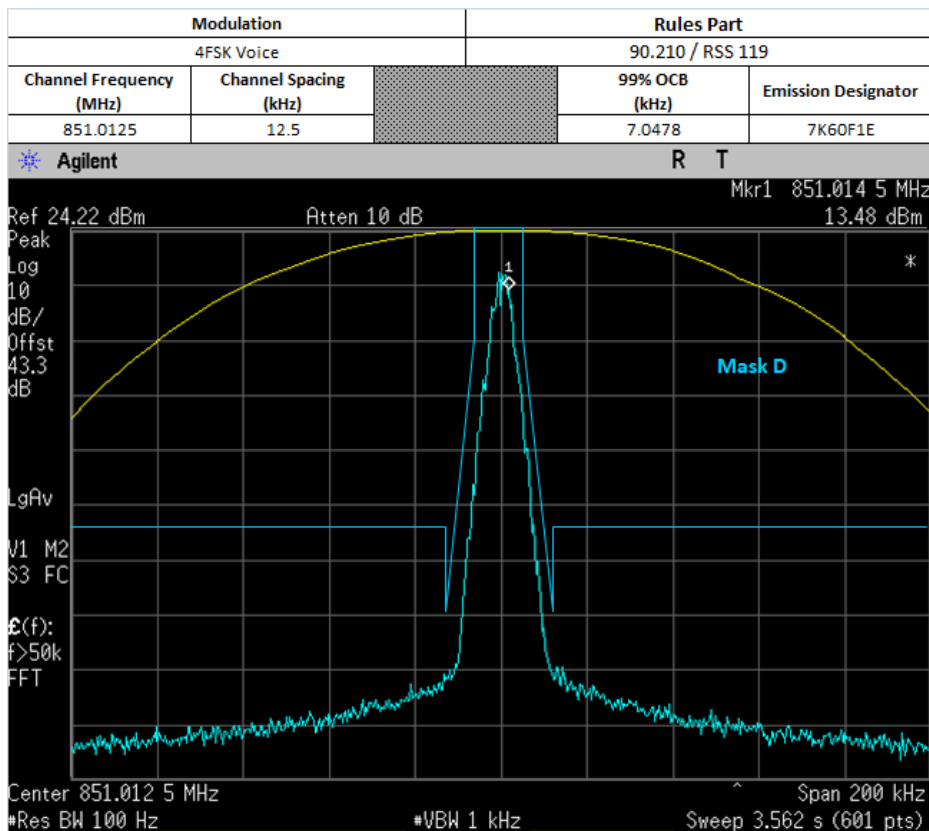
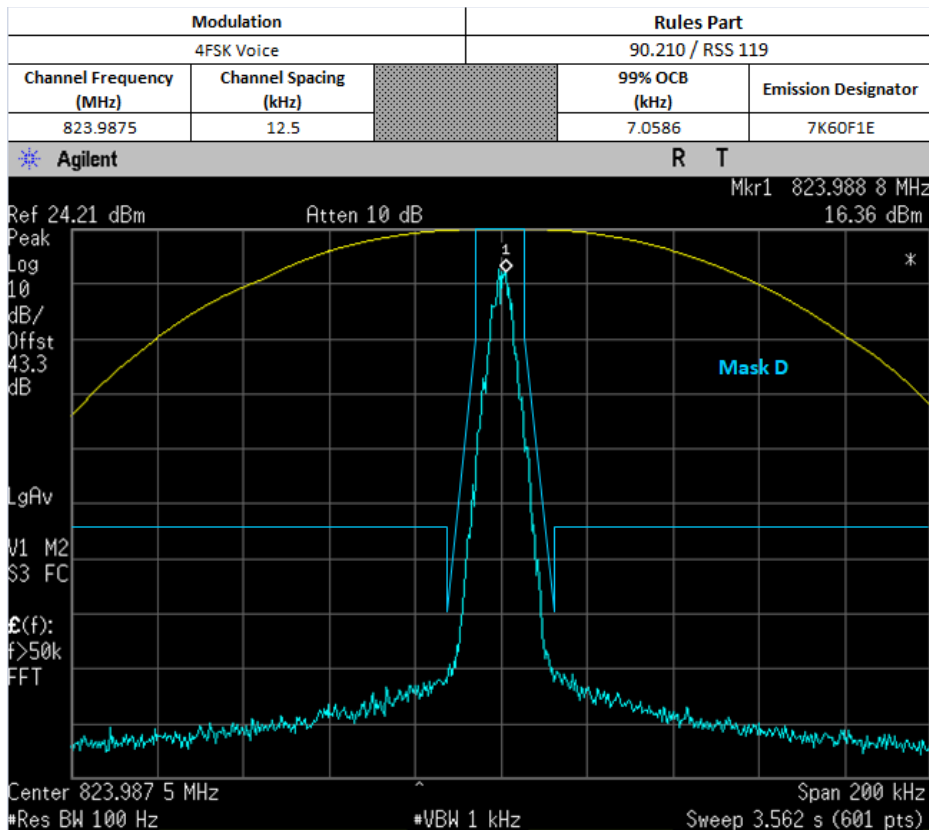

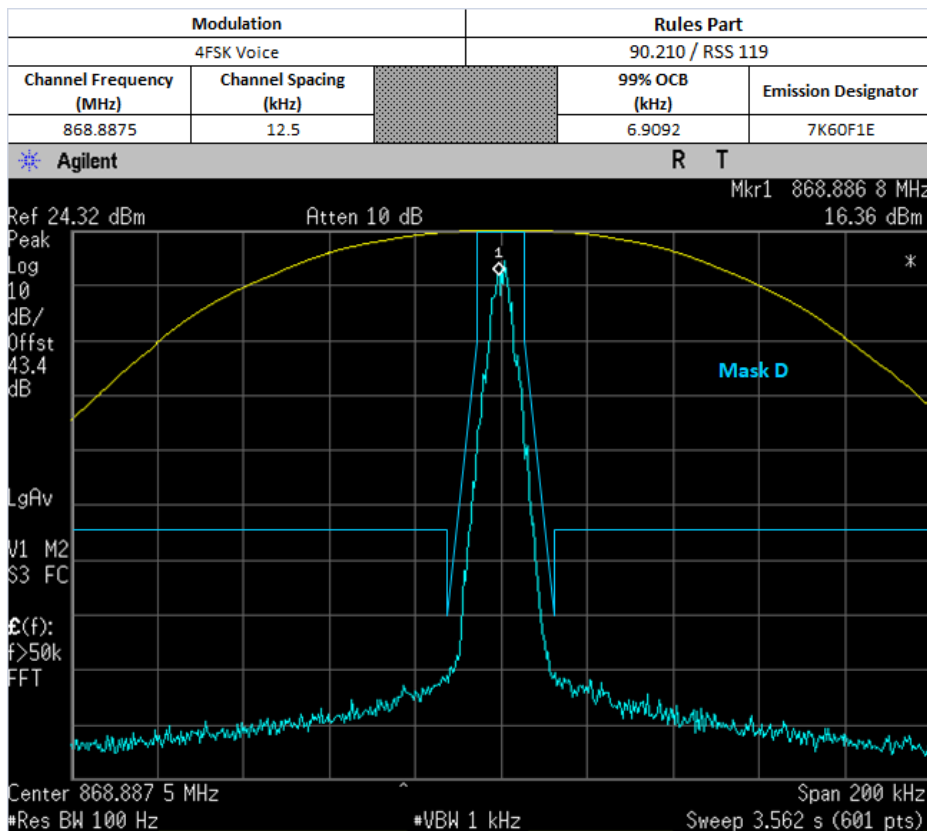
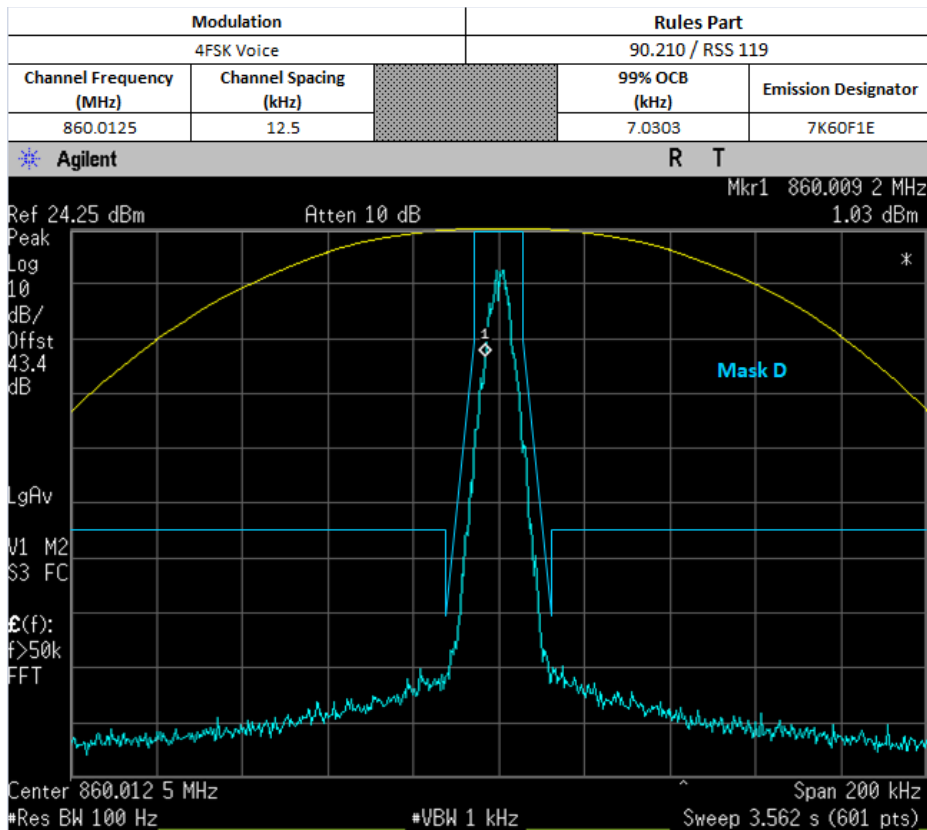

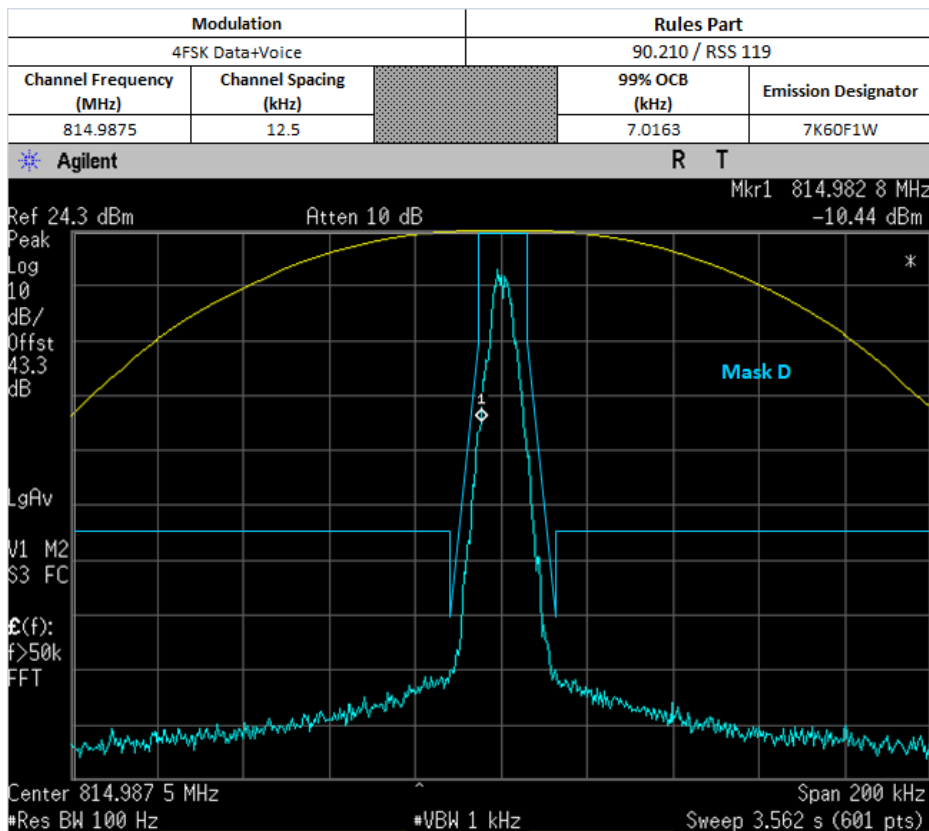
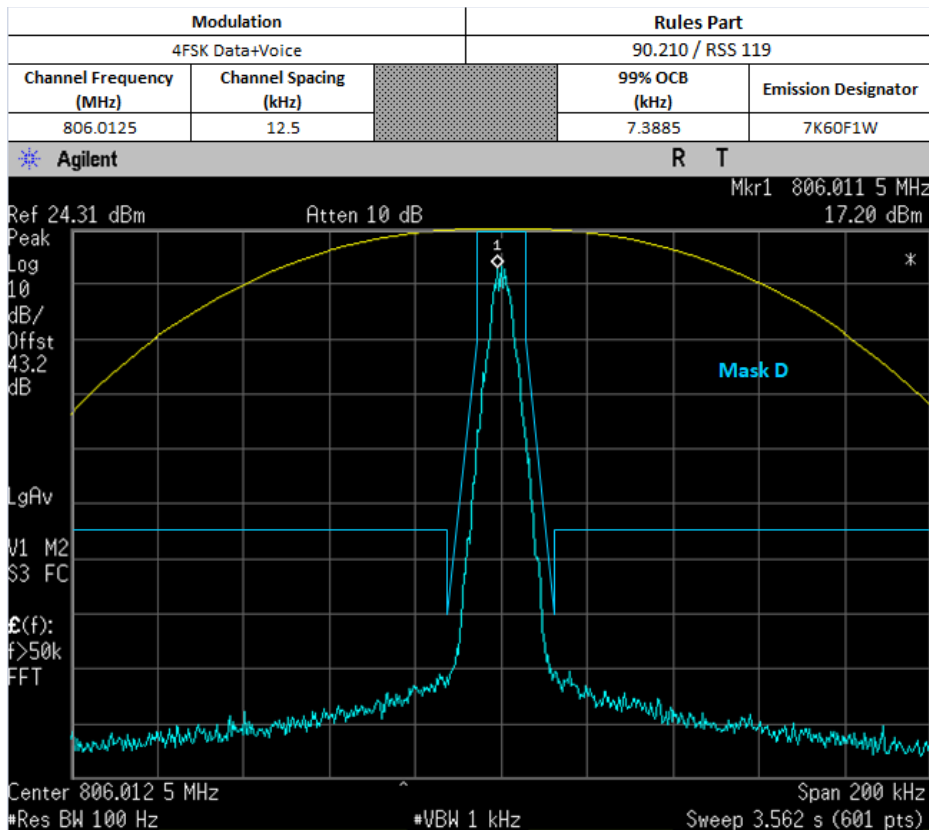

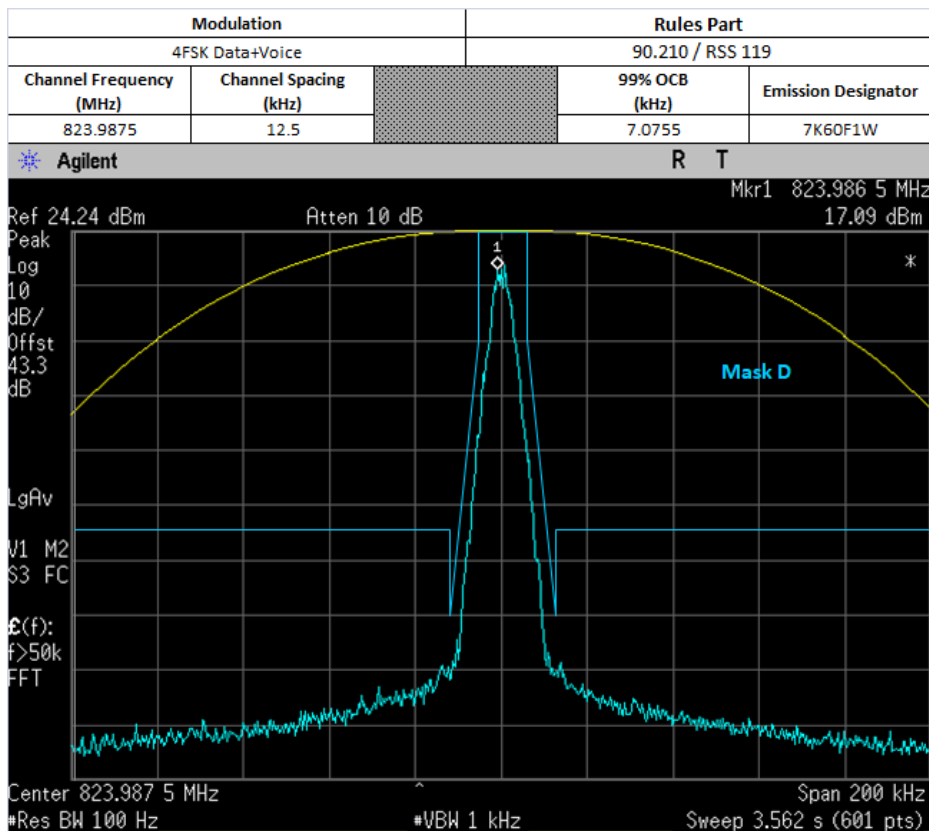
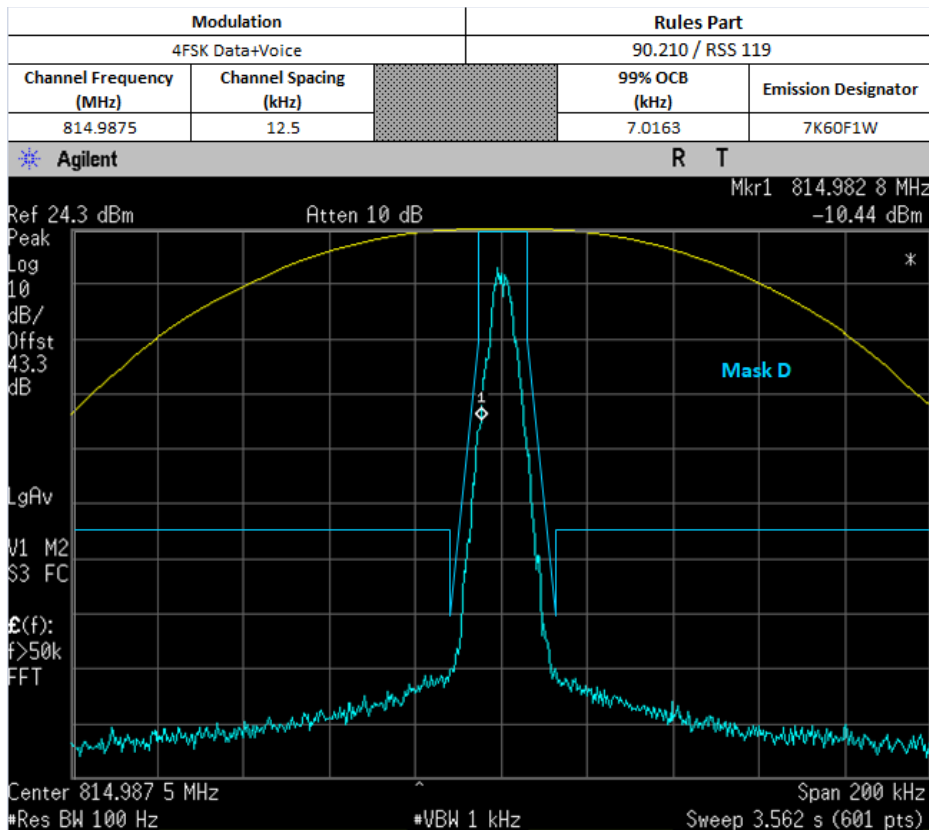

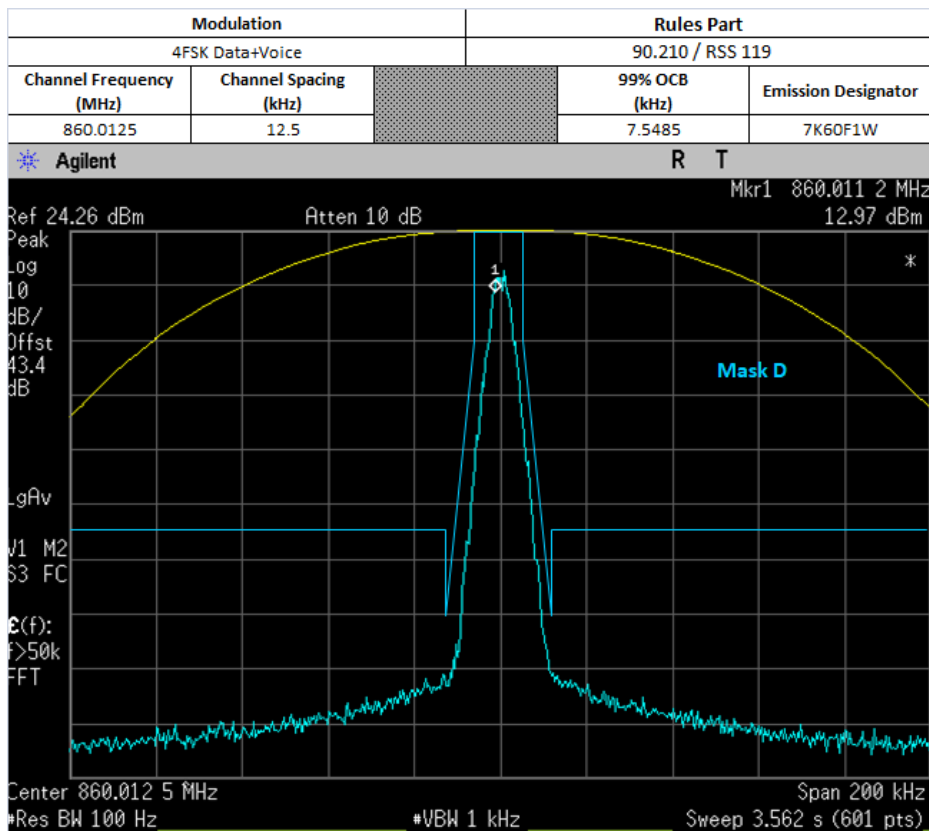
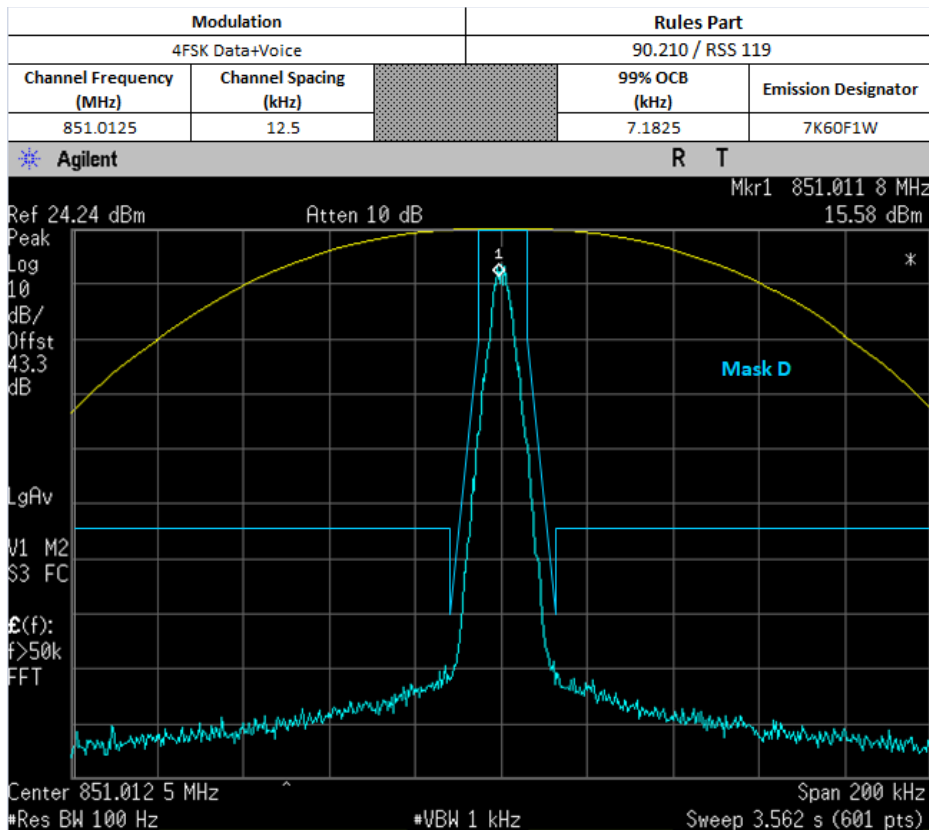

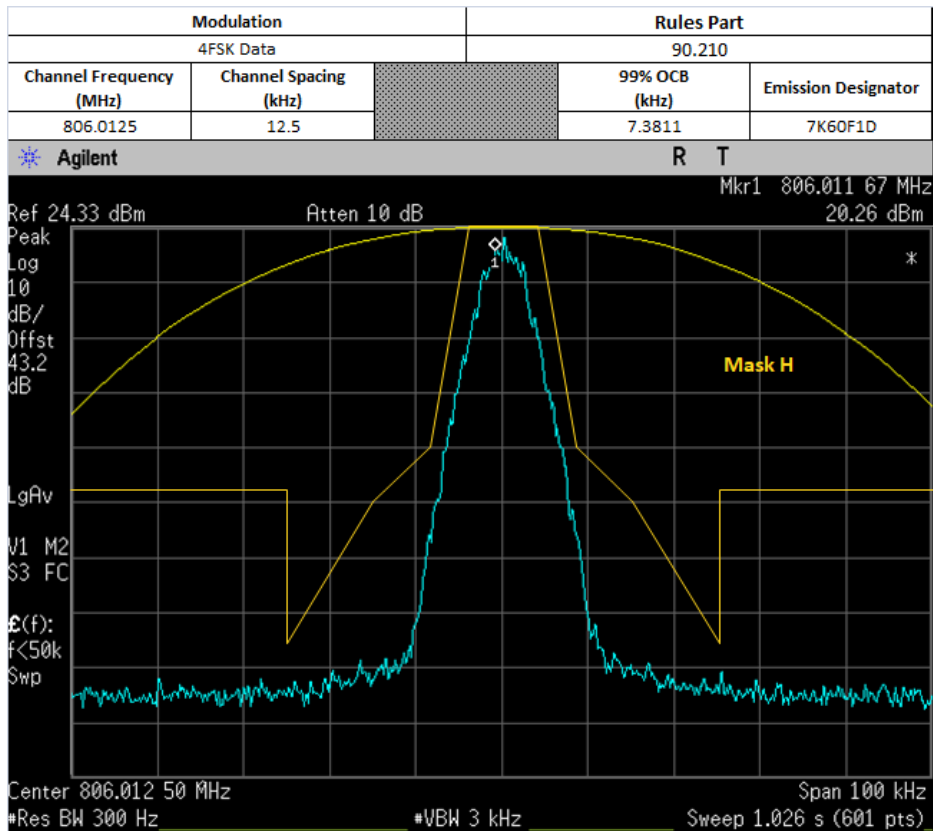
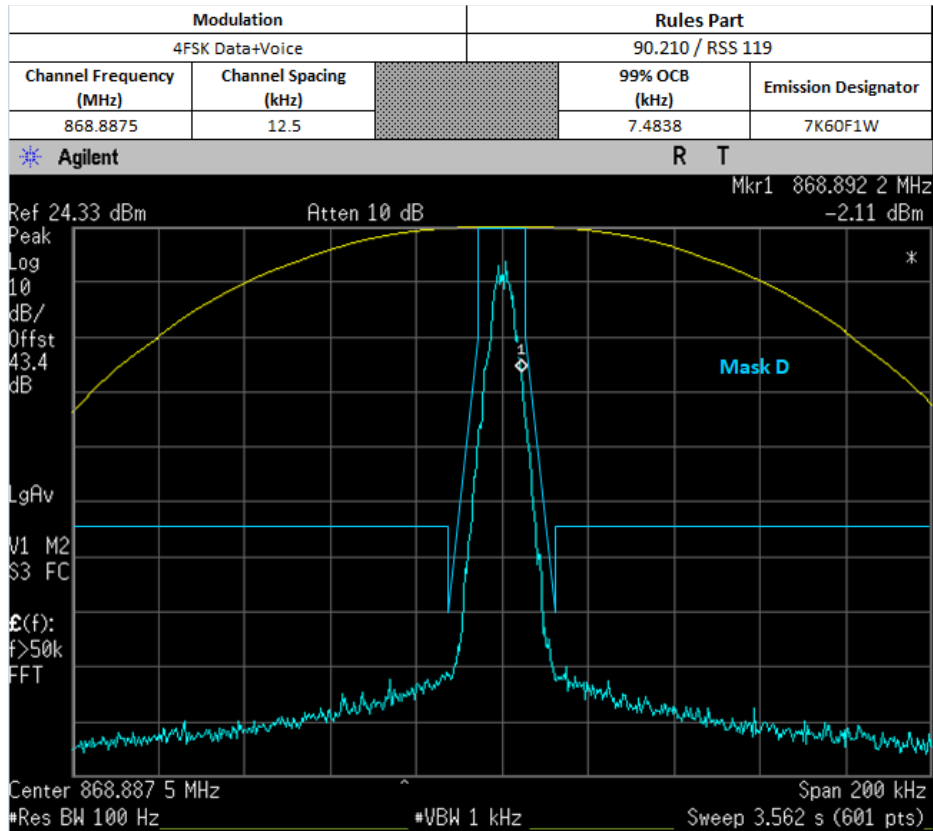

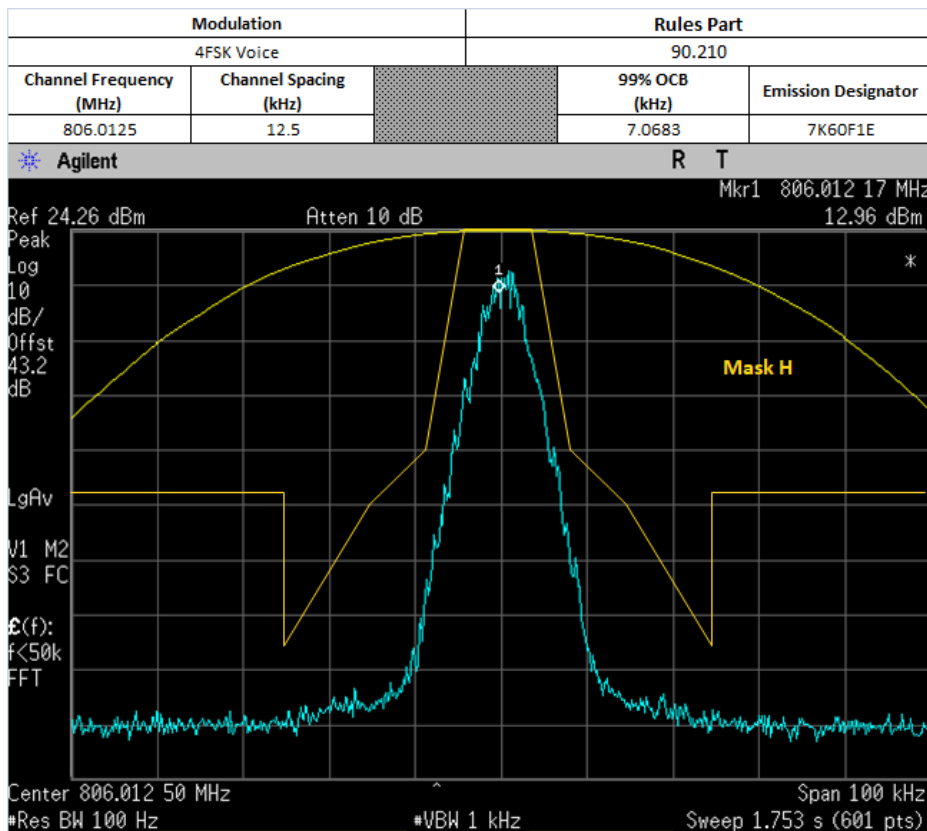
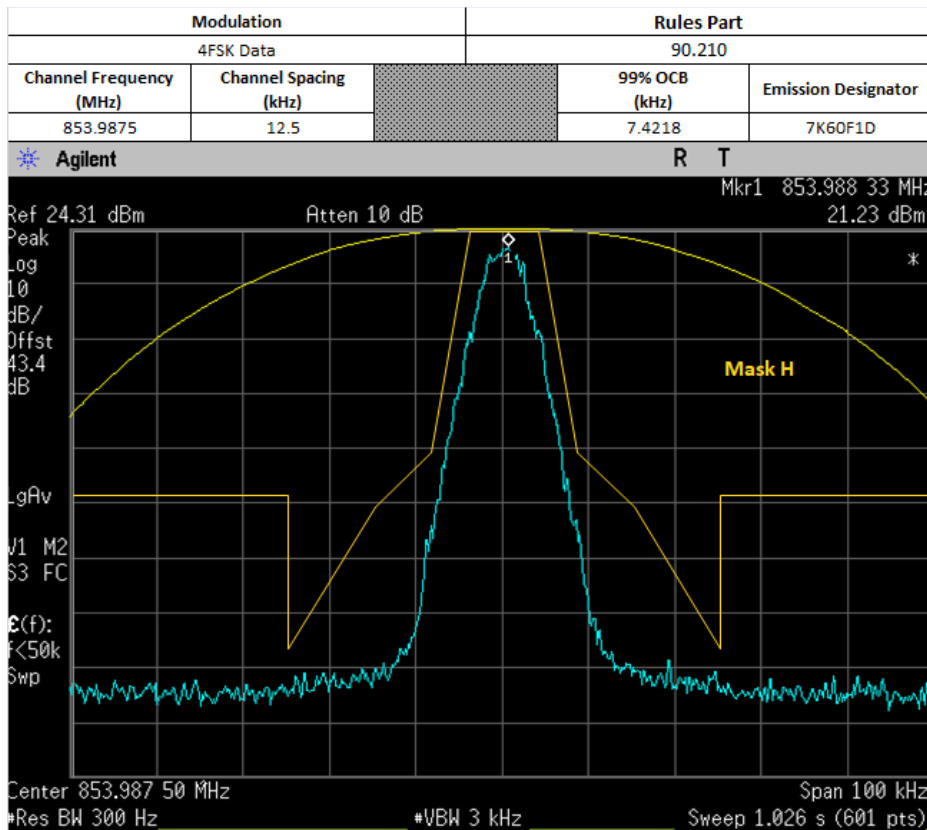

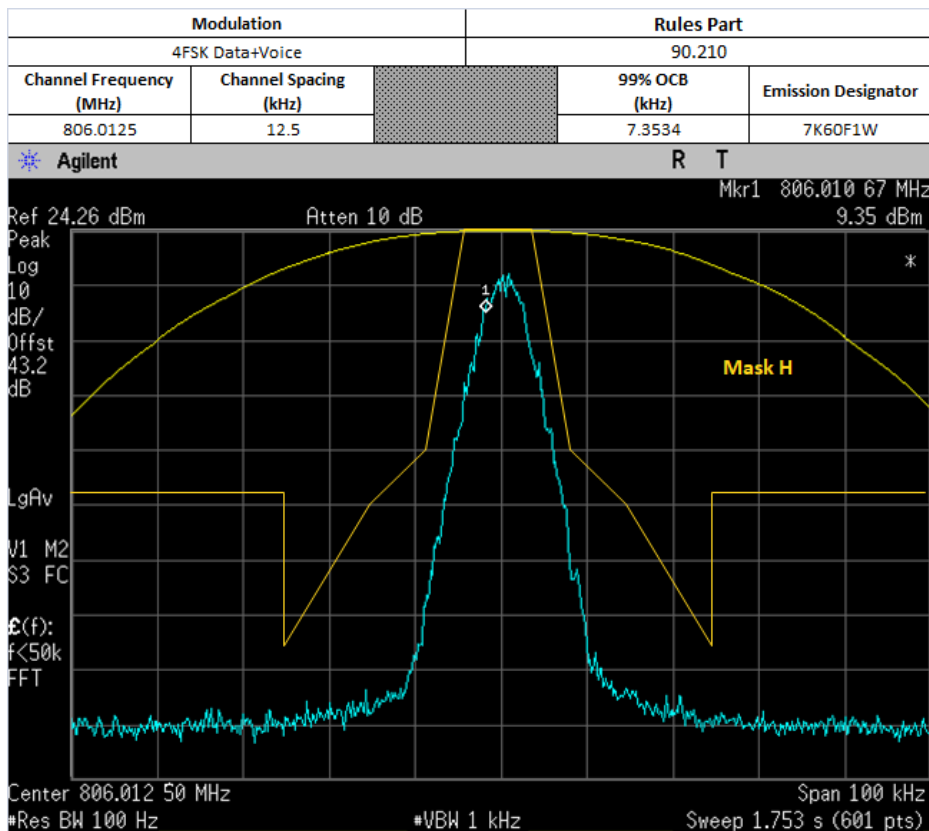
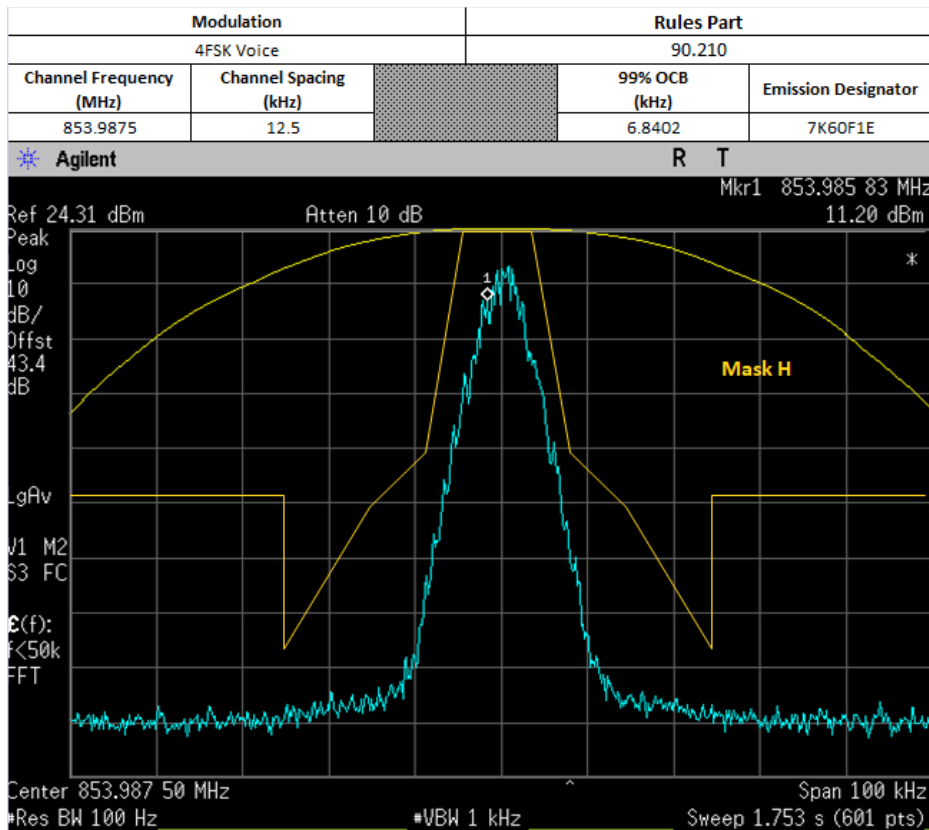

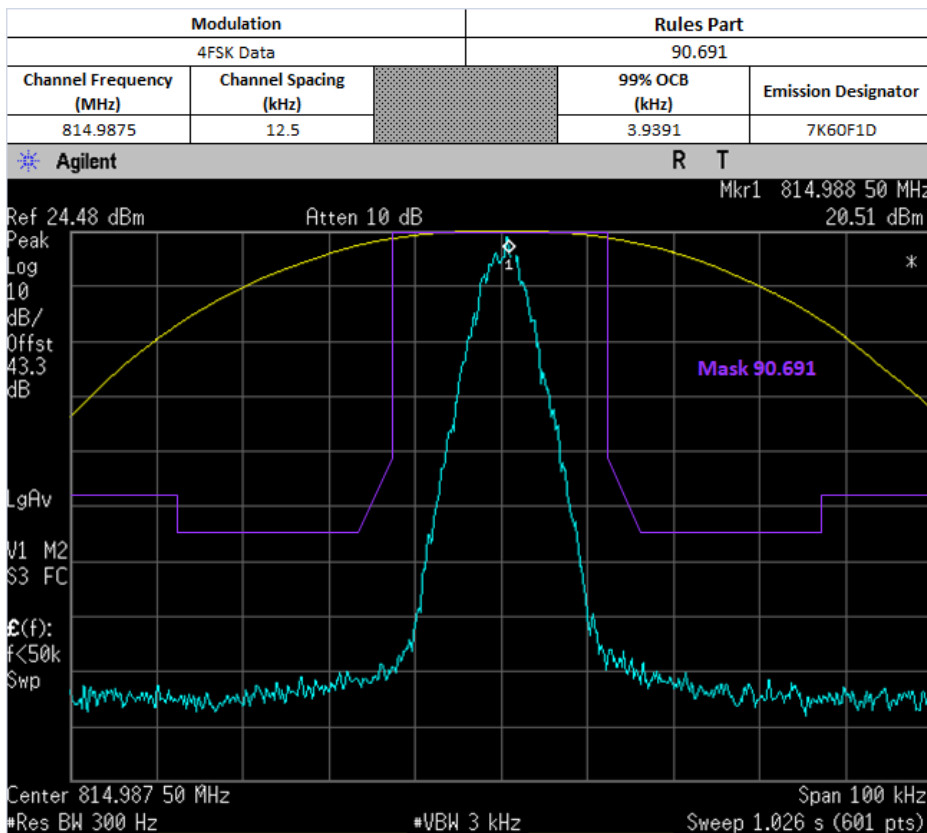
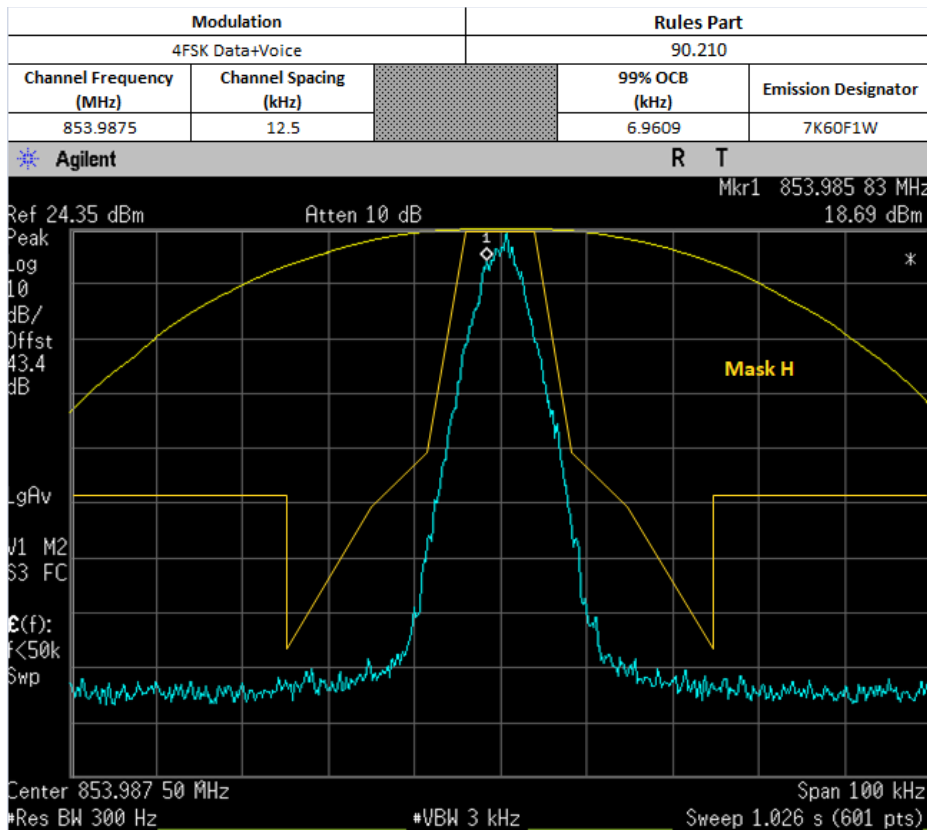

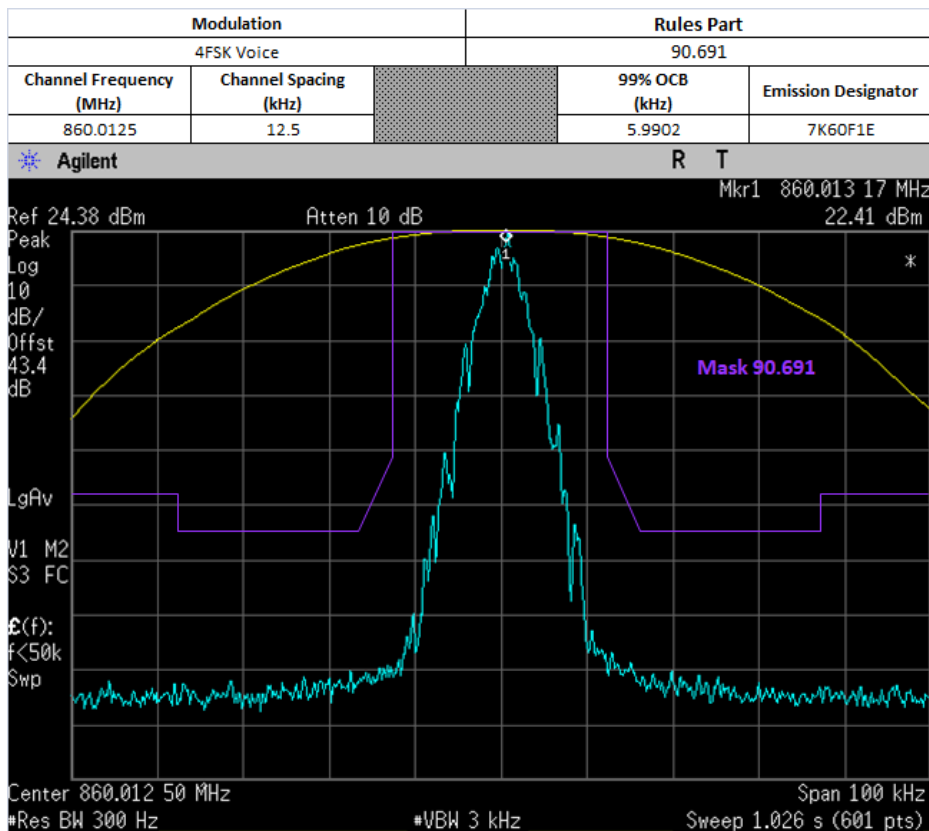
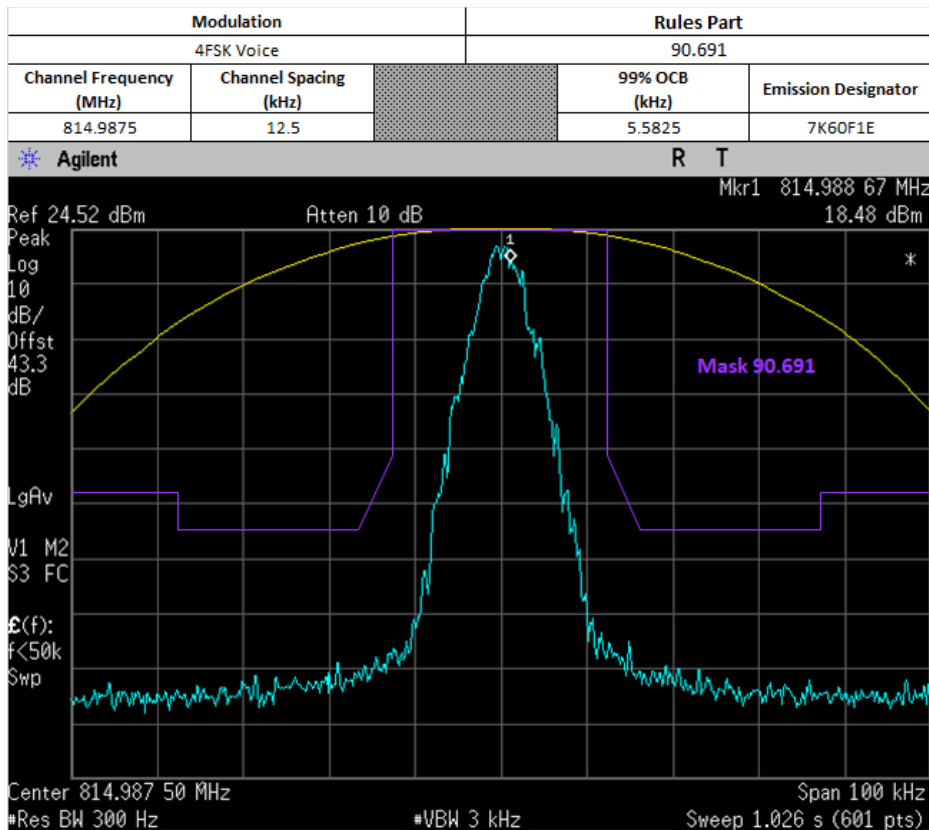

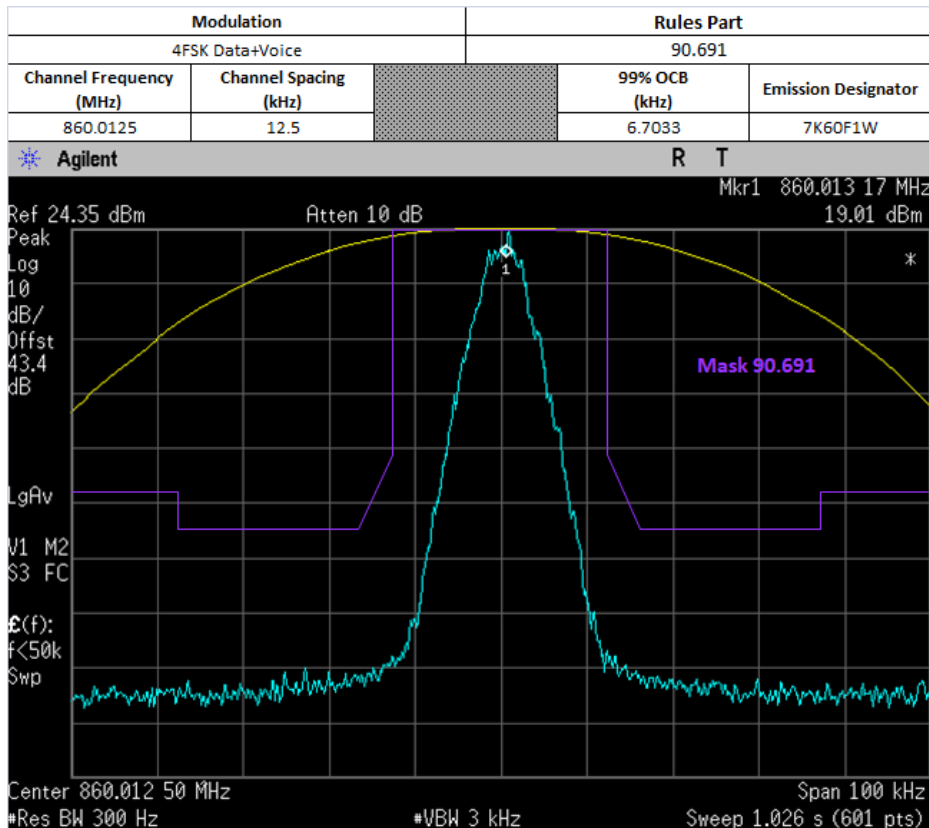
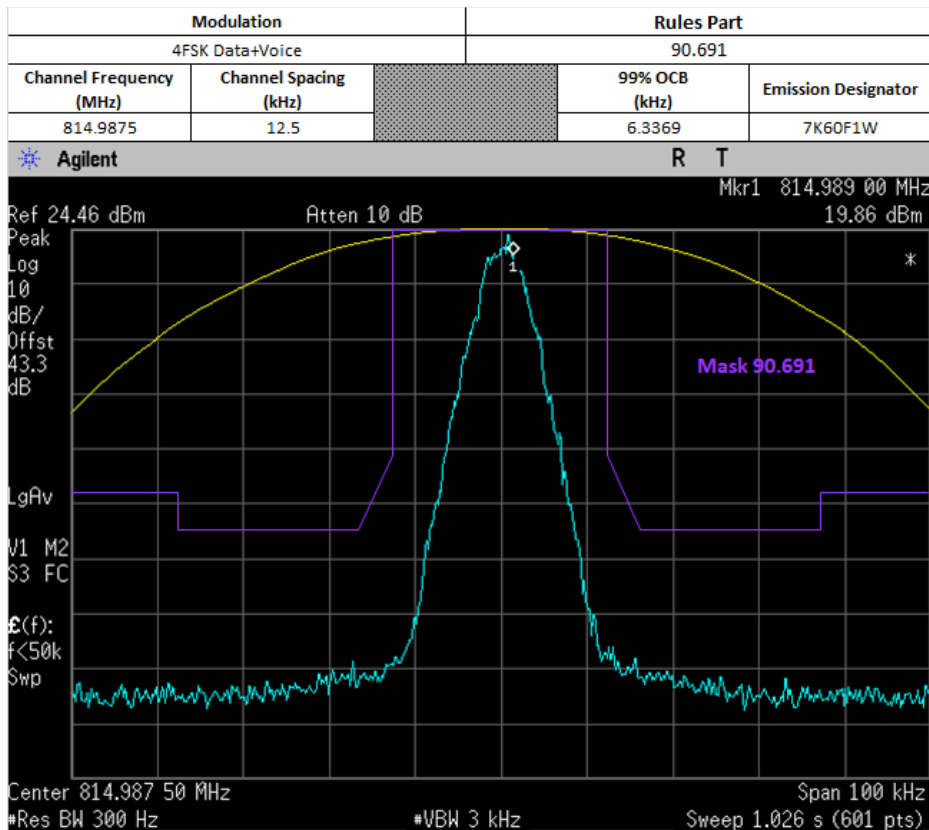

6.5.5. Test Limit

The 99% occupied bandwidth is the width of a frequency band such that, below the lower and above the upper frequency limits, the mean powers emitted are each equal to a specified percentage 0.5% of the total mean transmitted power.

6.6. Band Edge Conducted Spurious Emission (Part 22)

6.6.1. Test Setup (Analog)

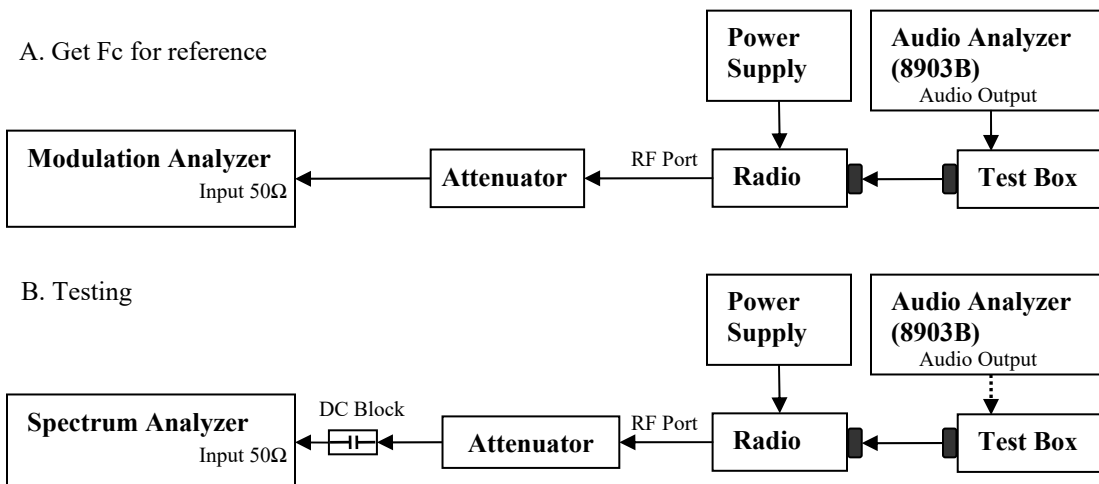

- 1) The DUT transmitter output port was connected to Modulation Analyzer.
- 2) Set the audio bandwidth filter to 15 kHz low pass filter and 50 kHz high pass filter.
- 3) Transmit the radio and set the audio analyzer to 2.5 kHz audio frequency and 50% of the rated deviation. Up the amplitude by 16 dB. Dekey the DUT.
- 4) Path loss for the measurement included.
- 5) Select the Occupied Bandwidth measurement for 99% and 26dB Emissions Bandwidth Measurement.
- 6) Key in the Fc and Resolution Bandwidth.
- 7) Transmit the DUT and record the occupied Bandwidth frequencies.
- 8) Preset the spectrum analyzer for band edge measurement.
- 9) The band edges of lowest and highest channels were measured.
- 10) Key in the Lowest and highest channel frequency, span is 60 kHz and Resolution Bandwidth is at least 1% of Emission Bandwidth.
- 11) Save the screen shot as modulated signal.
- 12) Remove the audio tone from audio analyzer to capture unmodulated signal.

*Note:

- For emission designator ending with F3E, 16K0F3E is the worst case and therefore only 16K0F3E will be shown.

6.6.2. Test Result (Analog)

Not Applicable

6.6.3. Test Setup (Digital)

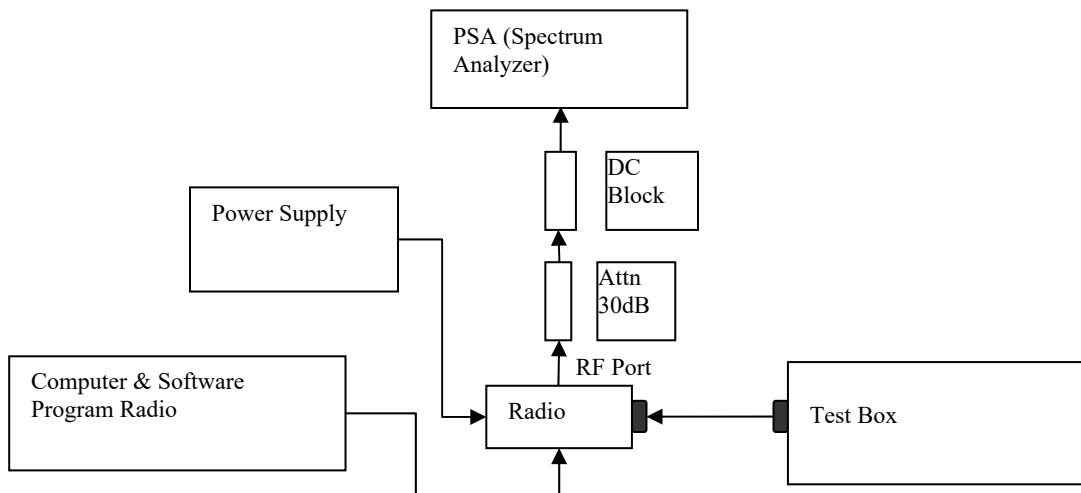

- 1) Program and set radio to operate in desire test frequency and digital mode with modulation. (*4FSK, C4FM or other digital modulation form).
- 2) Path loss for the measurement included.
- 3) Select the Occupied Bandwidth measurement for 99% and 26dB Emissions Bandwidth Measurement.
- 4) Key in the Fc and Resolution Bandwidth.
- 5) Transmit radio record the occupied Bandwidth frequencies.
- 6) Preset the spectrum analyzer for band edge measurement.
- 7) Key in the lowest and highest channels frequency, span is 60 kHz and Resolution Bandwidth is at least 1% of Emission Bandwidth.
- 8) Save the screen shot.

*Note:

- For Digital Modulation, 12.5 kHz Data F1D & FXD would be the same. Therefore only measurements with F1D modulation shown below.
- For Digital Modulation, 12.5 kHz Data F1E & FXE would be the same. Therefore only measurements with F1E modulation shown below.

6.6.4. Test Result (Digital)

Not Applicable

6.6.5. Test Limit

The power of any emission outside of the authorized operating frequency ranges must be attenuated below the transmitting power (P) by a factor of at least $43 + 10 \log(P)$ dB.

6.7. Transient Frequency Behavior

6.7.1. Test Setup

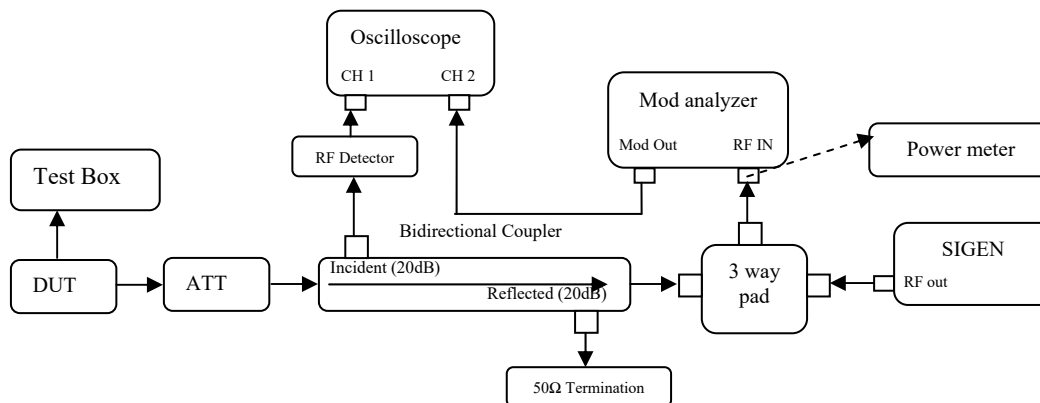

- 1) Connect the setup as figure above.
- 2) Path loss for the measurement included.
- 3) Set on Sigen with the assigned center frequency, internal 1 kHz FM tone.
FM Deviation: Analog 25kHz Channel Spacing = 25 kHz
Analog 12.5 kHz Channel Spacing = 12.5 kHz
C4FM = 12.5 kHz
- 4) Turn on 50 kHz high pass filter and 15 kHz low pass filter on modulation analyzer.
- 5) Supply sufficient attenuation ATT to provide the output power of ≤ -11 dBm into power meter when DUT is keying up.
- 6) Note the power level on power meter and dekey the DUT.
- 7) Adjust the amplitude of the signal generator to the level power meter, maintained the amplitude throughout the rest of the measurement.
- 8) Connect the output to modulation analyzer.
- 9) Reduce 30dB attenuation and transmit the radio to get the trigger line.
- 10) Capture the screen shot for key-up (rising edge) and de-key (falling edge) mode.

6.7.2. Test Result

Not Applicable

6.7.3. Test Limit

Transmitters designed to operate in the 150-174 MHz and 421-512 MHz frequency bands must maintain transient frequencies within the maximum frequency difference limits during the time intervals indicated:

Time intervals ^{1 2}	Maximum frequency difference ³	All equipment	
		150 to 174 MHz	421 to 512 MHz
Transient Frequency Behavior for Equipment Designed to Operate on 25 kHz Channels			
t ₁ ⁴	±25.0 kHz	5.0 ms	10.0 ms
t ₂	±12.5 kHz	20.0 ms	25.0 ms
t ₃ ⁴	±25.0 kHz	5.0 ms	10.0 ms
Transient Frequency Behavior for Equipment Designed to Operate on 12.5 kHz Channels			
t ₁ ⁴	±12.5 kHz	5.0 ms	10.0 ms
t ₂	±6.25 kHz	20.0 ms	25.0 ms
t ₃ ⁴	±12.5 kHz	5.0 ms	10.0 ms
Transient Frequency Behavior for Equipment Designed to Operate on 6.25 kHz Channels			
t ₁ ⁴	±6.25 kHz	5.0 ms	10.0 ms
t ₂	±3.125 kHz	20.0 ms	25.0 ms
t ₃ ⁴	±6.25 kHz	5.0 ms	10.0 ms

¹ t_{on} is the instant when a 1 kHz test signal is completely suppressed, including any capture time due to phasing.

t₁ is the time period immediately following t_{on}.

t₂ is the time period immediately following t₁.

t₃ is the time period from the instant when the transmitter is turned off until t_{off}.

t_{off} is the instant when the 1 kHz test signal starts to rise.

² During the time from the end of t₂ to the beginning of t₃, the frequency difference must not exceed the limits specified in §90.213.

³ Difference between the actual transmitter frequency and the assigned transmitter frequency.

⁴ If the transmitter carrier output power rating is 6 watts or less, the frequency difference during this time period may exceed the maximum frequency difference for this time period.

6.8. Adjacent Channel Power

6.8.1. Test Setup (Analog)

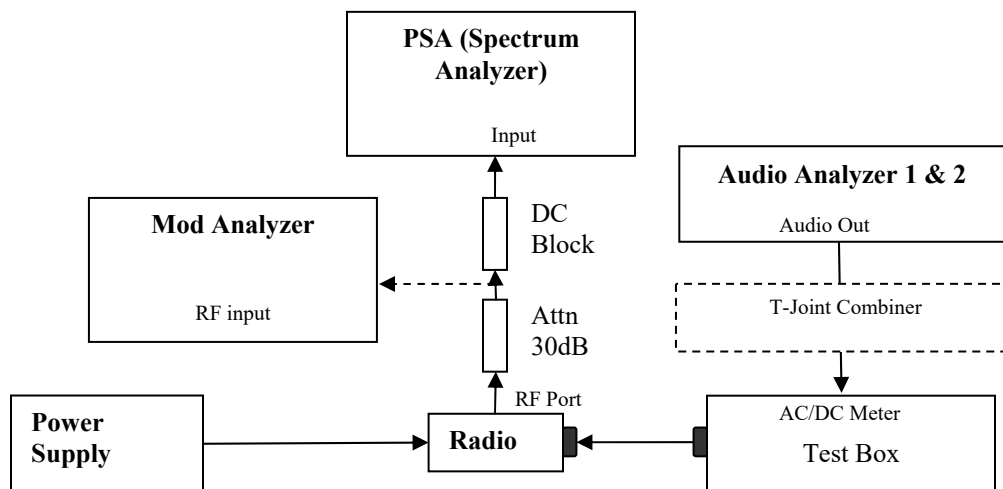

- 1) The DUT transmitter output port was connected to modulation analyzer.
- 2) Transmit the radio and turn on 1st audio analyzer with audio frequency 650Hz, 50% rated deviation, and record the amplitude value as AmpT1.
- 3) Turn off Audio analyzer 1 and turn on audio analyzer 2, set the audio frequency to 2.2 kHz and 50% deviation. Record the amplitude as AmpT2.
- 4) Turn both audio analyzers ON and up 10dB amplitude level.
- 5) Connect the output to PSA and set to assigned center frequency.
- 6) Set Span, Resolution Bandwidth and Video Bandwidth per rules part.
- 7) Transmit the radio and record the Adjacent Channel Power value in dBc.

6.8.2. Test Result

Not Applicable

6.8.3. Test Setup (Digital)

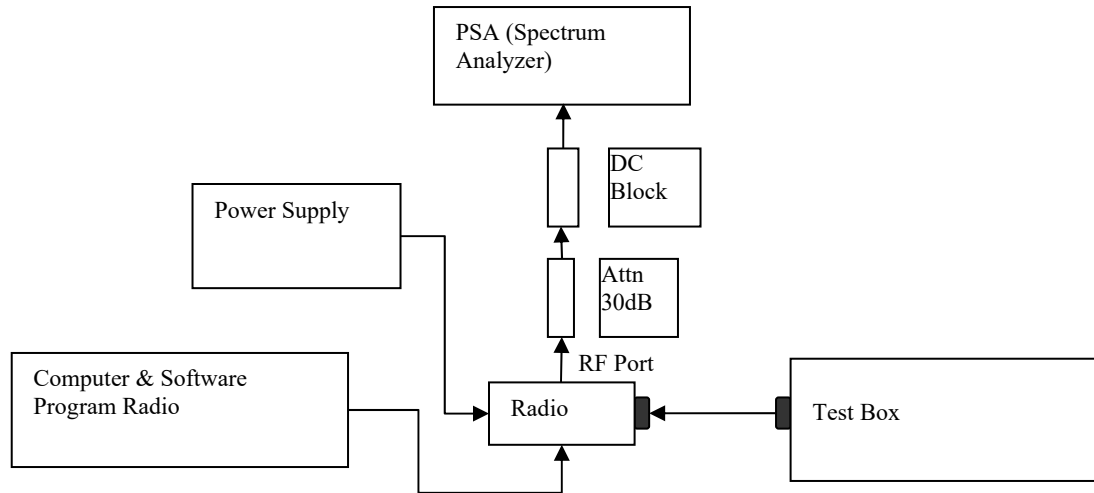

- 1) Program and set radio to operate in desire test frequency and digital mode with modulation. (4FSK, C4FM or other digital modulation form).
- 2) Prepare setup as per picture.
- 3) Turn on the ACP Measurement – Press Measure, ACP.
- 4) Set Span, Resolution Bandwidth and Video Bandwidth as per rules part.
- 5) Transmit the radio and record the Adjacent Channel Power value in dBc.

6.8.4. Test Result

Not Applicable

6.8.5. Test Limit

12.5 kHz MOBILE TRANSMITTER ACP REQUIREMENTS

Offset from center frequency (kHz)	Measurement bandwidth (kHz)	Maximum ACP relative (dBc)
9.375	6.25	-40
15.625	6.25	-60
21.875	6.25	-60
37.50	25.00	-60
62.50	25.00	-65
87.50	25.00	-65
150.00	100	-65
250.00	100	-65
350.00	100	-65
>400 to 12 MHz	30 (s)	-75
12 MHz to paired receive band	30 (s)	-75
In the paired receive band	30 (s)	-100

25 kHz MOBILE TRANSMITTER ACP REQUIREMENTS

Offset from center frequency (kHz)	Measurement bandwidth (kHz)	Maximum ACP relative (dBc)
15.625	6.25	-40
21.875	6.25	-60
37.50	25	-60
62.50	25	-65
87.50	25	-65
150.00	100	-65
250.00	100	-65
350.00	100	-65
>400 kHz to 12 MHz	30 (s)	-75
12 MHz to paired receive band	30 (s)	-75
In the paired receive band	30 (s)	-100

12.5 kHz BASE TRANSMITTER ACP REQUIREMENTS

Offset from center frequency (kHz)	Measurement bandwidth (kHz)	Maximum ACP (dBc)
9.375	6.25	-40
15.625	6.25	-60
21.875	6.25	-60
37.5	25	-60
62.5	25	-65
87.5	25	-65
150	100	-65
250	100	-65
350.00	100	-65
>400 kHz to 12 MHz	30 (s)	-80
12 MHz to paired receive band	30 (s)	-80
In the paired receive band	30 (s)	¹ -85

25 kHz BASE TRANSMITTER ACP REQUIREMENTS

Offset from center frequency (kHz)	Measurement bandwidth (kHz)	Maximum ACP (dBc)
15.625	6.25	-40
21.875	6.25	-60
37.5	25	-60
62.5	25	-65
87.5	25	-65
150	100	-65
250	100	-65
350	100.00	-65
>400 kHz to 12 MHz	30 (s)	-80
12 MHz to paired receive band	30 (s)	-80
In the paired receive band	30 (s)	¹ -85

6.9. Conducted Spurious Emission

6.9.1. Test Setup

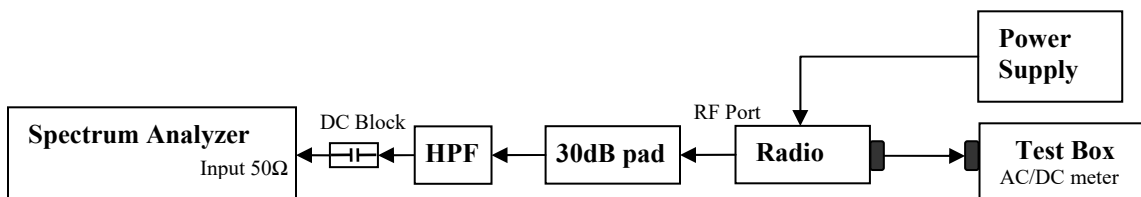

- 1) The DUT transmitter output port was connected to Spectrum Analyzer with above setup.
- 2) Program and set radio to operate in desire test frequency and mode. (Analog / digital modulation form).
- 3) Path loss for the measurement included.
- 4) Set the PSA Resolution Bandwidth as per rules part.
- 5) Set the Ref offset from the pathloss offset calibration file.
- 6) Adjust the center frequency of the spectrum analyzer for incremental coverage of the range from:
 - a. 9 KHz to $F_c - \text{Test Bandwidth}$
 - b. $F_c + \text{Test Bandwidth}$ to $2F_c - 5\text{MHz}$.
- 7) Key up the DUT, Peak Search the highest Spur and record the levels of spurious emissions
- 8) Dekey the DUT.
- 9) Turn On High Pass Filter path and Key up the DUT.
- 10) Adjust the PSA Freq for incremental coverage of range from $2F_c$ to $10F_c$
- 11) Key up the DUT and record the highest spur levels of spurious emissions.

6.9.2. Test Result (Analog)

Analog: 806.0125. MHz, 25.kHz Channel Spacing, Max. Power

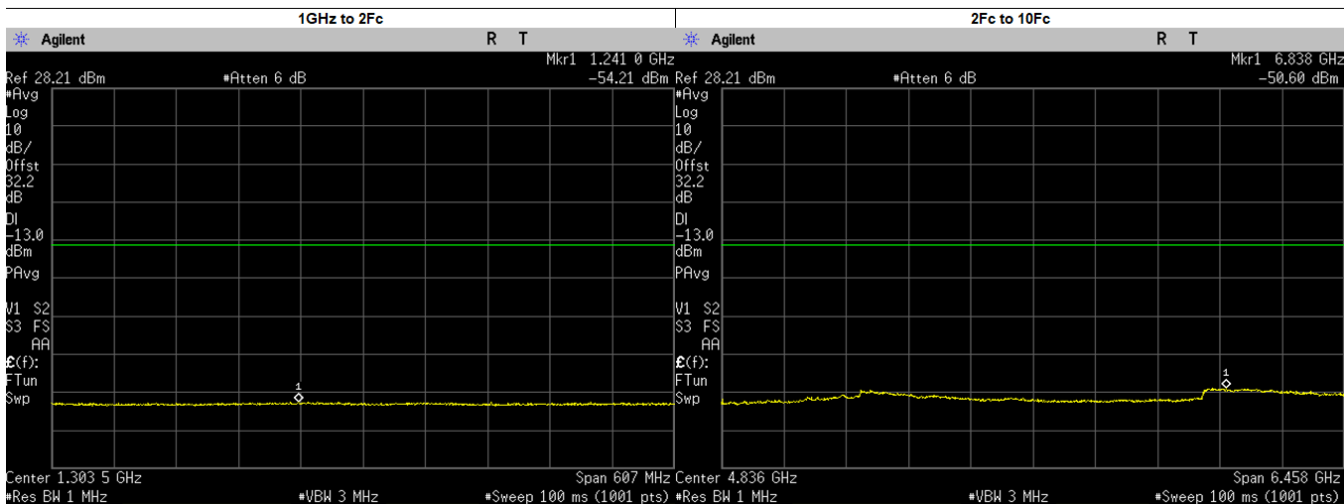
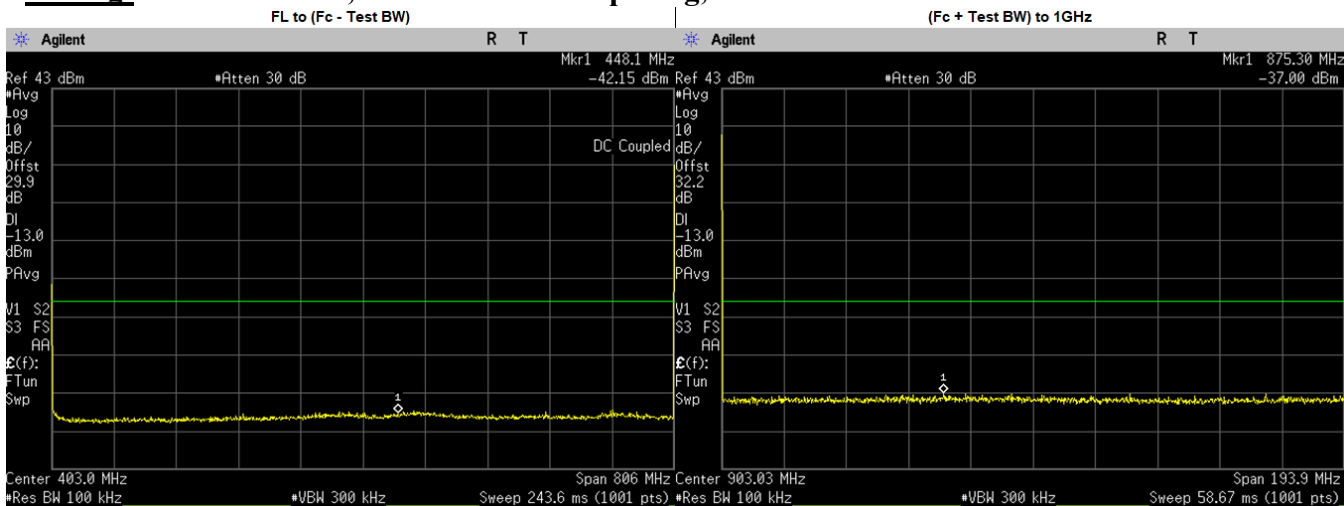

Frequency Range	Highest Spur Frequency (MHz)	Spurious Level (dBm)	Failing Limit (dBm)	Results
FL to (Fc - Test BW)	448.1000	-42.1540	-13.00	PASS
(Fc + Test BW) to 1GHz	875.2982	-37.0000	-13.00	PASS
1GHz to 2Fc	1240.9890	-54.2100	-13.00	PASS
2Fc to 10Fc	6838.0860	-50.6000	-13.00	PASS
	1612.0250	-53.7184	-13.00	PASS
	2418.0370	-53.8408	-13.00	PASS
	3224.0500	-51.8576	-13.00	PASS
	4030.0620	-53.1232	-13.00	PASS
	4836.0750	-53.8620	-13.00	PASS
	5642.0870	-54.0020	-13.00	PASS
	6448.1000	-53.8015	-13.00	PASS
	7254.1130	-51.4035	-13.00	PASS
8060.1250	-52.2989	-13.00	PASS	

Analog: 814.9875. MHz, 25.kHz Channel Spacing, Max. Power

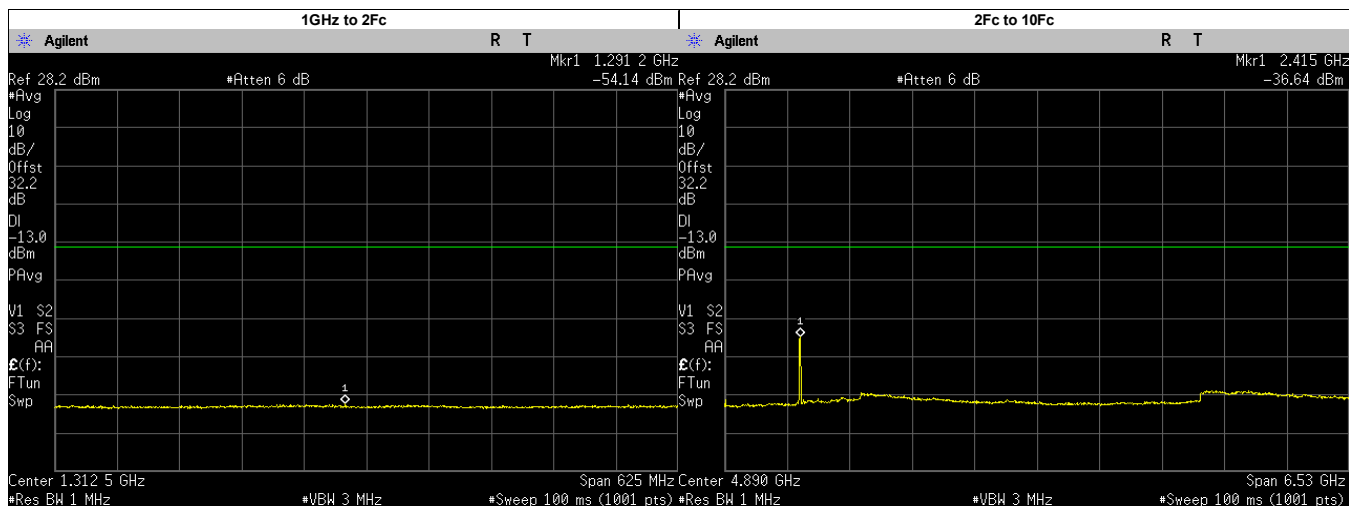
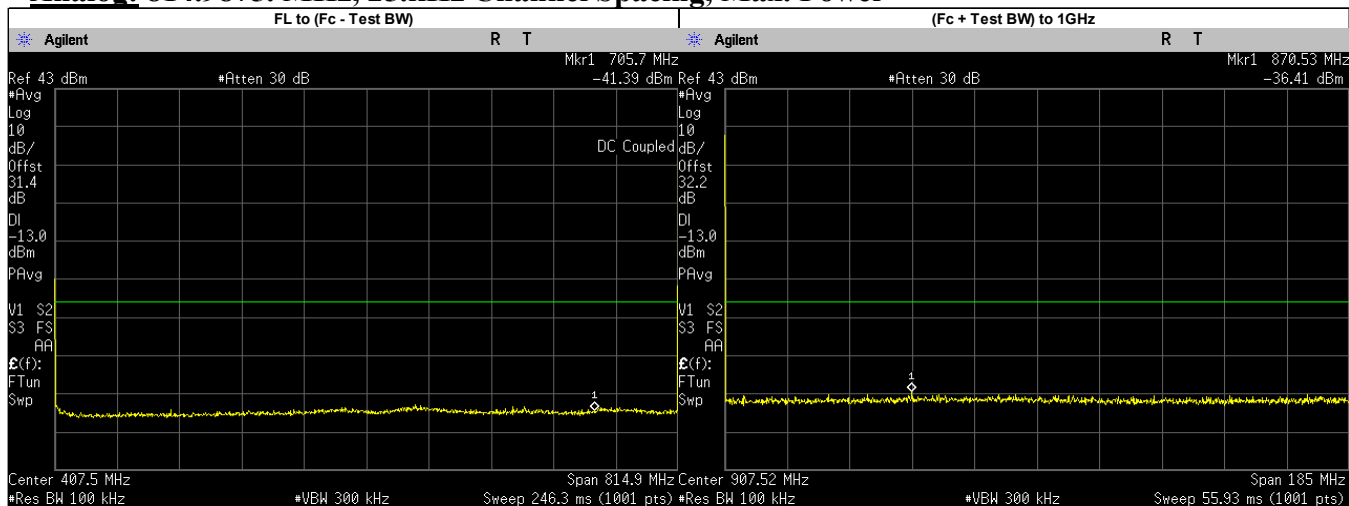

Frequency Range	Highest Spur Frequency (MHz)	Spurious Level (dBm)	Failing Limit (dBm)	Results
FL to (Fc - Test BW)	705.7000	-41.3940	-13.00	PASS
(Fc + Test BW) to 1GHz	870.5263	-36.4100	-13.00	PASS
1GHz to 2Fc	1291.2380	-54.1400	-13.00	PASS
2Fc to 10Fc	2415.0930	-36.6400	-13.00	PASS
	1629.9750	-53.5215	-13.00	PASS
	2444.9630	-53.4672	-13.00	PASS
	3259.9500	-51.9614	-13.00	PASS
	4074.9370	-53.5461	-13.00	PASS
	4889.9250	-53.9480	-13.00	PASS
	5704.9130	-54.0384	-13.00	PASS
	6519.9000	-53.5821	-13.00	PASS
	7334.8870	-51.6736	-13.00	PASS
8149.8750	-52.4744	-13.00	PASS	

Analog: 823.9875. MHz, 25.kHz Channel Spacing, Max. Power

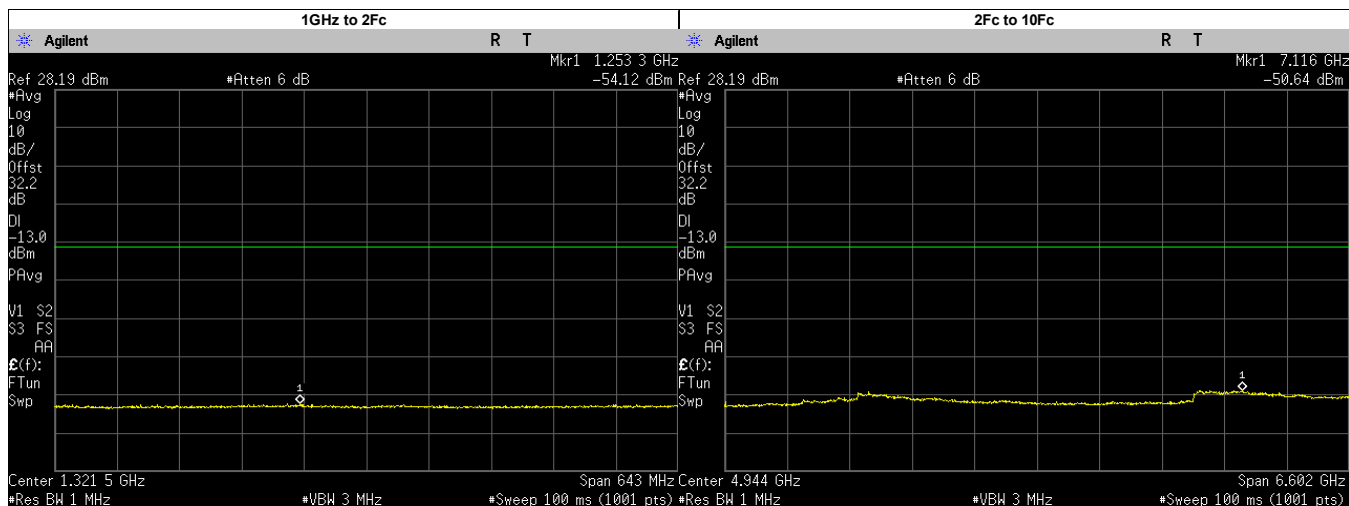
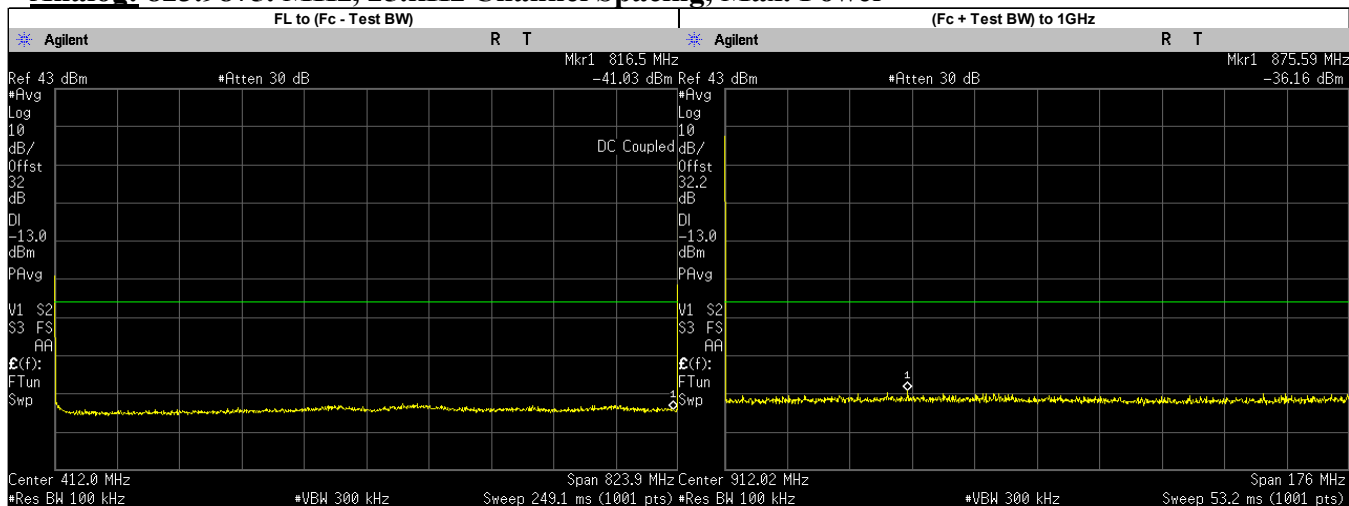

Frequency Range	Highest Spur Frequency (MHz)	Spurious Level (dBm)	Failing Limit (dBm)	Results
FL to (Fc - Test BW)	816.5000	-41.0250	-13.00	PASS
(Fc + Test BW) to 1GHz	875.5945	-36.1600	-13.00	PASS
1GHz to 2Fc	1253.3320	-54.1200	-13.00	PASS
2Fc to 10Fc	7115.9500	-50.6400	-13.00	PASS
	1647.9750	-53.9137	-13.00	PASS
	2471.9630	-53.3839	-13.00	PASS
	3295.9500	-51.7611	-13.00	PASS
	4119.9370	-53.4482	-13.00	PASS
	4943.9250	-54.3680	-13.00	PASS
	5767.9130	-53.8462	-13.00	PASS
	6591.9000	-53.4107	-13.00	PASS
	7415.8870	-51.8925	-13.00	PASS
	8239.8750	-52.2968	-13.00	PASS

Analog: 851.0125. MHz, 25.kHz Channel Spacing, Max. Power

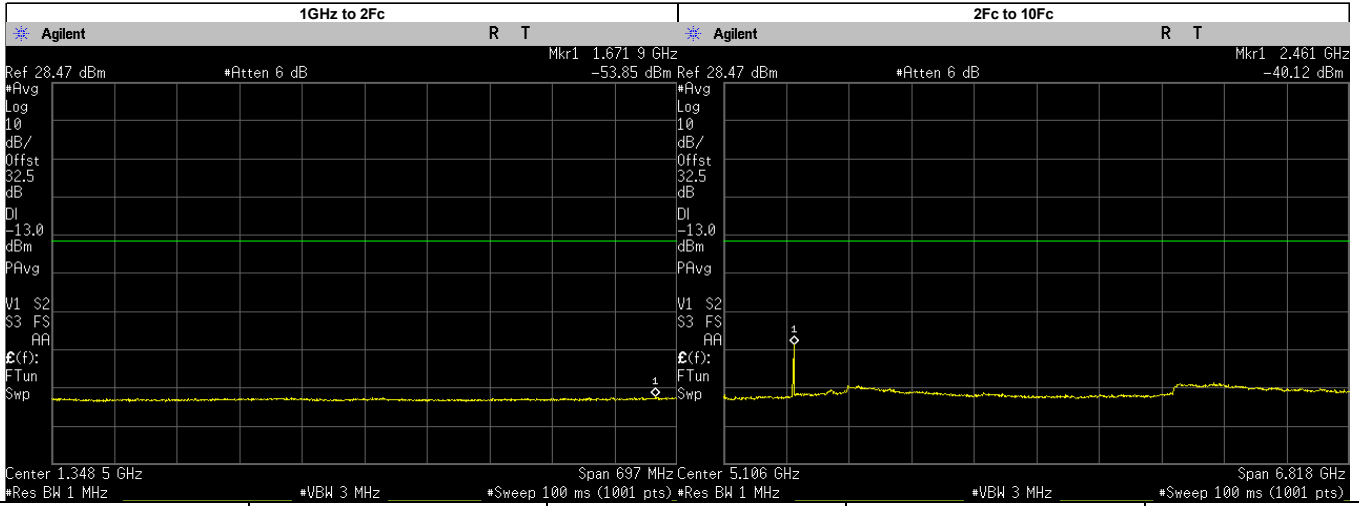
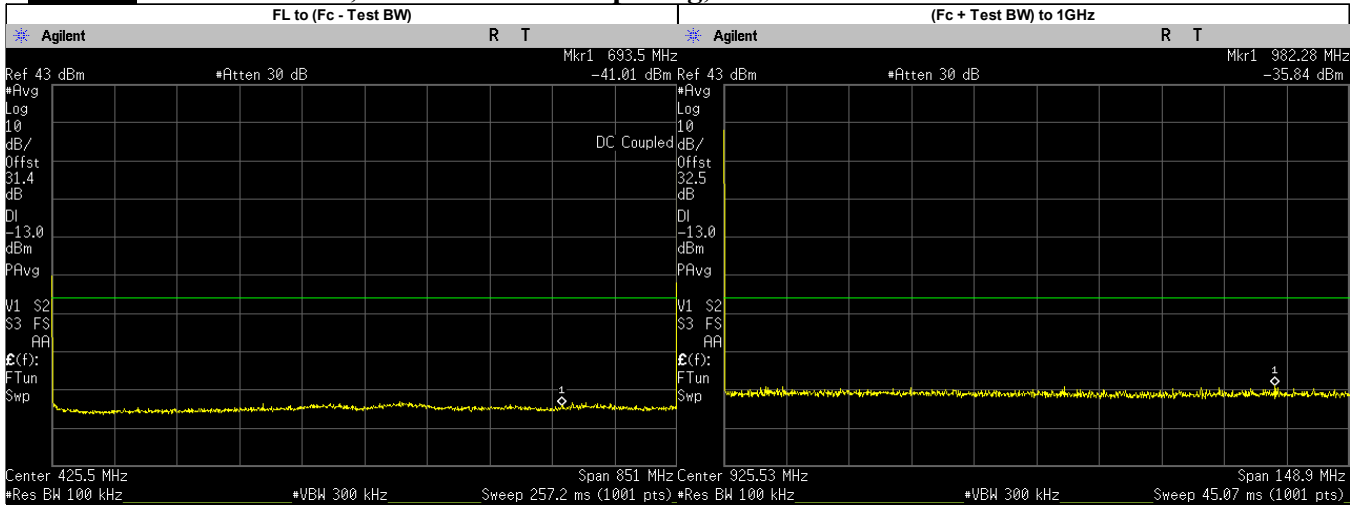

Frequency Range	Highest Spur Frequency (MHz)	Spurious Level (dBm)	Failing Limit (dBm)	Results
FL to (Fc - Test BW)	693.5000	-41.0130	-13.00	PASS
(Fc + Test BW) to 1GHz	982.2764	-35.8400	-13.00	PASS
1GHz to 2Fc	1671.9320	-53.8500	-13.00	PASS
2Fc to 10Fc	2460.6520	-40.1200	-13.00	PASS
	1702.0250	-53.4763	-13.00	PASS
	2553.0370	-53.0950	-13.00	PASS
	3404.0500	-52.1353	-13.00	PASS
	4255.0620	-53.5649	-13.00	PASS
	5106.0750	-54.0960	-13.00	PASS
	5957.0870	-53.8868	-13.00	PASS
	6808.1000	-50.7470	-13.00	PASS
	7659.1130	-51.7612	-13.00	PASS
8510.1250	-52.4174	-13.00	PASS	

Analog: 860.0125. MHz, 25.kHz Channel Spacing, Max. Power

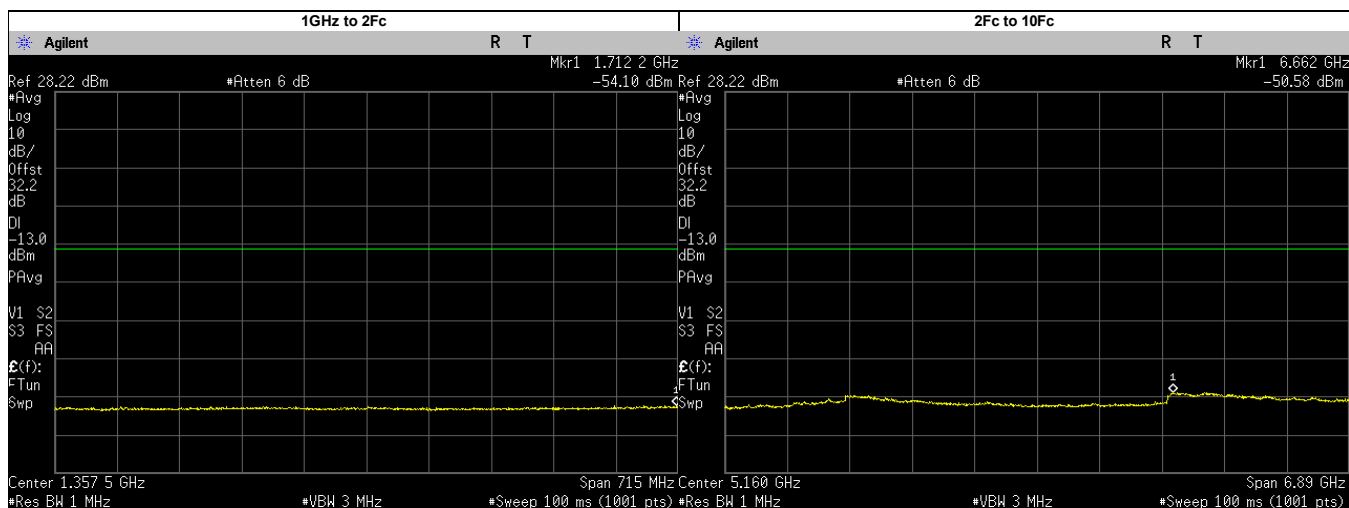
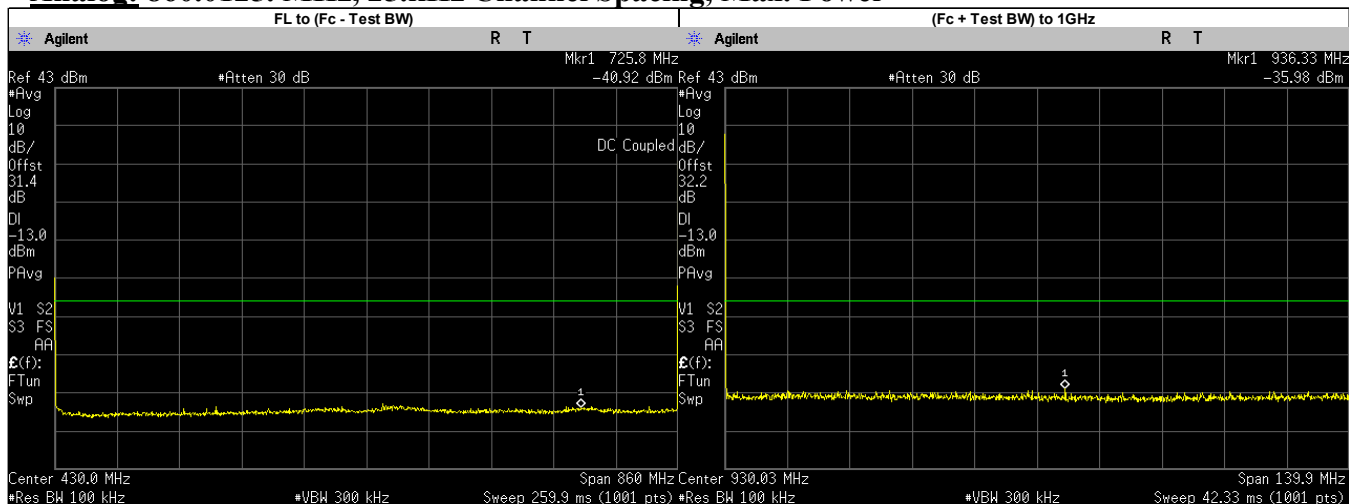

Frequency Range	Highest Spur Frequency (MHz)	Spurious Level (dBm)	Failing Limit (dBm)	Results
FL to (Fc - Test BW)	725.8000	-40.9230	-13.00	PASS
(Fc + Test BW) to 1GHz	936.3284	-35.9800	-13.00	PASS
1GHz to 2Fc	1712.1650	-54.1000	-13.00	PASS
2Fc to 10Fc	6662.1170	-50.5800	-13.00	PASS
	1720.0250	-54.2270	-13.00	PASS
	2580.0370	-53.3270	-13.00	PASS
	3440.0500	-52.4839	-13.00	PASS
	4300.0620	-53.8160	-13.00	PASS
	5160.0750	-54.3060	-13.00	PASS
	6020.0870	-54.0328	-13.00	PASS
	6880.1000	-51.4890	-13.00	PASS
	7740.1130	-51.9369	-13.00	PASS
8600.1250	-52.5729	-13.00	PASS	

Analog: 868.8875. MHz, 25.kHz Channel Spacing, Max. Power

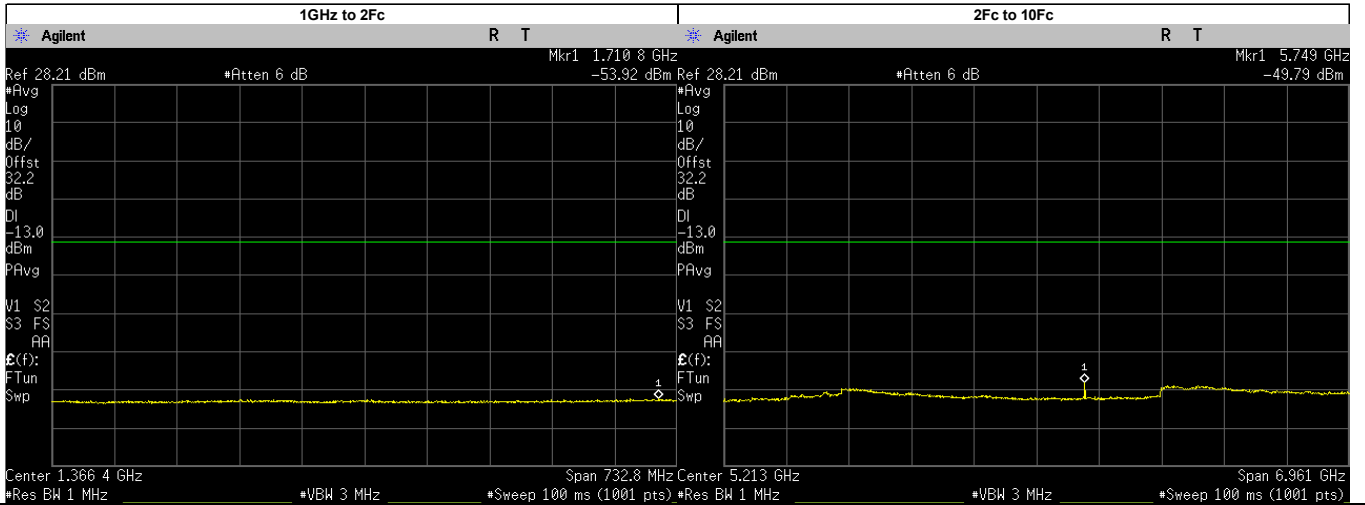
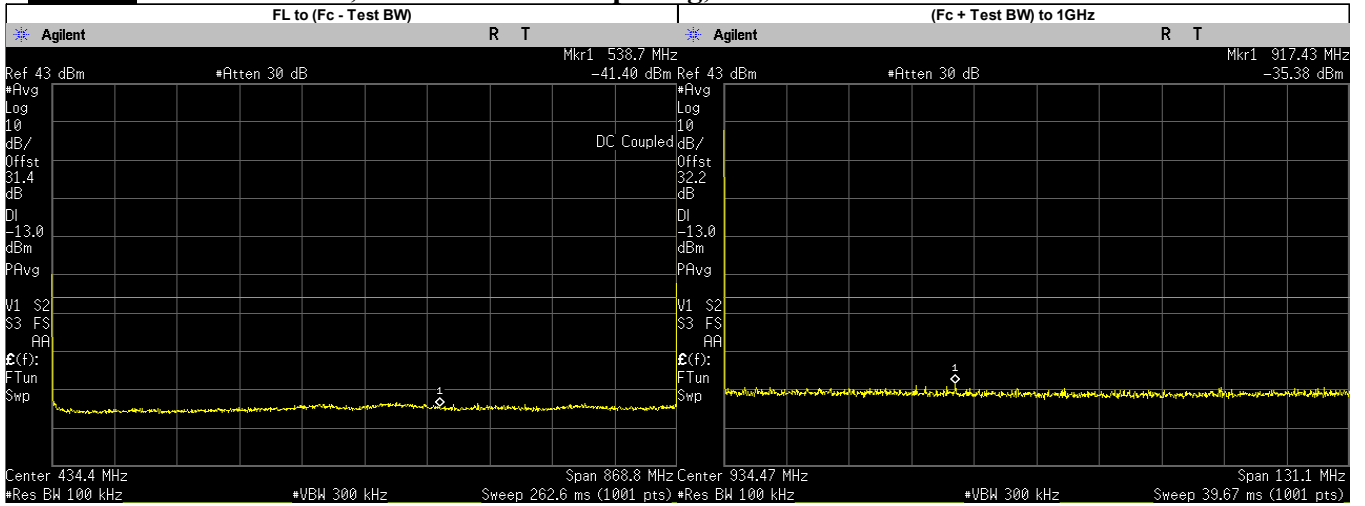

Frequency Range	Highest Spur Frequency (MHz)	Spurious Level (dBm)	Failing Limit (dBm)	Results
FL to (Fc - Test BW)	538.7000	-41.3990	-13.00	PASS
(Fc + Test BW) to 1GHz	917.4306	-35.3800	-13.00	PASS
1GHz to 2Fc	1710.7920	-53.9200	-13.00	PASS
2Fc to 10Fc	5749.3300	-49.7900	-13.00	PASS
	1737.7750	-54.3330	-13.00	PASS
	2606.6620	-52.9580	-13.00	PASS
	3475.5500	-52.4214	-13.00	PASS
	4344.4370	-53.8002	-13.00	PASS
	5213.3250	-54.1600	-13.00	PASS
	6082.2120	-53.9380	-13.00	PASS
	6951.1000	-51.3016	-13.00	PASS
	7819.9880	-52.4292	-13.00	PASS
	8688.8750	-52.6451	-13.00	PASS

6.9.3. Test Result (Digital)

Digital.: 806.0125. MHz, 12.5 kHz Channel Spacing, Max. Power

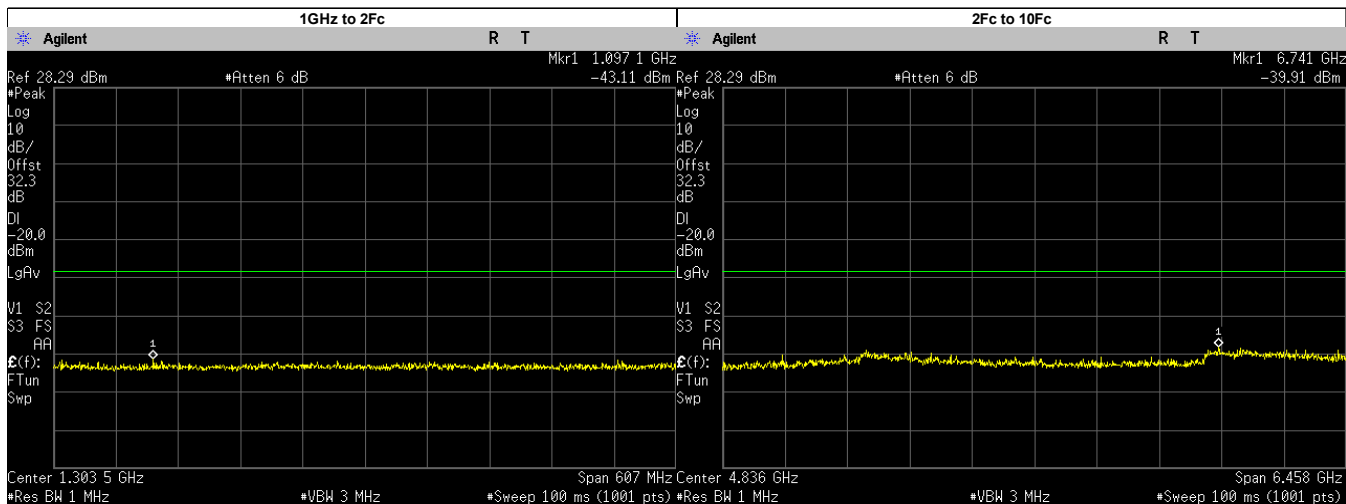
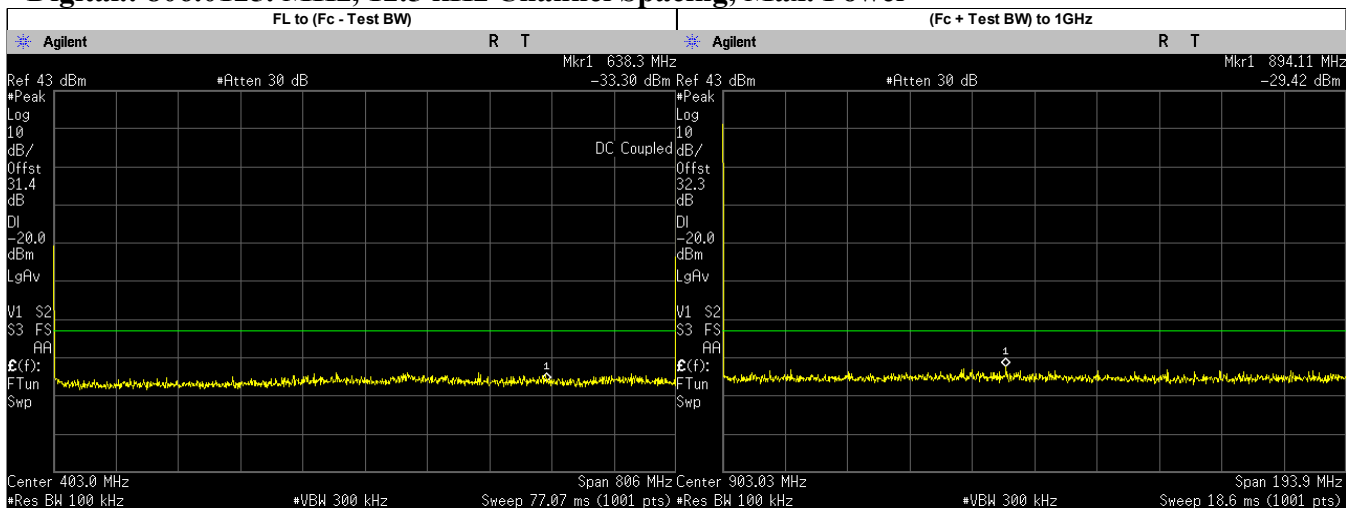

Frequency Range	Highest Spur Frequency (MHz)	Spurious Level (dBm)	Failing Limit (dBm)	Results
FL to (Fc - Test BW)	638.3000	-33.2990	-20.00	PASS
(Fc + Test BW) to 1GHz	894.1101	-29.4200	-20.00	PASS
1GHz to 2Fc	1097.1240	-43.1100	-20.00	PASS
2Fc to 10Fc	1612.0250	-44.2050	-20.00	PASS
	2418.0370	-44.0647	-20.00	PASS
	3224.0500	-42.8259	-20.00	PASS
	4030.0620	-42.6140	-20.00	PASS
	4836.0750	-44.4750	-20.00	PASS
	5642.0870	-44.5010	-20.00	PASS
	6448.1000	-44.6485	-20.00	PASS
	7254.1130	-41.9377	-20.00	PASS
	8060.1250	-42.9336	-20.00	PASS

Digital.: 814.9875. MHz, 12.5 kHz Channel Spacing, Max. Power

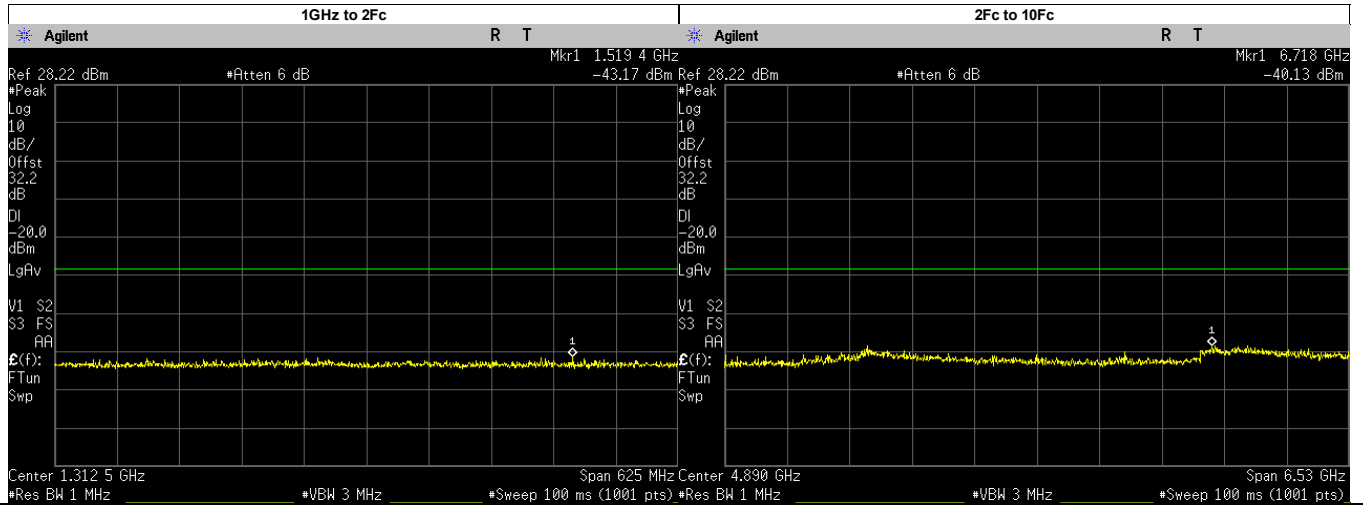
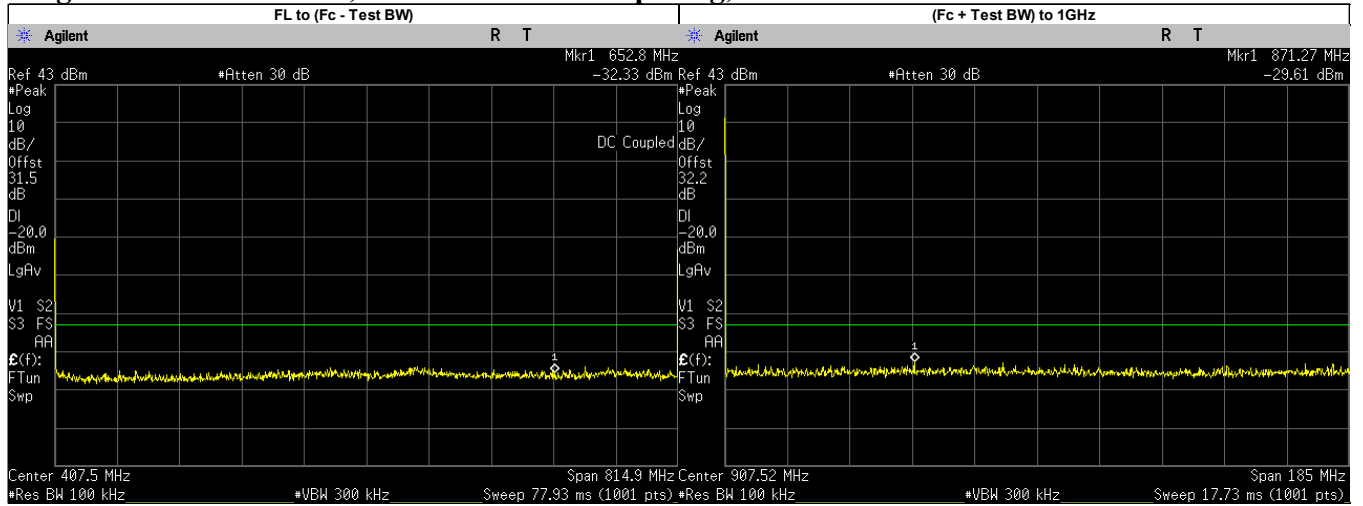

Frequency Range	Highest Spur Frequency (MHz)	Spurious Level (dBm)	Failing Limit (dBm)	Results
FL to (Fc - Test BW)	652.8000	-32.3280	-20.00	PASS
(Fc + Test BW) to 1GHz	871.2661	-29.6100	-20.00	PASS
1GHz to 2Fc	1519.3540	-43.1600	-20.00	PASS
2Fc to 10Fc	6718.2970	-40.1300	-20.00	PASS
	1629.9750	-43.3455	-20.00	PASS
	2444.9630	-43.4422	-20.00	PASS
	3259.9500	-42.6881	-20.00	PASS
	4074.9370	-43.9008	-20.00	PASS
	4889.9250	-42.4570	-20.00	PASS
	5704.9130	-44.5287	-20.00	PASS
	6519.9000	-43.4672	-20.00	PASS
7334.8870	-41.9015	-20.00	PASS	
8149.8750	-42.9649	-20.00	PASS	

Digital.: 823.9875. MHz, 12.5 kHz Channel Spacing, Max. Power

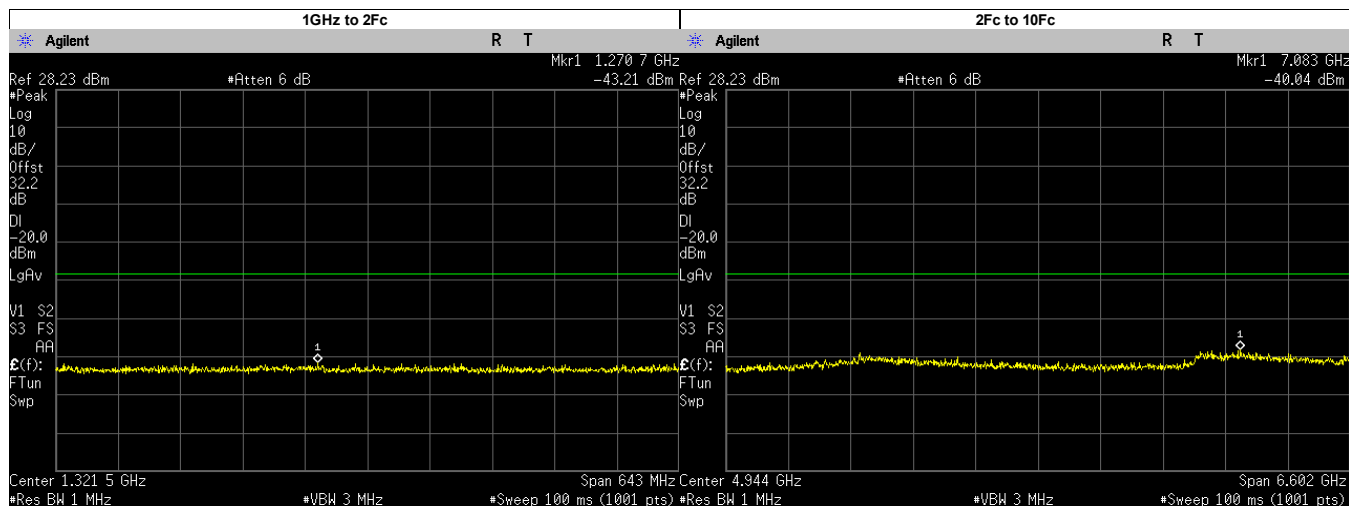
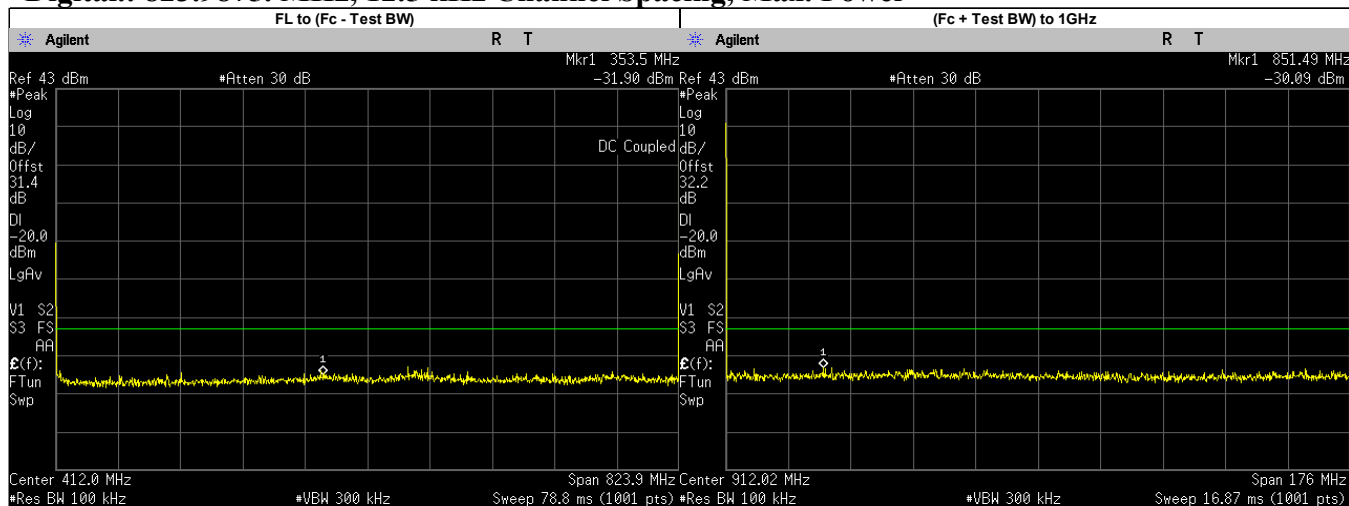

Frequency Range	Highest Spur Frequency (MHz)	Spurious Level (dBm)	Failing Limit (dBm)	Results
FL to (Fc - Test BW)	353.5000	-31.8990	-20.00	PASS
(Fc + Test BW) to 1GHz	851.4877	-30.0900	-20.00	PASS
1GHz to 2Fc	1270.6930	-43.2100	-20.00	PASS
2Fc to 10Fc	7082.9410	-40.0400	-20.00	PASS
	1647.9750	-44.2528	-20.00	PASS
	2471.9630	-44.0501	-20.00	PASS
	3295.9500	-42.4814	-20.00	PASS
	4119.9370	-44.0516	-20.00	PASS
	4943.9250	-44.1840	-20.00	PASS
	5767.9130	-44.3680	-20.00	PASS
	6591.9000	-43.6095	-20.00	PASS
7415.8870	-42.5056	-20.00	PASS	
8239.8750	-42.6042	-20.00	PASS	

Digital.: 851.0125. MHz, 12.5 kHz Channel Spacing, Max. Power

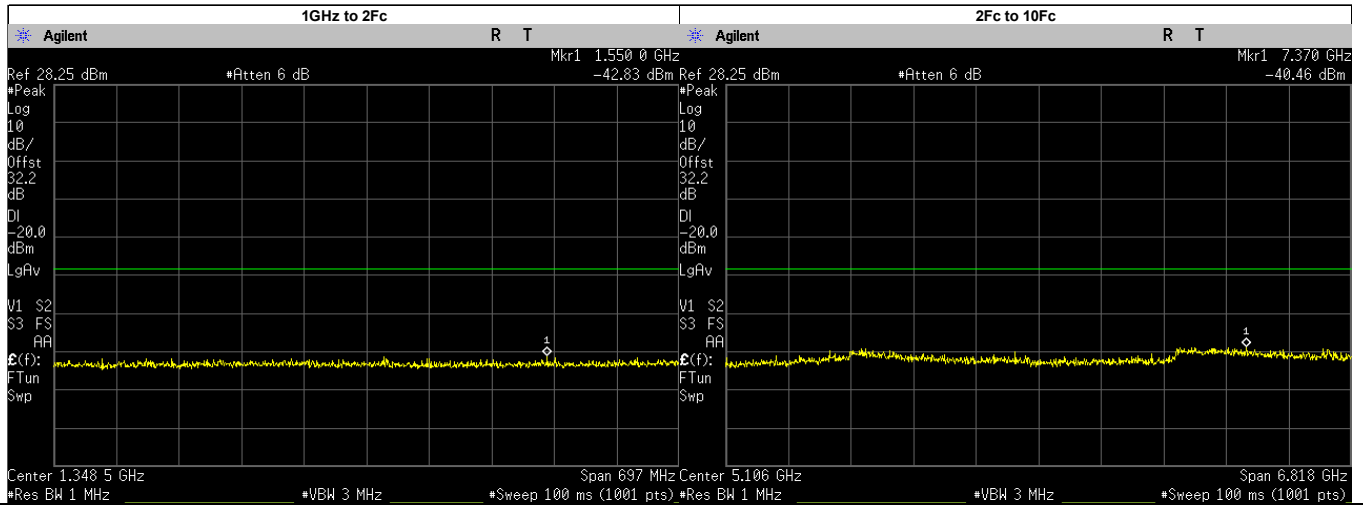
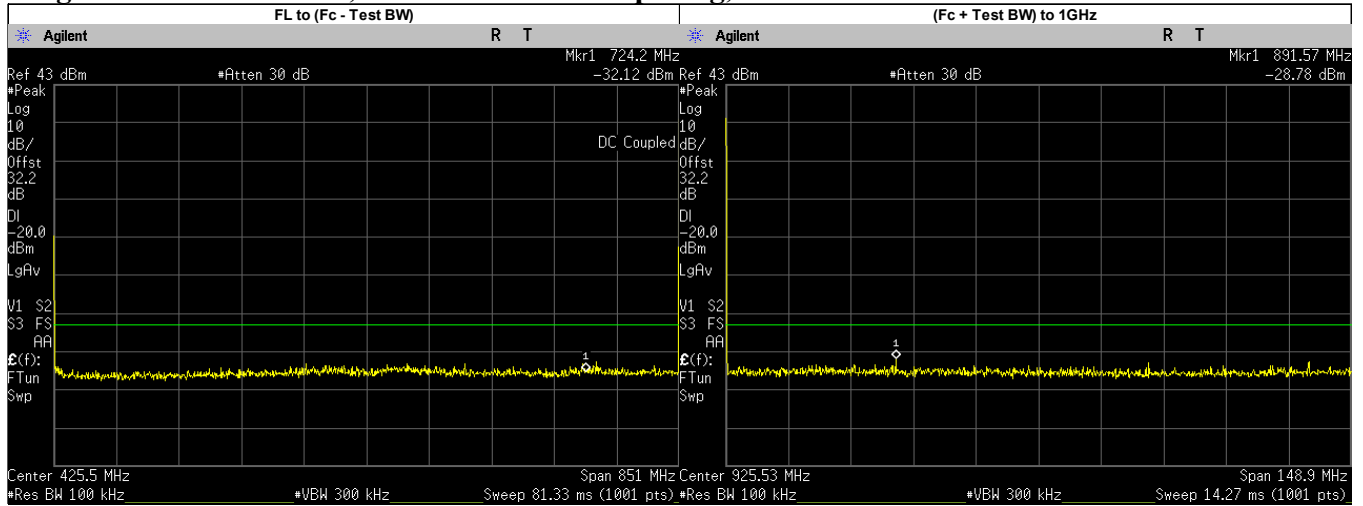

Frequency Range	Highest Spur Frequency (MHz)	Spurious Level (dBm)	Failing Limit (dBm)	Results
FL to (Fc - Test BW)	724.2000	-32.1250	-20.00	PASS
(Fc + Test BW) to 1GHz	891.5735	-28.7800	-20.00	PASS
1GHz to 2Fc	1549.9530	-42.8300	-20.00	PASS
2Fc to 10Fc	7369.6840	-40.4600	-20.00	PASS
	1702.0250	-44.0199	-20.00	PASS
	2553.0370	-43.8470	-20.00	PASS
	3404.0500	-42.4639	-20.00	PASS
	4255.0620	-43.2143	-20.00	PASS
	5106.0750	-45.1650	-20.00	PASS
	5957.0870	-44.9975	-20.00	PASS
	6808.1000	-41.1631	-20.00	PASS
7659.1130	-42.1240	-20.00	PASS	
8510.1250	-43.1743	-20.00	PASS	

Digital.: 860.0125. MHz, 12.5 kHz Channel Spacing, Max. Power

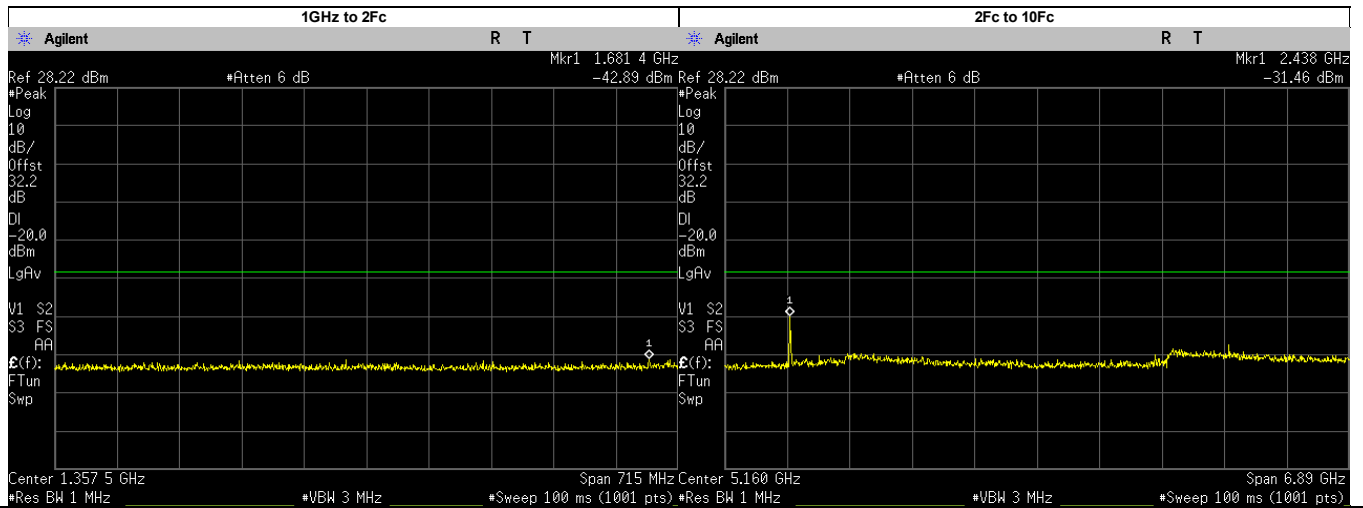
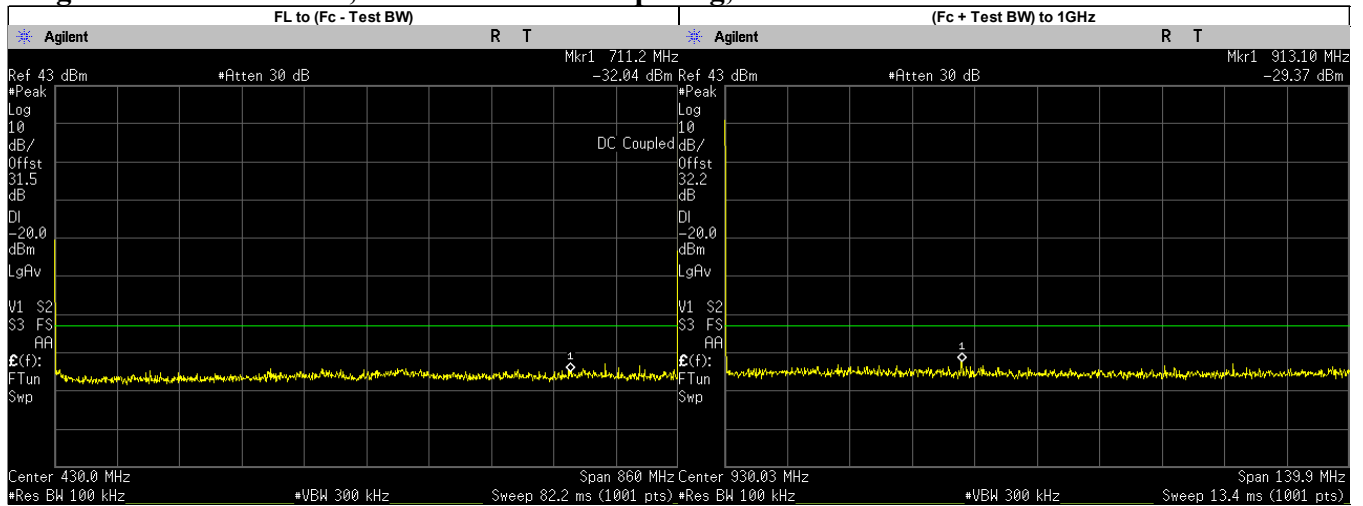

Frequency Range	Highest Spur Frequency (MHz)	Spurious Level (dBm)	Failing Limit (dBm)	Results
FL to (Fc - Test BW)	711.2000	-32.0410	-20.00	PASS
(Fc + Test BW) to 1GHz	913.0988	-29.3700	-20.00	PASS
1GHz to 2Fc	1681.4190	-42.8900	-20.00	PASS
2Fc to 10Fc	2438.0000	-31.4600	-20.00	PASS
	1720.0250	-44.6154	-20.00	PASS
	2580.0370	-43.4623	-20.00	PASS
	3440.0500	-43.2677	-20.00	PASS
	4300.0620	-44.2122	-20.00	PASS
	5160.0750	-45.2820	-20.00	PASS
	6020.0870	-44.5923	-20.00	PASS
	6880.1000	-42.0269	-20.00	PASS
	7740.1130	-43.0878	-20.00	PASS
8600.1250	-43.1249	-20.00	PASS	

Digital.: 868.8875. MHz, 12.5 kHz Channel Spacing, Max. Power

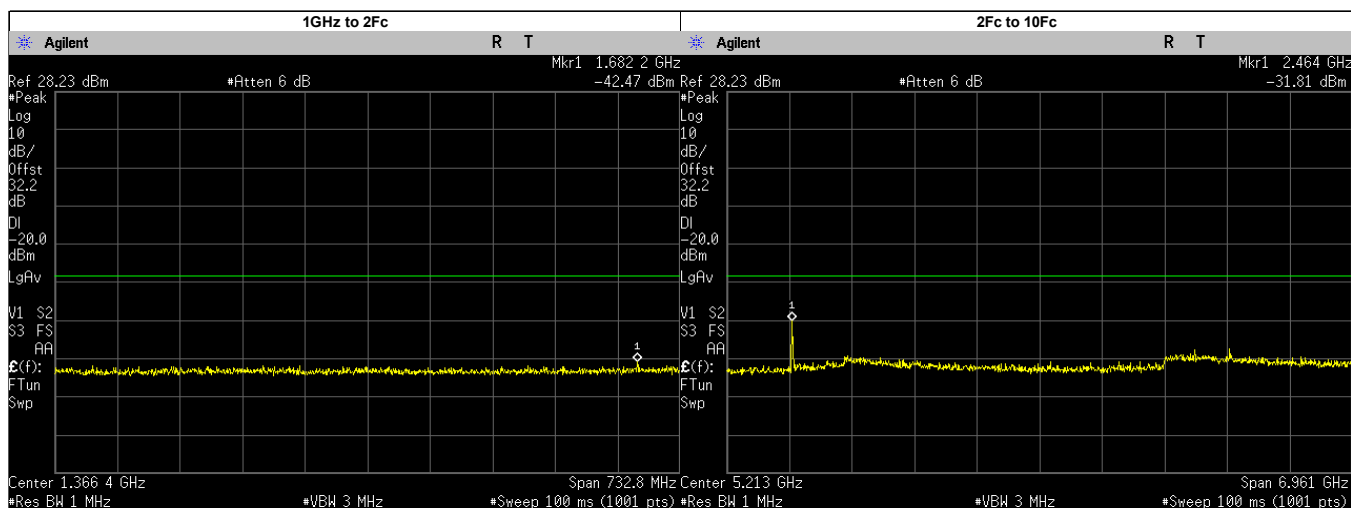
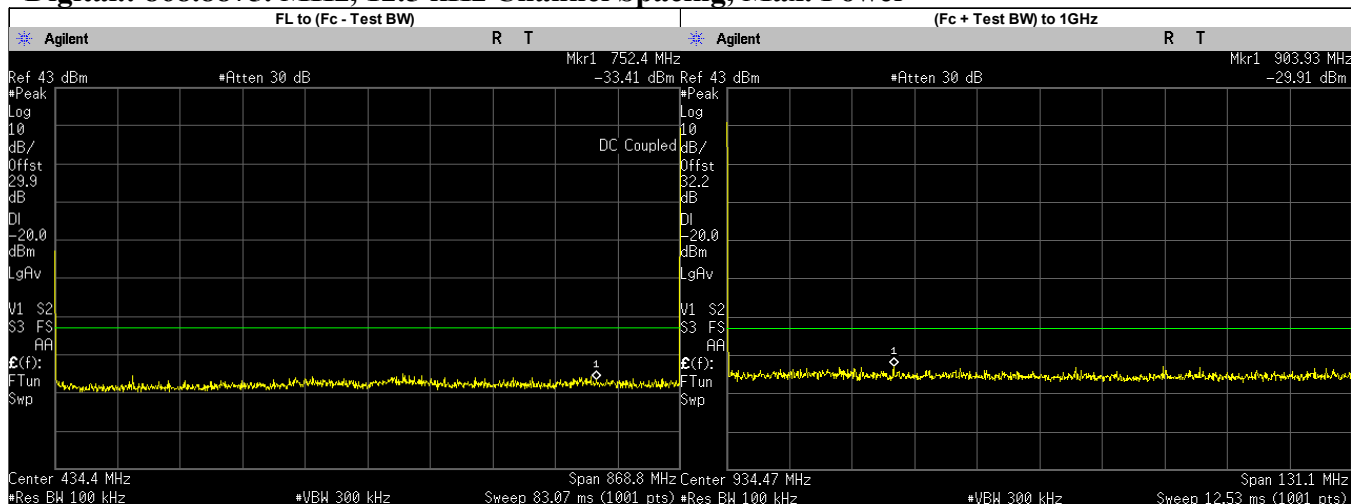

Frequency Range	Highest Spur Frequency (MHz)	Spurious Level (dBm)	Failing Limit (dBm)	Results
FL to (Fc - Test BW)	298.0000	-31.5940	-20.00	PASS
(Fc + Test BW) to 1GHz	903.9312	-29.9100	-20.00	PASS
1GHz to 2Fc	1682.2140	-42.4700	-20.00	PASS
2Fc to 10Fc	2464.0000	-31.8100	-20.00	PASS
	1737.7750	-44.6565	-20.00	PASS
	2606.6620	-43.4793	-20.00	PASS
	3475.5500	-42.6580	-20.00	PASS
	4344.4370	-44.6442	-20.00	PASS
	5213.3250	-44.1550	-20.00	PASS
	6082.2120	-43.7885	-20.00	PASS
	6951.1000	-42.2200	-20.00	PASS
7819.9880	-42.5979	-20.00	PASS	
8688.8750	-43.1854	-20.00	PASS	

6.9.4. Test Limit

Table below summarized the power of any emission outside a licensee’s frequency block shall be attenuated below the transmitter power (P) by at least

Channel Spacing	Part 22	Part 24D	Part 74	Part 80	Part 90 (UHF, VHF, 800, 900)	Part 90 (700)
12.5kHz	43 + log ₁₀ (P) (-13 dBm)	43 + log ₁₀ (P) (-13 dBm)	43 + log ₁₀ (P) (-13 dBm)	Not Applicable	50 + log ₁₀ (P) (-20 dBm)	43 + log ₁₀ (P) (-13 dBm)
25kHz		Not Applicable		43 + log ₁₀ (P) (-13 dBm)	43 + log ₁₀ (P) (-13 dBm)	43 + log ₁₀ (P) (-13 dBm)

Channel Spacing	RSS 134	RSS 182	RSS 119 (UHF, VHF, 800, 900)	RSS 119 (700)
12.5kHz	43 + log ₁₀ (P) (-13 dBm)	Not Applicable	50 + log ₁₀ (P) (-20 dBm)	43 + log ₁₀ (P) (-13 dBm)
25kHz	Not Applicable	43 + log ₁₀ (P) (-13 dBm)	43 + log ₁₀ (P) (-13 dBm)	43 + log ₁₀ (P) (-13 dBm)

6.10. Radiated Spurious Emission

6.10.1. Test Setup

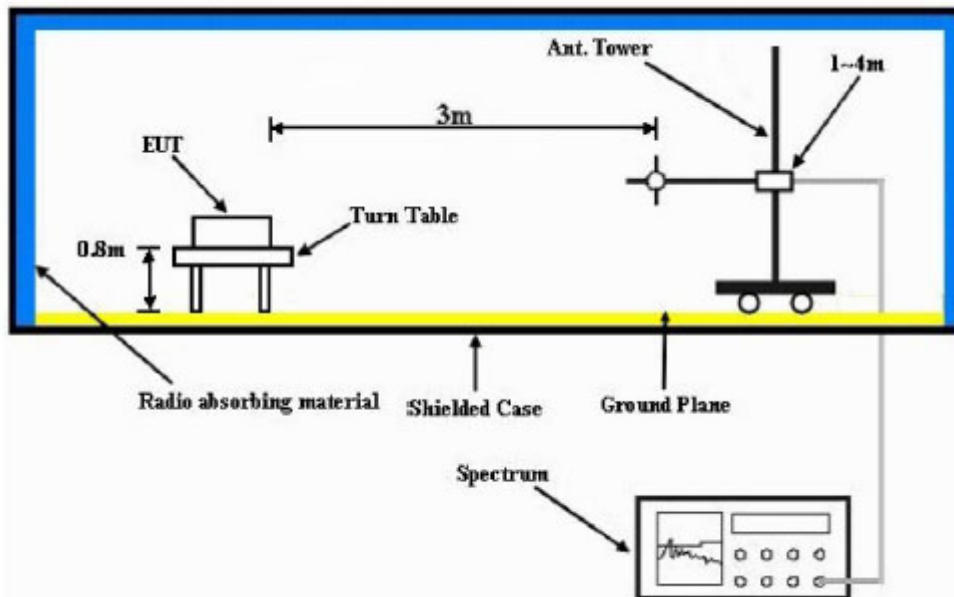

- 1) The Resolution Bandwidth for scanning Radiated Emission below 1 GHz is 100 kHz with Video Bandwidth = 300 kHz and Resolution Bandwidth for above 1 GHz is 1 MHz with Video Bandwidth = 3 MHz. Detector mode is positive peak.
- 2) In the semi- anechoic chamber, setup as illustrated above the DUT placed on the 0.8m height (for $F_c < 1\text{GHz}$) or 1.5m height (for $F_c > 1\text{GHz}$) of Turn Table, rotated the table around 360 degrees to search the maximum radiation power and receiver antenna shall be rotated vertical and horizontal polarization and moved height from 1m to 4m to find the maximum polar radiated power. The “Read Value” is the spectrum reading the maximum power value.
- 3) The substitution antenna is substituted for DUT at the same position and signals generator (S.G) export the CW signal to the substitution antenna via a TX cable. The receiver antenna shall be rotated vertical and horizontal polarization and moved height from 1m to 4m to find the maximum radiation power. Record the power level of maximum radiation power from spectrum. So, the measured substitution value = Ref level of S.G + TX cables loss – Substituted Antenna Gain.
- 4) Final Radiated Spurious Emission = “Read Value” + Measured substitution value.

6.10.2. Test Result (Analog)

SAC Transmitter Radiated Emission:

Model Number: AAH90UCU9RH1AN S/N: 734TYF0065 SR:27331-EMC-00022
 Battery Part No: PMNN4805A Accy Part No: N/A
 Test Mode: TX Analog
 806.012500 MHz 25 kHz 3.000 Watt(s) /Max Power

Frequency (MHz)	Limit	Horizontal Measured Emission Equiv Pwr Into Ideal Dipole (dBm)	Vertical Measured Emission Equiv Pwr Into ideal Dipole (dBm)
1612.0250	-13.0000	-60.2875 **	-59.5977 **
2418.0375	-13.0000	-57.0140 **	-56.9930 **
3224.0500	-13.0000	-51.8444 **	-52.7894 **
4030.0625	-13.0000	-51.5063 **	-50.2104 **
4836.0750	-13.0000	-47.3873 **	-48.5168 **
5642.0875	-13.0000	-49.2551 **	-48.4429 **
6448.1000	-13.0000	-46.9957 **	-46.0596 **
7254.1125	-13.0000	-45.3505 **	-44.3722 **
8060.1250	-13.0000	-44.7678 **	-44.8944 **

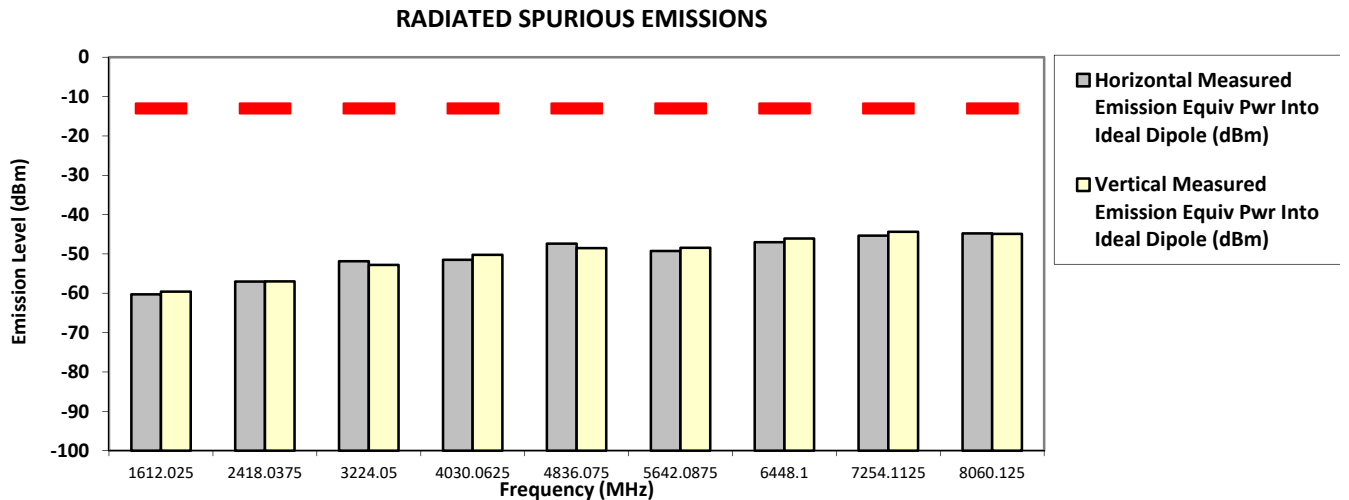

The data presented here was taken using the substitution method as found in the ANSI C63.26-2015 document.
 Motorola Penang EMC Lab - Test Performed by: Aiman & Azil Sun, 10 Apr, 2022

Remarks: ** Indicates the spurious emission could not be detected due to noise limitations or ambient.
 *Pursuant to CFR 47 Part 2.1057 (c), emissions attenuated more than 20 dB below the permissible limit are not reported
 Temp(Deg): 22.1 Hum(%RH): 53.4

Remarks: Passed Results Marginal Results Failed Results

SAC Transmitter Radiated Emission:

Model Number: AAH90UCU9RH1AN

S/N: 734TYF0065

SR:27331-EMC-00022

Battery Part No: PMNN4805A

Accy Part No: N/A

814.987500 MHz

Test Mode: TX Analog
 25 kHz

3.000 Watt(s) /Max Power

Frequency (MHz)	Limit	Horizontal Measured Emission Equiv Pwr Into Ideal Dipole (dBm)	Vertical Measured Emission Equiv Pwr Into ideal Dipole (dBm)
1629.9750	-13.0000	-61.0791 **	-58.6803 **
2444.9625	-13.0000	-57.3032 **	-57.4113 **
3259.9500	-13.0000	-51.7008 **	-52.6477 **
4074.9375	-13.0000	-51.4616 **	-51.4776 **
4889.9250	-13.0000	-49.2466 **	-49.0698 **
5704.9125	-13.0000	-48.1092 **	-48.5059 **
6519.9000	-13.0000	-46.1337 **	-46.0206 **
7334.8875	-13.0000	-45.1521 **	-45.2976 **
8149.8750	-13.0000	-42.0031 **	-42.8068 **

RADIATED SPURIOUS EMISSIONS

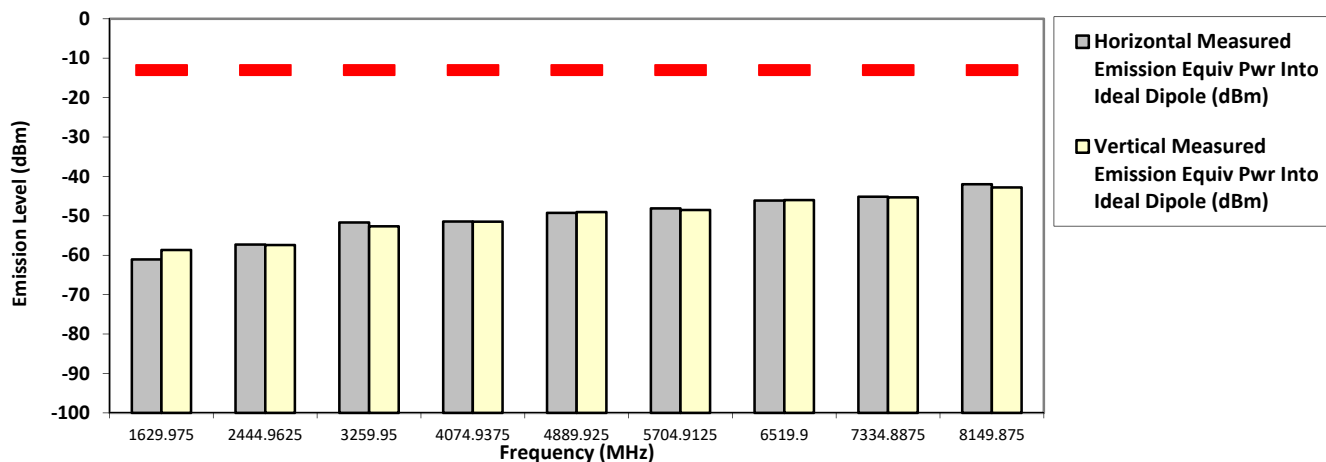

The data presented here was taken using the substitution method as found in the ANSI C63.26-2015 document.
 Motorola Penang EMC Lab - Test Performed by: Aiman & Azil Sun, 10 Apr, 2022

Remarks: ** Indicates the spurious emission could not be detected due to noise limitations or ambient.

*Pursuant to CFR 47 Part 2.1057 (c), emissions attenuated more than 20 dB below the permissible limit are not reported
 Temp(Deg): 22.1 Hum(%RH): 53.4

Remarks:

Passed Results	Marginal Results	Failed Results
----------------	------------------	----------------

SAC Transmitter Radiated Emission:

Model Number: AAH90UCU9RH1AN S/N: 734TYF0065 SR:27331-EMC-00022
 Battery Part No: PMNN4805A Test Mode: TX Analog Accy Part No: N/A
 823.987500 MHz 25 kHz 3.000 Watt(s) /Max Power

Frequency (MHz)	Limit	Horizontal Measured Emission Equiv Pwr Into Ideal Dipole (dBm)	Vertical Measured Emission Equiv Pwr Into ideal Dipole (dBm)
1647.9750	-13.0000	-60.4409 **	-61.5958 **
2471.9625	-13.0000	-57.5507 **	-57.8119 **
3295.9500	-13.0000	-52.9252 **	-52.4890 **
4119.9375	-13.0000	-51.2989 **	-51.2252 **
4943.9250	-13.0000	-48.6269 **	-48.3744 **
5767.9125	-13.0000	-48.6017 **	-47.9377 **
6591.9000	-13.0000	-45.9475 **	-44.7362 **
7415.8875	-13.0000	-44.7598 **	-45.9488 **
8239.8750	-13.0000	-42.7171 **	-41.8273 **

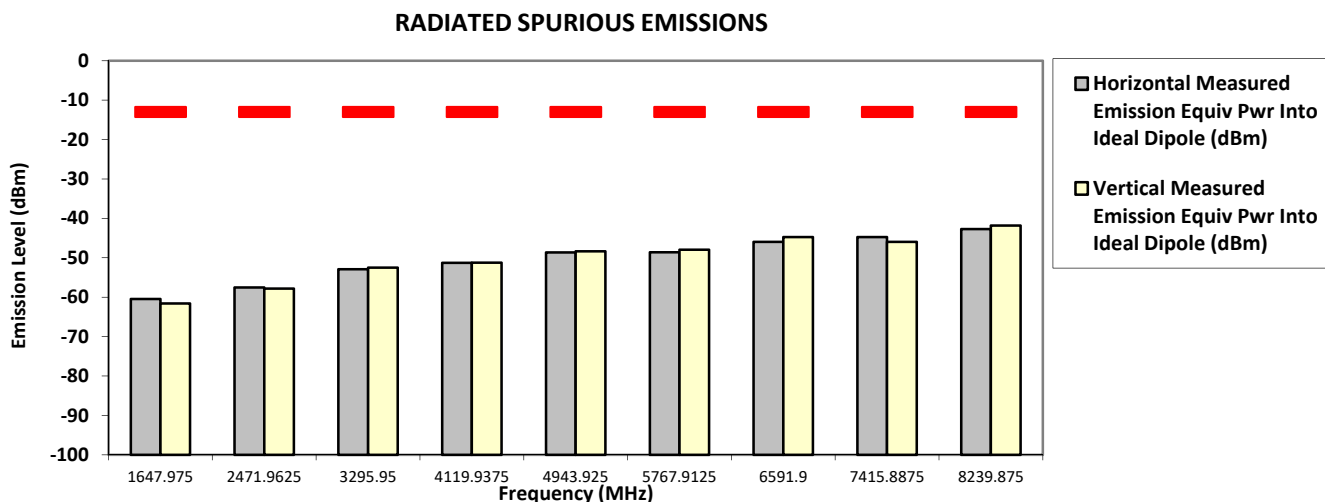

The data presented here was taken using the substitution method as found in the ANSI C63.26-2015 document.
 Motorola Penang EMC Lab - Test Performed by: Aiman & Azil Sun, 10 Apr, 2022

Remarks: ** Indicates the spurious emission could not be detected due to noise limitations or ambient.
 *Pursuant to CFR 47 Part 2.1057 (c), emissions attenuated more than 20 dB below the permissible limit are not reported
 Temp(Deg): 22.1 Hum(%RH): 53.4

Remarks: Passed Results Marginal Results Failed Results

SAC Transmitter Radiated Emission:

Model Number: AAH90UCU9RH1AN S/N: 734TYF0065 SR:27331-EMC-00022
 Battery Part No: PMNN4805A Test Mode: TX Analog Accy Part No: N/A
 851.012500 MHz 25 kHz 3.000 Watt(s) /Max Power

Frequency (MHz)	Limit	Horizontal Measured Emission Equiv Pwr Into Ideal Dipole (dBm)	Vertical Measured Emission Equiv Pwr Into ideal Dipole (dBm)
1702.0250	-13.0000	-60.9974 **	-60.2985 **
2553.0375	-13.0000	-57.3670 **	-56.5353 **
3404.0500	-13.0000	-52.0409 **	-54.0788 **
4255.0625	-13.0000	-52.6605 **	-51.8855 **
5106.0750	-13.0000	-49.0069 **	-48.0385 **
5957.0875	-13.0000	-46.5376 **	-46.9076 **
6808.1000	-13.0000	-44.6267 **	-44.8030 **
7659.1125	-13.0000	-43.5001 **	-43.7983 **
8510.1250	-13.0000	-43.0028 **	-44.3303 **

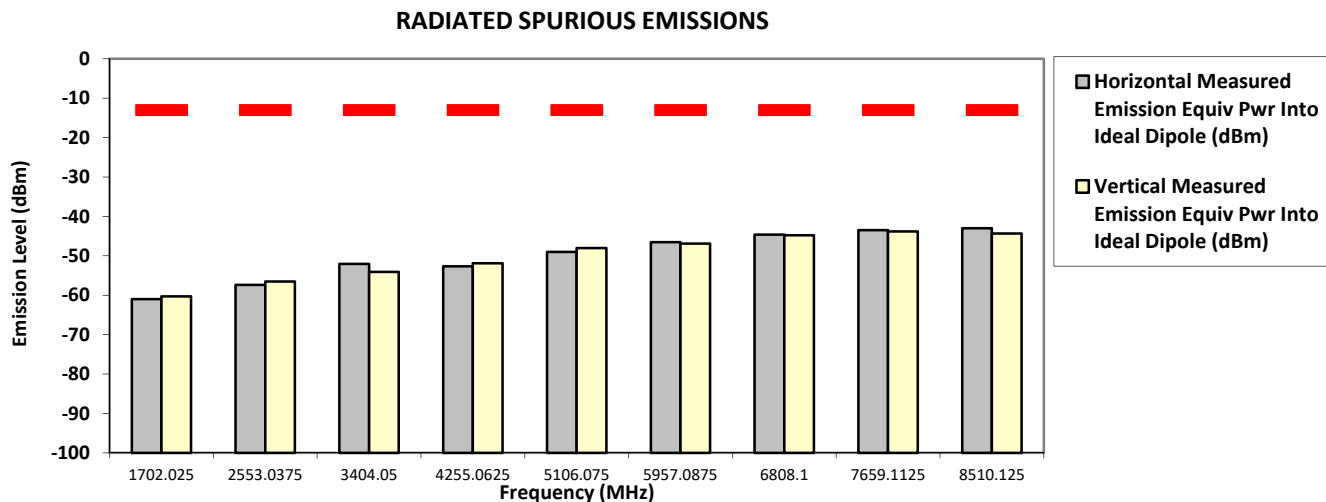

The data presented here was taken using the substitution method as found in the ANSI C63.26-2015 document.
 Motorola Penang EMC Lab - Test Performed by: Aiman & Azil Sun, 10 Apr, 2022

Remarks: ** Indicates the spurious emission could not be detected due to noise limitations or ambient.
 *Pursuant to CFR 47 Part 2.1057 (c), emissions attenuated more than 20 dB below the permissible limit are not reported
 Temp(Deg): 22.1 Hum(%RH): 53.4

Remarks: Passed Results Marginal Results Failed Results

SAC Transmitter Radiated Emission:

Model Number: AAH90UCU9RH1AN

S/N: 734TYF0065

SR:27331-EMC-00022

Battery Part No: PMNN4805A

Accy Part No: N/A

860.012500 MHz

Test Mode: TX Analog
 25 kHz

3.000 Watt(s) /Max Power

Frequency (MHz)	Limit	Horizontal Measured Emission Equiv Pwr Into Ideal Dipole (dBm)	Vertical Measured Emission Equiv Pwr Into ideal Dipole (dBm)
1720.0250	-13.0000	-60.2853 **	-59.8518 **
2580.0375	-13.0000	-57.2476 **	-56.4541 **
3440.0500	-13.0000	-53.2692 **	-53.5267 **
4300.0625	-13.0000	-52.4995 **	-51.7789 **
5160.0750	-13.0000	-48.7714 **	-48.5071 **
6020.0875	-13.0000	-45.8011 **	-47.3782 **
6880.1000	-13.0000	-44.3386 **	-45.3713 **
7740.1125	-13.0000	-42.8873 **	-44.4305 **
8600.1250	-13.0000	-42.8004 **	-44.0048 **

RADIATED SPURIOUS EMISSIONS

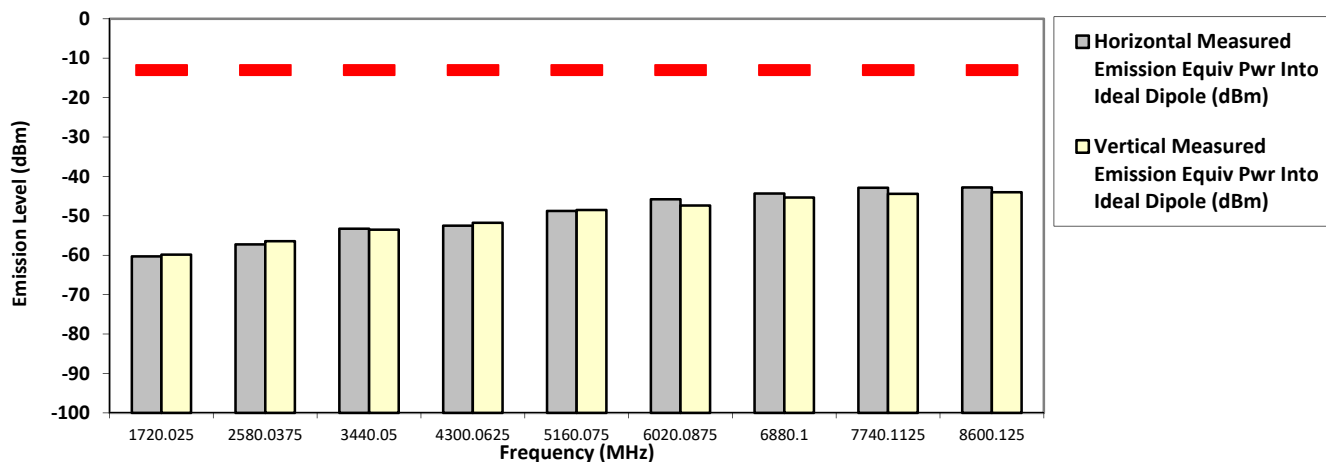

The data presented here was taken using the substitution method as found in the ANSI C63.26-2015 document.
 Motorola Penang EMC Lab - Test Performed by: Aiman & Azil
 Sun, 10 Apr, 2022

Remarks: ** Indicates the spurious emission could not be detected due to noise limitations or ambient.

*Pursuant to CFR 47 Part 2.1057 (c), emissions attenuated more than 20 dB below the permissible limit are not reported
 Temp(Deg): 22.1 Hum(%RH): 53.4

Remarks:

Passed Results	Marginal Results	Failed Results
----------------	------------------	----------------

SAC Transmitter Radiated Emission:

Model Number: AAH90UCU9RH1AN S/N: 734TYF0065 SR:27331-EMC-00022
 Battery Part No: PMNN4805A Test Mode: TX Analog Accy Part No: N/A
 868.887500 MHz 25 kHz 3.000 Watt(s) /Max Power

Frequency (MHz)	Limit	Horizontal Measured Emission Equiv Pwr Into Ideal Dipole (dBm)	Vertical Measured Emission Equiv Pwr Into ideal Dipole (dBm)
1737.7750	-13.0000	-60.0421 **	-60.2361 **
2606.6625	-13.0000	-55.3857 **	-56.1841 **
3475.5500	-13.0000	-53.6197 **	-52.9977 **
4344.4375	-13.0000	-51.4566 **	-51.5561 **
5213.3250	-13.0000	-49.4528 **	-48.4918 **
6082.2125	-13.0000	-46.2116 **	-46.2333 **
6951.1000	-13.0000	-45.7185 **	-44.5083 **
7819.9875	-13.0000	-45.0636 **	-43.9535 **
8688.8750	-13.0000	-43.7515 **	-42.8888 **

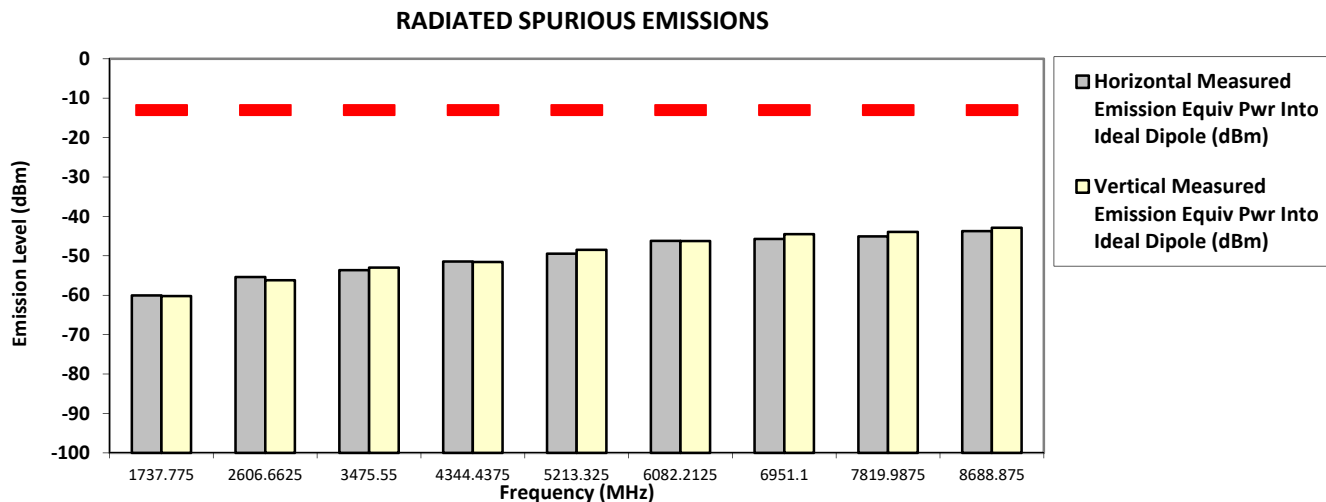

The data presented here was taken using the substitution method as found in the ANSI C63.26-2015 document.
 Motorola Penang EMC Lab - Test Performed by: Aiman & Azil Sun, 10 Apr, 2022

Remarks: ** Indicates the spurious emission could not be detected due to noise limitations or ambient.
 *Pursuant to CFR 47 Part 2.1057 (c), emissions attenuated more than 20 dB below the permissible limit are not reported
 Temp(Deg): 22.1 Hum(%RH): 53.4

Remarks: Passed Results Marginal Results Failed Results

6.10.3. Test Result (Digital)

SAC Transmitter Radiated Emission:

Model Number: AAH90UCU9RH1AN S/N: 734TYF0065 SR:27331-EMC-00022
 Battery Part No: PMNN4805A Accy Part No: N/A

Test Mode: TX Digital 3.000 Watt(s) /Max Power
 806.012500 MHz 12.5 kHz

Frequency (MHz)	Limit	Horizontal Measured Emission Equiv Pwr Into Ideal Dipole (dBm)	Vertical Measured Emission Equiv Pwr Into ideal Dipole (dBm)
1612.0250	-20.0000	-61.1394 **	-61.1713 **
2418.0375	-20.0000	-56.1528 **	-56.2977 **
3224.0500	-20.0000	-53.1339 **	-51.6745 **
4030.0625	-20.0000	-50.8831 **	-51.7428 **
4836.0750	-20.0000	-48.8219 **	-48.3223 **
5642.0875	-20.0000	-46.8785 **	-47.8911 **
6448.1000	-20.0000	-46.1632 **	-45.5544 **
7254.1125	-20.0000	-45.2164 **	-43.8218 **
8060.1250	-20.0000	-44.2277 **	-44.0823 **

RADIATED SPURIOUS EMISSIONS

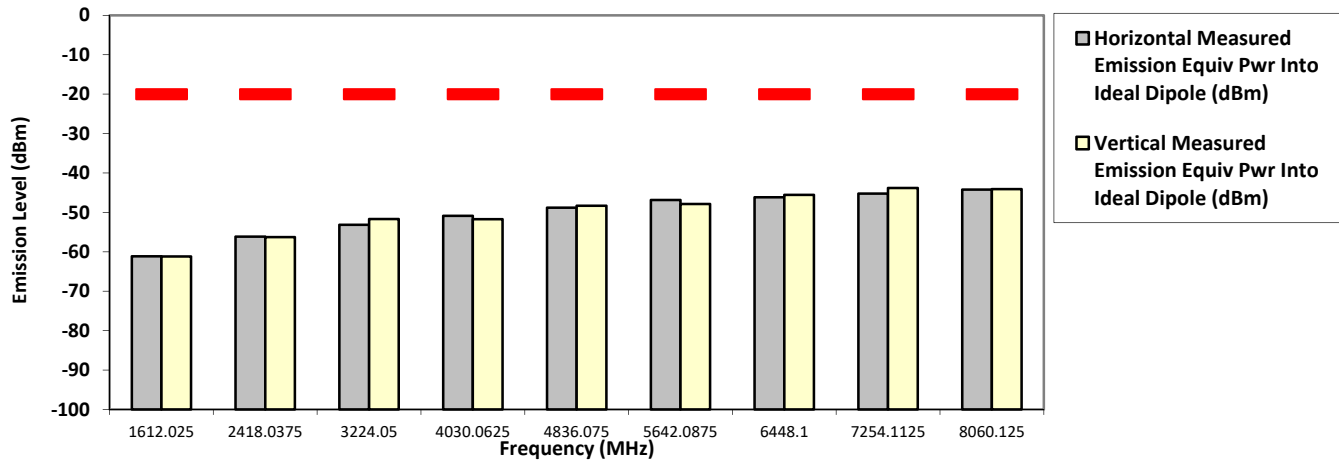

The data presented here was taken using the substitution method as found in the ANSI C63.26-2015 document.
 Motorola Penang EMC Lab - Test Performed by: Aiman & Azil Sun, 10 Apr, 2022

Remarks: ** Indicates the spurious emission could not be detected due to noise limitations or ambient.
 *Pursuant to CFR 47 Part 2.1057 (c), emissions attenuated more than 20 dB below the permissible limit are not reported
 Temp(Deg): 22.1 Hum(%RH): 53.4

Remarks: Passed Results Marginal Results Failed Results

SAC Transmitter Radiated Emission:

Model Number: AAH90UCU9RH1AN S/N: 734TYF0065 SR:27331-EMC-00022
 Battery Part No: PMNN4805A Accy Part No: N/A
 Test Mode: TX Digital
 814.987500 MHz 12.5 kHz 3.000 Watt(s) /Max Power

Frequency (MHz)	Limit	Horizontal Measured Emission Equiv Pwr Into Ideal Dipole (dBm)	Vertical Measured Emission Equiv Pwr Into ideal Dipole (dBm)
1629.9750	-20.0000	-59.6061 **	-60.0919 **
2444.9625	-20.0000	-56.5753 **	-56.8545 **
3259.9500	-20.0000	-51.2569 **	-52.5426 **
4074.9375	-20.0000	-50.7961 **	-51.9180 **
4889.9250	-20.0000	-48.0594 **	-48.4252 **
5704.9125	-20.0000	-49.2460 **	-47.3168 **
6519.9000	-20.0000	-44.9503 **	-46.8475 **
7334.8875	-20.0000	-44.8179 **	-44.5257 **
8149.8750	-20.0000	-43.1312 **	-42.9919 **

RADIATED SPURIOUS EMISSIONS

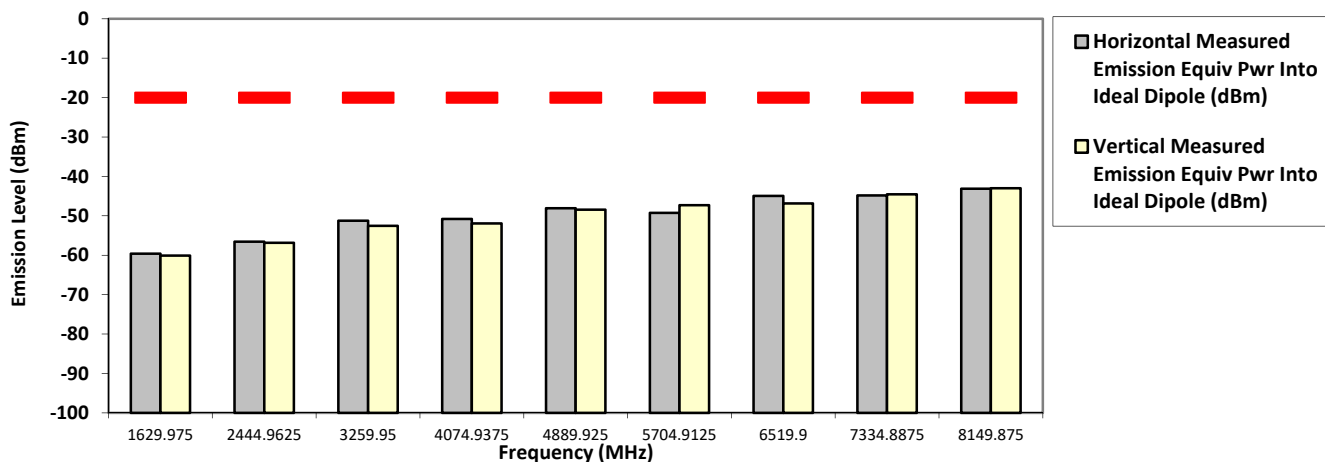

The data presented here was taken using the substitution method as found in the ANSI C63.26-2015 document.
 Motorola Penang EMC Lab - Test Performed by: Aiman & Azil Sun, 10 Apr, 2022

Remarks: ** Indicates the spurious emission could not be detected due to noise limitations or ambient.
 *Pursuant to CFR 47 Part 2.1057 (c), emissions attenuated more than 20 dB below the permissible limit are not reported
 Temp(Deg): 22.1 Hum(%RH): 53.4

Remarks: Passed Results Marginal Results Failed Results

SAC Transmitter Radiated Emission:

Model Number: AAH90UCU9RH1AN S/N: 734TYF0065 SR:27331-EMC-00022
 Battery Part No: PMNN4805A Accy Part No: N/A
 Test Mode: TX Digital
 823.987500 MHz 12.5 kHz 3.000 Watt(s) /Max Power

Frequency (MHz)	Limit	Horizontal Measured Emission Equiv Pwr Into Ideal Dipole (dBm)	Vertical Measured Emission Equiv Pwr Into ideal Dipole (dBm)
1647.9750	-20.0000	-60.1913 **	-59.0538 **
2471.9625	-20.0000	-55.9767 **	-56.8903 **
3295.9500	-20.0000	-52.7680 **	-52.8800 **
4119.9375	-20.0000	-49.7162 **	-51.1690 **
4943.9250	-20.0000	-48.8180 **	-47.4198 **
5767.9125	-20.0000	-48.2297 **	-47.8718 **
6591.9000	-20.0000	-44.9161 **	-46.0089 **
7415.8875	-20.0000	-45.6102 **	-46.1465 **
8239.8750	-20.0000	-40.9229 **	-42.0344 **

RADIATED SPURIOUS EMISSIONS

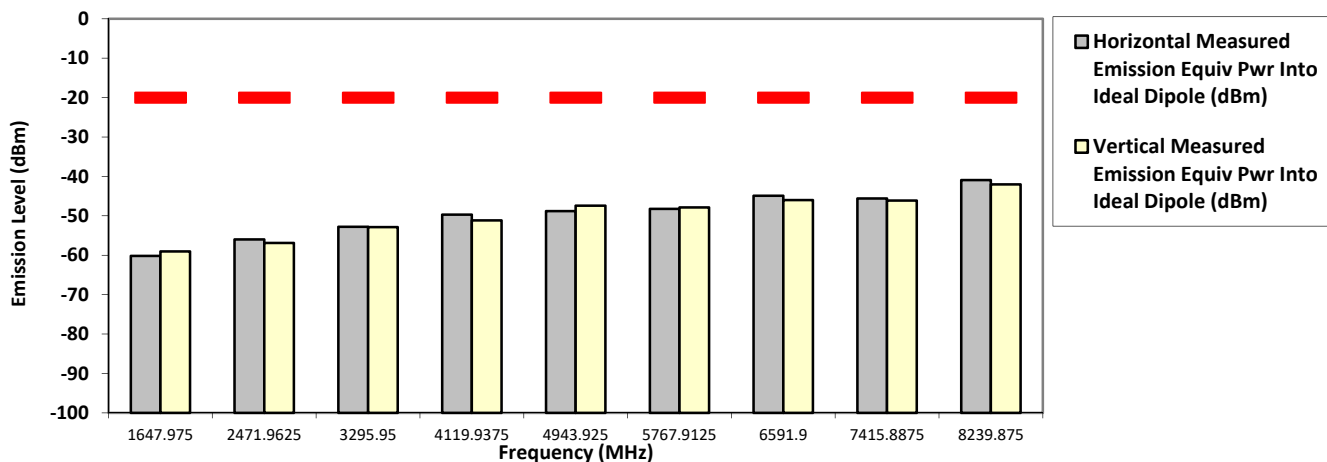

The data presented here was taken using the substitution method as found in the ANSI C63.26-2015 document.
 Motorola Penang EMC Lab - Test Performed by: Aiman & Azil Sun, 10 Apr, 2022

Remarks: ** Indicates the spurious emission could not be detected due to noise limitations or ambient.
 *Pursuant to CFR 47 Part 2.1057 (c), emissions attenuated more than 20 dB below the permissible limit are not reported
 Temp(Deg): 22.1 Hum(%RH): 53.4

Remarks: Passed Results Marginal Results Failed Results

SAC Transmitter Radiated Emission:

Model Number: AAH90UCU9RH1AN S/N: 734TYF0065 SR:27331-EMC-00022
 Battery Part No: PMNN4805A Test Mode: TX Digital Accy Part No: N/A
 851.012500 MHz 12.5 kHz 3.000 Watt(s) /Max Power

Frequency (MHz)	Limit	Horizontal Measured Emission Equiv Pwr Into Ideal Dipole (dBm)	Vertical Measured Emission Equiv Pwr Into ideal Dipole (dBm)
1702.0250	-20.0000	-59.4848 **	-59.5573 **
2553.0375	-20.0000	-55.1026 **	-57.3305 **
3404.0500	-20.0000	-53.0849 **	-54.0109 **
4255.0625	-20.0000	-51.3197 **	-51.6948 **
5106.0750	-20.0000	-49.2135 **	-47.3562 **
5957.0875	-20.0000	-47.2503 **	-46.7331 **
6808.1000	-20.0000	-45.6717 **	-45.1248 **
7659.1125	-20.0000	-43.0703 **	-43.6898 **
8510.1250	-20.0000	-42.9045 **	-44.4221 **

RADIATED SPURIOUS EMISSIONS

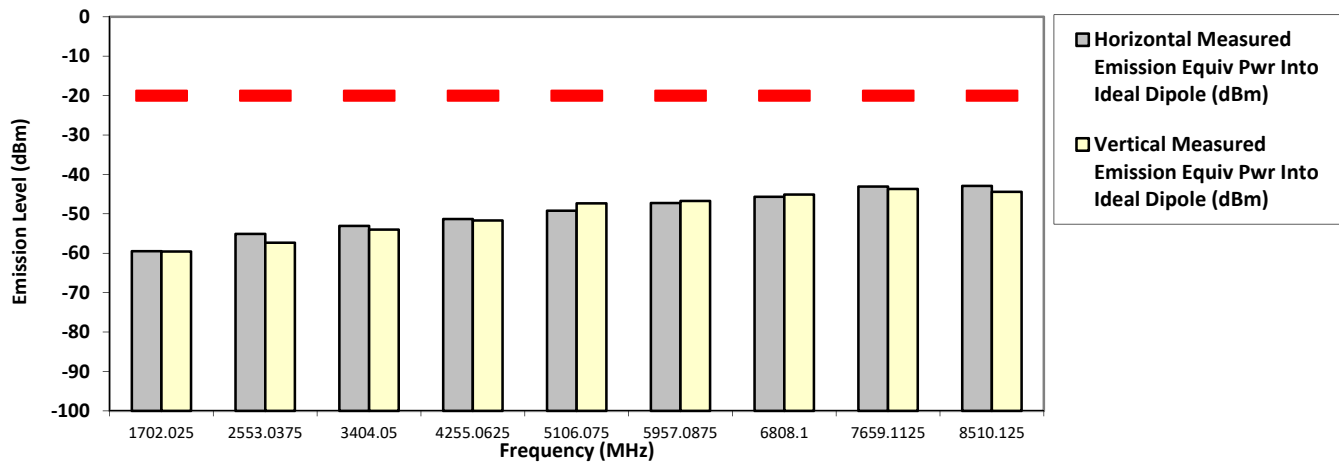

The data presented here was taken using the substitution method as found in the ANSI C63.26-2015 document.
 Motorola Penang EMC Lab - Test Performed by: Aiman & Azil Sun, 10 Apr, 2022

Remarks: ** Indicates the spurious emission could not be detected due to noise limitations or ambient.
 *Pursuant to CFR 47 Part 2.1057 (c), emissions attenuated more than 20 dB below the permissible limit are not reported
 Temp(Deg): 22.1 Hum(%RH): 53.4

Remarks: Passed Results Marginal Results Failed Results

SAC Transmitter Radiated Emission:

Model Number: AAH90UCU9RH1AN S/N: 734TYF0065 SR:27331-EMC-00022
 Battery Part No: PMNN4805A Accy Part No: N/A
 Test Mode: TX Digital
 860.012500 MHz 12.5 kHz 3.000 Watt(s) /Max Power

Frequency (MHz)	Limit	Horizontal Measured Emission Equiv Pwr Into Ideal Dipole (dBm)	Vertical Measured Emission Equiv Pwr Into ideal Dipole (dBm)
1720.0250	-20.0000	-59.1573 **	-60.7008 **
2580.0375	-20.0000	-55.5064 **	-56.0220 **
3440.0500	-20.0000	-53.3970 **	-53.8745 **
4300.0625	-20.0000	-50.6703 **	-51.6233 **
5160.0750	-20.0000	-49.0623 **	-47.6996 **
6020.0875	-20.0000	-46.7866 **	-45.0550 **
6880.1000	-20.0000	-44.7787 **	-45.5947 **
7740.1125	-20.0000	-43.4775 **	-42.5088 **
8600.1250	-20.0000	-44.0906 **	-44.0682 **

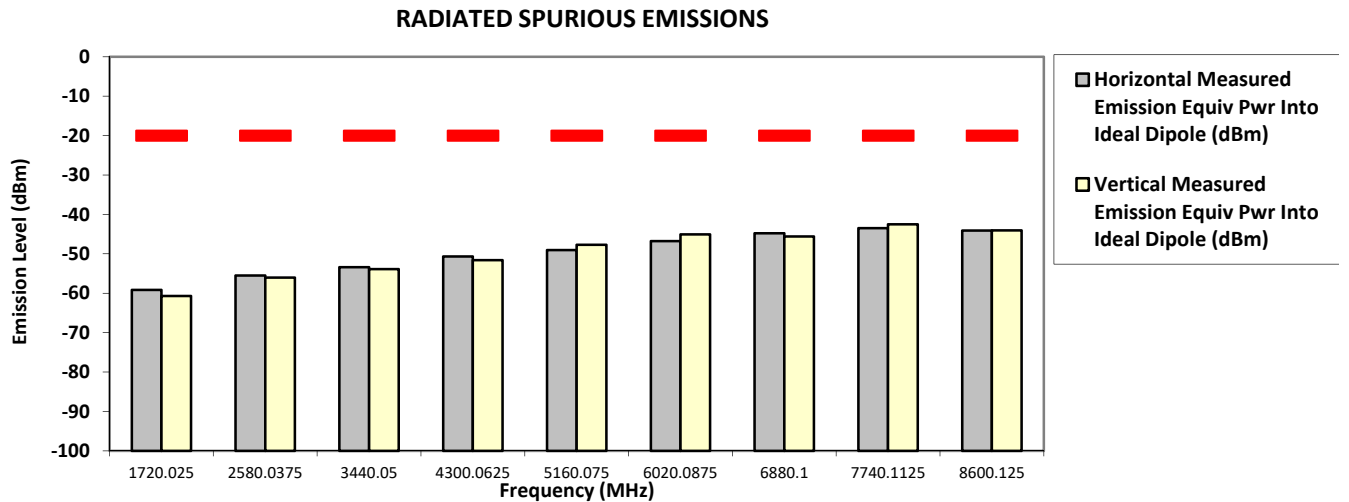

The data presented here was taken using the substitution method as found in the ANSI C63.26-2015 document.
 Motorola Penang EMC Lab - Test Performed by: Aiman & Azil Sun, 10 Apr, 2022

Remarks: ** Indicates the spurious emission could not be detected due to noise limitations or ambient.
 *Pursuant to CFR 47 Part 2.1057 (c), emissions attenuated more than 20 dB below the permissible limit are not reported
 Temp(Deg): 22.1 Hum(%RH): 53.4

Remarks: Passed Results Marginal Results Failed Results

SAC Transmitter Radiated Emission:

Model Number: AAH90UCU9RH1AN S/N: 734TYF0065 SR:27331-EMC-00022
 Battery Part No: PMNN4805A Accy Part No: N/A
 Test Mode: TX Digital
 868.887500 MHz 12.5 kHz 3.000 Watt(s) /Max Power

Frequency (MHz)	Limit	Horizontal Measured Emission Equiv Pwr Into Ideal Dipole (dBm)	Vertical Measured Emission Equiv Pwr Into ideal Dipole (dBm)
1737.7750	-20.0000	-60.1229 **	-59.8687 **
2606.6625	-20.0000	-56.5602 **	-55.6675 **
3475.5500	-20.0000	-53.4381 **	-52.3785 **
4344.4375	-20.0000	-51.9616 **	-50.2893 **
5213.3250	-20.0000	-48.7968 **	-49.2446 **
6082.2125	-20.0000	-46.1227 **	-47.0729 **
6951.1000	-20.0000	-44.7938 **	-45.3911 **
7819.9875	-20.0000	-42.5798 **	-44.1413 **
8688.8750	-20.0000	-42.2289 **	-42.9672 **

RADIATED SPURIOUS EMISSIONS

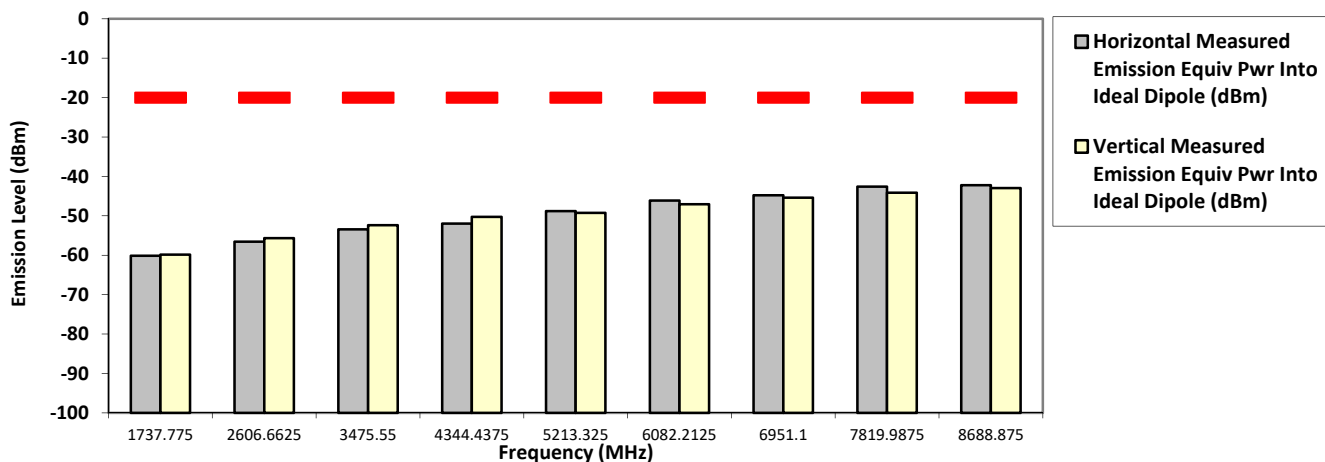

The data presented here was taken using the substitution method as found in the ANSI C63.26-2015 document.
 Motorola Penang EMC Lab - Test Performed by: Aiman & Azil Sun, 10 Apr, 2022

Remarks: ** Indicates the spurious emission could not be detected due to noise limitations or ambient.
 *Pursuant to CFR 47 Part 2.1057 (c), emissions attenuated more than 20 dB below the permissible limit are not reported
 Temp(Deg): 22.1 Hum(%RH): 53.4

Remarks: Passed Results Marginal Results Failed Results

6.10.4. Test Limit

Table below summarized the power of any emission outside a licensee’s frequency block shall be attenuated below the transmitter power (P) by at least

Channel Spacing	Part 22	Part 24D	Part 74	Part 80	Part 90 (UHF, VHF, 800, 900)	Part 90 (700)
12.5kHz	43 + log ₁₀ (P) (-13 dBm)	43 + log ₁₀ (P) (-13 dBm)	43 + log ₁₀ (P) (-13 dBm)	Not Applicable	50 + log ₁₀ (P) (-20 dBm)	43 + log ₁₀ (P) (-13 dBm)
25kHz		Not Applicable		43 + log ₁₀ (P) (-13 dBm)	43 + log ₁₀ (P) (-13 dBm)	43 + log ₁₀ (P) (-13 dBm)

Channel Spacing	RSS 134	RSS 182	RSS 119 (UHF, VHF, 800, 900)	RSS 119 (700)
12.5kHz	43 + log ₁₀ (P) (-13 dBm)	Not Applicable	50 + log ₁₀ (P) (-20 dBm)	43 + log ₁₀ (P) (-13 dBm)
25kHz	Not Applicable	43 + log ₁₀ (P) (-13 dBm)	43 + log ₁₀ (P) (-13 dBm)	43 + log ₁₀ (P) (-13 dBm)

6.11. Effective Radiated Power (ERP)

6.11.1. Test Setup

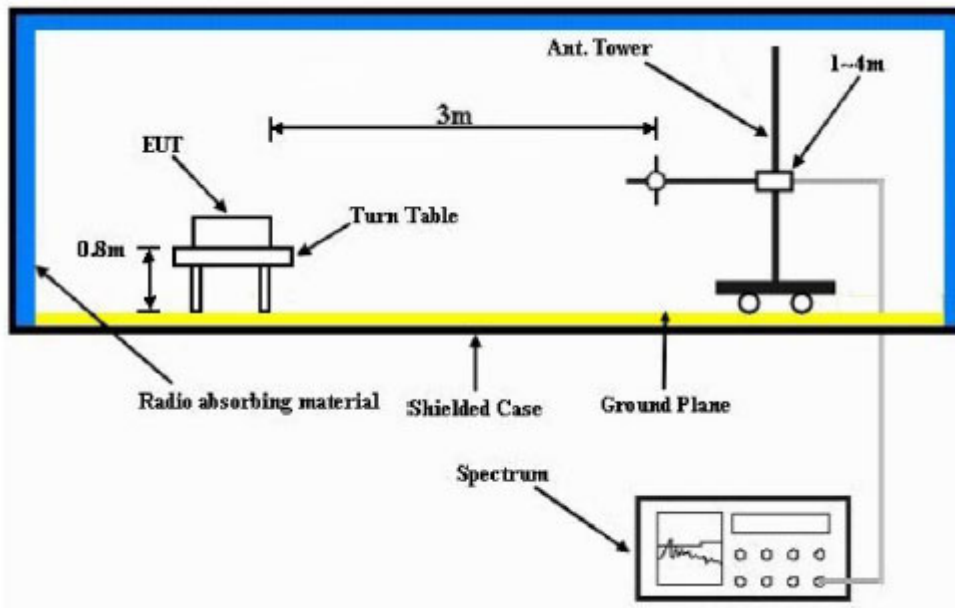

- 1) The Resolution Bandwidth for Equivalent Radiated Power (ERP) below 1 GHz is 100 kHz with Video Bandwidth = 300 kHz and Resolution Bandwidth for EIRP above 1 GHz is 1 MHz with Video Bandwidth = 3 MHz. Detector Mode is RMS.
- 2) In the semi-anechoic chamber, setup as illustrated above the DUT placed on the 0.8m height (for $f_c < 1\text{GHz}$) or 1.5m (for $f_c > 1\text{GHz}$) of Turn Table, rotated the table 45 degree each interval to search the maximum radiation power and receiver antenna shall be rotated vertical and horizontal polarization and moved height from 1m to 4m to find the maximum polar radiated power for each degree interval. The “Read Value” is the spectrum reading of maximum power value.
- 3) The substitution antenna is substituted for DUT at the same position and signals generator (S.G) export the CW signal to the substitution antenna via a TX cable. The receiver antenna shall be rotated vertical and horizontal polarization and moved height from 1m to 4m to find the maximum radiation power. Record the power level of maximum radiation power from spectrum. So, the Measured substitution value = Ref level of S.G + TX cables loss – Substituted Antenna Gain.

6.11.2. Test Result

Not Applicable.

6.11.3. Test Limit

The maximum output power of the transmitter for mobile stations is 100 watts (20 dB). Power is given in terms of effective radiated power (ERP).

6.12. GNSS (EIRP for 1559 - 1610MHz)

6.12.1. Test Setup

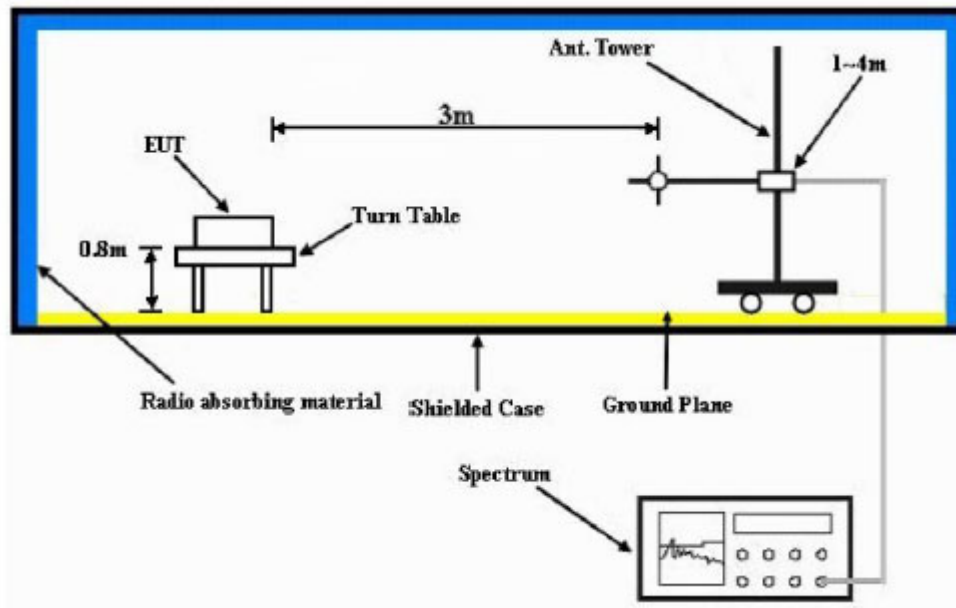

- 4) The Resolution Bandwidth for Equivalent Isotropically Radiated Power (EIRP) below 1 GHz is 100 kHz with Video Bandwidth = 300 kHz and Resolution Bandwidth for EIRP above 1 GHz is 1 MHz with Video Bandwidth = 3 MHz. Detector Mode is RMS.
- 5) In the semi-anechoic chamber, setup as illustrated above the DUT placed on the 0.8m height of Turn Table, rotated the table 45 degree each interval to search the maximum radiation power and receiver antenna shall be rotated vertical and horizontal polarization and moved height from 1m to 4m to find the maximum polar radiated power for each degree interval. The “Read Value” is the spectrum reading of maximum power value.
- 6) The substitution antenna is substituted for DUT at the same position and signals generator (S.G) export the CW signal to the substitution antenna via a TX cable. The receiver antenna shall be rotated vertical and horizontal polarization and moved height from 1m to 4m to find the maximum radiation power. Record the power level of maximum radiation power from spectrum. So, the Measured substitution value = Ref level of S.G + TX cables loss – Substituted Antenna Gain.
- 7) $EIRP = \text{“Read Value”} + \text{Measured substitution value} + 2.15$.

6.12.1. Test Result

Not Applicable.

6.12.2. Test Limit

For operations in the 758-775 MHz and 788-805 MHz bands, all emissions including harmonics in the band 1559-1610 MHz shall be limited to -70 dBW/MHz equivalent isotropically radiated power (EIRP) for wideband signals, and -80 dBW EIRP for discrete emissions of less than 700 Hz bandwidth.

~ End of Test Report ~