

**6.5.5. Test Limit**

The 99% occupied bandwidth is the width of a frequency band such that, below the lower and above the upper frequency limits, the mean powers emitted are each equal to a specified percentage 0.5% of the total mean transmitted power.



## 6.6. Band Edge Conducted Spurious Emission (Part 22)

### 6.6.1. Test Setup (Analog)

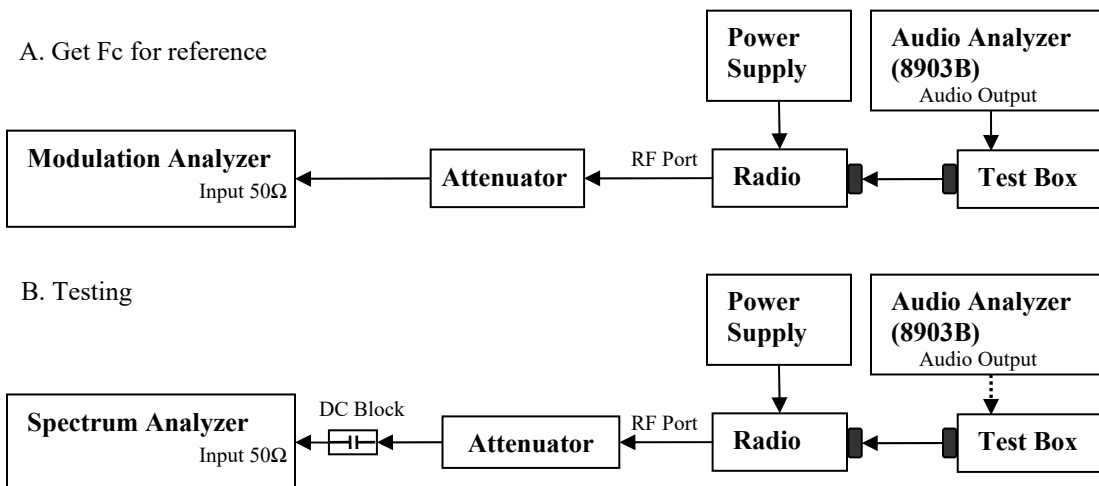

- 1) The DUT transmitter output port was connected to Modulation Analyzer.
- 2) Set the audio bandwidth filter to 15 kHz low pass filter and 50 kHz high pass filter.
- 3) Transmit the radio and set the audio analyzer to 2.5 kHz audio frequency and 50% of the rated deviation. Up the amplitude by 16 dB. Dekey the DUT.
- 4) Path loss for the measurement included.
- 5) Select the Occupied Bandwidth measurement for 99% and 26dB Emissions Bandwidth Measurement.
- 6) Key in the Fc and Resolution Bandwidth.
- 7) Transmit the DUT and record the occupied Bandwidth frequencies.
- 8) Preset the spectrum analyzer for band edge measurement.
- 9) The band edges of lowest and highest channels were measured.
- 10) Key in the Lowest and highest channel frequency, span is 60 kHz and Resolution Bandwidth is at least 1% of Emission Bandwidth.
- 11) Save the screen shot as modulated signal.
- 12) Remove the audio tone from audio analyzer to capture unmodulated signal.

\*Note:

- For emission designator ending with F3E, 16K0F3E is the worst case and therefore only 16K0F3E will be shown.

### 6.6.2. Test Result (Analog)

**Not Applicable.**

### 6.6.3. Test Setup (Digital)

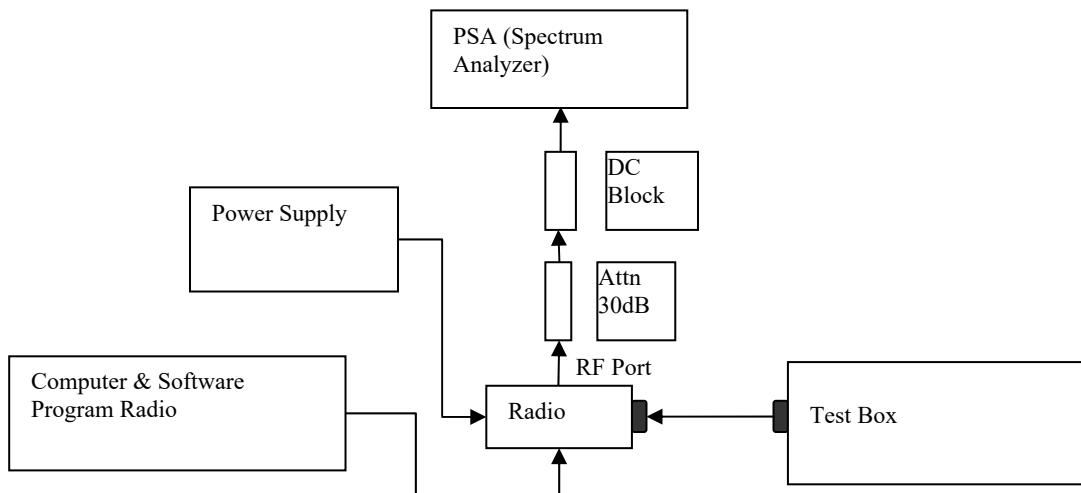

- 1) Program and set radio to operate in desire test frequency and digital mode with modulation. (\*4FSK, C4FM or other digital modulation form).
- 2) Path loss for the measurement included.
- 3) Select the Occupied Bandwidth measurement for 99% and 26dB Emissions Bandwidth Measurement.
- 4) Key in the Fc and Resolution Bandwidth.
- 5) Transmit radio record the occupied Bandwidth frequencies.
- 6) Preset the spectrum analyzer for band edge measurement.
- 7) Key in the lowest and highest channels frequency, span is 60 kHz and Resolution Bandwidth is at least 1% of Emission Bandwidth.
- 8) Save the screen shot.

\*Note:

- For Digital Modulation, 12.5 kHz Data F1D & FXD would be the same. Therefore only measurements with F1D modulation shown below.
- For Digital Modulation, 12.5 kHz Data F1E & FXE would be the same. Therefore only measurements with F1E modulation shown below.

### 6.6.4. Test Result (Digital)

**Not Applicable**

### 6.6.5. Test Limit

The power of any emission outside of the authorized operating frequency ranges must be attenuated below the transmitting power (P) by a factor of at least  $43 + 10 \log(P)$  dB.

## 6.7. Transient Frequency Behavior

### 6.7.1. Test Setup

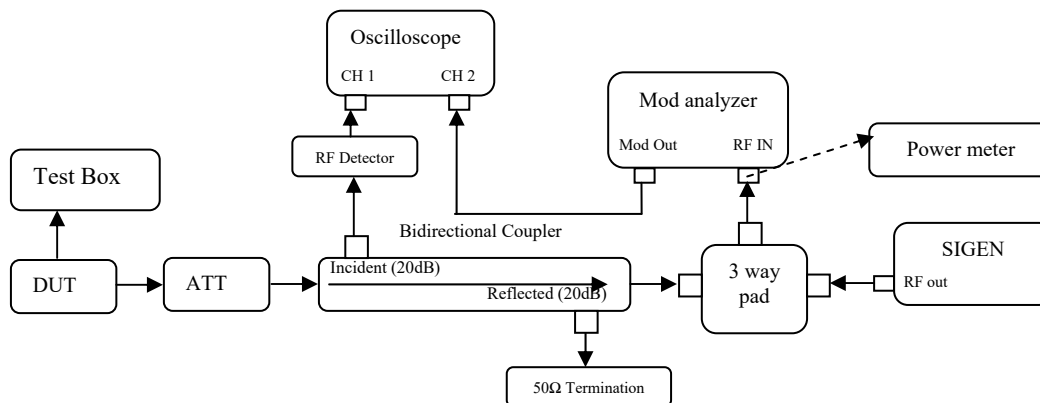

- 1) Connect the setup as figure above.
- 2) Path loss for the measurement included.
- 3) Set on Sigen with the assigned center frequency, internal 1 kHz FM tone.  
FM Deviation: Analog 25kHz Channel Spacing = 25 kHz  
Analog 12.5 kHz Channel Spacing = 12.5 kHz  
C4FM = 12.5 kHz
- 4) Turn on 50 kHz high pass filter and 15 kHz low pass filter on modulation analyzer.
- 5) Supply sufficient attenuation ATT to provide the output power of  $\leq -11$ dBm into power meter when DUT is keying up.
- 6) Note the power level on power meter and dekey the DUT.
- 7) Adjust the amplitude of the signal generator to the level power meter, maintained the amplitude throughout the rest of the measurement.
- 8) Connect the output to modulation analyzer.
- 9) Reduce 30dB attenuation and transmit the radio to get the trigger line.
- 10) Capture the screen shot for key-up (rising edge) and de-key (falling edge) mode.

### 6.7.2. Test Result

**Not Applicable**

### 6.7.3. Test Limit

Transmitters designed to operate in the 150-174 MHz and 421-512 MHz frequency bands must maintain transient frequencies within the maximum frequency difference limits during the time intervals indicated:

| Time intervals <sup>1 2</sup>   | Maximum frequency difference <sup>3</sup> | All equipment  |                |
|---|---|----------------|----------------|
|   |   | 150 to 174 MHz | 421 to 512 MHz |
| Transient Frequency Behavior for Equipment Designed to Operate on 25 kHz Channels   |   |                |                |
| t <sub>1</sub> <sup>4</sup>   | ±25.0 kHz                                 | 5.0 ms         | 10.0 ms        |
| t <sub>2</sub>  | ±12.5 kHz                                 | 20.0 ms        | 25.0 ms        |
| t <sub>3</sub> <sup>4</sup>   | ±25.0 kHz                                 | 5.0 ms         | 10.0 ms        |
| Transient Frequency Behavior for Equipment Designed to Operate on 12.5 kHz Channels |   |                |                |
| t <sub>1</sub> <sup>4</sup>   | ±12.5 kHz                                 | 5.0 ms         | 10.0 ms        |
| t <sub>2</sub>  | ±6.25 kHz                                 | 20.0 ms        | 25.0 ms        |
| t <sub>3</sub> <sup>4</sup>   | ±12.5 kHz                                 | 5.0 ms         | 10.0 ms        |
| Transient Frequency Behavior for Equipment Designed to Operate on 6.25 kHz Channels |   |                |                |
| t <sub>1</sub> <sup>4</sup>   | ±6.25 kHz                                 | 5.0 ms         | 10.0 ms        |
| t <sub>2</sub>  | ±3.125 kHz                                | 20.0 ms        | 25.0 ms        |
| t <sub>3</sub> <sup>4</sup>   | ±6.25 kHz                                 | 5.0 ms         | 10.0 ms        |

<sup>1</sup> t<sub>on</sub> is the instant when a 1 kHz test signal is completely suppressed, including any capture time due to phasing.

t<sub>1</sub> is the time period immediately following t<sub>on</sub>.

t<sub>2</sub> is the time period immediately following t<sub>1</sub>.

t<sub>3</sub> is the time period from the instant when the transmitter is turned off until t<sub>off</sub>.

t<sub>off</sub> is the instant when the 1 kHz test signal starts to rise.

<sup>2</sup> During the time from the end of t<sub>2</sub> to the beginning of t<sub>3</sub>, the frequency difference must not exceed the limits specified in §90.213.

<sup>3</sup> Difference between the actual transmitter frequency and the assigned transmitter frequency.

<sup>4</sup> If the transmitter carrier output power rating is 6 watts or less, the frequency difference during this time period may exceed the maximum frequency difference for this time period.

## 6.8. Adjacent Channel Power

### 6.8.1. Test Setup (Analog)

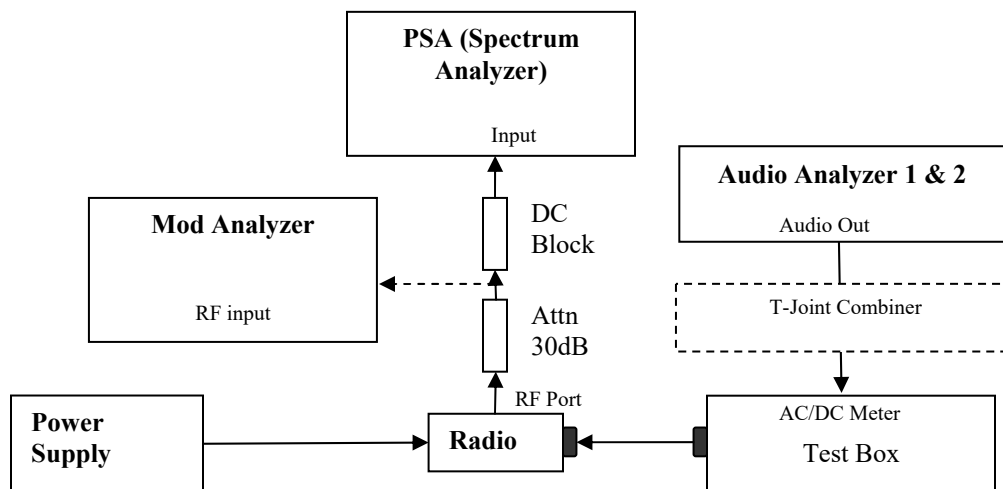

- 1) The DUT transmitter output port was connected to modulation analyzer.
- 2) Transmit the radio and turn on 1<sup>st</sup> audio analyzer with audio frequency 650Hz, 50% rated deviation, and record the amplitude value as AmpT1.
- 3) Turn off Audio analyzer 1 and turn on audio analyzer 2, set the audio frequency to 2.2 kHz and 50% deviation. Record the amplitude as AmpT2.
- 4) Turn both audio analyzers ON and up 10dB amplitude level.
- 5) Connect the output to PSA and set to assigned center frequency.
- 6) Set Span, Resolution Bandwidth and Video Bandwidth per rules part.
- 7) Transmit the radio and record the Adjacent Channel Power value in dBc.

### 6.8.2. Test Result

**Not Applicable**

### 6.8.3. Test Setup (Digital)

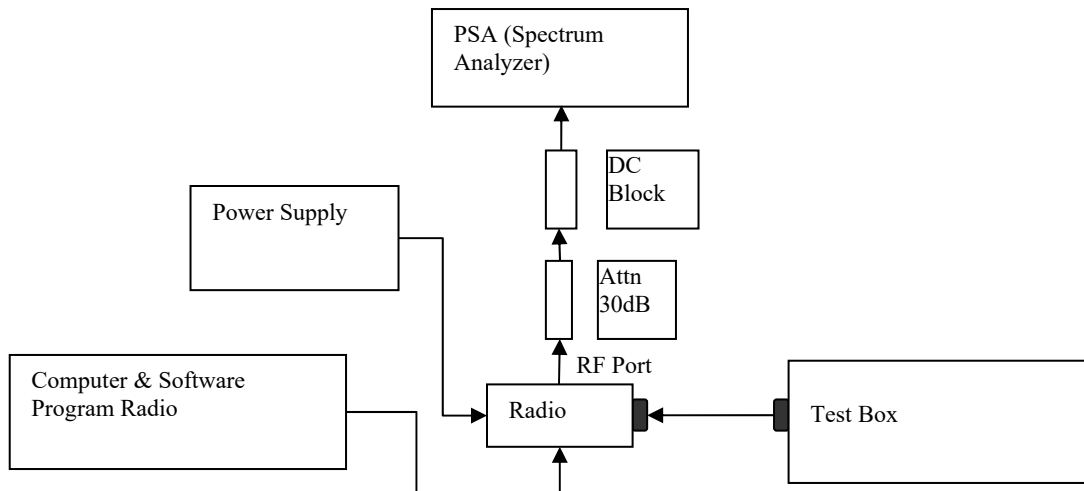

- 1) Program and set radio to operate in desire test frequency and digital mode with modulation. (4FSK, C4FM or other digital modulation form).
- 2) Prepare setup as per picture.
- 3) Turn on the ACP Measurement – Press Measure, ACP.
- 4) Set Span, Resolution Bandwidth and Video Bandwidth as per rules part.
- 5) Transmit the radio and record the Adjacent Channel Power value in dBc.

### 6.8.4. Test Result

**Not Applicable**

### 6.8.5. Test Limit

#### 12.5 kHz MOBILE TRANSMITTER ACP REQUIREMENTS

| Offset from center frequency (kHz) | Measurement bandwidth (kHz) | Maximum ACP relative (dBc) |
|------------------------------------|-----------------------------|----------------------------|
| 9.375                              | 6.25                        | -40                        |
| 15.625                             | 6.25                        | -60                        |
| 21.875                             | 6.25                        | -60                        |
| 37.50                              | 25.00                       | -60                        |
| 62.50                              | 25.00                       | -65                        |
| 87.50                              | 25.00                       | -65                        |
| 150.00                             | 100                         | -65                        |
| 250.00                             | 100                         | -65                        |
| 350.00                             | 100                         | -65                        |
| >400 to 12 MHz                     | 30 (s)                      | -75                        |
| 12 MHz to paired receive band      | 30 (s)                      | -75                        |
| In the paired receive band         | 30 (s)                      | -100                       |

#### 25 kHz MOBILE TRANSMITTER ACP REQUIREMENTS

| Offset from center frequency (kHz) | Measurement bandwidth (kHz) | Maximum ACP relative (dBc) |
|------------------------------------|-----------------------------|----------------------------|
| 15.625                             | 6.25                        | -40                        |
| 21.875                             | 6.25                        | -60                        |
| 37.50                              | 25                          | -60                        |
| 62.50                              | 25                          | -65                        |
| 87.50                              | 25                          | -65                        |
| 150.00                             | 100                         | -65                        |
| 250.00                             | 100                         | -65                        |
| 350.00                             | 100                         | -65                        |
| >400 kHz to 12 MHz                 | 30 (s)                      | -75                        |
| 12 MHz to paired receive band      | 30 (s)                      | -75                        |
| In the paired receive band         | 30 (s)                      | -100                       |

**12.5 kHz BASE TRANSMITTER ACP REQUIREMENTS**

| Offset from center frequency (kHz) | Measurement bandwidth (kHz) | Maximum ACP (dBc) |
|------------------------------------|-----------------------------|-------------------|
| 9.375                              | 6.25                        | -40               |
| 15.625                             | 6.25                        | -60               |
| 21.875                             | 6.25                        | -60               |
| 37.5                               | 25                          | -60               |
| 62.5                               | 25                          | -65               |
| 87.5                               | 25                          | -65               |
| 150                                | 100                         | -65               |
| 250                                | 100                         | -65               |
| 350.00                             | 100                         | -65               |
| >400 kHz to 12 MHz                 | 30 (s)                      | -80               |
| 12 MHz to paired receive band      | 30 (s)                      | -80               |
| In the paired receive band         | 30 (s)                      | <sup>1</sup> -85  |

**25 kHz BASE TRANSMITTER ACP REQUIREMENTS**

| Offset from center frequency (kHz) | Measurement bandwidth (kHz) | Maximum ACP (dBc) |
|------------------------------------|-----------------------------|-------------------|
| 15.625                             | 6.25                        | -40               |
| 21.875                             | 6.25                        | -60               |
| 37.5                               | 25                          | -60               |
| 62.5                               | 25                          | -65               |
| 87.5                               | 25                          | -65               |
| 150                                | 100                         | -65               |
| 250                                | 100                         | -65               |
| 350                                | 100.00                      | -65               |
| >400 kHz to 12 MHz                 | 30 (s)                      | -80               |
| 12 MHz to paired receive band      | 30 (s)                      | -80               |
| In the paired receive band         | 30 (s)                      | <sup>1</sup> -85  |



## 6.9. Conducted Spurious Emission

### 6.9.1. Test Setup

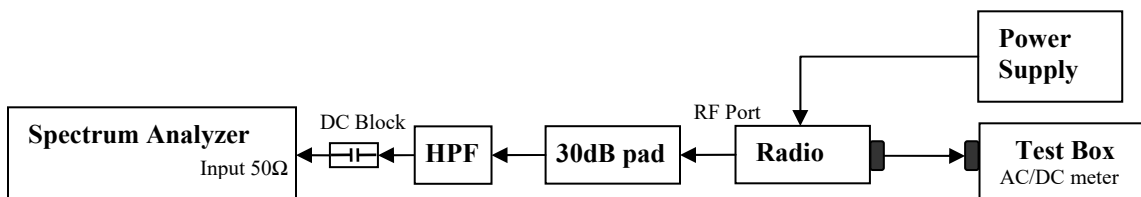

- 1) The DUT transmitter output port was connected to Spectrum Analyzer with above setup.
- 2) Program and set radio to operate in desire test frequency and mode. (Analog / digital modulation form).
- 3) Path loss for the measurement included.
- 4) Set the PSA Resolution Bandwidth as per rules part.
- 5) Set the Ref offset from the pathloss offset calibration file.
- 6) Adjust the center frequency of the spectrum analyzer for incremental coverage of the range from:
  - a. 9 KHz to  $F_c - \text{Test Bandwidth}$
  - b.  $F_c + \text{Test Bandwidth}$  to  $2F_c - 5\text{MHz}$ .
- 7) Key up the DUT, Peak Search the highest Spur and record the levels of spurious emissions
- 8) Dekey the DUT.
- 9) Turn On High Pass Filter path and Key up the DUT.
- 10) Adjust the PSA Freq for incremental coverage of range from  $2F_c$  to  $10F_c$
- 11) Key up the DUT and record the highest spur levels of spurious emissions.

6.9.2. Test Result (Analog)

Analog: 806.0125. MHz, 25.kHz Channel Spacing, Max. Power

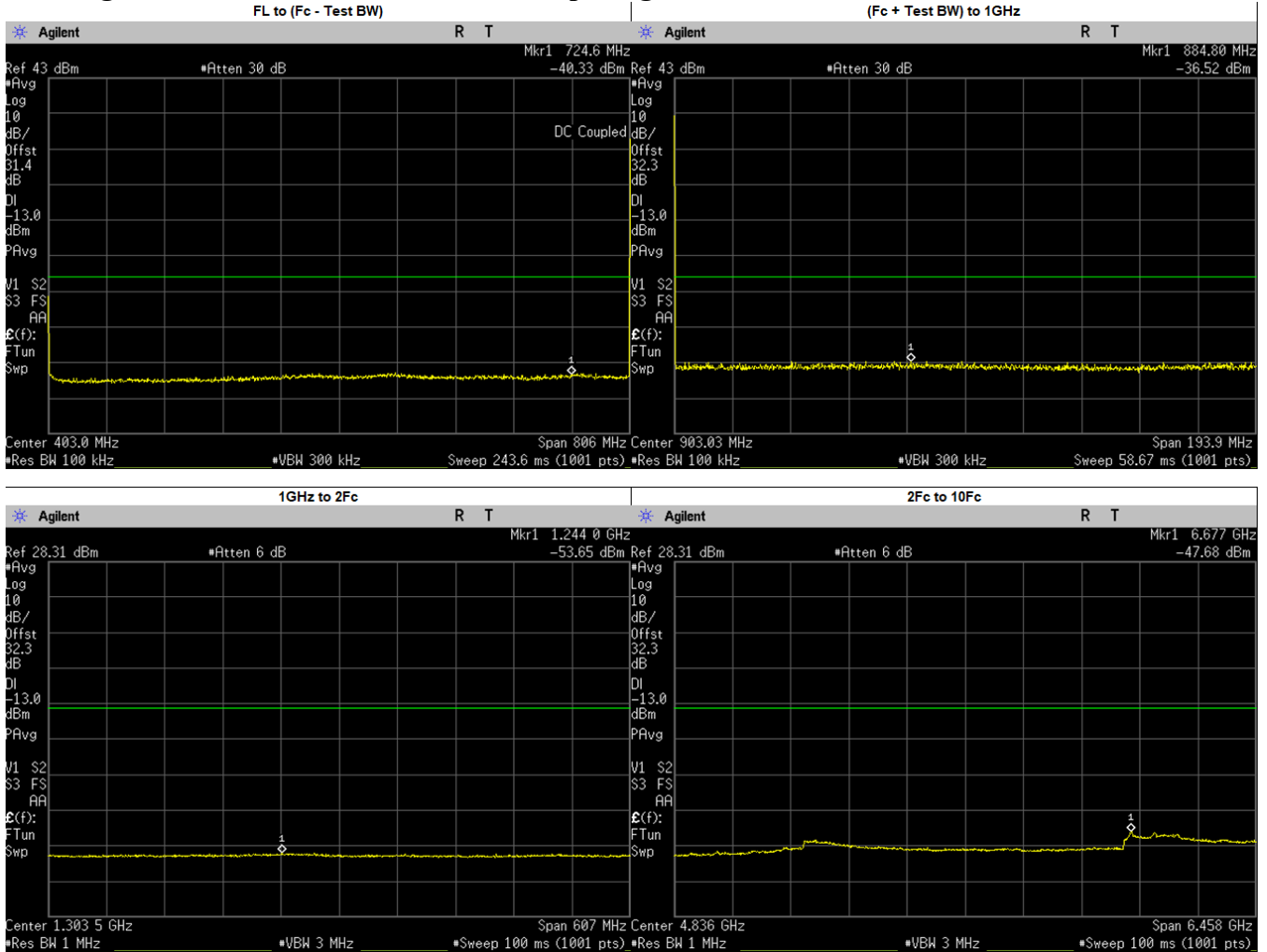

| Frequency Range        | Highest Spur Frequency (MHz) | Spurious Level (dBm) | Failing Limit (dBm) | Results |
|------------------------|------------------------------|----------------------|---------------------|---------|
| FL to (Fc - Test BW)   | 724.6000                     | -40.3340             | -13.00              | PASS    |
| (Fc + Test BW) to 1GHz | 884.8011                     | -36.5200             | -13.00              | PASS    |
| 1GHz to 2Fc            | 1244.0240                    | -53.6500             | -13.00              | PASS    |
| 2Fc to 10Fc            | 6676.6330                    | -47.6800             | -13.00              | PASS    |
|                        | 1612.0250                    | -54.4904             | -13.00              | PASS    |
|                        | 2418.0370                    | -53.7479             | -13.00              | PASS    |
|                        | 3224.0500                    | -50.8556             | -13.00              | PASS    |
|                        | 4030.0620                    | -52.5274             | -13.00              | PASS    |
|                        | 4836.0750                    | -52.7030             | -13.00              | PASS    |
|                        | 5642.0870                    | -52.9591             | -13.00              | PASS    |
|                        | 6448.1000                    | -52.5836             | -13.00              | PASS    |
|                        | 7254.1130                    | -49.7253             | -13.00              | PASS    |
| 8060.1250              | -50.5260                     | -13.00               | PASS                |         |

### Analog: 814.9875. MHz, 25.kHz Channel Spacing, Max. Power

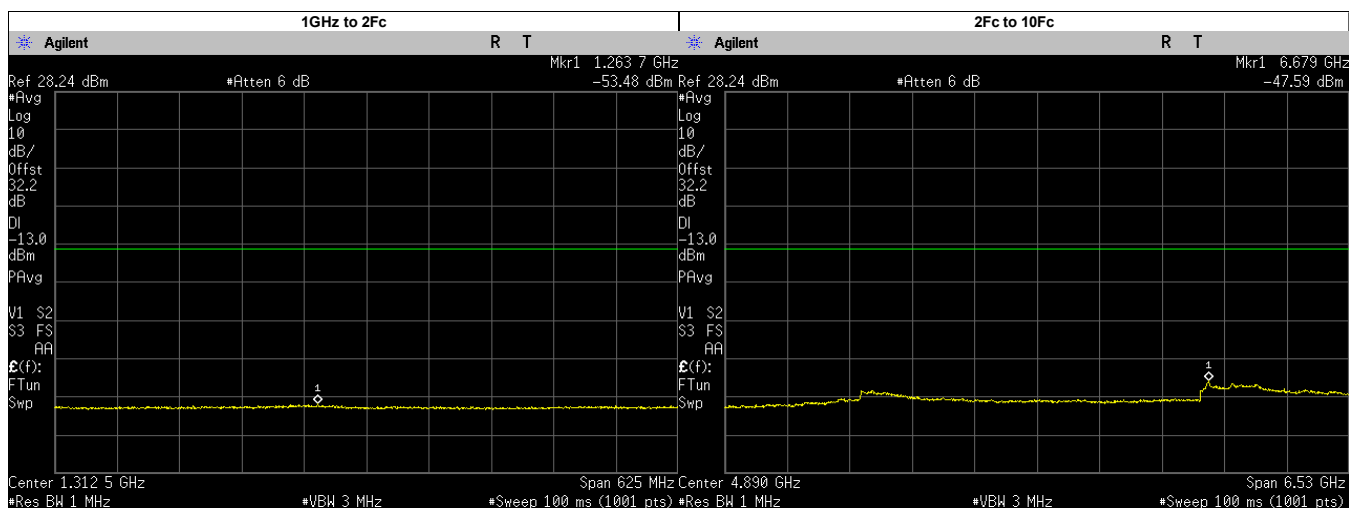
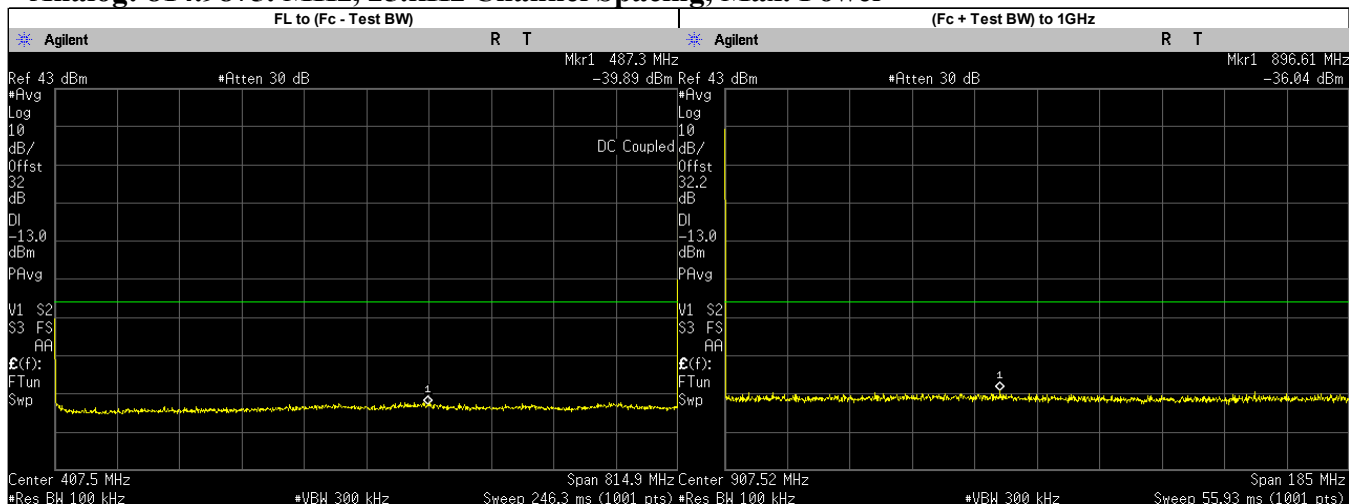

| Frequency Range        | Highest Spur Frequency (MHz) | Spurious Level (dBm) | Failing Limit (dBm) | Results |
|------------------------|------------------------------|----------------------|---------------------|---------|
| FL to (Fc - Test BW)   | 487.3000                     | -39.8940             | -13.00              | PASS    |
| (Fc + Test BW) to 1GHz | 896.6060                     | -36.0400             | -13.00              | PASS    |
| 1GHz to 2Fc            | 1263.7390                    | -53.4800             | -13.00              | PASS    |
| 2Fc to 10Fc            | 6679.1180                    | -47.5900             | -13.00              | PASS    |
|                        | 1629.9750                    | -54.4776             | -13.00              | PASS    |
|                        | 2444.9630                    | -53.6408             | -13.00              | PASS    |
|                        | 3259.9500                    | -51.0206             | -13.00              | PASS    |
|                        | 4074.9370                    | -52.5572             | -13.00              | PASS    |
|                        | 4889.9250                    | -52.8720             | -13.00              | PASS    |
|                        | 5704.9130                    | -52.7651             | -13.00              | PASS    |
|                        | 6519.9000                    | -52.6141             | -13.00              | PASS    |
| 7334.8870              | -49.8935                     | -13.00               | PASS                |         |
| 8149.8750              | -51.2166                     | -13.00               | PASS                |         |

### Analog: 823.9875. MHz, 25.kHz Channel Spacing, Max. Power

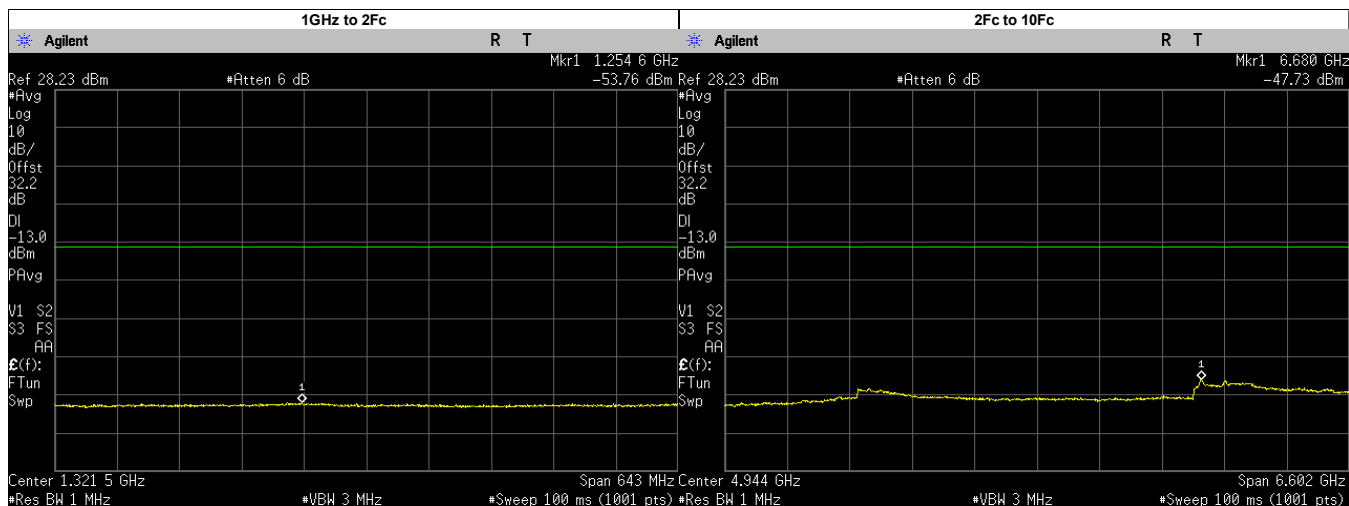
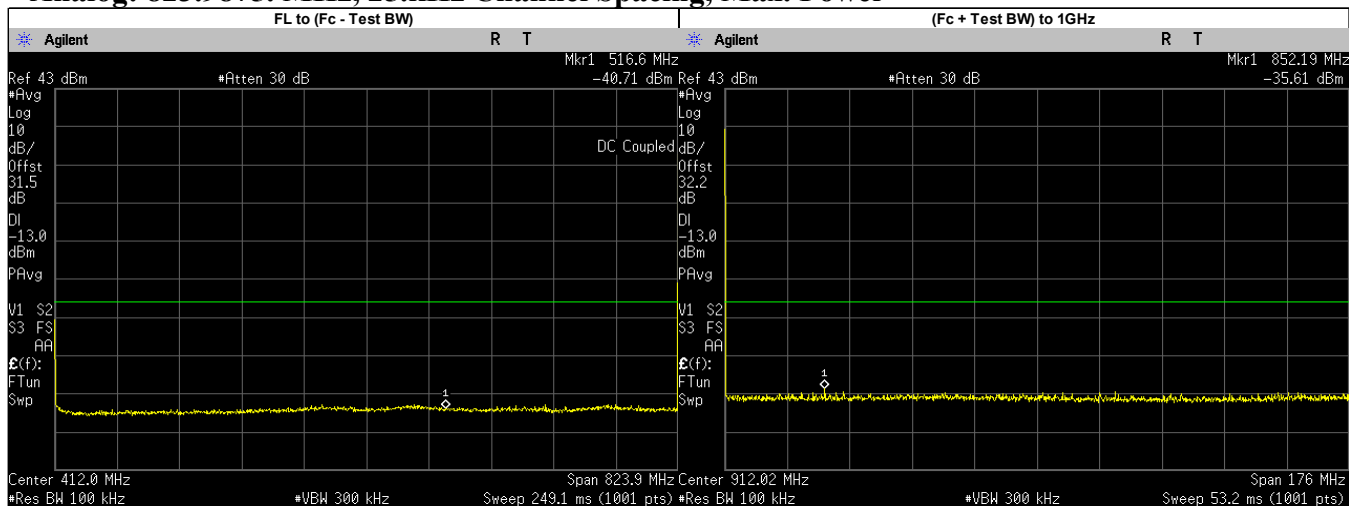

| Frequency Range        | Highest Spur Frequency (MHz) | Spurious Level (dBm) | Failing Limit (dBm) | Results |
|------------------------|------------------------------|----------------------|---------------------|---------|
| FL to (Fc - Test BW)   | 516.6000                     | -40.7130             | -13.00              | PASS    |
| (Fc + Test BW) to 1GHz | 852.1915                     | -35.6100             | -13.00              | PASS    |
| 1GHz to 2Fc            | 1254.6180                    | -53.7600             | -13.00              | PASS    |
| 2Fc to 10Fc            | 6680.2250                    | -47.7300             | -13.00              | PASS    |
|                        | 1647.9750                    | -54.5268             | -13.00              | PASS    |
|                        | 2471.9630                    | -53.1484             | -13.00              | PASS    |
|                        | 3295.9500                    | -50.6320             | -13.00              | PASS    |
|                        | 4119.9370                    | -52.2940             | -13.00              | PASS    |
|                        | 4943.9250                    | -52.8570             | -13.00              | PASS    |
|                        | 5767.9130                    | -52.8840             | -13.00              | PASS    |
|                        | 6591.9000                    | -52.6707             | -13.00              | PASS    |
|                        | 7415.8870                    | -49.9751             | -13.00              | PASS    |
| 8239.8750              | -51.2022                     | -13.00               | PASS                |         |

### Analog: 851.0125. MHz, 25.kHz Channel Spacing, Max. Power

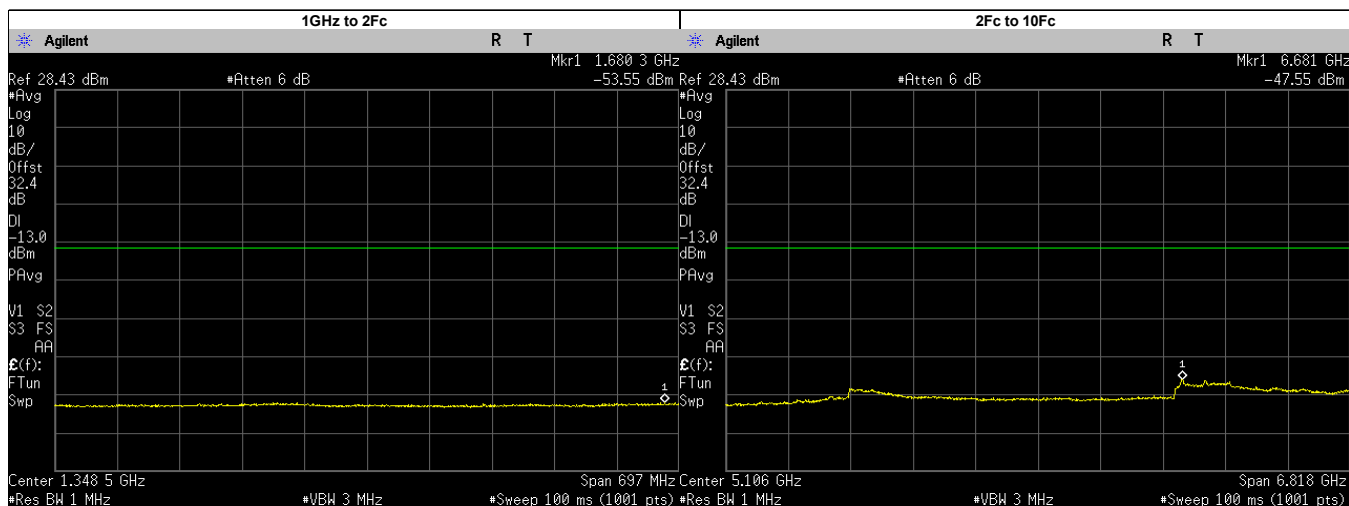
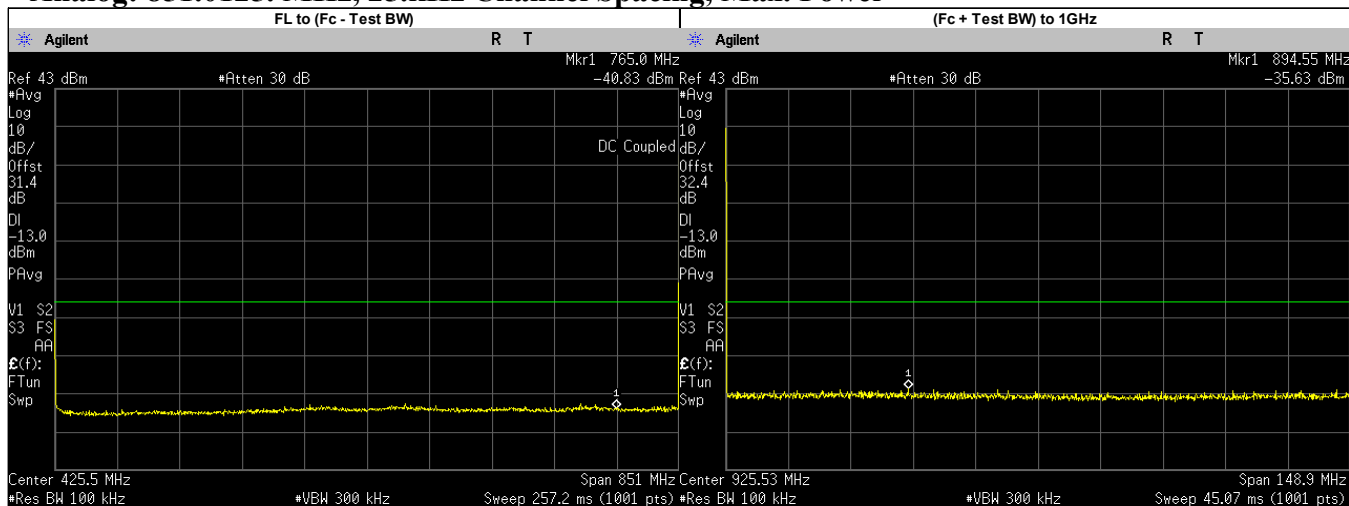

| Frequency Range        | Highest Spur Frequency (MHz) | Spurious Level (dBm) | Failing Limit (dBm) | Results |
|------------------------|------------------------------|----------------------|---------------------|---------|
| FL to (Fc - Test BW)   | 765.0000                     | -40.8330             | -13.00              | PASS    |
| (Fc + Test BW) to 1GHz | 894.5522                     | -35.6300             | -13.00              | PASS    |
| 1GHz to 2Fc            | 1680.2960                    | -53.5500             | -13.00              | PASS    |
| 2Fc to 10Fc            | 6681.0560                    | -47.5500             | -13.00              | PASS    |
|                        | 1702.0250                    | -54.1431             | -13.00              | PASS    |
|                        | 2553.0370                    | -53.3935             | -13.00              | PASS    |
|                        | 3404.0500                    | -51.0557             | -13.00              | PASS    |
|                        | 4255.0620                    | -52.6797             | -13.00              | PASS    |
|                        | 5106.0750                    | -52.8480             | -13.00              | PASS    |
|                        | 5957.0870                    | -52.9353             | -13.00              | PASS    |
|                        | 6808.1000                    | -49.2663             | -13.00              | PASS    |
|                        | 7659.1130                    | -50.0704             | -13.00              | PASS    |
| 8510.1250              | -50.4193                     | -13.00               | PASS                |         |

**Analog: 860.0125. MHz, 25.kHz Channel Spacing, Max. Power**

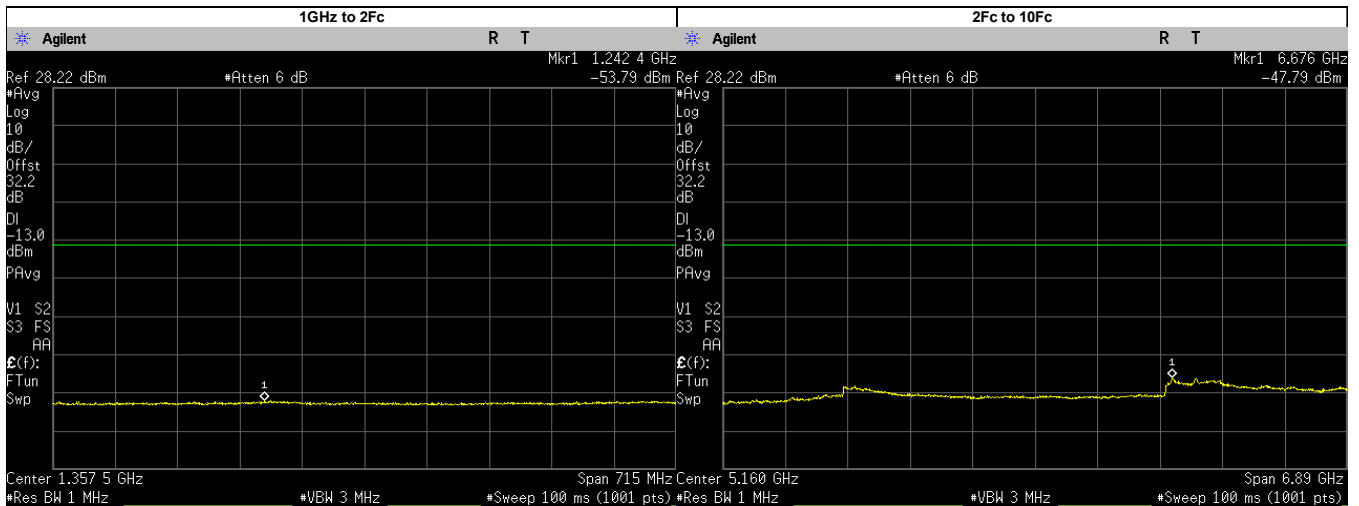
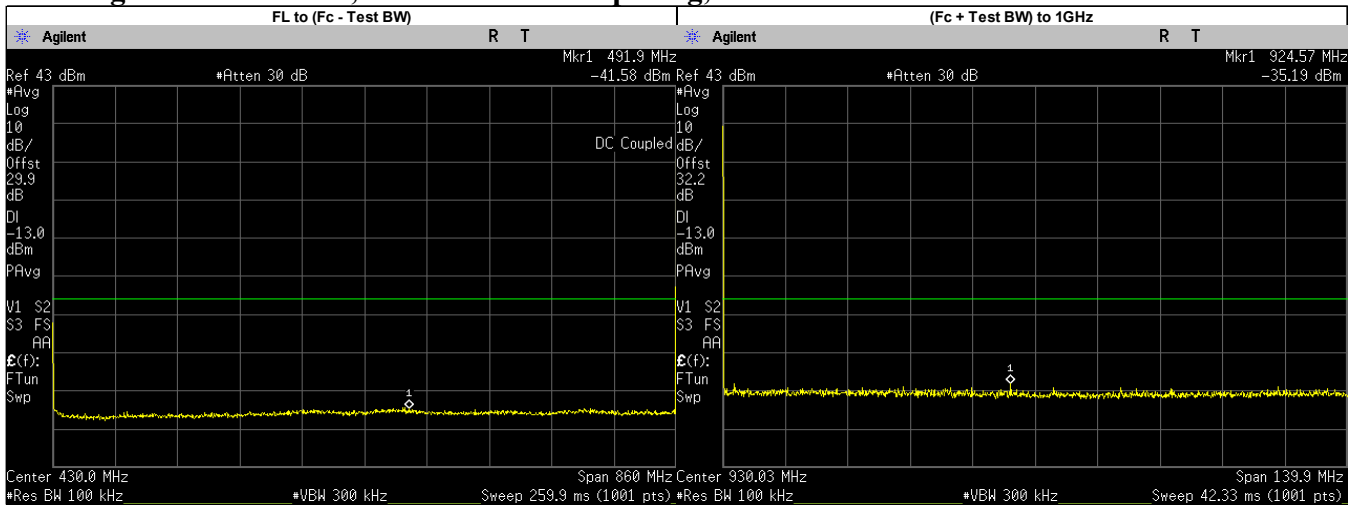

| Frequency Range        | Highest Spur Frequency (MHz) | Spurious Level (dBm) | Failing Limit (dBm) | Results |
|------------------------|------------------------------|----------------------|---------------------|---------|
| FL to (Fc - Test BW)   | 491.9000                     | -41.5750             | -13.00              | PASS    |
| (Fc + Test BW) to 1GHz | 924.5737                     | -35.1900             | -13.00              | PASS    |
| 1GHz to 2Fc            | 1242.3930                    | -53.7900             | -13.00              | PASS    |
| 2Fc to 10Fc            | 6675.8970                    | -47.7900             | -13.00              | PASS    |
|                        | 1720.0250                    | -54.3108             | -13.00              | PASS    |
|                        | 2580.0370                    | -53.4413             | -13.00              | PASS    |
|                        | 3440.0500                    | -51.4758             | -13.00              | PASS    |
|                        | 4300.0620                    | -52.7063             | -13.00              | PASS    |
|                        | 5160.0750                    | -52.9930             | -13.00              | PASS    |
|                        | 6020.0870                    | -52.7403             | -13.00              | PASS    |
|                        | 6880.1000                    | -49.6269             | -13.00              | PASS    |
| 7740.1130              | -50.3037                     | -13.00               | PASS                |         |
| 8600.1250              | -51.0238                     | -13.00               | PASS                |         |

### Analog: 868.8875. MHz, 25.kHz Channel Spacing, Max. Power

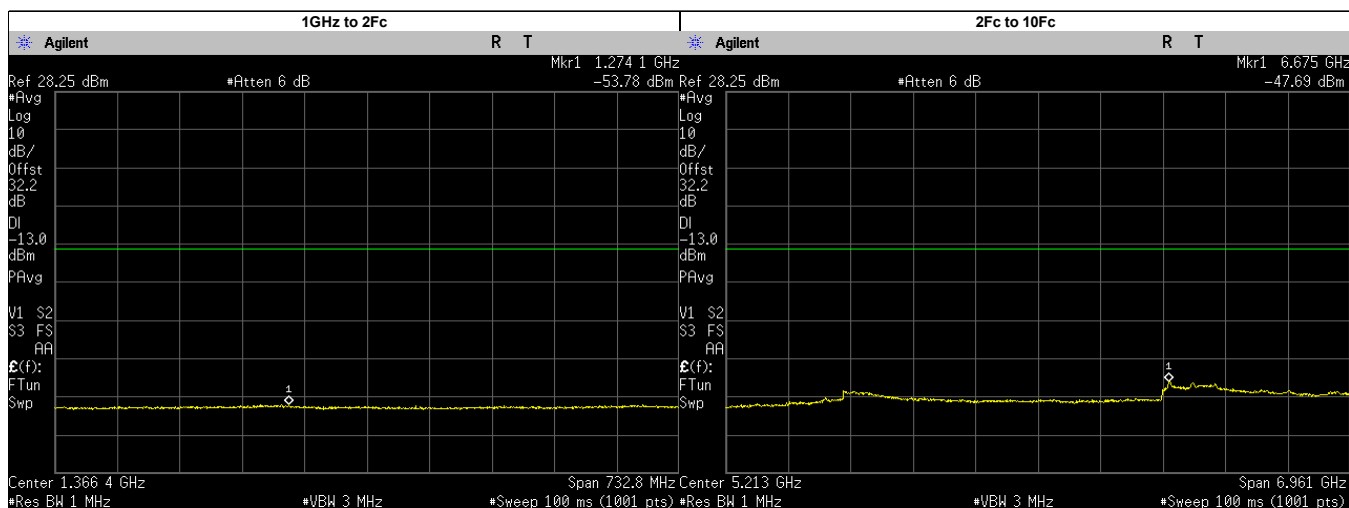
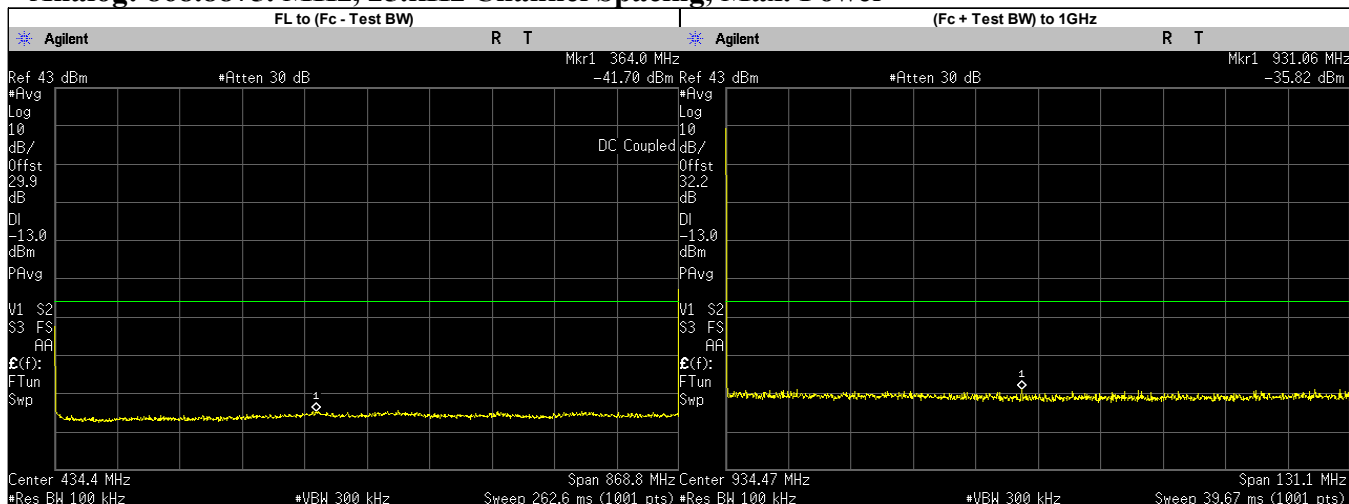

| Frequency Range        | Highest Spur Frequency (MHz) | Spurious Level (dBm) | Failing Limit (dBm) | Results |
|------------------------|------------------------------|----------------------|---------------------|---------|
| FL to (Fc - Test BW)   | 364.0000                     | -41.7000             | -13.00              | PASS    |
| (Fc + Test BW) to 1GHz | 931.0611                     | -35.8200             | -13.00              | PASS    |
| 1GHz to 2Fc            | 1274.0580                    | -53.7800             | -13.00              | PASS    |
| 2Fc to 10Fc            | 6675.1560                    | -47.7000             | -13.00              | PASS    |
|                        | 1737.7750                    | -54.4733             | -13.00              | PASS    |
|                        | 2606.6620                    | -53.2360             | -13.00              | PASS    |
|                        | 3475.5500                    | -51.4338             | -13.00              | PASS    |
|                        | 4344.4370                    | -52.5299             | -13.00              | PASS    |
|                        | 5213.3250                    | -52.8990             | -13.00              | PASS    |
|                        | 6082.2120                    | -52.9032             | -13.00              | PASS    |
|                        | 6951.1000                    | -48.4204             | -13.00              | PASS    |
|                        | 7819.9880                    | -50.5776             | -13.00              | PASS    |
|                        | 8688.8750                    | -51.0518             | -13.00              | PASS    |

### 6.9.3. Test Result (Digital)

#### Digital.: 806.0125. MHz, 12.5 kHz Channel Spacing, Max. Power

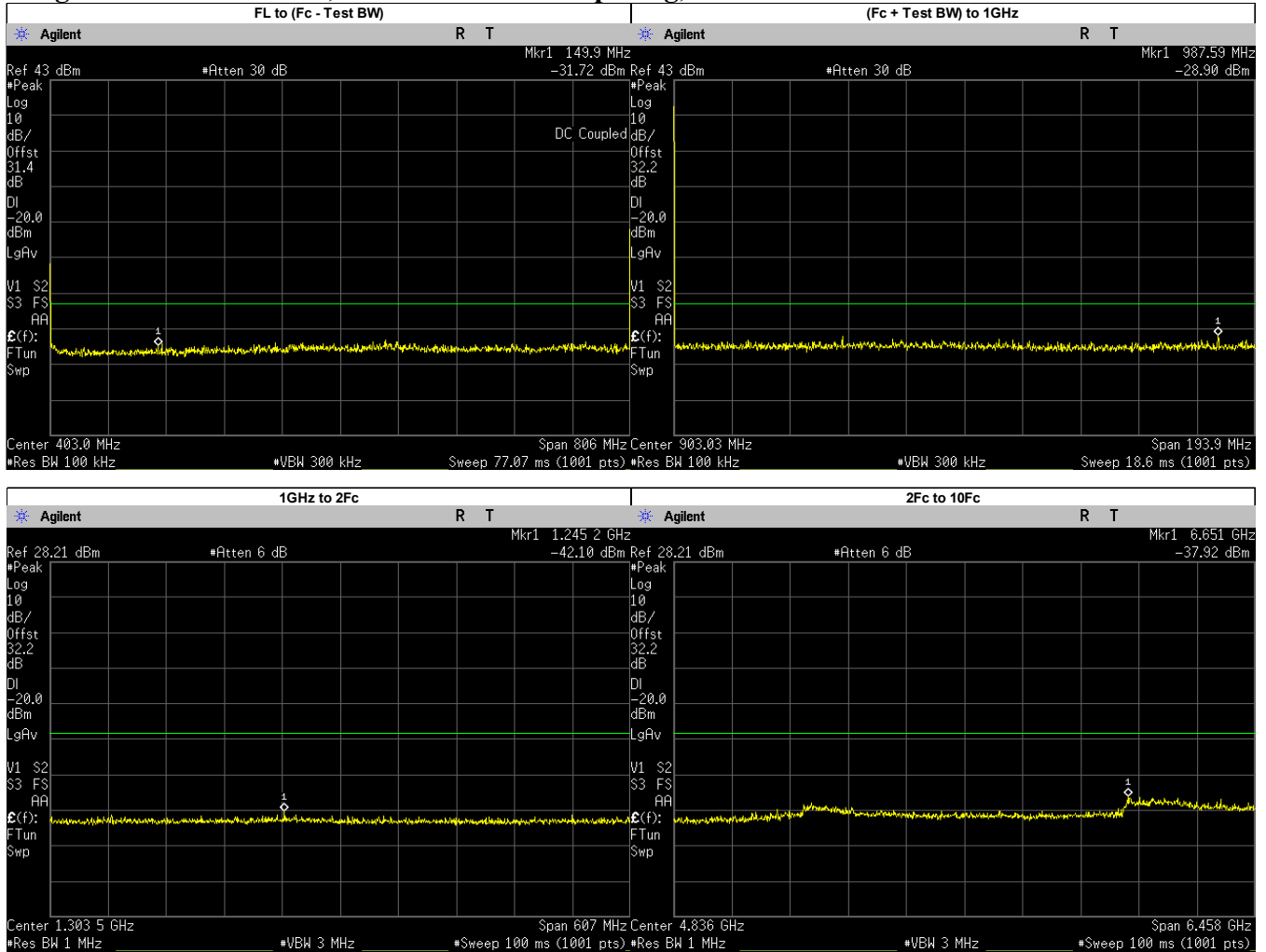

| Frequency Range        | Highest Spur Frequency (MHz) | Spurious Level (dBm) | Failing Limit (dBm) | Results |
|------------------------|------------------------------|----------------------|---------------------|---------|
| FL to (Fc - Test BW)   | 149.9000                     | -31.7150             | -20.00              | PASS    |
| (Fc + Test BW) to 1GHz | 987.5880                     | -28.9000             | -20.00              | PASS    |
| 1GHz to 2Fc            | 1245.2380                    | -42.1000             | -20.00              | PASS    |
| 2Fc to 10Fc            | 6651.0000                    | -37.9200             | -20.00              | PASS    |
|                        | 1612.0250                    | -44.8780             | -20.00              | PASS    |
|                        | 2418.0370                    | -44.4179             | -20.00              | PASS    |
|                        | 3224.0500                    | -41.4730             | -20.00              | PASS    |
|                        | 4030.0620                    | -42.7174             | -20.00              | PASS    |
|                        | 4836.0750                    | -43.5760             | -20.00              | PASS    |
|                        | 5642.0870                    | -43.8806             | -20.00              | PASS    |
|                        | 6448.1000                    | -42.7791             | -20.00              | PASS    |
|                        | 7254.1130                    | -40.5089             | -20.00              | PASS    |
| 8060.1250              | -41.5194                     | -20.00               | PASS                |         |



### Digital.: 814.9875 MHz, 12.5 kHz Channel Spacing, Max. Power

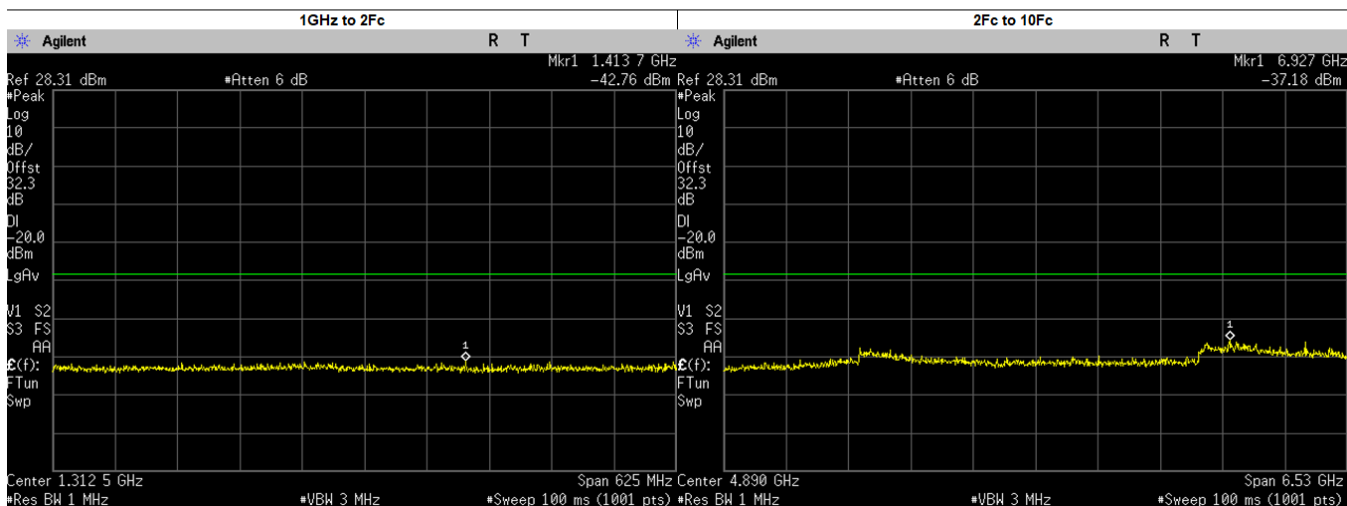
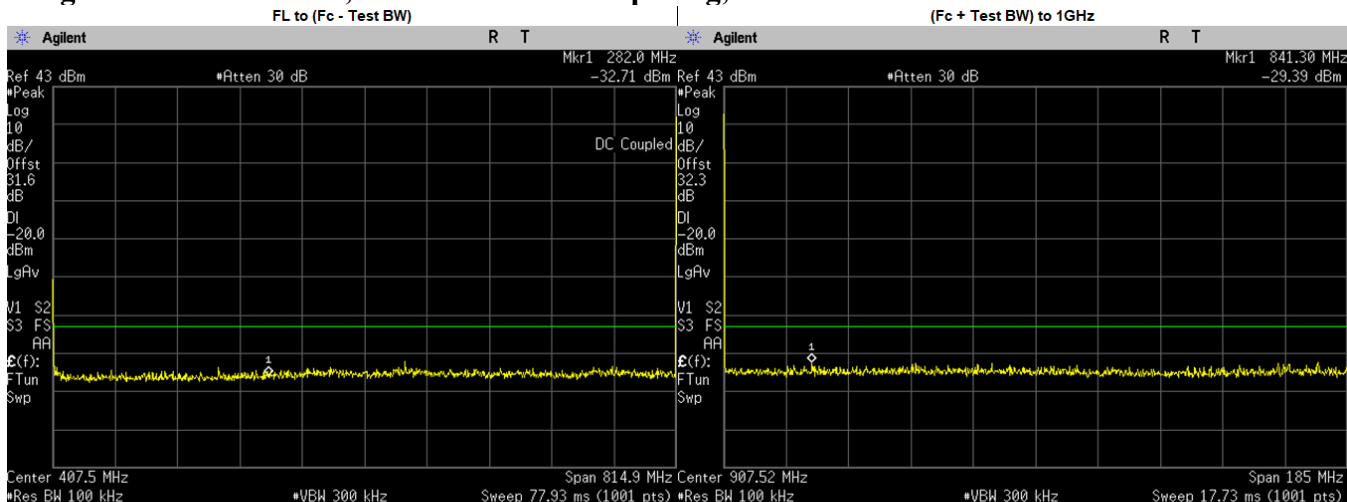

| Frequency Range        | Highest Spur Frequency (MHz) | Spurious Level (dBm) | Failing Limit (dBm) | Results |
|------------------------|------------------------------|----------------------|---------------------|---------|
| FL to (Fc - Test BW)   | 282.0000                     | -32.7100             | -20.00              | PASS    |
| (Fc + Test BW) to 1GHz | 841.3022                     | -29.3900             | -20.00              | PASS    |
| 1GHz to 2Fc            | 1413.7330                    | -42.7600             | -20.00              | PASS    |
| 2Fc to 10Fc            | 6927.0000                    | -37.1800             | -20.00              | PASS    |
|                        | 1629.9750                    | -45.0301             | -20.00              | PASS    |
|                        | 2444.9630                    | -43.9924             | -20.00              | PASS    |
|                        | 3259.9500                    | -41.6280             | -20.00              | PASS    |
|                        | 4074.9370                    | -43.0443             | -20.00              | PASS    |
|                        | 4889.9250                    | -43.9390             | -20.00              | PASS    |
|                        | 5704.9130                    | -43.5375             | -20.00              | PASS    |
|                        | 6519.9000                    | -43.0101             | -20.00              | PASS    |
|                        | 8149.8750                    | -41.6040             | -20.00              | PASS    |
|                        | 7334.8870                    | -39.9825             | -20.00              | PASS    |

### Digital.: 823.9875 MHz, 12.5 kHz Channel Spacing, Max. Power

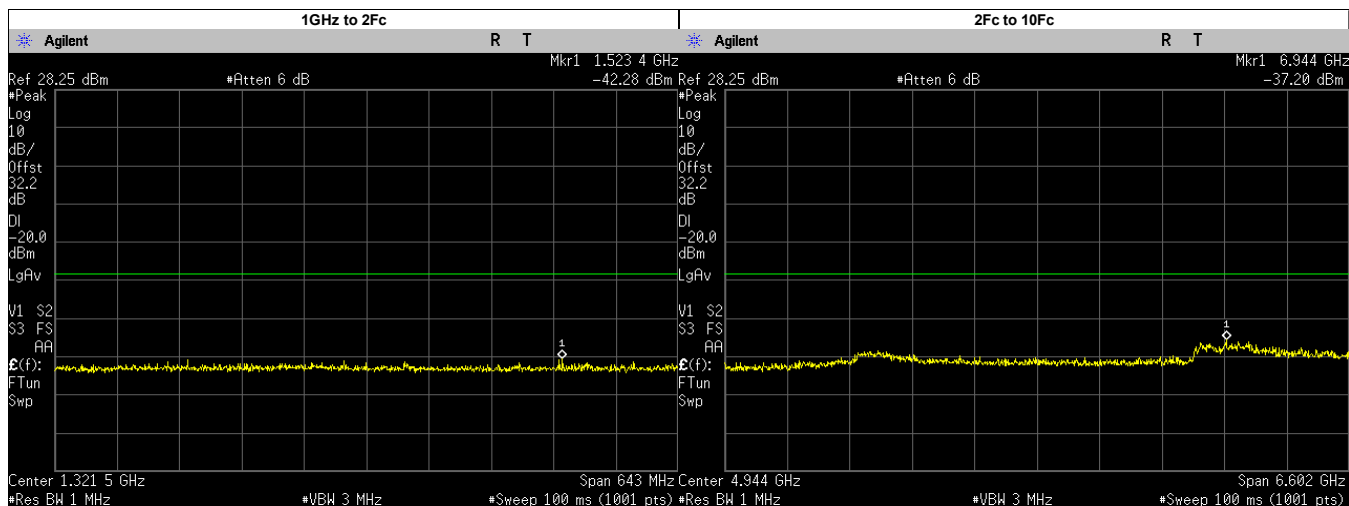
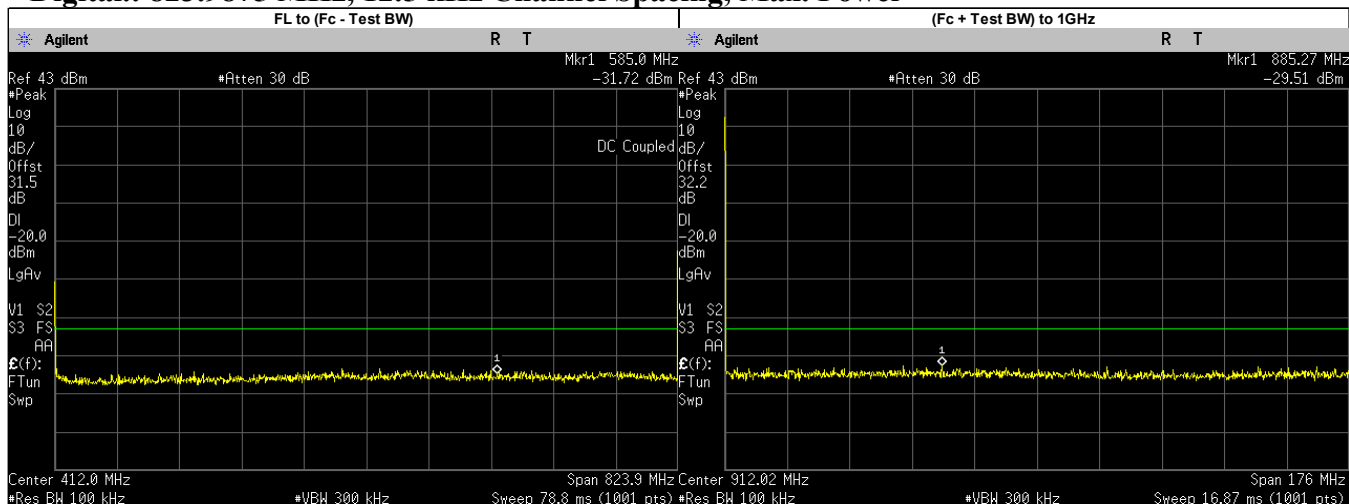

| Frequency Range        | Highest Spur Frequency (MHz) | Spurious Level (dBm) | Failing Limit (dBm) | Results |
|------------------------|------------------------------|----------------------|---------------------|---------|
| FL to (Fc - Test BW)   | 585.0000                     | -31.7160             | -20.00              | PASS    |
| (Fc + Test BW) to 1GHz | 885.2725                     | -29.5100             | -20.00              | PASS    |
| 1GHz to 2Fc            | 1523.3820                    | -42.2800             | -20.00              | PASS    |
| 2Fc to 10Fc            | 6944.0000                    | -37.2000             | -20.00              | PASS    |
|                        | 1647.9750                    | -44.1716             | -20.00              | PASS    |
|                        | 2471.9630                    | -43.3274             | -20.00              | PASS    |
|                        | 3295.9500                    | -41.3944             | -20.00              | PASS    |
|                        | 4119.9370                    | -42.2844             | -20.00              | PASS    |
|                        | 4943.9250                    | -43.2520             | -20.00              | PASS    |
|                        | 5767.9130                    | -42.5221             | -20.00              | PASS    |
|                        | 6591.9000                    | -42.5098             | -20.00              | PASS    |
| 7415.8870              | -40.5447                     | -20.00               | PASS                |         |
| 8239.8750              | -41.7835                     | -20.00               | PASS                |         |

### Digital.: 851.0125 MHz, 12.5 kHz Channel Spacing, Max. Power

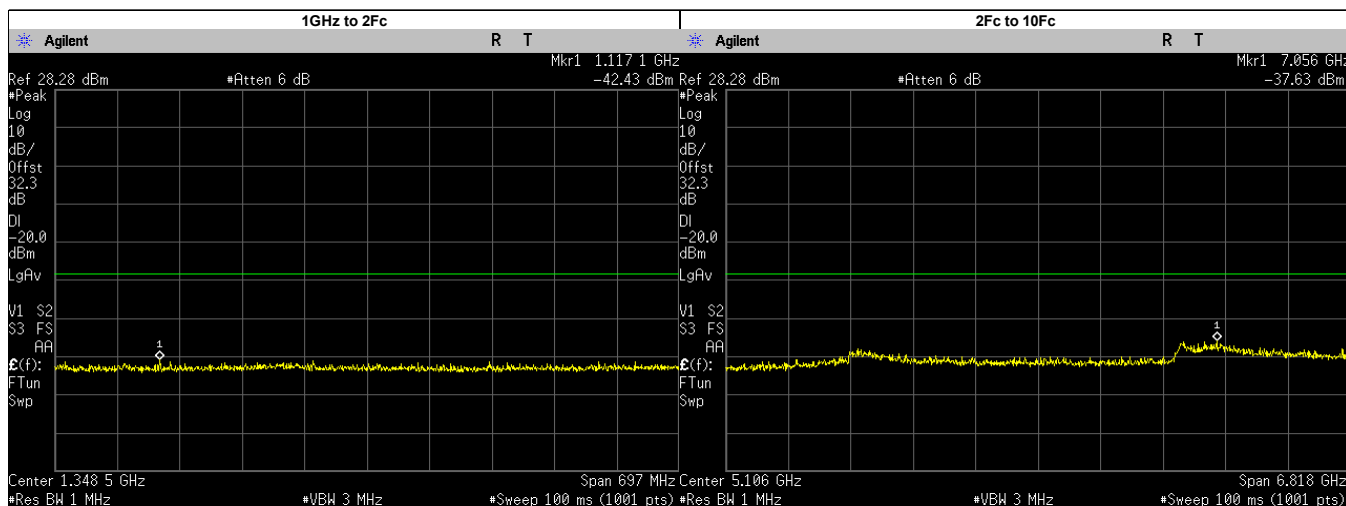
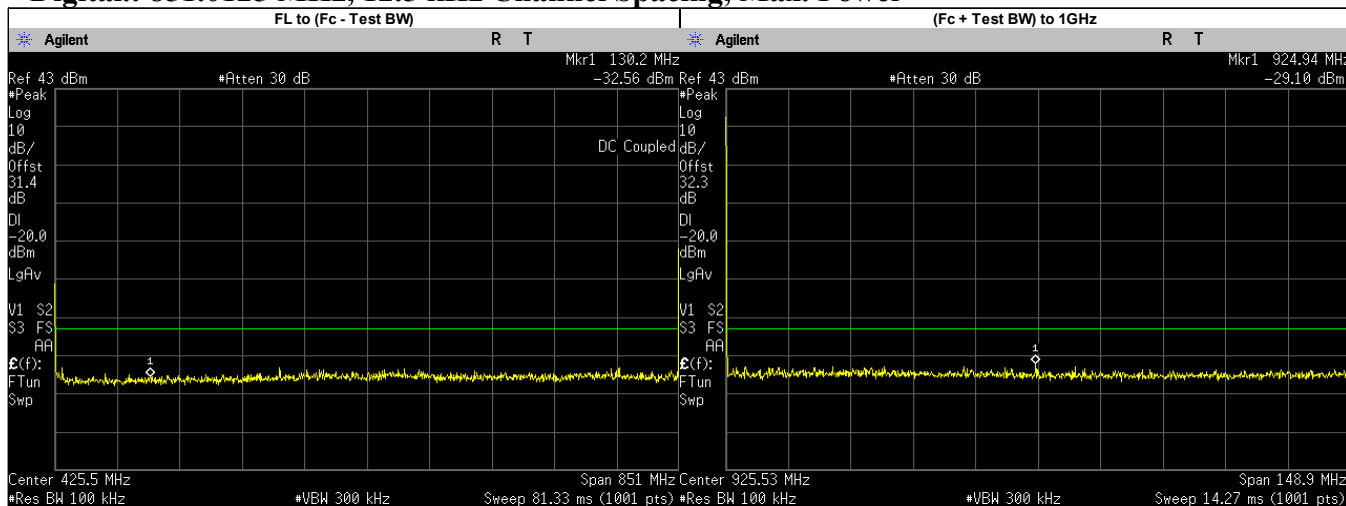

| Frequency Range        | Highest Spur Frequency (MHz) | Spurious Level (dBm) | Failing Limit (dBm) | Results |
|------------------------|------------------------------|----------------------|---------------------|---------|
| FL to (Fc - Test BW)   | 130.2000                     | -32.5630             | -20.00              | PASS    |
| (Fc + Test BW) to 1GHz | 924.9355                     | -29.1000             | -20.00              | PASS    |
| 1GHz to 2Fc            | 1117.1000                    | -42.4300             | -20.00              | PASS    |
| 2Fc to 10Fc            | 7056.0000                    | -37.6300             | -20.00              | PASS    |
|                        | 1702.0250                    | -44.5492             | -20.00              | PASS    |
|                        | 2553.0370                    | -43.6719             | -20.00              | PASS    |
|                        | 3404.0500                    | -41.2390             | -20.00              | PASS    |
|                        | 4255.0620                    | -43.8764             | -20.00              | PASS    |
|                        | 5106.0750                    | -43.6470             | -20.00              | PASS    |
|                        | 5957.0870                    | -43.6636             | -20.00              | PASS    |
|                        | 7659.1130                    | -41.1035             | -20.00              | PASS    |
| 8510.1250              | -41.2353                     | -20.00               | PASS                |         |
| 6808.1000              | -39.7483                     | -20.00               | PASS                |         |

### Digital.: 860.0125 MHz, 12.5 kHz Channel Spacing, Max. Power

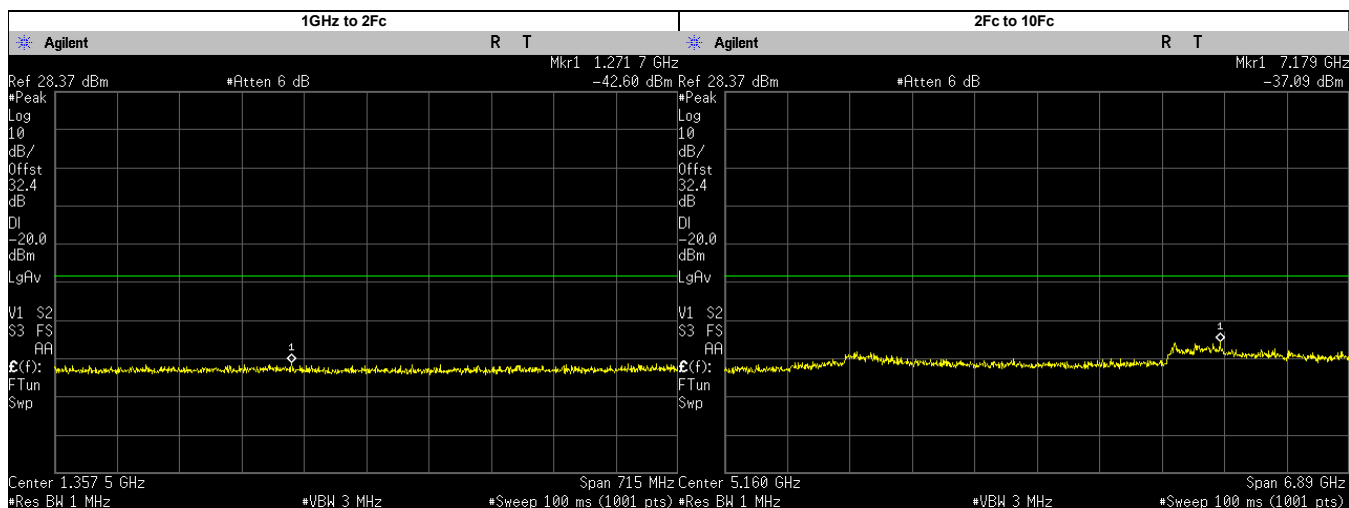
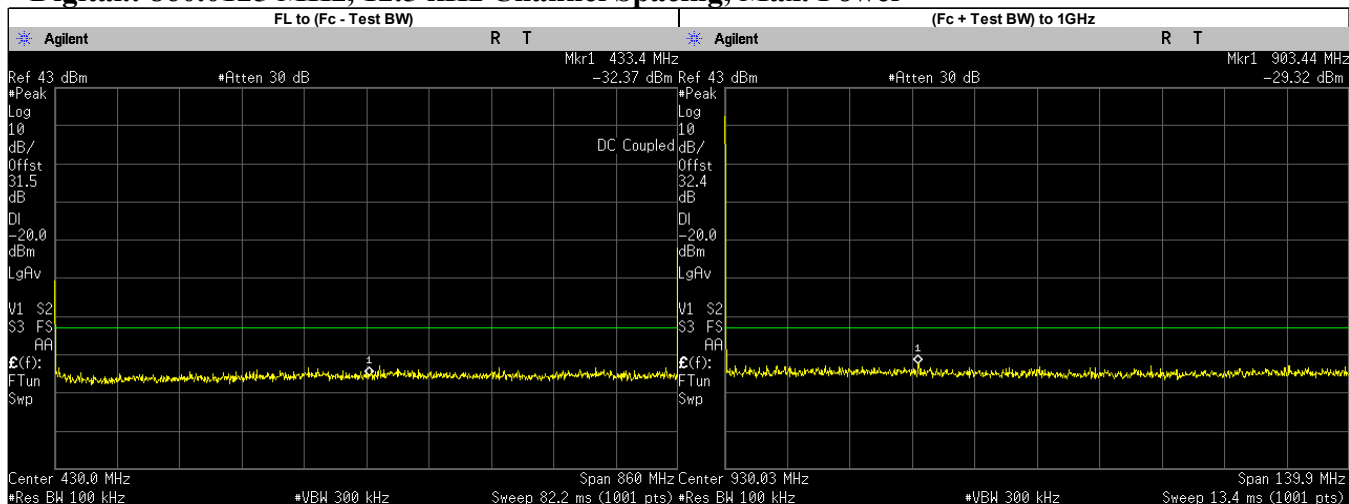

| Frequency Range        | Highest Spur Frequency (MHz) | Spurious Level (dBm) | Failing Limit (dBm) | Results |
|------------------------|------------------------------|----------------------|---------------------|---------|
| FL to (Fc - Test BW)   | 433.4000                     | -32.3680             | -20.00              | PASS    |
| (Fc + Test BW) to 1GHz | 903.4431                     | -29.3200             | -20.00              | PASS    |
| 1GHz to 2Fc            | 1271.7090                    | -42.6000             | -20.00              | PASS    |
| 2Fc to 10Fc            | 7179.0000                    | -37.0900             | -20.00              | PASS    |
|                        | 1720.0250                    | -44.2118             | -20.00              | PASS    |
|                        | 2580.0370                    | -43.7311             | -20.00              | PASS    |
|                        | 3440.0500                    | -41.4222             | -20.00              | PASS    |
|                        | 4300.0620                    | -42.9045             | -20.00              | PASS    |
|                        | 5160.0750                    | -43.4270             | -20.00              | PASS    |
|                        | 6020.0870                    | -43.4752             | -20.00              | PASS    |
|                        | 6880.1000                    | -40.0177             | -20.00              | PASS    |
|                        | 7740.1130                    | -40.6827             | -20.00              | PASS    |
|                        | 8600.1250                    | -41.2428             | -20.00              | PASS    |

### Digital.: 868.8875 MHz, 12.5 kHz Channel Spacing, Max. Power

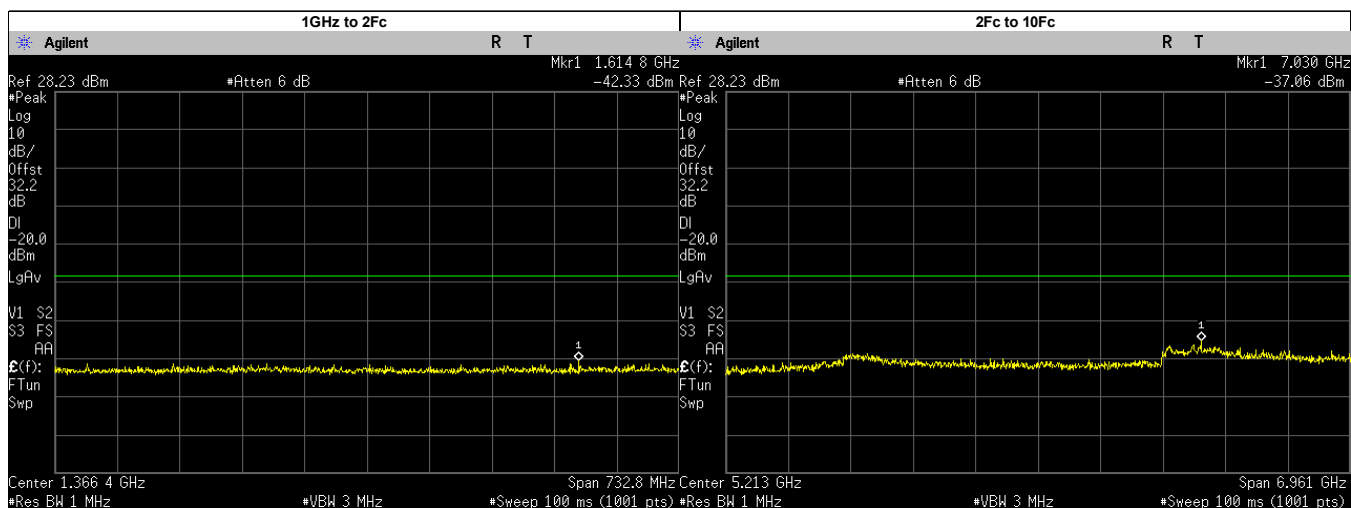
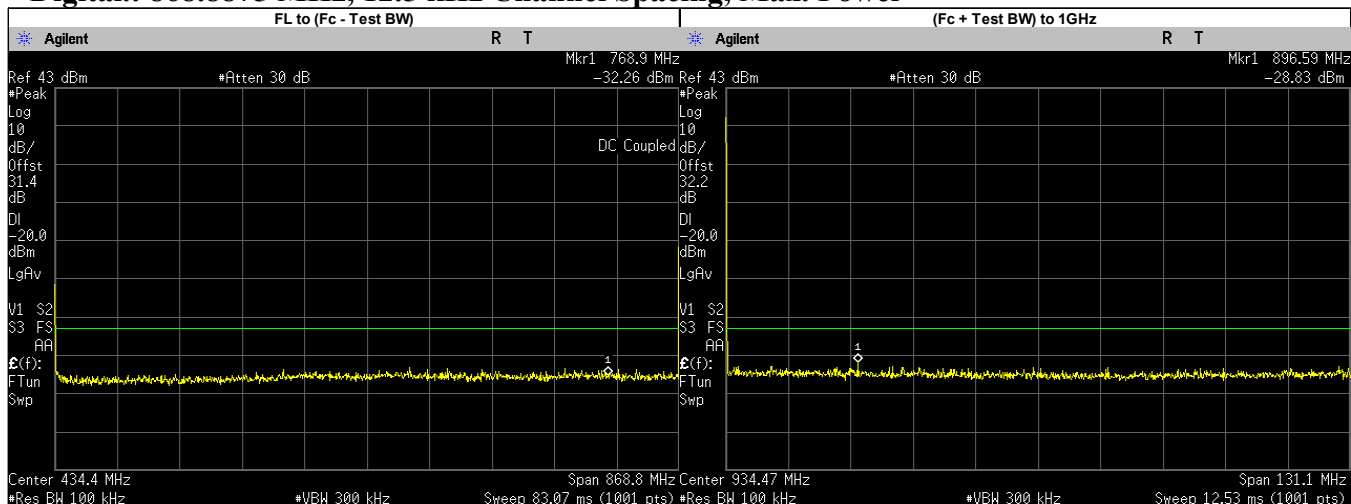

| Frequency Range        | Highest Spur Frequency (MHz) | Spurious Level (dBm) | Failing Limit (dBm) | Results |
|------------------------|------------------------------|----------------------|---------------------|---------|
| FL to (Fc - Test BW)   | 768.9000                     | -32.2620             | -20.00              | PASS    |
| (Fc + Test BW) to 1GHz | 896.5917                     | -28.8300             | -20.00              | PASS    |
| 1GHz to 2Fc            | 1614.7980                    | -42.3300             | -20.00              | PASS    |
| 2Fc to 10Fc            | 7030.0000                    | -37.0600             | -20.00              | PASS    |
|                        | 1737.7750                    | -45.2379             | -20.00              | PASS    |
|                        | 2606.6620                    | -44.4453             | -20.00              | PASS    |
|                        | 3475.5500                    | -42.1187             | -20.00              | PASS    |
|                        | 4344.4370                    | -43.2548             | -20.00              | PASS    |
|                        | 5213.3250                    | -43.8450             | -20.00              | PASS    |
|                        | 6082.2120                    | -42.8817             | -20.00              | PASS    |
|                        | 7819.9880                    | -40.9319             | -20.00              | PASS    |
| 8688.8750              | -40.9780                     | -20.00               | PASS                |         |
| 6951.1000              | -38.9807                     | -20.00               | PASS                |         |

### Phase II.: 806.0125 MHz, 12.5 kHz Channel Spacing, Max. Power

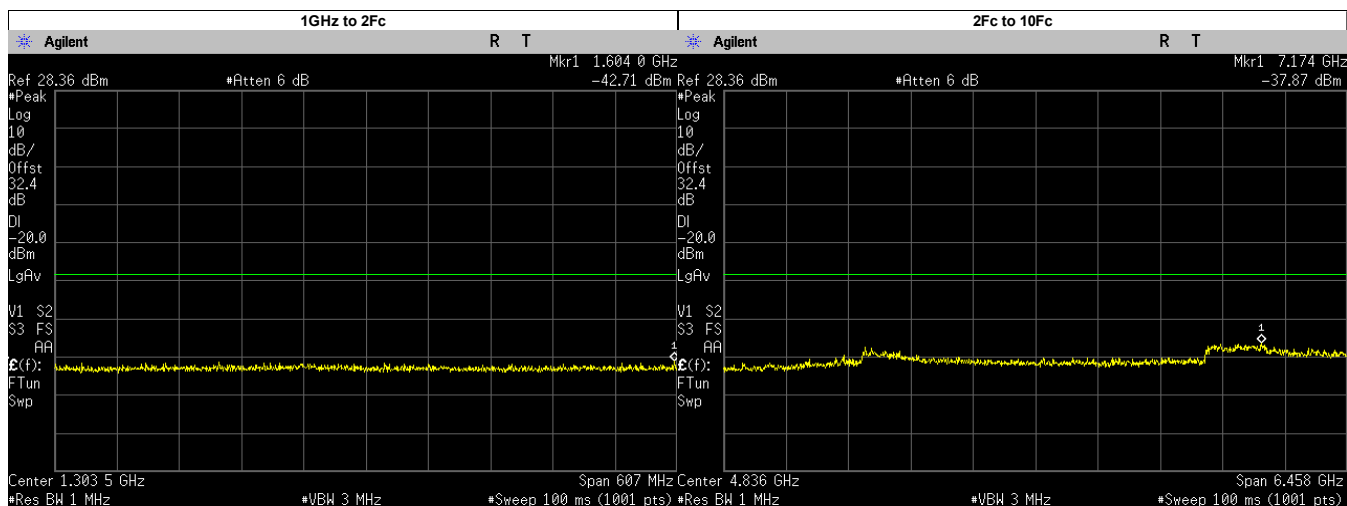
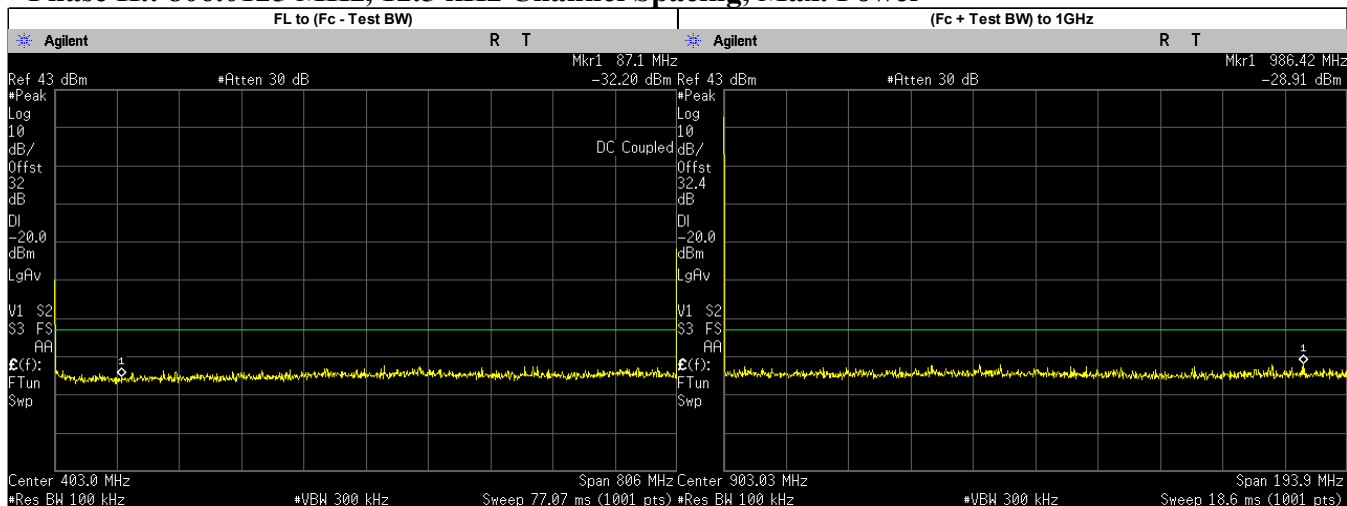

| Frequency Range        | Highest Spur Frequency (MHz) | Spurious Level (dBm) | Failing Limit (dBm) | Results |
|------------------------|------------------------------|----------------------|---------------------|---------|
| FL to (Fc - Test BW)   | 87.1000                      | -32.1980             | -20.00              | PASS    |
| (Fc + Test BW) to 1GHz | 986.4244                     | -28.9100             | -20.00              | PASS    |
| 1GHz to 2Fc            | 1603.9900                    | -42.7100             | -20.00              | PASS    |
| 2Fc to 10Fc            | 7174.0000                    | -37.8700             | -20.00              | PASS    |
|                        | 1612.0250                    | -45.2074             | -20.00              | PASS    |
|                        | 2418.0370                    | -44.2100             | -20.00              | PASS    |
|                        | 3224.0500                    | -41.4692             | -20.00              | PASS    |
|                        | 4030.0620                    | -43.1667             | -20.00              | PASS    |
|                        | 4836.0750                    | -43.1520             | -20.00              | PASS    |
|                        | 5642.0870                    | -42.7302             | -20.00              | PASS    |
|                        | 6448.1000                    | -42.7691             | -20.00              | PASS    |
| 7254.1130              | -40.5896                     | -20.00               | PASS                |         |
| 8060.1250              | -41.3314                     | -20.00               | PASS                |         |

**Phase II.: 814.9875 MHz, 12.5 kHz Channel Spacing, Max. Power**

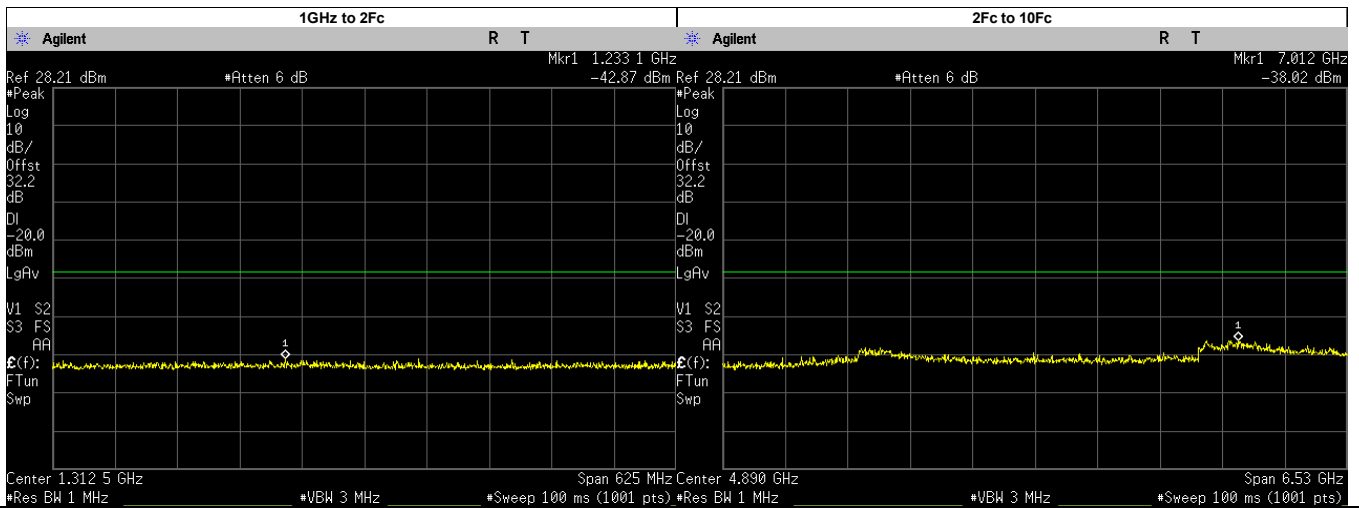
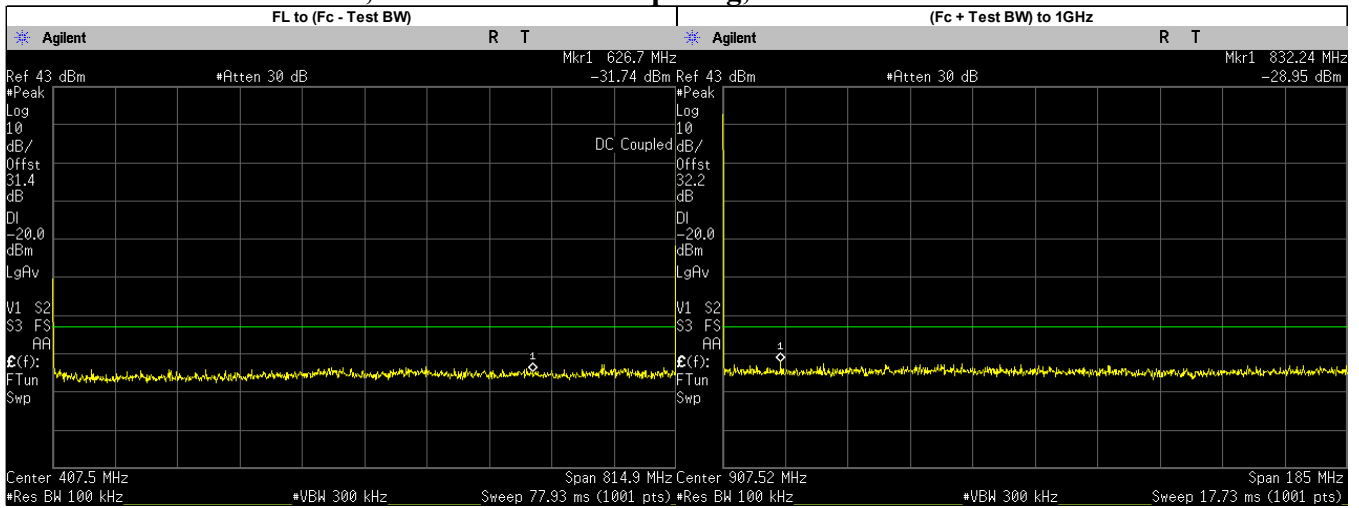

| Frequency Range        | Highest Spur Frequency (MHz) | Spurious Level (dBm) | Failing Limit (dBm) | Results |
|------------------------|------------------------------|----------------------|---------------------|---------|
| FL to (Fc - Test BW)   | 626.7000                     | -31.7420             | -20.00              | PASS    |
| (Fc + Test BW) to 1GHz | 832.2390                     | -28.9500             | -20.00              | PASS    |
| 1GHz to 2Fc            | 1233.1160                    | -42.8700             | -20.00              | PASS    |
| 2Fc to 10Fc            | 7012.0000                    | -38.0200             | -20.00              | PASS    |
|                        | 1629.9750                    | -44.6437             | -20.00              | PASS    |
|                        | 2444.9630                    | -43.2008             | -20.00              | PASS    |
|                        | 3259.9500                    | -41.4944             | -20.00              | PASS    |
|                        | 4074.9370                    | -43.2496             | -20.00              | PASS    |
|                        | 4889.9250                    | -44.1830             | -20.00              | PASS    |
|                        | 5704.9130                    | -43.2928             | -20.00              | PASS    |
|                        | 6519.9000                    | -43.1211             | -20.00              | PASS    |
| 8149.8750              | -41.7092                     | -20.00               | PASS                |         |
| 7334.8870              | -39.6491                     | -20.00               | PASS                |         |

### Phase II.: 823.9875 MHz, 12.5 kHz Channel Spacing, Max. Power

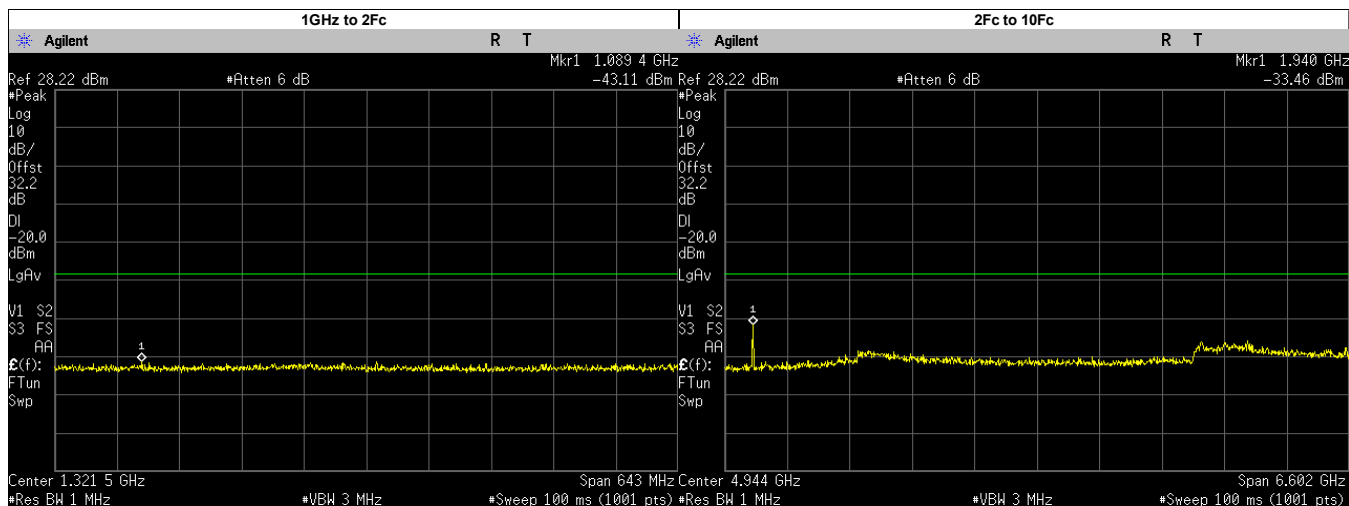
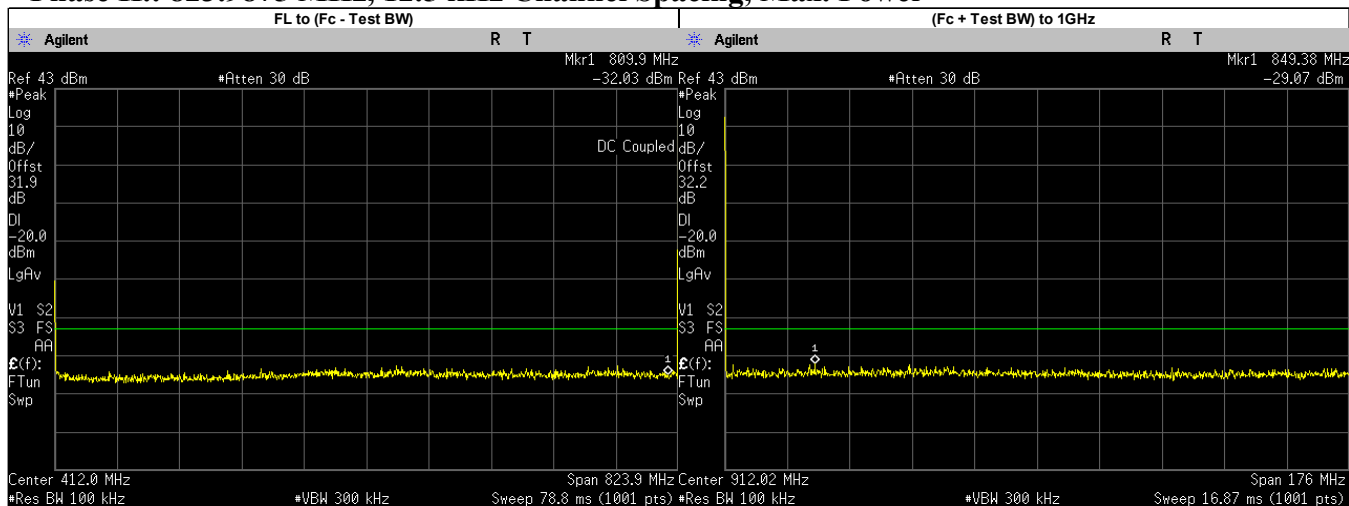

| Frequency Range        | Highest Spur Frequency (MHz) | Spurious Level (dBm) | Failing Limit (dBm) | Results |
|------------------------|------------------------------|----------------------|---------------------|---------|
| FL to (Fc - Test BW)   | 809.9000                     | -32.0280             | -20.00              | PASS    |
| (Fc + Test BW) to 1GHz | 849.3761                     | -29.0700             | -20.00              | PASS    |
| 1GHz to 2Fc            | 1089.3730                    | -43.1100             | -20.00              | PASS    |
| 2Fc to 10Fc            | 1940.0000                    | -33.4600             | -20.00              | PASS    |
|                        | 1647.9750                    | -45.1177             | -20.00              | PASS    |
|                        | 2471.9630                    | -43.3716             | -20.00              | PASS    |
|                        | 3295.9500                    | -40.9454             | -20.00              | PASS    |
|                        | 4119.9370                    | -42.9205             | -20.00              | PASS    |
|                        | 4943.9250                    | -43.0220             | -20.00              | PASS    |
|                        | 5767.9130                    | -43.6531             | -20.00              | PASS    |
|                        | 6591.9000                    | -42.3488             | -20.00              | PASS    |
|                        | 7415.8870                    | -41.1063             | -20.00              | PASS    |
| 8239.8750              | -42.0559                     | -20.00               | PASS                |         |



### Phase II.: 851.0125 MHz, 12.5 kHz Channel Spacing, Max. Power

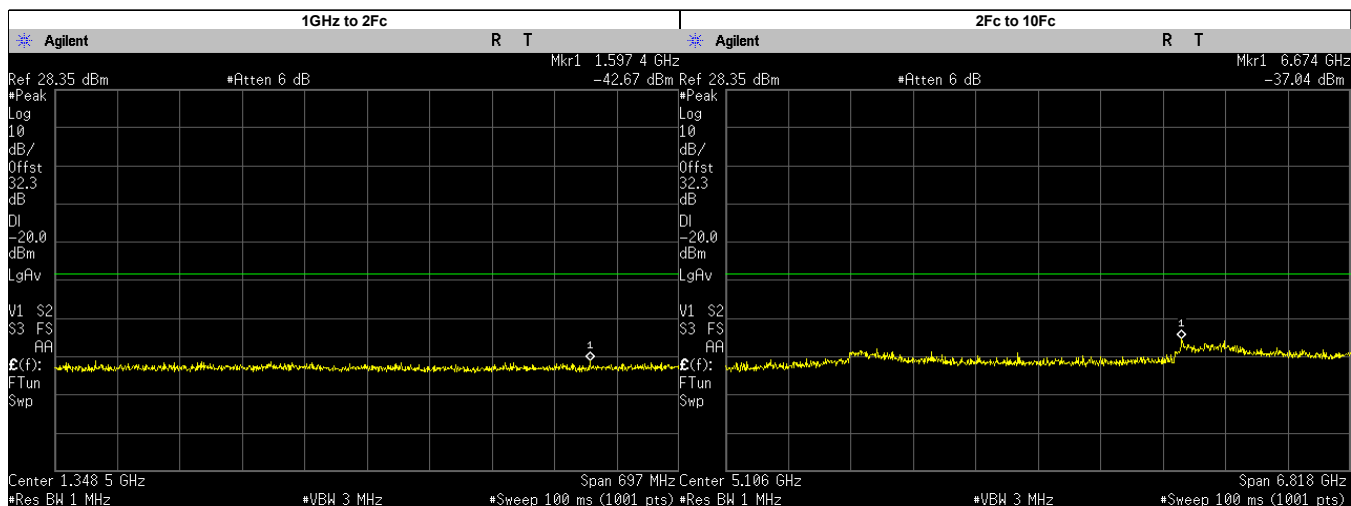
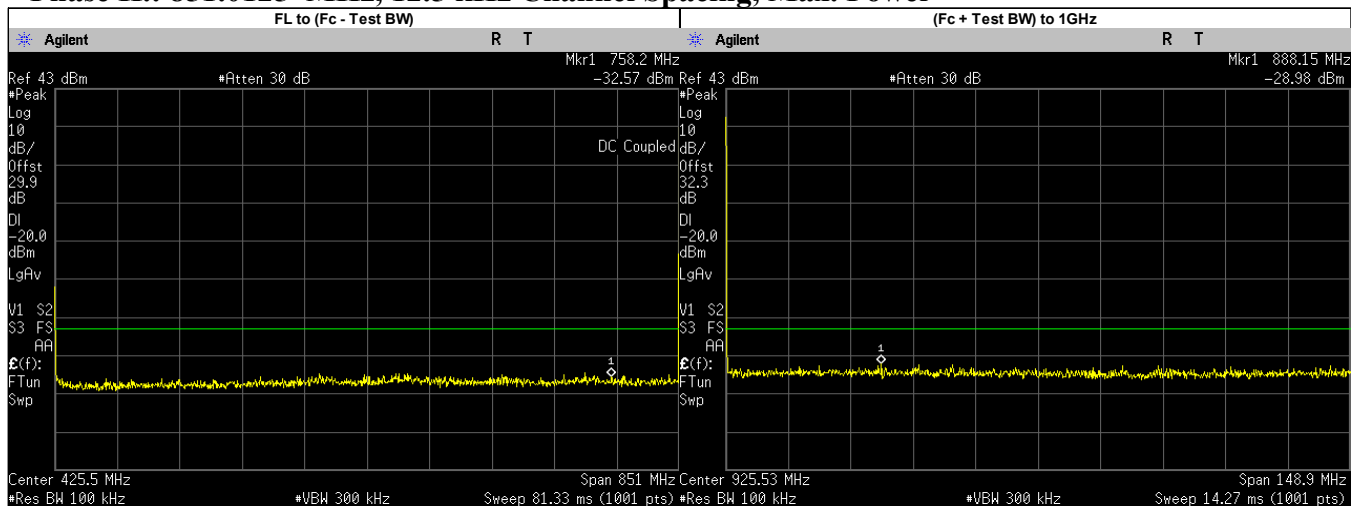

| Frequency Range        | Highest Spur Frequency (MHz) | Spurious Level (dBm) | Failing Limit (dBm) | Results |
|------------------------|------------------------------|----------------------|---------------------|---------|
| FL to (Fc - Test BW)   | 758.2000                     | -32.5700             | -20.00              | PASS    |
| (Fc + Test BW) to 1GHz | 888.1479                     | -28.9800             | -20.00              | PASS    |
| 1GHz to 2Fc            | 1597.3500                    | -42.6700             | -20.00              | PASS    |
| 2Fc to 10Fc            | 6674.0000                    | -37.0400             | -20.00              | PASS    |
|                        | 1702.0250                    | -44.4744             | -20.00              | PASS    |
|                        | 2553.0370                    | -43.9774             | -20.00              | PASS    |
|                        | 3404.0500                    | -41.6838             | -20.00              | PASS    |
|                        | 4255.0620                    | -42.9811             | -20.00              | PASS    |
|                        | 5106.0750                    | -43.3310             | -20.00              | PASS    |
|                        | 5957.0870                    | -43.6217             | -20.00              | PASS    |
|                        | 7659.1130                    | -40.9794             | -20.00              | PASS    |
|                        | 8510.1250                    | -41.1318             | -20.00              | PASS    |
| 6808.1000              | -39.1055                     | -20.00               | PASS                |         |

### Phase II.: 860.0125 MHz, 12.5 kHz Channel Spacing, Max. Power

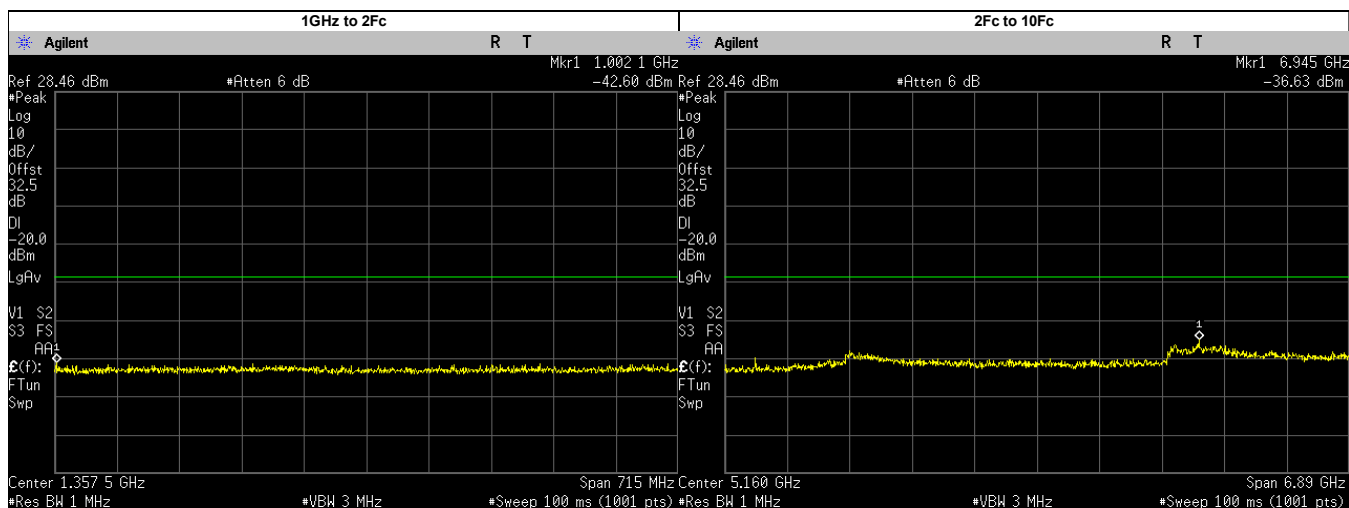
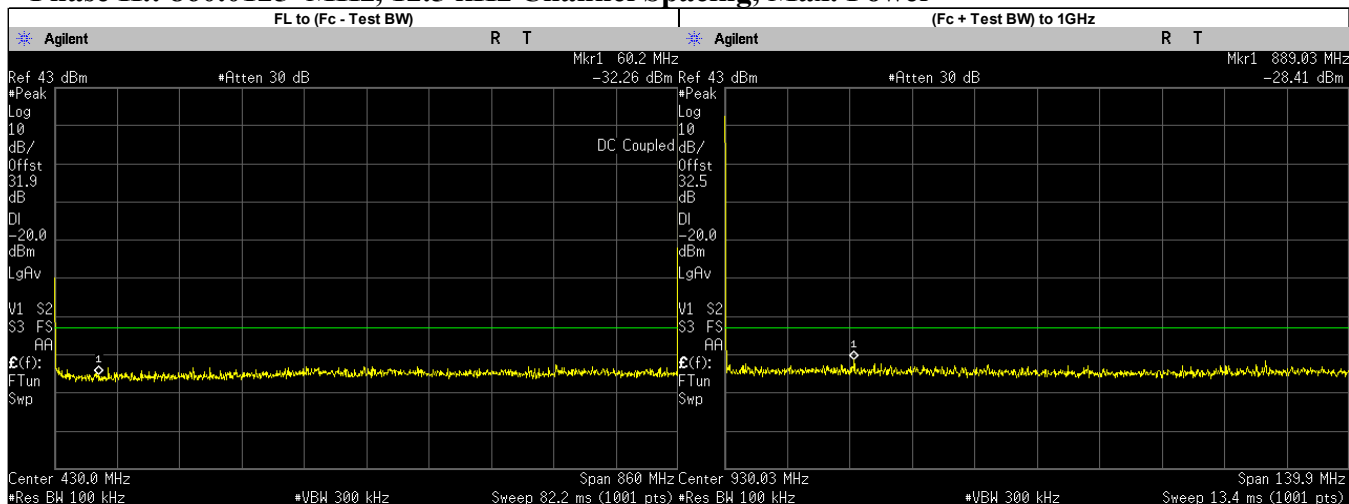

| Frequency Range        | Highest Spur Frequency (MHz) | Spurious Level (dBm) | Failing Limit (dBm) | Results |
|------------------------|------------------------------|----------------------|---------------------|---------|
| FL to (Fc - Test BW)   | 60.2000                      | -32.2600             | -20.00              | PASS    |
| (Fc + Test BW) to 1GHz | 889.0296                     | -28.4100             | -20.00              | PASS    |
| 1GHz to 2Fc            | 1002.1450                    | -42.6000             | -20.00              | PASS    |
| 2Fc to 10Fc            | 6945.0000                    | -36.6300             | -20.00              | PASS    |
|                        | 1720.0250                    | -44.5117             | -20.00              | PASS    |
|                        | 2580.0370                    | -43.3788             | -20.00              | PASS    |
|                        | 3440.0500                    | -41.9092             | -20.00              | PASS    |
|                        | 4300.0620                    | -43.4905             | -20.00              | PASS    |
|                        | 5160.0750                    | -43.5410             | -20.00              | PASS    |
|                        | 6020.0870                    | -43.5309             | -20.00              | PASS    |
|                        | 8600.1250                    | -41.1590             | -20.00              | PASS    |
|                        | 6880.1000                    | -38.7471             | -20.00              | PASS    |
|                        | 7740.1130                    | -39.6187             | -20.00              | PASS    |

### Phase II.: 868.8875 MHz, 12.5 kHz Channel Spacing, Max. Power

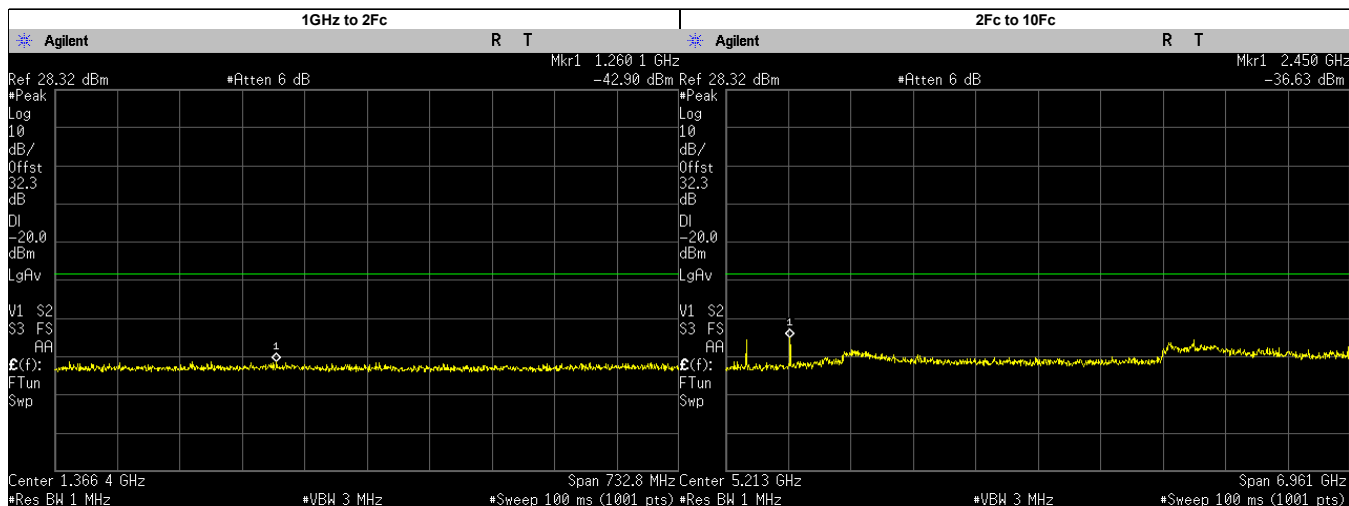
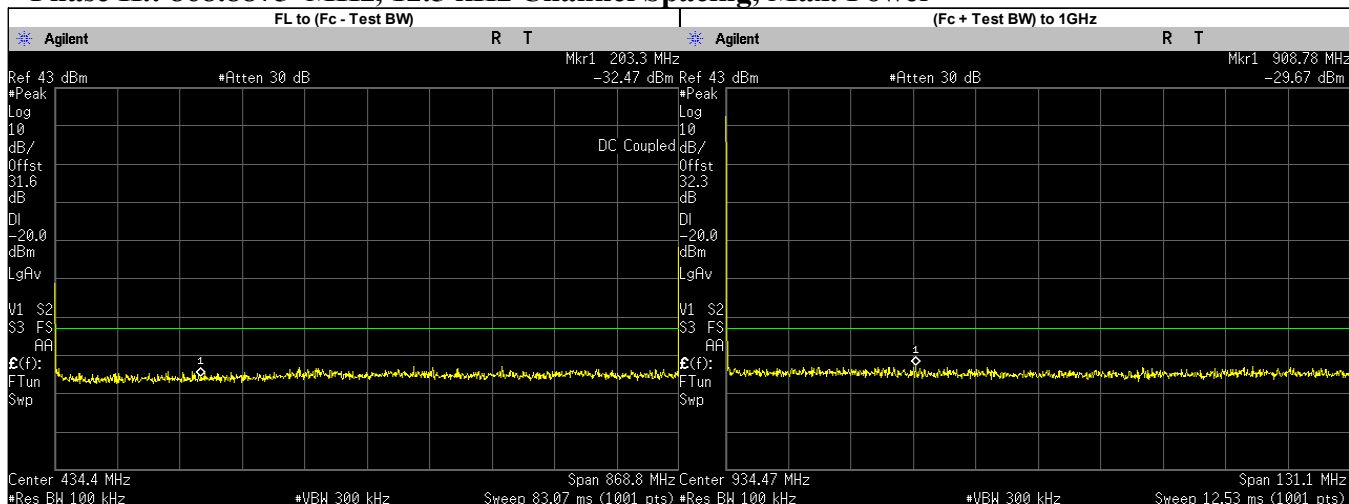

| Frequency Range        | Highest Spur Frequency (MHz) | Spurious Level (dBm) | Failing Limit (dBm) | Results |
|------------------------|------------------------------|----------------------|---------------------|---------|
| FL to (Fc - Test BW)   | 203.3000                     | -32.4720             | -20.00              | PASS    |
| (Fc + Test BW) to 1GHz | 908.7805                     | -29.6700             | -20.00              | PASS    |
| 1GHz to 2Fc            | 1260.1350                    | -42.9000             | -20.00              | PASS    |
| 2Fc to 10Fc            | 2450.0000                    | -36.6300             | -20.00              | PASS    |
|                        | 1737.7750                    | -44.7468             | -20.00              | PASS    |
|                        | 2606.6620                    | -43.6267             | -20.00              | PASS    |
|                        | 3475.5500                    | -41.4476             | -20.00              | PASS    |
|                        | 4344.4370                    | -42.6736             | -20.00              | PASS    |
|                        | 5213.3250                    | -43.6280             | -20.00              | PASS    |
|                        | 6082.2120                    | -42.4846             | -20.00              | PASS    |
|                        | 7819.9880                    | -40.5954             | -20.00              | PASS    |
| 8688.8750              | -41.8732                     | -20.00               | PASS                |         |
| 6951.1000              | -38.2617                     | -20.00               | PASS                |         |

### 6.9.4. Test Limit

Table below summarized the power of any emission outside a licensee’s frequency block shall be attenuated below the transmitter power (P) by at least

| Channel Spacing | Part 22                                 | Part 24D                                | Part 74                                 | Part 80                                 | Part 90 (UHF, VHF, 800, 900)            | Part 90 (700)                           |
|-----------------|---|---|---|---|---|---|
| 12.5kHz         | 43 + log <sub>10</sub> (P)<br>(-13 dBm) | 43 + log <sub>10</sub> (P)<br>(-13 dBm) | 43 + log <sub>10</sub> (P)<br>(-13 dBm) | Not Applicable                          | 50 + log <sub>10</sub> (P)<br>(-20 dBm) | 43 + log <sub>10</sub> (P)<br>(-13 dBm) |
| 25kHz           |   | Not Applicable                          |   | 43 + log <sub>10</sub> (P)<br>(-13 dBm) | 43 + log <sub>10</sub> (P)<br>(-13 dBm) | 43 + log <sub>10</sub> (P)<br>(-13 dBm) |

| Channel Spacing | RSS 134                                 | RSS 182                                 | RSS 119 (UHF, VHF, 800, 900)            | RSS 119 (700)                           |
|-----------------|---|---|---|---|
| 12.5kHz         | 43 + log <sub>10</sub> (P)<br>(-13 dBm) | Not Applicable                          | 50 + log <sub>10</sub> (P)<br>(-20 dBm) | 43 + log <sub>10</sub> (P)<br>(-13 dBm) |
| 25kHz           | Not Applicable                          | 43 + log <sub>10</sub> (P)<br>(-13 dBm) | 43 + log <sub>10</sub> (P)<br>(-13 dBm) | 43 + log <sub>10</sub> (P)<br>(-13 dBm) |

## 6.10. Radiated Spurious Emission

### 6.10.1. Test Setup

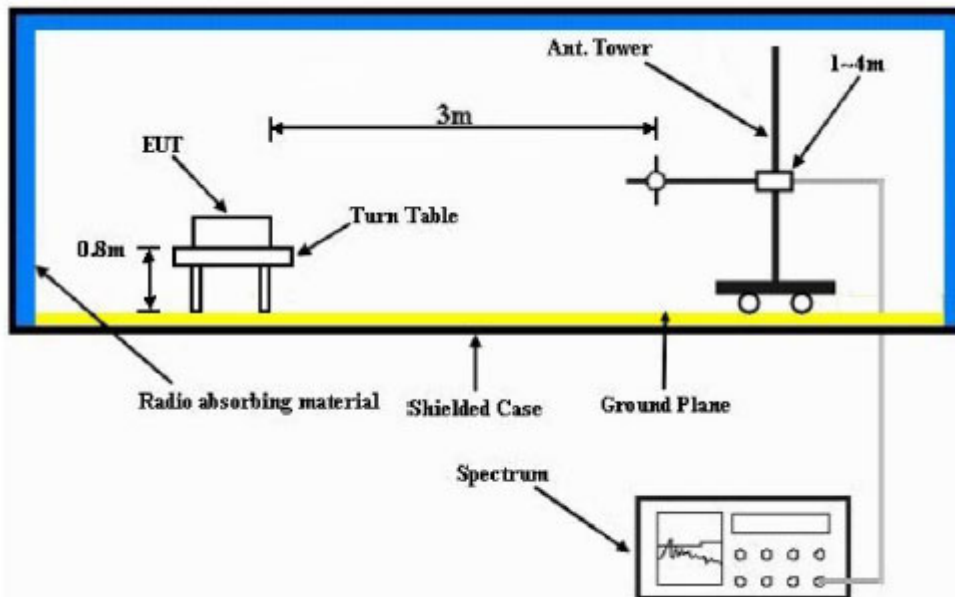

- 1) The Resolution Bandwidth for scanning Radiated Emission below 1 GHz is 100 kHz with Video Bandwidth = 300 kHz and Resolution Bandwidth for above 1 GHz is 1 MHz with Video Bandwidth = 3 MHz. Detector mode is positive peak.
- 2) In the semi- anechoic chamber, setup as illustrated above the DUT placed on the 0.8m height (for  $F_c < 1\text{GHz}$ ) or 1.5m height (for  $F_c > 1\text{GHz}$ ) of Turn Table, rotated the table around 360 degrees to search the maximum radiation power and receiver antenna shall be rotated vertical and horizontal polarization and moved height from 1m to 4m to find the maximum polar radiated power. The “Read Value” is the spectrum reading the maximum power value.
- 3) The substitution antenna is substituted for DUT at the same position and signals generator (S.G) export the CW signal to the substitution antenna via a TX cable. The receiver antenna shall be rotated vertical and horizontal polarization and moved height from 1m to 4m to find the maximum radiation power. Record the power level of maximum radiation power from spectrum. So, the measured substitution value = Ref level of S.G + TX cables loss – Substituted Antenna Gain.
- 4) Final Radiated Spurious Emission = “Read Value” + Measured substitution value.

### 6.10.2. Test Result (Analog)

**SAC Transmitter Radiated Emission:**

Model Number: H35UCT9PW8AN      S/N: 022TYP0004      SR:26977-EMC-00102  
 Battery Part No: PMMN4817A      Accy Part No: NA  
 Test Mode: TX Analog  
 806.012500 MHz      25 kHz      3.600 Watt(s) /Max Power

| Frequency (MHz) | Limit    | Horizontal Measured Emission Equiv Pwr Into Ideal Dipole (dBm) | Vertical Measured Emission Equiv Pwr Into ideal Dipole (dBm) |
|-----------------|----------|--|--|
| 1612.0250       | -13.0000 | -59.3509 **  | -59.5821 **  |
| 2418.0375       | -13.0000 | -54.5712 **  | -53.4102 **  |
| 3224.0500       | -13.0000 | -50.8587 **  | -51.6151 **  |
| 4030.0625       | -13.0000 | -50.2670 **  | -50.2965 **  |
| 4836.0750       | -13.0000 | -45.6309 **  | -48.9703 **  |
| 5642.0875       | -13.0000 | -45.9217 **  | -47.8233 **  |
| 6448.1000       | -13.0000 | -44.8350 **  | -44.4867 **  |
| 7254.1125       | -13.0000 | -43.3282 **  | -43.1451 **  |
| 8060.1250       | -13.0000 | -41.6779 **  | -42.0905 **  |
|                 |          |  |  |
|                 |          |  |  |

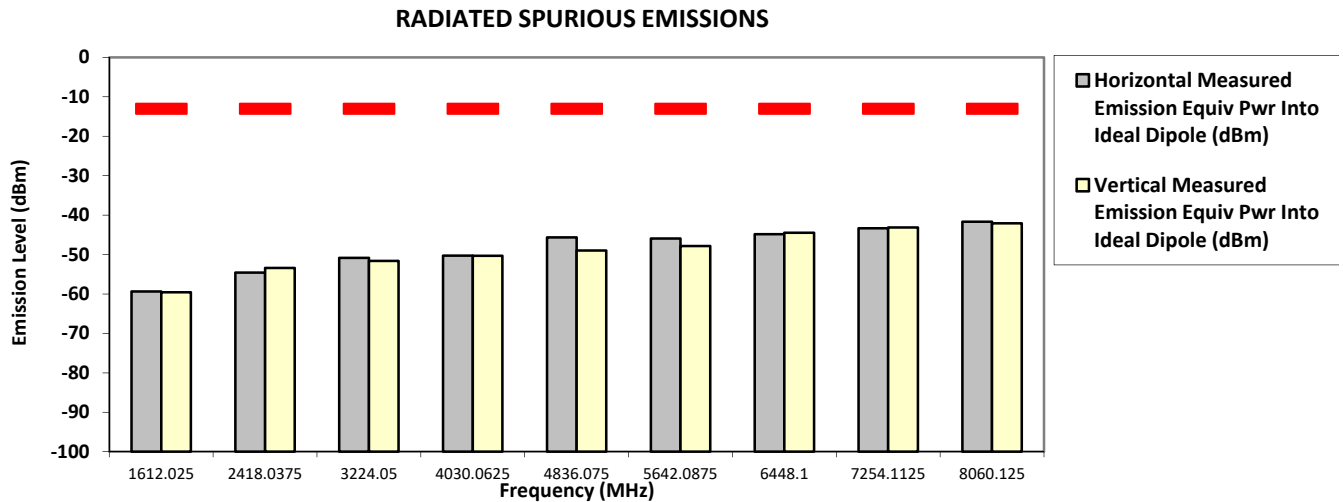

The data presented here was taken using the substitution method as found in the ANSI C63.26-2015 document.  
 Motorola Penang EMC Lab - Test Performed by: Qawiman&Aiman      Thu, 4 Aug, 2022

Remarks: \*\* Indicates the spurious emission could not be detected due to noise limitations or ambient.  
 \*Pursuant to CFR 47 Part 2.1057 ( c ), emissions attenuated more than 20 dB below the permissible limit are not reported  
 Temp(Deg): 23.4 Hum(%RH): 69.6

Remarks: Passed Results Marginal Results Failed Results

SAC Transmitter Radiated Emission:

Model Number: H35UCT9PW8AN

S/N: 022TYP0004

SR:26977-EMC-00102

Battery Part No: PMMN4817A

Accy Part No: NA

814.987500 MHz

Test Mode: TX Analog  
 25 kHz

3.600 Watt(s) /Max Power

| Frequency (MHz) | Limit    | Horizontal Measured Emission Equip Pwr Into Ideal Dipole (dBm) | Vertical Measured Emission Equip Pwr Into ideal Dipole (dBm) |
|-----------------|----------|--|--|
| 1629.9750       | -13.0000 | -59.4900 **  | -59.4048 **  |
| 2444.9625       | -13.0000 | -54.8711 **  | -54.8176 **  |
| 3259.9500       | -13.0000 | -51.0210 **  | -51.5119 **  |
| 4074.9375       | -13.0000 | -50.1632 **  | -50.9444 **  |
| 4889.9250       | -13.0000 | -47.7795 **  | -48.3184 **  |
| 5704.9125       | -13.0000 | -47.2550 **  | -46.8090 **  |
| 6519.9000       | -13.0000 | -44.2296 **  | -43.9910 **  |
| 7334.8875       | -13.0000 | -43.1587 **  | -42.7299 **  |
| 8149.8750       | -13.0000 | -42.6160 **  | -42.5646 **  |
|                 |          |  |  |
|                 |          |  |  |
|                 |          |  |  |

RADIATED SPURIOUS EMISSIONS

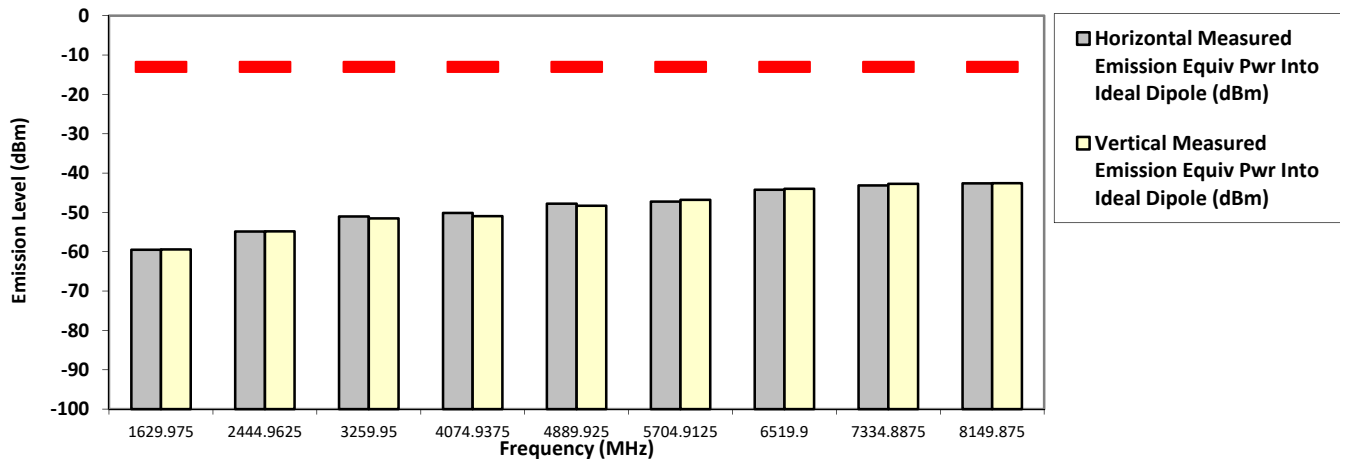

The data presented here was taken using the substitution method as found in the ANSI C63.26-2015 document.  
 Motorola Penang EMC Lab - Test Performed by: Qawiman&Aiman Thu, 4 Aug, 2022

Remarks: \*\* Indicates the spurious emission could not be detected due to noise limitations or ambient.  
 \*Pursuant to CFR 47 Part 2.1057 ( c ), emissions attenuated more than 20 dB below the permissible limit are not reported  
 Temp(Deg): 23.4 Hum(%RH): 69.6

Remarks: Passed Results Marginal Results Failed Results

SAC Transmitter Radiated Emission:

Model Number: H35UCT9PW8AN

S/N: 022TYP0004

SR:26977-EMC-00102

Battery Part No: PMMN4817A

Accy Part No: NA

823.987500 MHz

Test Mode: TX Analog  
 25 kHz

3.600 Watt(s) /Max Power

| Frequency (MHz) | Limit    | Horizontal Measured Emission Equip Pwr Into Ideal Dipole (dBm) | Vertical Measured Emission Equip Pwr Into ideal Dipole (dBm) |
|-----------------|----------|--|--|
| 1647.9750       | -13.0000 | -59.1301 **  | -58.7846 **  |
| 2471.9625       | -13.0000 | -53.5020 **  | -53.8145 **  |
| 3295.9500       | -13.0000 | -51.4497 **  | -50.9597 **  |
| 4119.9375       | -13.0000 | -47.9708 **  | -50.4855 **  |
| 4943.9250       | -13.0000 | -48.2544 **  | -47.6292 **  |
| 5767.9125       | -13.0000 | -46.8015 **  | -47.8486 **  |
| 6591.9000       | -13.0000 | -44.3572 **  | -43.8936 **  |
| 7415.8875       | -13.0000 | -42.5836 **  | -43.1262 **  |
| 8239.8750       | -13.0000 | -42.2542 **  | -41.5998 **  |
|                 |          |  |  |
|                 |          |  |  |
|                 |          |  |  |

RADIATED SPURIOUS EMISSIONS

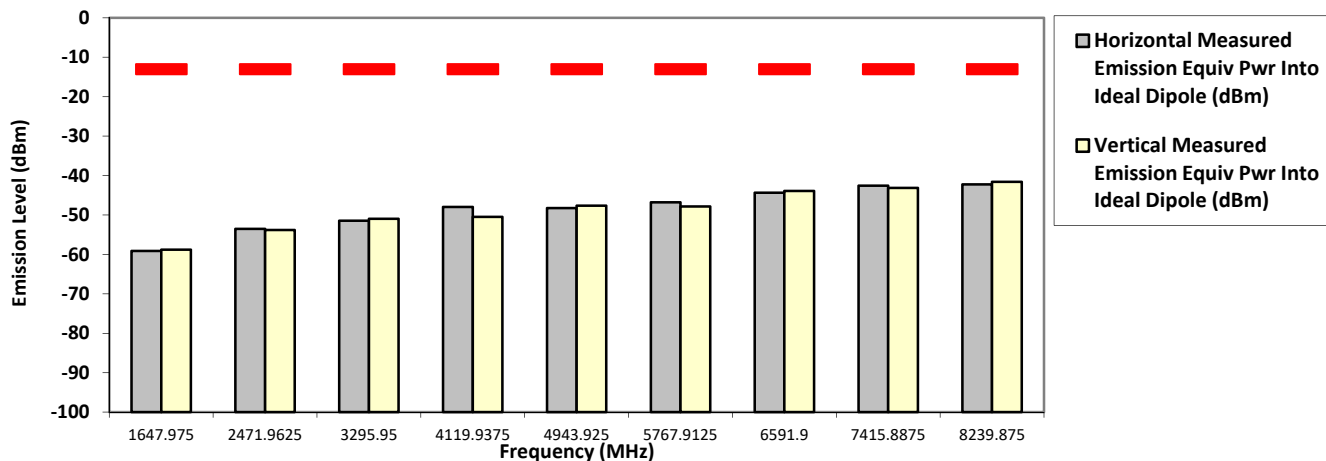

The data presented here was taken using the substitution method as found in the ANSI C63.26-2015 document.  
 Motorola Penang EMC Lab - Test Performed by: Qawiman&Aiman Thu, 4 Aug, 2022

Remarks: \*\* Indicates the spurious emission could not be detected due to noise limitations or ambient.

\*Pursuant to CFR 47 Part 2.1057 ( c ), emissions attenuated more than 20 dB below the permissible limit are not reported  
 Temp(Deg): 23.4 Hum(%RH): 69.6

Remarks:

|                |                  |                |
|----------------|------------------|----------------|
| Passed Results | Marginal Results | Failed Results |
|----------------|------------------|----------------|



SAC Transmitter Radiated Emission:

Model Number: H35UCT9PW8AN

S/N: 022TYP0004

SR:26977-EMC-00102

Battery Part No: PMMN4817A

Accy Part No: NA

851.012500 MHz

Test Mode: TX Analog  
 25 kHz

3.600 Watt(s) /Max Power

| Frequency (MHz) | Limit    | Horizontal Measured Emission Equip Pwr Into Ideal Dipole (dBm) | Vertical Measured Emission Equip Pwr Into ideal Dipole (dBm) |
|-----------------|----------|--|--|
| 1702.0250       | -13.0000 | -60.0634 **  | -58.4423 **  |
| 2553.0375       | -13.0000 | -53.8867 **  | -53.8602 **  |
| 3404.0500       | -13.0000 | -52.1697 **  | -51.8934 **  |
| 4255.0625       | -13.0000 | -49.4383 **  | -49.9689 **  |
| 5106.0750       | -13.0000 | -47.4130 **  | -47.0507 **  |
| 5957.0875       | -13.0000 | -44.9518 **  | -46.3766 **  |
| 6808.1000       | -13.0000 | -44.4535 **  | -44.3806 **  |
| 7659.1125       | -13.0000 | -42.7470 **  | -43.5522 **  |
| 8510.1250       | -13.0000 | -42.1779 **  | -42.0949 **  |
|                 |          |  |  |
|                 |          |  |  |
|                 |          |  |  |

RADIATED SPURIOUS EMISSIONS

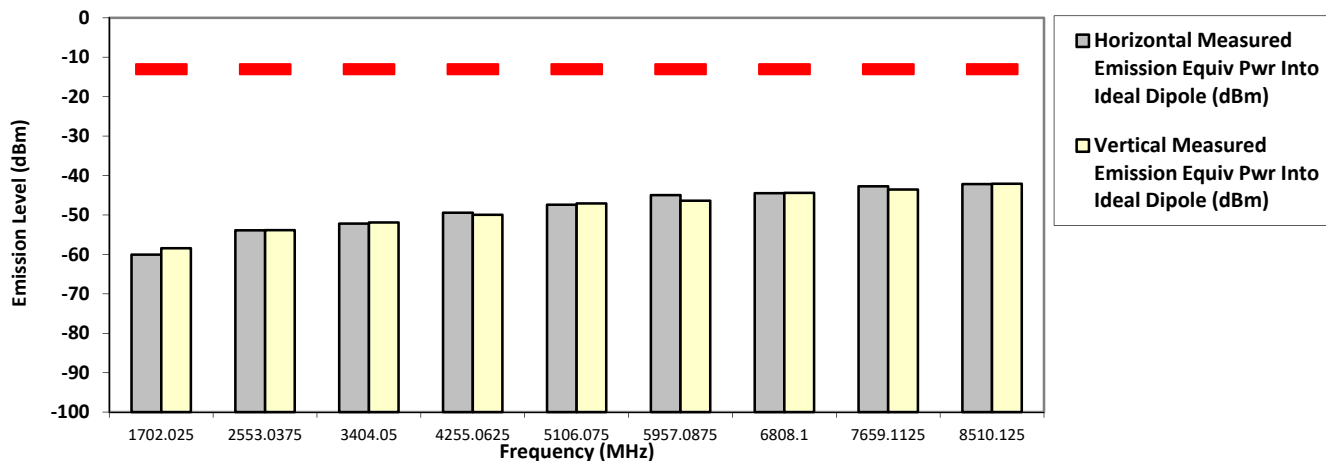

The data presented here was taken using the substitution method as found in the ANSI C63.26-2015 document.  
 Motorola Penang EMC Lab - Test Performed by: Qawiman&Aiman Thu, 4 Aug, 2022

Remarks: \*\* Indicates the spurious emission could not be detected due to noise limitations or ambient.

\*Pursuant to CFR 47 Part 2.1057 ( c ), emissions attenuated more than 20 dB below the permissible limit are not reported  
 Temp(Deg): 23.4 Hum(%RH): 69.6

Remarks:

|                |                  |                |
|----------------|------------------|----------------|
| Passed Results | Marginal Results | Failed Results |
|----------------|------------------|----------------|

**SAC Transmitter Radiated Emission:**

**Model Number: H35UCT9PW8AN**

**S/N: 022TYP0004**

**SR:26977-EMC-00102**

**Battery Part No: PMMN4817A**

**Accy Part No: NA**

**860.012500 MHz**

**Test Mode: TX Analog  
 25 kHz**

**3.600 Watt(s) /Max Power**

| Frequency (MHz) | Limit    | Horizontal Measured Emission Equip Pwr Into Ideal Dipole (dBm) | Vertical Measured Emission Equip Pwr Into ideal Dipole (dBm) |
|-----------------|----------|--|--|
| 1720.0250       | -13.0000 | -59.3924 **  | -59.5228 **  |
| 2580.0375       | -13.0000 | -54.6179 **  | -52.1699 **  |
| 3440.0500       | -13.0000 | -52.5416 **  | -52.4685 **  |
| 4300.0625       | -13.0000 | -50.0417 **  | -50.1242 **  |
| 5160.0750       | -13.0000 | -47.5084 **  | -48.2782 **  |
| 6020.0875       | -13.0000 | -45.6247 **  | -46.0341 **  |
| 6880.1000       | -13.0000 | -44.9768 **  | -45.0290 **  |
| 7740.1125       | -13.0000 | -42.4174 **  | -42.4280 **  |
| 8600.1250       | -13.0000 | -40.5321 **  | -41.2481 **  |
|                 |          |  |  |
|                 |          |  |  |
|                 |          |  |  |

**RADIATED SPURIOUS EMISSIONS**

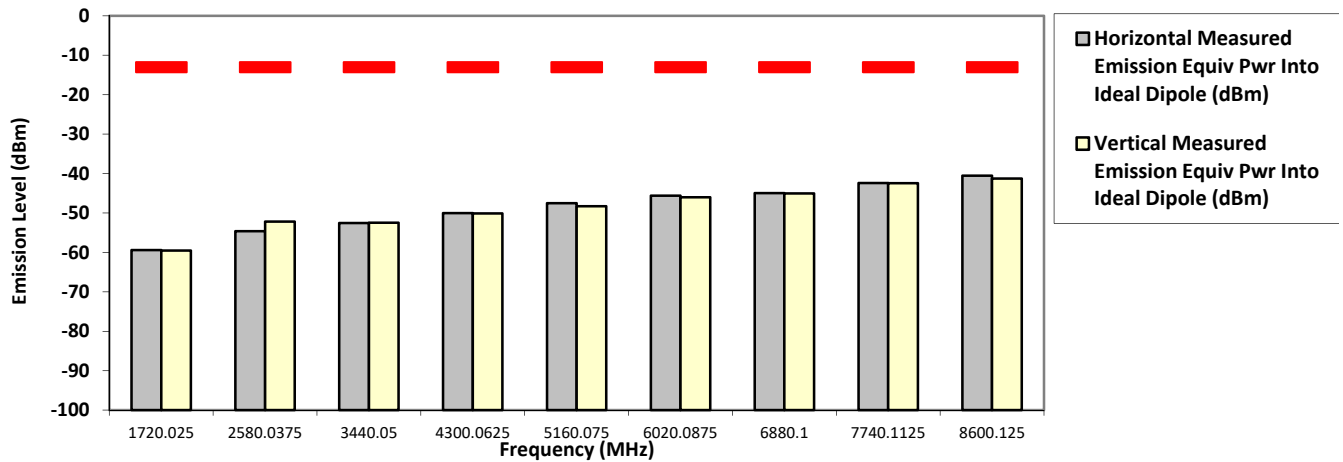

The data presented here was taken using the substitution method as found in the ANSI C63.26-2015 document.  
 Motorola Penang EMC Lab - Test Performed by: Qawiman&Aiman Thu, 4 Aug, 2022

Remarks: \*\* Indicates the spurious emission could not be detected due to noise limitations or ambient.

\*Pursuant to CFR 47 Part 2.1057 ( c ), emissions attenuated more than 20 dB below the permissible limit are not reported  
 Temp(Deg): 23.4 Hum(%RH): 69.6

Remarks: Passed Results Marginal Results Failed Results

SAC Transmitter Radiated Emission:

Model Number: H35UCT9PW8AN

S/N: 022TYP0004

SR:26977-EMC-00102

Battery Part No: PMMN4817A

Accy Part No: NA

868.887500 MHz

Test Mode: TX Analog  
 25 kHz

3.600 Watt(s) /Max Power

| Frequency (MHz) | Limit    | Horizontal Measured Emission Equip Pwr Into Ideal Dipole (dBm) | Vertical Measured Emission Equip Pwr Into ideal Dipole (dBm) |
|-----------------|----------|--|--|
| 1737.7750       | -13.0000 | -58.6441 **  | -59.8707 **  |
| 2606.6625       | -13.0000 | -53.3735 **  | -53.6560 **  |
| 3475.5500       | -13.0000 | -51.0725 **  | -52.6668 **  |
| 4344.4375       | -13.0000 | -51.4851 **  | -50.8894 **  |
| 5213.3250       | -13.0000 | -47.8142 **  | -48.2526 **  |
| 6082.2125       | -13.0000 | -46.0590 **  | -46.5211 **  |
| 6951.1000       | -13.0000 | -44.3548 **  | -43.6709 **  |
| 7819.9875       | -13.0000 | -42.7637 **  | -41.6279 **  |
| 8688.8750       | -13.0000 | -41.1046 **  | -41.1552 **  |
|                 |          |  |  |
|                 |          |  |  |

RADIATED SPURIOUS EMISSIONS

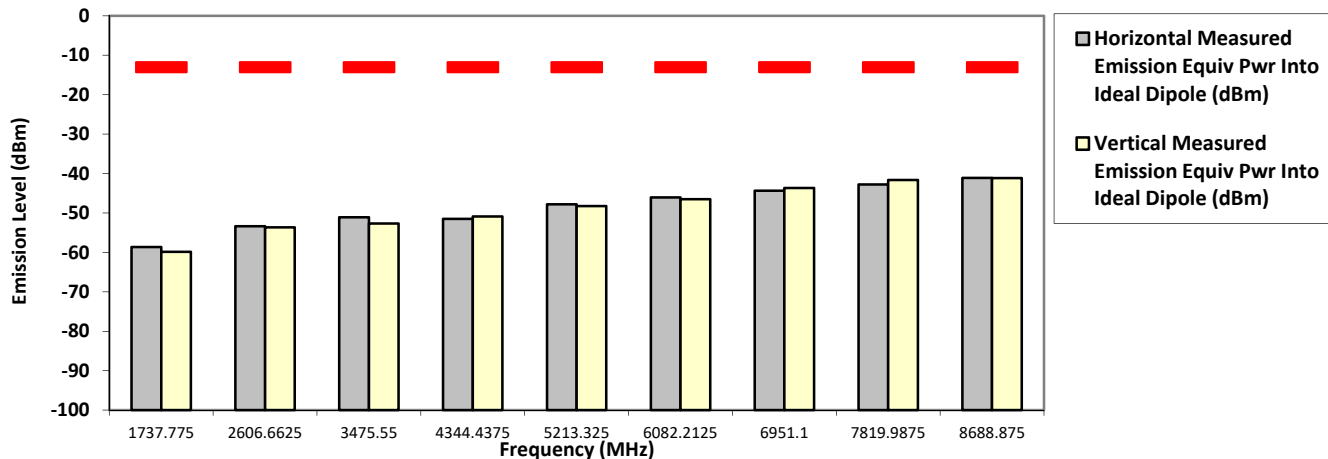

The data presented here was taken using the substitution method as found in the ANSI C63.26-2015 document.  
 Motorola Penang EMC Lab - Test Performed by: Qawiman&Aiman Thu, 4 Aug, 2022

Remarks: \*\* Indicates the spurious emission could not be detected due to noise limitations or ambient.

\*Pursuant to CFR 47 Part 2.1057 ( c ), emissions attenuated more than 20 dB below the permissible limit are not reported  
 Temp(Deg): 23.4 Hum(%RH): 69.6

Remarks:

|                |                  |                |
|----------------|------------------|----------------|
| Passed Results | Marginal Results | Failed Results |
|----------------|------------------|----------------|

### 6.10.3. Test Result (Digital)

**SAC Transmitter Radiated Emission:**

Model Number: H35UCT9PW8AN      S/N: 022TYP0004      SR:26977-EMC-00102  
 Battery Part No: PMMN4817A      Accy Part No: NA  
 Test Mode: TX APCO Digital C4FM  
 806.012500 MHz      12.5 kHz      3.600 Watt(s) /Max Power

| Frequency (MHz) | Limit    | Horizontal Measured Emission Equiv Pwr Into Ideal Dipole (dBm) | Vertical Measured Emission Equiv Pwr Into ideal Dipole (dBm) |
|-----------------|----------|--|--|
| 1612.0250       | -20.0000 | -59.5712 **  | -59.3036 **  |
| 2418.0375       | -20.0000 | -54.5609 **  | -53.7119 **  |
| 3224.0500       | -20.0000 | -51.3640 **  | -50.6597 **  |
| 4030.0625       | -20.0000 | -50.5076 **  | -48.8302 **  |
| 4836.0750       | -20.0000 | -48.5059 **  | -47.6974 **  |
| 5642.0875       | -20.0000 | -47.7813 **  | -47.9736 **  |
| 6448.1000       | -20.0000 | -44.9671 **  | -44.9468 **  |
| 7254.1125       | -20.0000 | -43.5778 **  | -43.2678 **  |
| 8060.1250       | -20.0000 | -42.0826 **  | -42.3695 **  |
|                 |          |  |  |
|                 |          |  |  |

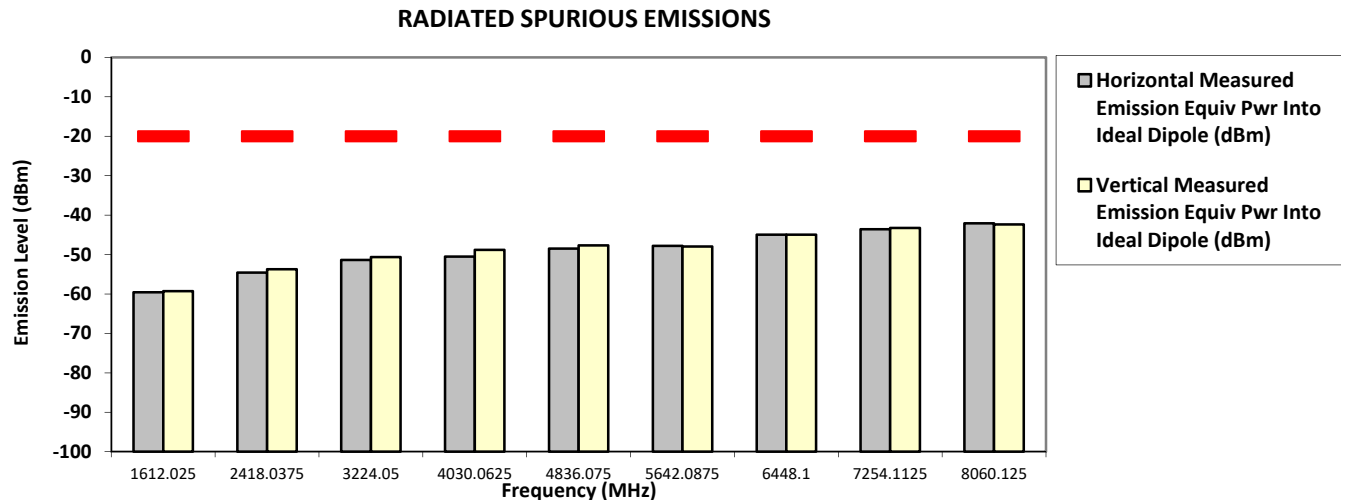

The data presented here was taken using the substitution method as found in the ANSI C63.26-2015 document.  
 Motorola Penang EMC Lab - Test Performed by: Qawiman&Aiman      Thu, 4 Aug, 2022

Remarks: \*\* Indicates the spurious emission could not be detected due to noise limitations or ambient.  
 \*Pursuant to CFR 47 Part 2.1057 ( c ), emissions attenuated more than 20 dB below the permissible limit are not reported  
 Temp(Deg): 23.4 Hum(%RH): 69.6

Remarks: Passed Results Marginal Results Failed Results

**SAC Transmitter Radiated Emission:**

**Model Number: H35UCT9PW8AN**      **S/N: 022TYP0004**      **SR:26977-EMC-00102**  
**Battery Part No: PMMN4817A**      **Accy Part No: NA**  
**Test Mode: TX APCO Digital C4FM**  
**814.987500 MHz**      **12.5 kHz**      **3.600 Watt(s) /Max Power**

| Frequency (MHz) | Limit    | Horizontal Measured Emission Equiv Pwr Into Ideal Dipole (dBm) | Vertical Measured Emission Equiv Pwr Into ideal Dipole (dBm) |
|-----------------|----------|--|--|
| 1629.9750       | -20.0000 | -59.3279 **  | -59.0145 **  |
| 2444.9625       | -20.0000 | -53.2301 **  | -52.9676 **  |
| 3259.9500       | -20.0000 | -50.6294 **  | -50.6434 **  |
| 4074.9375       | -20.0000 | -49.8592 **  | -49.9277 **  |
| 4889.9250       | -20.0000 | -47.4474 **  | -48.0765 **  |
| 5704.9125       | -20.0000 | -47.1534 **  | -46.7855 **  |
| 6519.9000       | -20.0000 | -44.6715 **  | -44.3162 **  |
| 7334.8875       | -20.0000 | -43.8276 **  | -43.8423 **  |
| 8149.8750       | -20.0000 | -42.9668 **  | -42.1555 **  |
|                 |          |  |  |
|                 |          |  |  |

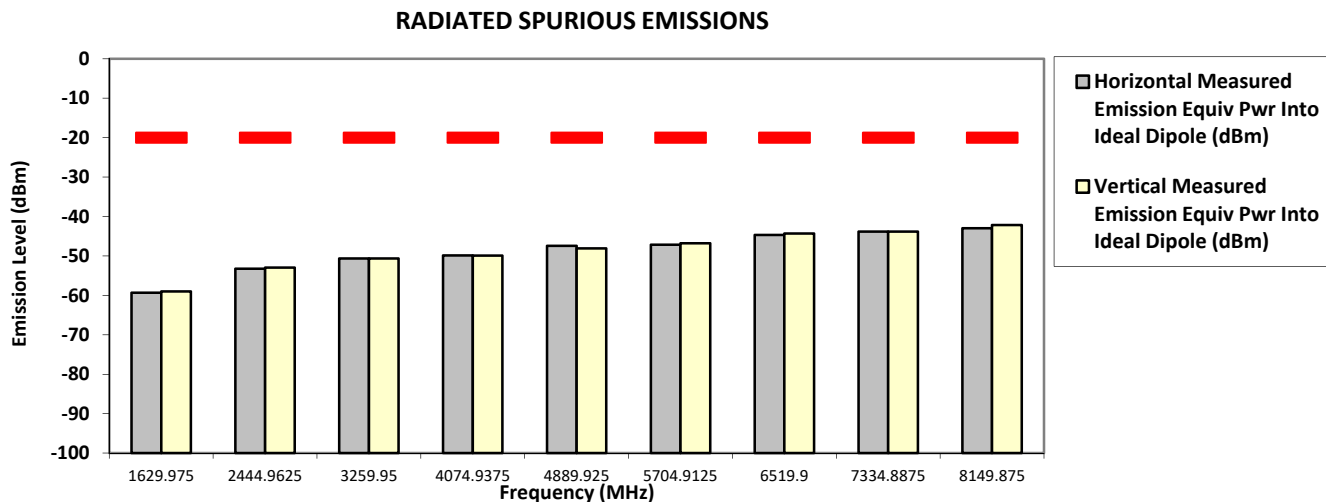

The data presented here was taken using the substitution method as found in the ANSI C63.26-2015 document.  
 Motorola Penang EMC Lab - Test Performed by: Qawiman&Aiman      Thu, 4 Aug, 2022

Remarks: \*\* Indicates the spurious emission could not be detected due to noise limitations or ambient.  
 \*Pursuant to CFR 47 Part 2.1057 ( c ), emissions attenuated more than 20 dB below the permissible limit are not reported  
 Temp(Deg): 23.4 Hum(%RH): 69.6

Remarks: Passed Results Marginal Results Failed Results

**SAC Transmitter Radiated Emission:**

**Model Number: H35UCT9PW8AN**      **S/N: 022TYP0004**      **SR:26977-EMC-00102**  
**Battery Part No: PMMN4817A**      **Accy Part No: NA**  
**Test Mode: TX APCO Digital C4FM**  
**823.987500 MHz**      **12.5 kHz**      **3.600 Watt(s) /Max Power**

| Frequency (MHz) | Limit    | Horizontal Measured Emission Equiv Pwr Into Ideal Dipole (dBm) | Vertical Measured Emission Equiv Pwr Into ideal Dipole (dBm) |
|-----------------|----------|--|--|
| 1647.9750       | -20.0000 | -58.8520 **  | -59.6045 **  |
| 2471.9625       | -20.0000 | -53.8428 **  | -53.6343 **  |
| 3295.9500       | -20.0000 | -51.1837 **  | -51.7054 **  |
| 4119.9375       | -20.0000 | -50.7381 **  | -50.4299 **  |
| 4943.9250       | -20.0000 | -47.8034 **  | -47.7318 **  |
| 5767.9125       | -20.0000 | -46.1318 **  | -46.4690 **  |
| 6591.9000       | -20.0000 | -44.7706 **  | -45.1273 **  |
| 7415.8875       | -20.0000 | -42.7155 **  | -42.4750 **  |
| 8239.8750       | -20.0000 | -42.7389 **  | -41.4469 **  |
|                 |          |  |  |
|                 |          |  |  |

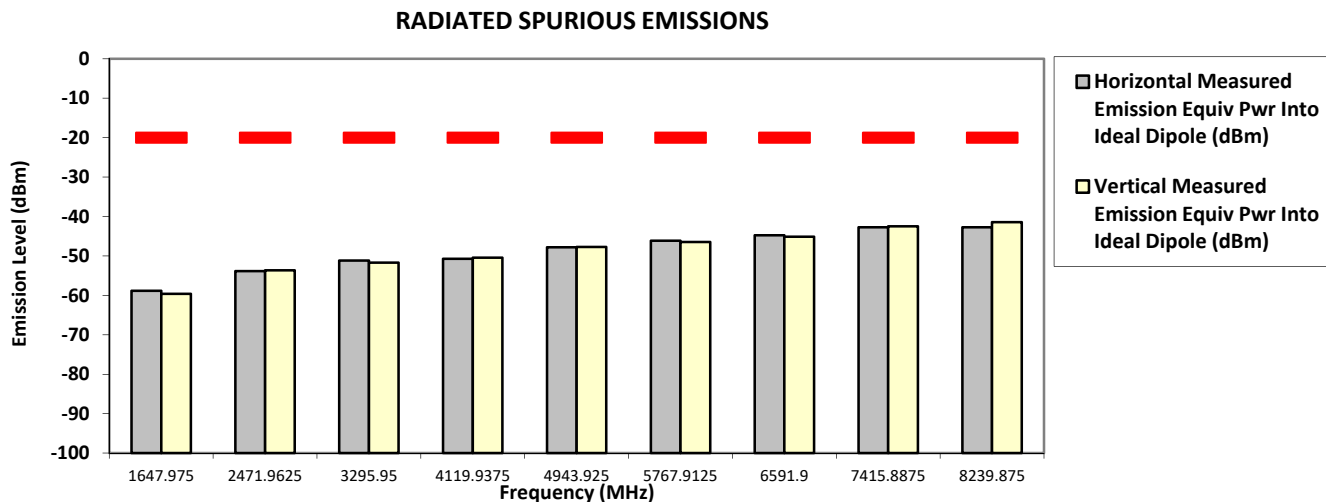

The data presented here was taken using the substitution method as found in the ANSI C63.26-2015 document.  
 Motorola Penang EMC Lab - Test Performed by: Qawiman&Aiman      Thu, 4 Aug, 2022

Remarks: \*\* Indicates the spurious emission could not be detected due to noise limitations or ambient.  
 \*Pursuant to CFR 47 Part 2.1057 ( c ), emissions attenuated more than 20 dB below the permissible limit are not reported  
 Temp(Deg): 23.4 Hum(%RH): 69.6

Remarks: Passed Results Marginal Results Failed Results

**SAC Transmitter Radiated Emission:**

**Model Number: H35UCT9PW8AN**      **S/N: 022TYP0004**      **SR:26977-EMC-00102**  
**Battery Part No: PMMN4817A**      **Accy Part No: NA**  
**Test Mode: TX APCO Digital C4FM**  
**851.012500 MHz**      **12.5 kHz**      **3.600 Watt(s) /Max Power**

| Frequency (MHz) | Limit    | Horizontal Measured Emission Equiv Pwr Into Ideal Dipole (dBm) | Vertical Measured Emission Equiv Pwr Into ideal Dipole (dBm) |
|-----------------|----------|--|--|
| 1702.0250       | -20.0000 | -58.9724 **  | -59.3829 **  |
| 2553.0375       | -20.0000 | -53.3323 **  | -53.1413 **  |
| 3404.0500       | -20.0000 | -51.8835 **  | -51.4559 **  |
| 4255.0625       | -20.0000 | -50.5842 **  | -50.0072 **  |
| 5106.0750       | -20.0000 | -47.2528 **  | -46.8787 **  |
| 5957.0875       | -20.0000 | -45.8505 **  | -46.0318 **  |
| 6808.1000       | -20.0000 | -44.9167 **  | -44.1303 **  |
| 7659.1125       | -20.0000 | -43.0709 **  | -42.1303 **  |
| 8510.1250       | -20.0000 | -41.9307 **  | -41.8435 **  |
|                 |          |  |  |
|                 |          |  |  |

**RADIATED SPURIOUS EMISSIONS**

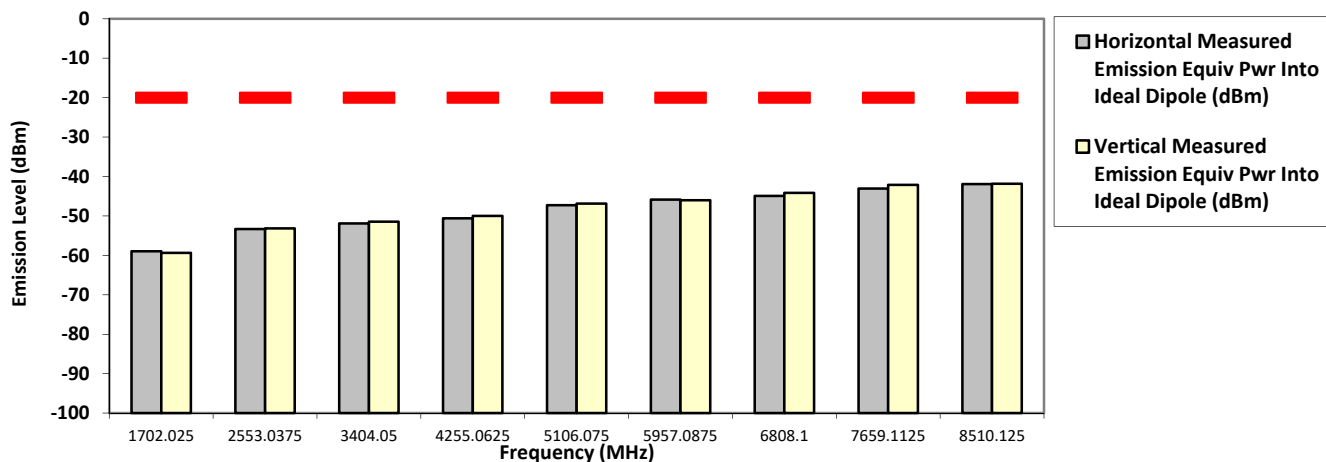

The data presented here was taken using the substitution method as found in the ANSI C63.26-2015 document.  
 Motorola Penang EMC Lab - Test Performed by: Qawiman&Aiman      Thu, 4 Aug, 2022

Remarks: \*\* Indicates the spurious emission could not be detected due to noise limitations or ambient.  
 \*Pursuant to CFR 47 Part 2.1057 ( c ), emissions attenuated more than 20 dB below the permissible limit are not reported  
 Temp(Deg): 23.4 Hum(%RH): 69.6

Remarks: Passed Results Marginal Results Failed Results

**SAC Transmitter Radiated Emission:**

**Model Number: H35UCT9PW8AN**      **S/N: 022TYP0004**      **SR:26977-EMC-00102**  
**Battery Part No: PMMN4817A**      **Accy Part No: NA**  
**Test Mode: TX APCO Digital C4FM**  
**860.012500 MHz**      **12.5 kHz**      **3.600 Watt(s) /Max Power**

| Frequency (MHz) | Limit    | Horizontal Measured Emission Equiv Pwr Into Ideal Dipole (dBm) | Vertical Measured Emission Equiv Pwr Into ideal Dipole (dBm) |
|-----------------|----------|--|--|
| 1720.0250       | -20.0000 | -58.7930 **  | -58.6400 **  |
| 2580.0375       | -20.0000 | -53.3675 **  | -52.9234 **  |
| 3440.0500       | -20.0000 | -52.1050 **  | -51.6158 **  |
| 4300.0625       | -20.0000 | -49.5230 **  | -50.8105 **  |
| 5160.0750       | -20.0000 | -47.4497 **  | -47.3761 **  |
| 6020.0875       | -20.0000 | -46.0744 **  | -46.2666 **  |
| 6880.1000       | -20.0000 | -44.4261 **  | -43.9005 **  |
| 7740.1125       | -20.0000 | -43.1182 **  | -43.4036 **  |
| 8600.1250       | -20.0000 | -41.5129 **  | -39.8914 **  |
|                 |          |  |  |
|                 |          |  |  |

**RADIATED SPURIOUS EMISSIONS**

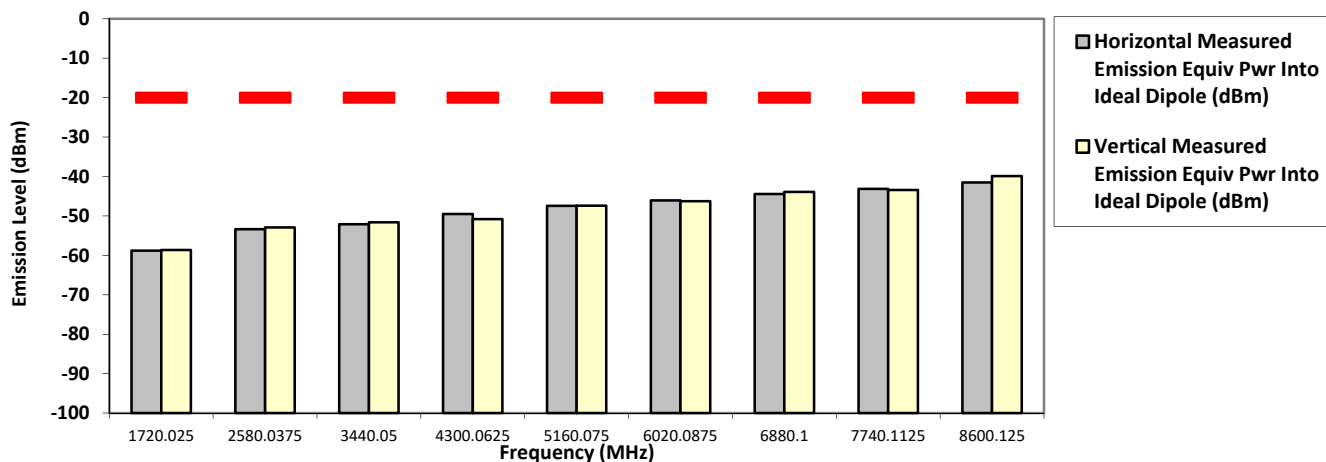

The data presented here was taken using the substitution method as found in the ANSI C63.26-2015 document.  
 Motorola Penang EMC Lab - Test Performed by: Qawiman&Aiman      Thu, 4 Aug, 2022

Remarks: \*\* Indicates the spurious emission could not be detected due to noise limitations or ambient.  
 \*Pursuant to CFR 47 Part 2.1057 ( c ), emissions attenuated more than 20 dB below the permissible limit are not reported  
 Temp(Deg): 23.4 Hum(%RH): 69.6

Remarks: Passed Results Marginal Results Failed Results



**SAC Transmitter Radiated Emission:**

**Model Number: H35UCT9PW8AN**      **S/N: 022TYP0004**      **SR:26977-EMC-00102**  
**Battery Part No: PMMN4817A**      **Accy Part No: NA**  
**Test Mode: TX APCO Digital C4FM**  
**868.887500 MHz**      **12.5 kHz**      **3.600 Watt(s) /Max Power**

| Frequency (MHz) | Limit    | Horizontal Measured Emission Equiv Pwr Into Ideal Dipole (dBm) | Vertical Measured Emission Equiv Pwr Into ideal Dipole (dBm) |
|-----------------|----------|--|--|
| 1737.7750       | -20.0000 | -58.7825 **  | -57.8625 **  |
| 2606.6625       | -20.0000 | -53.9885 **  | -54.0310 **  |
| 3475.5500       | -20.0000 | -52.5413 **  | -52.2163 **  |
| 4344.4375       | -20.0000 | -50.7934 **  | -50.6583 **  |
| 5213.3250       | -20.0000 | -46.5602 **  | -47.6683 **  |
| 6082.2125       | -20.0000 | -45.8084 **  | -46.2494 **  |
| 6951.1000       | -20.0000 | -43.9583 **  | -44.0779 **  |
| 7819.9875       | -20.0000 | -42.8129 **  | -43.0893 **  |
| 8688.8750       | -20.0000 | -41.8047 **  | -42.0695 **  |
|                 |          |  |  |
|                 |          |  |  |

**RADIATED SPURIOUS EMISSIONS**

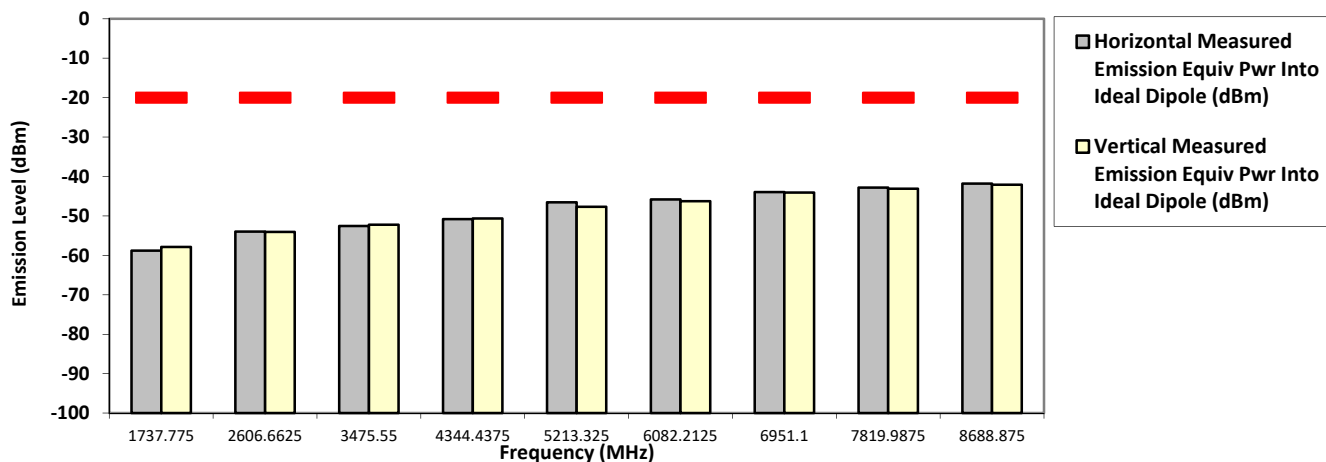

The data presented here was taken using the substitution method as found in the ANSI C63.26-2015 document.  
 Motorola Penang EMC Lab - Test Performed by: Qawiman&Aiman      Thu, 4 Aug, 2022

Remarks: \*\* Indicates the spurious emission could not be detected due to noise limitations or ambient.  
 \*Pursuant to CFR 47 Part 2.1057 ( c ), emissions attenuated more than 20 dB below the permissible limit are not reported  
 Temp(Deg): 23.4 Hum(%RH): 69.6

Remarks: Passed Results Marginal Results Failed Results

**SAC Transmitter Radiated Emission:**

**Model Number: H35UCT9PW8AN**      **S/N: 022TYP0004**      **SR:26977-EMC-00102**  
**Battery Part No: PMMN4817A**      **Accy Part No: NA**  
**Test Mode: TX APCO Phase II**  
**806.012500 MHz**      **12.5 kHz**      **3.600 Watt(s) /Max Power**

| Frequency (MHz) | Limit    | Horizontal Measured Emission Equiv Pwr Into Ideal Dipole (dBm) | Vertical Measured Emission Equiv Pwr Into ideal Dipole (dBm) |
|-----------------|----------|--|--|
| 1612.0250       | -20.0000 | -58.4938 **  | -58.7865 **  |
| 2418.0375       | -20.0000 | -54.7477 **  | -54.2046 **  |
| 3224.0500       | -20.0000 | -49.5786 **  | -50.4530 **  |
| 4030.0625       | -20.0000 | -51.2244 **  | -50.8840 **  |
| 4836.0750       | -20.0000 | -47.8751 **  | -48.3178 **  |
| 5642.0875       | -20.0000 | -46.7220 **  | -47.1278 **  |
| 6448.1000       | -20.0000 | -45.5926 **  | -44.5866 **  |
| 7254.1125       | -20.0000 | -42.7042 **  | -42.8111 **  |
| 8060.1250       | -20.0000 | -42.7663 **  | -43.1047 **  |
|                 |          |  |  |
|                 |          |  |  |
|                 |          |  |  |

**RADIATED SPURIOUS EMISSIONS**

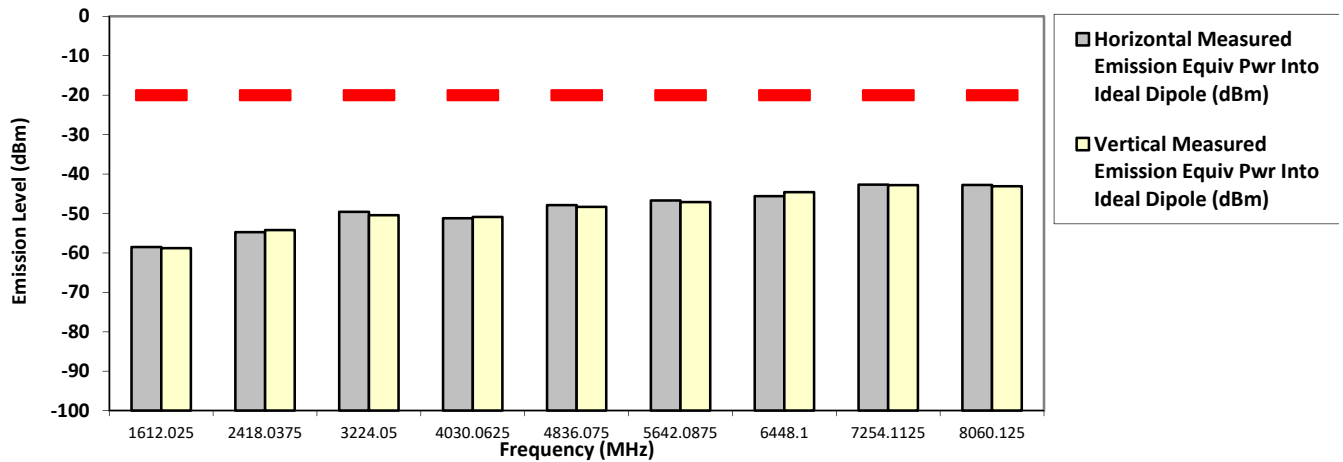

The data presented here was taken using the substitution method as found in the ANSI C63.26-2015 document.  
 Motorola Penang EMC Lab - Test Performed by: Qawiman&Aiman      Thu, 4 Aug, 2022

Remarks: \*\* Indicates the spurious emission could not be detected due to noise limitations or ambient.  
 \*Pursuant to CFR 47 Part 2.1057 ( c ), emissions attenuated more than 20 dB below the permissible limit are not reported  
 Temp(Deg): 23.4 Hum(%RH): 69.6

Remarks: Passed Results Marginal Results Failed Results

SAC Transmitter Radiated Emission:

Model Number: H35UCT9PW8AN

S/N: 022TYP0004

SR:26977-EMC-00102

Battery Part No: PMMN4817A

Accy Part No: NA

Test Mode: TX APCO Phase II

814.987500 MHz

12.5 kHz

3.600 Watt(s) /Max Power

| Frequency (MHz) | Limit    | Horizontal Measured Emission Equip Pwr Into Ideal Dipole (dBm) | Vertical Measured Emission Equip Pwr Into ideal Dipole (dBm) |
|-----------------|----------|--|--|
| 1629.9750       | -20.0000 | -58.6644 **  | -58.8802 **  |
| 2444.9625       | -20.0000 | -53.5949 **  | -54.5637 **  |
| 3259.9500       | -20.0000 | -50.9022 **  | -51.6642 **  |
| 4074.9375       | -20.0000 | -50.3118 **  | -50.1776 **  |
| 4889.9250       | -20.0000 | -47.2503 **  | -48.8272 **  |
| 5704.9125       | -20.0000 | -46.8301 **  | -46.2790 **  |
| 6519.9000       | -20.0000 | -45.3119 **  | -45.1032 **  |
| 7334.8875       | -20.0000 | -43.7087 **  | -42.7830 **  |
| 8149.8750       | -20.0000 | -42.0768 **  | -42.7682 **  |
|                 |          |  |  |
|                 |          |  |  |
|                 |          |  |  |

RADIATED SPURIOUS EMISSIONS

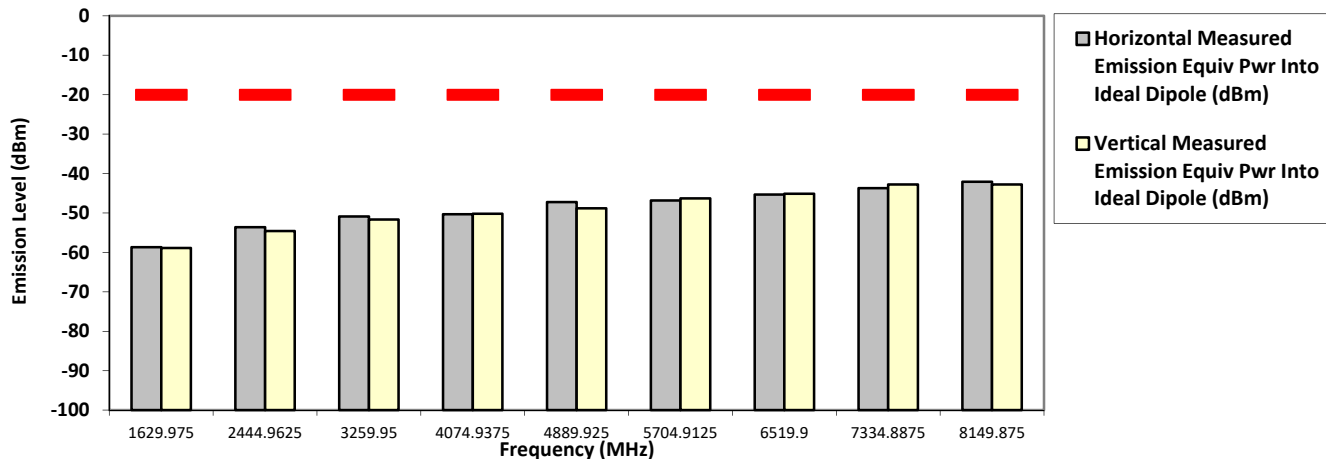

The data presented here was taken using the substitution method as found in the ANSI C63.26-2015 document.  
 Motorola Penang EMC Lab - Test Performed by: Qawiman&Aiman Thu, 4 Aug, 2022

Remarks: \*\* Indicates the spurious emission could not be detected due to noise limitations or ambient.

\*Pursuant to CFR 47 Part 2.1057 ( c ), emissions attenuated more than 20 dB below the permissible limit are not reported  
 Temp(Deg): 23.4 Hum(%RH): 69.6

Remarks: Passed Results Marginal Results Failed Results

**SAC Transmitter Radiated Emission:**

**Model Number: H35UCT9PW8AN**      **S/N: 022TYP0004**      **SR:26977-EMC-00102**  
**Battery Part No: PMMN4817A**      **Accy Part No: NA**  
**Test Mode: TX APCO Phase II**  
**823.987500 MHz**      **12.5 kHz**      **3.600 Watt(s) /Max Power**

| Frequency (MHz) | Limit    | Horizontal Measured Emission Equip Pwr Into Ideal Dipole (dBm) | Vertical Measured Emission Equip Pwr Into ideal Dipole (dBm) |
|-----------------|----------|--|--|
| 1647.9750       | -20.0000 | -58.7932 **  | -59.2456 **  |
| 2471.9625       | -20.0000 | -54.2109 **  | -53.8109 **  |
| 3295.9500       | -20.0000 | -51.4236 **  | -50.7567 **  |
| 4119.9375       | -20.0000 | -49.8093 **  | -50.1854 **  |
| 4943.9250       | -20.0000 | -47.6196 **  | -47.3842 **  |
| 5767.9125       | -20.0000 | -46.8435 **  | -46.7830 **  |
| 6591.9000       | -20.0000 | -44.4363 **  | -43.3446 **  |
| 7415.8875       | -20.0000 | -41.9259 **  | -43.6176 **  |
| 8239.8750       | -20.0000 | -41.3529 **  | -42.2256 **  |
|                 |          |  |  |
|                 |          |  |  |
|                 |          |  |  |

**RADIATED SPURIOUS EMISSIONS**

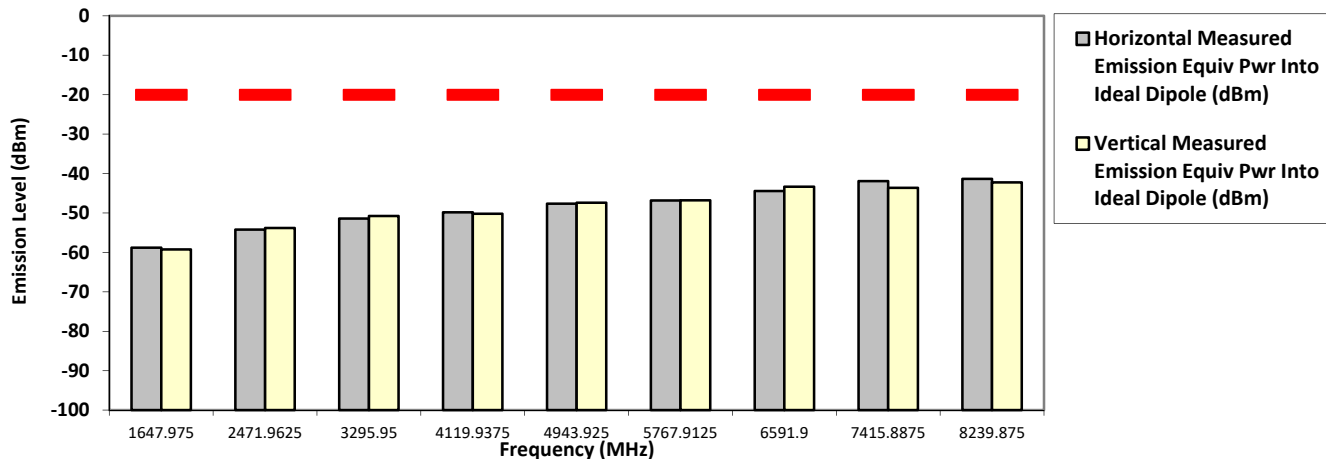

The data presented here was taken using the substitution method as found in the ANSI C63.26-2015 document.  
 Motorola Penang EMC Lab - Test Performed by: Qawiman&Aiman      Thu, 4 Aug, 2022

Remarks: \*\* Indicates the spurious emission could not be detected due to noise limitations or ambient.  
 \*Pursuant to CFR 47 Part 2.1057 ( c ), emissions attenuated more than 20 dB below the permissible limit are not reported  
 Temp(Deg): 23.4 Hum(%RH): 69.6

Remarks: Passed Results Marginal Results Failed Results

**SAC Transmitter Radiated Emission:**

**Model Number: H35UCT9PW8AN**

**S/N: 022TYP0004**

**SR:26977-EMC-00102**

**Battery Part No: PMMN4817A**

**Accy Part No: NA**

**Test Mode: TX APCO Phase II**

**851.012500 MHz**

**12.5 kHz**

**3.600 Watt(s) /Max Power**

| Frequency (MHz) | Limit    | Horizontal Measured Emission Equip Pwr Into Ideal Dipole (dBm) | Vertical Measured Emission Equip Pwr Into ideal Dipole (dBm) |
|-----------------|----------|--|--|
| 1702.0250       | -20.0000 | -59.2536 **  | -59.2608 **  |
| 2553.0375       | -20.0000 | -54.0655 **  | -54.1292 **  |
| 3404.0500       | -20.0000 | -50.8709 **  | -51.9341 **  |
| 4255.0625       | -20.0000 | -50.0388 **  | -49.9889 **  |
| 5106.0750       | -20.0000 | -47.8305 **  | -46.2911 **  |
| 5957.0875       | -20.0000 | -45.3092 **  | -45.0373 **  |
| 6808.1000       | -20.0000 | -44.5090 **  | -44.2596 **  |
| 7659.1125       | -20.0000 | -41.9609 **  | -42.9698 **  |
| 8510.1250       | -20.0000 | -41.9015 **  | -42.2363 **  |
|                 |          |  |  |
|                 |          |  |  |
|                 |          |  |  |

**RADIATED SPURIOUS EMISSIONS**

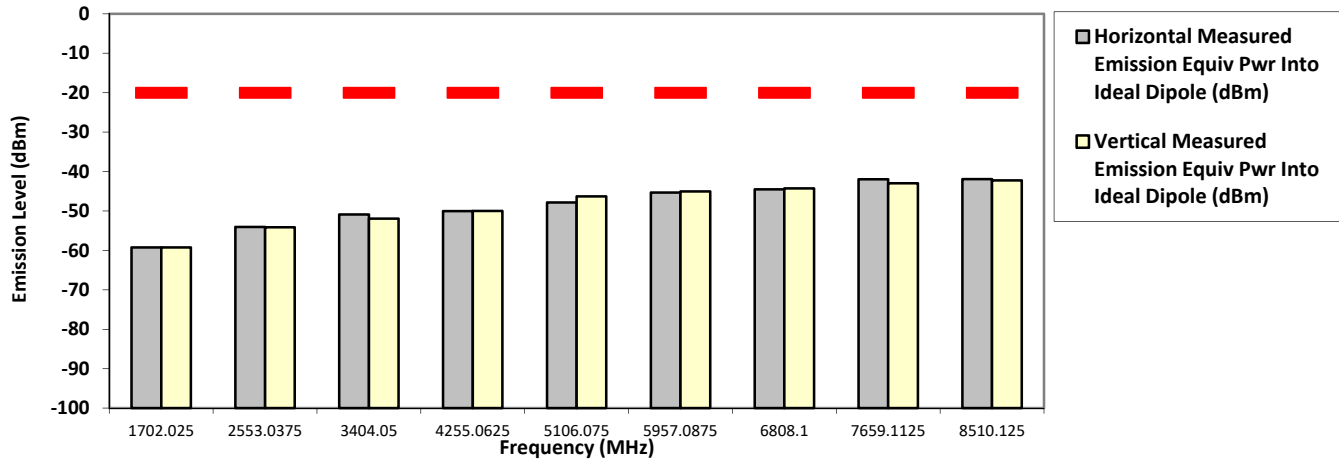

The data presented here was taken using the substitution method as found in the ANSI C63.26-2015 document.

Motorola Penang EMC Lab - Test Performed by: Qawiman&Aiman

Thu, 4 Aug, 2022

Remarks: \*\* Indicates the spurious emission could not be detected due to noise limitations or ambient.

\*Pursuant to CFR 47 Part 2.1057 ( c ), emissions attenuated more than 20 dB below the permissible limit are not reported

Temp(Deg): 23.4 Hum(%RH): 69.6

Remarks:

|                |                  |                |
|----------------|------------------|----------------|
| Passed Results | Marginal Results | Failed Results |
|----------------|------------------|----------------|

**SAC Transmitter Radiated Emission:**

**Model Number: H35UCT9PW8AN**

**S/N: 022TYP0004**

**SR:26977-EMC-00102**

**Battery Part No: PMMN4817A**

**Accy Part No: NA**

**Test Mode: TX APCO Phase II**

**860.012500 MHz**

**12.5 kHz**

**3.600 Watt(s) /Max Power**

| Frequency (MHz) | Limit    | Horizontal Measured Emission Equiv Pwr Into Ideal Dipole (dBm) | Vertical Measured Emission Equiv Pwr Into ideal Dipole (dBm) |
|-----------------|----------|--|--|
| 1720.0250       | -20.0000 | -58.5313 **  | -60.1652 **  |
| 2580.0375       | -20.0000 | -53.7852 **  | -55.0696 **  |
| 3440.0500       | -20.0000 | -52.0305 **  | -52.4219 **  |
| 4300.0625       | -20.0000 | -50.5164 **  | -49.9738 **  |
| 5160.0750       | -20.0000 | -46.8142 **  | -47.7087 **  |
| 6020.0875       | -20.0000 | -45.8301 **  | -45.1108 **  |
| 6880.1000       | -20.0000 | -45.0349 **  | -44.7962 **  |
| 7740.1125       | -20.0000 | -43.3080 **  | -43.3375 **  |
| 8600.1250       | -20.0000 | -41.1605 **  | -41.3220 **  |
|                 |          |  |  |
|                 |          |  |  |

**RADIATED SPURIOUS EMISSIONS**

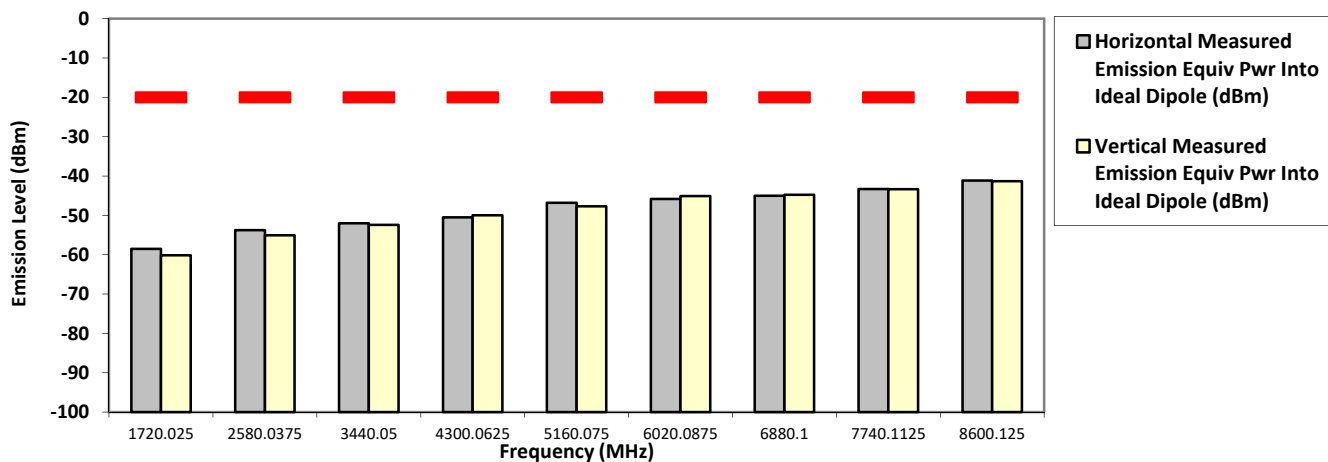

The data presented here was taken using the substitution method as found in the ANSI C63.26-2015 document.  
 Motorola Penang EMC Lab - Test Performed by: Qawiman&Aiman Thu, 4 Aug, 2022

Remarks: \*\* Indicates the spurious emission could not be detected due to noise limitations or ambient.  
 \*Pursuant to CFR 47 Part 2.1057 ( c ), emissions attenuated more than 20 dB below the permissible limit are not reported  
 Temp(Deg): 23.4 Hum(%RH): 69.6

Remarks:

|                |                  |                |
|----------------|------------------|----------------|
| Passed Results | Marginal Results | Failed Results |
|----------------|------------------|----------------|

**SAC Transmitter Radiated Emission:**

**Model Number: H35UCT9PW8AN**      **S/N: 022TYP0004**      **SR:26977-EMC-00102**  
**Battery Part No: PMMN4817A**      **Accy Part No: NA**  
**Test Mode: TX APCO Phase II**  
**868.887500 MHz**      **12.5 kHz**      **3.600 Watt(s) /Max Power**

| Frequency (MHz) | Limit    | Horizontal Measured Emission Equip Pwr Into Ideal Dipole (dBm) | Vertical Measured Emission Equip Pwr Into ideal Dipole (dBm) |
|-----------------|----------|--|--|
| 1737.7750       | -20.0000 | -57.6263 **  | -59.5869 **  |
| 2606.6625       | -20.0000 | -53.8076 **  | -53.7742 **  |
| 3475.5500       | -20.0000 | -52.5064 **  | -51.1421 **  |
| 4344.4375       | -20.0000 | -50.4452 **  | -49.6094 **  |
| 5213.3250       | -20.0000 | -47.4803 **  | -47.8301 **  |
| 6082.2125       | -20.0000 | -46.2682 **  | -45.1210 **  |
| 6951.1000       | -20.0000 | -44.7563 **  | -43.9539 **  |
| 7819.9875       | -20.0000 | -41.6844 **  | -42.8382 **  |
| 8688.8750       | -20.0000 | -41.6341 **  | -42.6801 **  |
|                 |          |  |  |
|                 |          |  |  |
|                 |          |  |  |

**RADIATED SPURIOUS EMISSIONS**

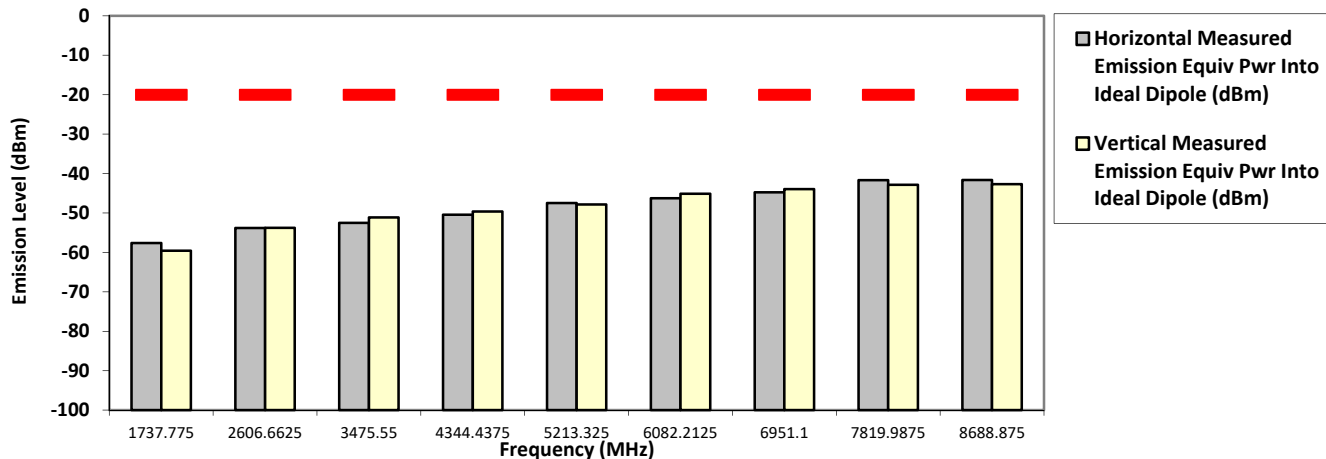

The data presented here was taken using the substitution method as found in the ANSI C63.26-2015 document.  
 Motorola Penang EMC Lab - Test Performed by: Qawiman&Aiman      Thu, 4 Aug, 2022

Remarks: \*\* Indicates the spurious emission could not be detected due to noise limitations or ambient.  
 \*Pursuant to CFR 47 Part 2.1057 ( c ), emissions attenuated more than 20 dB below the permissible limit are not reported  
 Temp(Deg): 23.4 Hum(%RH): 69.6

Remarks: Passed Results Marginal Results Failed Results

**6.10.4. Test Limit**

Table below summarized the power of any emission outside a licensee’s frequency block shall be attenuated below the transmitter power (P) by at least

| Channel Spacing | Part 22                                 | Part 24D                                | Part 74                                 | Part 80                                 | Part 90 (UHF, VHF, 800, 900)            | Part 90 (700)                           |
|-----------------|---|---|---|---|---|---|
| 12.5kHz         | 43 + log <sub>10</sub> (P)<br>(-13 dBm) | 43 + log <sub>10</sub> (P)<br>(-13 dBm) | 43 + log <sub>10</sub> (P)<br>(-13 dBm) | Not Applicable                          | 50 + log <sub>10</sub> (P)<br>(-20 dBm) | 43 + log <sub>10</sub> (P)<br>(-13 dBm) |
| 25kHz           |   | Not Applicable                          |   | 43 + log <sub>10</sub> (P)<br>(-13 dBm) | 43 + log <sub>10</sub> (P)<br>(-13 dBm) | 43 + log <sub>10</sub> (P)<br>(-13 dBm) |

| Channel Spacing | RSS 134                                 | RSS 182                                 | RSS 119 (UHF, VHF, 800, 900)            | RSS 119 (700)                           |
|-----------------|---|---|---|---|
| 12.5kHz         | 43 + log <sub>10</sub> (P)<br>(-13 dBm) | Not Applicable                          | 50 + log <sub>10</sub> (P)<br>(-20 dBm) | 43 + log <sub>10</sub> (P)<br>(-13 dBm) |
| 25kHz           | Not Applicable                          | 43 + log <sub>10</sub> (P)<br>(-13 dBm) | 43 + log <sub>10</sub> (P)<br>(-13 dBm) | 43 + log <sub>10</sub> (P)<br>(-13 dBm) |



## 6.11. Effective Radiated Power (ERP)

### 6.11.1. Test Setup

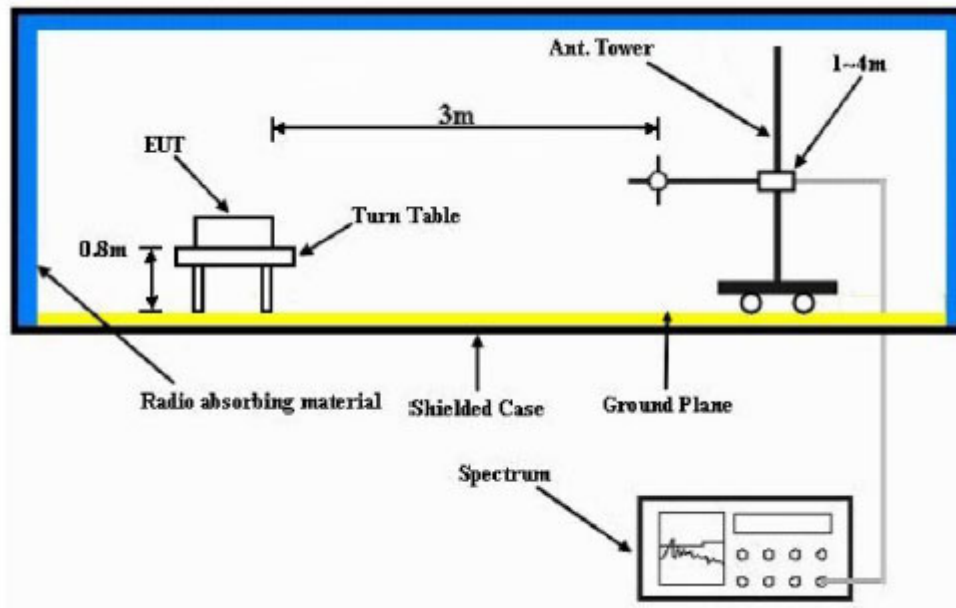

- 1) The Resolution Bandwidth for Equivalent Radiated Power (ERP) below 1 GHz is 100 kHz with Video Bandwidth = 300 kHz and Resolution Bandwidth for EIRP above 1 GHz is 1 MHz with Video Bandwidth = 3 MHz. Detector Mode is RMS.
- 2) In the semi-anechoic chamber, setup as illustrated above the DUT placed on the 0.8m height (for  $F_c < 1\text{GHz}$ ) or 1.5m (for  $F_c > 1\text{GHz}$ ) of Turn Table, rotated the table 45 degree each interval to search the maximum radiation power and receiver antenna shall be rotated vertical and horizontal polarization and moved height from 1m to 4m to find the maximum polar radiated power for each degree interval. The “Read Value” is the spectrum reading of maximum power value.
- 3) The substitution antenna is substituted for DUT at the same position and signals generator (S.G) export the CW signal to the substitution antenna via a TX cable. The receiver antenna shall be rotated vertical and horizontal polarization and moved height from 1m to 4m to find the maximum radiation power. Record the power level of maximum radiation power from spectrum. So, the Measured substitution value = Ref level of S.G + TX cables loss – Substituted Antenna Gain.

### 6.11.2. Test Result

**Not Applicable**

### 6.11.3. Test Limit

The maximum output power of the transmitter for mobile stations is 100 watts (20 dB). Power is given in terms of effective radiated power (ERP).

## 6.12. GNSS (EIRP for 1559 - 1610MHz)

### 6.12.1. Test Setup

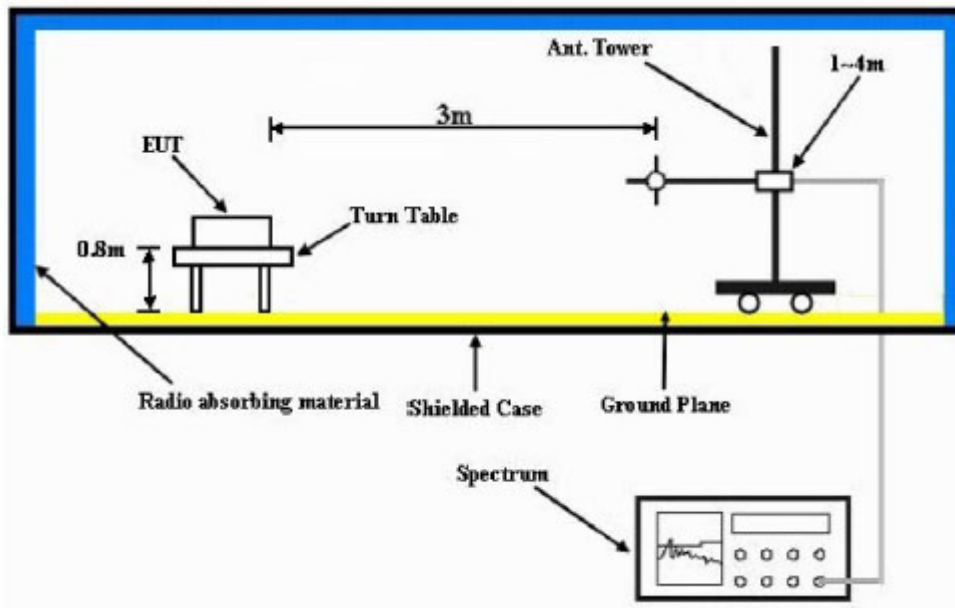

- 4) The Resolution Bandwidth for Equivalent Isotropically Radiated Power (EIRP) below 1 GHz is 100 kHz with Video Bandwidth = 300 kHz and Resolution Bandwidth for EIRP above 1 GHz is 1 MHz with Video Bandwidth = 3 MHz. Detector Mode is RMS.
- 5) In the semi-anechoic chamber, setup as illustrated above the DUT placed on the 0.8m height of Turn Table, rotated the table 45 degree each interval to search the maximum radiation power and receiver antenna shall be rotated vertical and horizontal polarization and moved height from 1m to 4m to find the maximum polar radiated power for each degree interval. The “Read Value” is the spectrum reading of maximum power value.
- 6) The substitution antenna is substituted for DUT at the same position and signals generator (S.G) export the CW signal to the substitution antenna via a TX cable. The receiver antenna shall be rotated vertical and horizontal polarization and moved height from 1m to 4m to find the maximum radiation power. Record the power level of maximum radiation power from spectrum. So, the Measured substitution value = Ref level of S.G + TX cables loss – Substituted Antenna Gain.
- 7)  $EIRP = \text{“Read Value”} + \text{Measured substitution value} + 2.15$ .

### 6.12.1. Test Result

**Not Applicable**

### 6.12.2. Test Limit

For operations in the 758-775 MHz and 788-805 MHz bands, all emissions including harmonics in the band 1559-1610 MHz shall be limited to  $-70$  dBW/MHz equivalent isotropically radiated power (EIRP) for wideband signals, and  $-80$  dBW EIRP for discrete emissions of less than 700 Hz bandwidth.

**~ End of Test Report ~**