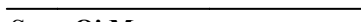
 <p>CERTIFICATE 2518.08</p> <p>MS ISO/IEC 17025 TESTING SAMM NO. 0825</p>
<p>MOTOROLA PENANG ADV. COMM. LABORATORY Motorola Solutions Malaysia SDN BHD, Plot 2A, Medan Bayan Lepas, Mukim 12 S.W.D, 11900 Bayan Lepas, Penang, Malaysia.</p>	<p>FCC/ISED TEST REPORT Report Revision : Rev.B</p>
<p>Date/s Tested : 02-AUG-2022 - 21-AUG-2022 Report Issue Date : 1-Sept-2022 Manufacturer : Motorola Solutions Malaysia SDN BHD Manufacturer Address : Plot 2A, Medan Bayan Lepas, Mukim 12 SWD, 11900 Bayan Lepas, Penang, Malaysia Requestor : CADOGAN SEAN Product Type : Hand-held Product Version (PMN) : APX N70 Model Number (HVIN) : H35UCT9PW8AN Frequency Band : 762-776MHz, 792-806MHz Max RF Output Power : 2.99 Watts Applicant Name : Motorola Solutions Inc Applicant Address : 8000 West Sunrise Boulevard, Fort Lauderdale, Florida 33322</p> <p>ISED Registrations : MY0001 FCC Registrations : 461337 Firmware Version (FVIN) : D00.00.45</p> <p>The equipment was tested accordance to the requirement listed below:</p> <p>(LMR) FCC 47 CFR Part 90 PASS ISED RSS- Gen Issue 5 / 119 Issue 12</p>	
<p>This report shall not be reproduced without written approval from an officially designated representative of the Motorola Penang Adv. Comm. Laboratory. The results and statements contained in this report pertain only to the device(s) evaluated.</p>	
<p>Prepared By:</p>  <p>Putri Nur Sarah Sofia Test Personnel</p>	<p>Approved Signatory:</p>  <p>Soon Oi May Responsible Engineer</p>

Table of Contents

Report Revision History	3
1.0 General Information.....	4
2.0 Summary of Test Results.....	5
3.0 Measurement Uncertainty.....	6
4.0 Equipment List.....	7
5.0 Test Condition.....	10
5.1. Transmitter Test Conditions	10
6.0 Transmitter Test Parameters	11
6.1. RF Output Power	11
6.1.1. Test Setup	11
6.1.2. Test Result	11
6.2. Frequency Stability	12
6.2.1. Test Setup	12
6.2.2. Test Result	13
6.2.3. Test Limit.....	14
6.3. Modulation Characteristics	15
6.3.1. Test Setup	15
6.3.2. Test Result	16
6.3.3. Test Limit.....	16
6.4. Modulation Limiting.....	17
6.4.1. Test Setup	17
6.4.2. Test Result	18
6.4.3. Test Limit.....	18
6.5. Occupied Bandwidth.....	19
6.5.1. Test Setup (Analog).....	19
6.5.2. Test Result (Analog).....	19
6.5.3. Test Setup (Digital).....	19
6.5.4. Test Result (Digital).....	20
6.5.5. Test Limit.....	20
6.6. Band Edge Conducted Spurious Emission (Part 22)	21
6.6.1. Test Setup (Analog).....	21
6.6.2. Test Result (Analog).....	21
6.6.3. Test Setup (Digital).....	22
6.6.4. Test Result (Digital).....	22
6.6.5. Test Limit.....	22
6.7. Transient Frequency Behavior.....	23
6.7.1. Test Setup	23
6.7.2. Test Result	23
6.7.3. Test Limit.....	24
6.8. Adjacent Channel Power.....	25
6.8.1. Test Setup (Analog).....	25
6.8.2. Test Result	26
6.8.3. Test Setup (Digital).....	28

6.8.4. Test Result 29
 6.8.5. Test Limit..... 37
 6.9. Conducted Spurious Emission 39
 6.9.1. Test Setup 39
 6.9.2. Test Result (Analog)..... 40
 6.9.3. Test Result (Digital)..... 47
 6.9.4. Test Limit..... 61
 6.10. Radiated Spurious Emission 62
 6.10.1. Test Setup 62
 6.10.2. Test Result (Analog)..... 63
 6.10.3. Test Result (Digital)..... 70
 6.10.4. Test Limit..... 83
 6.11. Effective Radiated Power (ERP) 85
 6.11.1. Test Setup 85
 6.11.2. Test Result 86
 6.11.3. Test Limit..... 89
 6.12. GNSS (EIRP for 1559 - 1610MHz)..... 90
 6.12.1. Test Setup 90
 6.12.1. Test Result 91
 6.12.2. Test Limit..... 91

Report Revision History

Revision History	Description	Date	Originator
Rev. A	Initial Report	23-AUG-2022	Putri
Rev. B	Updated Itinerant TX measured conducted power	14-SEP-2022	Putri

1.0 General Information

EUT Description:

Technologies	Land Mobile Radio (LMR)
Modulation Type	Analog, C4FM, Phase II

The EUT contains following accessory devices and data cable:

Item	Brand	Model or P/N
Standard 3200mAh (new 18650 Li-Ion cell)	MOTOROLA	PMNN4816A
Hi Cap 4400mAH (using RN 2170 Li-Ion cell) Non-UL battery	MOTOROLA	PMNN4817A
7800 Whip Antenna 762-870MHz	MOTOROLA	AN000411A01
CHARGER,CHGR DESKTOP SINGLE UNIT IMPRES 2 EXT PS BASE ONLY	MOTOROLA	PMPN4591A
POWER CORD US for MUC	MOTOROLA	3087791G01
GCAI-mini Programming & Test Cable	MOTOROLA	PMKN4231A
CHARGER,CHGR DESKTOP SINGLE UNIT IMPRES 2 EXT PS BASE ONLY	MOTOROLA	PMPN4590A
PWR SUPPLY WALL CUBE,AC,DC 110VAC FIXED BLADE US 14.5V/2.5A L6 BARREL	MOTOROLA	PS000040A01
Vehicular charger	MOTOROLA	PMPN4639A

General Description of Applied Standards

The EUT is a RF Product. According to the specifications of the manufacturer, the EUT is to comply with the requirements of the following standards:

ANSI C63.26-2015

No modifications were done to the UUT to facilitate the tests in this report.

Deviation from standard

Not applicable as no deviation from standard test method

Antenna gain disclaimer

Antenna gain information is provided by customer. The validity of the results is dependent upon this information. The lab will not be held accountable in the event the supplied information affects compliance.

Test configuration of EUT

All relevant configurations involving radio models and accessories (including chargers, batteries, and antennas) were assessed. Only worst case configurations will be included in this report.

2.0 Summary of Test Results

FCC General Rules Part (47CFR)	ISED General Rules Part	Test Item	Result	Remarks	Serial number tested
2.1046, 90.541	RSS-Gen, RSS-119	RF Power Output	Pass		022TYP0067
2.1055, 90.213	RSS-Gen, RSS-119	Frequency Stability	Pass		022TYP0067
2.1047	RSS-Gen, RSS-119	Audio Frequency Response	Pass		022TYP0067
2.1047	RSS-Gen, RSS-119	Audio Low Pass Filter Response	Pass		022TYP0067
2.1047	RSS-Gen, RSS-119	Modulation limiting	Pass		022TYP0067
-	-	Occupied Bandwidth	NA		
-	-	Band Edge Conducted Spurious Emission	NA		
-	-	Transient Frequency Behavior	NA		
90.543	RSS-119	Adjacent Channel Power	Pass		022TYP0067
2.1051, 90.210	RSS-Gen, RSS-119	Conducted Spurious Emissions	Pass	Worst case: -33.16dBm	022TYP0067
2.1051, 90.210	RSS-Gen, RSS-119	Radiated Spurious Emission	Pass	Worst case: -40.5752 dBm margin: 27.5752 dB (noise floor)	022TYP0037
90.210	RSS-119	GNSS (EIRP for 1559 – 1610MHz)	Pass		022TYP0037
90.210	RSS-119	Effective Radiated Power (ERP)	Pass		022TYP0037

NA → Not Applicable

3.0 Measurement Uncertainty

Measurement	Frequency	Expanded Uncertainty (k=1.96) (±)
AC Power Line Conducted Spurious Emission	150KHz ~ 30MHz	3.48 dB
Radiated Emissions up to 1 GHz dB μ V/m (Field Strength)	30MHz ~ 1000MHz	5.88 dB
Radiated Emissions above 1 GHz dB μ V/m (Field Strength)	1GHz ~ 18GHz	5.84 dB
	18GHz ~ 40GHz	6.02 dB
Radiated Emissions dBm (ERP/EiRP)	30MHz ~ 18GHz	4.03 dB
Conducted Spurious Emissions	9kHz ~ 12.75GHz	2.82 dB
Frequency Stability	9kHz ~ 12.75GHz	0.0085 ppm
Audio Frequency Response / Low Pass Filter Response	300Hz – 20kHz	4.09 %
Modulation Limiting	300Hz – 3kHz	1.15 %
Occupied Bandwidth	9kHz ~ 12.75GHz	2.82 dB
Band Edge Conducted Spurious Emission	9kHz ~ 12.75GHz	2.82 dB
Transient Frequency Behavior	9kHz ~ 12.75GHz	5.4 ms
Adjacent Channel Power	9kHz ~ 12.75GHz	2.82 dB

4.0 Equipment List

FCC Analog ATE#1: (SW version: FCC_Analog_v2.5.0)

Description	Model	Serial Number	Calibration Date	Calibration Due Date
CHAMBER	SH-641	92009188	21-Mar-22	21-Mar-23
POWER SENSOR	E4412A	MY41502652	09-Sep-21	09-Sep-22
POWER SUPPLY	6032A	3232A08203	14-Jun-21	14-Jun-22
POWER METER	E4416A	MY45101705	04-Mar-22	04-Mar-23
MODULATION ANALYZER	8901B	3403A04974	06-Sep-21	06-Sep-22
AUDIO ANALYZER	U8903B	MY61340003	21-Mar-22	21-Mar-23
CXA SIGNAL ANALYZER	N9000B	MY60250694	14-Dec-21	14-Dec-22
N to N RF Cable # 1	M17/128-RG400	NA	NA	NA
BNC to N RF Cable # 1	RG 58	NA	NA	NA
BNC to BNC RF Cable # 1	RG 58	NA	NA	NA
BNC to BNC RF Cable # 2	RG 58	NA	NA	NA
BNC to BNC RF Cable # 3	RG 58	NA	NA	NA
BNC to BNC RF Cable # 4	RG 58	NA	NA	NA
BNC to BNC RF Cable # 5	RG 58	NA	NA	NA
BNC to BNC RF Cable # 6	RG 58	NA	NA	NA
BNC to BNC RF Cable # 7	RG 58	NA	NA	NA
N to SMA RF Cable # 1	RG 58	NA	NA	NA
N to SMA RF Cable # 2	RG 58	NA	NA	NA
N to SMA RF Cable # 3	RG 58	NA	NA	NA
Aeroflex Attenuator 30dB	49-30-34-LIM	NA	NA	NA

FCC Transient ATE #1: (SW version: FCC Transient ATE_R1.1.4)

Description	Model	Serial Number	Calibration Date	Calibration Due Date
SWITCH CONTROL UNIT	3488A	2719A36210	CNR	CNR
ATTENUATOR / SWITCH DRIVER	11713A	2508A10141	CNR	CNR
POWER SENSOR	E9301B	MY41495393	09-Jun-22	09-Jun-23
SIGNAL GENERATOR	8657A	3315U04973	03-Sep-21	03-Sep-22
AUDIO ANALYZER	8903B	3011A10318	01-Nov-21	01-Nov-22
POWER METER	E4416A	GB41293240	14-Mar-22	14-Mar-23
STEP ATTENUATOR	8494G	MY42145194	12-Sep-21	12-Sep-22
POWER SUPPLY	6033A	3232A08203	03-Jun-22	03-Jun-23
ANALYZER SPECTRUM	E4445A	MY45301089	11-Oct-21	11-Oct-22
ATTENUATOR/110DB	8496G	MY42143970	12-Sep-21	12-Sep-22
AUDIO ANALYZER	8903B	3413A14586	13-Sep-21	13-Sep-22
ANALYZER MODULATION	8901B	2619A00845	30-Sep-21	30-Sep-22
AUDIO ANALYZER	8903B	3011A12488	13-Sep-21	13-Sep-22
N to N RF Cable # 1	SF126/11N/11N	NA	NA	NA
N to N RF Cable # 1	SF126/11N/11N	NA	NA	NA
N to N RF Cable # 2	M17/128-RG400	NA	NA	NA
N to N RF Cable # 3	M17/128-RG400	NA	NA	NA
N to N RF Cable # 4	M17/128-RG400	NA	NA	NA
N to N RF Cable # 5	M17/128-RG400	NA	NA	NA
N to N RF Cable # 6	M17/128-RG400	NA	NA	NA
N to N RF Cable # 7	M17/128-RG400	NA	NA	NA
N to N RF Cable # 8	M17/128-RG400	NA	NA	NA
N to N RF Cable # 9	M17/128-RG400	NA	NA	NA
BNC to BNC RF Cable # 1	RG 58	NA	NA	NA
BNC to BNC RF Cable # 2	RG 58	NA	NA	NA
BNC to BNC RF Cable # 3	RG 58	NA	NA	NA
BNC to BNC RF Cable # 4	RG 58	NA	NA	NA
BNC to BNC RF Cable # 5	RG 58	NA	NA	NA
BNC to BNC RF Cable # 6	RG 58	NA	NA	NA
BNC to N RF Cable # 1	RG 58	NA	NA	NA
Aeroflex Attenuator 10dB	49-10-43-LIM	NA	NA	NA
Aeroflex Attenuator 10dB	33-10-34-LIM	NA	NA	NA

FCC CONDUCTED SPUR EMISSION ATE # 1 (SW version: Conducted Spur ATE_rev 1.23.03)

Description	Model	Serial Number	Calibration Date	Calibration Due Date
SWITCH CONTROL UNIT	3488A	2719A32735	CNR	CNR
ANALYZER SPECTRUM	E4440A	MY46181250	23-May-22	23-May-23
POWER SUPPLY	6031A	3506A08076	19-Jan-22	19-Jan-23
INTERFACE BOX - FILTER	CNR	CS001	06-Jul-22	06-Oct-22
N to N RF Cable # 1	SF126/11N/11N	NA	NA	NA
N to N RF Cable # 2	SF126/11N/11N	NA	NA	NA
BNC to BNC RF Cable # 1	RG 58	NA	NA	NA
Aeroflex Attenuator 30dB	49-30-43-LIM	NA	NA	NA
Aeroflex Attenuator 10dB	33-10-34-LIM	NA	NA	NA

EMC Chamber 1

DESCRIPTION	MODEL	SERIAL NUMBER	CALIBRATION DATE	CALIBRATION DUE DATE
DRG HORN FREQ.	SAS-571	720	06-Apr-21	06-Apr-23
DRG HORN FREQ.	SAS-571	719	13-Sep-21	13-Sep-22
POWER SUPPLY	N7977A	MY54420118	17-Aug-21	17-Aug-22
SIGNAL GENERATOR	SMB 100A	182511	4-Jun-21	4-Jun-24
EMI TEST RECEIVER	ESW44	101731	5-Nov-21	5-Nov-22
5m SEMI-ANECHOIC CHAMBER	S800-HX	J2308	No Cal. Req'd	No Cal. Req'd
BILOG ANTENNA	CBL6112B	2863	22-Jun-22	22-Jun-23
BILOG ANTENNA	CBL6112D	30991	05-Oct-21	05-Oct-22
DATA LOGGER THERMOHYGROMETER	SDL500	A.016800	13-Jun-21	13-Jun-23
SYSTEM CONTROLLER	SC104V	050806-1	No Cal. Req'd	No Cal. Req'd
TURNTABLE FLUSH MOUNT 2M	FM2011	NA	No Cal. Req'd	No Cal. Req'd
ANTENNA POSITIONING TOWER	TLT2	NA	No Cal. Req'd	No Cal. Req'd
BROAD-BAND HORN ANTENNA	BBHA9170	BBHA9170255	18-Feb-22	18-Feb-23
PREAMPLIFIER 18-40GHz	BBV9721	9721-007	No Cal. Req'd	No Cal. Req'd
PREAMPLIFIER	PAM-0118P	361	11-Sep-20	11-Sep-23
LOOP ANTENNA	6502	00208416	8-Oct-21	8-Oct-22
TEST SOFTWARE	EMC_FCC_IC_BLUETOOTH_RE_TEST			
VERSION	EMC_FCC_RE_v1.6.4			

5.0 Test Condition

5.1. Transmitter Test Conditions

Test Item, (Channel Spacing)	Power (W)	Modulation	Test Frequency (MHz)	Tested By	Environmental conditions
RF Output Power	Low & Max	Analog	762.0125, 768.0125, 769.0875, 774.8875, 775.9875, 792.0125, , 799.0875, 804.9125, 805.9875	Putri	23.4°C, 50%RH
Frequency Stability	Max	Analog	769.0875	Putri	25.1°C, 54.3%RH, 60.3°C, 50%RH, -30.1°C, 51.2%RH
Audio Frequency Response (12.5kHz / 25kHz)	Max	Analog	769.0875	Putri	23.4°C, 50%RH
Audio Low Pass Filter Response (12.5kHz / 25kHz)	Max	Analog	769.0875	Putri	23.4°C, 50%RH
Modulation limiting (12.5kHz / 25kHz)	Max	Analog	769.0875	Putri	23.4°C, 50%RH
Occupied Bandwidth (12.5kHz / 20kHz / 25kHz)	Max	Analog, C4FM, Phase II	NA		
Band Edge Conducted Spurious Emissions (Part 22) (12.5kHz / 20kHz / 25kHz)	Max	Analog, C4FM, Phase II	NA		
Transient Frequency Behavior (UHF & VHF Band) (12.5kHz / 25kHz)	Max	Analog, C4FM, Phase II	NA		
Adjacent Channel Power (700MHz Band) (12.5kHz / 25kHz)	Max	Analog, C4FM, Phase II	769.0875, 774.8875, 799.0875, 804.9125	Putri	23.4°C, 50%RH
Conducted Spurious Emissions- (12.5kHz / 25kHz)	Low / Max	Analog, C4FM, Phase II	762.0125, 769.0125, 769.0875, 774.8875, 792.0125, 799.0875, 804.9125	Putri	23.4°C, 50%RH
Radiated Spurious Emission (12.5kHz / 25kHz)	Low / Max	Analog, C4FM, Phase II	762.0125, 769.0125, 769.0875, 774.8875, 792.0125, 799.0875, 804.9125	Nazrin & Qawiman	23.4°C, 69.6%RH
GNSS (EIRP for 1559 - 1610MHz) (12.5kHz / 25kHz)	Max	Analog	799.0875, 804.9125	Nazrin & Qawiman	23.4°C, 69.6%RH
Effective Radiated Power (ERP) (12.5kHz / 25kHz)	Max	Analog	769.0125, 769.0875, 799.0125, 804.9125	Nazrin & Qawiman	23.4°C, 69.6%RH

NA → Not Applicable

6.0 Transmitter Test Parameters

6.1 RF Output Power

6.1.1 Test Setup

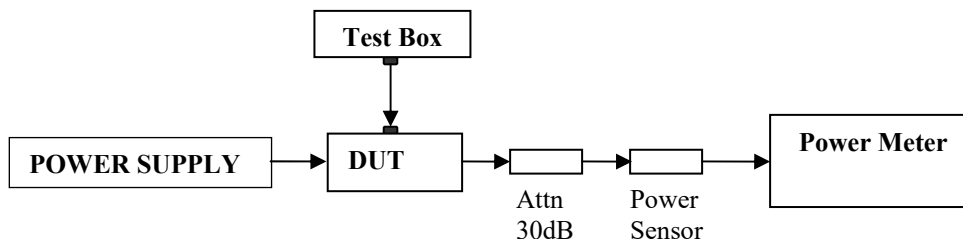

- 1) The DUT transmitter connected to Power Meter using the 30 dB attenuator and power sensor with above setup.
- 2) Path loss for the measurement included.
- 3) All the measurement was done at low, mid, high frequency for each band.
- 4) Record the power into the test report.

6.1.2 Test Result

Temperature	25°C				Remark
Voltage (V)	7.5V				
Frequency (MHz)	Low Power (W)	Current (A)	Max Power (W)	Current (A)	
762.01250	0.97	1.03	2.91	1.56	Not for FCC review
768.01250	0.97	1.01	2.91	1.62	Not for FCC review
769.08750	0.97	1.04	2.91	1.59	
774.88750	0.97	0.99	2.90	1.80	
775.98750	0.97	0.99	2.90	1.59	Not for FCC review
792.01250	0.97	0.99	2.89	1.59	Not for FCC review
798.01250	0.96	1.03	2.89	1.56	Not for FCC review
799.08750	0.96	0.98	2.89	1.53	
804.91250	0.96	0.98	2.88	1.53	
805.98750	0.96	1.05	2.97	1.50	Not for FCC review

6.2. Frequency Stability

6.2.1. Test Setup

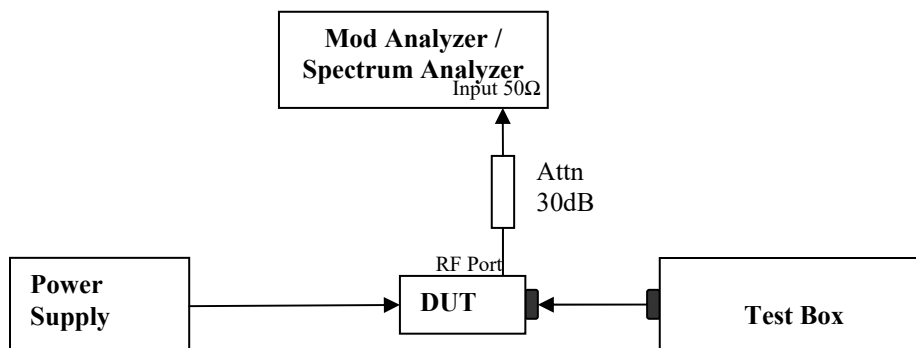

- 1) The DUT transmitter output port was connected to Modulation / Spectrum Analyzer.
- 2) Path loss for the measurement included.
- 3) Transmit the DUT and record the freq in MCF_{MHz} .
- 4) Test in 2 conditions:
 - Temperature: The frequency of the transmitter was measured from -30°C to 50°C.
 - Supply Voltage:
 - Mobile: The frequency of the transmitter was measured from 85% to 115% of the nominal operating input voltage.
 - Portable: The frequency of the transmitter was measured from nominal $\pm x$ % as specified by the manufacturer
- 5) Calculate the ppm frequency error by the following:

$$ppm\ error = \left(\frac{MCF_{MHz}}{ACF_{MHz}} - 1 \right) * 10^6$$

Where: MCF_{MHz} is the Measured Carrier Frequency in MHz
 ACF_{MHz} is the Assigned Carrier Frequency in MHz

6.2.2. Test Result

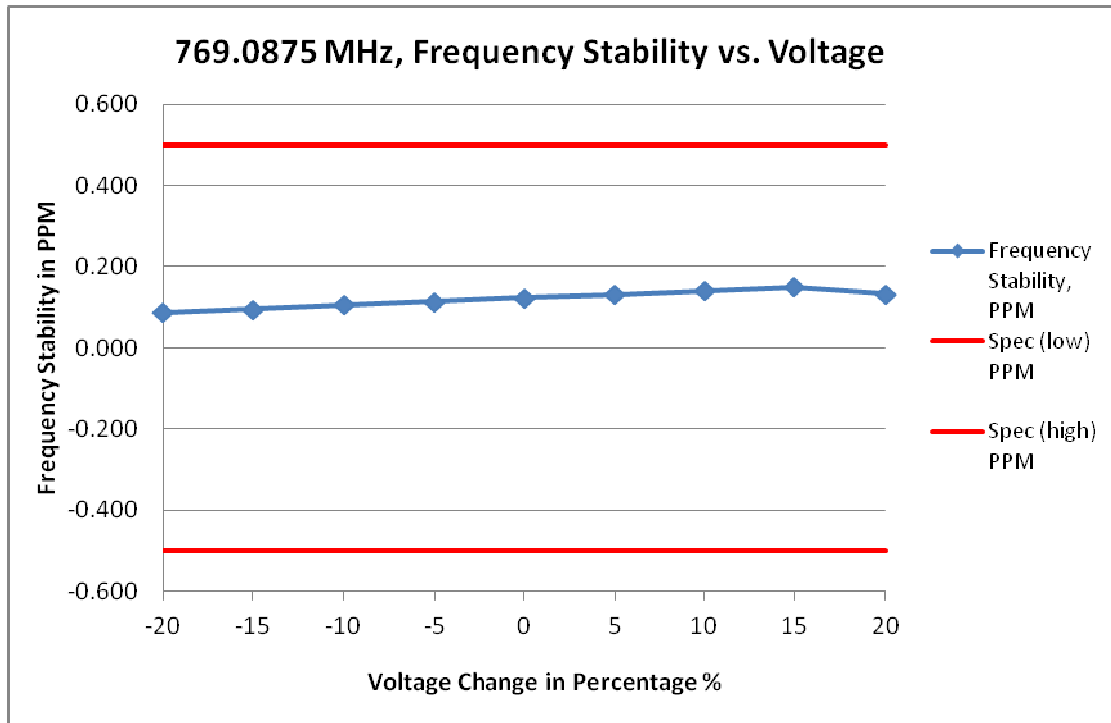

(i) Frequency Stability VS Voltage

Frequency / Channel Spacing	769.0875 MHz / 12.5 kHz				
Temperature, °C	25				
Voltage %	Voltage, V	Frequency, MHz	Frequency Stability, PPM	Spec (low) PPM	Spec (high) PPM
-20	6.000	769.087568	0.088	-0.500	0.500
-15	6.370	769.087573	0.095	-0.500	0.500
-10	6.750	769.087581	0.105	-0.500	0.500
-5	7.120	769.087588	0.114	-0.500	0.500
0	7.500	769.087595	0.123	-0.500	0.500
5	7.870	769.087601	0.131	-0.500	0.500
10	8.250	769.087608	0.140	-0.500	0.500
15	8.620	769.087615	0.149	-0.500	0.500
20	9.000	769.087602	0.133	-0.500	0.500

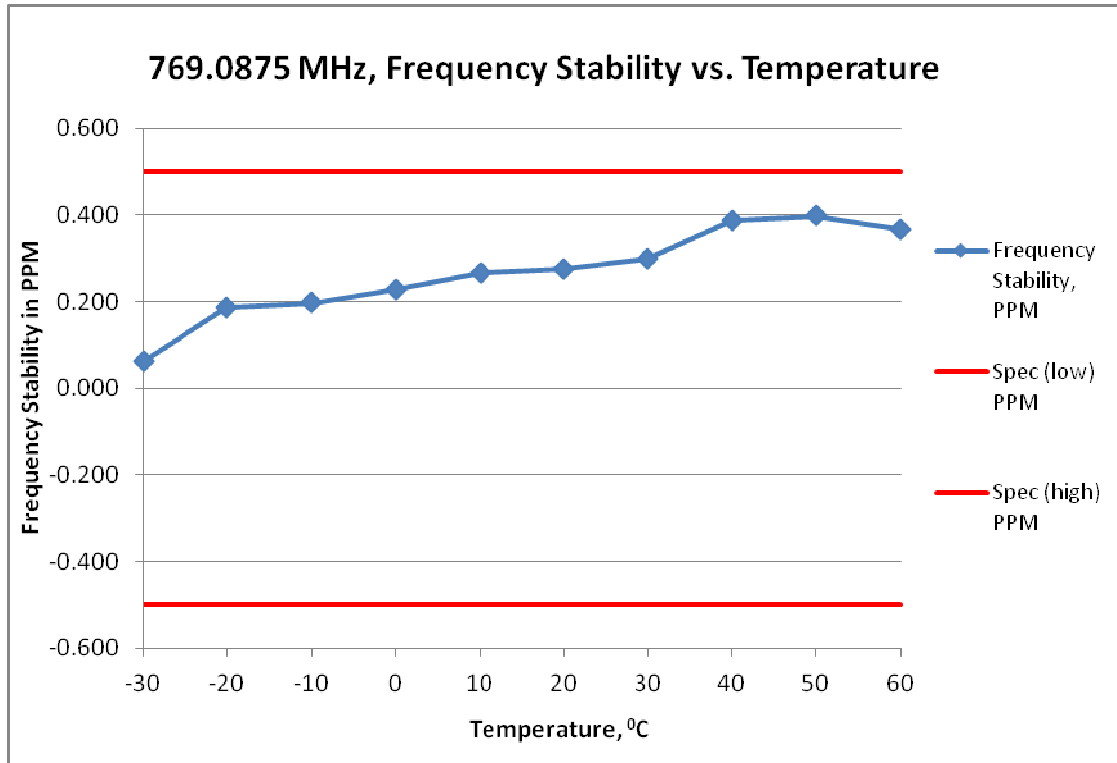

(ii) Frequency Stability VS temperature

Frequency / Channel Spacing	769.0875 MHz / 12.5 kHz			
Voltage, V	7.5			
Temperature, °C	Frequency, MHz	Frequency Stability, PPM	Spec (low) PPM	Spec (high) PPM
-30	769.087548	0.062	-0.500	0.500
-20	769.087644	0.187	-0.500	0.500
-10	769.087651	0.196	-0.500	0.500
0	769.087675	0.227	-0.500	0.500
10	769.087705	0.267	-0.500	0.500
20	769.087712	0.275	-0.500	0.500
30	769.087730	0.299	-0.500	0.500
40	769.087798	0.388	-0.500	0.500
50	769.087806	0.398	-0.500	0.500
60	769.087782	0.367	-0.500	0.500

6.2.3. Test Limit

As per manufacturer declared spec +/- 0.5ppm

6.3. Modulation Characteristics

6.3.1. Test Setup

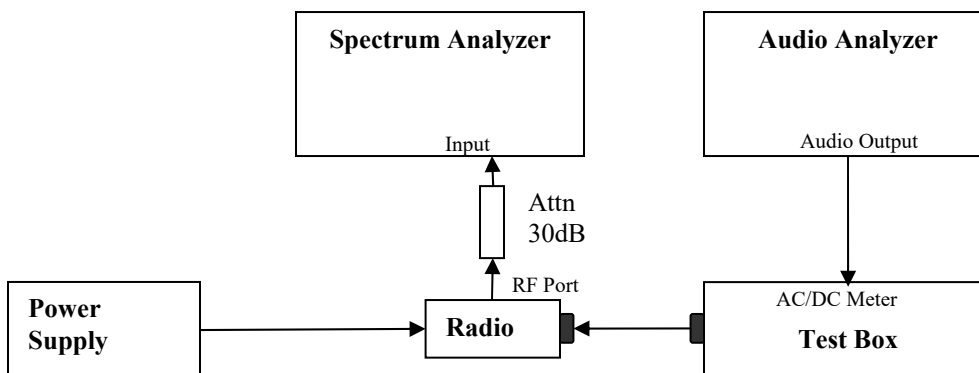

- 1) The DUT transmitter output port was connected to Modulation Analyzer.
- 2) Path loss for the measurement included.
- 3) Set the audio bandwidth filter to 15 kHz and 50 kHz.
- 4) Transmit the radio and set the audio analyzer to 1 kHz audio frequency and 20% of the Full rated system deviation.
- 5) On audio analyzer, set the rated level as 0dB reference
- 6) Vary the audio frequency from 300 Hz to 20 kHz. Record the change in modulation in reference to step 5.

6.3.2. Test Result

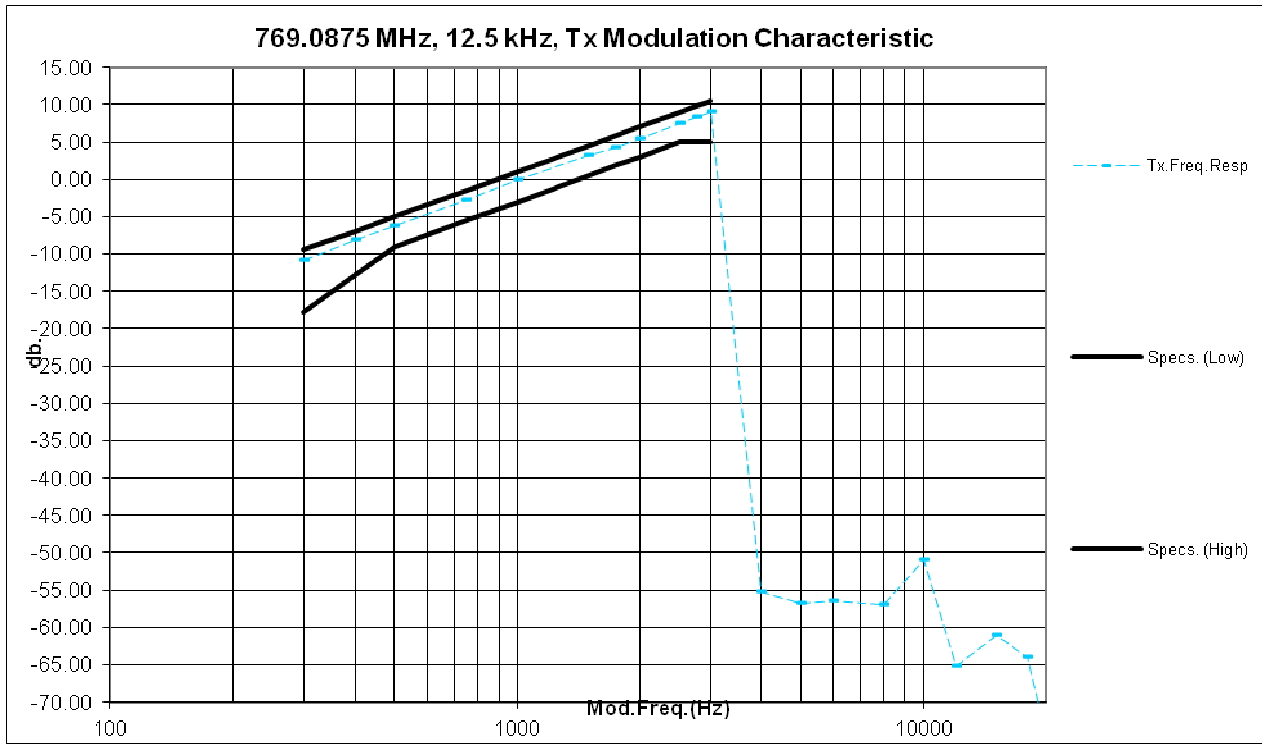

6.3.3. Test Limit

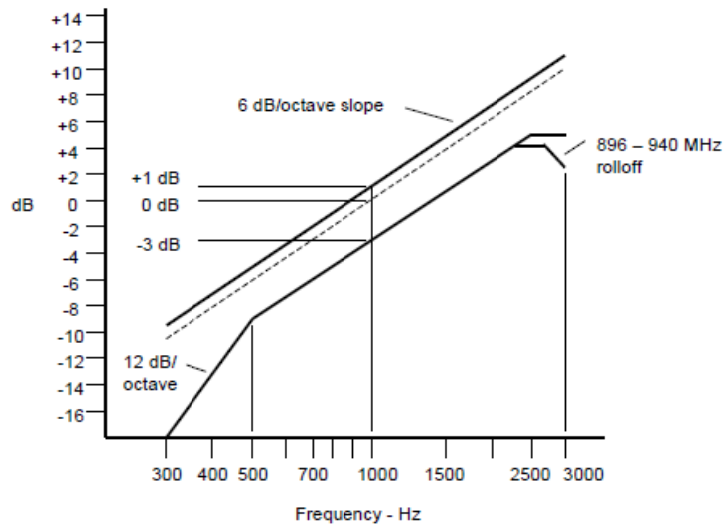

Note:

- o There are additional 6 dB per octave attenuation is allowed from 2.5KHz to 3KHz in equipment 25MHz to 869MHz radio.
- o Additional 6 dB per octave attenuation is allowed from 2.3KHz to 2.7KHz & additional 12 dB per octave attenuation is allowed from 2.7KHz to 3KHz in equipment 896MHz to 940MHz radio.

6.4. Modulation Limiting

6.4.1. Test Setup

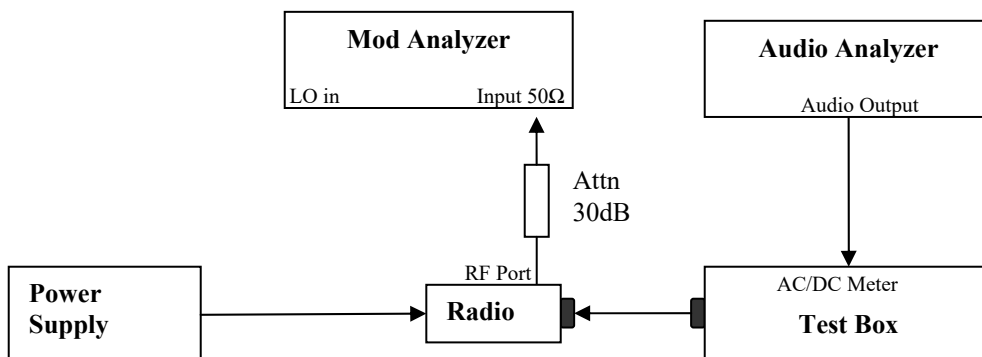

- 1) The DUT transmitter output port was connected to Modulation Analyzer.
- 2) Path loss for the measurement included.
- 3) Set the audio bandwidth filter to 15 kHz.
- 4) Transmit the radio and set the audio analyzer to 1 kHz audio frequency and 60% of the Full rated system deviation.
- 5) Record the frequency deviation as 0dB input level at 1kHz audio frequency.
- 6) Repeat the step and record the frequency deviation from -20 dB to 20dB by 5 dB increments and different audio freq 300 Hz, 2.5 kHz and 3 kHz.

6.4.2. Test Result

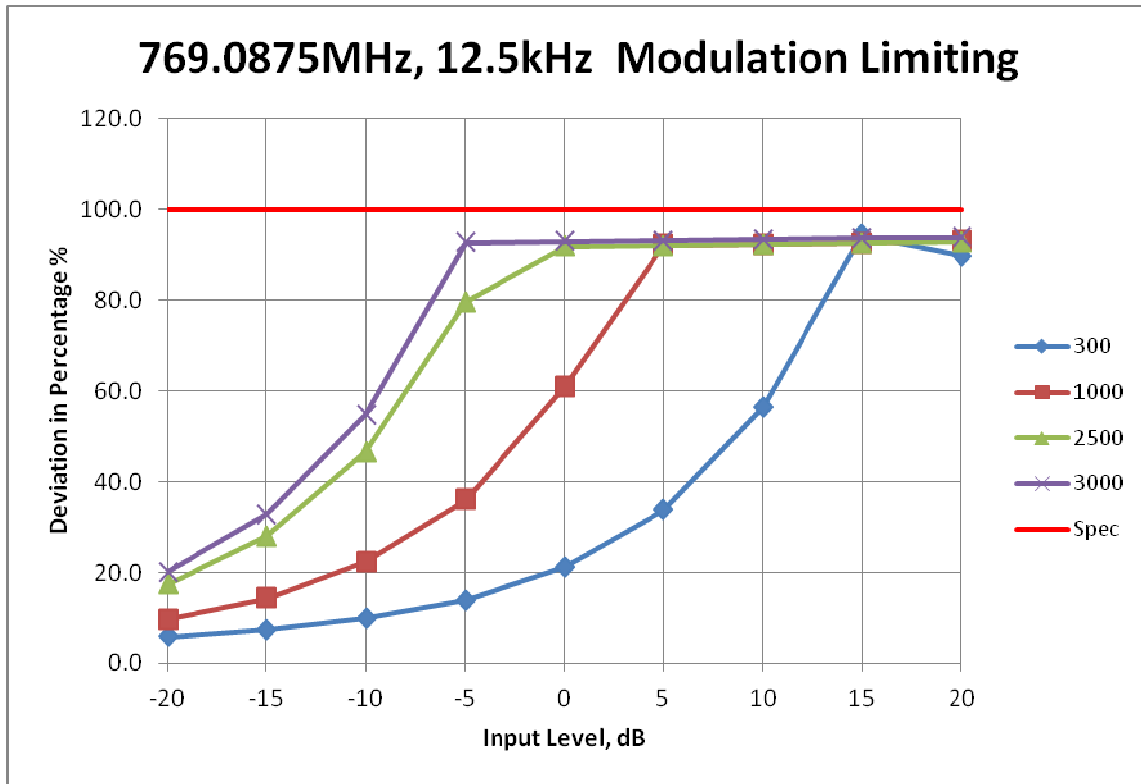

6.4.3. Test Limit

Modulation Limiting shall not exceed 100 percent.

6.5. Occupied Bandwidth

6.5.1. Test Setup (Analog)

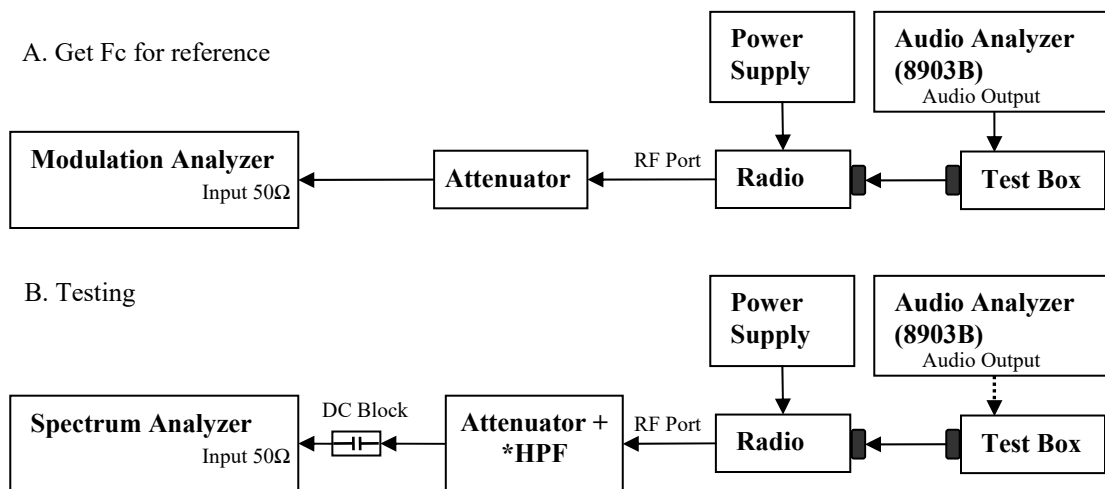

- 1) The DUT transmitter output port was connected to Modulation Analyzer.
- 2) Set the audio bandwidth filter to 15 kHz low pass filter and 50 kHz high pass filter.
- 3) Transmit the radio and set the audio analyzer to 2.5 kHz audio frequency and 50% of the rated deviation. Up the amplitude by 16 dB. Dekey the DUT.
- 4) Path loss for the measurement included.
- 5) Select the Occupied Bandwidth measurement for 99% Emissions Bandwidth Measurement.
- 6) Key in the Fc and Resolution Bandwidth (1 ~ 5 % of emission designator).
- 7) Transmit the DUT and record the occupied Bandwidth frequency.
- 8) Preset the spectrum analyzer for sideband spectrum measurement.
- 9) Set the span and Resolution Bandwidth (according to FCC/ ISED standard).
- 10) Save the screen shot as modulated signal
- 11) Remove the audio tone from audio analyzer to capture unmodulated signal.

* Only HPF added for Mask 80.211 measurement with attenuator.

* 99% Bandwidth measurement is computed by the spectrum analyzer and is consistent with the C63.26 5.4.4 method.

6.5.2. Test Result (Analog)

Not Applicable

6.5.3. Test Setup (Digital)

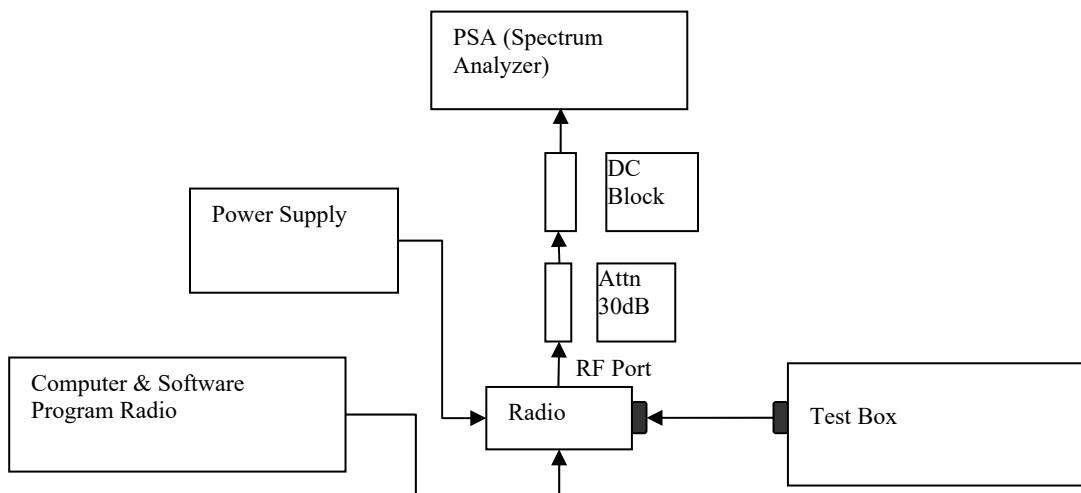

- 1) Program and set radio to operate in desire test frequency and digital mode with modulation. (*4FSK, C4FM or other digital modulation form).
- 2) Path loss for the measurement included.
- 3) Select the Occupied Bandwidth measurement for 99% Emissions Bandwidth Measurement.
- 4) Key in the Fc and Resolution Bandwidth (1 ~ 5 % of emission designator).
- 5) Transmit the DUT and record the occupied Bandwidth frequency.
- 6) Preset the spectrum analyzer for modulation emission spectrum measurement.
- 7) Set the span and Resolution Bandwidth (according to FCC/ ISED standard).
- 8) Capture the screen shot as modulated signal.

* 99% Bandwidth measurement is computed by the spectrum analyzer and is consistent with the C63.26 5.4.4 method.

*Note:

- For Digital Modulation, 12.5 kHz Data F1D & FXD would be the same. Therefore only measurements with F1D modulation shown below.
- For Digital Modulation, 12.5 kHz Data F1E & FXE would be the same. Therefore only measurements with F1E modulation shown below.

6.5.4. Test Result (Digital)

Not Applicable

6.5.5. Test Limit

The 99% occupied bandwidth is the width of a frequency band such that, below the lower and above the upper frequency limits, the mean powers emitted are each equal to a specified percentage 0.5% of the total mean transmitted power.

6.6. Band Edge Conducted Spurious Emission (Part 22)

6.6.1. Test Setup (Analog)

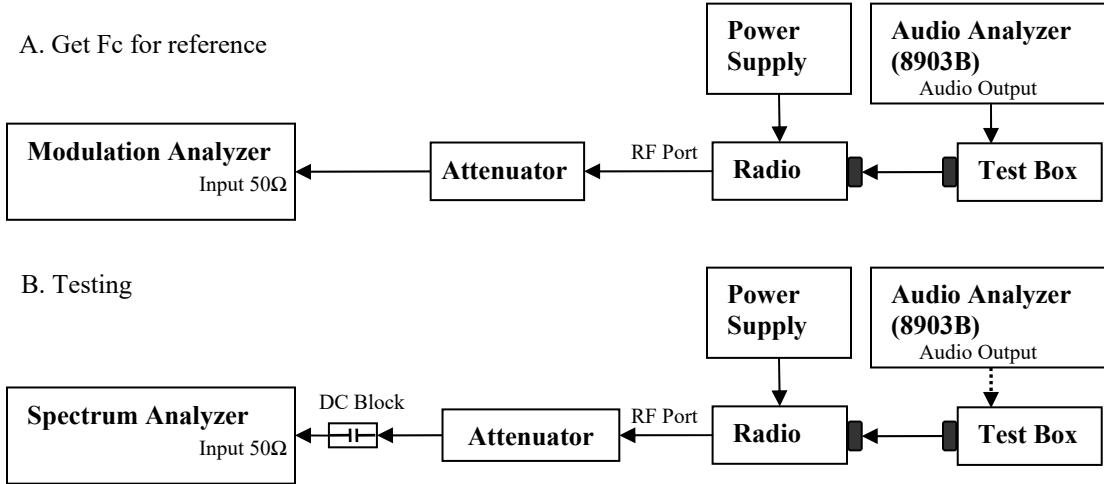

- 1) The DUT transmitter output port was connected to Modulation Analyzer.
- 2) Set the audio bandwidth filter to 15 kHz low pass filter and 50 kHz high pass filter.
- 3) Transmit the radio and set the audio analyzer to 2.5 kHz audio frequency and 50% of the rated deviation. Up the amplitude by 16 dB. Dekey the DUT.
- 4) Path loss for the measurement included.
- 5) Select the Occupied Bandwidth measurement for 99% and 26dB Emissions Bandwidth Measurement.
- 6) Key in the Fc and Resolution Bandwidth.
- 7) Transmit the DUT and record the occupied Bandwidth frequencies.
- 8) Preset the spectrum analyzer for band edge measurement.
- 9) The band edges of lowest and highest channels were measured.
- 10) Key in the Lowest and highest channel frequency, span is 60 kHz and Resolution Bandwidth is at least 1% of Emission Bandwidth.
- 11) Save the screen shot as modulated signal.
- 12) Remove the audio tone from audio analyzer to capture unmodulated signal.

*Note:

- For emission designator ending with F3E, 16K0F3E is the worst case and therefore only 16K0F3E will be shown.

6.6.2. Test Result (Analog)

Not Applicable

6.6.3. Test Setup (Digital)

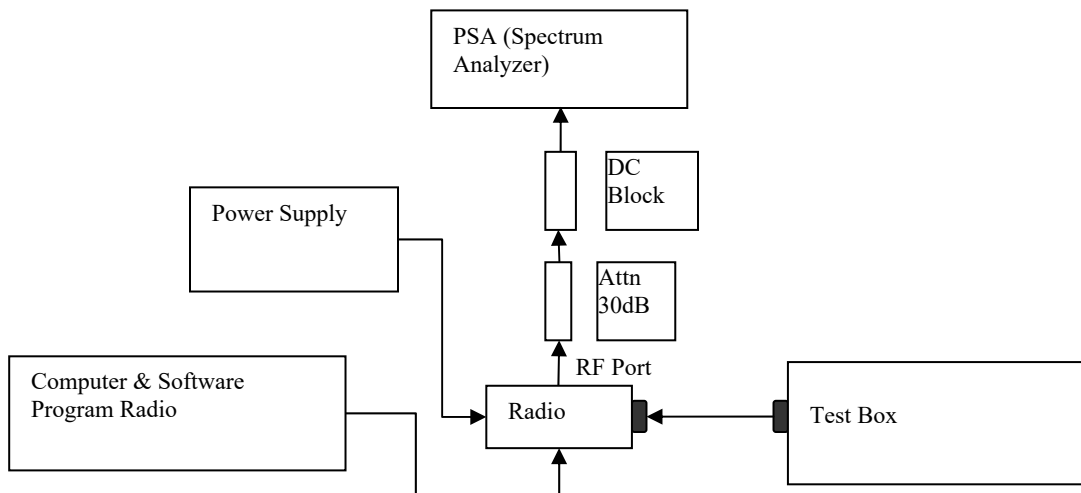

- 1) Program and set radio to operate in desire test frequency and digital mode with modulation. (*4FSK, C4FM or other digital modulation form).
- 2) Path loss for the measurement included.
- 3) Select the Occupied Bandwidth measurement for 99% and 26dB Emissions Bandwidth Measurement.
- 4) Key in the Fc and Resolution Bandwidth.
- 5) Transmit radio record the occupied Bandwidth frequencies.
- 6) Preset the spectrum analyzer for band edge measurement.
- 7) Key in the lowest and highest channels frequency, span is 60 kHz and Resolution Bandwidth is at least 1% of Emission Bandwidth.
- 8) Save the screen shot.

*Note:

- For Digital Modulation, 12.5 kHz Data F1D & FXD would be the same. Therefore only measurements with F1D modulation shown below.
- For Digital Modulation, 12.5 kHz Data F1E & FXE would be the same. Therefore only measurements with F1E modulation shown below.

6.6.4. Test Result (Digital)

Not Applicable

6.6.5. Test Limit

The power of any emission outside of the authorized operating frequency ranges must be attenuated below the transmitting power (P) by a factor of at least $43 + 10 \log(P)$ dB.

6.7. Transient Frequency Behavior

6.7.1. Test Setup

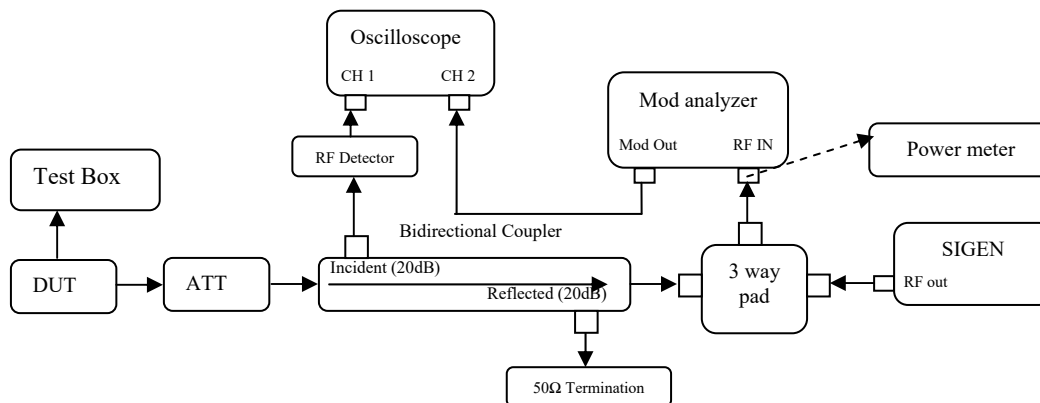

- 1) Connect the setup as figure above.
- 2) Path loss for the measurement included.
- 3) Set on Sigen with the assigned center frequency, internal 1 kHz FM tone.
FM Deviation: Analog 25kHz Channel Spacing = 25 kHz
Analog 12.5 kHz Channel Spacing = 12.5 kHz
C4FM = 12.5 kHz
- 4) Turn on 50 kHz high pass filter and 15 kHz low pass filter on modulation analyzer.
- 5) Supply sufficient attenuation ATT to provide the output power of ≤ -11 dBm into power meter when DUT is keying up.
- 6) Note the power level on power meter and dekey the DUT.
- 7) Adjust the amplitude of the signal generator to the level power meter, maintained the amplitude throughout the rest of the measurement.
- 8) Connect the output to modulation analyzer.
- 9) Reduce 30dB attenuation and transmit the radio to get the trigger line.
- 10) Capture the screen shot for key-up (rising edge) and de-key (falling edge) mode.

6.7.2. Test Result

Not Applicable

6.7.3. Test Limit

Transmitters designed to operate in the 150-174 MHz and 421-512 MHz frequency bands must maintain transient frequencies within the maximum frequency difference limits during the time intervals indicated:

Time intervals ^{1 2}	Maximum frequency difference ³	All equipment	
		150 to 174 MHz	421 to 512 MHz
Transient Frequency Behavior for Equipment Designed to Operate on 25 kHz Channels			
t ₁ ⁴	±25.0 kHz	5.0 ms	10.0 ms
t ₂	±12.5 kHz	20.0 ms	25.0 ms
t ₃ ⁴	±25.0 kHz	5.0 ms	10.0 ms
Transient Frequency Behavior for Equipment Designed to Operate on 12.5 kHz Channels			
t ₁ ⁴	±12.5 kHz	5.0 ms	10.0 ms
t ₂	±6.25 kHz	20.0 ms	25.0 ms
t ₃ ⁴	±12.5 kHz	5.0 ms	10.0 ms
Transient Frequency Behavior for Equipment Designed to Operate on 6.25 kHz Channels			
t ₁ ⁴	±6.25 kHz	5.0 ms	10.0 ms
t ₂	±3.125 kHz	20.0 ms	25.0 ms
t ₃ ⁴	±6.25 kHz	5.0 ms	10.0 ms

¹ t_{on} is the instant when a 1 kHz test signal is completely suppressed, including any capture time due to phasing.

t₁ is the time period immediately following t_{on}.

t₂ is the time period immediately following t₁.

t₃ is the time period from the instant when the transmitter is turned off until t_{off}.

t_{off} is the instant when the 1 kHz test signal starts to rise.

² During the time from the end of t₂ to the beginning of t₃, the frequency difference must not exceed the limits specified in §90.213.

³ Difference between the actual transmitter frequency and the assigned transmitter frequency.

⁴ If the transmitter carrier output power rating is 6 watts or less, the frequency difference during this time period may exceed the maximum frequency difference for this time period.

6.8. Adjacent Channel Power

6.8.1. Test Setup (Analog)

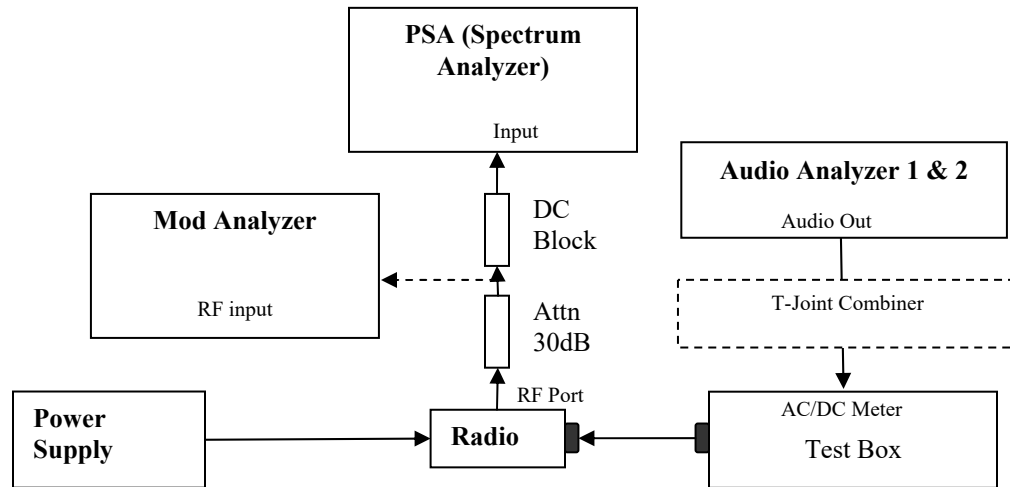

- 1) The DUT transmitter output port was connected to modulation analyzer.
- 2) Transmit the radio and turn on 1st audio analyzer with audio frequency 650Hz, 50% rated deviation, and record the amplitude value as AmpT1.
- 3) Turn off Audio analyzer 1 and turn on audio analyzer 2, set the audio frequency to 2.2 kHz and 50% deviation. Record the amplitude as AmpT2.
- 4) Turn both audio analyzers ON and up 10dB amplitude level.
- 5) Connect the output to PSA and set to assigned center frequency.
- 6) Set Span, Resolution Bandwidth and Video Bandwidth per rules part.
- 7) Transmit the radio and record the Adjacent Channel Power value in dBc.

6.8.2. Test Result

Mode	Analog			
Frequency, MHz	769.0875			
Channel Spacing, kHz	12.5			
Offset (kHz)	Meas BW (kHz)	Lower	Upper	Spec (dB)
9.375	6.25	-49.885	-49.945	-40
15.625	6.25	-77.804	-77.973	-60
21.875	6.25	-79.249	-79.617	-60
37.500	25	-74.127	-74.178	-65
62.500	25	-76.201	-76.503	-65
87.500	25	-78.666	-78.773	-65
150.000	100	-76.728	-76.585	-65
250.000	100	-81.190	-81.427	-65
350.000	100	-83.569	-83.503	-65
400k	30	-88.971	-89.138	-75
12M	30	-89.836	-89.897	-75

Mode	Analog			
Frequency, MHz	774.8875			
Channel Spacing, kHz	12.5			
Offset (kHz)	Meas BW (kHz)	Lower	Upper	Spec (dB)
9.375	6.25	-50.011	-49.850	-40
15.625	6.25	-78.023	-78.693	-60
21.875	6.25	-79.421	-79.285	-60
37.500	25	-73.873	-73.908	-65
62.500	25	-76.267	-76.229	-65
87.500	25	-78.769	-78.547	-65
150.000	100	-76.618	-76.773	-65
250.000	100	-81.298	-81.051	-65
350.000	100	-83.514	-83.300	-65
400k	30	-88.766	-88.640	-75
12M	30	-89.992	-89.409	-75

Mode	Analog			
Frequency, MHz	799.0875			
Channel Spacing, kHz	12.5			
Offset (kHz)	Meas BW (kHz)	Lower	Upper	Spec (dB)
9.375	6.25	-51.724	-49.656	-40
15.625	6.25	-77.207	-77.402	-60
21.875	6.25	-78.815	-78.691	-60
37.500	25	-73.665	-73.760	-65
62.500	25	-76.283	-76.139	-65
87.500	25	-78.639	-78.796	-65
150.000	100	-76.703	-76.737	-65
250.000	100	-81.191	-81.142	-65
350.000	100	-83.448	-83.158	-65
400k	30	-89.118	-88.778	-75
12M	30	-89.655	-89.331	-75

Mode	Analog			
Frequency, MHz	804.9125			
Channel Spacing, kHz	12.5			
Offset (kHz)	Meas BW (kHz)	Lower	Upper	Spec (dB)
9.375	6.25	-52.271	-49.857	-40
15.625	6.25	-77.284	-77.221	-60
21.875	6.25	-79.124	-79.092	-60
37.500	25	-73.561	-73.742	-65
62.500	25	-76.065	-75.951	-65
87.500	25	-78.363	-78.398	-65
150.000	100	-76.554	-76.397	-65
250.000	100	-80.984	-81.102	-65
350.000	100	-83.346	-83.106	-65
400k	30	-88.811	-88.534	-75
12M	30	-89.408	-89.433	-75

6.8.3. Test Setup (Digital)

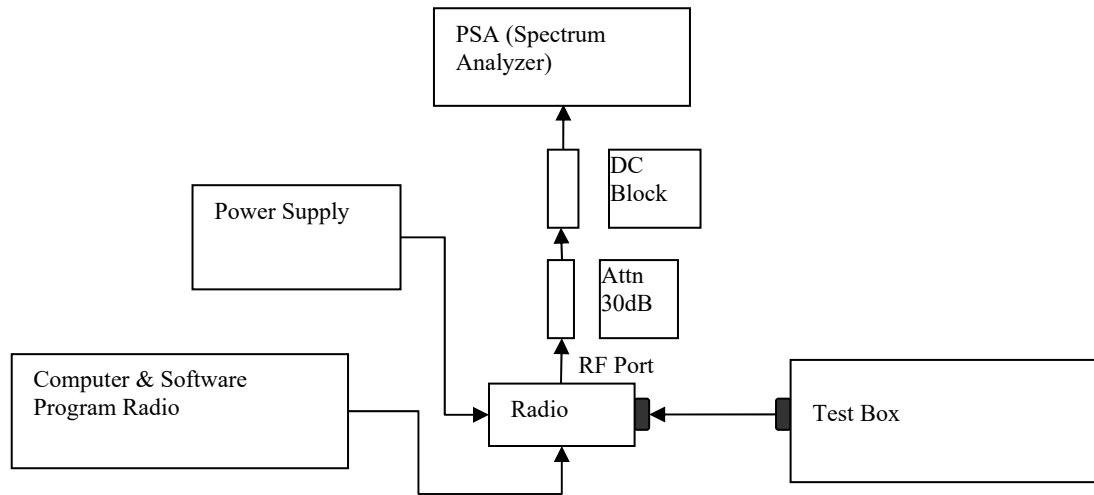

- 1) Program and set radio to operate in desire test frequency and digital mode with modulation. (4FSK, C4FM or other digital modulation form).
- 2) Prepare setup as per picture.
- 3) Turn on the ACP Measurement – Press Measure, ACP.
- 4) Set Span, Resolution Bandwidth and Video Bandwidth as per rules part.
- 5) Transmit the radio and record the Adjacent Channel Power value in dBc.

6.8.4. Test Result

Mode	Digital Data			
Frequency, MHz	769.0875			
Channel Spacing, kHz	12.5			
Offset (kHz)	Meas BW (kHz)	Lower	Upper	Spec (dB)
9.375	6.25	-43.104	-44.466	-40
15.625	6.25	-77.879	-77.820	-60
21.875	6.25	-79.538	-79.315	-60
37.500	25	-74.165	-74.148	-65
62.500	25	-76.182	-76.323	-65
87.500	25	-78.665	-78.520	-65
150.000	100	-76.752	-76.561	-65
250.000	100	-81.269	-81.308	-65
350.000	100	-83.383	-83.475	-65
400k	30	-88.895	-88.684	-75
12M	30	-89.560	-89.465	-75

Mode	Digital Data			
Frequency, MHz	774.8875			
Channel Spacing, kHz	12.5			
Offset (kHz)	Meas BW (kHz)	Lower	Upper	Spec (dB)
9.375	6.25	-42.745	-44.641	-40
15.625	6.25	-78.136	-77.732	-60
21.875	6.25	-79.658	-79.521	-60
37.500	25	-73.887	-73.923	-65
62.500	25	-76.123	-76.261	-65
87.500	25	-78.649	-78.745	-65
150.000	100	-76.724	-76.742	-65
250.000	100	-81.226	-81.234	-65
350.000	100	-83.219	-83.438	-65
400k	30	-88.267	-89.093	-75
12M	30	-89.986	-89.571	-75

Mode	Digital Data			
Frequency, MHz	799.0875			
Channel Spacing, kHz	12.5			
Offset (kHz)	Meas BW (kHz)	Lower	Upper	Spec (dB)
9.375	6.25	-46.196	-46.420	-40
15.625	6.25	-76.918	-77.253	-60
21.875	6.25	-79.359	-78.895	-60
37.500	25	-73.946	-73.628	-65
62.500	25	-76.175	-76.067	-65
87.500	25	-78.655	-78.461	-65
150.000	100	-76.591	-76.662	-65
250.000	100	-81.297	-81.141	-65
350.000	100	-83.303	-83.250	-65
400k	30	-89.382	-88.901	-75
12M	30	-89.133	-89.730	-75

Mode	Digital Data			
Frequency, MHz	804.9125			
Channel Spacing, kHz	12.5			
Offset (kHz)	Meas BW (kHz)	Lower	Upper	Spec (dB)
9.375	6.25	-45.323	-46.045	-40
15.625	6.25	-77.094	-76.892	-60
21.875	6.25	-79.228	-78.694	-60
37.500	25	-73.662	-73.619	-65
62.500	25	-76.044	-76.093	-65
87.500	25	-78.707	-78.387	-65
150.000	100	-76.504	-76.363	-65
250.000	100	-81.157	-81.017	-65
350.000	100	-83.157	-82.992	-65
400k	30	-88.712	-88.347	-75
12M	30	-89.452	-88.969	-75

Mode	Digital Voice			
Frequency, MHz	769.0875			
Channel Spacing, kHz	12.5			
Offset (kHz)	Meas BW (kHz)	Lower	Upper	Spec (dB)
9.375	6.25	-47.450	-54.110	-40
15.625	6.25	-78.316	-77.828	-60
21.875	6.25	-79.101	-79.319	-60
37.500	25	-74.265	-74.064	-65
62.500	25	-76.365	-75.953	-65
87.500	25	-78.801	-78.780	-65
150.000	100	-76.626	-76.556	-65
250.000	100	-81.174	-81.262	-65
350.000	100	-83.400	-83.431	-65
400k	30	-88.848	-88.923	-75
12M	30	-89.429	-89.834	-75

Mode	Digital Voice			
Frequency, MHz	774.8875			
Channel Spacing, kHz	12.5			
Offset (kHz)	Meas BW (kHz)	Lower	Upper	Spec (dB)
9.375	6.25	-57.666	-46.235	-40
15.625	6.25	-78.345	-78.152	-60
21.875	6.25	-79.493	-79.369	-60
37.500	25	-74.200	-74.065	-65
62.500	25	-76.423	-76.109	-65
87.500	25	-78.835	-78.734	-65
150.000	100	-76.743	-76.645	-65
250.000	100	-81.374	-81.226	-65
350.000	100	-83.397	-83.406	-65
400k	30	-88.755	-89.205	-75
12M	30	-88.869	-89.282	-75

Mode	Digital Voice			
Frequency, MHz	799.0875			
Channel Spacing, kHz	12.5			
Offset (kHz)	Meas BW (kHz)	Lower	Upper	Spec (dB)
9.375	6.25	-53.486	-45.598	-40
15.625	6.25	-76.859	-76.737	-60
21.875	6.25	-78.978	-78.652	-60
37.500	25	-73.779	-73.727	-65
62.500	25	-76.116	-75.970	-65
87.500	25	-78.738	-78.601	-65
150.000	100	-76.685	-76.642	-65
250.000	100	-81.280	-81.200	-65
350.000	100	-83.544	-83.317	-65
400k	30	-88.837	-88.962	-75
12M	30	-89.434	-89.114	-75

Mode	Digital Voice			
Frequency, MHz	804.9125			
Channel Spacing, kHz	12.5			
Offset (kHz)	Meas BW (kHz)	Lower	Upper	Spec (dB)
9.375	6.25	-56.567	-49.858	-40
15.625	6.25	-77.556	-75.891	-60
21.875	6.25	-78.521	-78.860	-60
37.500	25	-73.511	-73.701	-65
62.500	25	-76.061	-75.801	-65
87.500	25	-78.494	-78.352	-65
150.000	100	-76.398	-76.490	-65
250.000	100	-81.095	-81.075	-65
350.000	100	-83.282	-83.118	-65
400k	30	-88.184	-88.604	-75
12M	30	-89.441	-89.298	-75

Mode	Digital Voice Encryption			
Frequency, MHz	769.0875			
Channel Spacing, kHz	12.5			
Offset (kHz)	Meas BW (kHz)	Lower	Upper	Spec (dB)
9.375	6.25	-56.069	-49.319	-40
15.625	6.25	-78.310	-77.558	-60
21.875	6.25	-79.186	-79.272	-60
37.500	25	-74.130	-74.210	-65
62.500	25	-76.307	-76.286	-65
87.500	25	-78.887	-78.597	-65
150.000	100	-76.883	-76.637	-65
250.000	100	-81.490	-81.181	-65
350.000	100	-83.733	-83.571	-65
400k	30	-89.433	-89.405	-75
12M	30	-89.445	-89.533	-75

Mode	Digital Voice Encryption			
Frequency, MHz	774.8875			
Channel Spacing, kHz	12.5			
Offset (kHz)	Meas BW (kHz)	Lower	Upper	Spec (dB)
9.375	6.25	-54.497	-49.369	-40
15.625	6.25	-78.417	-77.838	-60
21.875	6.25	-79.154	-79.274	-60
37.500	25	-73.844	-74.102	-65
62.500	25	-76.352	-76.142	-65
87.500	25	-78.751	-78.654	-65
150.000	100	-76.826	-76.657	-65
250.000	100	-81.294	-81.453	-65
350.000	100	-83.406	-83.636	-65
400k	30	-89.129	-89.011	-75
12M	30	-89.801	-89.669	-75

Mode	Digital Voice Encryption			
Frequency, MHz	799.0875			
Channel Spacing, kHz	12.5			
Offset (kHz)	Meas BW (kHz)	Lower	Upper	Spec (dB)
9.375	6.25	-54.528	-46.467	-40
15.625	6.25	-77.040	-76.669	-60
21.875	6.25	-79.151	-78.583	-60
37.500	25	-73.637	-73.483	-65
62.500	25	-76.307	-76.150	-65
87.500	25	-78.678	-78.523	-65
150.000	100	-76.656	-76.690	-65
250.000	100	-81.284	-81.315	-65
350.000	100	-83.560	-83.421	-65
400k	30	-88.542	-89.081	-75
12M	30	-89.636	-89.544	-75

Mode	Digital Voice Encryption			
Frequency, MHz	804.9125			
Channel Spacing, kHz	12.5			
Offset (kHz)	Meas BW (kHz)	Lower	Upper	Spec (dB)
9.375	6.25	-52.921	-47.820	-40
15.625	6.25	-77.351	-76.063	-60
21.875	6.25	-78.775	-78.015	-60
37.500	25	-73.587	-73.691	-65
62.500	25	-76.241	-76.079	-65
87.500	25	-78.663	-78.393	-65
150.000	100	-76.422	-76.503	-65
250.000	100	-81.220	-81.116	-65
350.000	100	-83.428	-83.276	-65
400k	30	-88.576	-88.578	-75
12M	30	-89.438	-89.622	-75

Mode	Phase II			
Frequency, MHz	769.0875			
Channel Spacing, kHz	12.5			
Offset (kHz)	Meas BW (kHz)	Lower	Upper	Spec (dB)
9.375	6.25	-42.778	-43.461	-40
15.625	6.25	-81.355	-69.576	-60
21.875	6.25	-83.302	-76.288	-60
37.500	25	-76.404	-76.196	-65
62.500	25	-79.209	-79.145	-65
87.500	25	-81.584	-81.607	-65
150.000	100	-79.434	-79.439	-65
250.000	100	-83.025	-83.047	-65
350.000	100	-84.545	-84.455	-65
400k	30	-89.979	-90.177	-75
12M	30	-88.908	-89.079	-75

Mode	Phase II			
Frequency, MHz	774.8875			
Channel Spacing, kHz	12.5			
Offset (kHz)	Meas BW (kHz)	Lower	Upper	Spec (dB)
9.375	6.25	-47.734	-42.953	-40
15.625	6.25	-80.534	-71.088	-60
21.875	6.25	-83.484	-80.163	-60
37.500	25	-76.334	-76.120	-65
62.500	25	-79.342	-79.434	-65
87.500	25	-81.714	-81.616	-65
150.000	100	-79.147	-79.107	-65
250.000	100	-83.085	-82.832	-65
350.000	100	-84.442	-84.397	-65
400k	30	-89.731	-89.325	-75
12M	30	-89.536	-89.254	-75

Mode	Phase II			
Frequency, MHz	799.0875			
Channel Spacing, kHz	12.5			
Offset (kHz)	Meas BW (kHz)	Lower	Upper	Spec (dB)
9.375	6.25	-48.344	-44.389	-40
15.625	6.25	-74.875	-71.632	-60
21.875	6.25	-80.880	-81.291	-60
37.500	25	-75.945	-75.764	-65
62.500	25	-79.316	-79.279	-65
87.500	25	-81.699	-81.425	-65
150.000	100	-79.121	-79.290	-65
250.000	100	-82.843	-82.865	-65
350.000	100	-84.438	-83.964	-65
400k	30	-89.760	-89.696	-75
12M	30	-89.348	-89.184	-75

Mode	Phase II			
Frequency, MHz	804.9125			
Channel Spacing, kHz	12.5			
Offset (kHz)	Meas BW (kHz)	Lower	Upper	Spec (dB)
9.375	6.25	-43.643	-44.565	-40
15.625	6.25	-73.515	-70.783	-60
21.875	6.25	-76.682	-78.447	-60
37.500	25	-75.991	-76.006	-65
62.500	25	-78.749	-78.992	-65
87.500	25	-81.512	-81.401	-65
150.000	100	-79.017	-79.012	-65
250.000	100	-82.708	-82.693	-65
350.000	100	-84.092	-84.337	-65
400k	30	-89.642	-89.558	-75
12M	30	-89.488	-89.180	-75

6.8.5. Test Limit

12.5 kHz MOBILE TRANSMITTER ACP REQUIREMENTS

Offset from center frequency (kHz)	Measurement bandwidth (kHz)	Maximum ACP relative (dBc)
9.375	6.25	-40
15.625	6.25	-60
21.875	6.25	-60
37.50	25.00	-60
62.50	25.00	-65
87.50	25.00	-65
150.00	100	-65
250.00	100	-65
350.00	100	-65
>400 to 12 MHz	30 (s)	-75
12 MHz to paired receive band	30 (s)	-75
In the paired receive band	30 (s)	-100

25 kHz MOBILE TRANSMITTER ACP REQUIREMENTS

Offset from center frequency (kHz)	Measurement bandwidth (kHz)	Maximum ACP relative (dBc)
15.625	6.25	-40
21.875	6.25	-60
37.50	25	-60
62.50	25	-65
87.50	25	-65
150.00	100	-65
250.00	100	-65
350.00	100	-65
>400 kHz to 12 MHz	30 (s)	-75
12 MHz to paired receive band	30 (s)	-75
In the paired receive band	30 (s)	-100

12.5 kHz BASE TRANSMITTER ACP REQUIREMENTS

Offset from center frequency (kHz)	Measurement bandwidth (kHz)	Maximum ACP (dBc)
9.375	6.25	-40
15.625	6.25	-60
21.875	6.25	-60
37.5	25	-60
62.5	25	-65
87.5	25	-65
150	100	-65
250	100	-65
350.00	100	-65
>400 kHz to 12 MHz	30 (s)	-80
12 MHz to paired receive band	30 (s)	-80
In the paired receive band	30 (s)	¹ -85

25 kHz BASE TRANSMITTER ACP REQUIREMENTS

Offset from center frequency (kHz)	Measurement bandwidth (kHz)	Maximum ACP (dBc)
15.625	6.25	-40
21.875	6.25	-60
37.5	25	-60
62.5	25	-65
87.5	25	-65
150	100	-65
250	100	-65
350	100.00	-65
>400 kHz to 12 MHz	30 (s)	-80
12 MHz to paired receive band	30 (s)	-80
In the paired receive band	30 (s)	¹ -85

6.9. Conducted Spurious Emission

6.9.1. Test Setup

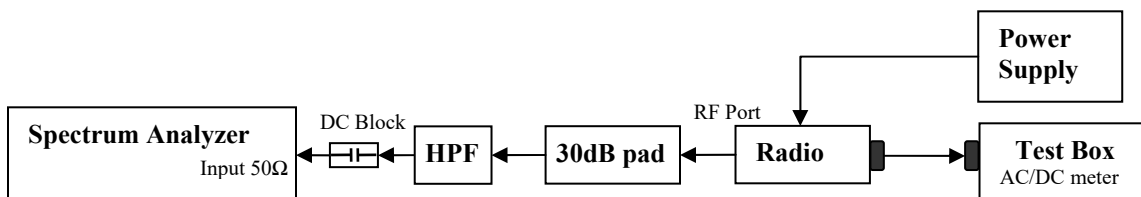

- 1) The DUT transmitter output port was connected to Spectrum Analyzer with above setup.
- 2) Program and set radio to operate in desire test frequency and mode. (Analog / digital modulation form).
- 3) Path loss for the measurement included.
- 4) Set the PSA Resolution Bandwidth as per rules part.
- 5) Set the Ref offset from the pathloss offset calibration file.
- 6) Adjust the center frequency of the spectrum analyzer for incremental coverage of the range from:
 - a. 9 KHz to $F_c - \text{Test Bandwidth}$
 - b. $F_c + \text{Test Bandwidth}$ to $2F_c - 5\text{MHz}$.
- 7) Key up the DUT, Peak Search the highest Spur and record the levels of spurious emissions
- 8) Dekey the DUT.
- 9) Turn On High Pass Filter path and Key up the DUT.
- 10) Adjust the PSA Freq for incremental coverage of range from $2F_c$ to $10F_c$
- 11) Key up the DUT and record the highest spur levels of spurious emissions.

6.9.2. Test Result (Analog)

Analog: 762.0125. MHz, 12.5.kHz Channel Spacing, Max. Power
 Not for FCC review

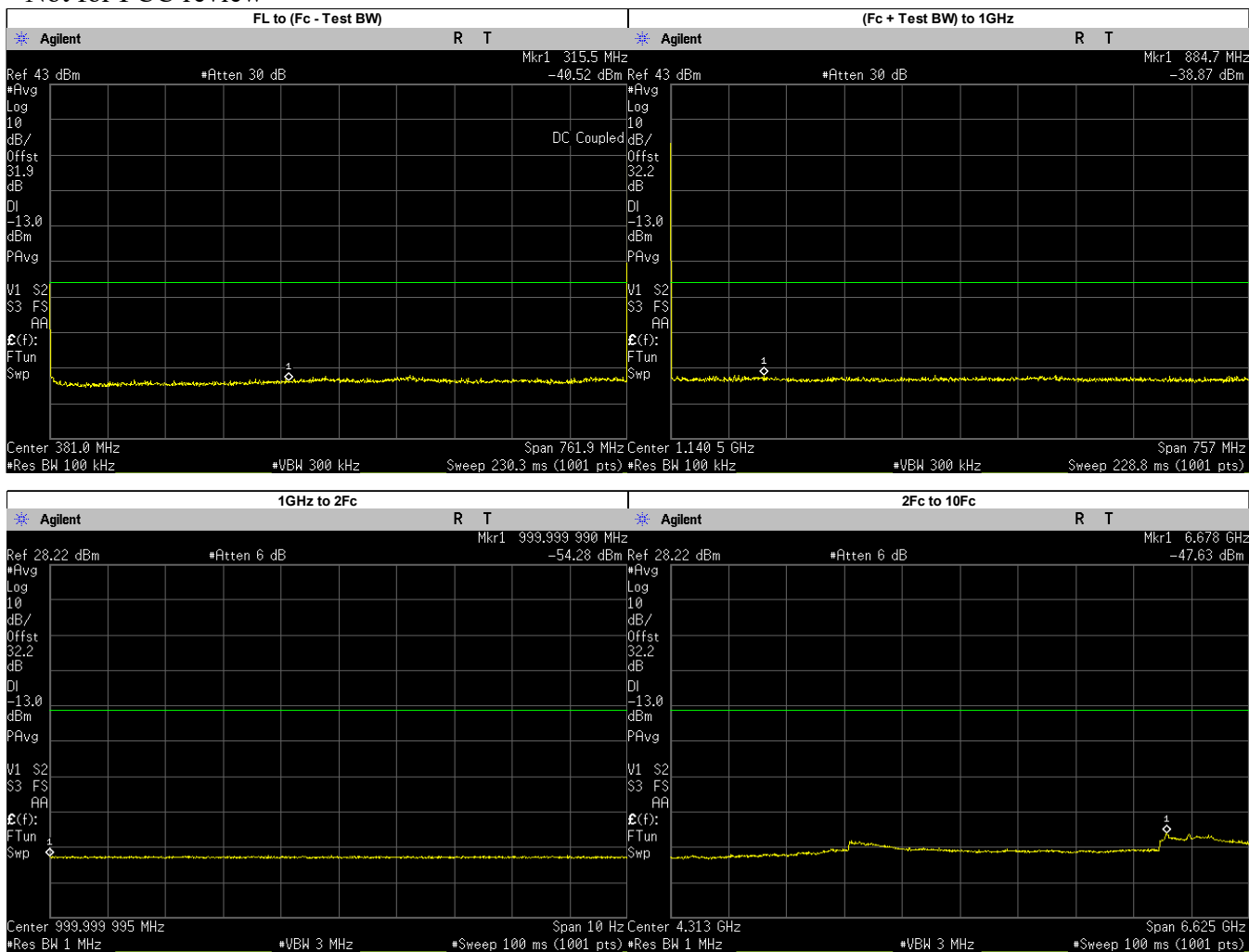

Frequency Range	Highest Spur Frequency (MHz)	Spurious Level (dBm)	Failing Limit (dBm)	Results
FL to (Fc - Test BW)	315.5000	-40.5180	-13.00	PASS
(Fc + Test BW) to 1GHz	884.6951	-38.8700	-13.00	PASS
1GHz to 2Fc	1000.0000	-54.2800	-13.00	PASS
2Fc to 10Fc	6677.7320	-47.6300	-13.00	PASS
	1524.0250	-54.7090	-13.00	PASS
	2286.0370	-53.8579	-13.00	PASS
	3048.0500	-50.0302	-13.00	PASS
	3810.0620	-52.3384	-13.00	PASS
	4572.0750	-52.8739	-13.00	PASS
	5334.0870	-52.8361	-13.00	PASS
	6096.1000	-52.6552	-13.00	PASS
	6858.1130	-49.6618	-13.00	PASS
	7620.1250	-50.6983	-13.00	PASS

Analog: 769.0125MHz, 12.5.kHz Channel Spacing, Max. Power Itinerant

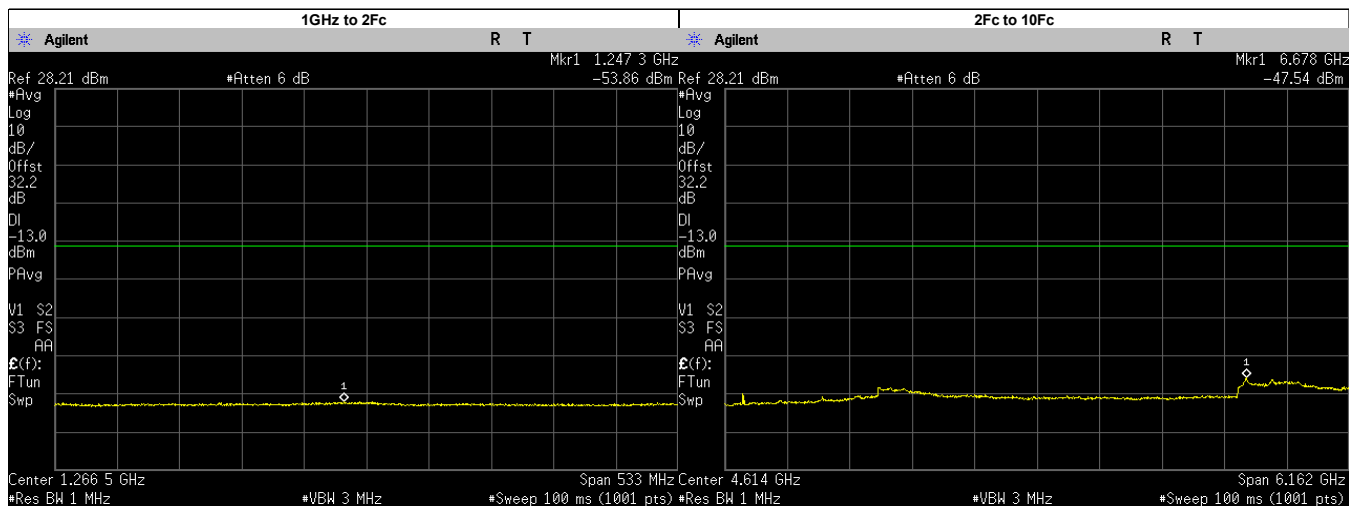
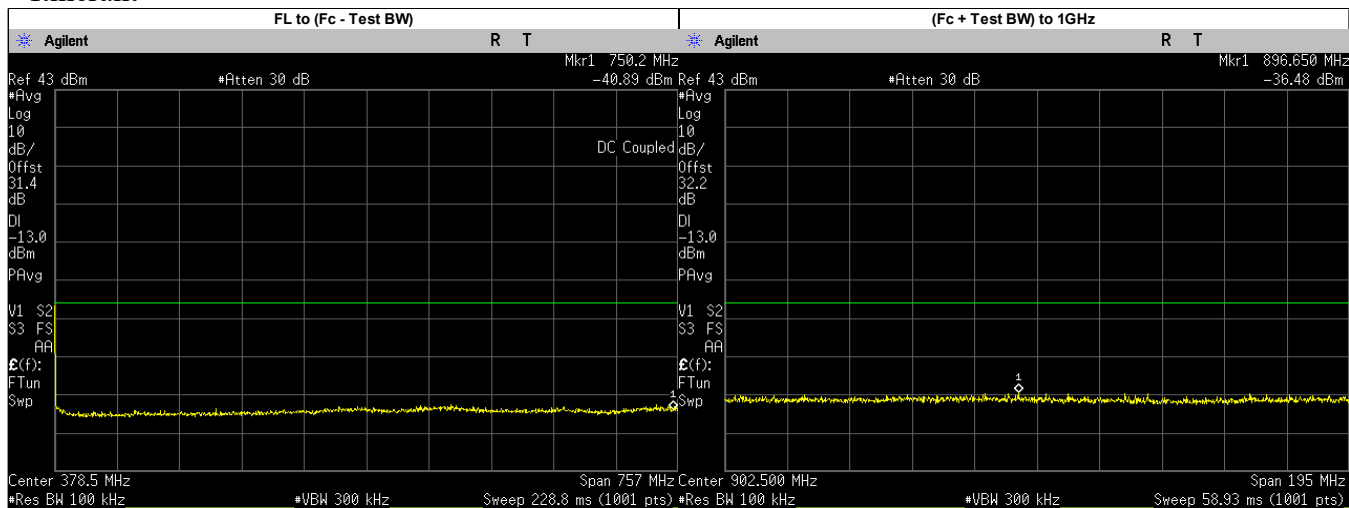

Frequency Range	Highest Spur Frequency (MHz)	Spurious Level (dBm)	Failing Limit (dBm)	Results
FL to (Fc - Test BW)	750.2000	-40.8880	-13.00	PASS
(Fc + Test BW) to 1GHz	896.6500	-36.4800	-13.00	PASS
1GHz to 2Fc	1247.3240	-53.8600	-13.00	PASS
2Fc to 10Fc	6678.3780	-47.5400	-13.00	PASS
	1538.0250	-54.4520	-13.00	PASS
	2307.0370	-53.9869	-13.00	PASS
	3076.0500	-50.6205	-13.00	PASS
	3845.0620	-52.5158	-13.00	PASS
	4614.0750	-52.8930	-13.00	PASS
	5383.0870	-52.7906	-13.00	PASS
	6152.1000	-52.7955	-13.00	PASS
	6921.1130	-48.5380	-13.00	PASS
	7690.1250	-50.0533	-13.00	PASS

Analog: 769.0875 MHz, 12.5.kHz Channel Spacing, Max. Power

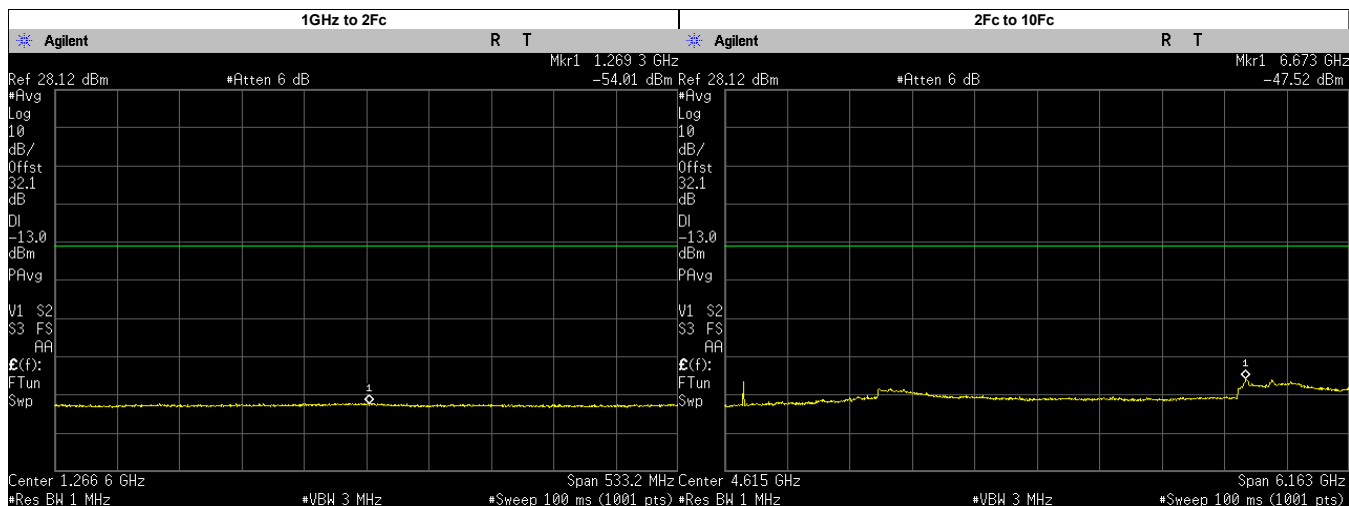
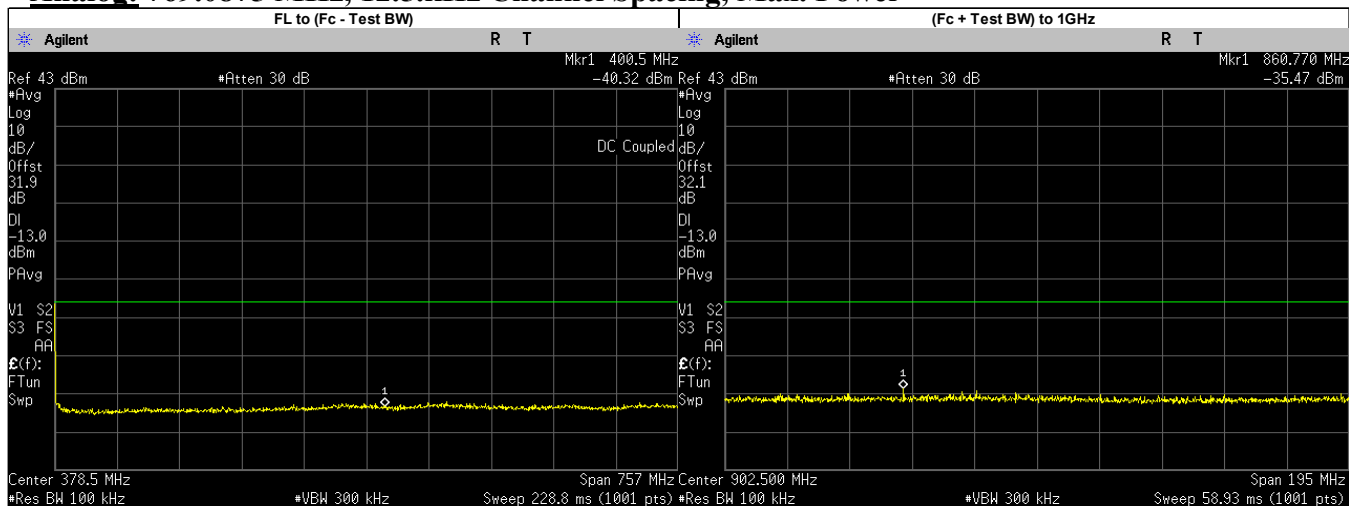

Frequency Range	Highest Spur Frequency (MHz)	Spurious Level (dBm)	Failing Limit (dBm)	Results
FL to (Fc - Test BW)	400.5000	-40.3190	-13.00	PASS
(Fc + Test BW) to 1GHz	860.7700	-35.4700	-13.00	PASS
1GHz to 2Fc	1269.2530	-54.0100	-13.00	PASS
2Fc to 10Fc	6672.8670	-47.5200	-13.00	PASS
	1538.1750	-54.3914	-13.00	PASS
	2307.2620	-54.2667	-13.00	PASS
	3076.3500	-50.7454	-13.00	PASS
	3845.4370	-52.5124	-13.00	PASS
	4614.5250	-52.9570	-13.00	PASS
	5383.6130	-52.8485	-13.00	PASS
	6152.7000	-52.8072	-13.00	PASS
	6921.7880	-48.5150	-13.00	PASS
7690.8750	-50.4002	-13.00	PASS	

Analog: 774.8875. MHz, 12.5.kHz Channel Spacing, Max. Power

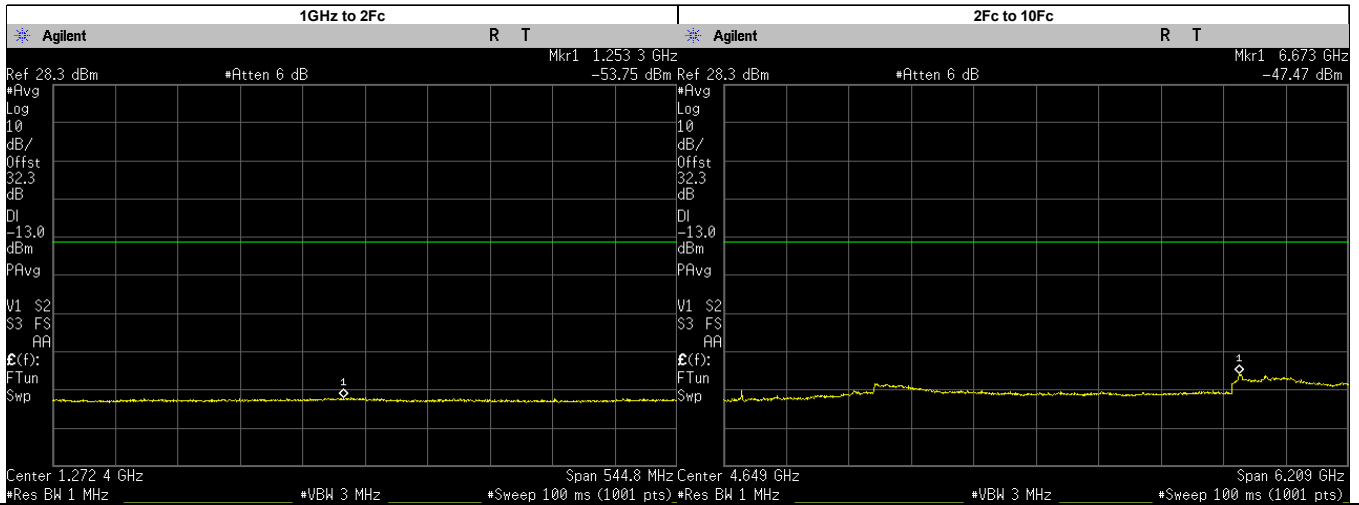
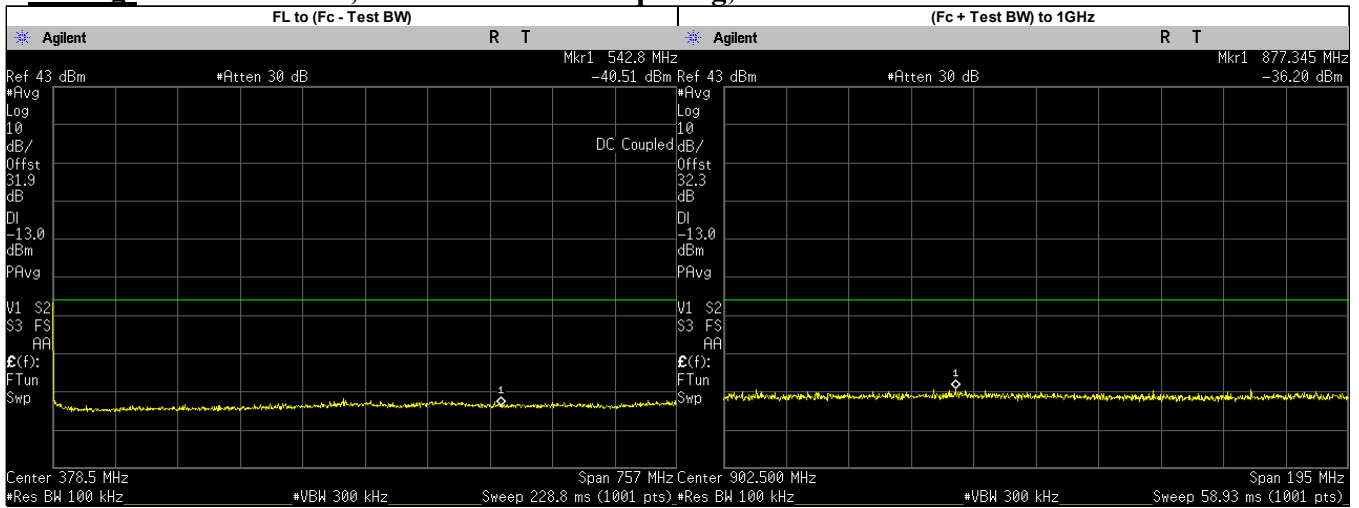

Frequency Range	Highest Spur Frequency (MHz)	Spurious Level (dBm)	Failing Limit (dBm)	Results
FL to (Fc - Test BW)	542.8000	-40.5080	-13.00	PASS
(Fc + Test BW) to 1GHz	877.3450	-36.2000	-13.00	PASS
1GHz to 2Fc	1253.3200	-53.7500	-13.00	PASS
2Fc to 10Fc	6673.4920	-47.4700	-13.00	PASS
	1549.7750	-54.3208	-13.00	PASS
	2324.6620	-54.0259	-13.00	PASS
	3099.5500	-50.6953	-13.00	PASS
	3874.4370	-52.1663	-13.00	PASS
	4649.3250	-52.9070	-13.00	PASS
	5424.2120	-52.8257	-13.00	PASS
	6199.1000	-52.5576	-13.00	PASS
	6973.9880	-48.9754	-13.00	PASS
	7748.8750	-50.1956	-13.00	PASS

Analog: 792.0125. MHz, 12.5.kHz Channel Spacing, Max. Power
 Not for FCC review

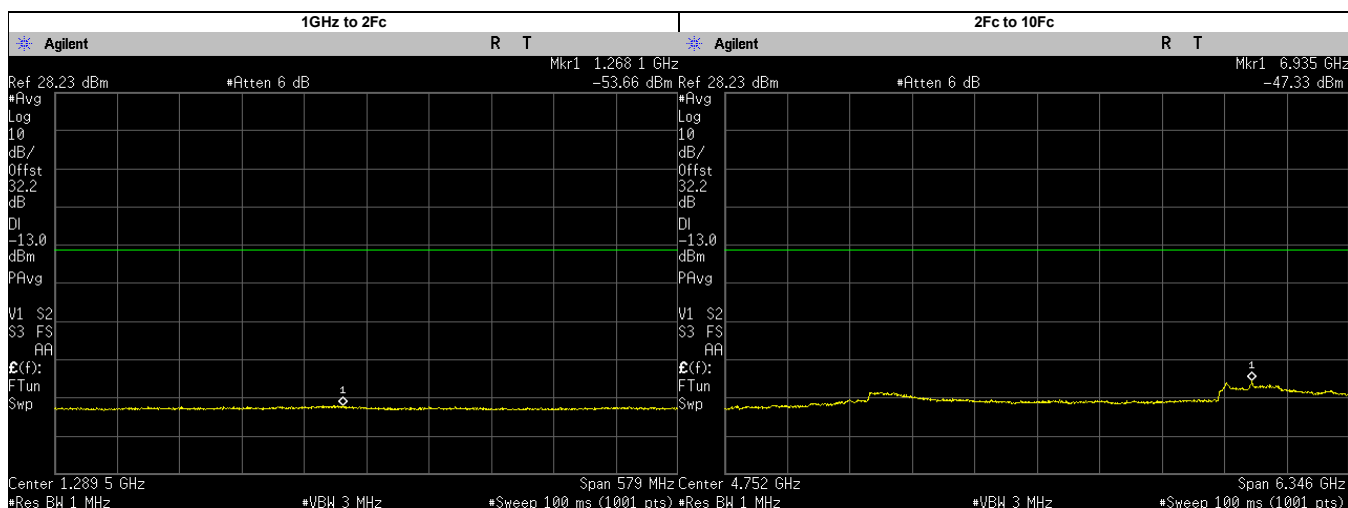
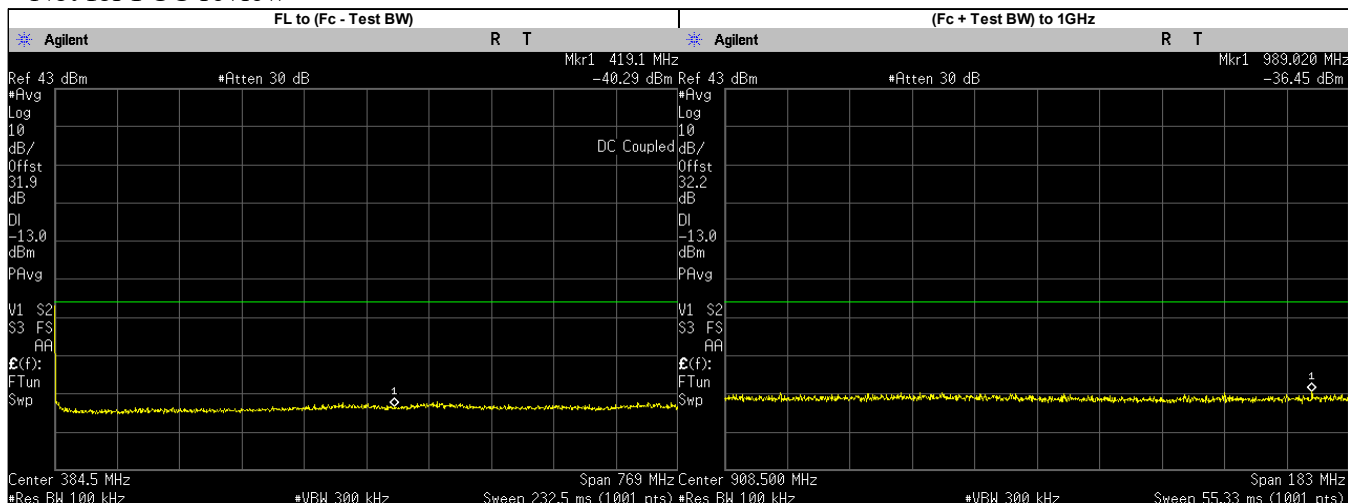

Frequency Range	Highest Spur Frequency (MHz)	Spurious Level (dBm)	Failing Limit (dBm)	Results
FL to (Fc - Test BW)	419.1000	-40.2940	-13.00	PASS
(Fc + Test BW) to 1GHz	989.0200	-36.4500	-13.00	PASS
1GHz to 2Fc	1268.0890	-53.6600	-13.00	PASS
2Fc to 10Fc	6935.1330	-47.3300	-13.00	PASS
	1584.0250	-54.5704	-13.00	PASS
	2376.0370	-53.8937	-13.00	PASS
	3168.0500	-50.3301	-13.00	PASS
	3960.0620	-52.2282	-13.00	PASS
	4752.0750	-52.8550	-13.00	PASS
	5544.0870	-53.1676	-13.00	PASS
	6336.1000	-52.4006	-13.00	PASS
7128.1130	-48.9036	-13.00	PASS	
7920.1250	-50.6867	-13.00	PASS	

Analog: 799.0875. MHz, 12.5.kHz Channel Spacing, Max. Power

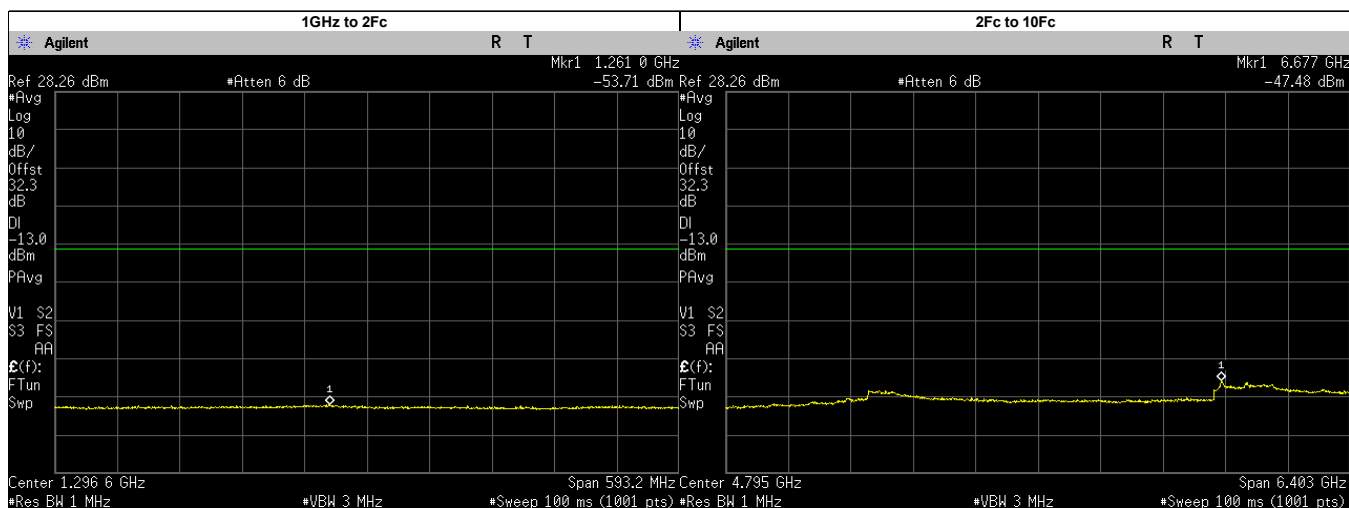
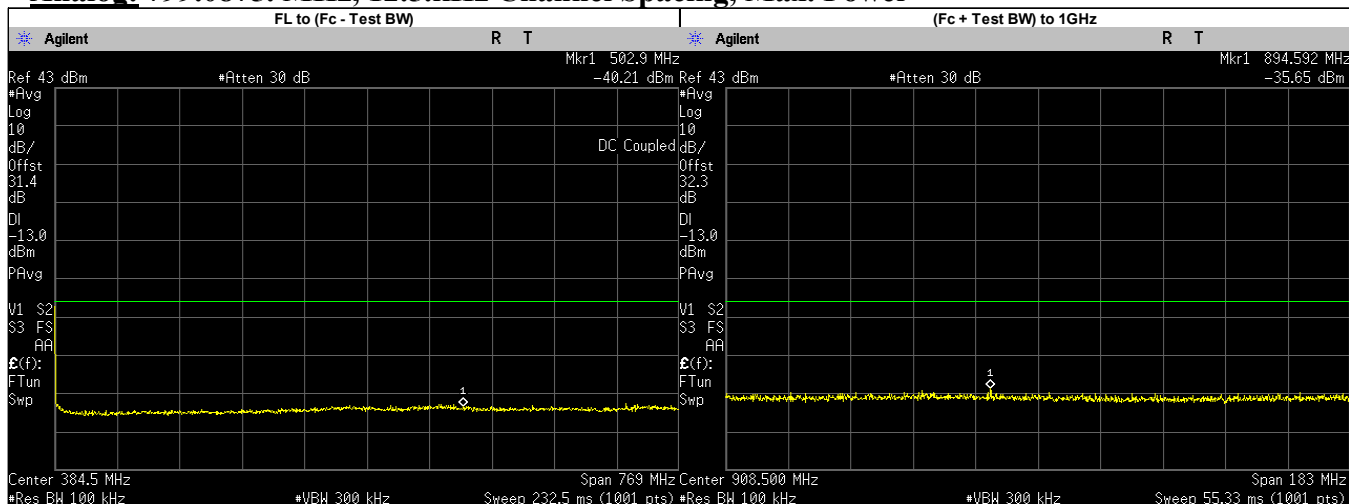

Frequency Range	Highest Spur Frequency (MHz)	Spurious Level (dBm)	Failing Limit (dBm)	Results
FL to (Fc - Test BW)	502.9000	-40.2140	-13.00	PASS
(Fc + Test BW) to 1GHz	894.5920	-35.6500	-13.00	PASS
1GHz to 2Fc	1260.9970	-53.7100	-13.00	PASS
2Fc to 10Fc	6676.9190	-47.4800	-13.00	PASS
	1598.1750	-54.6030	-13.00	PASS
	2397.2620	-53.8709	-13.00	PASS
	3196.3500	-50.7677	-13.00	PASS
	3995.4370	-52.3127	-13.00	PASS
	4794.5250	-52.7500	-13.00	PASS
	5593.6130	-53.0510	-13.00	PASS
	6392.7000	-52.6159	-13.00	PASS
	7191.7880	-48.4852	-13.00	PASS
7990.8750	-50.4791	-13.00	PASS	

Analog: 804.9125. MHz, 12.5.kHz Channel Spacing, Max. Power

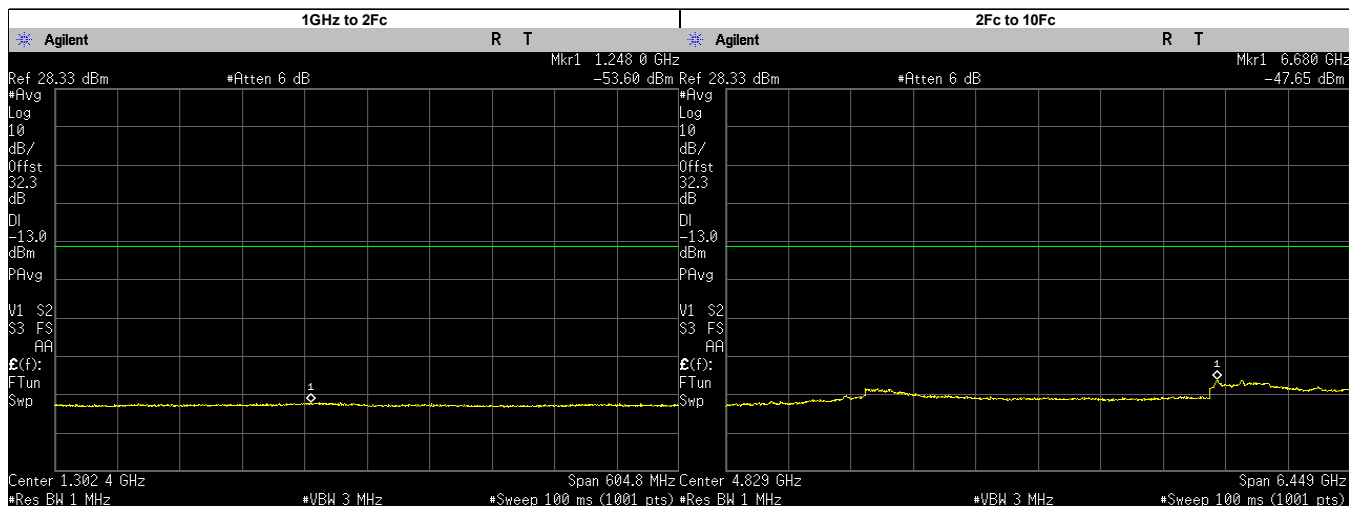
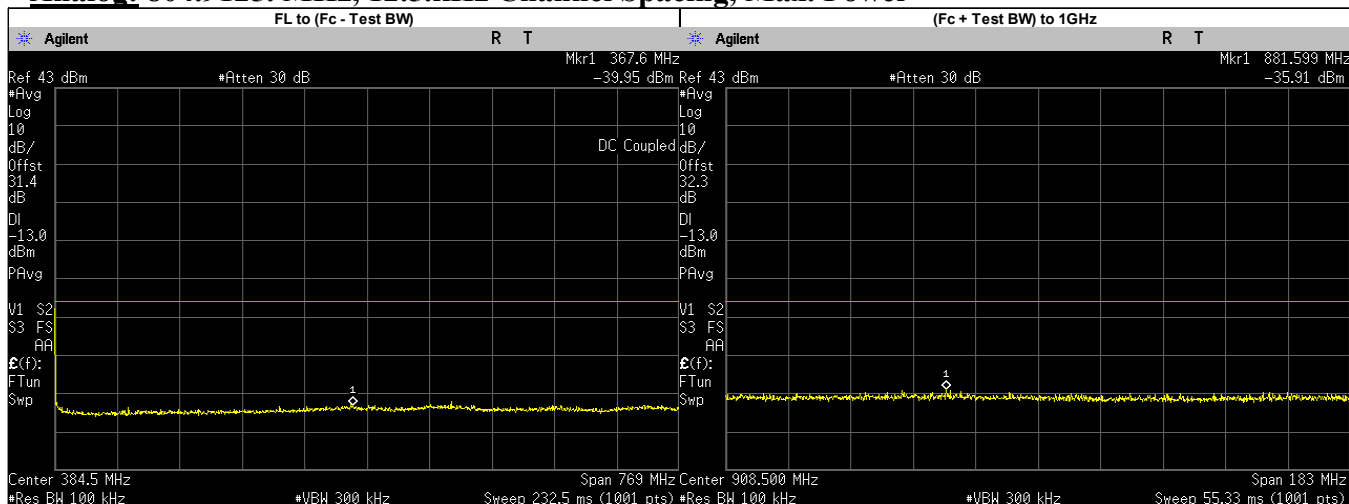

Frequency Range	Highest Spur Frequency (MHz)	Spurious Level (dBm)	Failing Limit (dBm)	Results
FL to (Fc - Test BW)	367.6000	-39.9470	-13.00	PASS
(Fc + Test BW) to 1GHz	881.5990	-35.9100	-13.00	PASS
1GHz to 2Fc	1247.9780	-53.5900	-13.00	PASS
2Fc to 10Fc	6680.4240	-47.6500	-13.00	PASS
	1609.8250	-54.5300	-13.00	PASS
	2414.7380	-53.7342	-13.00	PASS
	3219.6500	-50.4329	-13.00	PASS
	4024.5620	-52.2766	-13.00	PASS
	4829.4750	-52.8490	-13.00	PASS
	5634.3870	-52.9260	-13.00	PASS
	6439.3000	-52.5213	-13.00	PASS
	7244.2120	-49.4576	-13.00	PASS
8049.1250	-50.5795	-13.00	PASS	

6.9.3. Test Result (Digital)

Digital.: 762.0125. MHz, 12.5 kHz Channel Spacing, Max. Power
 Not for FCC review

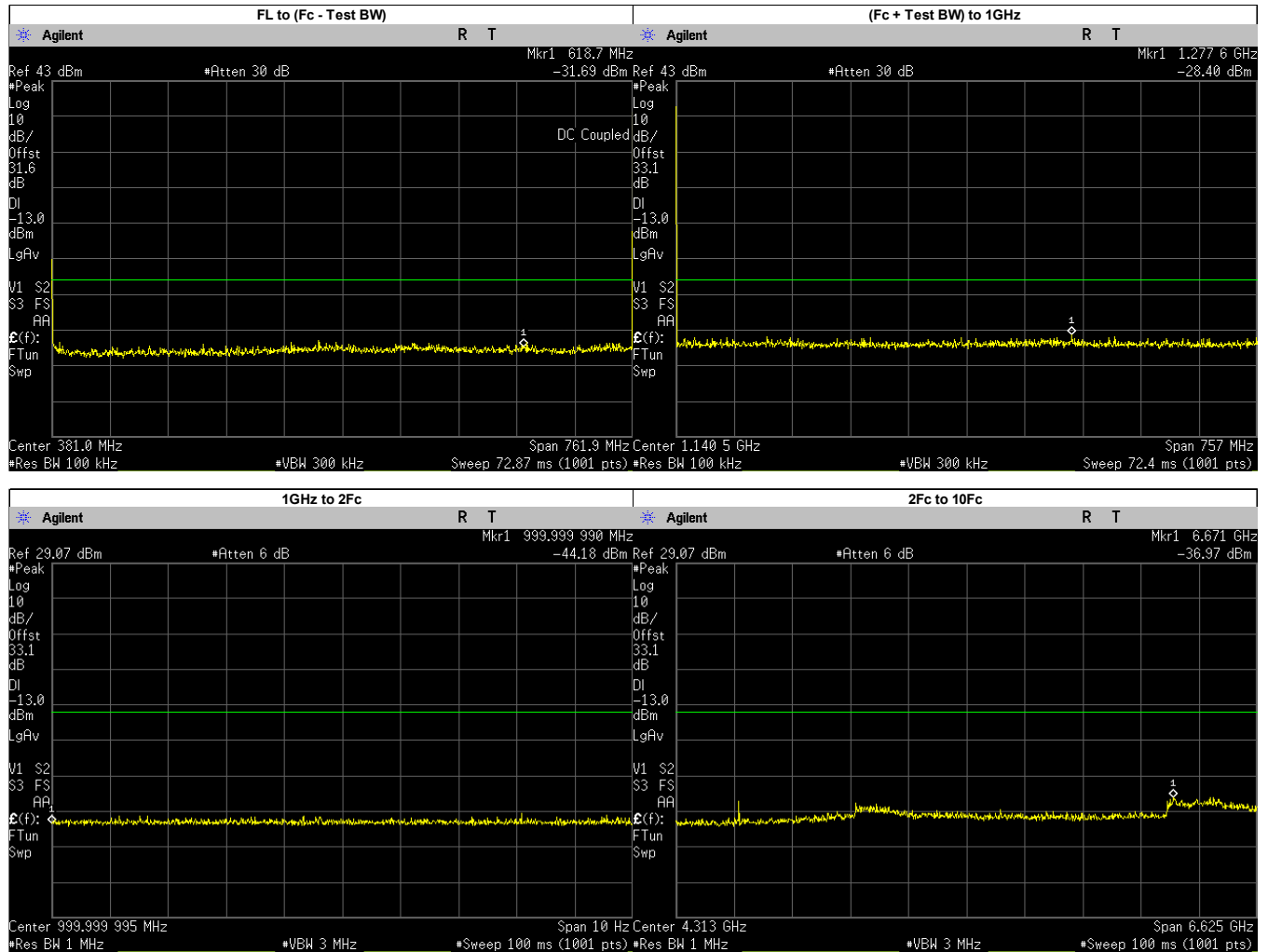

Frequency Range	Highest Spur Frequency (MHz)	Spurious Level (dBm)	Failing Limit (dBm)	Results
FL to (Fc - Test BW)	618.7000	-31.6940	-13.00	PASS
(Fc + Test BW) to 1GHz	1277.5560	-28.4000	-13.00	PASS
1GHz to 2Fc	1000.0000	-44.1800	-13.00	PASS
2Fc to 10Fc	6671.1070	-36.9700	-13.00	PASS
	1524.0250	-44.2770	-13.00	PASS
	2286.0370	-42.9556	-13.00	PASS
	3048.0500	-39.9519	-13.00	PASS
	3810.0620	-41.9717	-13.00	PASS
	4572.0750	-41.7181	-13.00	PASS
	5334.0870	-42.2567	-13.00	PASS
	6096.1000	-42.9622	-13.00	PASS
	6858.1130	-38.9878	-13.00	PASS
7620.1250	-39.8202	-13.00	PASS	

Digital.: 769.0125. MHz, 12.5 kHz Channel Spacing, Max. Power Itinerant

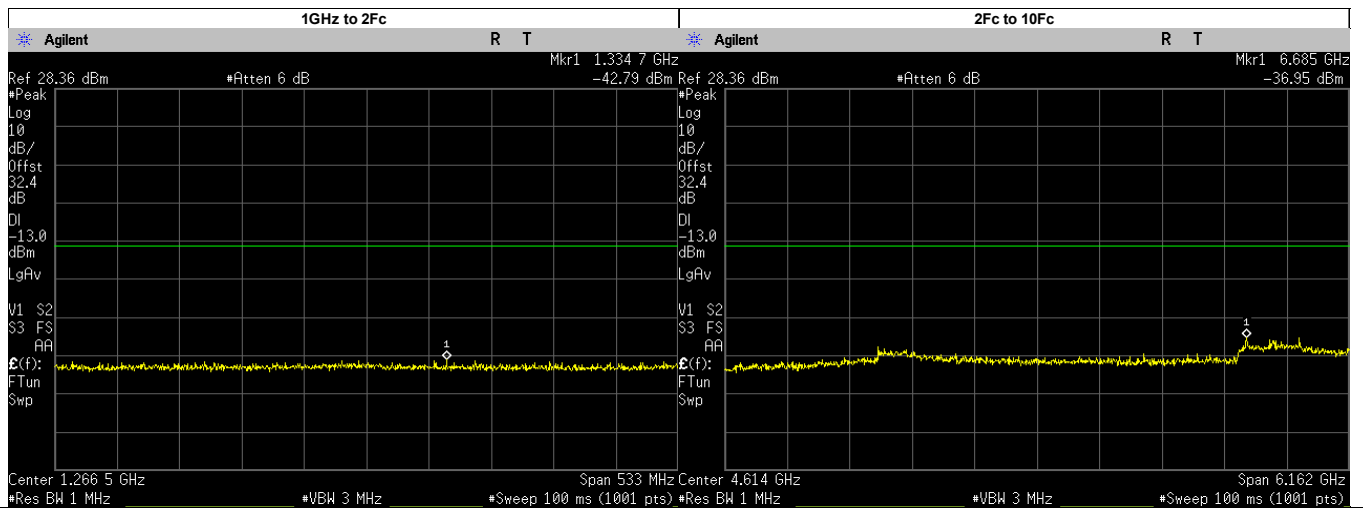
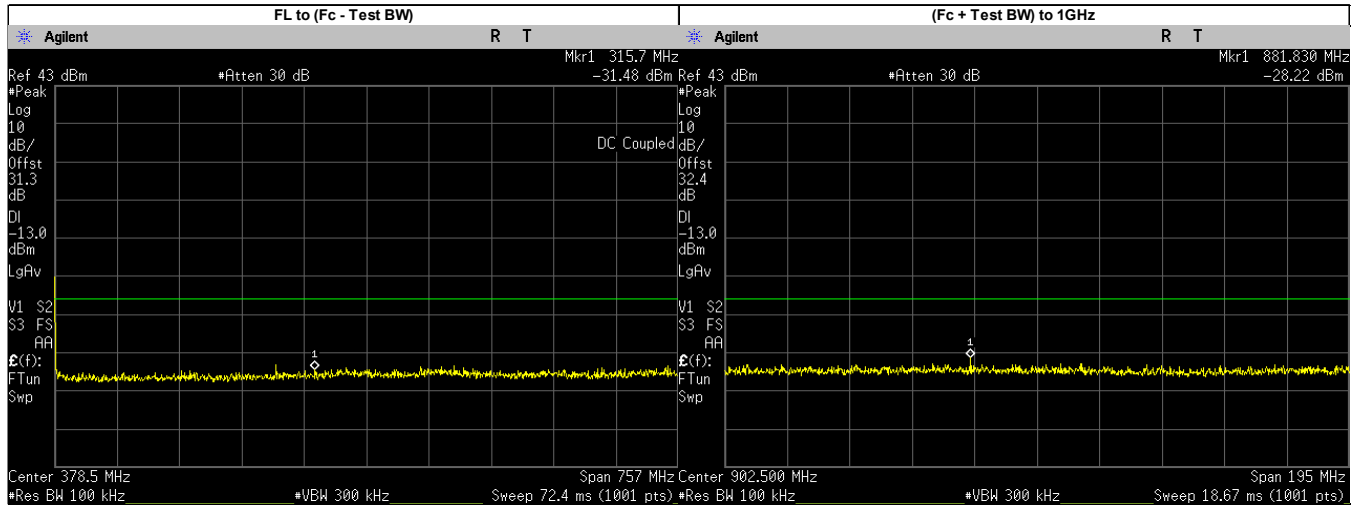

Frequency Range	Highest Spur Frequency (MHz)	Spurious Level (dBm)	Failing Limit (dBm)	Results
FL to (Fc - Test BW)	315.7000	-31.4790	-13.00	PASS
(Fc + Test BW) to 1GHz	881.8300	-28.2200	-13.00	PASS
1GHz to 2Fc	1334.7400	-42.7900	-13.00	PASS
2Fc to 10Fc	6684.5410	-36.9500	-13.00	PASS
	1538.0250	-45.0368	-13.00	PASS
	2307.0370	-44.9559	-13.00	PASS
	3076.0500	-41.1048	-13.00	PASS
	3845.0620	-43.5111	-13.00	PASS
	4614.0750	-42.4510	-13.00	PASS
	5383.0870	-43.2000	-13.00	PASS
	6152.1000	-43.2295	-13.00	PASS
6921.1130	-39.2123	-13.00	PASS	
7690.1250	-40.3084	-13.00	PASS	

Digital.: 769.0875. MHz, 12.5 kHz Channel Spacing, Max. Power

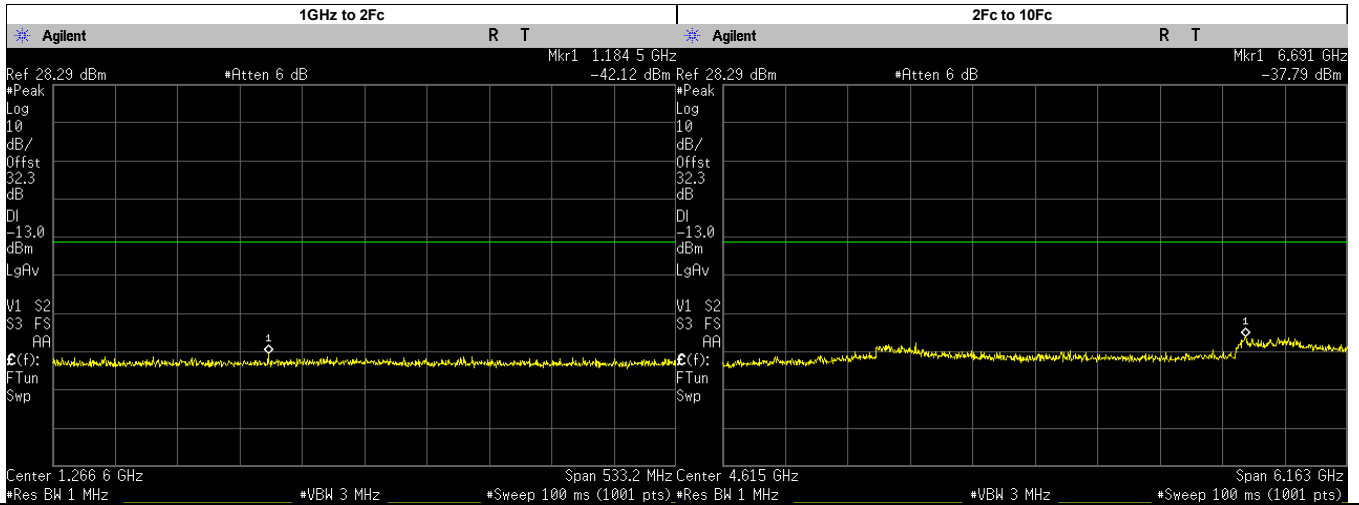
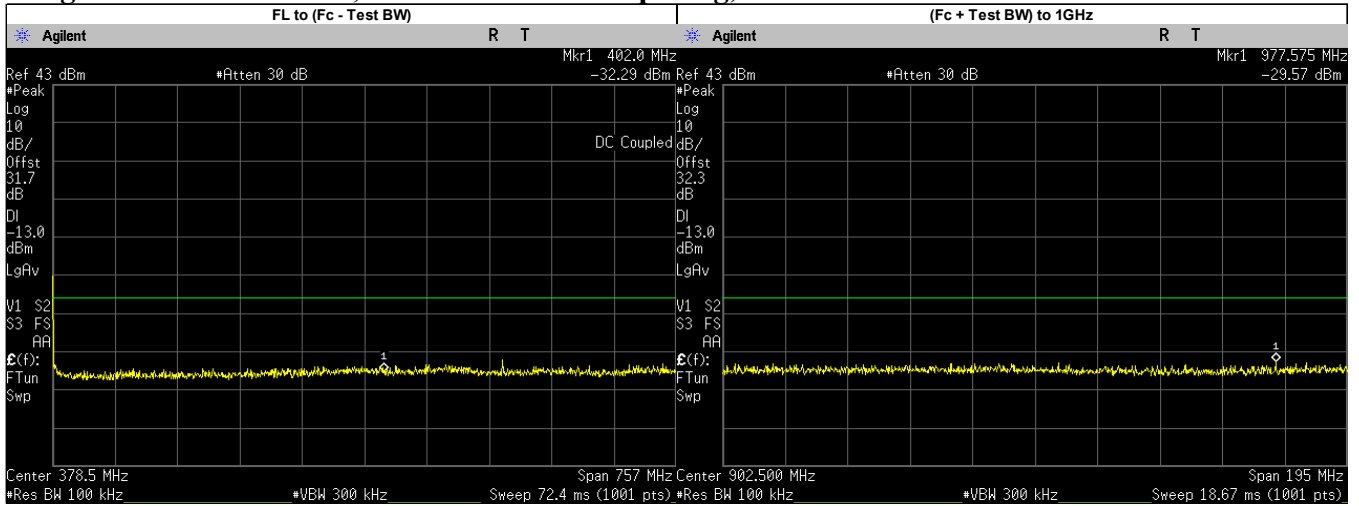

Frequency Range	Highest Spur Frequency (MHz)	Spurious Level (dBm)	Failing Limit (dBm)	Results
FL to (Fc - Test BW)	402.0000	-32.2920	-13.00	PASS
(Fc + Test BW) to 1GHz	977.5750	-29.5700	-13.00	PASS
1GHz to 2Fc	1184.4790	-42.1200	-13.00	PASS
2Fc to 10Fc	6691.3550	-37.8000	-13.00	PASS
	1538.1750	-45.3640	-13.00	PASS
	2307.2620	-44.5979	-13.00	PASS
	3076.3500	-40.7383	-13.00	PASS
	3845.4370	-43.3775	-13.00	PASS
	4614.5250	-43.6520	-13.00	PASS
	5383.6130	-43.0171	-13.00	PASS
	6152.7000	-43.0532	-13.00	PASS
	6921.7880	-39.2712	-13.00	PASS
	7690.8750	-40.7849	-13.00	PASS

Digital.: 774.8875. MHz, 12.5 kHz Channel Spacing, Max. Power

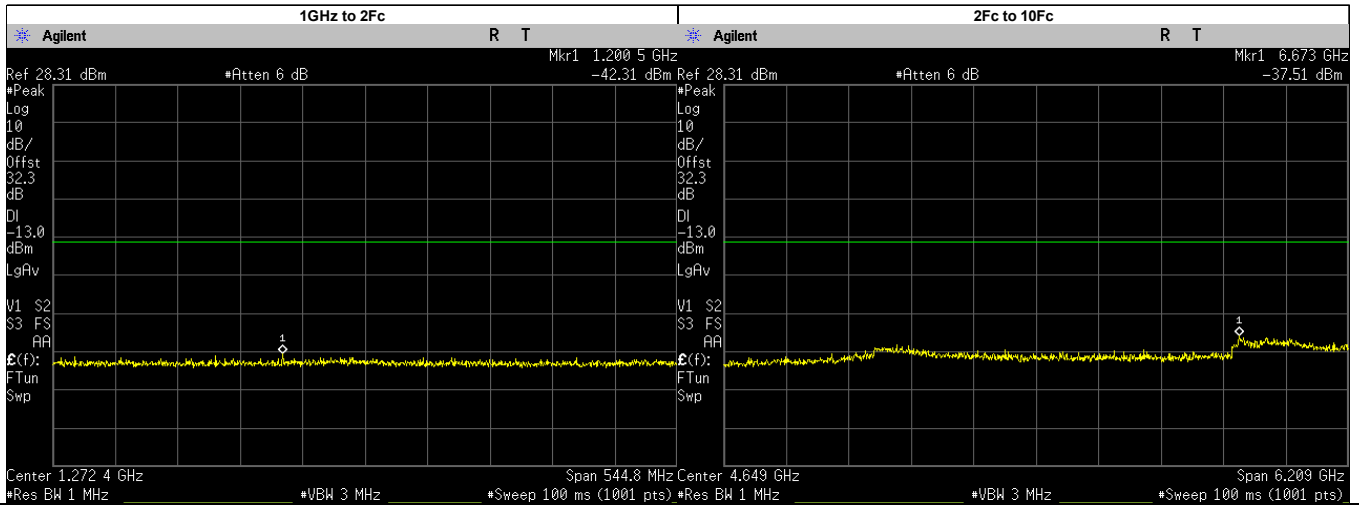
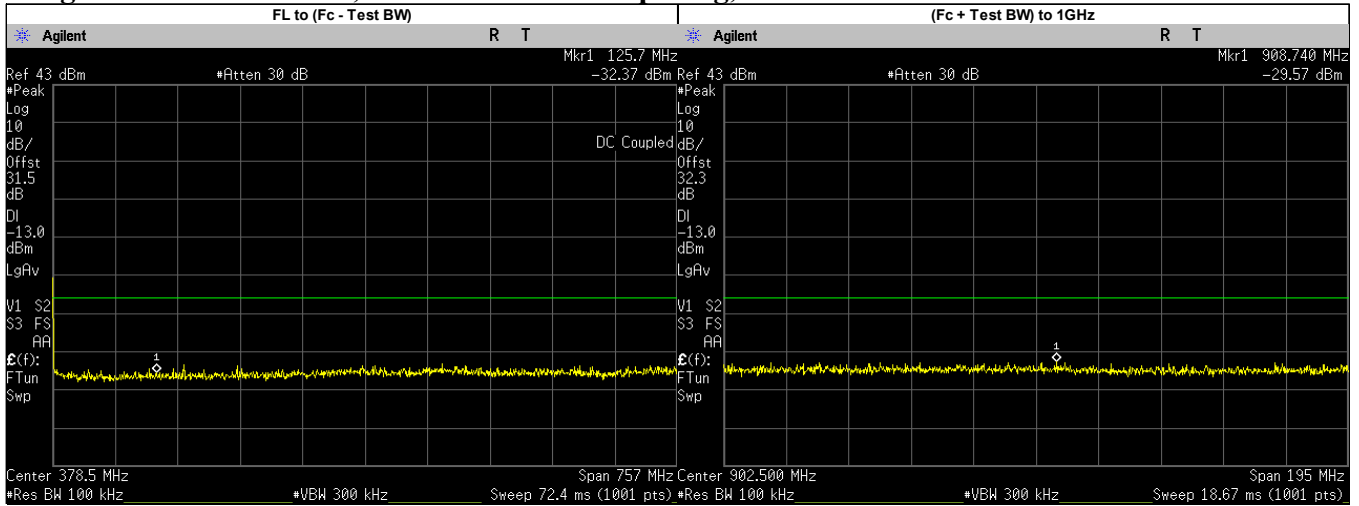

Frequency Range	Highest Spur Frequency (MHz)	Spurious Level (dBm)	Failing Limit (dBm)	Results
FL to (Fc - Test BW)	125.7000	-32.3660	-13.00	PASS
(Fc + Test BW) to 1GHz	908.7400	-29.5700	-13.00	PASS
1GHz to 2Fc	1200.4770	-42.3100	-13.00	PASS
2Fc to 10Fc	6673.4920	-37.5200	-13.00	PASS
	1549.7750	-45.1791	-13.00	PASS
	2324.6620	-44.5789	-13.00	PASS
	3099.5500	-41.2742	-13.00	PASS
	3874.4370	-43.3388	-13.00	PASS
	4649.3250	-42.7960	-13.00	PASS
	5424.2120	-41.8493	-13.00	PASS
	6199.1000	-43.5423	-13.00	PASS
	6973.9880	-39.5159	-13.00	PASS
	7748.8750	-41.0865	-13.00	PASS

Digital.: 792.0125. MHz, 12.5 kHz Channel Spacing, Max. Power
 Not for FCC review

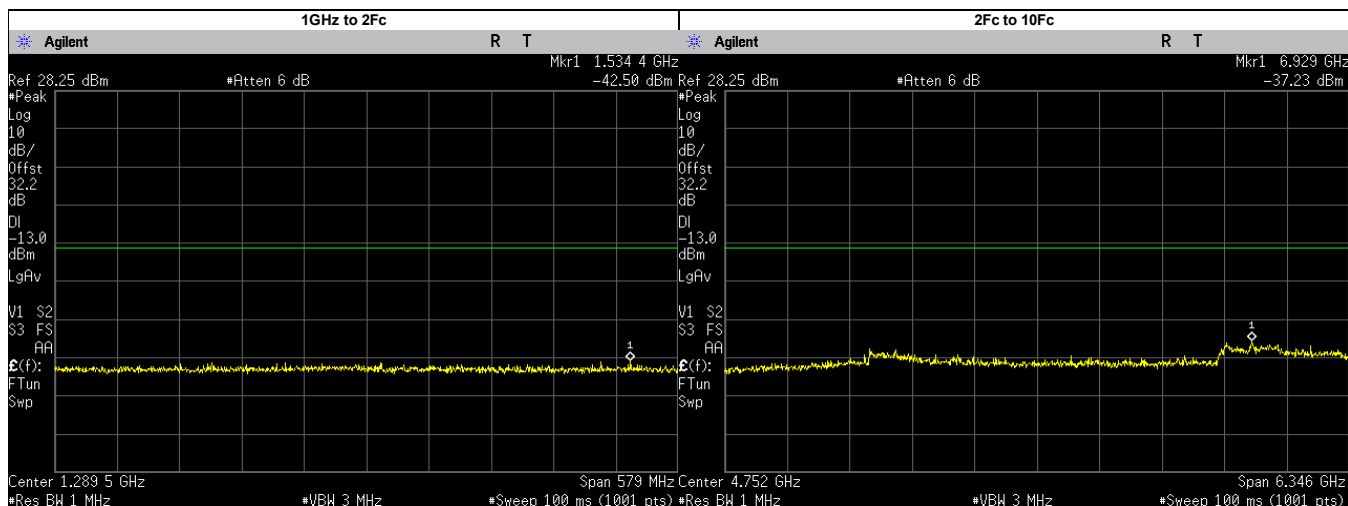
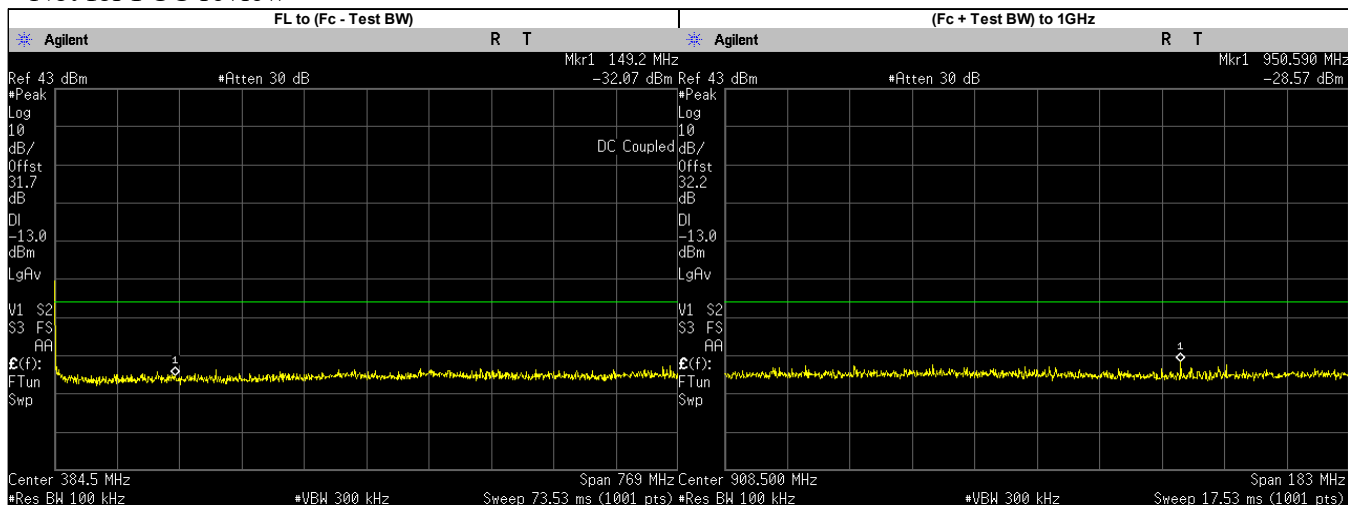

Frequency Range	Highest Spur Frequency (MHz)	Spurious Level (dBm)	Failing Limit (dBm)	Results
FL to (Fc - Test BW)	149.2000	-32.0720	-13.00	PASS
(Fc + Test BW) to 1GHz	950.5900	-28.5700	-13.00	PASS
1GHz to 2Fc	1534.4400	-42.5000	-13.00	PASS
2Fc to 10Fc	6928.7870	-37.2300	-13.00	PASS
	1584.0250	-44.7055	-13.00	PASS
	2376.0370	-43.8500	-13.00	PASS
	3168.0500	-40.9721	-13.00	PASS
	3960.0620	-41.8736	-13.00	PASS
	4752.0750	-43.8350	-13.00	PASS
	5544.0870	-43.2545	-13.00	PASS
	6336.1000	-42.3333	-13.00	PASS
7128.1130	-39.0218	-13.00	PASS	
7920.1250	-41.7206	-13.00	PASS	

Digital.: 799.0875. MHz, 12.5 kHz Channel Spacing, Max. Power

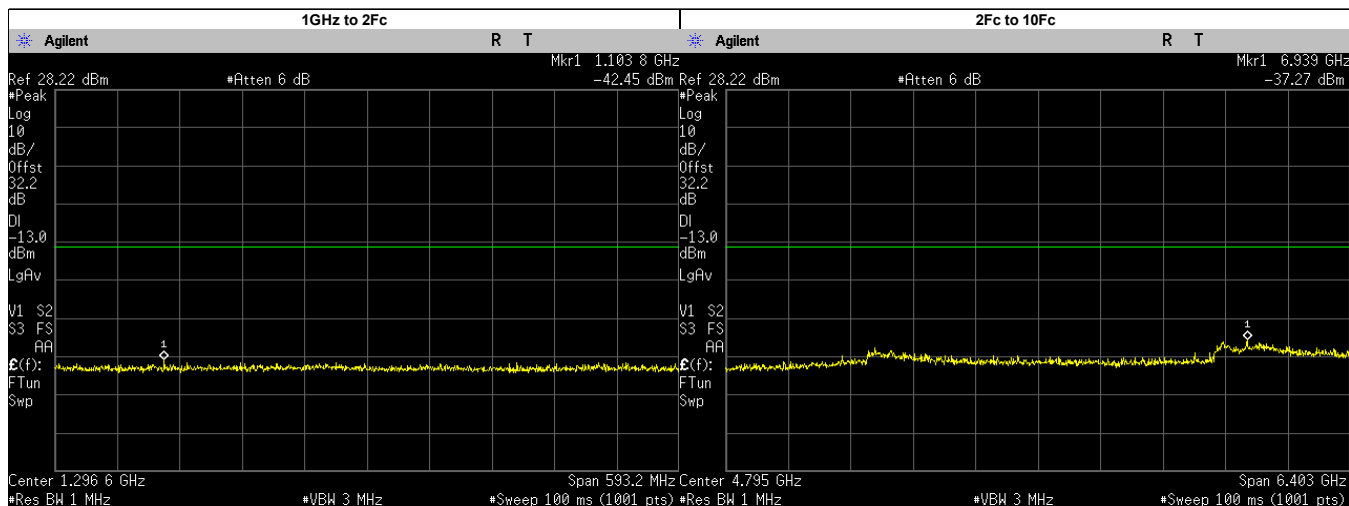
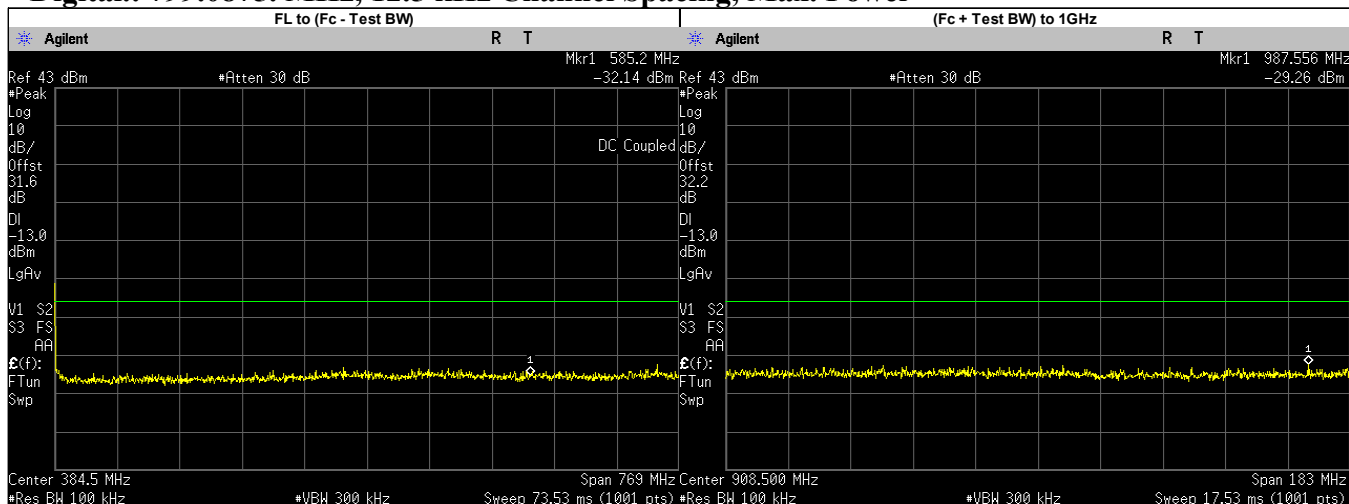

Frequency Range	Highest Spur Frequency (MHz)	Spurious Level (dBm)	Failing Limit (dBm)	Results
FL to (Fc - Test BW)	585.2000	-32.1390	-13.00	PASS
(Fc + Test BW) to 1GHz	987.5560	-29.2600	-13.00	PASS
1GHz to 2Fc	1103.8060	-42.4500	-13.00	PASS
2Fc to 10Fc	6939.4300	-37.2700	-13.00	PASS
	1598.1750	-45.4347	-13.00	PASS
	2397.2620	-43.8502	-13.00	PASS
	3196.3500	-41.7742	-13.00	PASS
	3995.4370	-43.1778	-13.00	PASS
	4794.5250	-43.3670	-13.00	PASS
	5593.6130	-43.7132	-13.00	PASS
	6392.7000	-42.7641	-13.00	PASS
7191.7880	-39.2146	-13.00	PASS	
7990.8750	-41.0969	-13.00	PASS	

Digital.: 804.9125. MHz, 12.5 kHz Channel Spacing, Max. Power

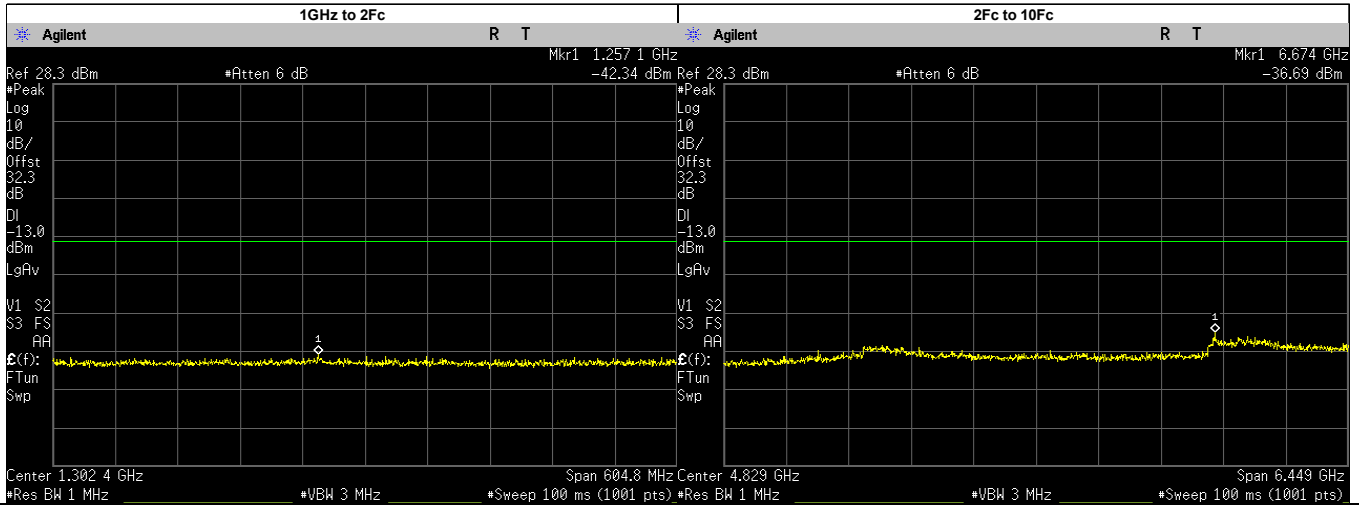
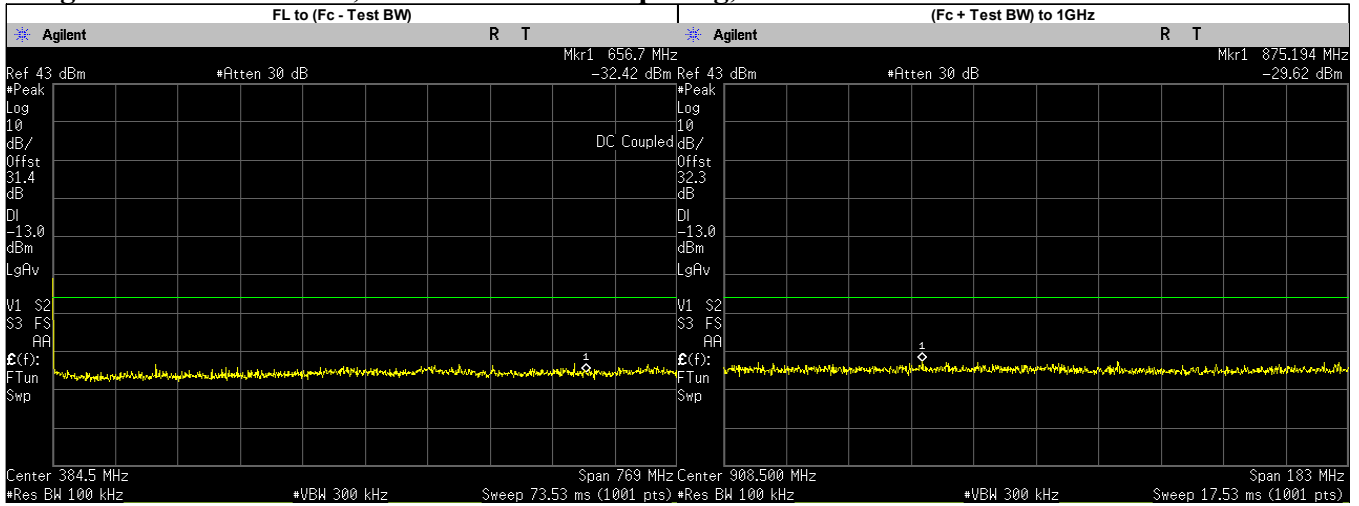

Frequency Range	Highest Spur Frequency (MHz)	Spurious Level (dBm)	Failing Limit (dBm)	Results
FL to (Fc - Test BW)	656.7000	-32.4150	-13.00	PASS
(Fc + Test BW) to 1GHz	875.1940	-29.6200	-13.00	PASS
1GHz to 2Fc	1257.0510	-42.3400	-13.00	PASS
2Fc to 10Fc	6673.9750	-36.6900	-13.00	PASS
	1609.8250	-45.0882	-13.00	PASS
	2414.7380	-44.1462	-13.00	PASS
	3219.6500	-40.9243	-13.00	PASS
	4024.5620	-43.5439	-13.00	PASS
	4829.4750	-42.4810	-13.00	PASS
	5634.3870	-43.3320	-13.00	PASS
	6439.3000	-42.7768	-13.00	PASS
	7244.2120	-39.3445	-13.00	PASS
8049.1250	-40.9987	-13.00	PASS	

Phase II.: 762.0125. MHz, 12.5 kHz Channel Spacing, Max. Power
 Not for FCC review

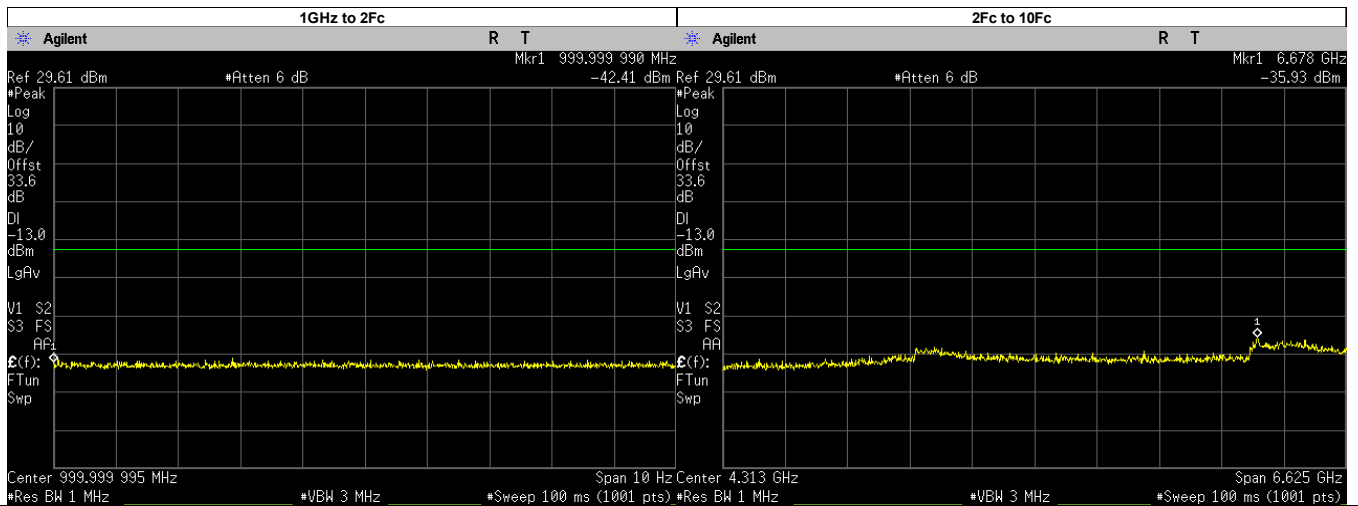
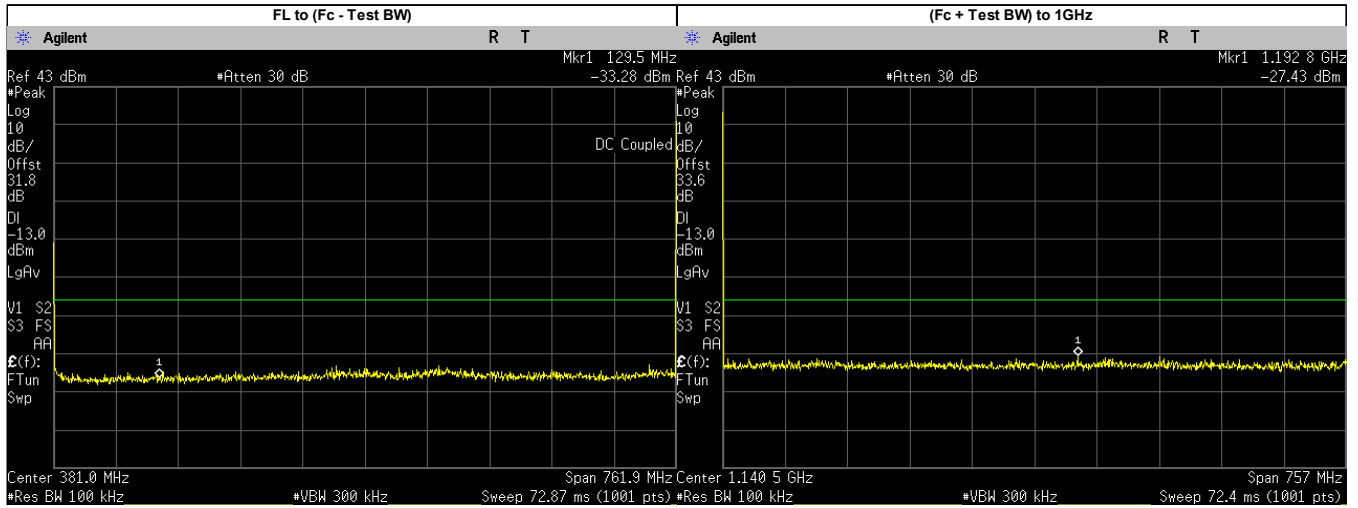

Frequency Range	Highest Spur Frequency (MHz)	Spurious Level (dBm)	Failing Limit (dBm)	Results
FL to (Fc - Test BW)	129.5000	-33.2500	-13.00	PASS
(Fc + Test BW) to 1GHz	1192.7770	-27.4300	-13.00	PASS
1GHz to 2Fc	1000.0000	-42.4100	-13.00	PASS
2Fc to 10Fc	6677.7320	-35.9300	-13.00	PASS
	1524.0250	-42.7574	-13.00	PASS
	2286.0370	-43.2353	-13.00	PASS
	3048.0500	-39.0765	-13.00	PASS
	3810.0620	-41.5533	-13.00	PASS
	4572.0750	-41.8985	-13.00	PASS
	5334.0870	-41.8936	-13.00	PASS
	6096.1000	-41.9476	-13.00	PASS
	6858.1130	-39.0422	-13.00	PASS
	7620.1250	-39.5014	-13.00	PASS

Phase II.: 769.0125. MHz, 12.5 kHz Channel Spacing, Max. Power Itinerant

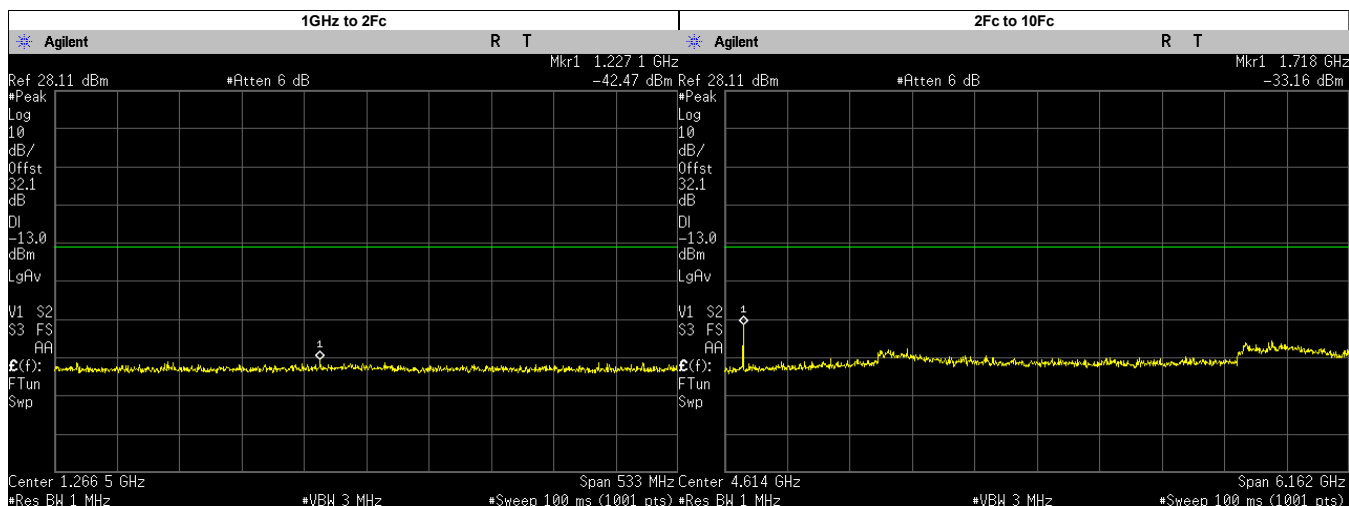
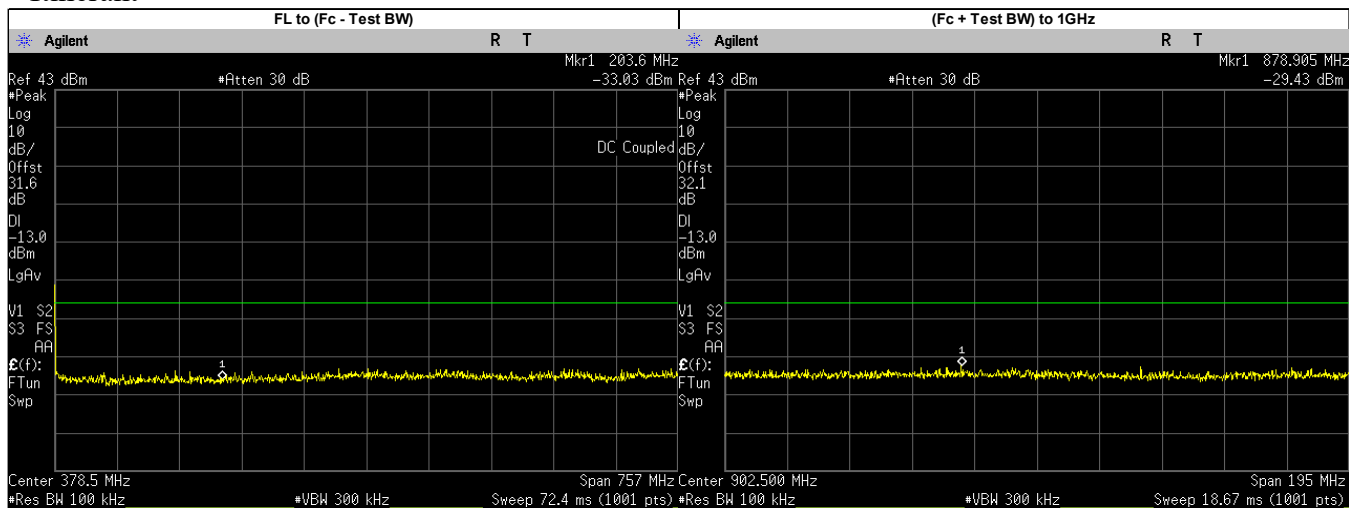

Frequency Range	Highest Spur Frequency (MHz)	Spurious Level (dBm)	Failing Limit (dBm)	Results
FL to (Fc - Test BW)	203.6000	-33.0260	-13.00	PASS
(Fc + Test BW) to 1GHz	878.9050	-29.4300	-13.00	PASS
1GHz to 2Fc	1227.0690	-42.4700	-13.00	PASS
2Fc to 10Fc	1717.8880	-33.1600	-13.00	PASS
	1538.0250	-44.6866	-13.00	PASS
	2307.0370	-44.5021	-13.00	PASS
	3076.0500	-40.5635	-13.00	PASS
	3845.0620	-42.9089	-13.00	PASS
	4614.0750	-42.8720	-13.00	PASS
	5383.0870	-42.4565	-13.00	PASS
	6152.1000	-42.1286	-13.00	PASS
	6921.1130	-39.3906	-13.00	PASS
7690.1250	-40.5369	-13.00	PASS	

Phase II.: 769.0875. MHz, 12.5 kHz Channel Spacing, Max. Power

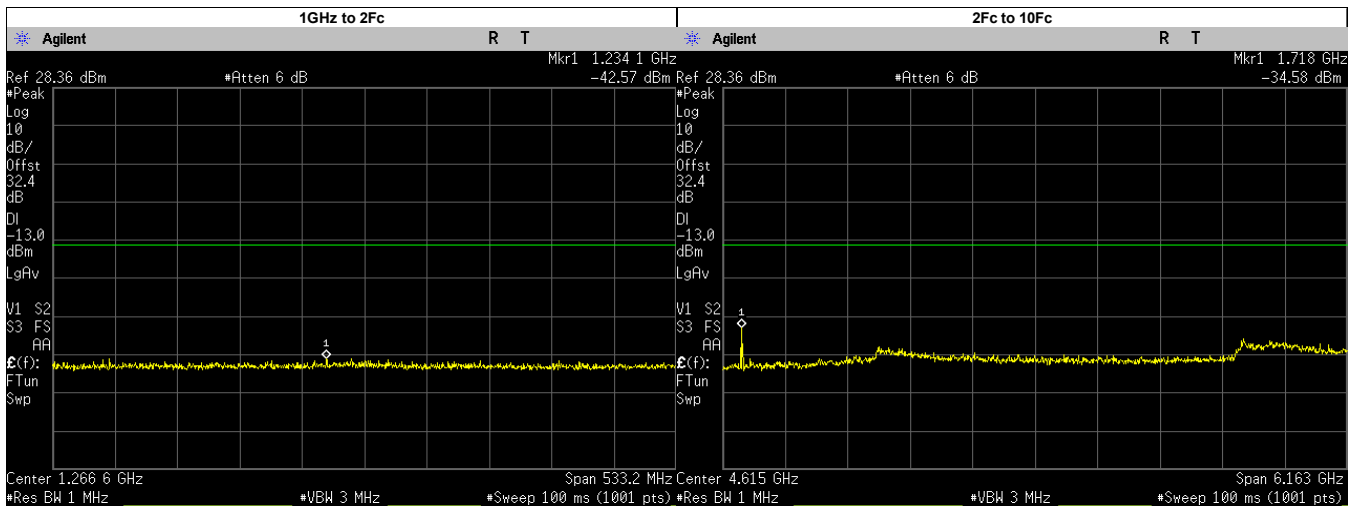
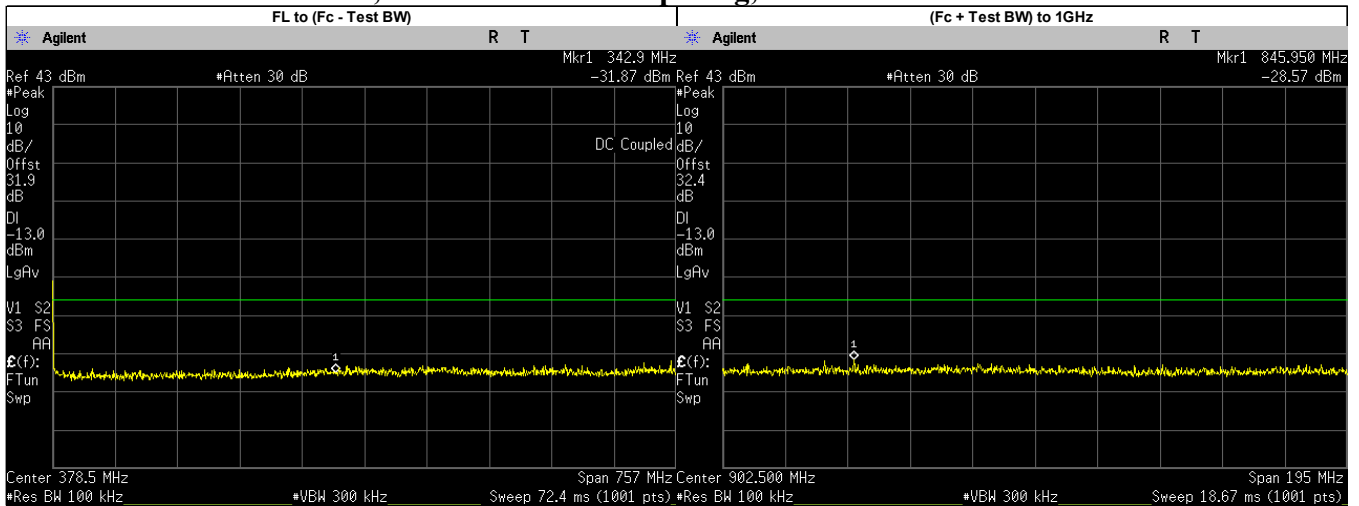

Frequency Range	Highest Spur Frequency (MHz)	Spurious Level (dBm)	Failing Limit (dBm)	Results
FL to (Fc - Test BW)	342.9000	-31.8710	-13.00	PASS
(Fc + Test BW) to 1GHz	845.9500	-28.5700	-13.00	PASS
1GHz to 2Fc	1234.0640	-42.5700	-13.00	PASS
2Fc to 10Fc	1718.0560	-34.5800	-13.00	PASS
	1538.1750	-45.3231	-13.00	PASS
	2307.2620	-44.9648	-13.00	PASS
	3076.3500	-39.9737	-13.00	PASS
	3845.4370	-42.8270	-13.00	PASS
	4614.5250	-41.9460	-13.00	PASS
	5383.6130	-42.0899	-13.00	PASS
	6152.7000	-43.1471	-13.00	PASS
	6921.7880	-39.1785	-13.00	PASS
7690.8750	-40.6862	-13.00	PASS	

Phase II.: 774.8875. MHz, 12.5 kHz Channel Spacing, Max. Power

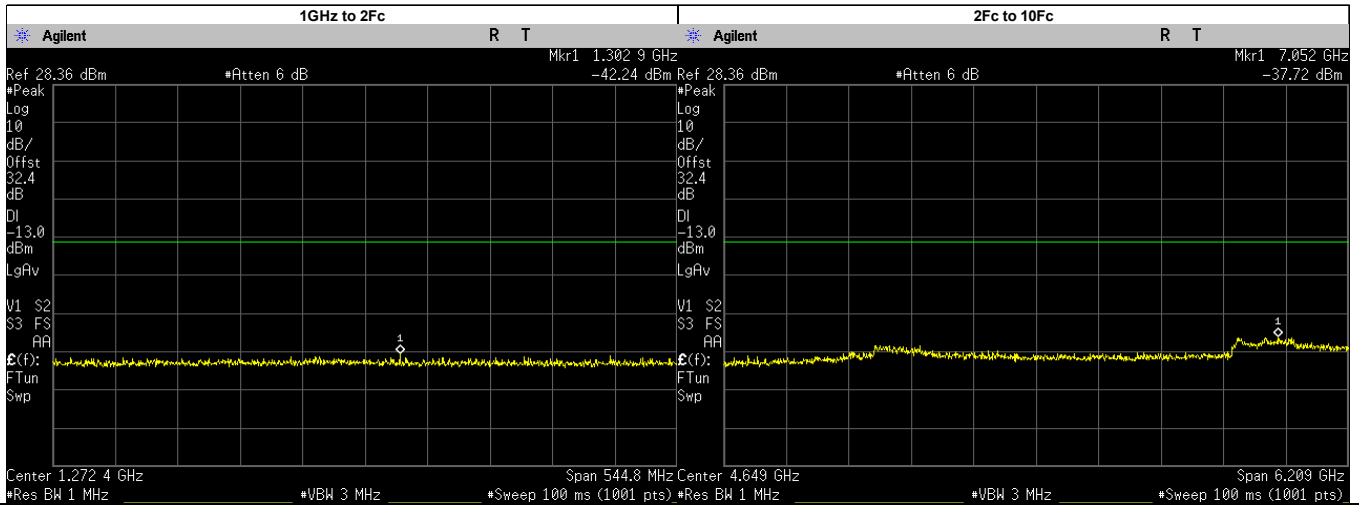
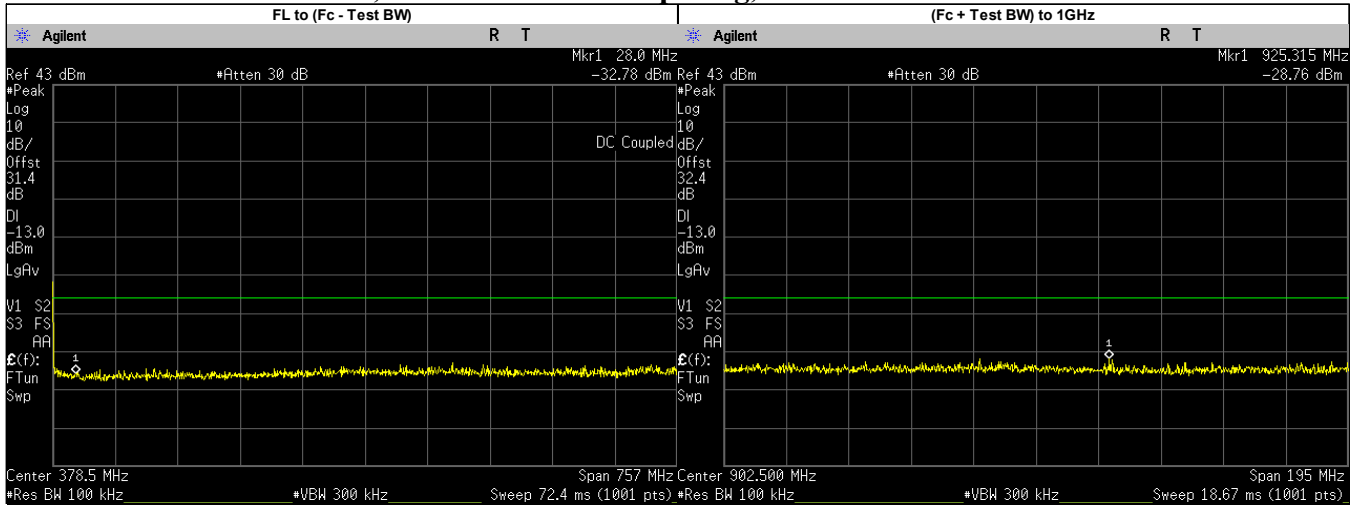

Frequency Range	Highest Spur Frequency (MHz)	Spurious Level (dBm)	Failing Limit (dBm)	Results
FL to (Fc - Test BW)	28.0000	-32.7830	-13.00	PASS
(Fc + Test BW) to 1GHz	925.3150	-28.7600	-13.00	PASS
1GHz to 2Fc	1302.8950	-42.2400	-13.00	PASS
2Fc to 10Fc	7052.2470	-37.7200	-13.00	PASS
	1549.7750	-44.7171	-13.00	PASS
	2324.6620	-44.5449	-13.00	PASS
	3099.5500	-40.1292	-13.00	PASS
	3874.4370	-42.2951	-13.00	PASS
	4649.3250	-42.6270	-13.00	PASS
	5424.2120	-42.4666	-13.00	PASS
	6199.1000	-42.4860	-13.00	PASS
6973.9880	-39.6981	-13.00	PASS	
7748.8750	-40.4556	-13.00	PASS	

Phase II.: 792.0125. MHz, 12.5 kHz Channel Spacing, Max. Power
 Not for FCC review

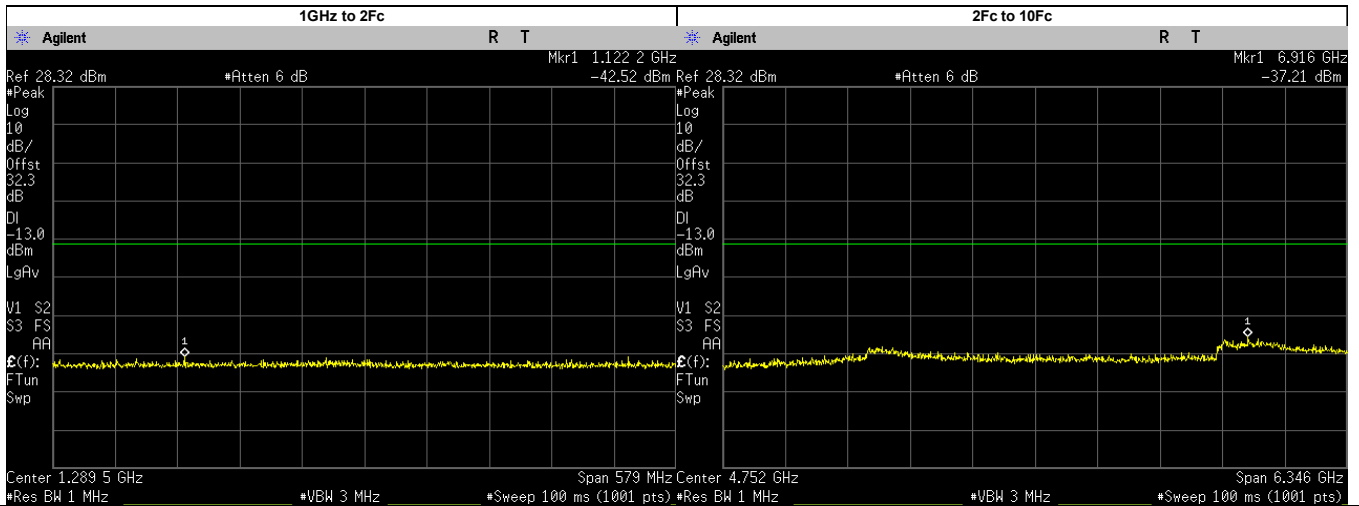
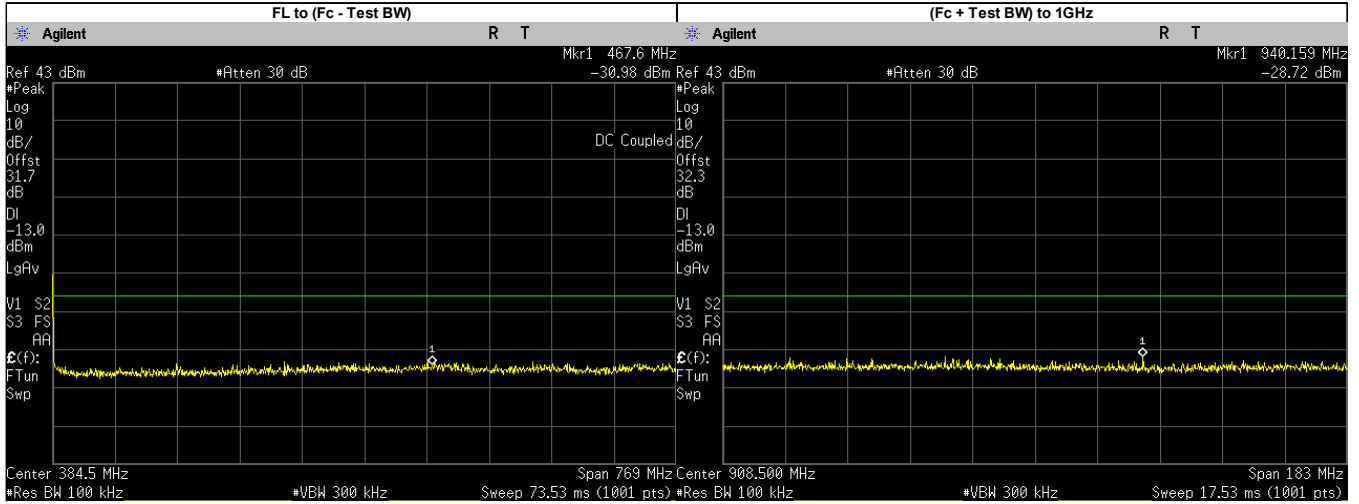

Frequency Range	Highest Spur Frequency (MHz)	Spurious Level (dBm)	Failing Limit (dBm)	Results
FL to (Fc - Test BW)	467.6000	-30.9750	-13.00	PASS
(Fc + Test BW) to 1GHz	940.1590	-28.7200	-13.00	PASS
1GHz to 2Fc	1122.1740	-42.5200	-13.00	PASS
2Fc to 10Fc	6916.0950	-37.2100	-13.00	PASS
	1584.0250	-44.9310	-13.00	PASS
	2376.0370	-44.0241	-13.00	PASS
	3168.0500	-40.6275	-13.00	PASS
	3960.0620	-42.5331	-13.00	PASS
	4752.0750	-43.2350	-13.00	PASS
	5544.0870	-42.7736	-13.00	PASS
	6336.1000	-42.9006	-13.00	PASS
7128.1130	-39.2522	-13.00	PASS	
7920.1250	-41.4119	-13.00	PASS	

Phase II.: 799.0875. MHz, 12.5 kHz Channel Spacing, Max. Power

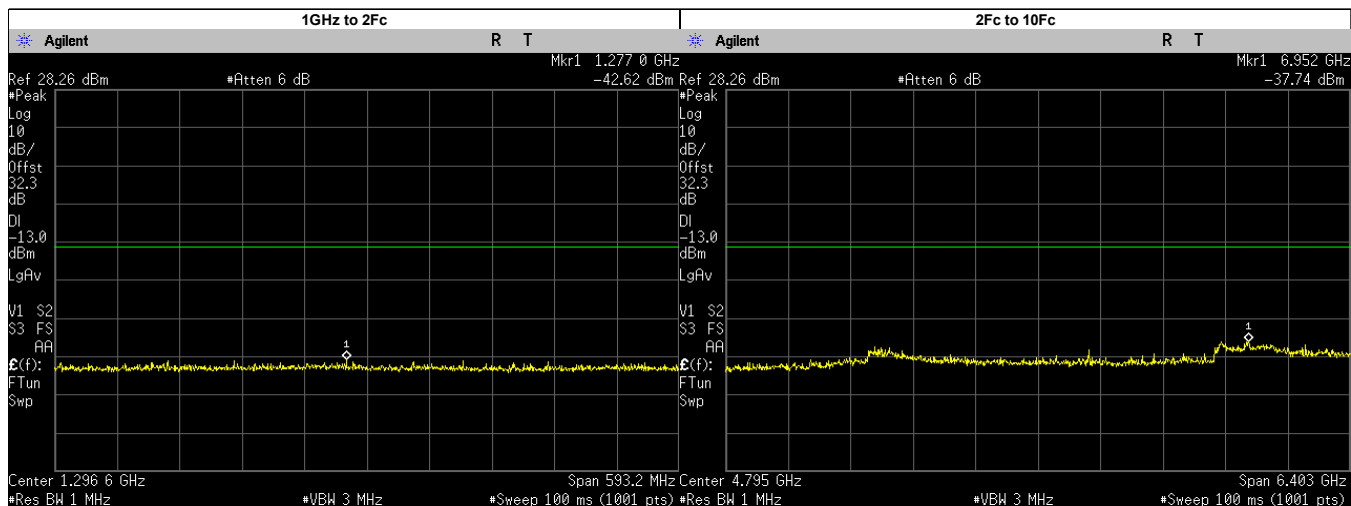
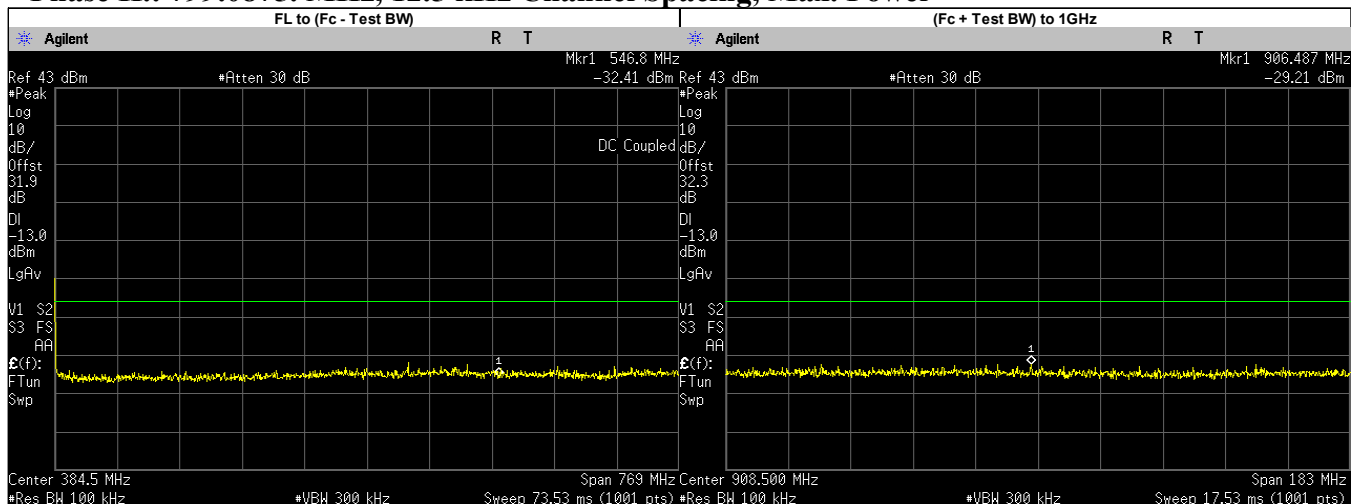

Frequency Range	Highest Spur Frequency (MHz)	Spurious Level (dBm)	Failing Limit (dBm)	Results
FL to (Fc - Test BW)	546.8000	-32.4070	-13.00	PASS
(Fc + Test BW) to 1GHz	906.4870	-29.2100	-13.00	PASS
1GHz to 2Fc	1277.0130	-42.6200	-13.00	PASS
2Fc to 10Fc	6952.2350	-37.7400	-13.00	PASS
	1598.1750	-44.6535	-13.00	PASS
	2397.2620	-44.8935	-13.00	PASS
	3196.3500	-40.6319	-13.00	PASS
	3995.4370	-42.8854	-13.00	PASS
	4794.5250	-43.5110	-13.00	PASS
	5593.6130	-44.0161	-13.00	PASS
	6392.7000	-42.9866	-13.00	PASS
	7191.7880	-38.9810	-13.00	PASS
7990.8750	-41.0188	-13.00	PASS	

Phase II.: 804.9125. MHz, 12.5 kHz Channel Spacing, Max. Power

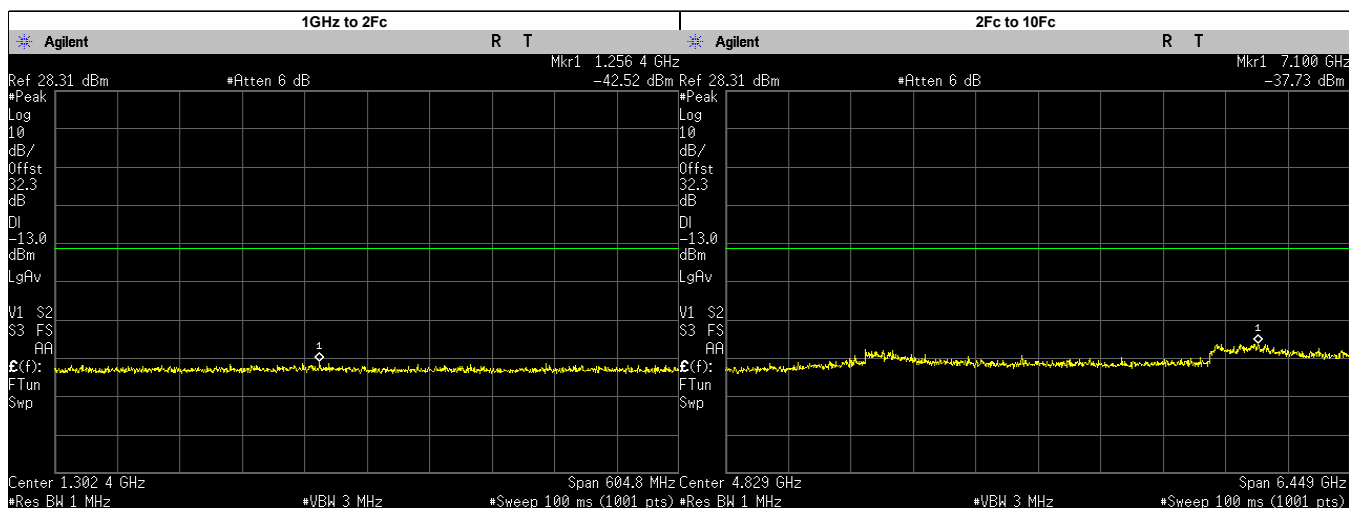
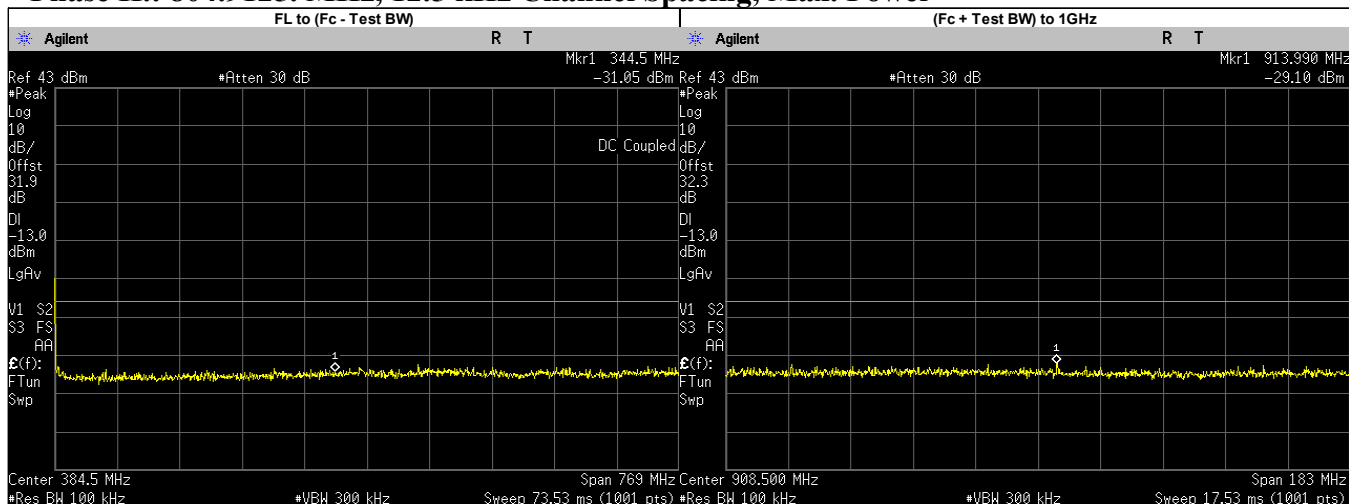

Frequency Range	Highest Spur Frequency (MHz)	Spurious Level (dBm)	Failing Limit (dBm)	Results
FL to (Fc - Test BW)	344.5000	-31.0460	-13.00	PASS
(Fc + Test BW) to 1GHz	913.9900	-29.1000	-13.00	PASS
1GHz to 2Fc	1256.4460	-42.5200	-13.00	PASS
2Fc to 10Fc	7099.6290	-37.7300	-13.00	PASS
	1609.8250	-44.2373	-13.00	PASS
	2414.7380	-44.2429	-13.00	PASS
	3219.6500	-40.6095	-13.00	PASS
	4024.5620	-43.1779	-13.00	PASS
	4829.4750	-43.3060	-13.00	PASS
	5634.3870	-43.8167	-13.00	PASS
	6439.3000	-42.8717	-13.00	PASS
7244.2120	-39.5163	-13.00	PASS	
8049.1250	-40.7345	-13.00	PASS	

6.9.4. Test Limit

Table below summarized the power of any emission outside a licensee's frequency block shall be attenuated below the transmitter power (P) by at least

Channel Spacing	Part 22	Part 24D	Part 74	Part 80	Part 90 (UHF, VHF, 800, 900)	Part 90 (700)
12.5kHz	43 + log ₁₀ (P) (-13 dBm)	43 + log ₁₀ (P) (-13 dBm)	43 + log ₁₀ (P) (-13 dBm)	Not Applicable	50 + log ₁₀ (P) (-20 dBm)	43 + log ₁₀ (P) (-13 dBm)
25kHz		Not Applicable		43 + log ₁₀ (P) (-13 dBm)	43 + log ₁₀ (P) (-13 dBm)	43 + log ₁₀ (P) (-13 dBm)

Channel Spacing	RSS 134	RSS 182	RSS 119 (UHF, VHF, 800, 900)	RSS 119 (700)
12.5kHz	43 + log ₁₀ (P) (-13 dBm)	Not Applicable	50 + log ₁₀ (P) (-20 dBm)	43 + log ₁₀ (P) (-13 dBm)
25kHz	Not Applicable	43 + log ₁₀ (P) (-13 dBm)	43 + log ₁₀ (P) (-13 dBm)	43 + log ₁₀ (P) (-13 dBm)

6.10. Radiated Spurious Emission

6.10.1. Test Setup

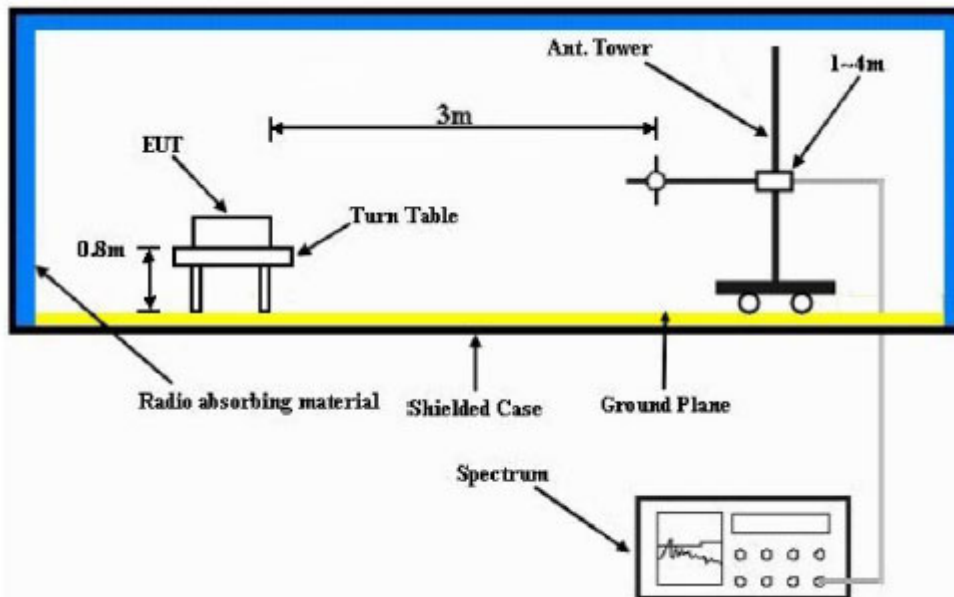

- 1) The Resolution Bandwidth for scanning Radiated Emission below 1 GHz is 100 kHz with Video Bandwidth = 300 kHz and Resolution Bandwidth for above 1 GHz is 1 MHz with Video Bandwidth = 3 MHz. Detector mode is positive peak.
- 2) In the semi- anechoic chamber, setup as illustrated above the DUT placed on the 0.8m height (for $F_c < 1\text{GHz}$) or 1.5m height (for $F_c > 1\text{GHz}$) of Turn Table, rotated the table around 360 degrees to search the maximum radiation power and receiver antenna shall be rotated vertical and horizontal polarization and moved height from 1m to 4m to find the maximum polar radiated power. The “Read Value” is the spectrum reading the maximum power value.
- 3) The substitution antenna is substituted for DUT at the same position and signals generator (S.G) export the CW signal to the substitution antenna via a TX cable. The receiver antenna shall be rotated vertical and horizontal polarization and moved height from 1m to 4m to find the maximum radiation power. Record the power level of maximum radiation power from spectrum. So, the measured substitution value = Ref level of S.G + TX cables loss – Substituted Antenna Gain.
- 4) Final Radiated Spurious Emission = “Read Value” + Measured substitution value.

6.10.2. Test Result (Analog)

SAC Transmitter Radiated Emission:

Model Number: H35UCT9PW8AN

S/N: 022TYP0037

SR:26977-EMC-00102

Battery Part No: PMMN4817A

Accy Part No: NA

Test Mode: TX Analog

762.012500 MHz (Not for FCC review)

12.5 kHz

2.990 Watt(s) /Max Power

Frequency (MHz)	Limit	Horizontal Measured Emission Equip Pwr Into Ideal Dipole (dBm)	Vertical Measured Emission Equip Pwr Into ideal Dipole (dBm)
1524.0250	-13.0000	-59.2562 **	-59.8232 **
2286.0375	-13.0000	-55.1491 **	-55.2755 **
3048.0500	-13.0000	-52.2809 **	-50.8122 **
3810.0625	-13.0000	-50.6734 **	-50.5189 **
4572.0750	-13.0000	-49.6745 **	-49.5781 **
5334.0875	-13.0000	-47.3982 **	-47.8326 **
6096.1000	-13.0000	-45.2181 **	-45.5658 **
6858.1125	-13.0000	-43.9145 **	-45.2598 **
7620.1250	-13.0000	-42.3637 **	-42.7108 **

RADIATED SPURIOUS EMISSIONS

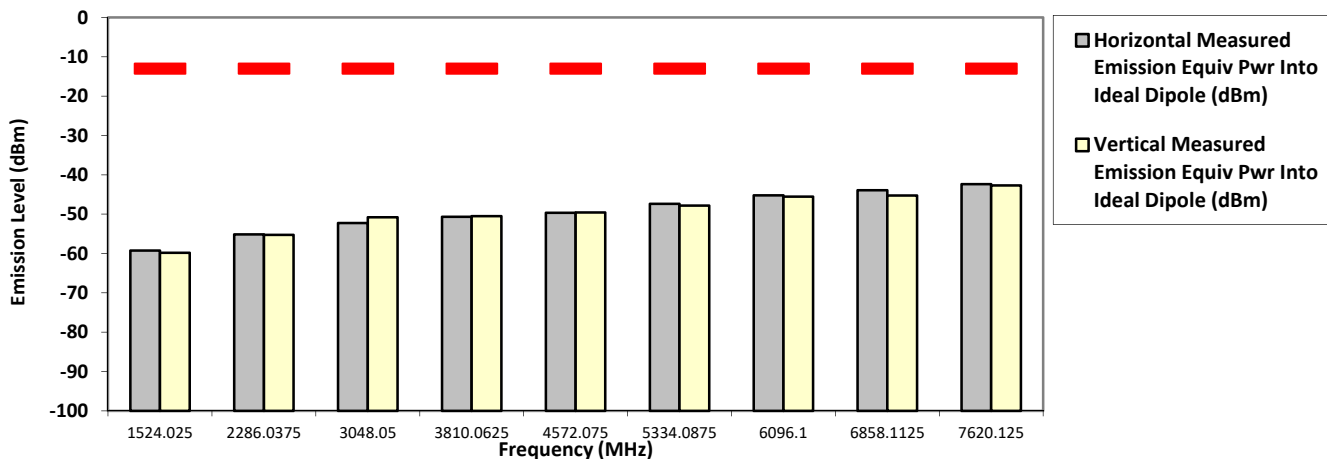

The data presented here was taken using the substitution method as found in the ANSI C63.26-2015 document.

Motorola Penang EMC Lab - Test Performed by: Qawiman&Nazrin

Thu, 4 Aug, 2022

Remarks: ** Indicates the spurious emission could not be detected due to noise limitations or ambient.

*Pursuant to CFR 47 Part 2.1057 (c), emissions attenuated more than 20 dB below the permissible limit are not reported

Temp(Deg): 23.4 Hum(%RH): 69.6

Remarks:

Passed Results	Marginal Results	Failed Results
----------------	------------------	----------------

SAC Transmitter Radiated Emission:

Model Number: H35UCT9PW8AN **S/N: 022TYP0037** **SR:26977-EMC-00102**
Battery Part No: PMMN4817A **Test Mode: TX Analog** **Accy Part No: NA**
769.012500 MHz (Itinerant) **12.5 kHz** **2.0 Watt(s) /Max Power**

Frequency (MHz)	Limit	Horizontal Measured Emission Equiv Pwr Into Ideal Dipole (dBm)	Vertical Measured Emission Equiv Pwr Into ideal Dipole (dBm)
1538.0250	-13.0000	-60.7027 **	-58.7076 **
2307.0375	-13.0000	-55.9990 **	-55.3997 **
3076.0500	-13.0000	-52.0703 **	-51.9663 **
3845.0625	-13.0000	-50.2781 **	-50.8169 **
4614.0750	-13.0000	-49.5386 **	-48.2689 **
5383.0875	-13.0000	-48.8793 **	-48.8897 **
6152.1000	-13.0000	-45.9892 **	-45.8464 **
6921.1125	-13.0000	-44.5755 **	-43.6548 **
7690.1250	-13.0000	-43.8693 **	-43.5928 **

RADIATED SPURIOUS EMISSIONS

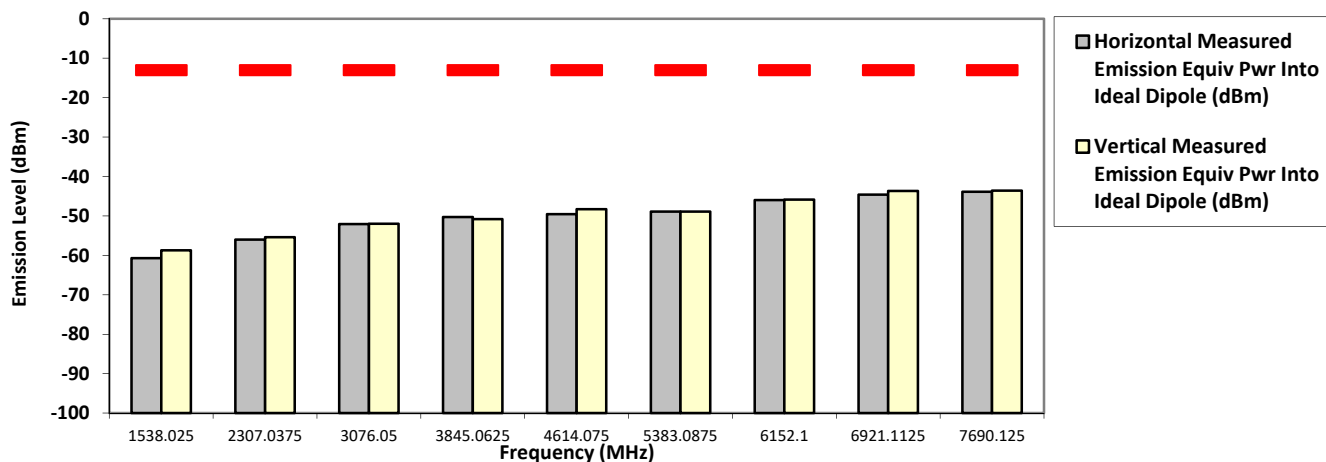

The data presented here was taken using the substitution method as found in the ANSI C63.26-2015 document.
 Motorola Penang EMC Lab - Test Performed by: Qawiman&Nazrin Thu, 4 Aug, 2022

Remarks: ** Indicates the spurious emission could not be detected due to noise limitations or ambient.
 *Pursuant to CFR 47 Part 2.1057 (c), emissions attenuated more than 20 dB below the permissible limit are not reported
 Temp(Deg): 23.4 Hum(%RH): 69.6

Remarks: Passed Results Marginal Results Failed Results

SAC Transmitter Radiated Emission:

Model Number: H35UCT9PW8AN

S/N: 022TYP0037

SR:26977-EMC-00102

Battery Part No: PMMN4817A

Accy Part No: NA

Test Mode: TX Analog

769.087500 MHz

12.5 kHz

2.990 Watt(s) /Max Power

Frequency (MHz)	Limit	Horizontal Measured Emission Equiv Pwr Into Ideal Dipole (dBm)	Vertical Measured Emission Equiv Pwr Into ideal Dipole (dBm)
1538.1750	-13.0000	-59.1606 **	-60.3693 **
2307.2625	-13.0000	-55.5558 **	-56.3467 **
3076.3500	-13.0000	-52.7950 **	-52.1332 **
3845.4375	-13.0000	-51.0667 **	-50.1685 **
4614.5250	-13.0000	-49.0035 **	-47.9386 **
5383.6125	-13.0000	-47.7575 **	-48.4397 **
6152.7000	-13.0000	-46.5182 **	-46.6156 **
6921.7875	-13.0000	-43.9281 **	-44.1822 **
7690.8750	-13.0000	-41.9536 **	-42.2217 **

RADIATED SPURIOUS EMISSIONS

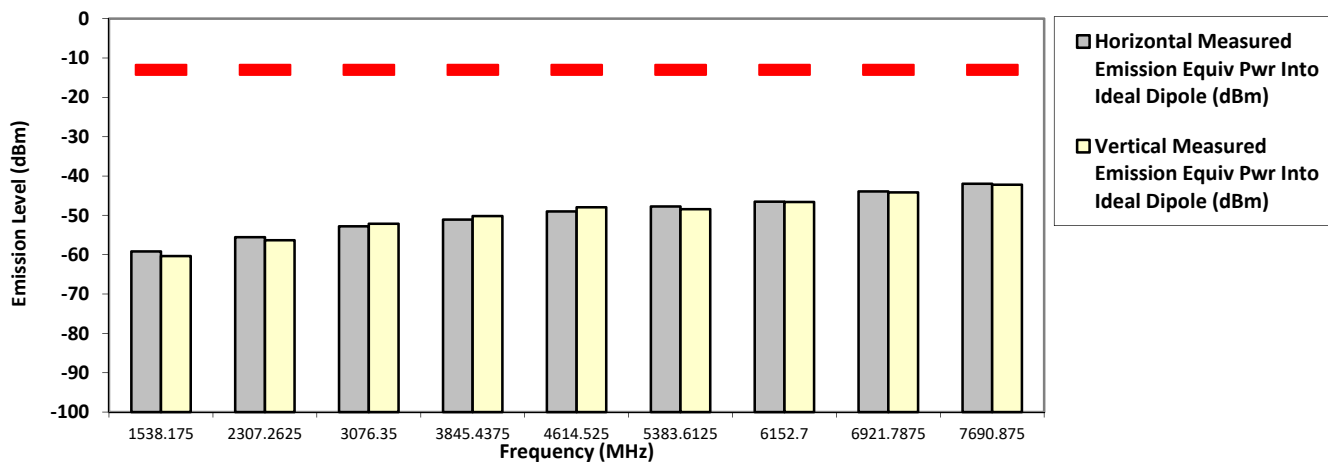

The data presented here was taken using the substitution method as found in the ANSI C63.26-2015 document.
 Motorola Penang EMC Lab - Test Performed by: Qawiman&Nazrin Thu, 4 Aug, 2022

Remarks: ** Indicates the spurious emission could not be detected due to noise limitations or ambient.
 *Pursuant to CFR 47 Part 2.1057 (c), emissions attenuated more than 20 dB below the permissible limit are not reported
 Temp(Deg): 23.4 Hum(%RH): 69.6

Remarks:

Passed Results	Marginal Results	Failed Results
----------------	------------------	----------------

SAC Transmitter Radiated Emission:

Model Number: H35UCT9PW8AN

S/N: 022TYP0037

SR:26977-EMC-00102

Battery Part No: PMMN4817A

Accy Part No: NA

Test Mode: TX Analog

774.887500 MHz

12.5 kHz

2.990 Watt(s) /Max Power

Frequency (MHz)	Limit	Horizontal Measured Emission Equip Pwr Into Ideal Dipole (dBm)	Vertical Measured Emission Equip Pwr Into ideal Dipole (dBm)
1549.7750	-13.0000	-59.5532 **	-60.2497 **
2324.6625	-13.0000	-56.1514 **	-55.2599 **
3099.5500	-13.0000	-51.3832 **	-51.5361 **
3874.4375	-13.0000	-50.3674 **	-49.5727 **
4649.3250	-13.0000	-49.0112 **	-48.8346 **
5424.2125	-13.0000	-46.9990 **	-46.9639 **
6199.1000	-13.0000	-45.2533 **	-47.0476 **
6973.9875	-13.0000	-44.1103 **	-44.7041 **
7748.8750	-13.0000	-42.9977 **	-43.1744 **

RADIATED SPURIOUS EMISSIONS

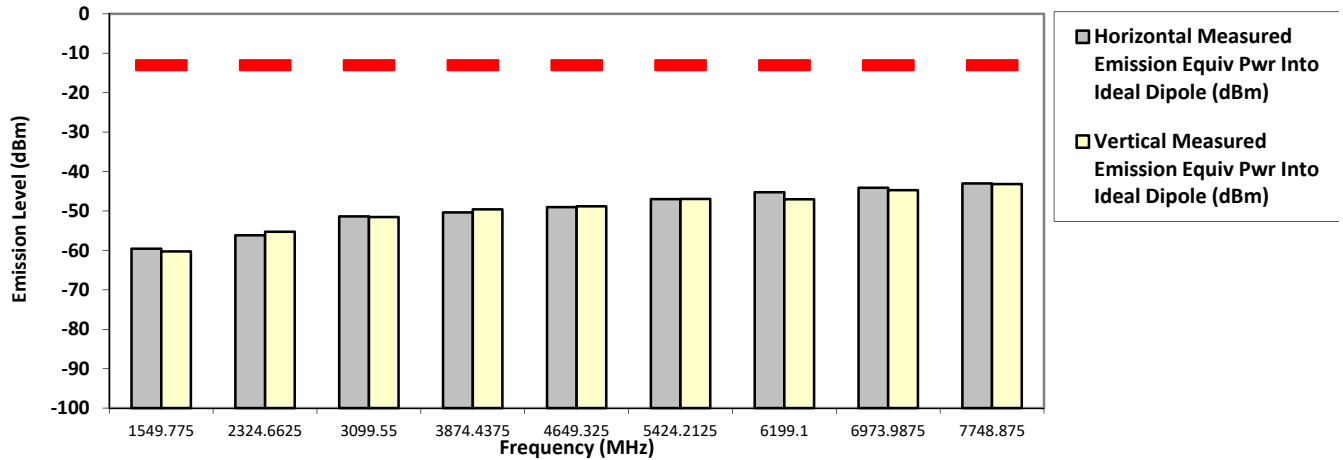

The data presented here was taken using the substitution method as found in the ANSI C63.26-2015 document.

Motorola Penang EMC Lab - Test Performed by: Qawiman&Nazrin

Thu, 4 Aug, 2022

Remarks: ** Indicates the spurious emission could not be detected due to noise limitations or ambient.

*Pursuant to CFR 47 Part 2.1057 (c), emissions attenuated more than 20 dB below the permissible limit are not reported
 Temp(Deg): 23.4 Hum(%RH): 69.6

Remarks:

Passed Results	Marginal Results	Failed Results
----------------	------------------	----------------

SAC Transmitter Radiated Emission:

Model Number: H35UCT9PW8AN S/N: 022TYP0004 SR:26977-EMC-00102
 Battery Part No: PMMN4817A Accy Part No: NA
 Test Mode: TX Analog
 792.012500 MHz (Not for FCC review) 12.5 kHz 2.990 Watt(s) /Max Power

Frequency (MHz)	Limit	Horizontal Measured Emission Equiv Pwr Into Ideal Dipole (dBm)	Vertical Measured Emission Equiv Pwr Into ideal Dipole (dBm)
1584.0250	-13.0000	-59.8014 **	-59.0474 **
2376.0375	-13.0000	-55.2188 **	-55.6390 **
3168.0500	-13.0000	-49.4680 **	-51.2228 **
3960.0625	-13.0000	-49.7079 **	-50.2325 **
4752.0750	-13.0000	-48.7341 **	-47.9751 **
5544.0875	-13.0000	-47.1550 **	-46.5142 **
6336.1000	-13.0000	-46.5982 **	-45.0137 **
7128.1125	-13.0000	-43.5998 **	-43.1638 **
7920.1250	-13.0000	-42.4153 **	-42.7765 **

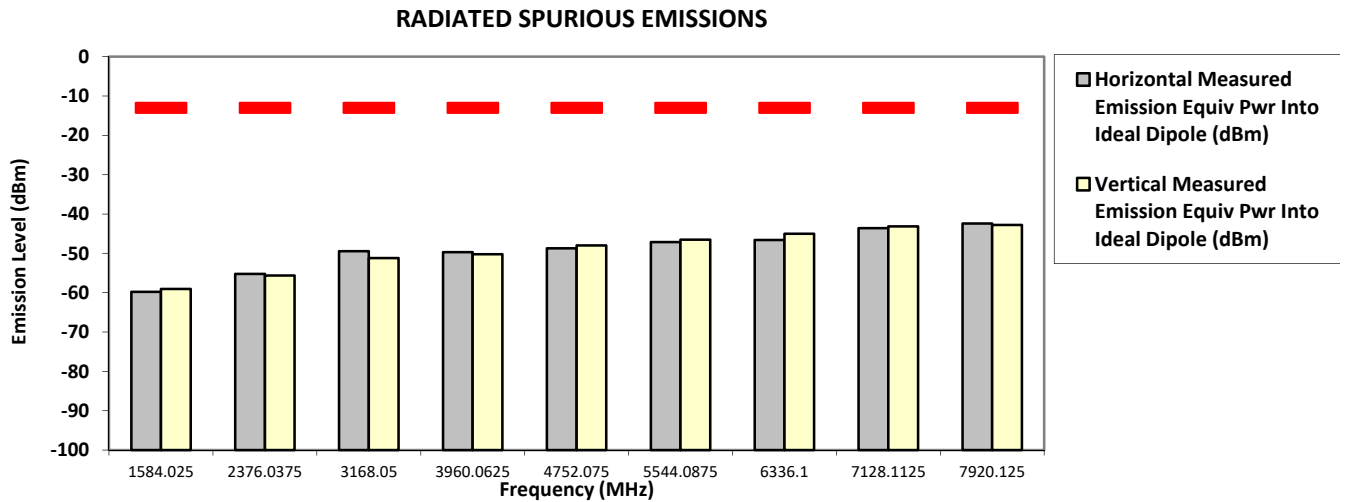

The data presented here was taken using the substitution method as found in the ANSI C63.26-2015 document.
 Motorola Penang EMC Lab - Test Performed by: Qawiman&Nazrin Thu, 4 Aug, 2022

Remarks: ** Indicates the spurious emission could not be detected due to noise limitations or ambient.
 *Pursuant to CFR 47 Part 2.1057 (c), emissions attenuated more than 20 dB below the permissible limit are not reported
 Temp(Deg): 23.4 Hum(%RH): 69.6

Remarks: Passed Results Marginal Results Failed Results

SAC Transmitter Radiated Emission:

Model Number: H35UCT9PW8AN

S/N: 022TYP0004

SR:26977-EMC-00102

Battery Part No: PMMN4817A

Accy Part No: NA

Test Mode: TX Analog

799.087500 MHz

12.5 kHz

2.990 Watt(s) /Max Power

Frequency (MHz)	Limit	Horizontal Measured Emission Equip Pwr Into Ideal Dipole (dBm)	Vertical Measured Emission Equip Pwr Into ideal Dipole (dBm)
1598.1750	-13.0000	-59.3577 **	-59.6054 **
2397.2625	-13.0000	-54.7798 **	-54.9619 **
3196.3500	-13.0000	-51.6721 **	-51.3450 **
3995.4375	-13.0000	-50.1604 **	-51.4852 **
4794.5250	-13.0000	-48.0696 **	-46.9819 **
5593.6125	-13.0000	-47.3233 **	-48.1074 **
6392.7000	-13.0000	-44.9023 **	-45.7194 **
7191.7875	-13.0000	-42.9302 **	-43.6400 **
7990.8750	-13.0000	-42.2515 **	-41.1183 **

RADIATED SPURIOUS EMISSIONS

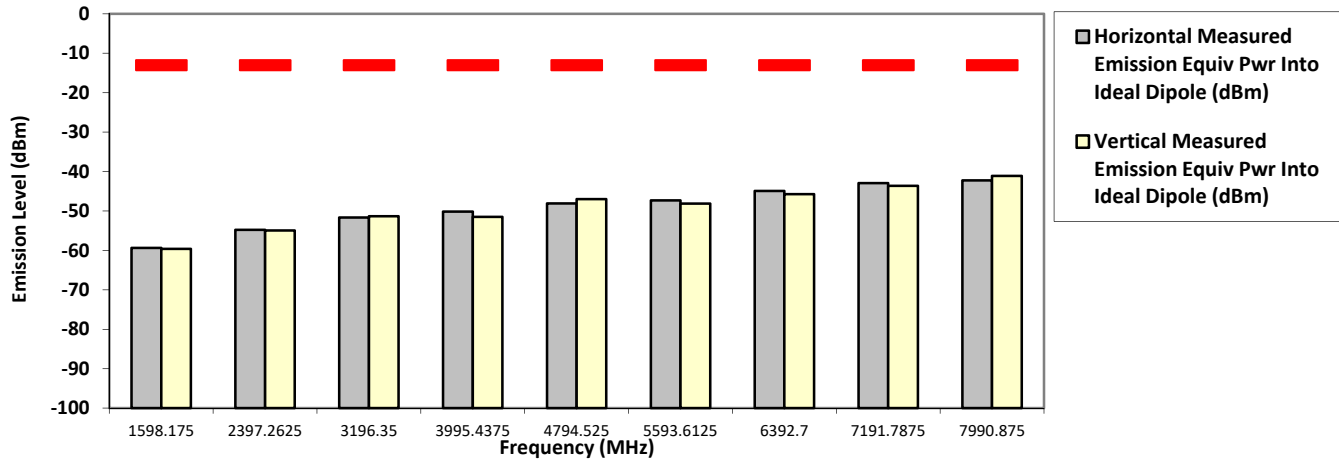

The data presented here was taken using the substitution method as found in the ANSI C63.26-2015 document.
 Motorola Penang EMC Lab - Test Performed by: Qawiman&Nazrin Thu, 4 Aug, 2022

SAC Transmitter Radiated Emission:

Model Number: H35UCT9PW8AN

S/N: 022TYP0037

SR:26977-EMC-00102

Battery Part No: PMMN4817A

Accy Part No: NA

Test Mode: TX Analog

804.912500 MHz

12.5 kHz

2.990 Watt(s) /Max Power

Frequency (MHz)	Limit	Horizontal Measured Emission Equiv Pwr Into Ideal Dipole (dBm)	Vertical Measured Emission Equiv Pwr Into ideal Dipole (dBm)
1609.8250	-13.0000	-58.4347 **	-59.2280 **
2414.7375	-13.0000	-54.4835 **	-53.3783 **
3219.6500	-13.0000	-50.6329 **	-50.7565 **
4024.5625	-13.0000	-49.8010 **	-49.8042 **
4829.4750	-13.0000	-48.6878 **	-48.6408 **
5634.3875	-13.0000	-46.8414 **	-47.8437 **
6439.3000	-13.0000	-45.1434 **	-45.6884 **
7244.2125	-13.0000	-42.5123 **	-43.6692 **
8049.1250	-13.0000	-41.8146 **	-40.5752 **

RADIATED SPURIOUS EMISSIONS

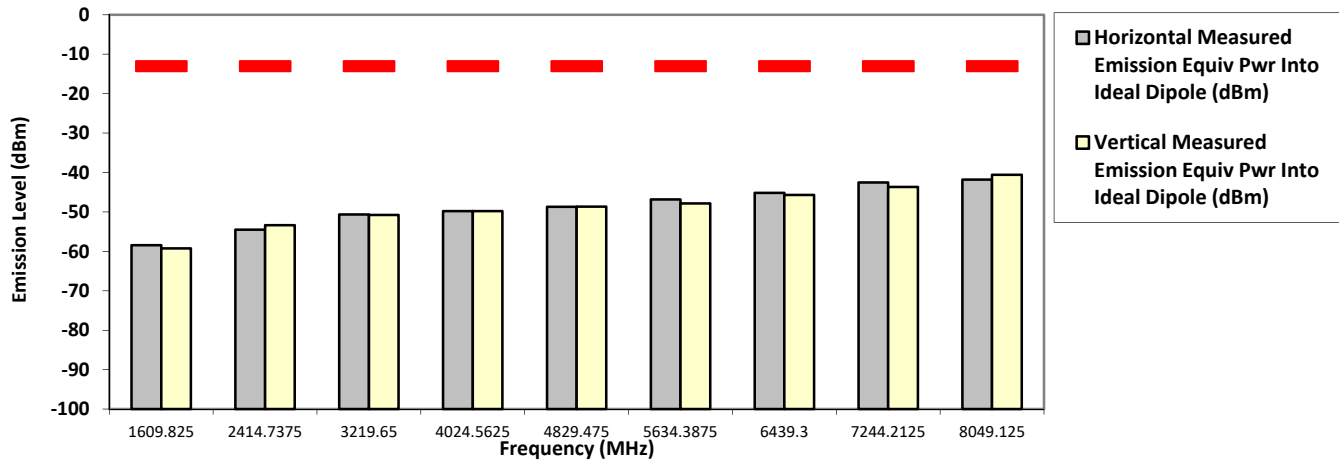

The data presented here was taken using the substitution method as found in the ANSI C63.26-2015 document.
 Motorola Penang EMC Lab - Test Performed by: Qawiman&Nazrin Thu, 4 Aug, 2022

Remarks: ** Indicates the spurious emission could not be detected due to noise limitations or ambient.

*Pursuant to CFR 47 Part 2.1057 (c), emissions attenuated more than 20 dB below the permissible limit are not reported
 Temp(Deg): 23.4 Hum(%RH): 69.6

Remarks: Passed Results Marginal Results Failed Results

6.10.3. Test Result (Digital)

SAC Transmitter Radiated Emission:

Model Number: H35UCT9PW8AN S/N: 022TYP0037 SR:26977-EMC-00102
 Battery Part No: PMMN4817A Accy Part No: NA
 Test Mode: TX APCO Digital C4FM
 762.012500 MHz (Not for FCC review) 12.5 kHz 2.990 Watt(s) /Max Power

Frequency (MHz)	Limit	Horizontal Measured Emission Equiv Pwr Into Ideal Dipole (dBm)	Vertical Measured Emission Equiv Pwr Into ideal Dipole (dBm)
1524.0250	-13.0000	-59.4142 **	-59.4278 **
2286.0375	-13.0000	-55.5825 **	-54.8692 **
3048.0500	-13.0000	-52.0484 **	-52.4770 **
3810.0625	-13.0000	-49.6612 **	-51.2483 **
4572.0750	-13.0000	-49.1791 **	-48.6714 **
5334.0875	-13.0000	-48.4039 **	-47.2136 **
6096.1000	-13.0000	-46.2916 **	-46.4254 **
6858.1125	-13.0000	-44.2391 **	-44.4865 **
7620.1250	-13.0000	-43.0659 **	-42.6870 **

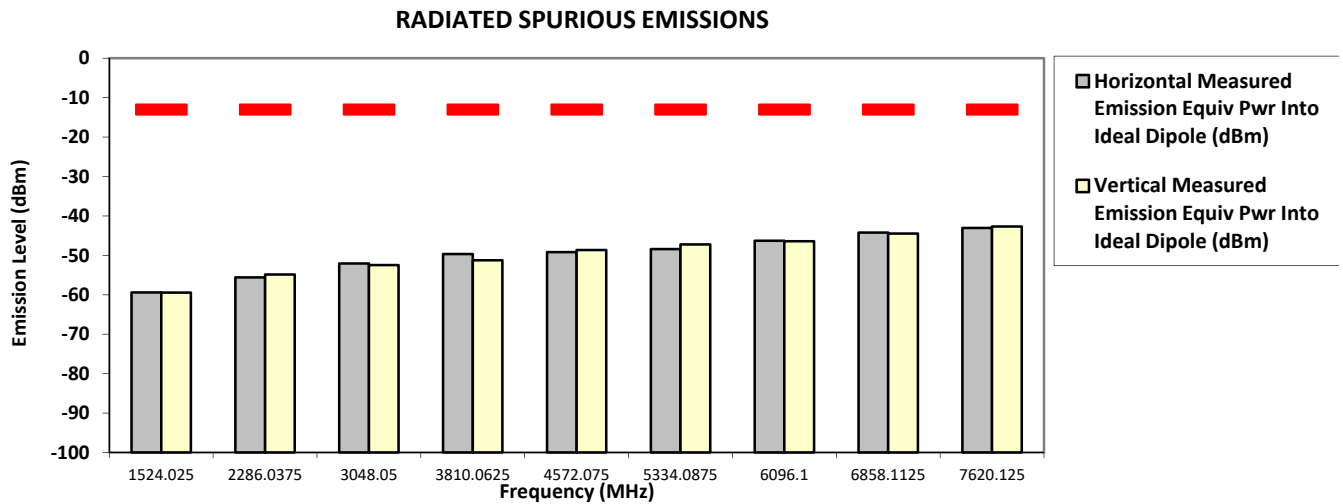

The data presented here was taken using the substitution method as found in the ANSI C63.26-2015 document.
 Motorola Penang EMC Lab - Test Performed by: Qawiman&Nazrin Thu, 4 Aug, 2022

Remarks: ** Indicates the spurious emission could not be detected due to noise limitations or ambient.
 *Pursuant to CFR 47 Part 2.1057 (c), emissions attenuated more than 20 dB below the permissible limit are not reported
 Temp(Deg): 23.4 Hum(%RH): 69.6

Remarks: Passed Results Marginal Results Failed Results

SAC Transmitter Radiated Emission:

Model Number: H35UCT9PW8AN **S/N: 022TYP0037** **SR:26977-EMC-00102**
Battery Part No: PMMN4817A **Accy Part No: NA**
Test Mode: TX APCO Digital C4FM
769.012500 MHz (Itinerant) **12.5 kHz** **2.0 Watt(s) /Max Power**

Frequency (MHz)	Limit	Horizontal Measured Emission Equiv Pwr Into Ideal Dipole (dBm)	Vertical Measured Emission Equiv Pwr Into ideal Dipole (dBm)
1538.0250	-13.0000	-59.9500 **	-59.5431 **
2307.0375	-13.0000	-55.2112 **	-55.5073 **
3076.0500	-13.0000	-51.4149 **	-52.0700 **
3845.0625	-13.0000	-50.9612 **	-50.7893 **
4614.0750	-13.0000	-48.7739 **	-47.8631 **
5383.0875	-13.0000	-47.7492 **	-47.4205 **
6152.1000	-13.0000	-46.1914 **	-46.5521 **
6921.1125	-13.0000	-44.1674 **	-45.0387 **
7690.1250	-13.0000	-42.5906 **	-41.1638 **

RADIATED SPURIOUS EMISSIONS

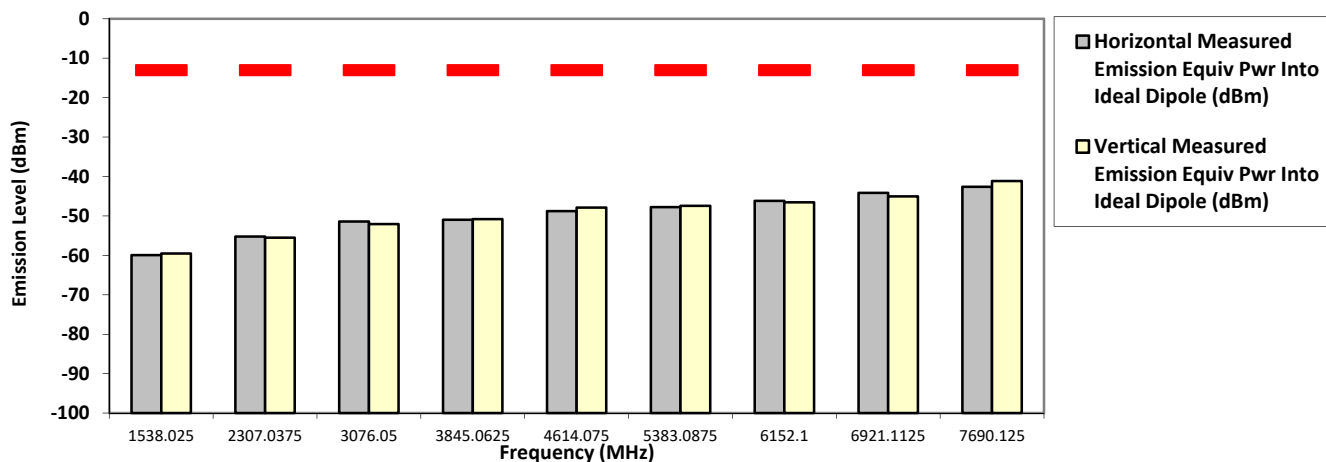

The data presented here was taken using the substitution method as found in the ANSI C63.26-2015 document.
 Motorola Penang EMC Lab - Test Performed by: Qawiman&Nazrin Thu, 4 Aug, 2022

Remarks: ** Indicates the spurious emission could not be detected due to noise limitations or ambient.
 *Pursuant to CFR 47 Part 2.1057 (c), emissions attenuated more than 20 dB below the permissible limit are not reported
 Temp(Deg): 23.4 Hum(%RH): 69.6

Remarks: Passed Results Marginal Results Failed Results

SAC Transmitter Radiated Emission:

Model Number: H35UCT9PW8AN

S/N: 022TYP0037

SR:26977-EMC-00102

Battery Part No: PMMN4817A

Accy Part No: NA

Test Mode: TX APCO Digital C4FM

769.087500 MHz

12.5 kHz

2.990 Watt(s) /Max Power

Frequency (MHz)	Limit	Horizontal Measured Emission Equip Pwr Into Ideal Dipole (dBm)	Vertical Measured Emission Equip Pwr Into ideal Dipole (dBm)
1538.1750	-13.0000	-61.9802 **	-59.0636 **
2307.2625	-13.0000	-57.7872 **	-56.3720 **
3076.3500	-13.0000	-53.5236 **	-52.5797 **
3845.4375	-13.0000	-53.5978 **	-51.3784 **
4614.5250	-13.0000	-50.3331 **	-48.9744 **
5383.6125	-13.0000	-48.8058 **	-48.3710 **
6152.7000	-13.0000	-47.3144 **	-44.4506 **
6921.7875	-13.0000	-45.9787 **	-43.9101 **
7690.8750	-13.0000	-44.3369 **	-42.1731 **

RADIATED SPURIOUS EMISSIONS

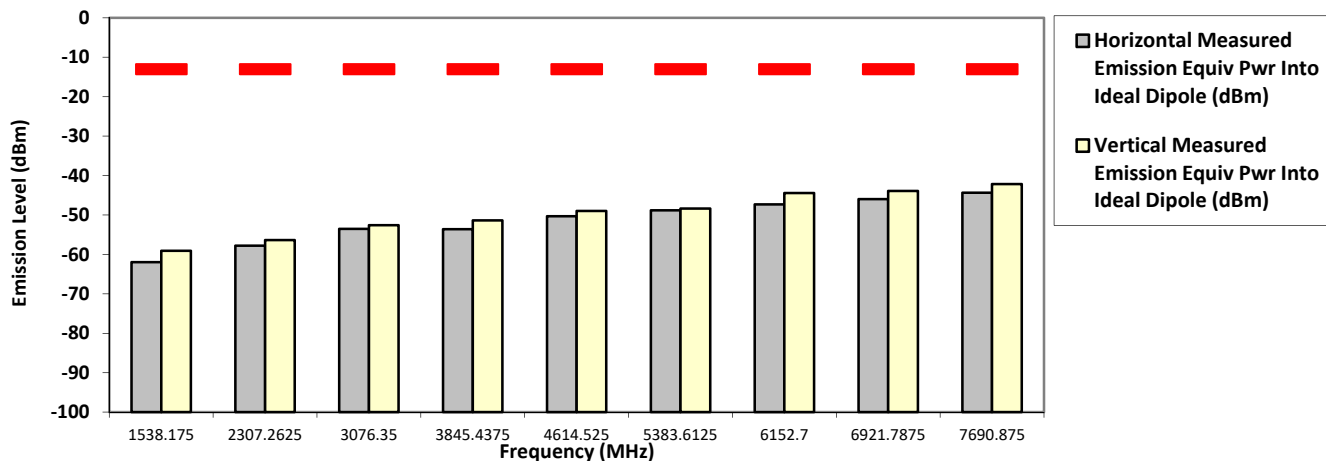

The data presented here was taken using the substitution method as found in the ANSI C63.26-2015 document.
 Motorola Penang EMC Lab - Test Performed by: Qawiman&Nazrin Thu, 4 Aug, 2022

Remarks: ** Indicates the spurious emission could not be detected due to noise limitations or ambient.

*Pursuant to CFR 47 Part 2.1057 (c), emissions attenuated more than 20 dB below the permissible limit are not reported
 Temp(Deg): 23.4 Hum(%RH): 69.6

Remarks:

Passed Results	Marginal Results	Failed Results
----------------	------------------	----------------

SAC Transmitter Radiated Emission:

Model Number: H35UCT9PW8AN **S/N: 022TYP0037** **SR:26977-EMC-00102**
Battery Part No: PMMN4817A **Accy Part No: NA**
Test Mode: TX APCO Digital C4FM
774.887500 MHz **12.5 kHz** **2.990 Watt(s) /Max Power**

Frequency (MHz)	Limit	Horizontal Measured Emission Equiv Pwr Into Ideal Dipole (dBm)	Vertical Measured Emission Equiv Pwr Into ideal Dipole (dBm)
1549.7750	-13.0000	-60.4606 **	-59.8729 **
2324.6625	-13.0000	-55.3516 **	-55.7443 **
3099.5500	-13.0000	-52.2282 **	-52.0945 **
3874.4375	-13.0000	-50.5954 **	-50.4073 **
4649.3250	-13.0000	-47.4427 **	-48.9939 **
5424.2125	-13.0000	-48.4239 **	-47.8228 **
6199.1000	-13.0000	-46.4323 **	-46.2398 **
6973.9875	-13.0000	-43.7389 **	-43.5848 **
7748.8750	-13.0000	-43.0588 **	-43.4365 **

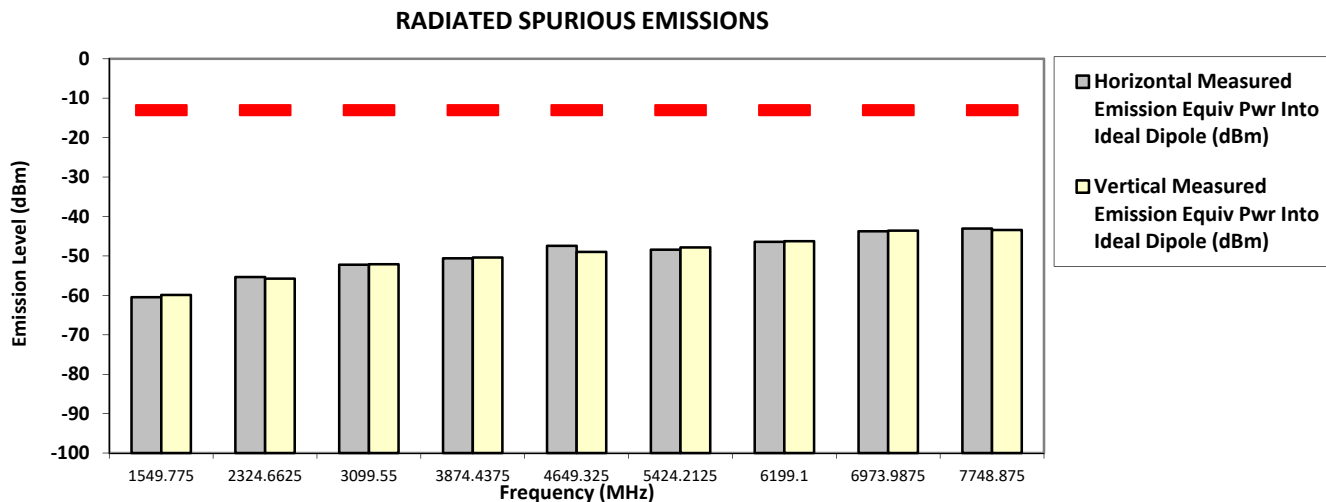

The data presented here was taken using the substitution method as found in the ANSI C63.26-2015 document.
 Motorola Penang EMC Lab - Test Performed by: Qawiman&Nazrin Thu, 4 Aug, 2022

Remarks: ** Indicates the spurious emission could not be detected due to noise limitations or ambient.
 *Pursuant to CFR 47 Part 2.1057 (c), emissions attenuated more than 20 dB below the permissible limit are not reported
 Temp(Deg): 23.4 Hum(%RH): 69.6

Remarks: Passed Results Marginal Results Failed Results

SAC Transmitter Radiated Emission:

Model Number: H35UCT9PW8AN-H S/N: 022TYP0037 SR:26977-EMC-00102
 Battery Part No: PMMN4817A Accy Part No: NA
 Test Mode: TX APCO Digital C4FM
 792.012500 MHz (Not for FCC review) 12.5 kHz 2.990 Watt(s) /Max Power

Frequency (MHz)	Limit	Horizontal Measured Emission Equip Pwr Into Ideal Dipole (dBm)	Vertical Measured Emission Equip Pwr Into ideal Dipole (dBm)
1584.0250	-13.0000	-59.8920 **	-59.3071 **
2376.0375	-13.0000	-54.1153 **	-54.9622 **
3168.0500	-13.0000	-50.6568 **	-51.2011 **
3960.0625	-13.0000	-50.0783 **	-49.8158 **
4752.0750	-13.0000	-48.2808 **	-48.4545 **
5544.0875	-13.0000	-47.4895 **	-46.9601 **
6336.1000	-13.0000	-45.3846 **	-45.4324 **
7128.1125	-13.0000	-43.6875 **	-44.2992 **
7920.1250	-13.0000	-42.8412 **	-42.6779 **

RADIATED SPURIOUS EMISSIONS

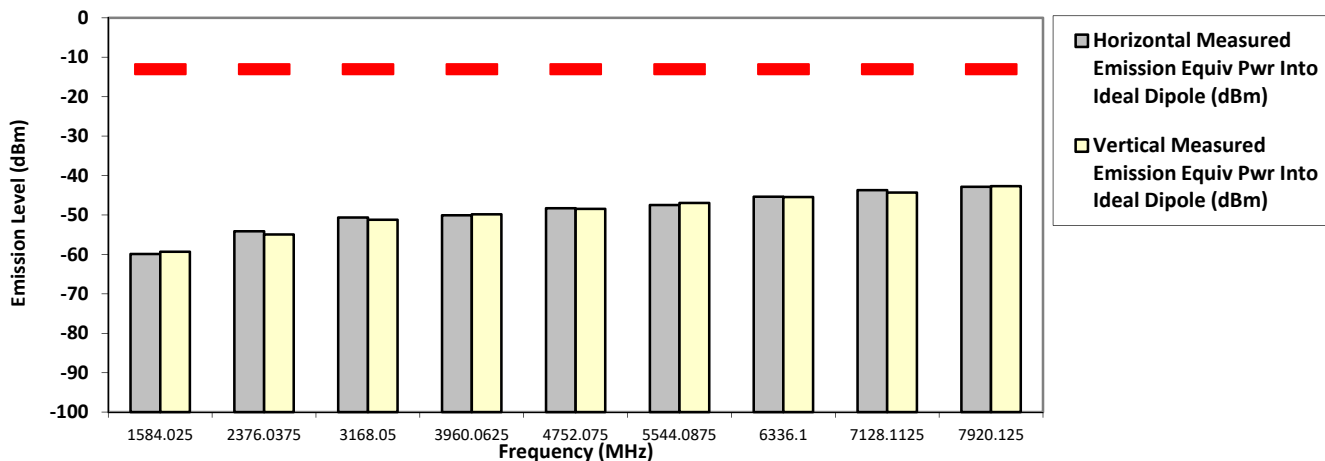

The data presented here was taken using the substitution method as found in the ANSI C63.26-2015 document.
 Motorola Penang EMC Lab - Test Performed by: Qawiman&Nazrin Thu, 4 Aug, 2022

Remarks: ** Indicates the spurious emission could not be detected due to noise limitations or ambient.
 *Pursuant to CFR 47 Part 2.1057 (c), emissions attenuated more than 20 dB below the permissible limit are not reported
 Temp(Deg): 23.4 Hum(%RH): 69.6

Remarks: Passed Results Marginal Results Failed Results

SAC Transmitter Radiated Emission:

Model Number: H35UCT9PW8AN **S/N: 022TYP0037** **SR:26977-EMC-00102**
Battery Part No: PMMN4817A **Accy Part No: NA**
Test Mode: TX APCO Digital C4FM
799.087500 MHz **12.5 kHz** **2.990 Watt(s) /Max Power**

Frequency (MHz)	Limit	Horizontal Measured Emission Equiv Pwr Into Ideal Dipole (dBm)	Vertical Measured Emission Equiv Pwr Into ideal Dipole (dBm)
1598.1750	-13.0000	-60.0634 **	-58.1967 **
2397.2625	-13.0000	-55.1711 **	-53.7770 **
3196.3500	-13.0000	-49.9064 **	-51.6082 **
3995.4375	-13.0000	-49.8227 **	-49.4645 **
4794.5250	-13.0000	-47.2768 **	-47.8026 **
5593.6125	-13.0000	-48.3333 **	-46.9201 **
6392.7000	-13.0000	-45.9453 **	-44.2088 **
7191.7875	-13.0000	-42.3314 **	-42.5328 **
7990.8750	-13.0000	-41.6373 **	-42.6911 **

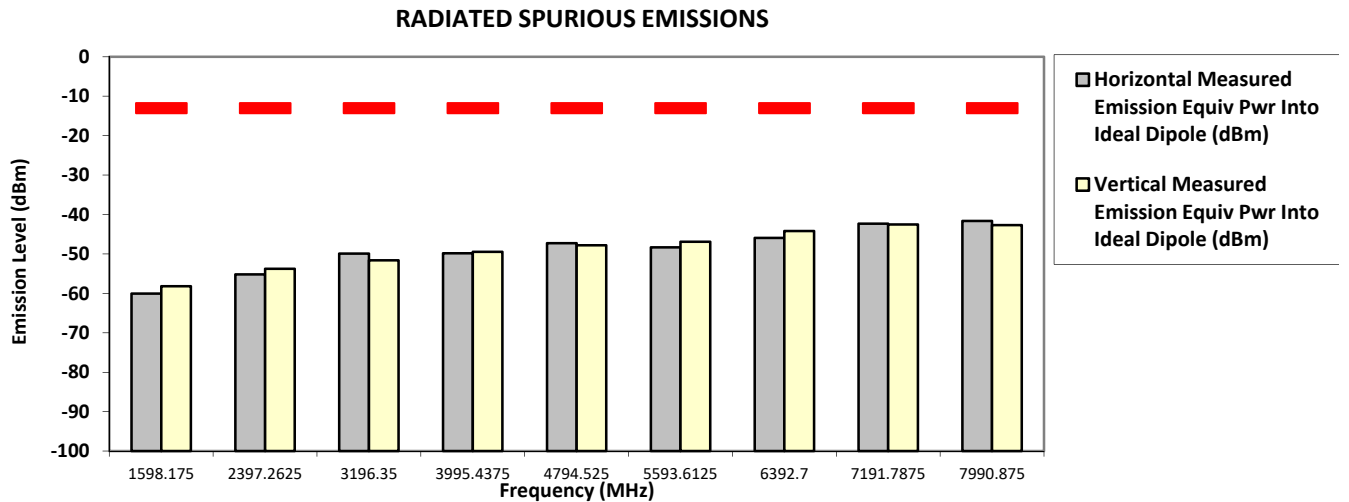

The data presented here was taken using the substitution method as found in the ANSI C63.26-2015 document.
 Motorola Penang EMC Lab - Test Performed by: Qawiman&Nazrin Thu, 4 Aug, 2022

Remarks: ** Indicates the spurious emission could not be detected due to noise limitations or ambient.
 *Pursuant to CFR 47 Part 2.1057 (c), emissions attenuated more than 20 dB below the permissible limit are not reported
 Temp(Deg): 23.4 Hum(%RH): 69.6

Remarks: Passed Results Marginal Results Failed Results

SAC Transmitter Radiated Emission:

Model Number: H35UCT9PW8AN **S/N: 022TYP0037** **SR:26977-EMC-00102**
Battery Part No: PMMN4817A **Accy Part No: NA**
Test Mode: TX APCO Digital C4FM
804.912500 MHz **12.5 kHz** **2.990 Watt(s) /Max Power**

Frequency (MHz)	Limit	Horizontal Measured Emission Equip Pwr Into Ideal Dipole (dBm)	Vertical Measured Emission Equip Pwr Into ideal Dipole (dBm)
1609.8250	-13.0000	-60.1814 **	-59.1939 **
2414.7375	-13.0000	-54.3602 **	-54.9327 **
3219.6500	-13.0000	-51.0904 **	-50.0515 **
4024.5625	-13.0000	-50.2681 **	-50.1886 **
4829.4750	-13.0000	-48.0522 **	-48.3785 **
5634.3875	-13.0000	-46.9583 **	-47.2294 **
6439.3000	-13.0000	-44.7526 **	-44.4781 **
7244.2125	-13.0000	-42.4710 **	-43.0684 **
8049.1250	-13.0000	-41.7055 **	-42.3115 **

RADIATED SPURIOUS EMISSIONS

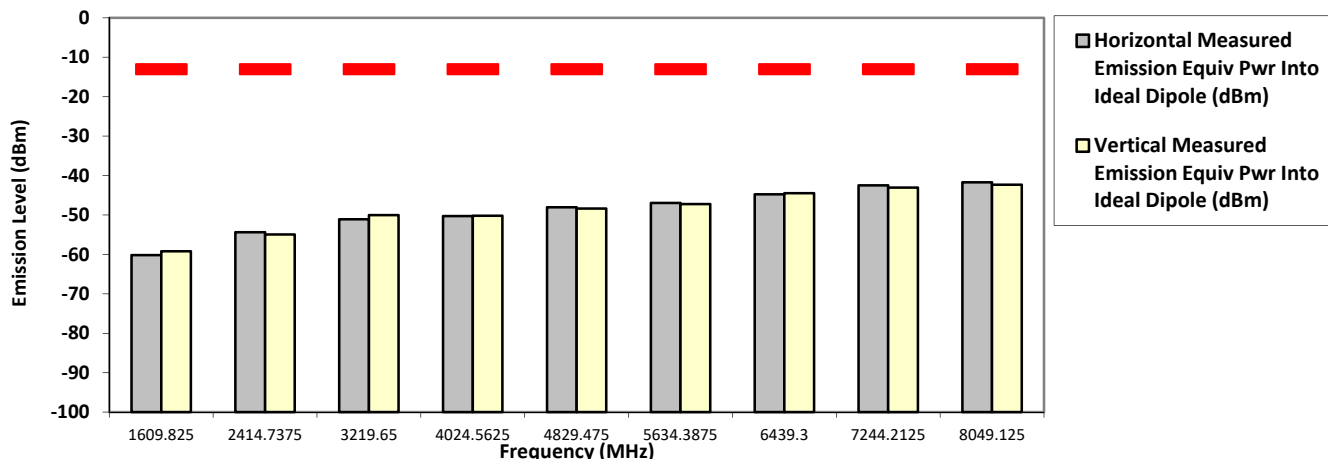

The data presented here was taken using the substitution method as found in the ANSI C63.26-2015 document.
 Motorola Penang EMC Lab - Test Performed by: Qawiman&Nazrin Thu, 4 Aug, 2022

Remarks: ** Indicates the spurious emission could not be detected due to noise limitations or ambient.
 *Pursuant to CFR 47 Part 2.1057 (c), emissions attenuated more than 20 dB below the permissible limit are not reported
 Temp(Deg): 23.4 Hum(%RH): 69.6

Remarks: Passed Results Marginal Results Failed Results

SAC Transmitter Radiated Emission:

Model Number: H35UCT9PW8AN **S/N: 022TYP0037** **SR:26977-EMC-00102**
Battery Part No: PMMN4817A **Accy Part No: NA**
Test Mode: TX APCO Digital Phase II
762.012500 MHz (Not for FCC review) **12.5 kHz** **2.990 Watt(s) /Max Power**

Frequency (MHz)	Limit	Horizontal Measured Emission Equiv Pwr Into Ideal Dipole (dBm)	Vertical Measured Emission Equiv Pwr Into ideal Dipole (dBm)
1524.0250	-13.0000	-60.3740 **	-59.5548 **
2286.0375	-13.0000	-53.6213 **	-56.3103 **
3048.0500	-13.0000	-52.6320 **	-52.3773 **
3810.0625	-13.0000	-51.1996 **	-51.5837 **
4572.0750	-13.0000	-48.2858 **	-49.1073 **
5334.0875	-13.0000	-47.7578 **	-48.4748 **
6096.1000	-13.0000	-45.5564 **	-46.3237 **
6858.1125	-13.0000	-45.2290 **	-44.3770 **
7620.1250	-13.0000	-42.2429 **	-42.3719 **

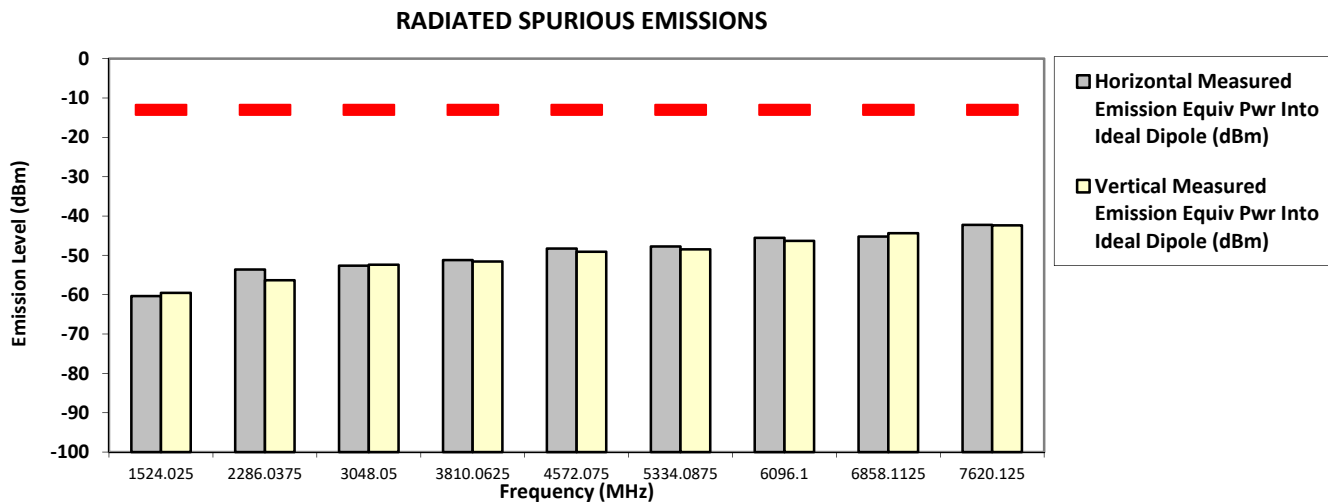

The data presented here was taken using the substitution method as found in the ANSI C63.26-2015 document.
 Motorola Penang EMC Lab - Test Performed by: Qawiman&Nazrin Thu, 4 Aug, 2022

Remarks: ** Indicates the spurious emission could not be detected due to noise limitations or ambient.
 *Pursuant to CFR 47 Part 2.1057 (c), emissions attenuated more than 20 dB below the permissible limit are not reported
 Temp(Deg): 23.4 Hum(%RH): 69.6

Remarks: Passed Results Marginal Results Failed Results

SAC Transmitter Radiated Emission:

Model Number: H35UCT9PW8AN **S/N: 022TYP0037** **SR:26977-EMC-00102**
Battery Part No: PMMN4817A **Accy Part No: NA**
Test Mode: TX APCO Digital Phase II
769.012500 MHz (Itinerant) **12.5 kHz** **2.0 Watt(s) /Max Power**

Frequency (MHz)	Limit	Horizontal Measured Emission Equiv Pwr Into Ideal Dipole (dBm)	Vertical Measured Emission Equiv Pwr Into ideal Dipole (dBm)
1538.0250	-13.0000	-59.9789 **	-59.3976 **
2307.0375	-13.0000	-55.8365 **	-55.3480 **
3076.0500	-13.0000	-50.4545 **	-51.9313 **
3845.0625	-13.0000	-50.7881 **	-51.0716 **
4614.0750	-13.0000	-48.4547 **	-49.4962 **
5383.0875	-13.0000	-47.6438 **	-47.9447 **
6152.1000	-13.0000	-46.4005 **	-45.1334 **
6921.1125	-13.0000	-44.2357 **	-44.5616 **
7690.1250	-13.0000	-42.6850 **	-43.4669 **

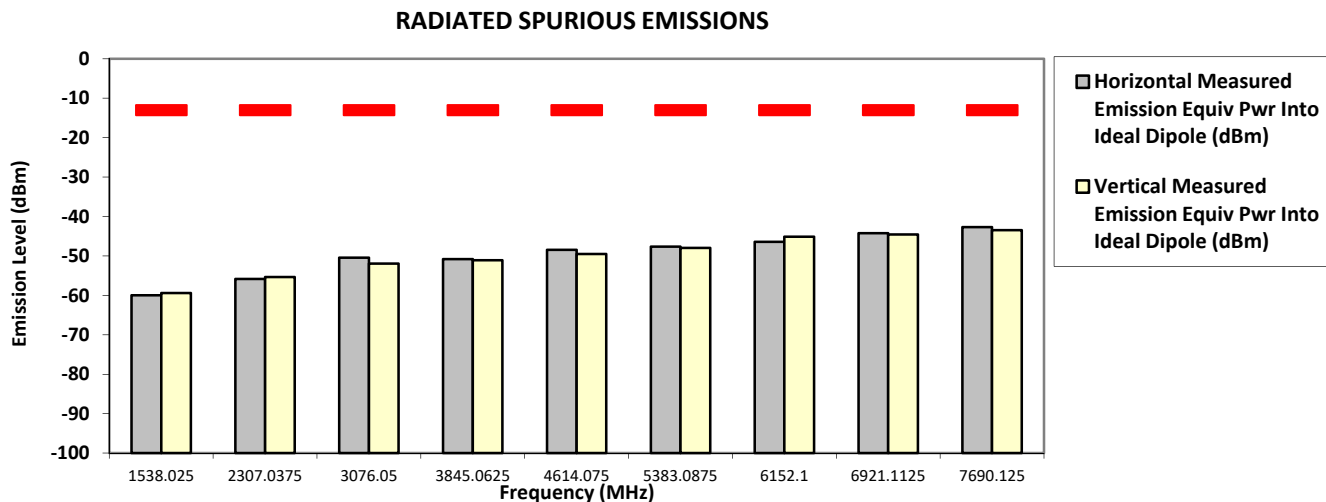

The data presented here was taken using the substitution method as found in the ANSI C63.26-2015 document.
 Motorola Penang EMC Lab - Test Performed by: Qawiman&Nazrin Thu, 4 Aug, 2022

Remarks: ** Indicates the spurious emission could not be detected due to noise limitations or ambient.
 *Pursuant to CFR 47 Part 2.1057 (c), emissions attenuated more than 20 dB below the permissible limit are not reported
 Temp(Deg): 23.4 Hum(%RH): 69.6

Remarks: Passed Results Marginal Results Failed Results

SAC Transmitter Radiated Emission:

Model Number: H35UCT9PW8AN **S/N: 022TYP0037** **SR:26977-EMC-00102**
Battery Part No: PMMN4817A **Accy Part No: NA**
Test Mode: TX APCO Digital Phase II
769.087500 MHz **12.5 kHz** **2.990 Watt(s) /Max Power**

Frequency (MHz)	Limit	Horizontal Measured Emission Equip Pwr Into Ideal Dipole (dBm)	Vertical Measured Emission Equip Pwr Into ideal Dipole (dBm)
1538.1750	-13.0000	-60.1592 **	-60.3039 **
2307.2625	-13.0000	-56.1024 **	-56.0730 **
3076.3500	-13.0000	-52.2962 **	-52.4121 **
3845.4375	-13.0000	-50.8786 **	-50.4439 **
4614.5250	-13.0000	-49.5479 **	-48.8946 **
5383.6125	-13.0000	-47.0122 **	-48.8303 **
6152.7000	-13.0000	-45.9892 **	-45.1780 **
6921.7875	-13.0000	-45.0808 **	-42.6798 **
7690.8750	-13.0000	-43.3592 **	-42.4198 **

RADIATED SPURIOUS EMISSIONS

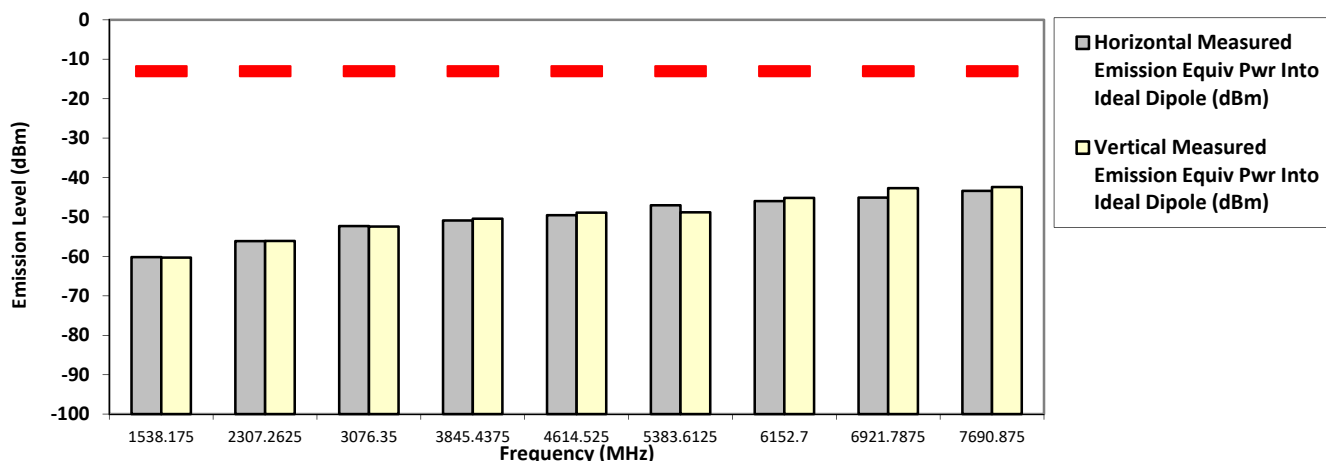

The data presented here was taken using the substitution method as found in the ANSI C63.26-2015 document.
 Motorola Penang EMC Lab - Test Performed by: Qawiman&Nazrin Thu, 4 Aug, 2022

Remarks: ** Indicates the spurious emission could not be detected due to noise limitations or ambient.
 *Pursuant to CFR 47 Part 2.1057 (c), emissions attenuated more than 20 dB below the permissible limit are not reported
 Temp(Deg): 23.4 Hum(%RH): 69.6

Remarks: Passed Results Marginal Results Failed Results

SAC Transmitter Radiated Emission:

Model Number: H35UCT9PW8AN **S/N: 022TYP0037** **SR:26977-EMC-00102**
Battery Part No: PMMN4817A **Accy Part No: NA**
Test Mode: TX APCO Digital Phase II
774.887500 MHz **12.5 kHz** **2.990 Watt(s) /Max Power**

Frequency (MHz)	Limit	Horizontal Measured Emission Equip Pwr Into Ideal Dipole (dBm)	Vertical Measured Emission Equip Pwr Into ideal Dipole (dBm)
1549.7750	-13.0000	-58.8006 **	-59.9645 **
2324.6625	-13.0000	-54.0898 **	-55.1667 **
3099.5500	-13.0000	-52.6255 **	-52.2906 **
3874.4375	-13.0000	-50.0694 **	-51.0644 **
4649.3250	-13.0000	-48.7289 **	-48.7802 **
5424.2125	-13.0000	-47.0528 **	-48.4141 **
6199.1000	-13.0000	-46.0104 **	-46.3089 **
6973.9875	-13.0000	-42.1096 **	-43.8307 **
7748.8750	-13.0000	-42.0698 **	-42.3008 **

RADIATED SPURIOUS EMISSIONS

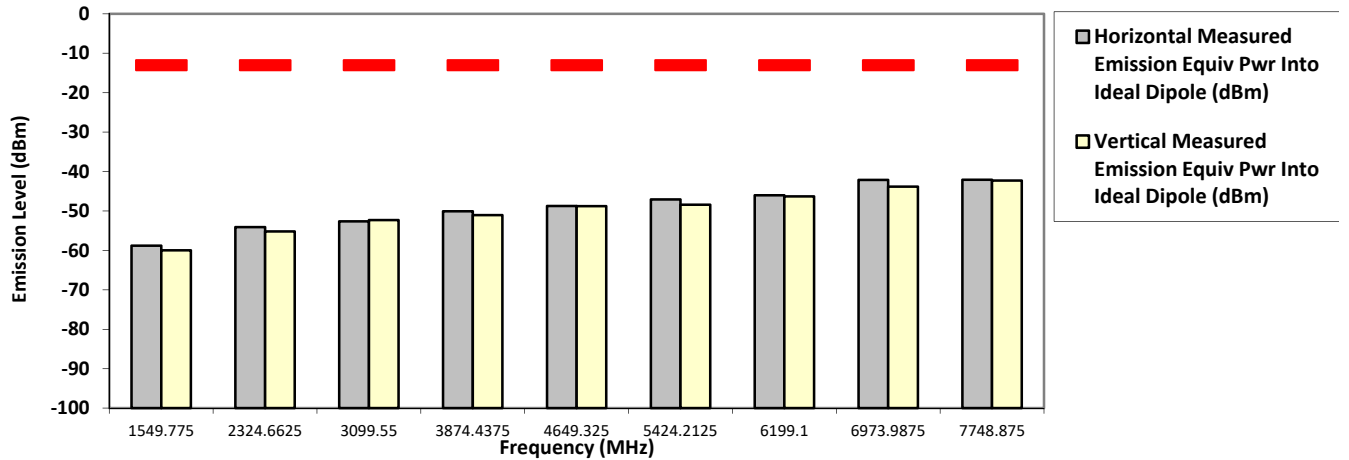

The data presented here was taken using the substitution method as found in the ANSI C63.26-2015 document.
 Motorola Penang EMC Lab - Test Performed by: Qawiman&Nazrin Thu, 4 Aug, 2022

Remarks: ** Indicates the spurious emission could not be detected due to noise limitations or ambient.
 *Pursuant to CFR 47 Part 2.1057 (c), emissions attenuated more than 20 dB below the permissible limit are not reported
 Temp(Deg): 23.4 Hum(%RH): 69.6

Remarks: Passed Results Marginal Results Failed Results

SAC Transmitter Radiated Emission:

Model Number: H35UCT9PW8AN **S/N: 022TYP0037** **SR:26977-EMC-00102**
Battery Part No: PMMN4817A **Accy Part No: NA**
Test Mode: TX APCO Digital Phase II
792.012500 MHz (Not for FCC review) **12.5 kHz** **2.990 Watt(s) /Max Power**

Frequency (MHz)	Limit	Horizontal Measured Emission Equip Pwr Into Ideal Dipole (dBm)	Vertical Measured Emission Equip Pwr Into ideal Dipole (dBm)
1584.0250	-13.0000	-59.6027 **	-58.7208 **
2376.0375	-13.0000	-55.2011 **	-53.8604 **
3168.0500	-13.0000	-50.2646 **	-51.2101 **
3960.0625	-13.0000	-50.5982 **	-50.1316 **
4752.0750	-13.0000	-47.5645 **	-48.4615 **
5544.0875	-13.0000	-47.9707 **	-47.4028 **
6336.1000	-13.0000	-44.9744 **	-45.2536 **
7128.1125	-13.0000	-43.7546 **	-43.8815 **
7920.1250	-13.0000	-42.7606 **	-42.3574 **

RADIATED SPURIOUS EMISSIONS

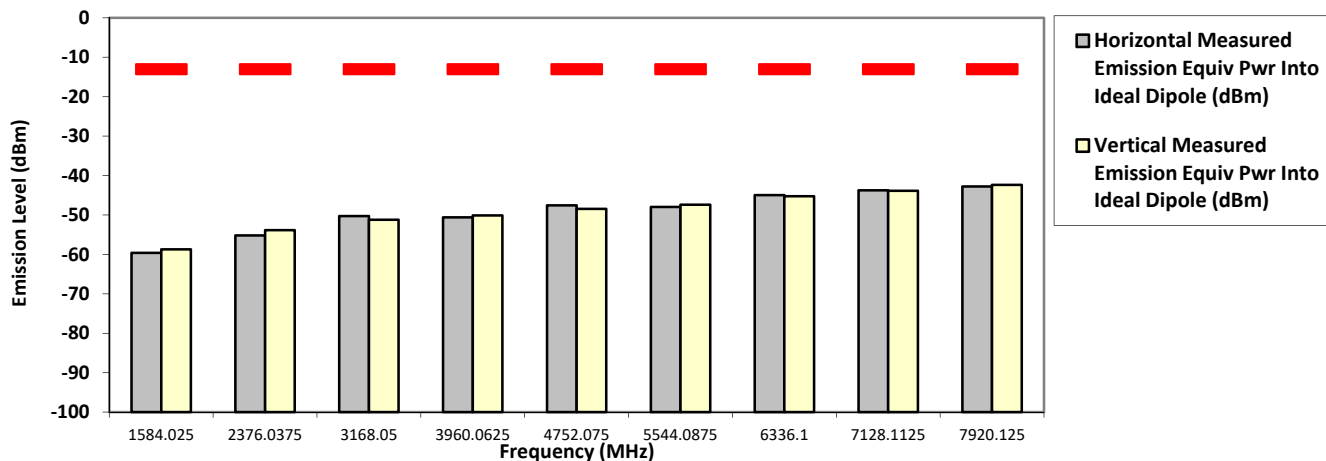

The data presented here was taken using the substitution method as found in the ANSI C63.26-2015 document.
 Motorola Penang EMC Lab - Test Performed by: Qawiman&Nazrin Thu, 4 Aug, 2022

Remarks: ** Indicates the spurious emission could not be detected due to noise limitations or ambient.
 *Pursuant to CFR 47 Part 2.1057 (c), emissions attenuated more than 20 dB below the permissible limit are not reported
 Temp(Deg): 23.4 Hum(%RH): 69.6

Remarks: Passed Results Marginal Results Failed Results

SAC Transmitter Radiated Emission:

Model Number: H35UCT9PW8AN **S/N: 022TYP0037** **SR:26977-EMC-00102**
Battery Part No: PMMN4817A **Accy Part No: NA**
Test Mode: TX APCO Digital Phase II
799.087500 MHz **12.5 kHz** **2.990 Watt(s) /Max Power**

Frequency (MHz)	Limit	Horizontal Measured Emission Equip Pwr Into Ideal Dipole (dBm)	Vertical Measured Emission Equip Pwr Into ideal Dipole (dBm)
1598.1750	-13.0000	-59.9226 **	-59.1858 **
2397.2625	-13.0000	-54.9735 **	-54.4357 **
3196.3500	-13.0000	-51.1511 **	-50.2156 **
3995.4375	-13.0000	-50.5417 **	-49.2369 **
4794.5250	-13.0000	-47.6259 **	-48.7402 **
5593.6125	-13.0000	-45.7869 **	-46.6013 **
6392.7000	-13.0000	-44.9260 **	-46.0597 **
7191.7875	-13.0000	-43.3428 **	-43.4324 **
7990.8750	-13.0000	-41.8653 **	-42.4364 **

RADIATED SPURIOUS EMISSIONS

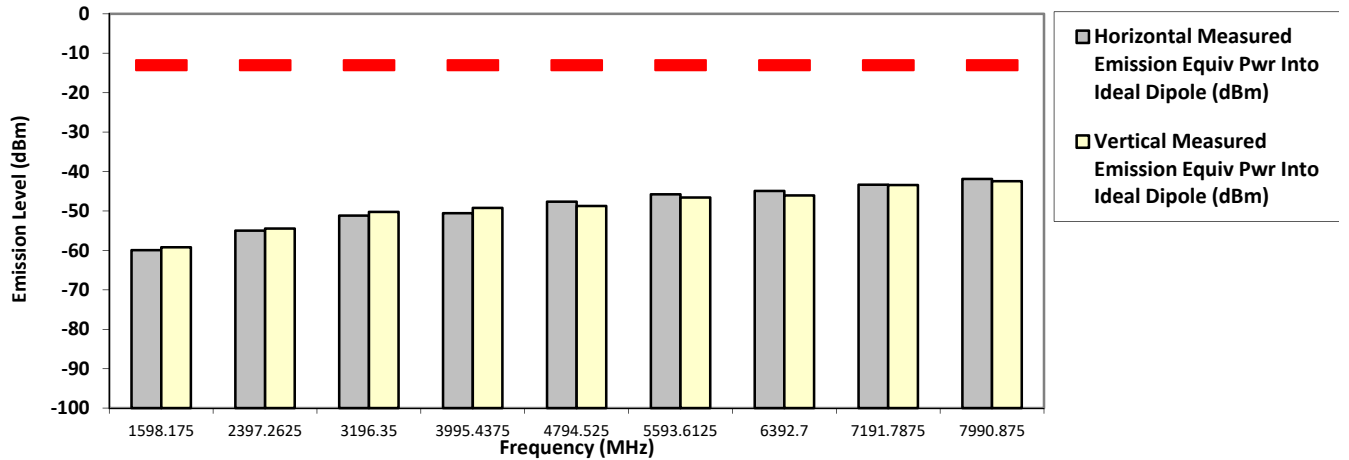

The data presented here was taken using the substitution method as found in the ANSI C63.26-2015 document.
 Motorola Penang EMC Lab - Test Performed by: Qawiman&Nazrin Thu, 4 Aug, 2022

Remarks: ** Indicates the spurious emission could not be detected due to noise limitations or ambient.
 *Pursuant to CFR 47 Part 2.1057 (c), emissions attenuated more than 20 dB below the permissible limit are not reported
 Temp(Deg): 23.4 Hum(%RH): 69.6

Remarks: Passed Results Marginal Results Failed Results

SAC Transmitter Radiated Emission:

Model Number: H35UCT9PW8AN **S/N: 022TYP0037** **SR:26977-EMC-00102**
Battery Part No: PMMN4817A **Accy Part No: NA**
Test Mode: TX APCO Digital Phase II
804.912500 MHz **12.5 kHz** **2.990 Watt(s) /Max Power**

Frequency (MHz)	Limit	Horizontal Measured Emission Equip Pwr Into Ideal Dipole (dBm)	Vertical Measured Emission Equip Pwr Into ideal Dipole (dBm)
1609.8250	-13.0000	-59.5246 **	-58.5364 **
2414.7375	-13.0000	-55.0239 **	-53.6743 **
3219.6500	-13.0000	-50.6590 **	-50.9685 **
4024.5625	-13.0000	-50.1632 **	-50.3111 **
4829.4750	-13.0000	-48.9196 **	-48.5552 **
5634.3875	-13.0000	-47.3430 **	-46.7447 **
6439.3000	-13.0000	-45.8438 **	-45.0496 **
7244.2125	-13.0000	-43.8462 **	-43.0795 **
8049.1250	-13.0000	-41.5421 **	-41.4490 **

RADIATED SPURIOUS EMISSIONS

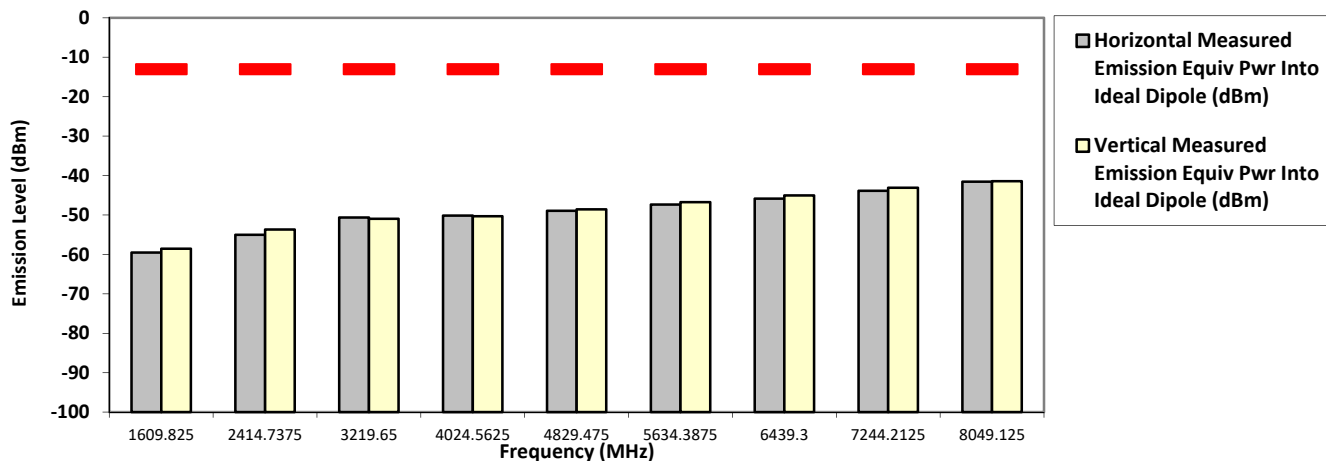

The data presented here was taken using the substitution method as found in the ANSI C63.26-2015 document.
 Motorola Penang EMC Lab - Test Performed by: Qawiman&Nazrin Thu, 4 Aug, 2022

Remarks: ** Indicates the spurious emission could not be detected due to noise limitations or ambient.
 *Pursuant to CFR 47 Part 2.1057 (c), emissions attenuated more than 20 dB below the permissible limit are not reported
 Temp(Deg): 23.4 Hum(%RH): 69.6

Remarks: Passed Results Marginal Results Failed Results

6.10.4. Test Limit

Table below summarized the power of any emission outside a licensee’s frequency block shall be attenuated below the transmitter power (P) by at least

Channel Spacing	Part 22	Part 24D	Part 74	Part 80	Part 90 (UHF, VHF, 800, 900)	Part 90 (700)
12.5kHz	43 + log ₁₀ (P) (-13 dBm)	43 + log ₁₀ (P) (-13 dBm)	43 + log ₁₀ (P) (-13 dBm)	Not Applicable	50 + log ₁₀ (P) (-20 dBm)	43 + log ₁₀ (P) (-13 dBm)
25kHz		Not Applicable		43 + log ₁₀ (P) (-13 dBm)	43 + log ₁₀ (P) (-13 dBm)	43 + log ₁₀ (P) (-13 dBm)

Channel Spacing	RSS 134	RSS 182	RSS 119 (UHF, VHF, 800, 900)	RSS 119 (700)
12.5kHz	43 + log ₁₀ (P) (-13 dBm)	Not Applicable	50 + log ₁₀ (P) (-20 dBm)	43 + log ₁₀ (P) (-13 dBm)
25kHz	Not Applicable	43 + log ₁₀ (P) (-13 dBm)	43 + log ₁₀ (P) (-13 dBm)	43 + log ₁₀ (P) (-13 dBm)

6.11. Effective Radiated Power (ERP)

6.11.1. Test Setup

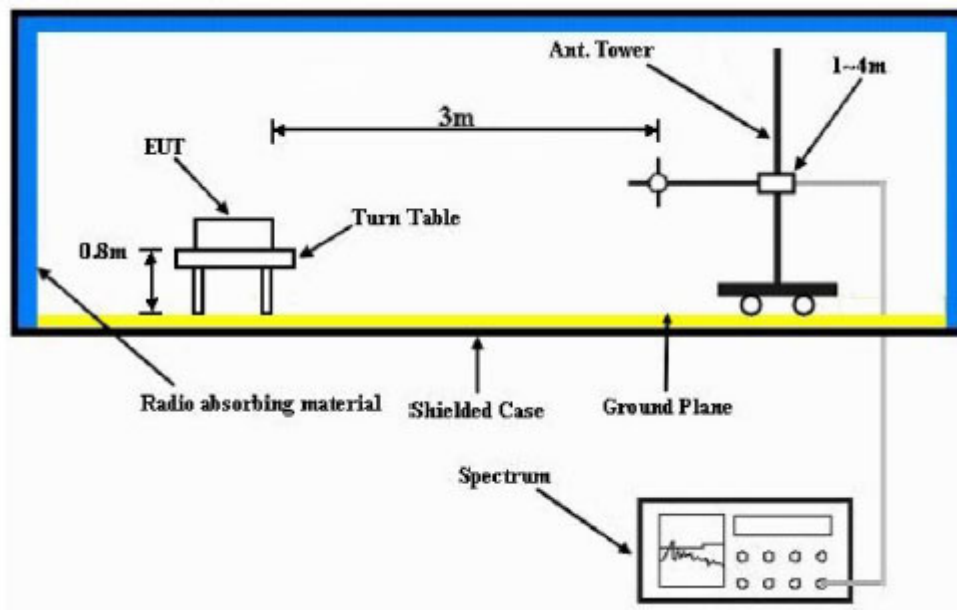

- 1) The Resolution Bandwidth for Equivalent Radiated Power (ERP) below 1 GHz is 100 kHz with Video Bandwidth = 300 kHz and Resolution Bandwidth for EIRP above 1 GHz is 1 MHz with Video Bandwidth = 3 MHz. Detector Mode is RMS.
- 2) In the semi-anechoic chamber, setup as illustrated above the DUT placed on the 0.8m height (for $F_c < 1\text{GHz}$) or 1.5m (for $F_c > 1\text{GHz}$) of Turn Table, rotated the table 45 degree each interval to search the maximum radiation power and receiver antenna shall be rotated vertical and horizontal polarization and moved height from 1m to 4m to find the maximum polar radiated power for each degree interval. The “Read Value” is the spectrum reading of maximum power value.
- 3) The substitution antenna is substituted for DUT at the same position and signals generator (S.G) export the CW signal to the substitution antenna via a TX cable. The receiver antenna shall be rotated vertical and horizontal polarization and moved height from 1m to 4m to find the maximum radiation power. Record the power level of maximum radiation power from spectrum. So, the Measured substitution value = Ref level of S.G + TX cables loss – Substituted Antenna Gain.

6.11.2. Test Result

Part 90 EIRP/ERP

SRID: 26977-EMC-00099

S/N: 022TYP0004

Channel Spacing: 12.5kHz

Antenna: AN000411A01

Tx Measured Conducted Power: 2.16 Watts

Modulation: Analog

Antenna Polarization	Frequency (MHz) (Itinerant)	EIRP (dBm)	ERP (dBm)	ERP (Watts)	Limit (Watts)	Result
Vert.	769.0125	35.10	32.95	1.9724	2	Pass

Part 90 EIRP/ERP

SRID: 26977-EMC-00099

S/N: 022TYP0004

Channel Spacing: 12.5kHz

Antenna: AN000411A01

Tx Measured Conducted Power: 2.85 Watts

Modulation: Analog

Antenna Polarization	Frequency (MHz)	EIRP (dBm)	ERP (dBm)	ERP (Watts)	Limit (Watts)	Result
Vert.	769.0875	36.32	34.17	2.6122	3	Pass

Part 90 EIRP/ERP

SRID: 26977-EMC-00099

S/N: 022TYP0004

Channel Spacing: 12.5kHz

Antenna: AN000411A01

Tx Measured Conducted Power: 2.15 Watts

Modulation: Analog

Antenna Polarization	Frequency (MHz) (Itinerant)	EIRP (dBm)	ERP (dBm)	ERP (Watts)	Limit (Watts)	Result
Vert.	799.0125	34.59	32.44	1.7539	2	Pass

Part 90 EIRP/ERP

SRID: 26977-EMC-00099

S/N: 022TYP0004

Channel Spacing: 12.5kHz

Antenna: AN000411A01

Tx Measured Conducted Power: 2.85 Watts

Modulation: Analog

Antenna Polarization	Frequency (MHz)	EIRP (dBm)	ERP (dBm)	ERP (Watts)	Limit (Watts)	Result
Vert.	804.9125	35.95	33.80	2.3988	3	Pass

6.11.3. Test Limit

The maximum output power of the transmitter for portable radio is 3 watts and 2 watts for itinerant channels. Power is given in terms of effective radiated power (ERP).

6.12. GNSS (EIRP for 1559 - 1610MHz)

6.12.1. Test Setup

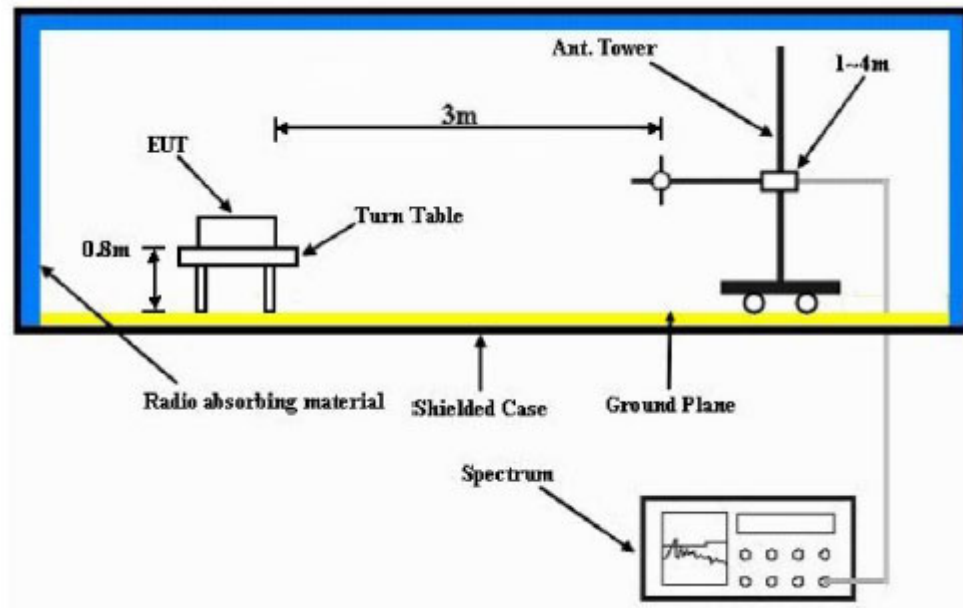

- 4) The Resolution Bandwidth for Equivalent Isotropically Radiated Power (EIRP) below 1 GHz is 100 kHz with Video Bandwidth = 300 kHz and Resolution Bandwidth for EIRP above 1 GHz is 1 MHz with Video Bandwidth = 3 MHz. Detector Mode is RMS.
- 5) In the semi-anechoic chamber, setup as illustrated above the DUT placed on the 0.8m height of Turn Table, rotated the table 45 degree each interval to search the maximum radiation power and receiver antenna shall be rotated vertical and horizontal polarization and moved height from 1m to 4m to find the maximum polar radiated power for each degree interval. The “Read Value” is the spectrum reading of maximum power value.
- 6) The substitution antenna is substituted for DUT at the same position and signals generator (S.G) export the CW signal to the substitution antenna via a TX cable. The receiver antenna shall be rotated vertical and horizontal polarization and moved height from 1m to 4m to find the maximum radiation power. Record the power level of maximum radiation power from spectrum. So, the Measured substitution value = Ref level of S.G + TX cables loss – Substituted Antenna Gain.
- 7) $EIRP = \text{“Read Value”} + \text{Measured substitution value} + 2.15$.

6.12.1. Test Result

EIRP in RNSS band (1.559GHz to 1.610GHz)

S/N: 022TYP0037

Tx Power: 2.99 Watts

Channel Spacing: 12.5kHz

Modulation: FM

Antenna: AN000411A01

Battery: PMNN4817A

Frequency Channel: 799.0875 MHz

Antenna Polarization	2Fc (MHz)	EIRP (dBm)	Limit (dBm)
Horizontal	1598.1750	-44.31	-40
Vertical	1598.1750	-45.97	-40

Frequency Channel: 804.9125 MHz

Antenna Polarization	2Fc (MHz)	EIRP (dBm)	Limit (dBm)
Horizontal	1609.8250	-45.90	-40
Vertical	1609.8250	-45.93	-40

6.12.2. Test Limit

For operations in the 758-775 MHz and 788-805 MHz bands, all emissions including harmonics in the band 1559-1610 MHz shall be limited to -70 dBW/MHz equivalent isotropically radiated power (EIRP) for wideband signals, and -80 dBW EIRP for discrete emissions of less than 700 Hz bandwidth.

~ End of Test Report ~