

 <p>CERTIFICATE 2518.08</p> <p>MS ISO/IEC 17025 TESTING SAMM NO. 0825</p>																																																	
<p>MOTOROLA PENANG ADV. COMM. LABORATORY Motorola Solutions Malaysia Sdn Bhd, Plot 2A Medan Bayan Lepas, Mukim 12 S.W.D, 11900 Bayan Lepas, Penang, Malaysia.</p>	<p>FCC Part 15 Subpart E, 15.407</p> <p>Report Revision : Rev.A Report ID : 22640-RF-00101 Service Request ID : 22640</p>																																																	
<table border="0"> <tr> <td>Date/s Tested</td> <td>: 04-Sep-2021</td> <td></td> </tr> <tr> <td>Manufacturer/Location</td> <td>: Motorola Solutions Malaysia Sdn Bhd</td> <td></td> </tr> <tr> <td>Manufacturer Address</td> <td>: Plot 2A Medan Bayan Lepas, Mukim 12 SWD, 11900 Bayan Lepas, Penang, Malaysia</td> <td></td> </tr> <tr> <td>Requestor</td> <td>: KHOO TEIK KEAN</td> <td></td> </tr> <tr> <td>Product Type</td> <td>: Hand-held</td> <td></td> </tr> <tr> <td>Tested Basic Function</td> <td>: Transmit / Receive</td> <td></td> </tr> <tr> <td>External Model Name (PMN)</td> <td>: R7</td> <td></td> </tr> <tr> <td>Sales Model Number (HVIN)</td> <td>: AAH06JDN9RA1AN (IC Model: PMUD3491ABB)</td> <td></td> </tr> <tr> <td>Frequency Band</td> <td>: 5180-5320MHz; 5500-5825MHz</td> <td></td> </tr> <tr> <td>Max RF Output Power</td> <td>: 63.1mW</td> <td></td> </tr> <tr> <td>Applicant Name</td> <td>: Motorola Solutions Inc</td> <td></td> </tr> <tr> <td>Applicant Address</td> <td>: 8000 West Sunrise Boulevard, Fort Lauderdale, Florida 33322</td> <td></td> </tr> <tr> <td>FCC Registrations</td> <td>: 461337</td> <td></td> </tr> <tr> <td>ISED Registrations</td> <td>: MY0001</td> <td></td> </tr> <tr> <td>Firmware Version (FVIN)</td> <td>: D02.21.04.0065</td> <td></td> </tr> </table> <div style="text-align: right; margin-top: 20px;">  </div> <p>The equipment was tested to the standard(s) listed below with the following result :</p> <table border="0" style="width: 100%;"> <tr> <td style="width: 60%;">- FCC Part 15 Subpart E 15.407</td> <td style="width: 40%; text-align: center;">PASS</td> </tr> <tr> <td>ISED RSS-247, Issue 2 Section 6.3</td> <td></td> </tr> </table>		Date/s Tested	: 04-Sep-2021		Manufacturer/Location	: Motorola Solutions Malaysia Sdn Bhd		Manufacturer Address	: Plot 2A Medan Bayan Lepas, Mukim 12 SWD, 11900 Bayan Lepas, Penang, Malaysia		Requestor	: KHOO TEIK KEAN		Product Type	: Hand-held		Tested Basic Function	: Transmit / Receive		External Model Name (PMN)	: R7		Sales Model Number (HVIN)	: AAH06JDN9RA1AN (IC Model: PMUD3491ABB)		Frequency Band	: 5180-5320MHz; 5500-5825MHz		Max RF Output Power	: 63.1mW		Applicant Name	: Motorola Solutions Inc		Applicant Address	: 8000 West Sunrise Boulevard, Fort Lauderdale, Florida 33322		FCC Registrations	: 461337		ISED Registrations	: MY0001		Firmware Version (FVIN)	: D02.21.04.0065		- FCC Part 15 Subpart E 15.407	PASS	ISED RSS-247, Issue 2 Section 6.3	
Date/s Tested	: 04-Sep-2021																																																	
Manufacturer/Location	: Motorola Solutions Malaysia Sdn Bhd																																																	
Manufacturer Address	: Plot 2A Medan Bayan Lepas, Mukim 12 SWD, 11900 Bayan Lepas, Penang, Malaysia																																																	
Requestor	: KHOO TEIK KEAN																																																	
Product Type	: Hand-held																																																	
Tested Basic Function	: Transmit / Receive																																																	
External Model Name (PMN)	: R7																																																	
Sales Model Number (HVIN)	: AAH06JDN9RA1AN (IC Model: PMUD3491ABB)																																																	
Frequency Band	: 5180-5320MHz; 5500-5825MHz																																																	
Max RF Output Power	: 63.1mW																																																	
Applicant Name	: Motorola Solutions Inc																																																	
Applicant Address	: 8000 West Sunrise Boulevard, Fort Lauderdale, Florida 33322																																																	
FCC Registrations	: 461337																																																	
ISED Registrations	: MY0001																																																	
Firmware Version (FVIN)	: D02.21.04.0065																																																	
- FCC Part 15 Subpart E 15.407	PASS																																																	
ISED RSS-247, Issue 2 Section 6.3																																																		
<p>This report shall not be reproduced without written approval from an officially designated representative of the Motorola Penang Adv. Comm. Laboratory. The results and statements contained in this report pertain only to the device(s) evaluated.</p>																																																		
<p>Prepared By:</p> <div style="text-align: center; margin-top: 20px;">  </div> <hr style="width: 20%; margin: 0 auto;"/> <p>Gan Boon Teong Technician</p>	<p>Approved Signatory:</p> <div style="text-align: center; margin-top: 20px;">  </div> <hr style="width: 20%; margin: 0 auto;"/> <p>Vincent Foong Chuen Kit Responsible Engineer</p>																																																	

TABLE OF CONTENTS

1. Introduction and Overview3

2. Test Laboratory Status3

3. Test Environmental Conditions.....3

3.1. Temperature and Humidity3

3.2. Tolerance.....3

3.3. Measurement Uncertainty3

4. Test Results Summary3

5. Technical Data of Device Under Test.....4

5.1. Operating Frequency Bands and Mode of EUT.....4

5.2. List of antennas and their corresponding gains4

5.3. Modifications and deviation from standard4

5.4. EUT Maximum Output Power4

5.5. Channel loading messages or sequences.....4

5.6. Transmit Power Control (TPC)5

5.7. Time required for master or client device to complete power cycle5

5.8. System Architecture.....5

5.9. Master device identification.....5

6. Test setup and list of equipment6

6.1. Setup block diagram6

6.2. List of Equipment.....7

6.3. Test Setup Photos7

7. Test Requirements.....8

7.1. DFS Requirements / Limits.....8

7.2. DFS Detection Threshold8

8. Test Procedure and Test Data.....9

8.1. Test Method9

8.2. Test Data9

REVISION HISTORY

Revision History	Description	Date	Originator
Rev. A	Initial report	20-Sep-2021	Gan Boon Teong

1. Introduction and Overview

This report details the utilization, technical data of device under test, test equipment, and test results of the measurements performed at the Motorola Penang Advanced Communication Laboratory in accordance to the standards specified on page 1.

This test report is only valid in its original form.

The test results herein refer only to the tested sample. Motorola Penang Advanced Communication Laboratory is not responsible for any generalizations or conclusions drawn from these test results and concerning further samples.

2. Test Laboratory Status

Motorola Penang Advanced Communication Laboratory is an ISO/IEC17025:2005 accredited laboratory. The laboratory was accredited by SAMM, with SAMM Cert No #0825

3. Test Environmental Conditions

3.1. Temperature and Humidity

Ambient Temperature	Rel. Air Humidity
15 °C to 35 °C	20 %RH to 75%RH

3.2. Tolerance

Chamber Temperature Tolerance	Chamber Humidity Tolerance
± 0.3 °c	± 3 %

3.3. Measurement Uncertainty

The measurement uncertainty represents an expanded uncertainty expressed at approximately the 95% confidence level using a coverage factor of k=1.96

4. Test Results Summary

The table below summarizes the test results for the test completed. For detailed test data, refer to section 7.

Section	Test Parameters	Results	Serial number
7.1.1	FCC Part 15.407 / RSS-247 Non Occupancy Period	PASS	865TXP0468
7.1.2	FCC Part 15.407 / RSS-247 Channel Move Time	PASS	865TXP0468
7.1.3	FCC Part 15.407 / RSS-247 Channel Closing Transmission Time	PASS	865TXP0468

NOTE:

NA → Not Applicable

5. Technical Data of Device Under Test

5.1. Operating Frequency Bands and Mode of EUT

Operational Mode	Operating Frequency Range	
	5250-5350MHz	5470-5725MHz
Client without radar detection and ad hoc function	Yes	Yes

5.2. List of antennas and their corresponding gains

Antenna #	Type	Frequency Range	Max Gain (dBi)
1	WiFi Antenna	4900-5900MHz	2.7

5.3. Modifications and deviation from standard

There is no deviation between the test carried out compared to the standard test method

5.4. EUT Maximum Output Power

802.11a

Antenna #	Frequency Range	Output Power (dBm)	Max EIRP including duty cycle correction
1	5250-5350MHz	17.364	20.064
1	5470-5725MHz	14.591	17.291

802.11n (20MHz)

Antenna #	Frequency Range	Output Power (dBm)	Max EIRP including duty cycle correction
1	5250-5350MHz	17.485	20.185
1	5470-5725MHz	14.679	17.379

5.5. Channel loading messages or sequences

Channel loading was achieved by using iPerf software to control throughput.

5.6. Transmit Power Control (TPC)

U-NII devices operating in the 5.25-5.35GHz band and the 5.47-5.725GHz band shall employ a TPC mechanism. The U-NII device is required to have the capability to operate at least 6dB below the EIRP value of 30dBm. A TPC mechanism is not required for systems with an EIRP of less than 500mW.

Maximum EIRP for this device is 20.041 dBm which is 100.95 mW, therefore TPC is not required.

5.7. Time required for master or client device to complete power cycle

The master device took 1 minute and 15 seconds to complete its power cycle. The client device does not have radar detection and therefore its power on time is not applicable.

5.8. System Architecture

The EUT utilizes IP based system architecture

5.9. Master device identification

The DFS compliant master device used for testing was a Linksys WRT3200ACM with serial number 19810625700081, and FCC ID Q87-WRT3200ACM and IC ID 3839A-WRT3200ACM

6. Test setup and list of equipment

6.1. Setup block diagram

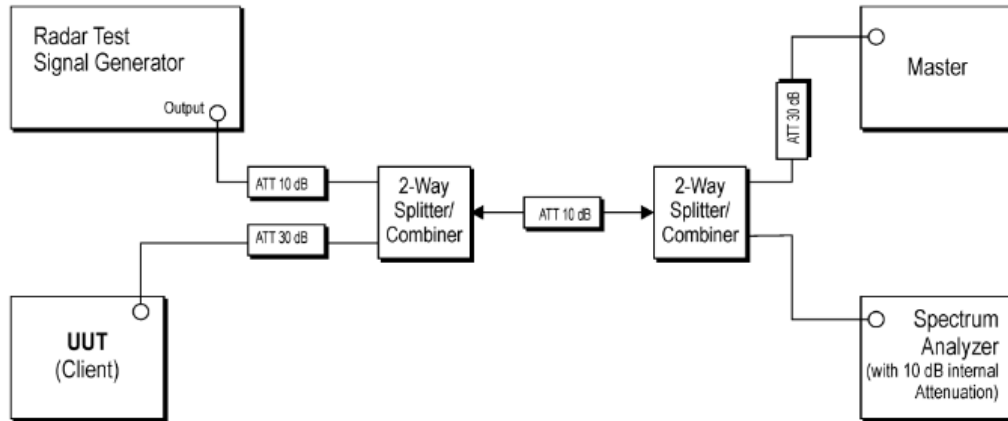

6.2. List of Equipment

Description	Model #	Serial Number	Calibration Date	Calibration Due Date
OPEN SWITCH & CONTROL UNIT	OSP120	101256	Not Required	Not Required
SIGNAL ANALYZER	FSV	101515	22-Apr-21	22-Apr-22
BASIC 8-CHANNEL SWITCH MODULE	OSP-B157W8	101073	11-Mar-21	11-Mar-23
VECTOR SIGNAL GENERATOR	SMBV100A	261962	21-Apr-21	21-Apr-23
WIDEBAND RADIO COMMUNICATION TESTER	CMW500	154549	7-Mar-21	7-Mar-23
CHAMBER	SH-641	92002651	2-Feb-21	2-Feb-22
STEP ATTENUATOR	RSC	102218	11-Nov-19	11-Nov-21
POWER SUPPLY	6033A	2934A04716	14-Jan-20	14-Jan-22
SIGNAL GENERATOR	SMB100A	182511	4-Jun-21	4-Jun-24

6.3. Test Setup Photos

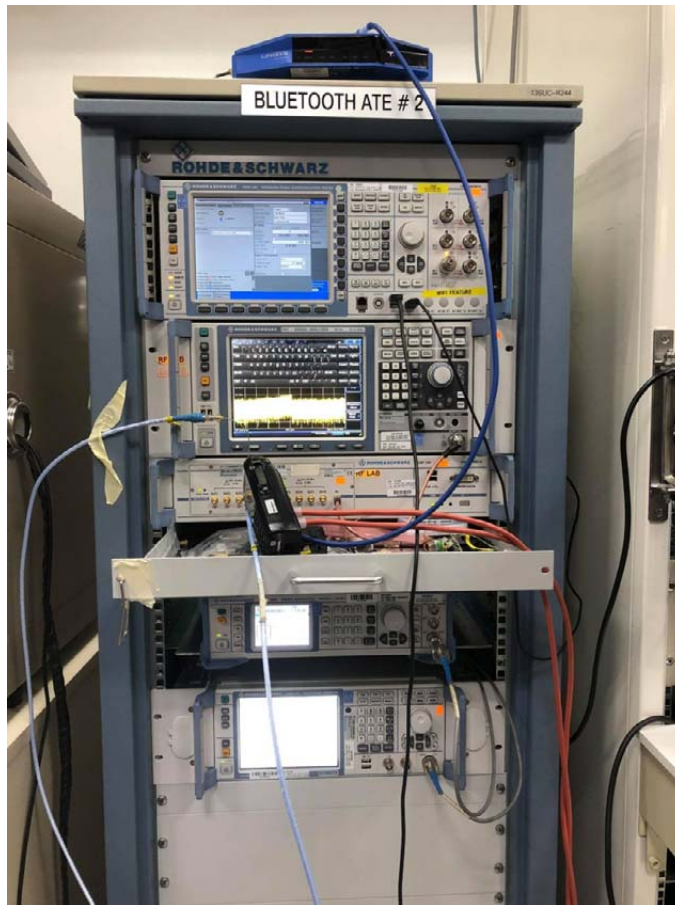

7. Test Requirements

7.1. DFS Requirements / Limits

Requirement	Limit
Channel Move Time	10 seconds
Channel Closing Transmission Time	200ms + an aggregate 60ms over following 10 seconds
Non-Occupancy Period	30 minutes

7.2. DFS Detection Threshold

The calibrated conducted DFS detection threshold level was set at -63 dBm. This level exceeds the specification for the stipulated detection level of -64dBm and ensures there is margin to the limit to ensure successful detection.

8. Test Procedure and Test Data

8.1. Test Method

DFS testing was performed using the conducted test methods defined in 905462 D02 UNII DFS Compliance Procedures New Rules v02. The device was a client only device without radar detection capability. The Rohde & Schwarz TS8997 test system in conjunction with WMS32 software was used for the automation of the testing.

8.2. Test Data

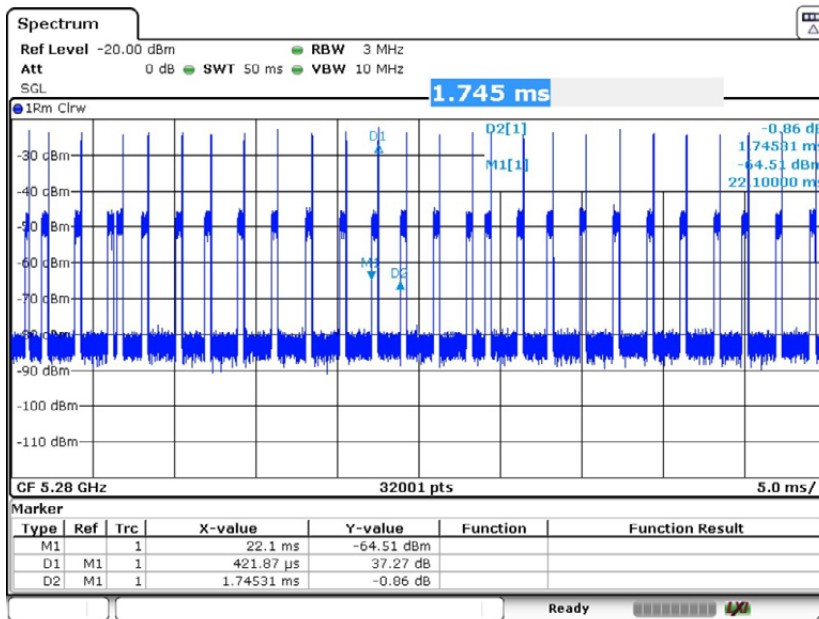

The resulting plot data was extracted and post processed, giving a duty cycle of 24.17%.

DFS Detection Threshold

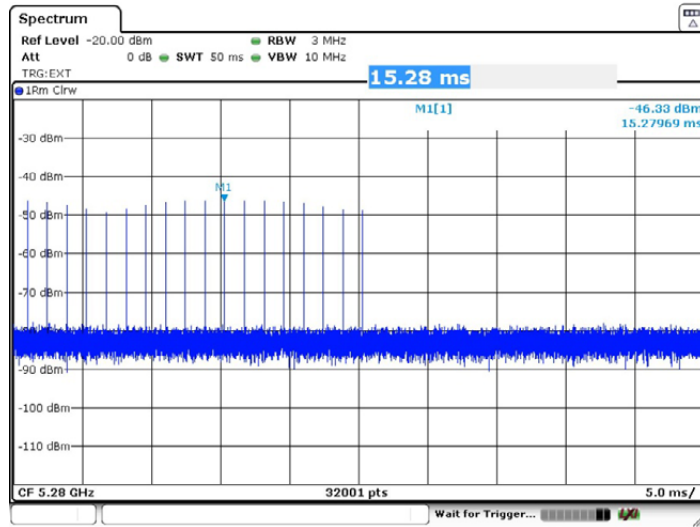

Peak of -46.33dBm, with losses at combiners factoring antenna gain to be 15.81dB, therefore level going into antenna port is -62.14dBm which exceeds threshold level of -64dBm for successful detection.

Channel Move and Closing Time

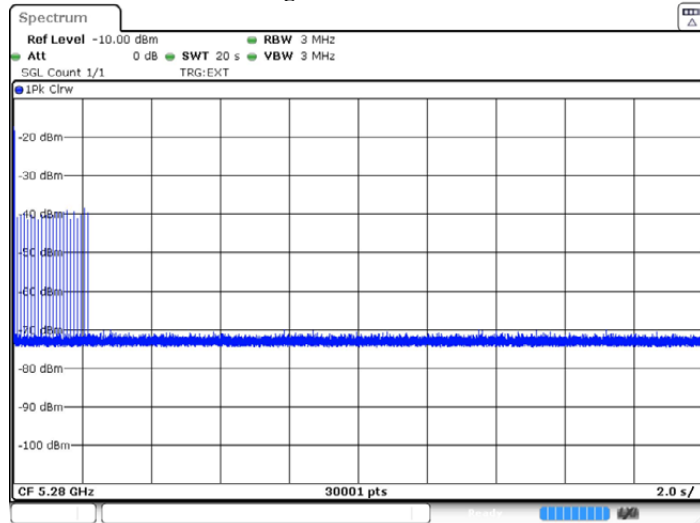

Channel Closing and Channel Move Time

Detailed Results

DUT Frequency (MHz)	Radar Type No.	Time duration	No of pulses found	Tx time (ms)	Tx Time Limit (ms)
5280	0	200ms	2	0.796	200
5280	0	remaining 10.0s period	19	7.664	60

Last transmission after injection of radar is 2.126 seconds, therefore meeting channel closing time 10s requirement.

Non-Occupancy Period

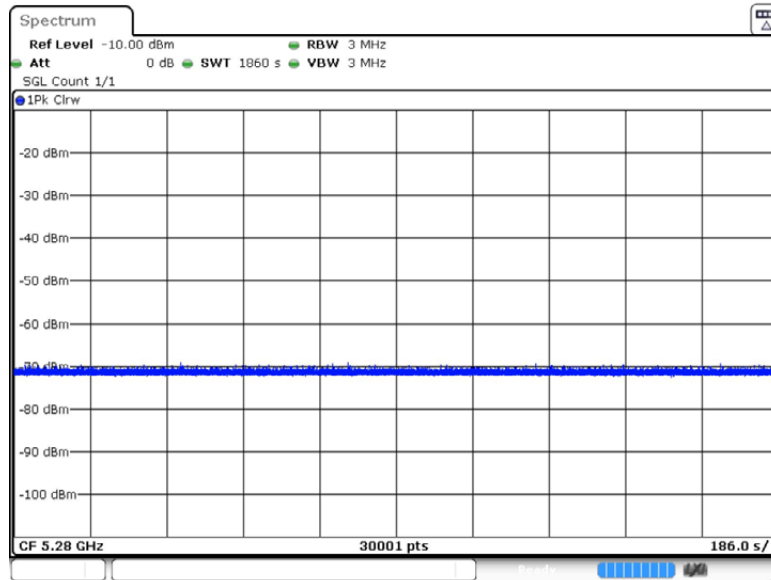

No pulses were detected in the 30 minutes that followed after channel move time, meeting non-occupancy 30 minute requirement.

END OF TEST REPORT