

EXHIBIT 9

Internal Photographs

(Pursuant to FCC Part 2.1033(b)(7) and 2.1033(c)(12) and RSP 100 Annex C)

The following photographs are attached.

	<u>Exhibit</u>
1. RF board <u>with</u> Shields (Top)	9A
2. RF board <u>without</u> Shields (Top)	9B
3. RF board <u>with</u> Shields (Bottom)	9C
4. RF board <u>without</u> Shields (Bottom)	9D
5. Display board <u>with</u> Shield	9E
6. Display board <u>without</u> Shield	9F
7. Display board (LED)	9G
8. PCB board with chassis and housing (Top)	9H
9. PCB board with chassis and housing (Bottom)	9I
10. Exploded View of radio	9J

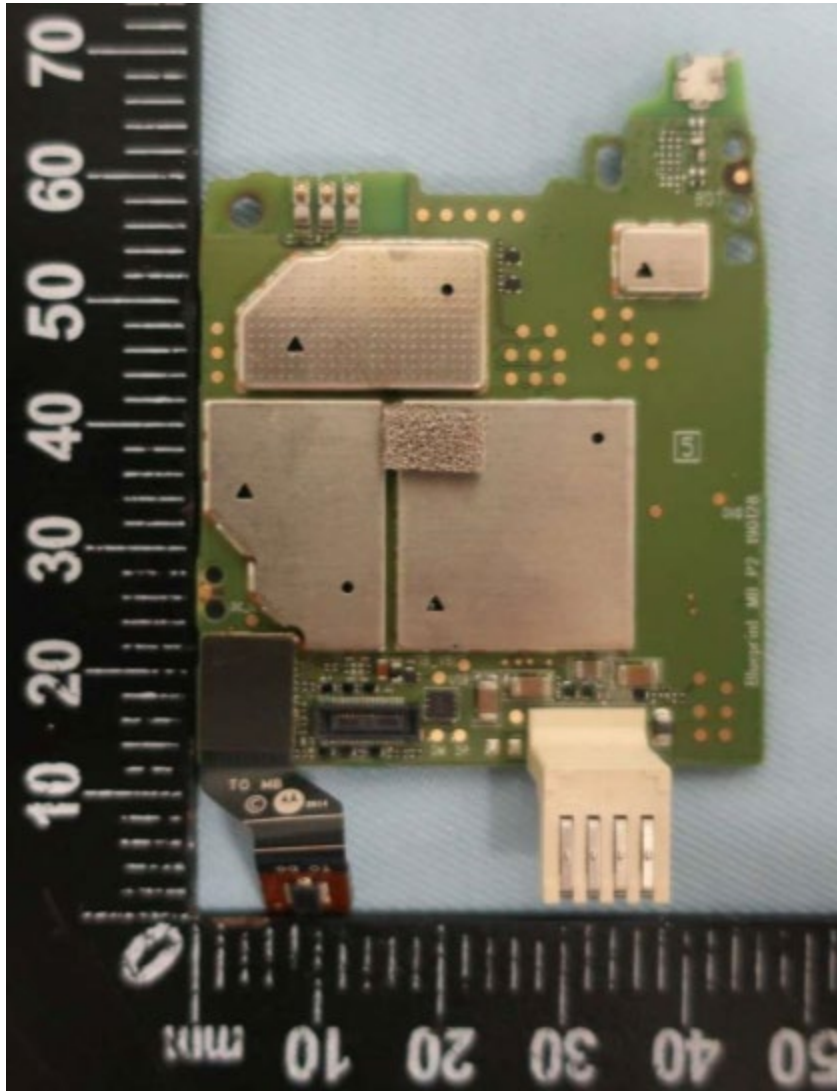

Exhibit 9A

RF board with Shields (Top)

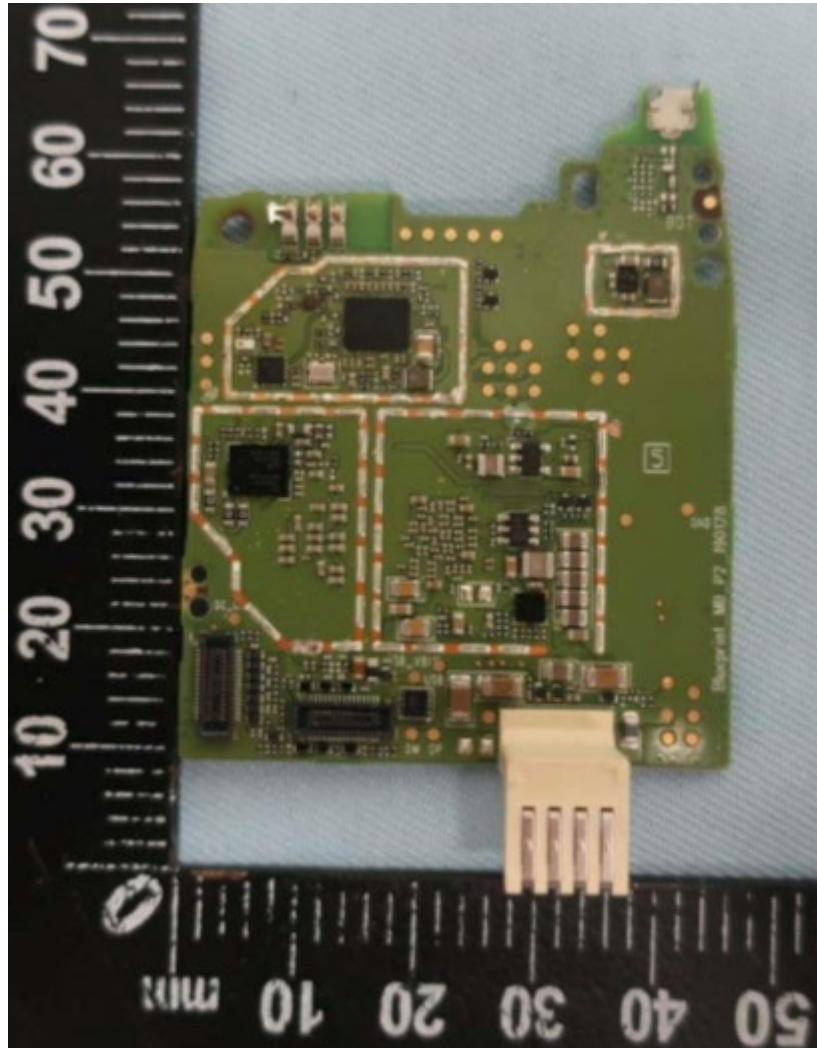

Exhibit 9A

RF board without Shields (Top)

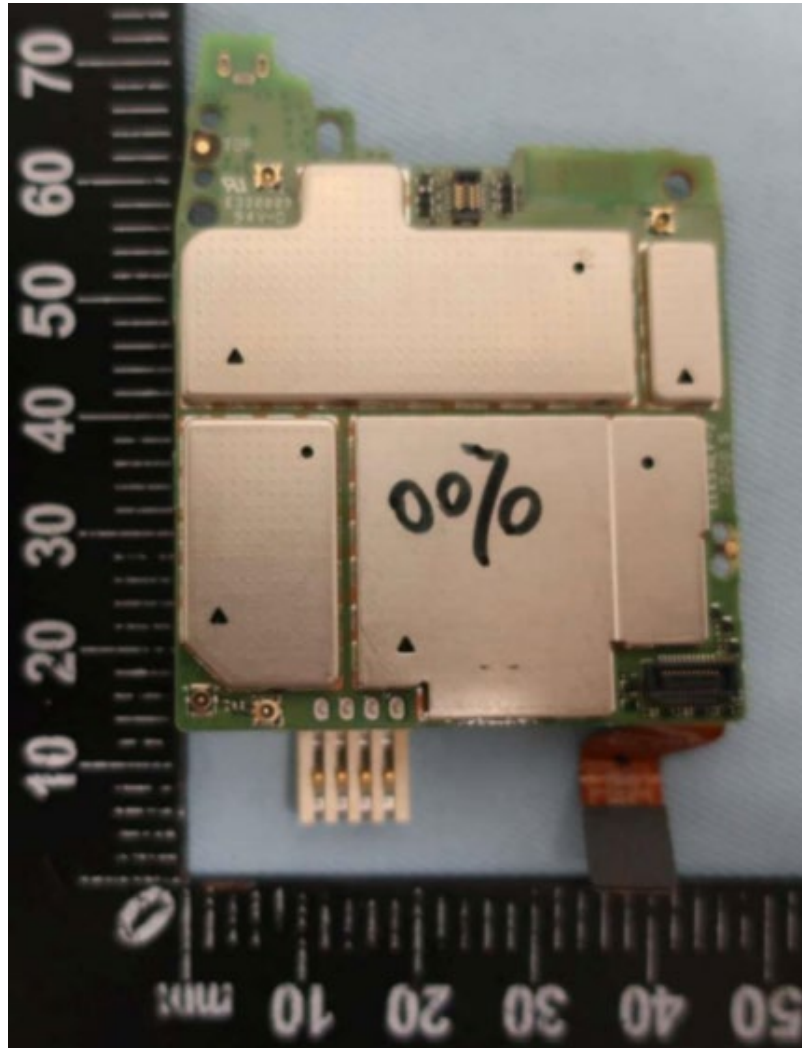

Exhibit 9B

RF board with Shields (Bottom)



Exhibit 9C

RF board without Shields (Bottom)

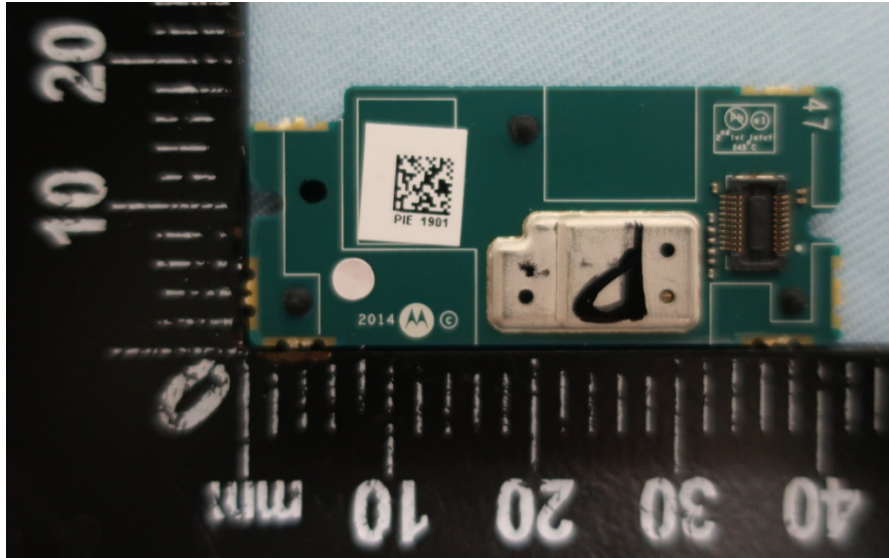

Exhibit 9E

Display board with Shield

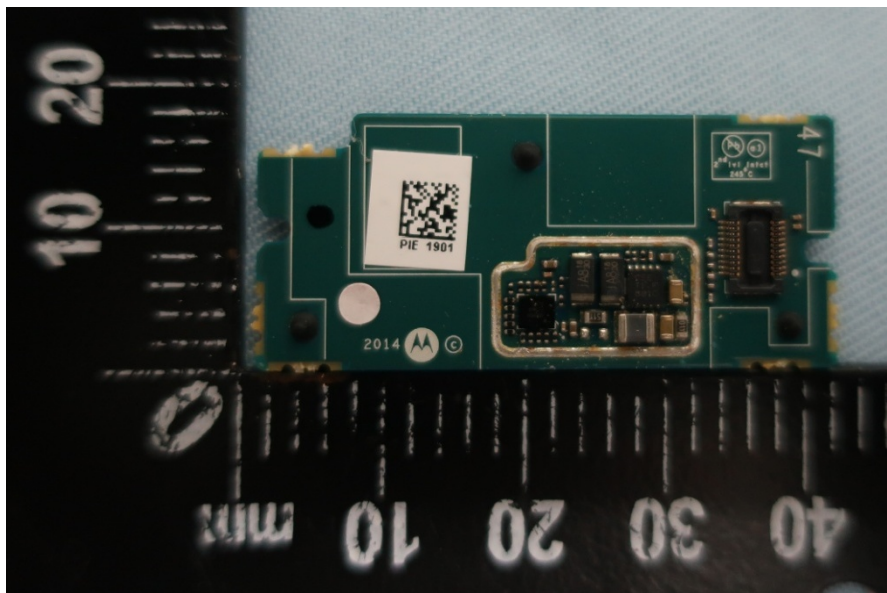

Exhibit 9F

Display board without Shield

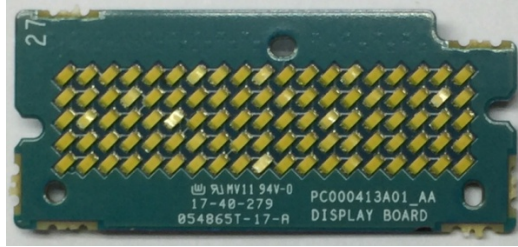

Exhibit 9G

Display board (LED)



Exhibit 9H

PCB board with chassis and housing (Top)

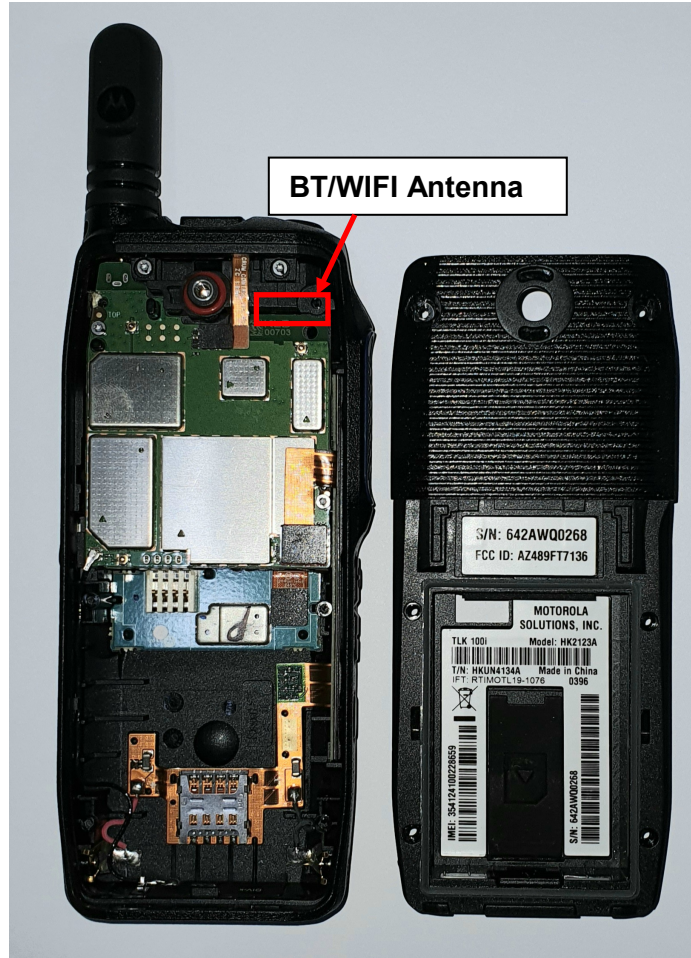

Exhibit 9I

PCB board with chassis and housing (Bottom)

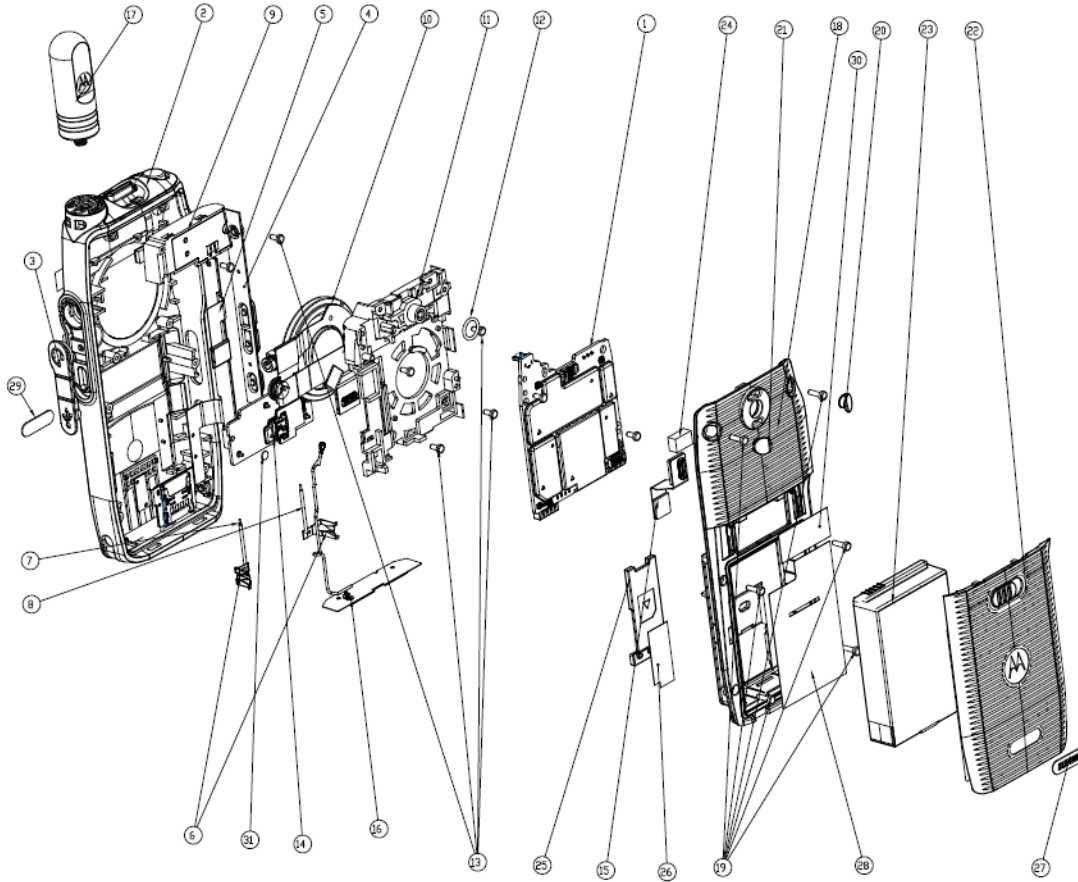

Exhibit 9J

Exploded View of radio