 <p>MS ISO/IEC 17025 TESTING SAMM No. 0825</p>
---	---

<p>MOTOROLA PENANG ADV. COMM. LABORATORY Motorola Solutions Malaysia Sdn Bhd Innoplex Plot 2A, Medan Bayan Lepas, Mukim 12 S.W.D, 11900 Bayan Lepas, Penang, Malaysia.</p>	<p>FCC / ISED TEST REPORT Report Revision : Rev.A</p>
---	---

<p>Date/s Tested : 24-DEC-2018 - 8-MAR-2019 Report Issue Date : 13-MAR-2019 Manufacturer/Location : Motorola Solutions Malaysia Sdn Bhd Manufacturer Address : Innoplex Plot 2A, Medan Bayan Lepas, 11900 Bayan Lepas, Penang, Malaysia Requestor : HOPKINS, SEAN Product Type : Portable Model Number : H55TGT9PW8AN Frequency Band : 806-825MHZ, 851-870MHZ Low / Max RF Output Power : 1 Watts / 3.6 Watts Application Name : Motorola Solutions Inc ISED Registrations : 109AK FCC Registrations : 461337 Firmware Version : D19.70.35</p>			
<p>The equipment was tested accordance to the requirement listed below:</p> <table><tr><td>(LMR) FCC 47 CFR Part 22 / 74 / 80 / 90 ISED RSS- Gen / 119</td><td>PASS</td></tr></table>		(LMR) FCC 47 CFR Part 22 / 74 / 80 / 90 ISED RSS- Gen / 119	PASS
(LMR) FCC 47 CFR Part 22 / 74 / 80 / 90 ISED RSS- Gen / 119	PASS		

This report shall not be reproduced without written approval from an officially designated representative of the Motorola Penang Adv. Comm. Laboratory. The results and statements contained in this report pertain only to the device(s) evaluated.

<p>Prepared By:</p>  <hr/> <p>Khor Wei Loong Test Personnel</p>	<p>Approved By:</p> <hr/> <p>Vincent Foong Responsible Engineer</p>
---	--

Table of Contents

Report Revision History	3
1.0 General Information.....	4
2.0 Summary of Test Results	5
3.0 Measurement Uncertainty	6
4.0 Equipment List.....	7
5.0 Test Condition.....	10
5.1. Transmitter Test Conditions	10
6.0 Transmitter Test Parameters	11
6.1. RF Output Power	11
6.1.1. Test Setup.....	11
6.1.2. Test Result	11
6.2. Frequency Stability	12
6.2.1. Test Setup.....	12
6.2.2. Test Result	13
6.2.3. Test Limit.....	14
6.3. Audio Frequency Response	15
6.3.1. Test Setup.....	15
6.3.2. Test Result	16
6.3.3. Test Limit.....	17
6.4. Audio Low Pass Filter Response	18
6.4.1. Test Setup.....	18
6.4.2. Test Result	19
6.4.3. Test Limit.....	20
6.5. Modulation Limiting.....	21
6.5.1. Test Setup.....	21
6.5.2. Test Result	22
6.5.3. Test Limit.....	22
6.6. Occupied Bandwidth.....	23
6.6.1. Test Setup (Analog)	23
6.6.2. Test Result (Analog)	24
6.6.3. Test Setup (Digital).....	40
6.6.4. Test Result (Digital).....	41
6.6.5. Test Limit.....	61
6.7. Band Edge Conducted Spurious Emission (Part 22)	62
6.7.1. Test Setup (Analog)	62
6.7.2. Test Result (Analog)	62
6.7.3. Test Setup (Digital).....	63
6.7.4. Test Result (Digital).....	63
6.7.5. Test Limit.....	63
6.8. Transient Frequency Behavior.....	64

6.8.1. Test Setup..... 64
 6.8.2. Test Result 65
 6.8.3. Test Limit..... 65
 6.9. Adjacent Channel Power..... 66
 6.9.1. Test Setup (Analog) 66
 6.9.2. Test Result 66
 6.9.3. Test Setup (Digital)..... 67
 6.9.4. Test Result 67
 6.10. Conducted Spurious Emission 70
 6.10.1. Test Setup..... 70
 6.10.2. Test Result (Analog)..... 71
 6.10.3. Test Result (Digital)..... 77
 6.10.4. Test Limit..... 89
 6.11. Radiated Spurious Emission 90
 6.11.1. Test Setup..... 90
 6.11.2. Test Result (Analog)..... 91
 6.11.3. Test Result (Digital)..... 103
 6.11.4. Test Limit..... 103
 6.12. Effective Radiated Power (ERP) 128
 6.12.1. Test Setup..... 128
 6.12.2. Test Result 128
 6.12.3. Test Limit..... 128
 6.13. GNSS (EIRP for 1559 - 1610MHz)..... 129
 6.13.1. Test Setup..... 129
 6.13.1. Test Result 129
 6.13.2. Test Limit..... 130

Report Revision History

Revision History	Description	Date	Originator
Rev. A	Initial Report	11-Mar-2019	Khor Wei Loong

1.0 General Information

EUT Description:

Technologies	Land Mobile Radio (LMR)
Modulation Type	Analog, C4FM , Phase II

General Description of Applied Standards

The EUT is a RF Product. According to the specifications of the manufacturer, the EUT is to comply with the requirements of the following standards:

ANSI C63.4-2014

ANSI C63.26-2015

2.0 Summary of Test Results

FCC General Rules Part (47CFR)	ISED General Rules Part	Test Item	Result	Remark
2.1046,22.565, 74.461,74.534, 80.215	RSS-119	RF Power Output	Pass	-
2.1055, 90.213,22.355	-	Frequency Stability	Pass	-
2.1047, 74.463, 80.213, RSS 119	RSS-119	Audio Frequency Response	Pass	-
2.1047, 74.463, 80.213, RSS 119	RSS-119	Audio Low Pass Filter Response	NA	-
2.1047, 74.463, 80.213, RSS 119	RSS-119	Modulation limiting	Pass	-
2.1049, 90.210, 22.359, 74.462, 74.535, 80.211(c), 80.211(f)	RSS-119	Occupied Bandwidth	Pass	8K10F1W – 7.4479kHz 8K10F1D –7.8548kHz 8K10F1E – 7.5032kHz 16K0F3E – 15.0556kHz 11K0F3E – 9.9997kHz 20K0F1E – 11.7461kHz
-	-	Band Edge Conducted Spurious Emission	NA	-
90.214	-	Transient Frequency Behavior	Pass	-
-	-	Adjacent Channel Power	NA	-
2.1051,22.359	RSS-119	Conducted Spurious Emissions	Pass	Highest Spur Level -37.95 dBm
2.1053, 90.543	RSS-119	Radiated Spurious Emission	Pass	Highest Radiated Emission Level -48.66 dBm
-	-	GNSS (EIRP for 1559 – 1610MHz)	NA	-
-	-	Effective Radiated Power (ERP)	NA	-

NA → Not Applicable

3.0 Measurement Uncertainty

Measurement	Frequency	Expanded Uncertainty (k=1.96) (±)
AC Power Line Conducted Spurious Emission	150KHz ~ 30MHz	3.43
Radiated Emissions up to 1 GHz	30MHz ~ 200MHz	5.01
	200MHz ~ 1000MHz	5.01
Radiated Emissions above 1 GHz	1GHz ~ 18GHz	5.01
	18GHz ~ 25GHz	5.01

4.0 Equipment List

FCC Analog ATE#1: (SW version: 2.4.5 & FCC_Frequency Stability 1.0.3 rev.)

Description	Model	Serial Number	Calibration Date	Calibration Due Date
Audio Analyzer	8903B	3011A10475	9-Jul-18	9-Jul-19
SIGNAL GENERATOR	2042	203001/904	8-Mar-18	9-Mar-19
MODULATION ANALYZER	8901B	3538A03696	3-Apr-18	3-Apr-19
DSA	36570A	MY42506781	6-Jul-18	6-Jul-19
POWER SENSOR	E9031A	MY41498969	17-Apr-18	17-Apr-19
POWER METER	E4416A	MY45101016	16-Jan-18	16-Jan-19
POWER SUPPLY	6031A	2430A00146	09-Apr-18	09-Apr-19
CHAMBER	SH-641	92009188	3-Apr-18	3-Apr-19
N to N RF Cable # 1	M17/128-RG400	NA	NA	NA
BNC to N RF Cable # 1	RG 58	NA	NA	NA
BNC to BNC RF Cable # 1	RG 58	NA	NA	NA
BNC to BNC RF Cable # 2	RG 58	NA	NA	NA
BNC to BNC RF Cable # 3	RG 58	NA	NA	NA
BNC to BNC RF Cable # 4	RG 58	NA	NA	NA
BNC to BNC RF Cable # 5	RG 58	NA	NA	NA
BNC to BNC RF Cable # 6	RG 58	NA	NA	NA
BNC to BNC RF Cable # 7	RG 58	NA	NA	NA
N to SMA RF Cable # 1	RG 58	NA	NA	NA
N to SMA RF Cable # 2	RG 58	NA	NA	NA
N to SMA RF Cable # 3	RG 58	NA	NA	NA
Aeroflex Attenuator 30dB	49-30-34-LIM	NA	NA	NA

FCC Transient ATE #1: (SW version: FCC Transient ATE_R1.1.2)

Description	Model	Serial Number	Calibration Date	Calibration Due Date
POWER SUPPLY	6032A	2818A03549	11-Jul-18	11-Jul-19
POWER SENSOR	E4412A	MY41498918	29-Jul-18	29-Jul-19
POWER METER	E4416A	GB41293240	2-Mar-18	2-Mar-19
ATTENUATORS/SWITCH DRIVER	11713A	2508A10141	CNR	CNR
STEP ATTENUATOR/11dB	8494G	MY42143006	16-Apr-18	16-Apr-19
STEP ATTENUATOR/110dB	8496G	MY421430125	16-Apr-18	16-Apr-19
OSCILLOSCOPE	MSO8104A	MY45002372	26-Jun-18	26-Jun-19
AUDIO ANALYZER	8903B	3729A17409	18-Jul-18	18-Jul-19
AUDIO ANALYZER	8903B	3413A14586	7-Jul-18	7-Jul-19
MODULATION ANALYZER	8901B	3403A04772	31-Mar-18	31-Mar-19
SIGNAL GENERATOR	8657A	3039A3205	5-Jul-18	5-Jul-19
SPECTRUM ANALYZER	E4440A	MY46185415	16-Aug-17	16-Aug-19
N to N RF Cable # 1	SF126/11N/11N	NA	NA	NA
N to N RF Cable # 2	M17/128-RG400	NA	NA	NA
N to N RF Cable # 3	M17/128-RG400	NA	NA	NA
N to N RF Cable # 4	M17/128-RG400	NA	NA	NA
N to N RF Cable # 5	M17/128-RG400	NA	NA	NA
N to N RF Cable # 6	M17/128-RG400	NA	NA	NA
N to N RF Cable # 7	M17/128-RG400	NA	NA	NA
N to N RF Cable # 8	M17/128-RG400	NA	NA	NA
N to N RF Cable # 9	M17/128-RG400	NA	NA	NA
BNC to BNC RF Cable # 1	RG 58	NA	NA	NA
BNC to BNC RF Cable # 2	RG 58	NA	NA	NA
BNC to BNC RF Cable # 3	RG 58	NA	NA	NA
BNC to BNC RF Cable # 4	RG 58	NA	NA	NA
BNC to BNC RF Cable # 5	RG 58	NA	NA	NA
BNC to BNC RF Cable # 6	RG 58	NA	NA	NA
BNC to N RF Cable # 1	RG 58	NA	NA	NA
Aeroflex Attenuator 10dB	49-10-43-LIM	NA	NA	NA
Aeroflex Attenuator 10dB	33-10-34-LIM	NA	NA	NA
SWITCH CONTROL UNIT	3488A	2719A36210	CNR	CNR

CONDUCTED SPUR EMISSION ATE # 1 (SW version: Conducted Spur ATE rev 1.23.02)

Description	Model	Serial Number	Calibration Date	Calibration Due Date
SWITCH CONTROL UNIT	3488A	2719A32735	CNR	CNR
PSA Series Spectrum Analyzer	E4445A	MY46181732	16-Feb-17	16-Feb-19
POWER SUPPLY	6032A	3232A08203	9-Apr-18	9-Apr-19
HIGH PASS FILTER SWITCH BOX	-	CS001	5-Jul-18	5-Jul-19
N to N RF Cable # 1	SF126/11N/11N	NA	NA	NA
N to N RF Cable # 2	SF126/11N/11N	NA	NA	NA
BNC to BNC RF Cable # 1	RG 58	NA	NA	NA
Aeroflex Attenuator 30dB	49-30-43-LIM	NA	NA	NA
Aeroflex Attenuator 10dB	33-10-34-LIM	NA	NA	NA
Vector Signal Generator	SMU200A	103537	22-Jul-17	22-Jul-20

EMC Chamber 1

DESCRIPTION	MODEL	SERIAL NUMBER	CALIBRATION DATE	CALIBRATION DUE DATE
DRG HORN FREQ.	SAS-571	719	18-Jul-17	18-Jul-19
DRG HORN FREQ.	SAS-571	720	2-Mar-17	2-Mar-19
POWER SUPPLY	6032A	2615A-01178	13-Jun-18	13-Jun-19
MICROWAVE SIGNAL GENERATOR	SMP04	100131	12-Jul-18	11-Jul-19
EMI TEST RECEIVER	ESIB26	100017	11-Apr-18	11-Apr-19
EMI TEST RECEIVER	ESW44	101750	25-Jun-18	25-Jun-19
5m Semi-anechoic Chamber	S800-HX	J2308	CNR	CNR
BILOG ANTENNA	CBL6112D	30991	23-Apr-18	23-Apr-19
BILOG ANTENNA	CBL6112B	2964	16-Feb-18	16-Feb-20
DATA LOGGER	SDL500	A.016776	18-Mar-17	18-Mar-19
SYSTEM CONTROLLER	SC104V	050806-1	CNR	CNR
TURNTABLE FLUSH MOUNT 2M	FM2011	NA	CNR	CNR
ANTENNA POSITIONING TOWER	TLT2	NA	CNR	CNR
18 - 40GHz PREAMPLIFIER	Miteq Hi Gain Sucoflex	002	CNR	CNR
PREAMPLIFIER	PAM-0118P	361	CNR	CNR
Test Software	EMC_FCC_IC_Bluetooth_RE_Test			
Version	EMC_FCC_RE_v1.5.1			

CNR → Calibration Not Require

5.0 Test Condition

5.1 Transmitter Test Conditions

Test Item, (Channel Spacing)	Power (W)	Modulation	Test Frequency (MHz)	Tested By
RF Output Power	Low & Max	Analog	806.0125, 814.9875, 823.9875, 851.0125, 860.0125, 868.8875	Khor Wei Loong
Frequency Stability	Max	Analog	823.9875	Khor Wei Loong
Audio Frequency Response (12.5kHz / 25kHz)	Max	Analog	823.9875	Khor Wei Loong
Audio Low Pass Filter Response (12.5kHz / 25kHz)	Max	Analog	823.9875	Khor Wei Loong
Modulation limiting (12.5kHz / 25kHz)	Max	Analog	823.9875	Khor Wei Loong
Occupied Bandwidth (12.5kHz / 25kHz)	Max	Analog	806.0125, 814.9875, 853.9875, 823.9875, 851.0125, 860.0125, 868.8875	Khor Wei Loong
Band Edge Conducted Spurious Emissions (Part 22) (12.5kHz / 20kHz / 25kHz)	Max	Analog	NA	Khor Wei Loong
Transient Frequency Behavior (UHF & VHF Band) (12.5kHz / 25kHz)	Max	Analog	NA	Khor Wei Loong
Adjacent Channel Power (700MHz Band) (12.5kHz)	Max	Analog	NA	NA
Conducted Spurious Emissions- (12.5kHz / 25kHz)	Low / Max	Analog	806.0125, 814.9875, 823.9875, 851.0125, 860.0125, 868.8875	Khor Wei Loong
Radiated Spurious Emission (12.5kHz / 25kHz)	Low / Max	Analog	806.0125, 814.9875, 823.9875, 851.0125, 860.0125, 868.8875	Nazrin & Qawiman
GNSS (EIRP for 1559 - 1610MHz) (12.5kHz / 25kHz)	Max	Analog	NA	NA
Effective Radiated Power (ERP) (12.5kHz / 25kHz)	Max	Analog	NA	NA

NA → Not Applicable

6.0 Transmitter Test Parameters

6.1. RF Output Power

6.1.1. Test Setup

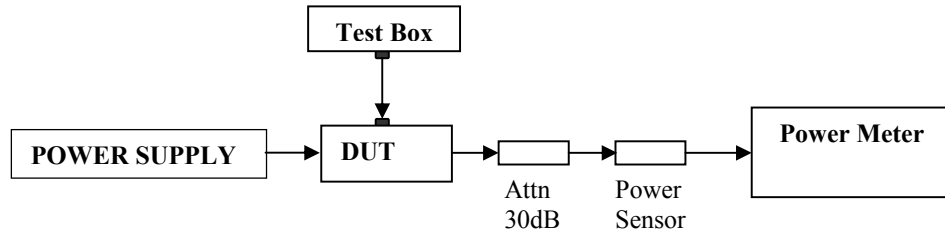

- 1) The DUT transmitter connected to Power Meter using the 30 dB attenuator and power sensor with above setup.
- 2) Path loss for the measurement included.
- 3) All the measurement was done at low, mid, high frequency for each band.
- 4) Record the power into the test report.

6.1.2. Test Result

Temperature	25°C				Remarks
Voltage (V)	7.5V				
Frequency (MHz)	Low Power (W)	Current (A)	Max Power (W)	Current (A)	
806.0125	0.998	0.73	3.57	1.20	
814.9875	0.993	0.70	3.55	1.21	
823.9875	0.999	0.80	3.58	1.19	
851.0125	0.995	0.78	3.58	1.21	
860.0125	0.998	0.78	3.59	1.20	
868.8875	0.998	0.76	3.58	1.23	

6.2. Frequency Stability

6.2.1. Test Setup

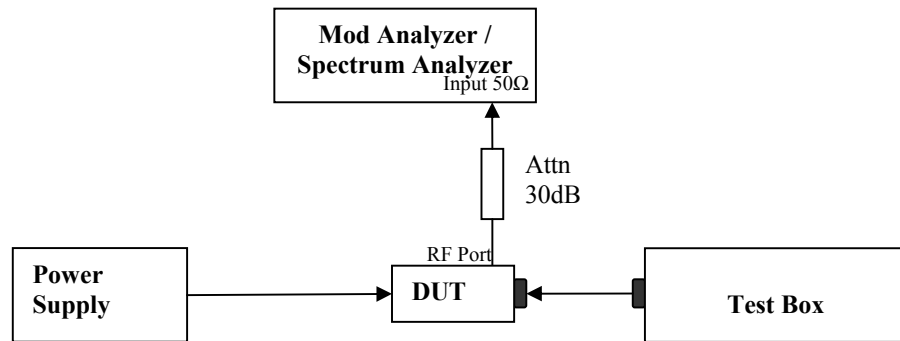

- 1) The DUT transmitter output port was connected to Modulation / Spectrum Analyzer.
- 2) Path loss for the measurement included.
- 3) Transmit the DUT and record the freq in MCF_{MHz} .
- 4) Test in 2 conditions:
 - Temperature: The frequency of the transmitter was measured from $-30^{\circ}C$ to $50^{\circ}C$.
 - Supply Voltage:
 - Mobile: The frequency of the transmitter was measured from 85% to 115% of the nominal operating input voltage.
 - Portable: The frequency of the transmitter was measured from nominal $\pm x\%$ as specified by the manufacturer
- 5) Calculate the ppm frequency error by the following:

$$ppm\ error = \left(\frac{MCF_{MHz}}{ACF_{MHz}} - 1 \right) * 10^6$$

Where: MCF_{MHz} is the Measured Carrier Frequency in MHz
 ACF_{MHz} is the Assigned Carrier Frequency in MHz

6.2.2. Test Result

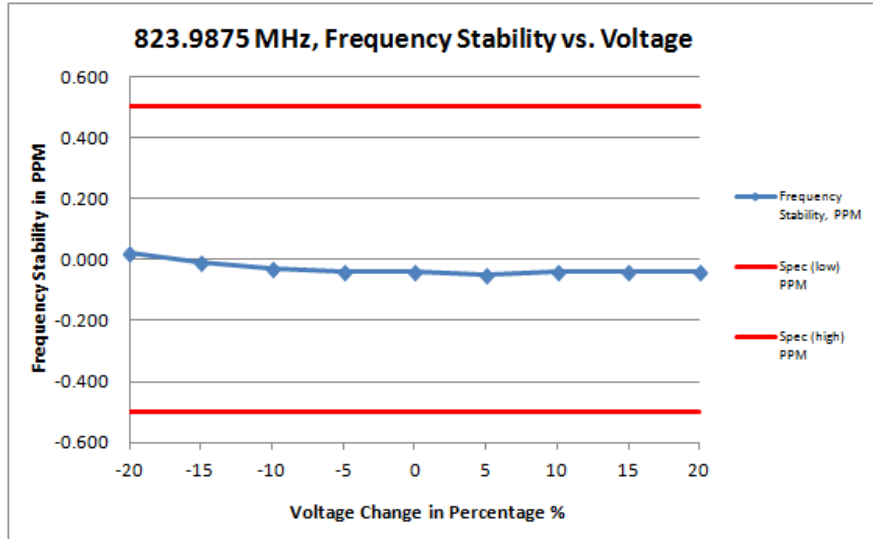

Frequency / Channel Spacing	823.9875 MHz / 12.5 kHz				
Temperature, °C	25				
Voltage %	Voltage, V	Frequency, MHz	Frequency Stability, PPM	Spec (low) PPM	Spec (high) PPM
-20	6.000	823.987516	0.020	-0.500	0.500
-15	6.370	823.987492	-0.010	-0.500	0.500
-10	6.750	823.987475	-0.030	-0.500	0.500
-5	7.120	823.987467	-0.040	-0.500	0.500
0	7.500	823.987467	-0.040	-0.500	0.500
5	7.870	823.987459	-0.050	-0.500	0.500
10	8.250	823.987467	-0.040	-0.500	0.500
15	8.620	823.987467	-0.040	-0.500	0.500
20	9.000	823.987467	-0.040	-0.500	0.500

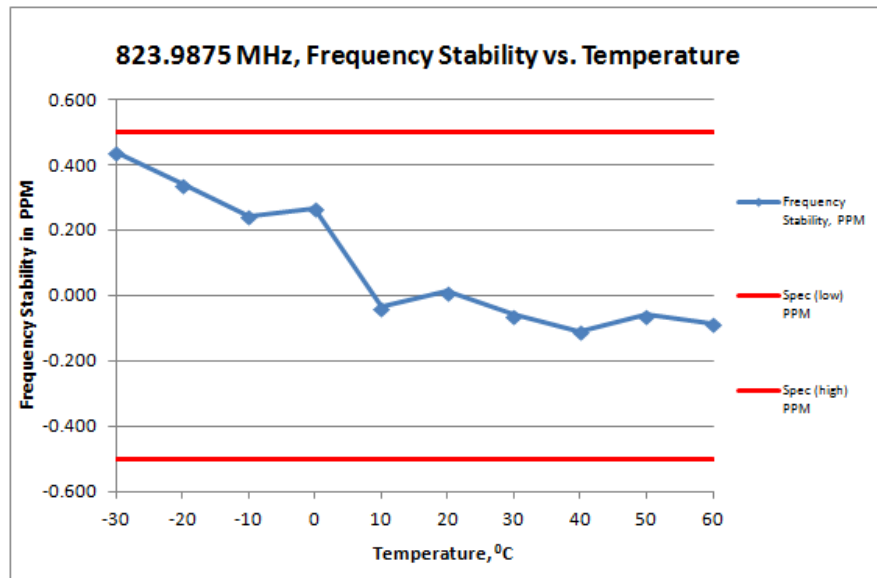

Frequency / Channel Spacing	823.9875 MHz / 12.5 kHz			
Voltage, V	7.5			
Temperature, °C	Frequency, MHz	Frequency Stability, PPM	Spec (low) PPM	Spec (high) PPM
-30	823.987980	0.437	-0.500	0.500
-20	823.987780	0.340	-0.500	0.500
-10	823.987700	0.243	-0.500	0.500
0	823.987720	0.267	-0.500	0.500
10	823.987470	-0.036	-0.500	0.500
20	823.987510	0.012	-0.500	0.500
30	823.987450	-0.061	-0.500	0.500
40	823.987410	-0.109	-0.500	0.500
50	823.987450	-0.061	-0.500	0.500
60	823.987430	-0.085	-0.500	0.500

6.2.3. Test Limit

As per manufacturer declared spec +/- 0.5ppm

6.3. Audio Frequency Response

6.3.1. Test Setup

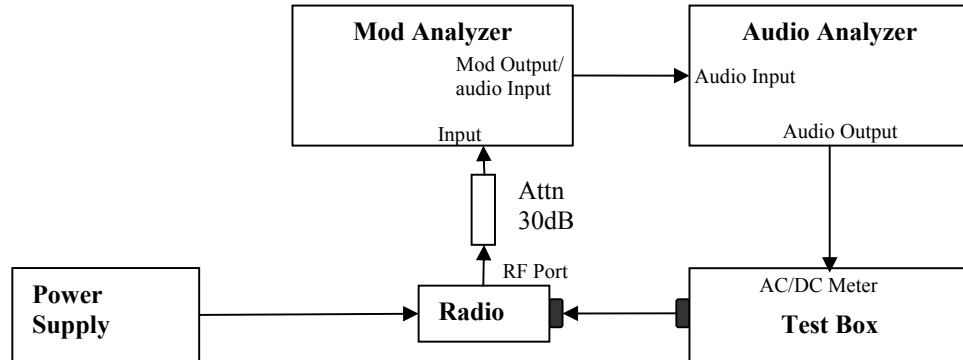

- 1) The DUT transmitter output port was connected to Modulation Analyzer.
- 2) Path loss for the measurement included.
- 3) Set the audio bandwidth filter to 15 kHz and 50 kHz.
- 4) Transmit the radio and set the audio analyzer to 1 kHz audio frequency and 20% of the Full rated system deviation.
- 5) On audio analyzer, set the rated level as reference to zero.
- 6) Vary the audio frequency from 300 Hz to 3 kHz. Record the change in dB on the audio analyzer.

6.3.2. Test Result

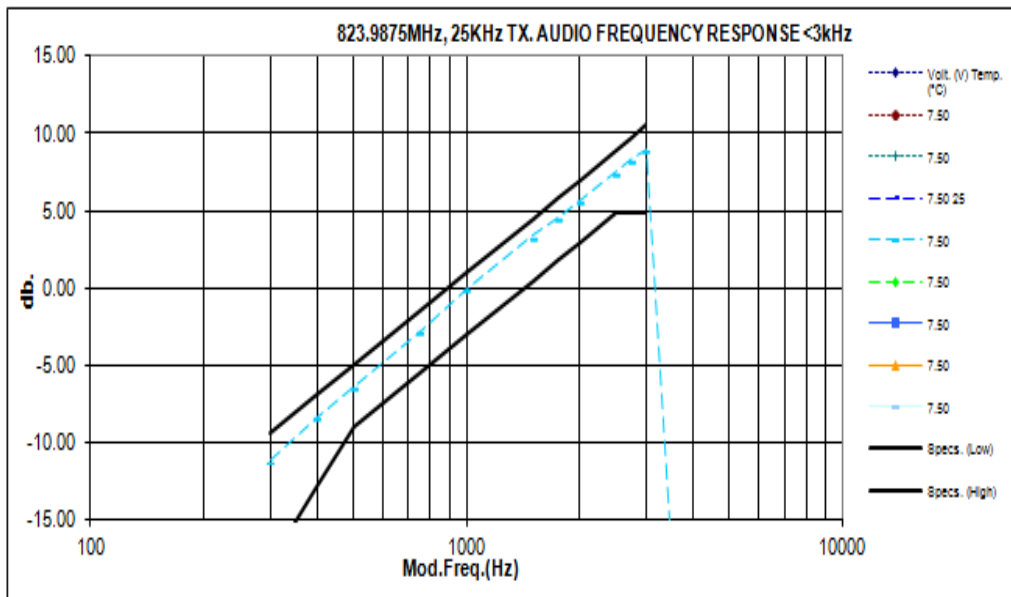
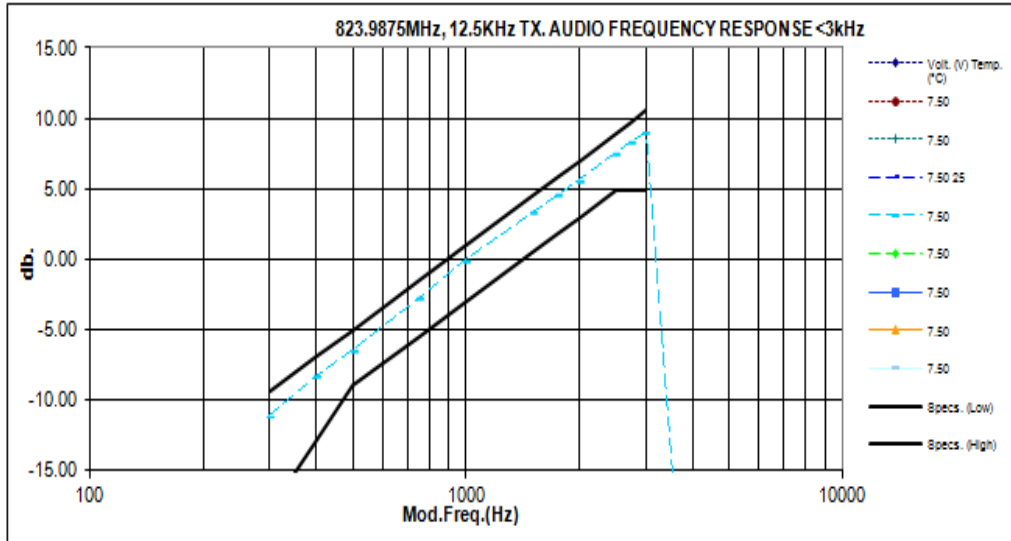

6.3.3. Test Limit

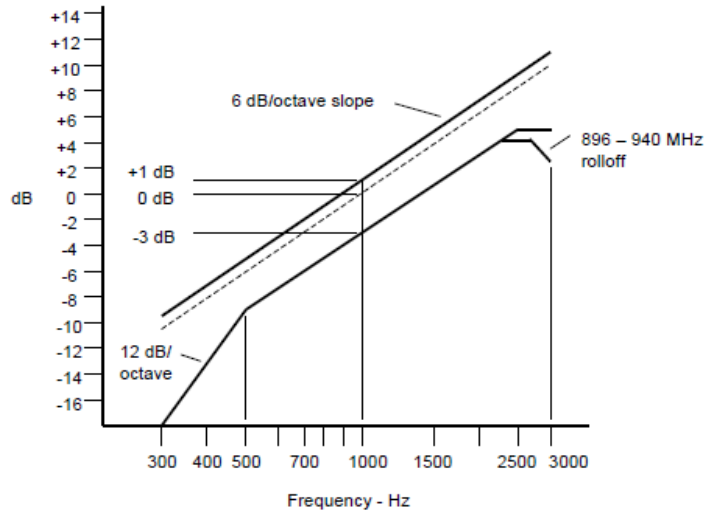

Note:

- o There are additional 6 dB per octave attenuation is allowed from 2.5KHz to 3KHz in equipment 25MHz to 869MHz radio.
- o Additional 6 dB per octave attenuation is allowed from 2.3KHz to 2.7KHz & additional 12 dB per octave attenuation is allowed from 2.7KHz to 3KHz in equipment 896MHz to 940MHz radio.

6.4. Audio Low Pass Filter Response

6.4.1. Test Setup

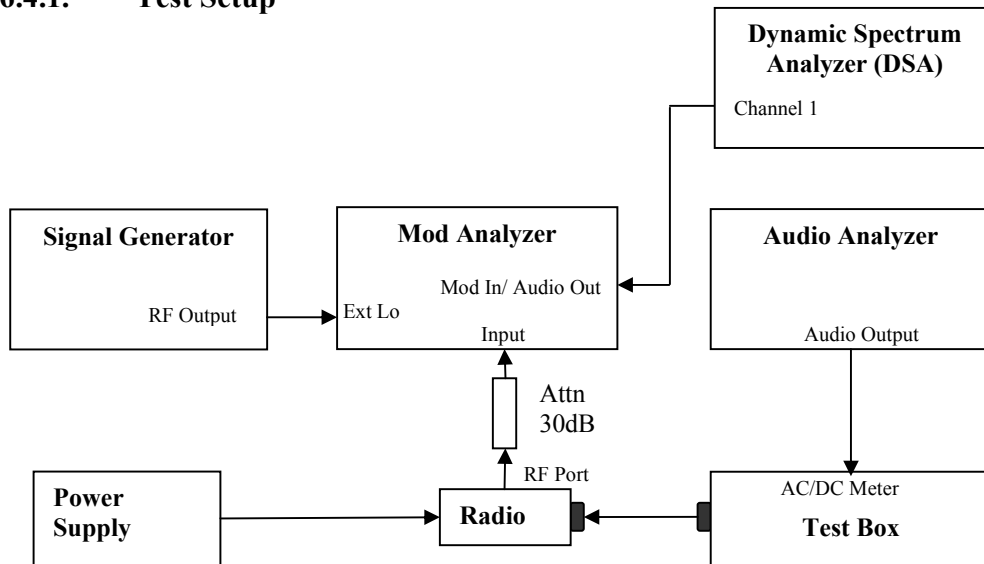

- 1) The DUT transmitter output port was connected to Modulation Analyzer.
- 2) Path loss for the measurement included.
- 3) Press 23.1SPCL on modulation analyzer to enable the external LO from Sigen.
- 4) Set the Sigen frequency to $F_c + 1.5$ MHz, RF output level to 0dBm without modulation.
- 5) Transmit the radio and set the audio analyzer to 1 kHz audio frequency and 60% of the Full rated system deviation.
- 6) Up the amplitude by 20dB.
- 7) On DSA, get the reference point to 0dB.
- 8) Vary the frequency on audio analyzer from 3 kHz to 20 kHz, record the audio tone from DSA.

6.4.2. Test Result

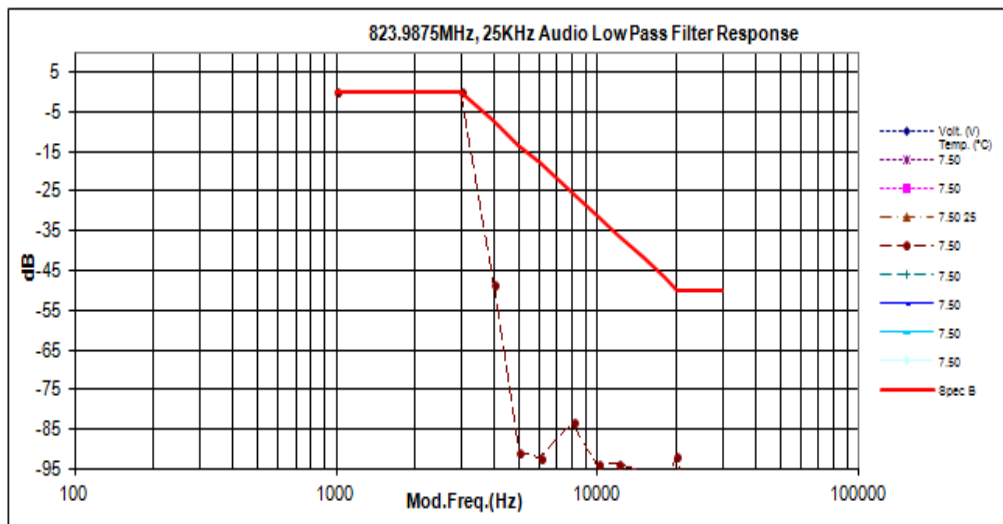
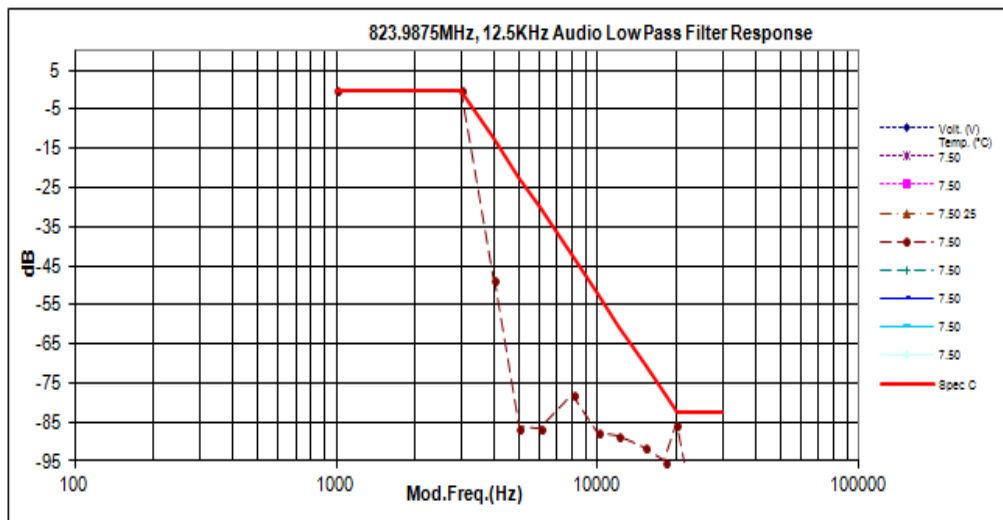

6.4.3. Test Limit

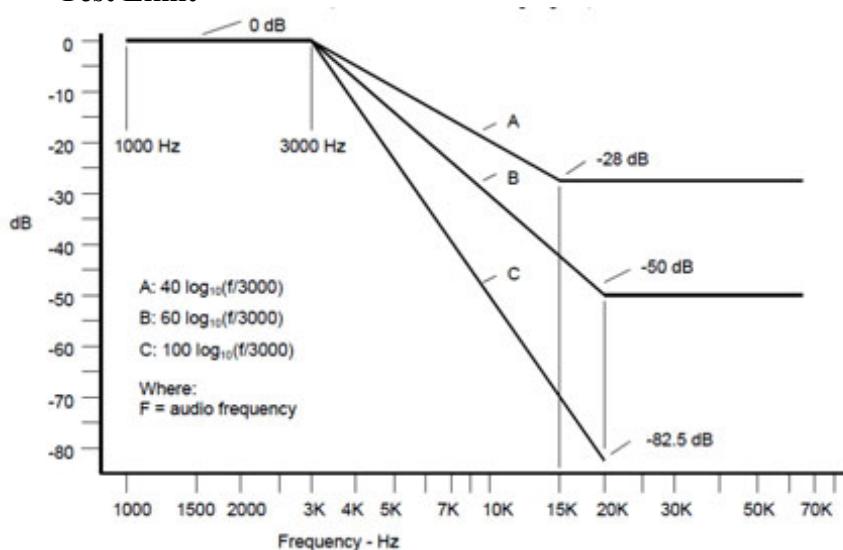

For audio frequencies above 3000 Hz, the audio response of the post limiter low-pass filter shall meet or exceed the following requirements:

- a) For equipment operating on 20, 25 or 30 kHz channel bandwidth in the 25 MHz to 174 MHz range:

At frequencies from 3000 Hz through 15,000 Hz the attenuation shall be greater than the attenuation at 1000 Hz by at least: $40 \log_{10}(f/3000)$ dB

where: f is the audio frequency in Hz.

At frequencies above 15,000 Hz, the attenuation shall be greater than the attenuation at 1000 Hz, by at least: 28 dB.

- b) For equipment operating with 25 kHz bandwidth channels between 406 and 512 MHz through 896 MHz, and between 929 MHz through 930 MHz:

At frequencies from 3000 Hz through 20,000 Hz, the attenuation shall be greater than the attenuation at 1000 Hz by at least: $60 \log_{10}(f/3000)$ dB

where: f is the audio frequency in Hz.

At frequencies above 20,000 Hz the attenuation shall be greater than the attenuation at 1000 Hz by at least: 50 dB.

- c) For equipment operating on channels between 896 MHz through 901 MHz, between 935 MHz through 940 MHz, and 12.5 or 15 kHz spaced channels in the frequency range 138-174 MHz and 406-512 MHz.

At frequencies from 3000 Hz through 20,000 Hz the attenuation shall be greater than the attenuation at 1000 Hz by at least: $100 \log_{10}(f/3000)$ dB

where: f is the audio frequency in Hz.

6.5. Modulation Limiting

6.5.1. Test Setup

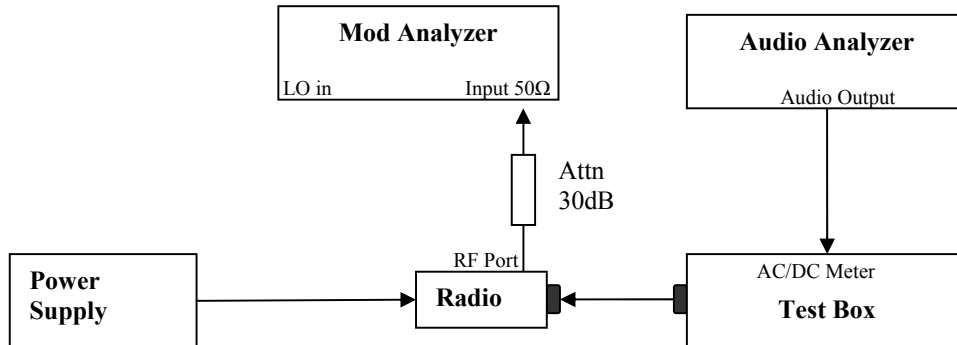

- 1) The DUT transmitter output port was connected to Modulation Analyzer.
- 2) Path loss for the measurement included.
- 3) Set the audio bandwidth filter to 15 kHz.
- 4) Transmit the radio and set the audio analyzer to 1 kHz audio frequency and 60% of the Full rated system deviation.
- 5) Record the frequency deviation as 0dB input level at 1kHz audio frequency.
- 6) Repeat the step and record the frequency deviation from -20 dB to 20dB by 5 dB increments and different audio freq 300 Hz, 2.5 kHz and 3 kHz.

6.5.2. Test Result

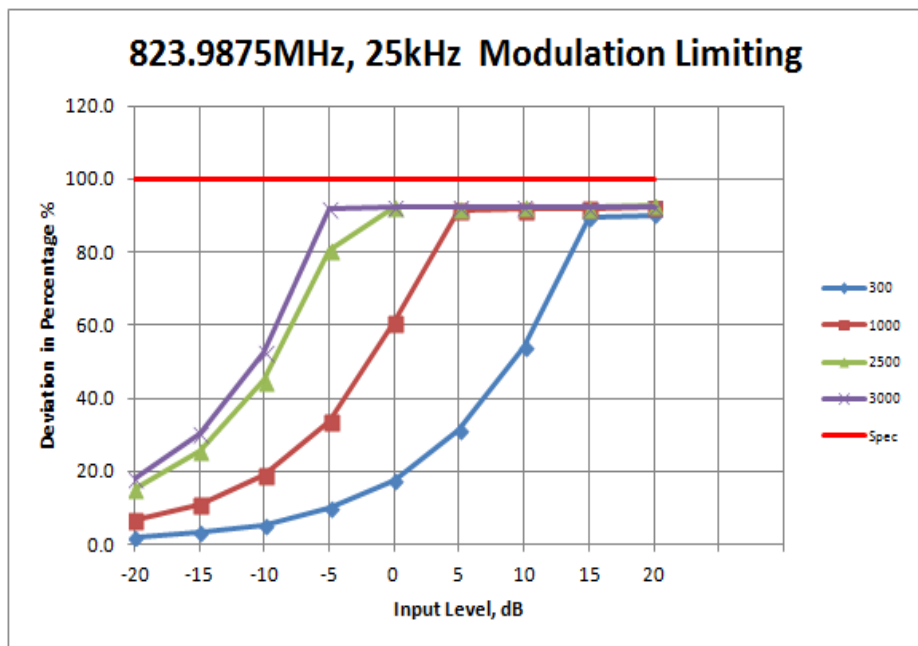
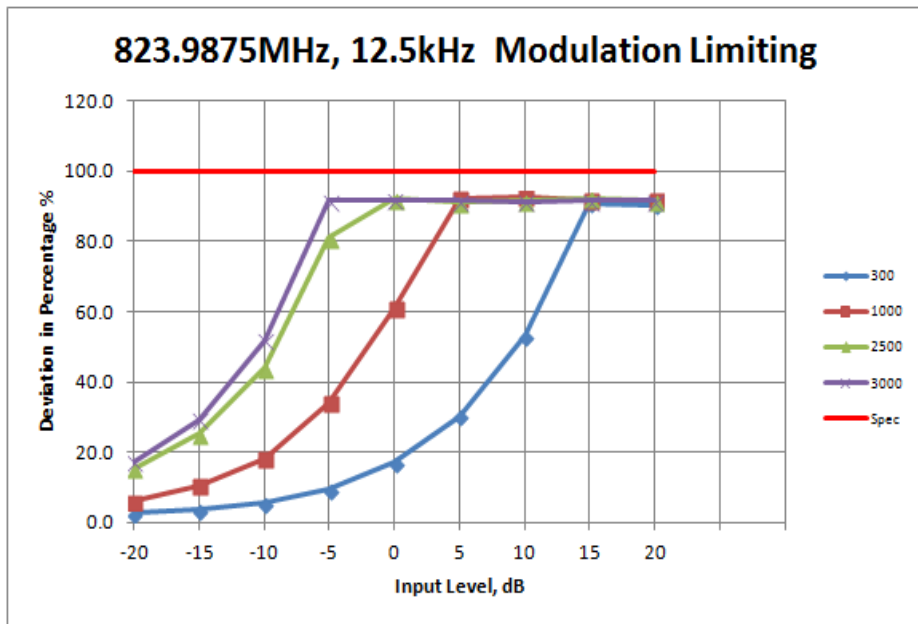

6.5.3. Test Limit

Modulation Limiting shall not exceed 100 percent.

6.6. Occupied Bandwidth

6.6.1. Test Setup (Analog)

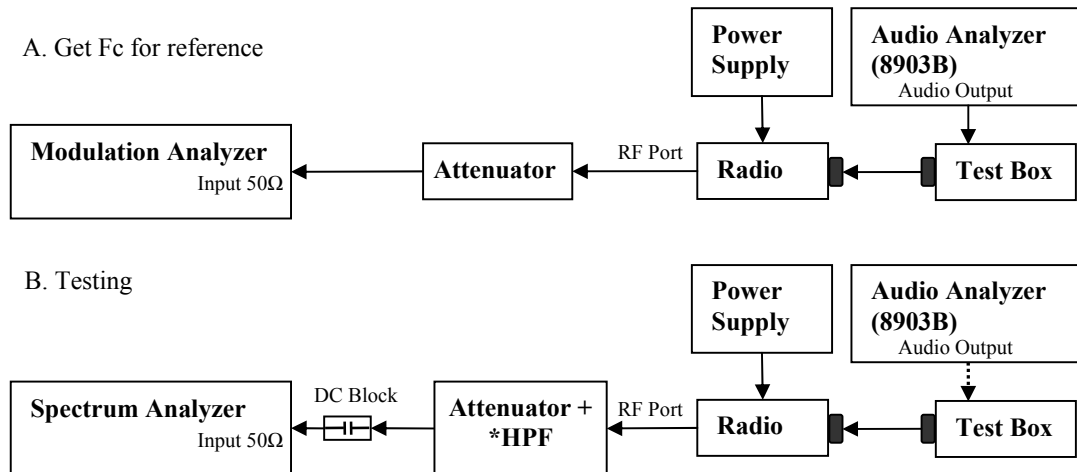

- 1) The DUT transmitter output port was connected to Modulation Analyzer.
- 2) Set the audio bandwidth filter to 15 kHz low pass filter and 50 kHz high pass filter.
- 3) Transmit the radio and set the audio analyzer to 2.5 kHz audio frequency and 50% of the rated deviation. Up the amplitude by 16 dB. Dekey the DUT.
- 4) Path loss for the measurement included.
- 5) Select the Occupied Bandwidth measurement for 99% Emissions Bandwidth Measurement.
- 6) Key in the Fc and Resolution Bandwidth (1 ~ 5 % of emission designator).
- 7) Transmit the DUT and record the occupied Bandwidth frequency.
- 8) Preset the spectrum analyzer for sideband spectrum measurement.
- 9) Set the span and Resolution Bandwidth (according to FCC/ ISED standard).
- 10) Save the screen shot as modulated signal
- 11) Remove the audio tone from audio analyzer to capture unmodulated signal.

* Only HPF added for Mask 80.211 measurement with attenuator.

6.6.2. Test Result (Analog)

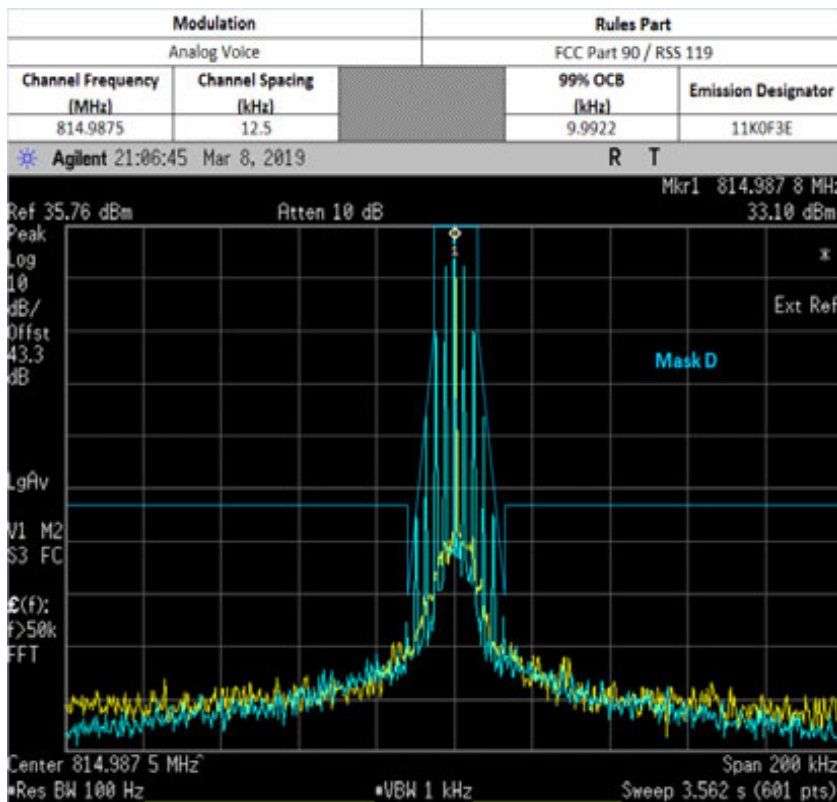
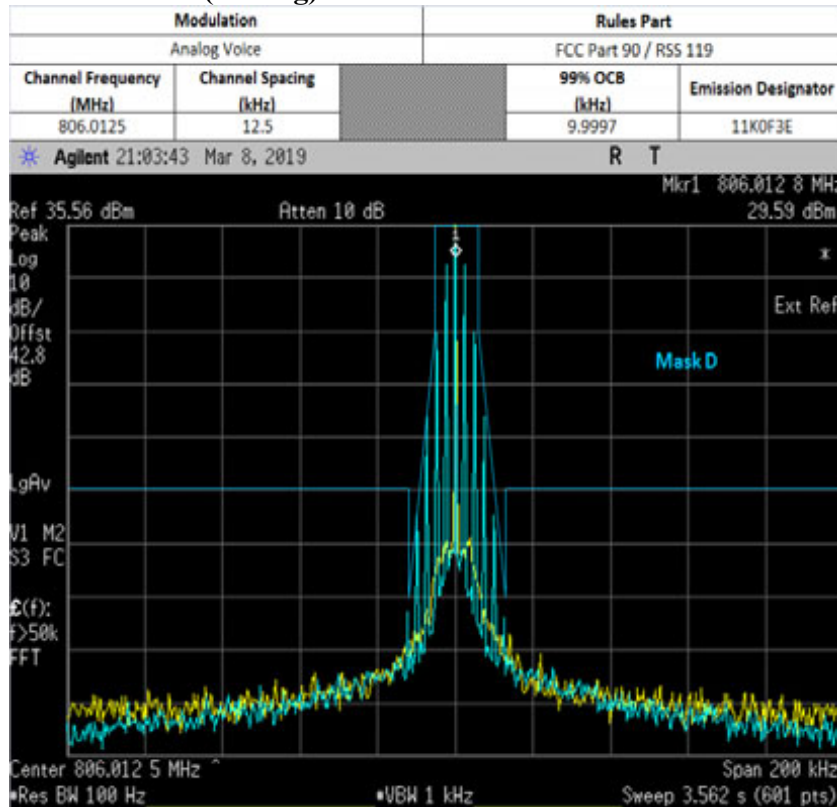

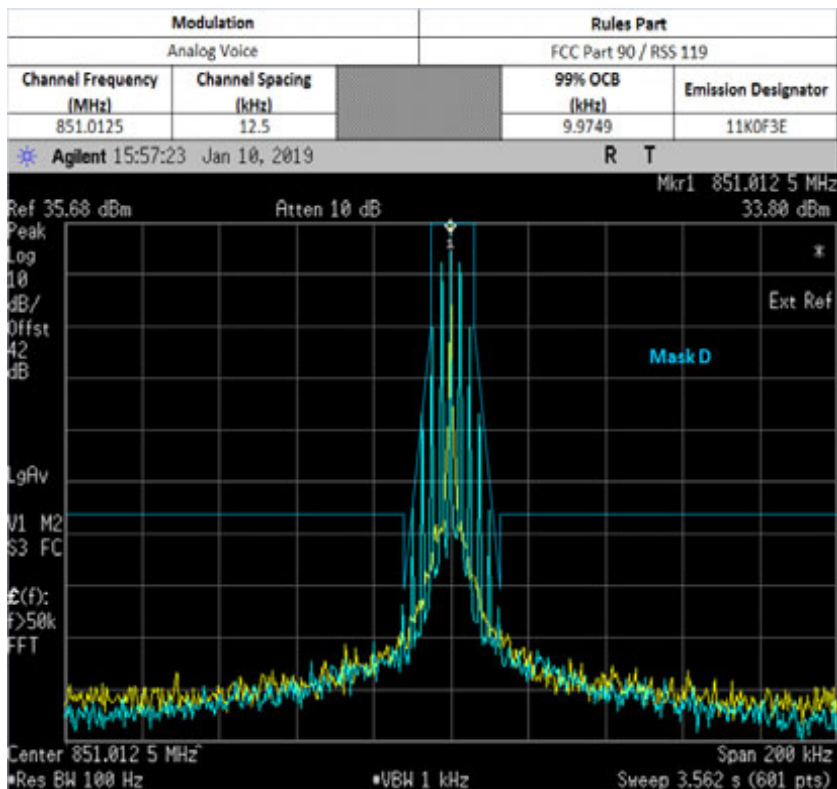
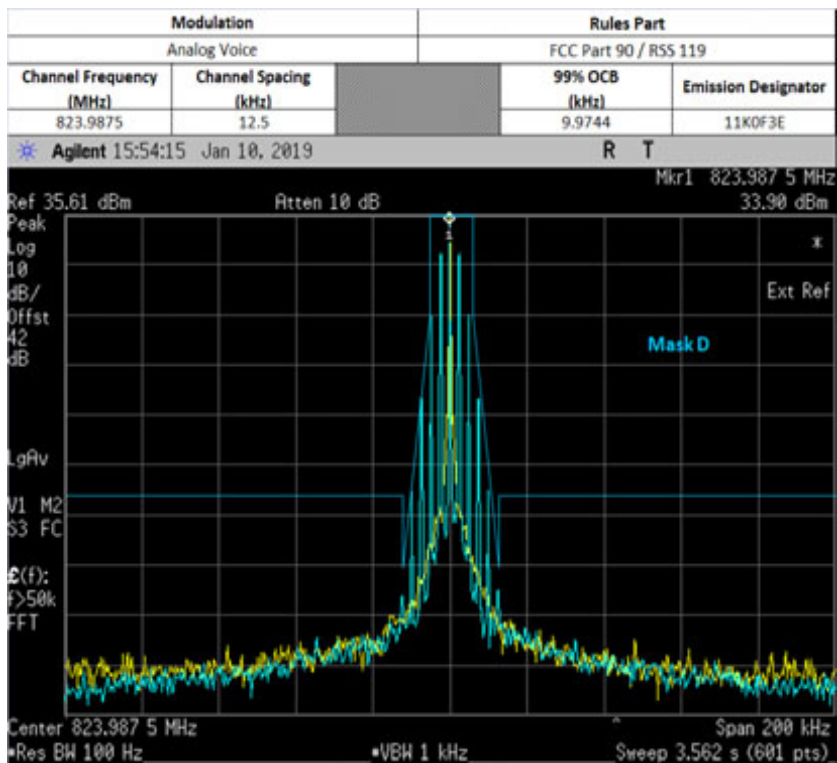

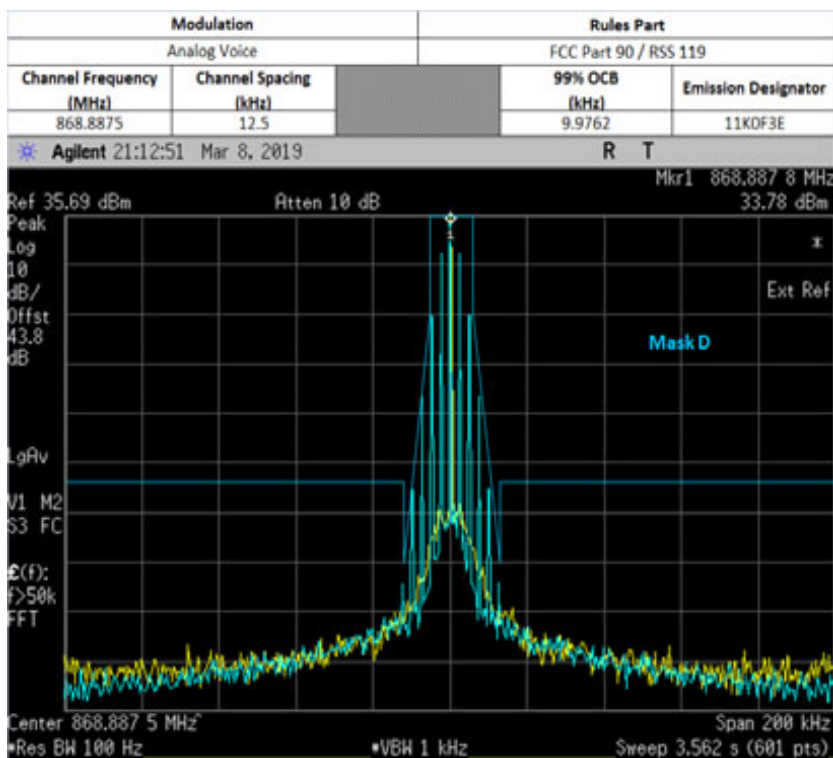
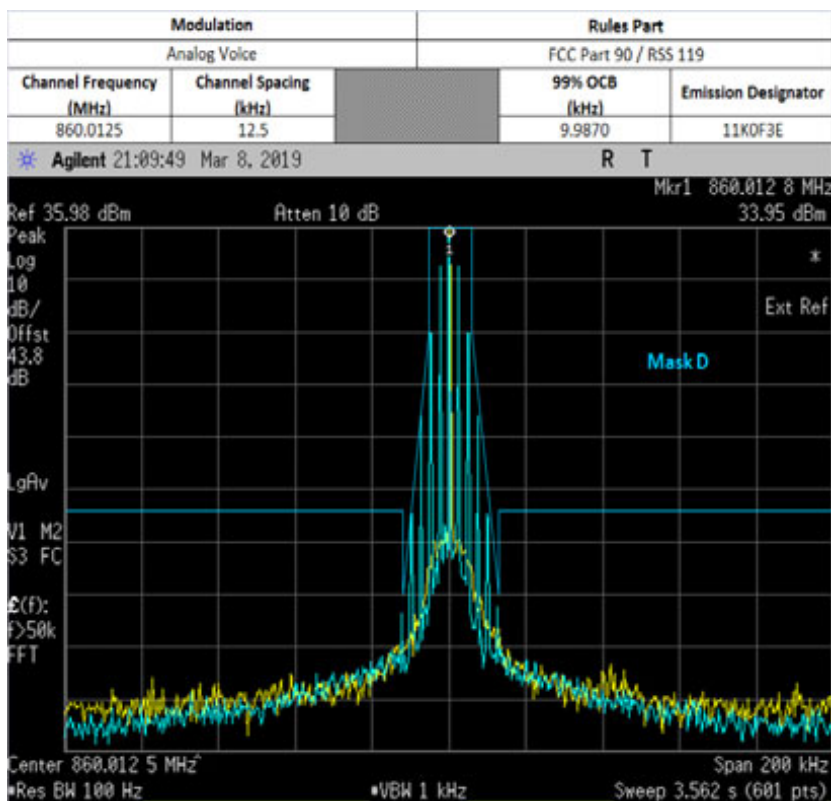

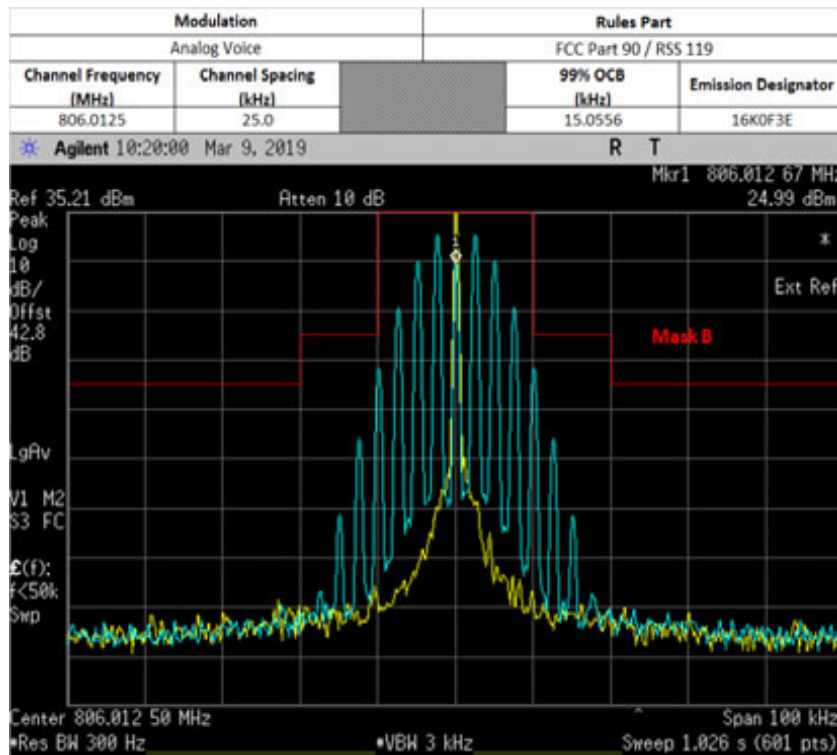

NOT FOR FCC REVIEW

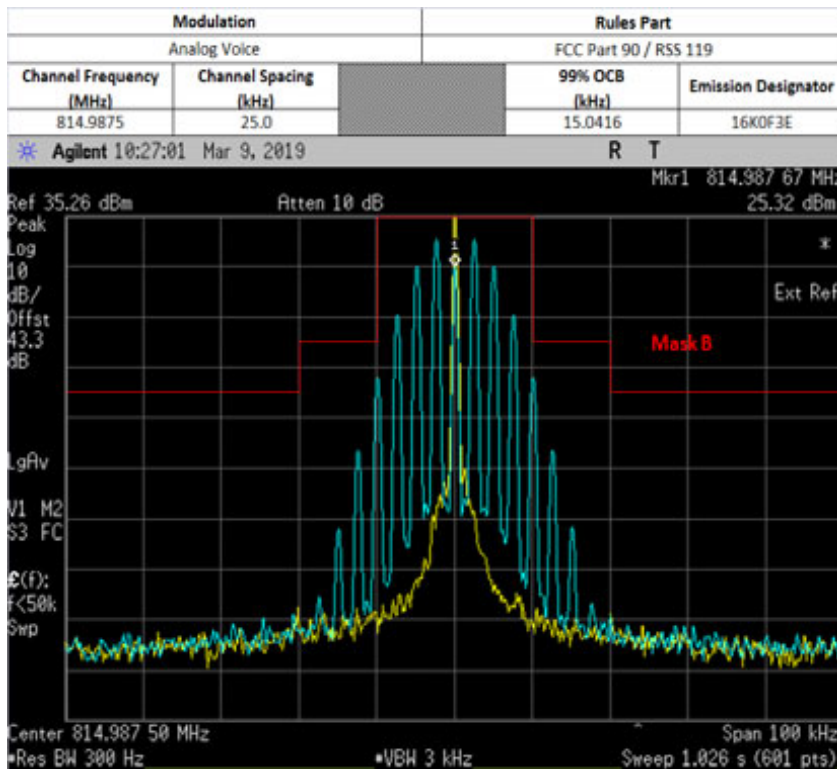

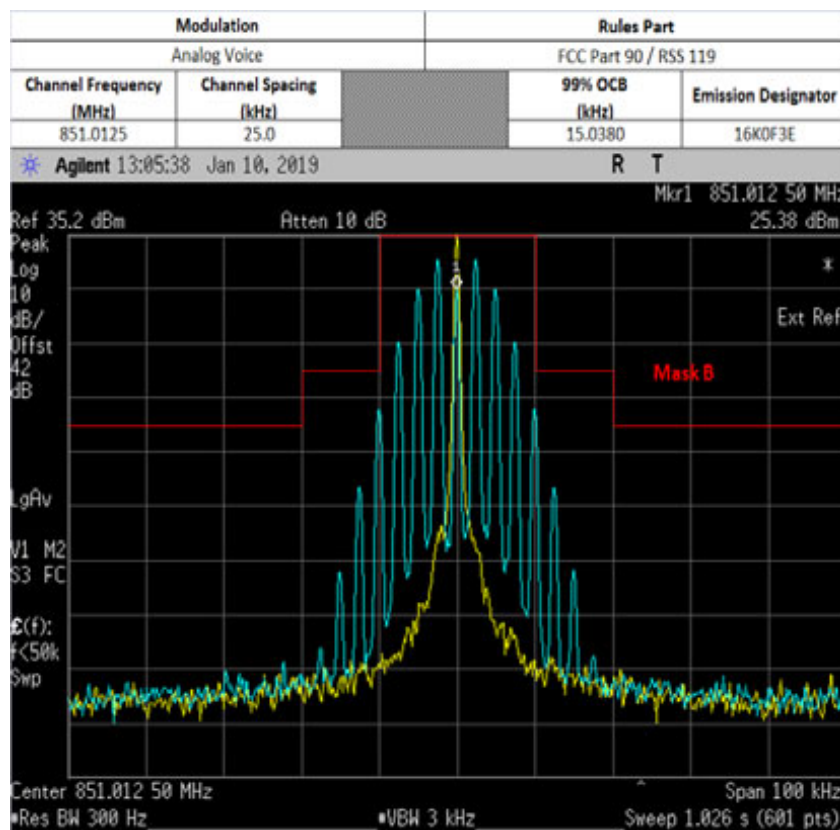
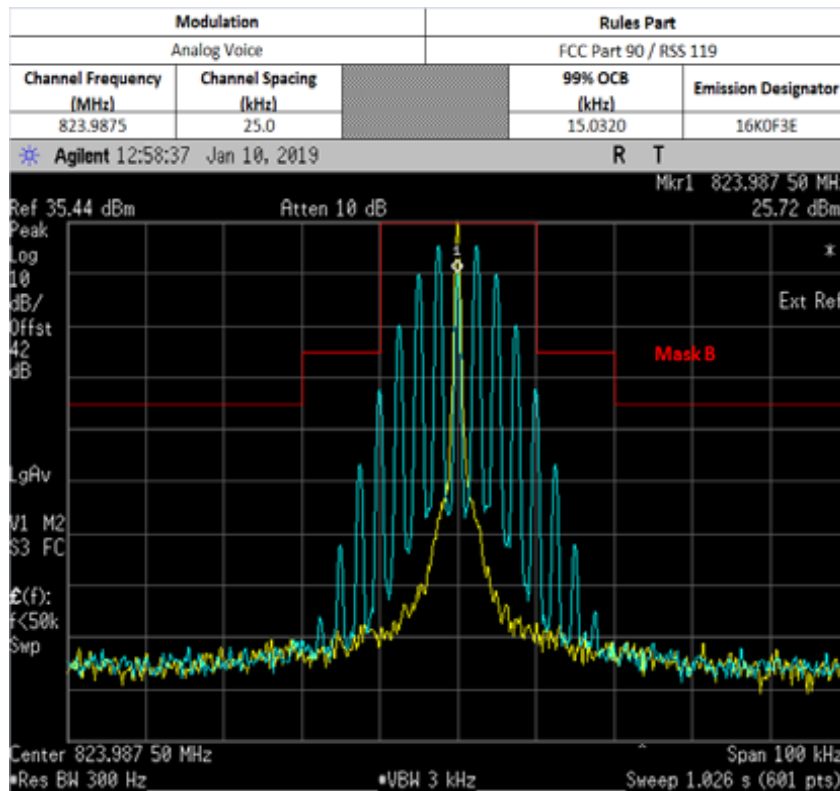

NOT FOR FCC REVIEW

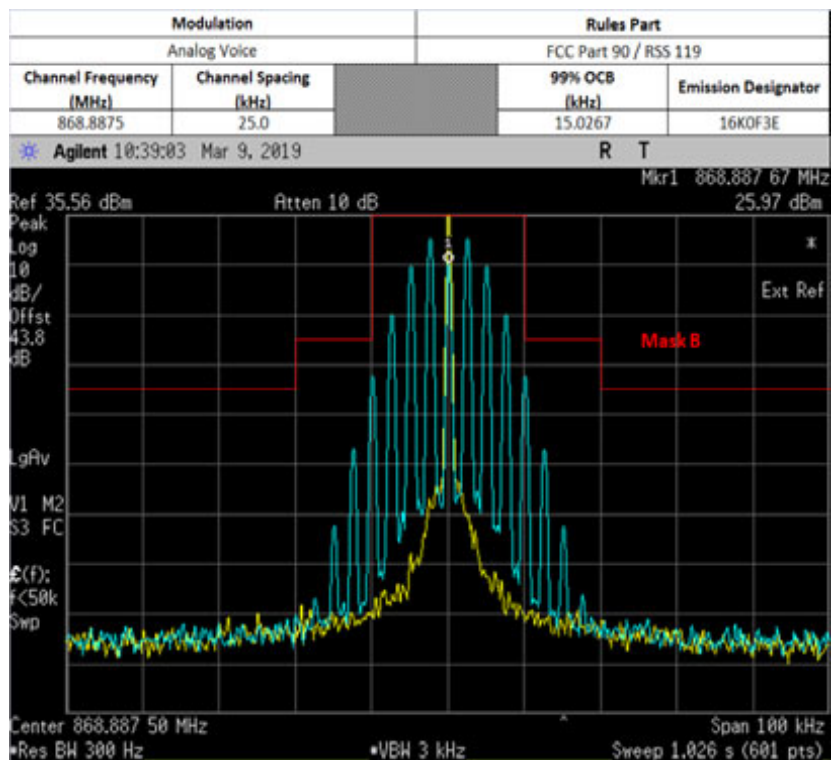
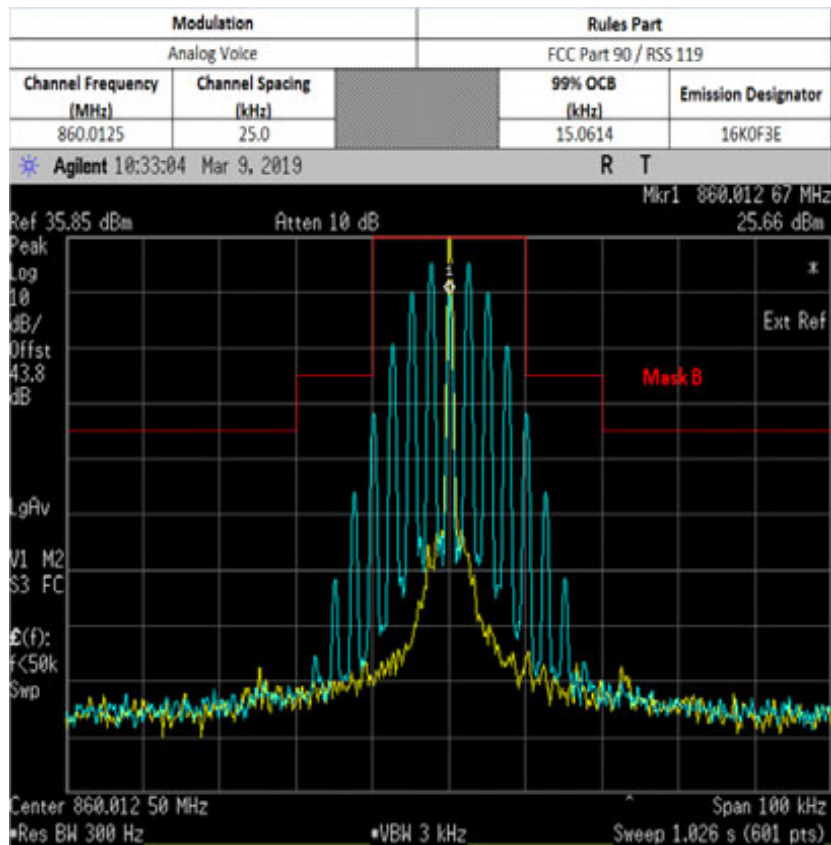

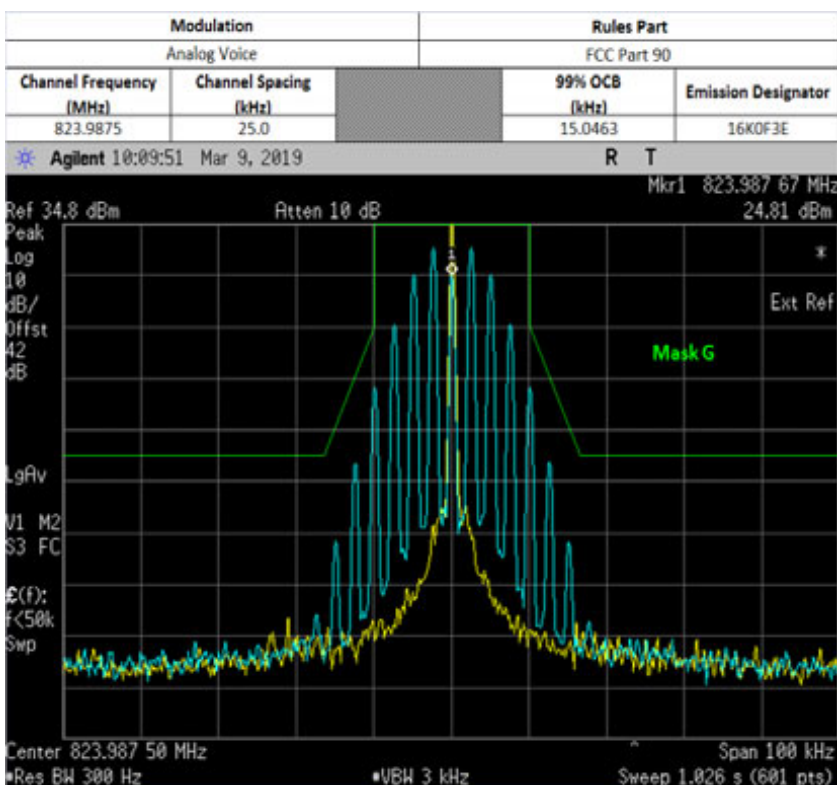
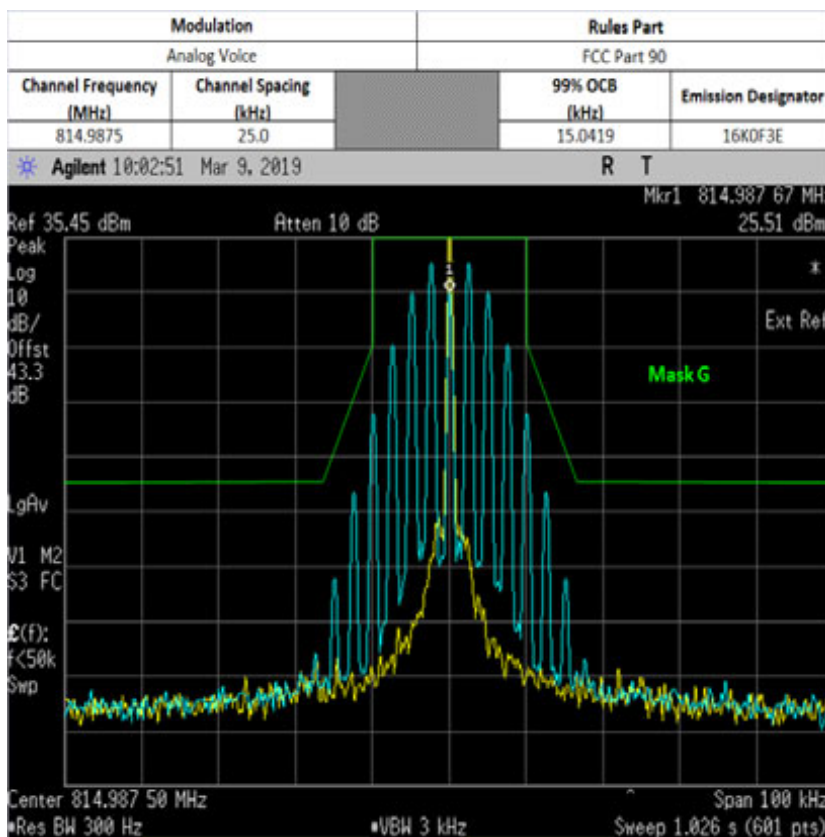

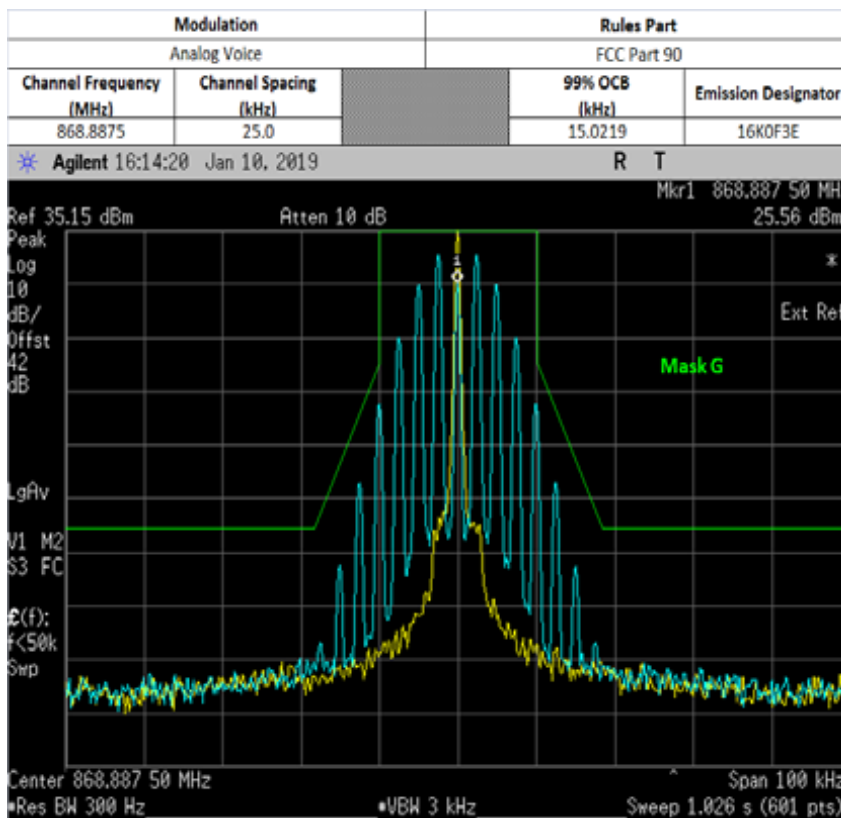
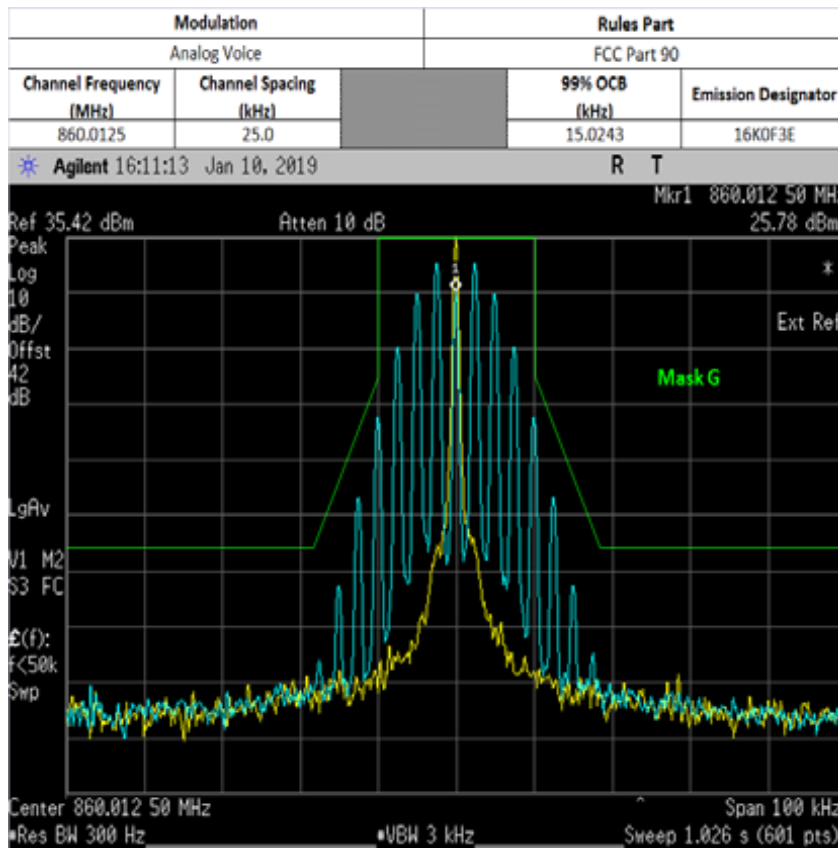

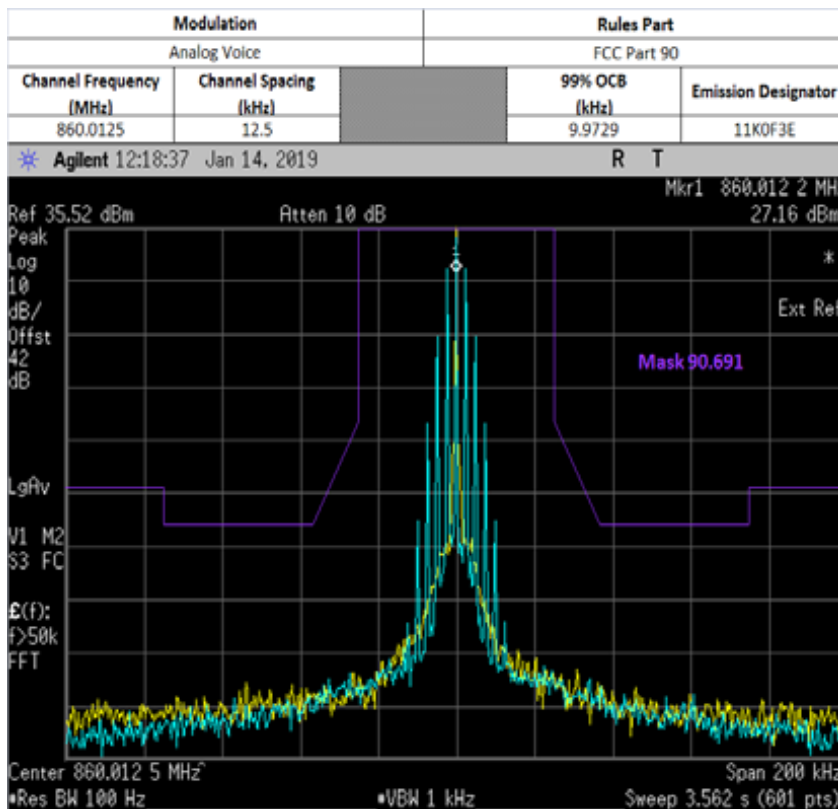
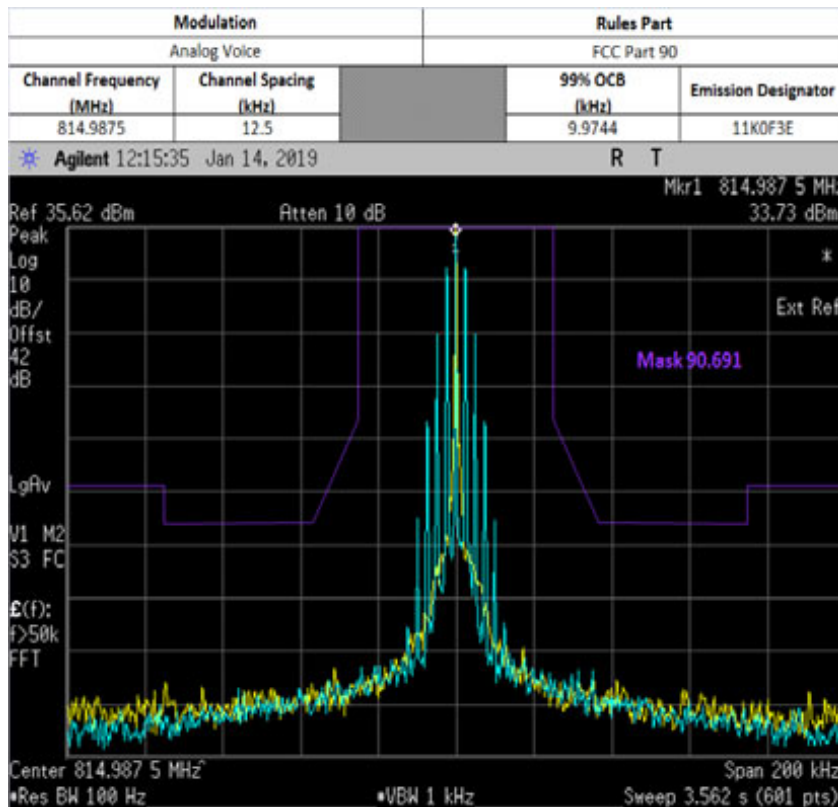

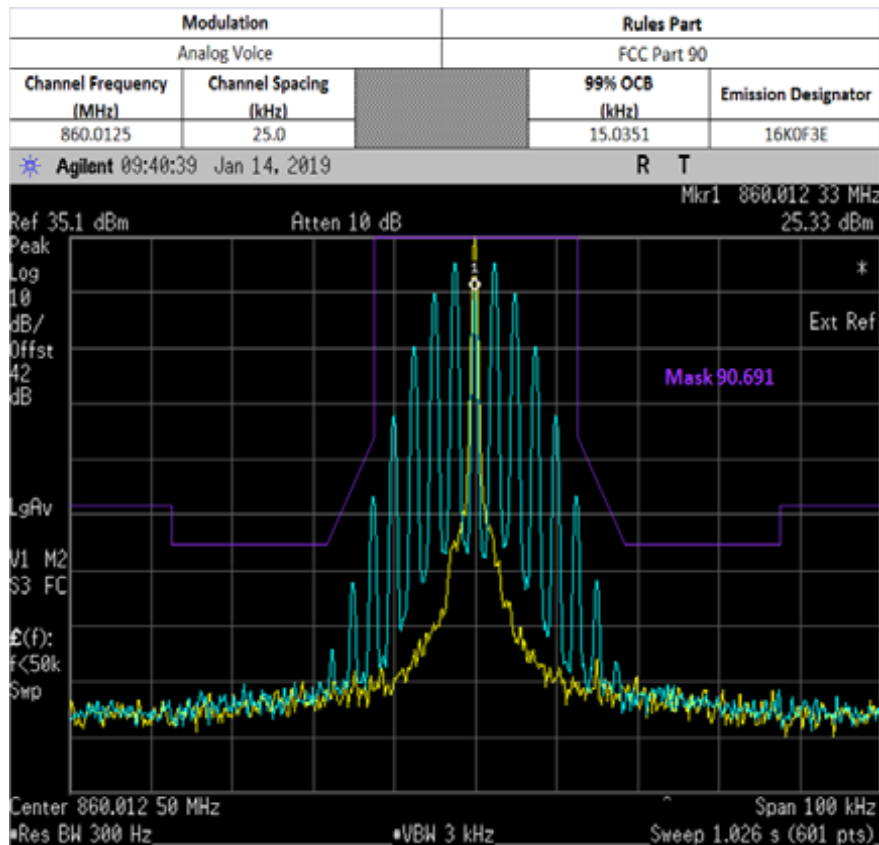
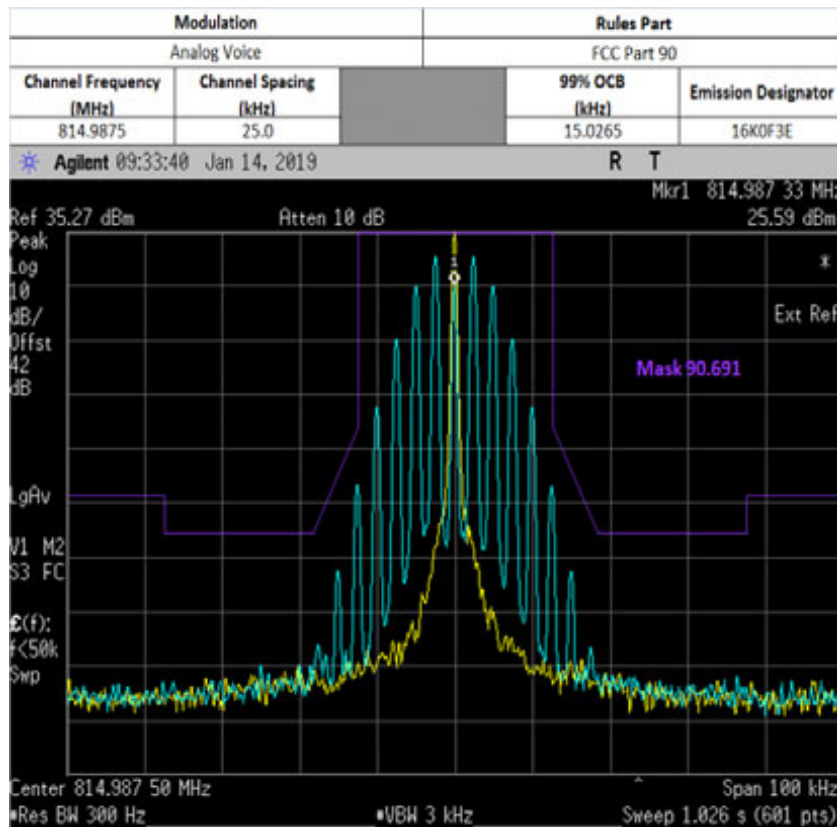

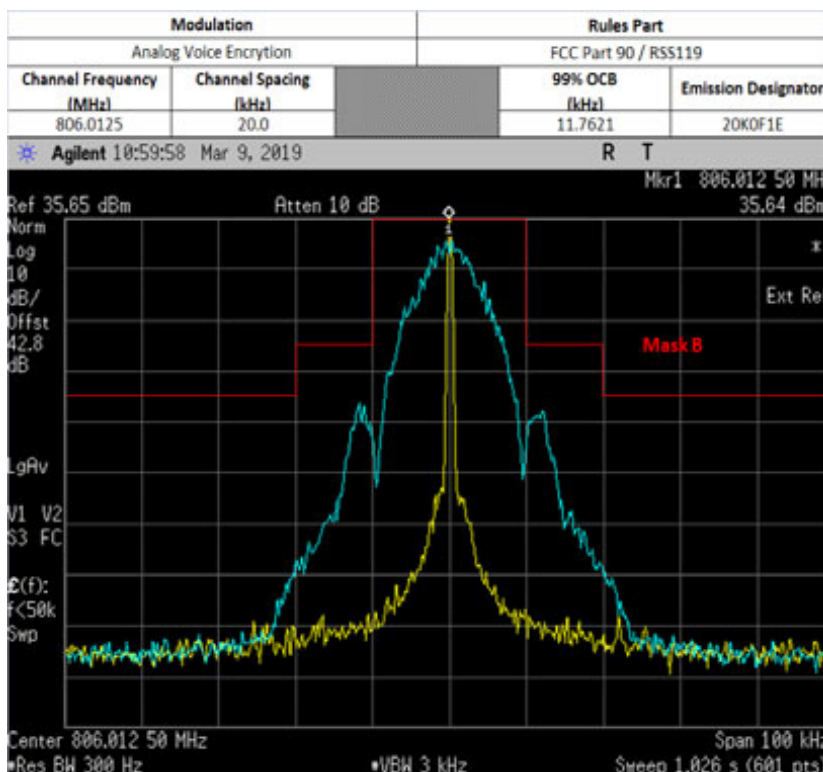

NOT FOR FCC REVIEW

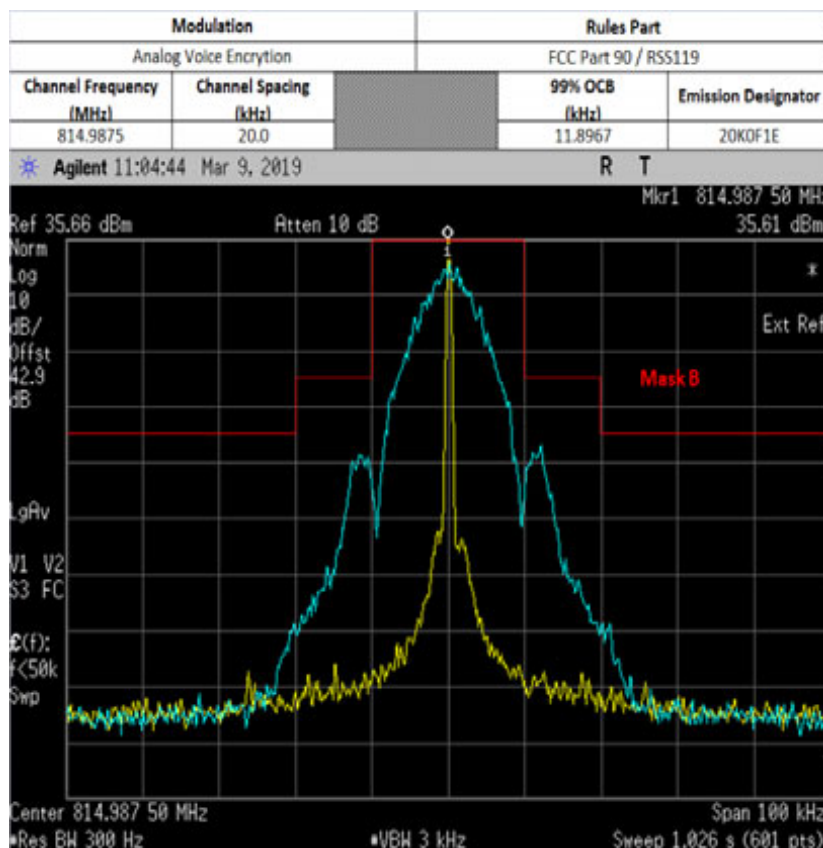

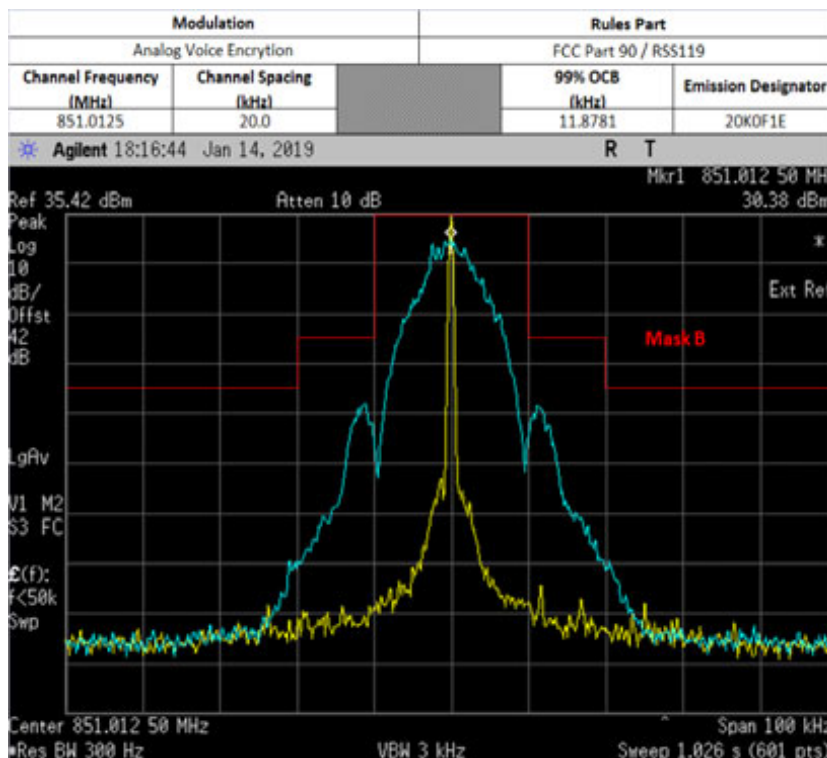
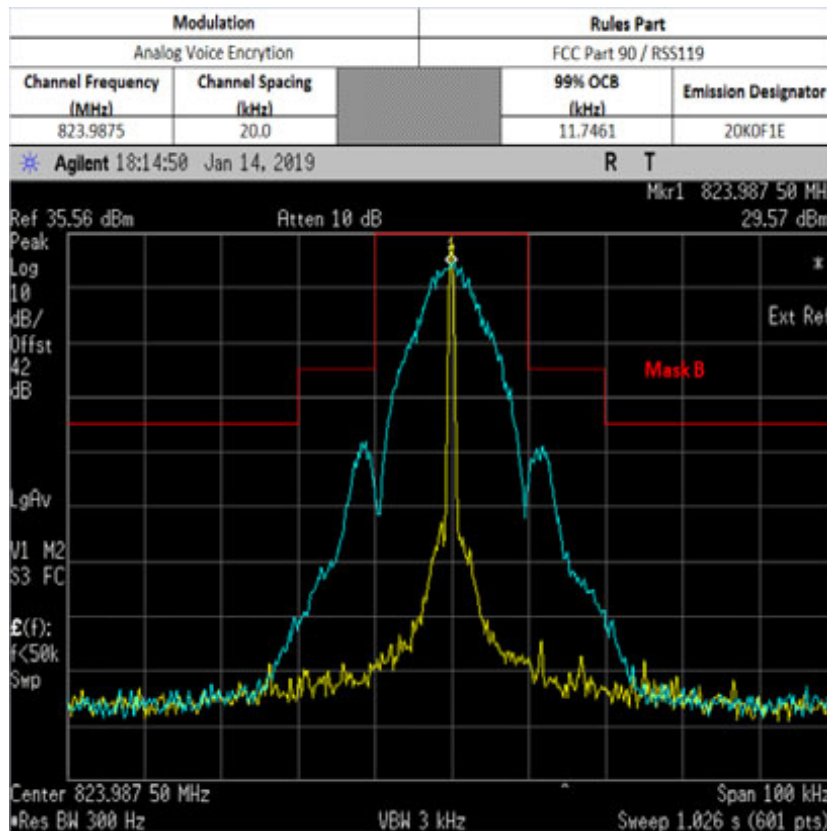

NOT FOR FCC REVIEW

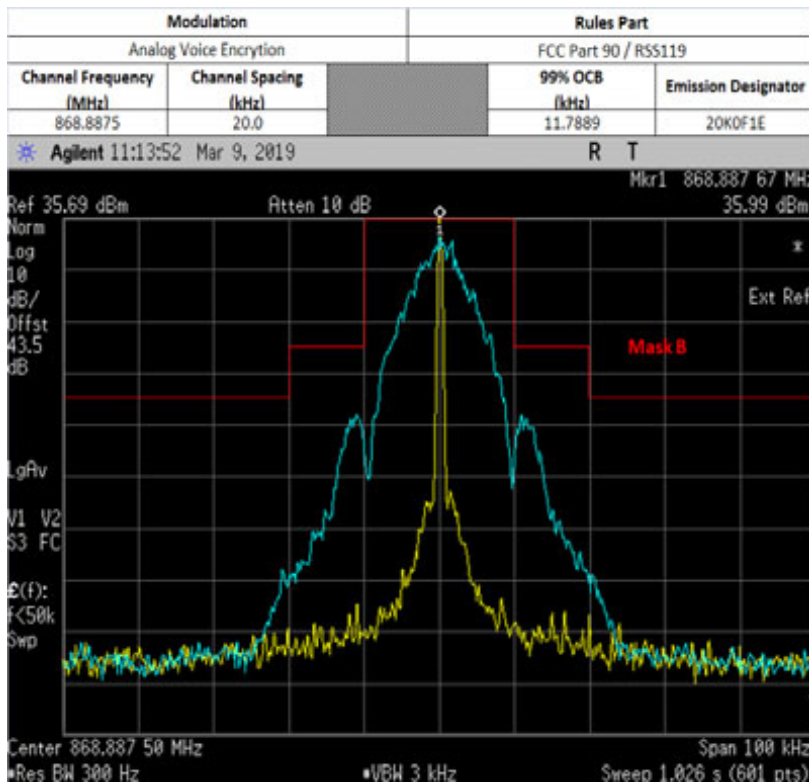
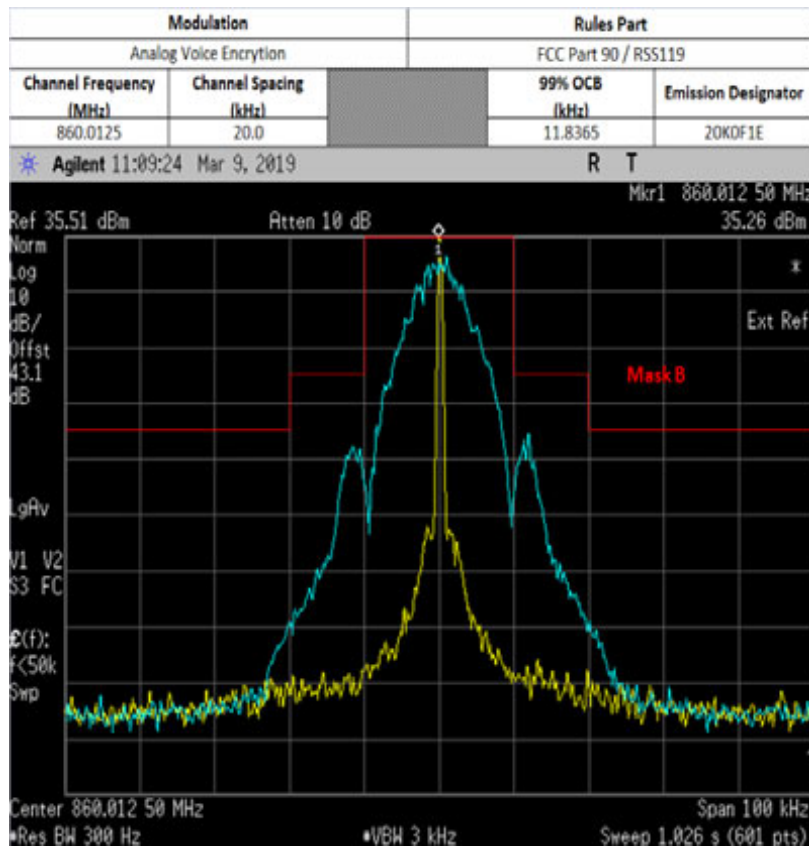

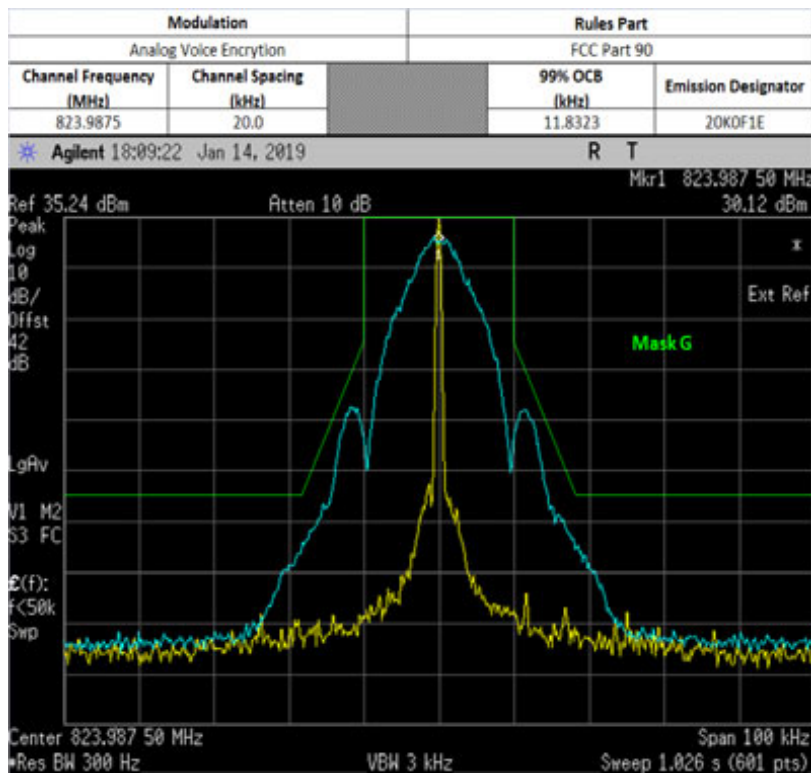
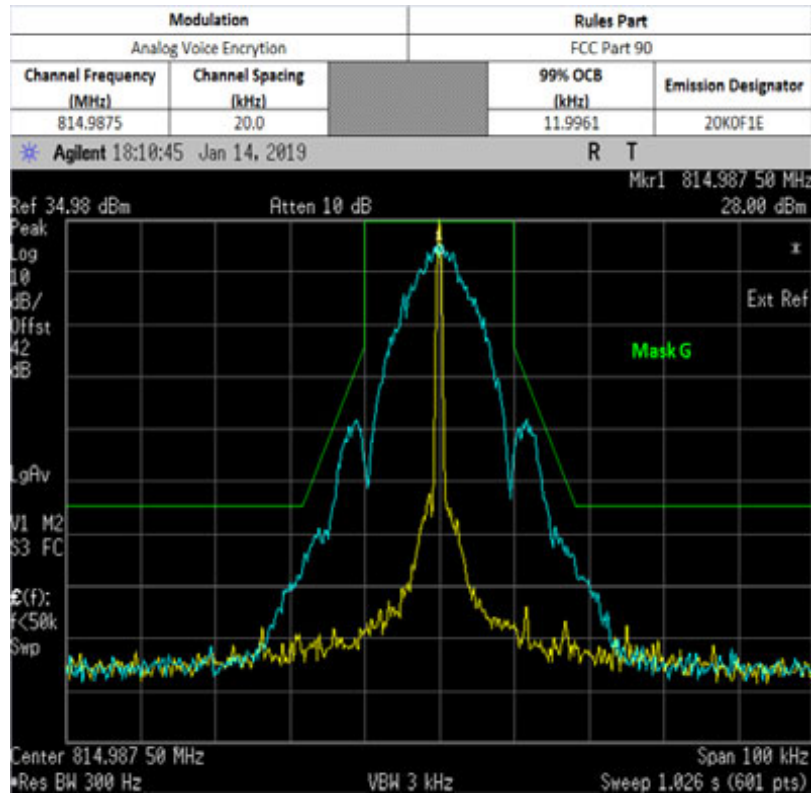

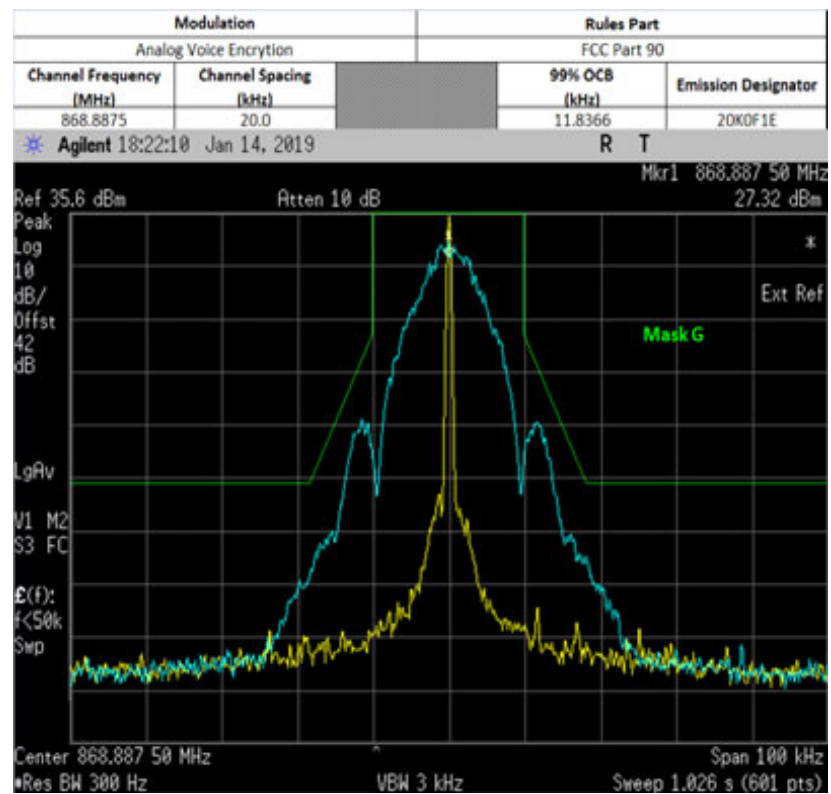
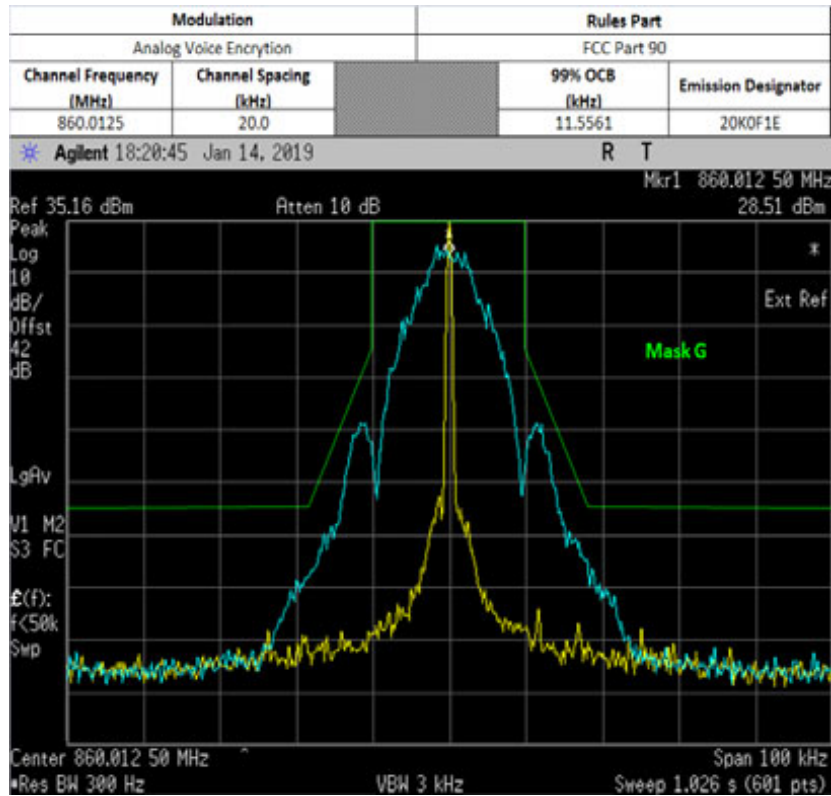

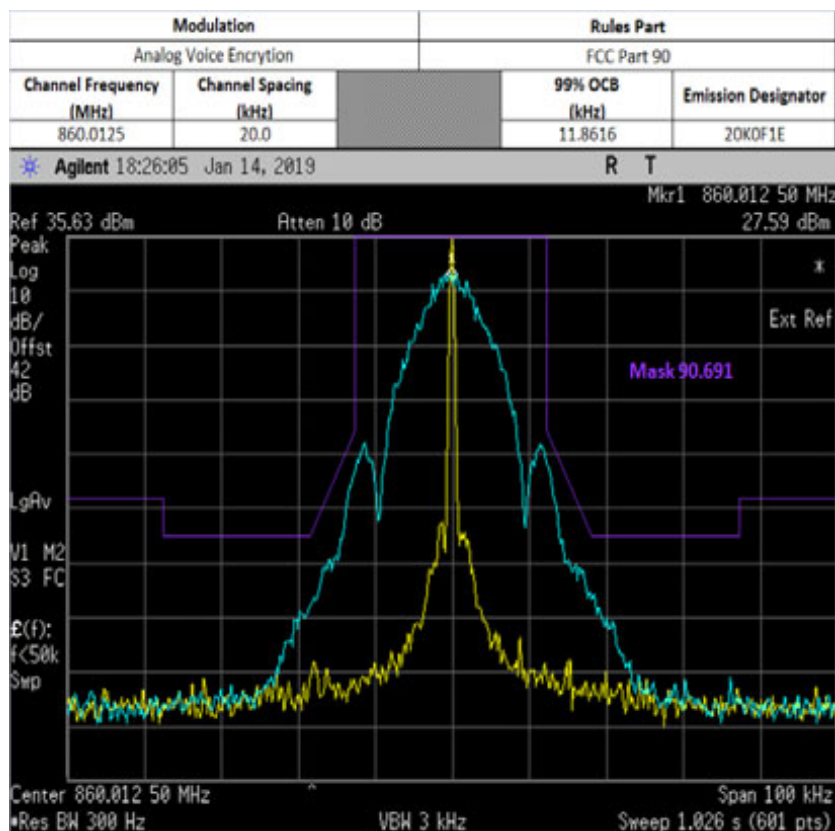
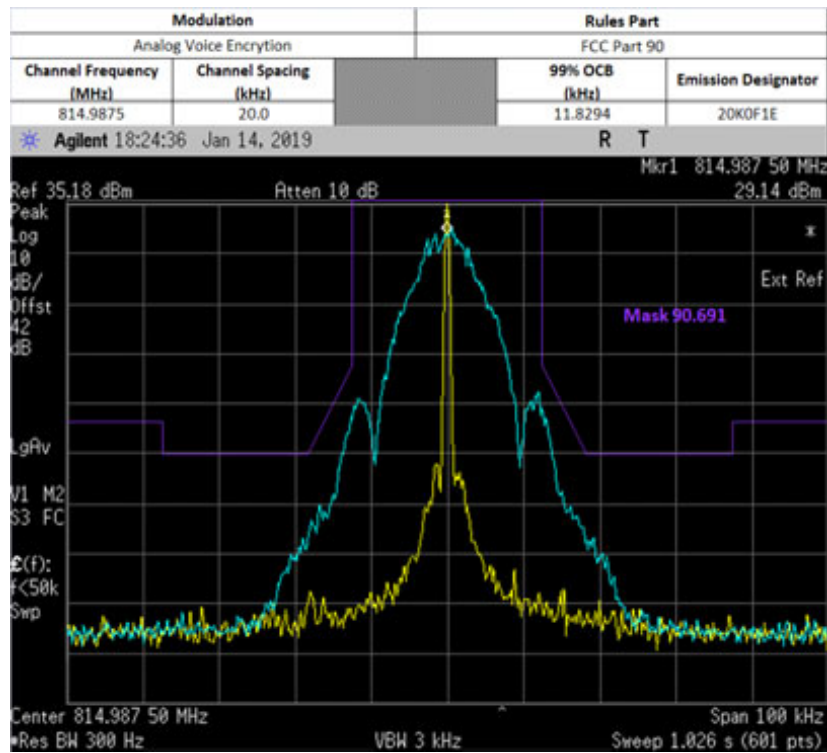

6.6.3. Test Setup (Digital)

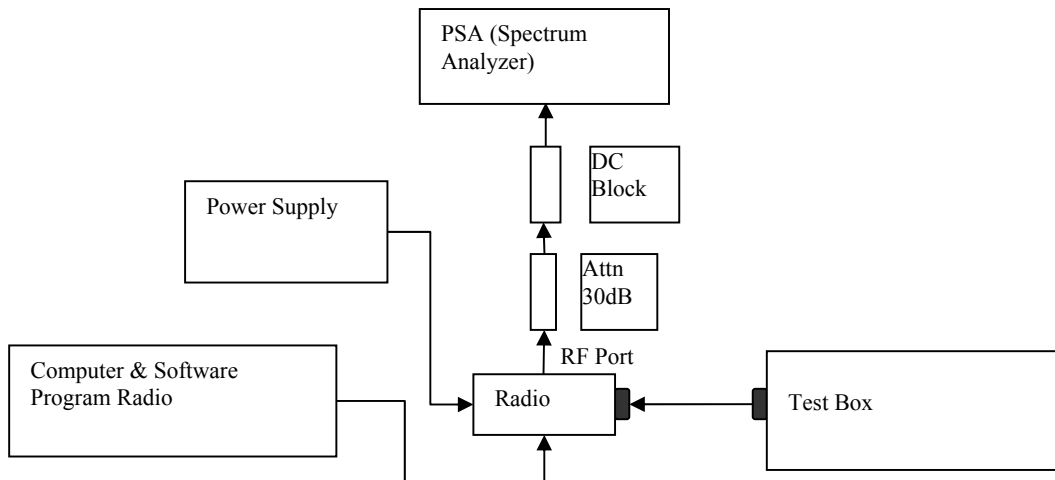

- 1) Program and set radio to operate in desire test frequency and digital mode with modulation. (*4FSK, C4FM or other digital modulation form).
- 2) Path loss for the measurement included.
- 3) Select the Occupied Bandwidth measurement for 99% Emissions Bandwidth Measurement.
- 4) Key in the Fc and Resolution Bandwidth (1 ~ 5 % of emission designator).
- 5) Transmit the DUT and record the occupied Bandwidth frequency.
- 6) Preset the spectrum analyzer for modulation emission spectrum measurement.
- 7) Set the span and Resolution Bandwidth (according to FCC/ ISED standard).
- 8) Capture the screen shot as modulated signal.

*Note:

- For Digital Modulation, 12.5 kHz Data F1D & FXD would be the same. Therefore only measurements with F1D modulation shown below.
- For Digital Modulation, 12.5 kHz Data F1E & FXE would be the same. Therefore only measurements with F1E modulation shown below.

6.6.4. Test Result (Digital)

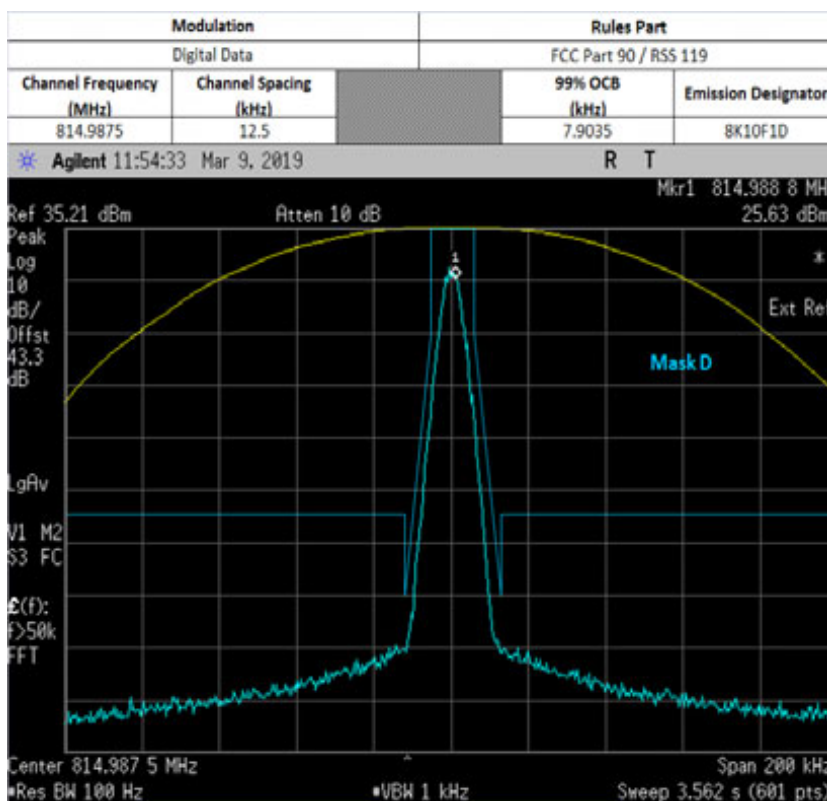
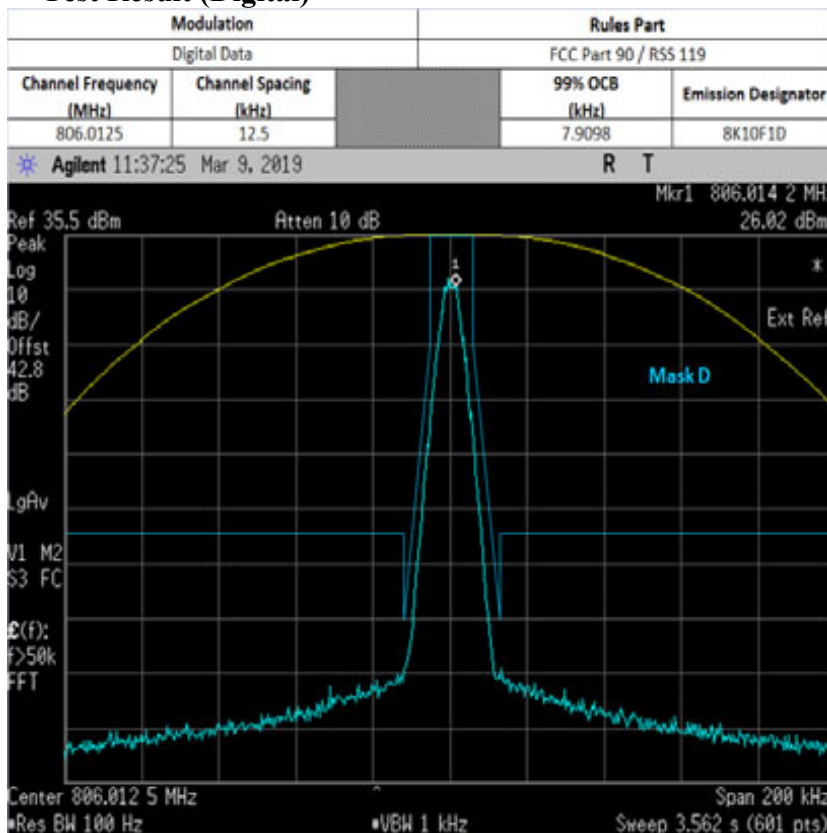

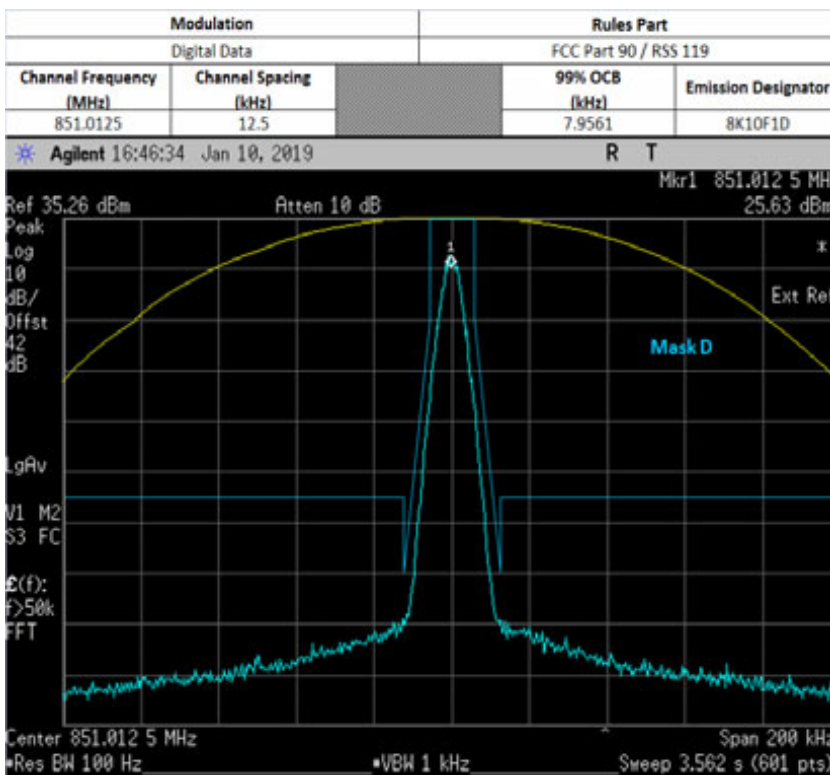
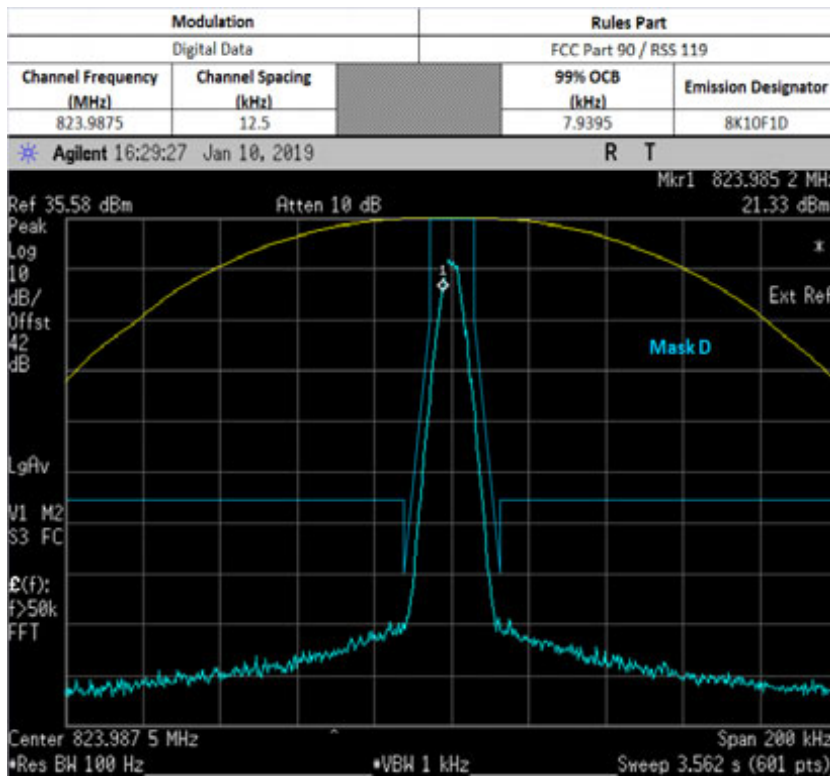

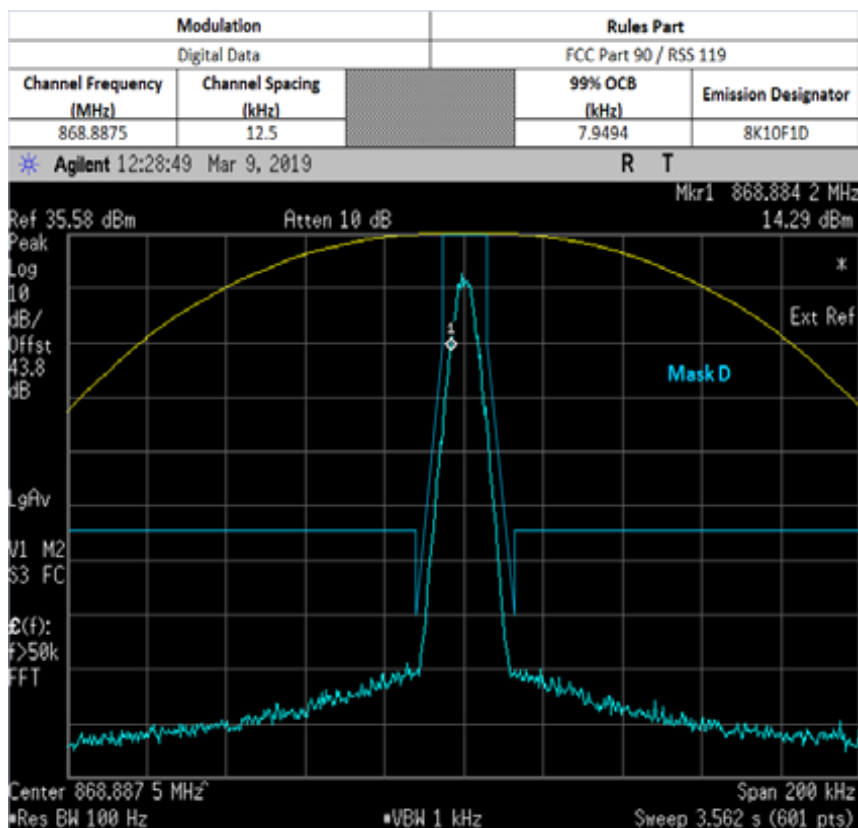
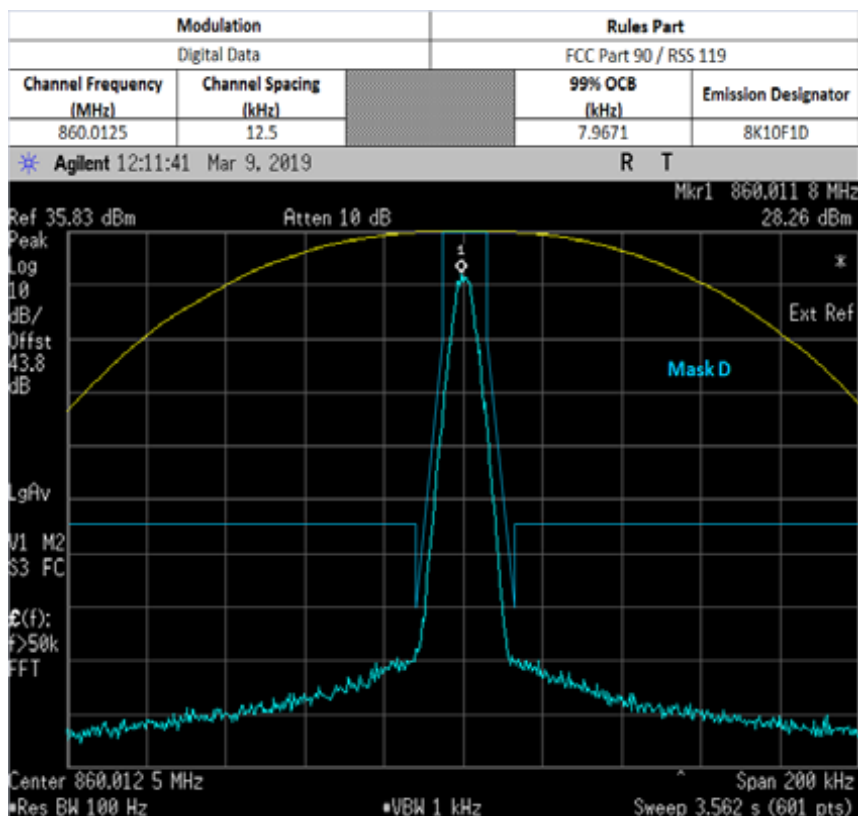

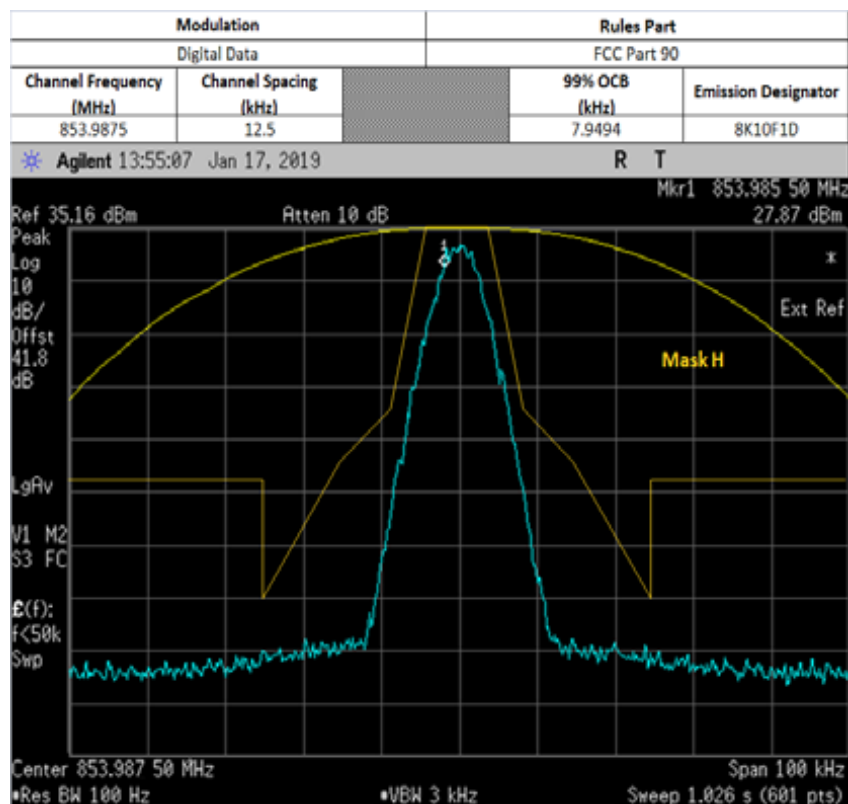
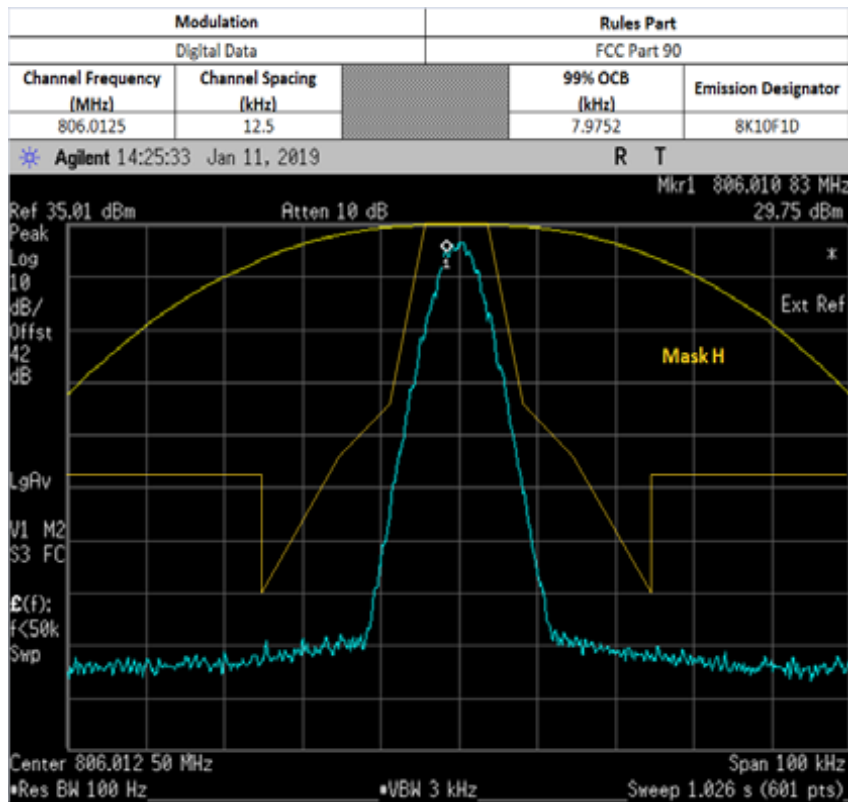

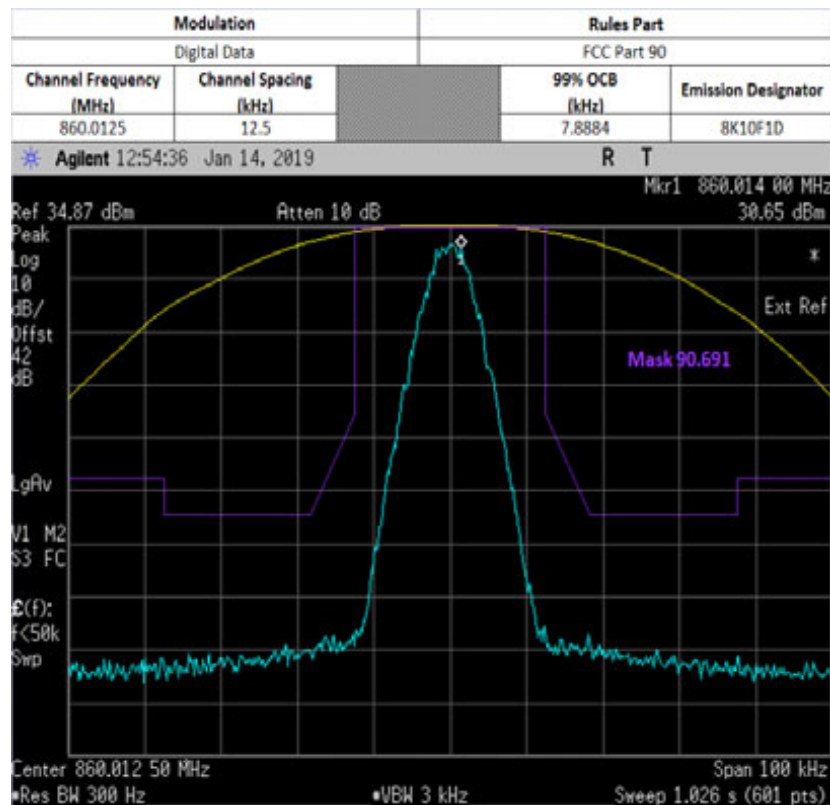
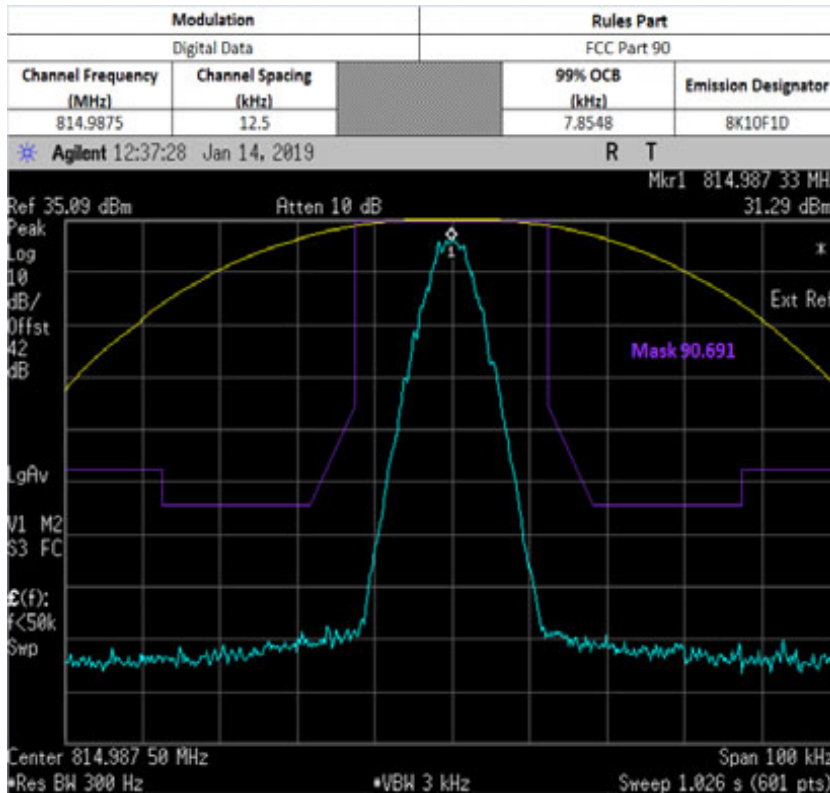

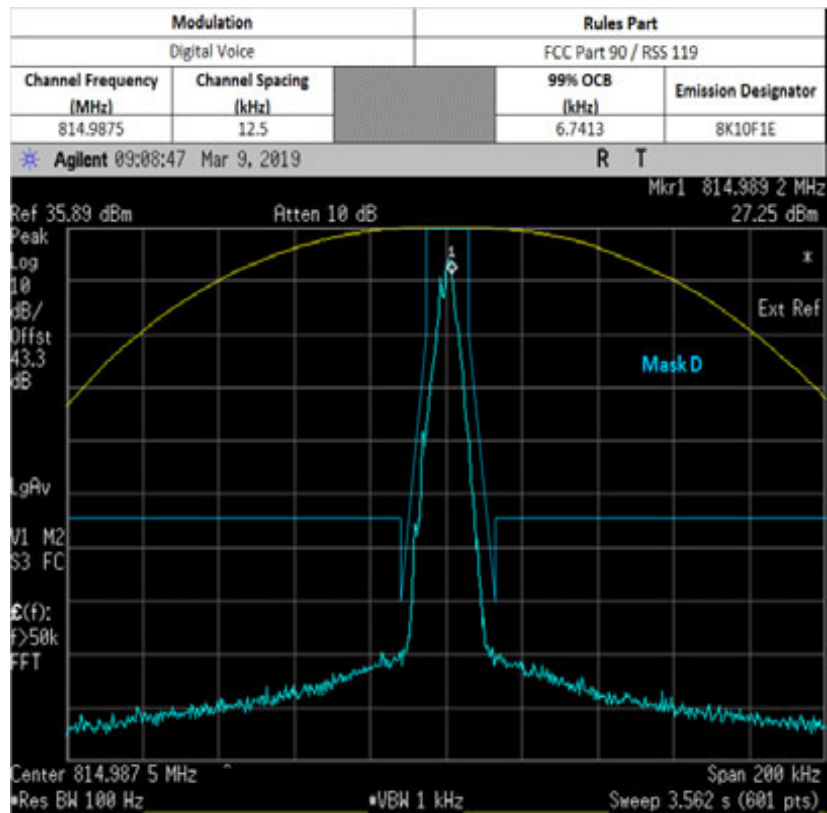
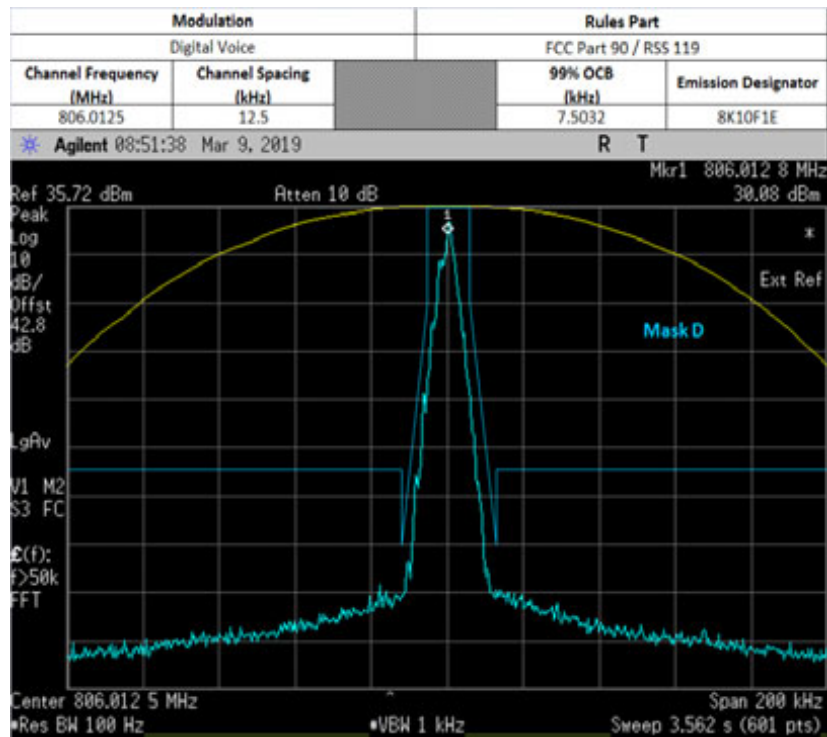

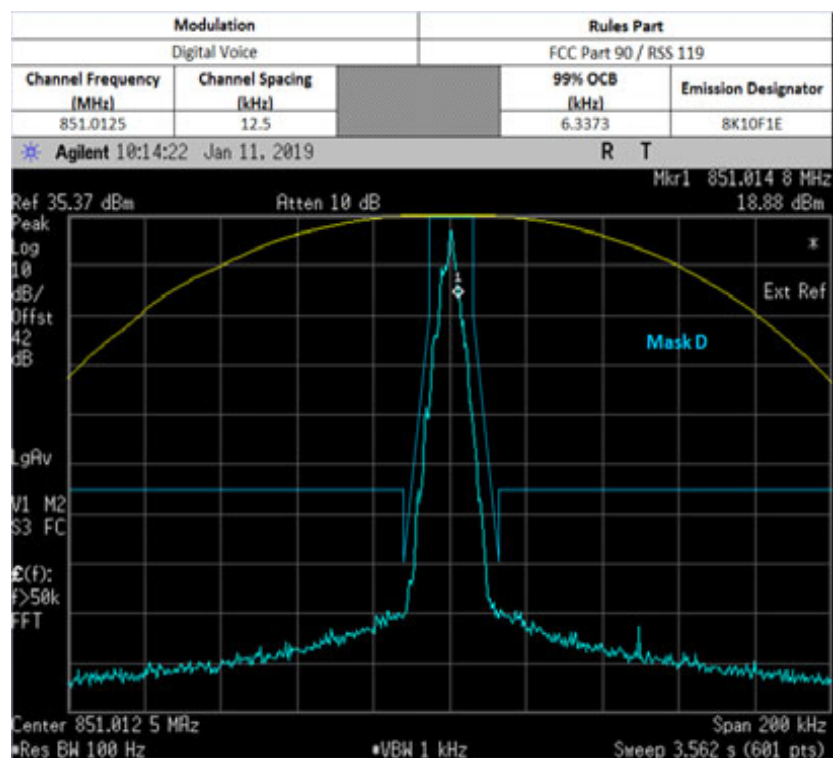
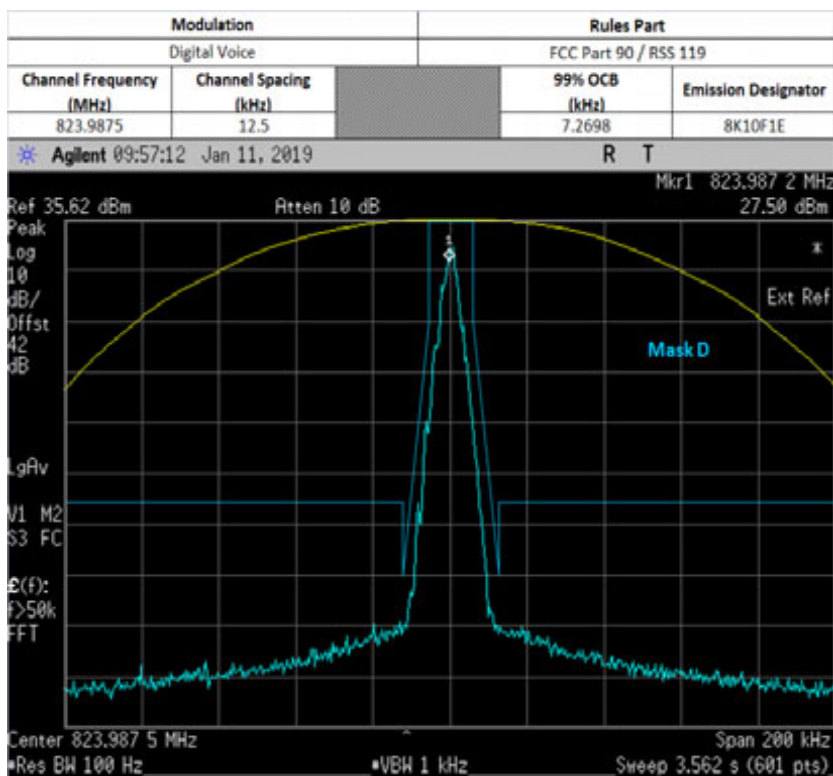

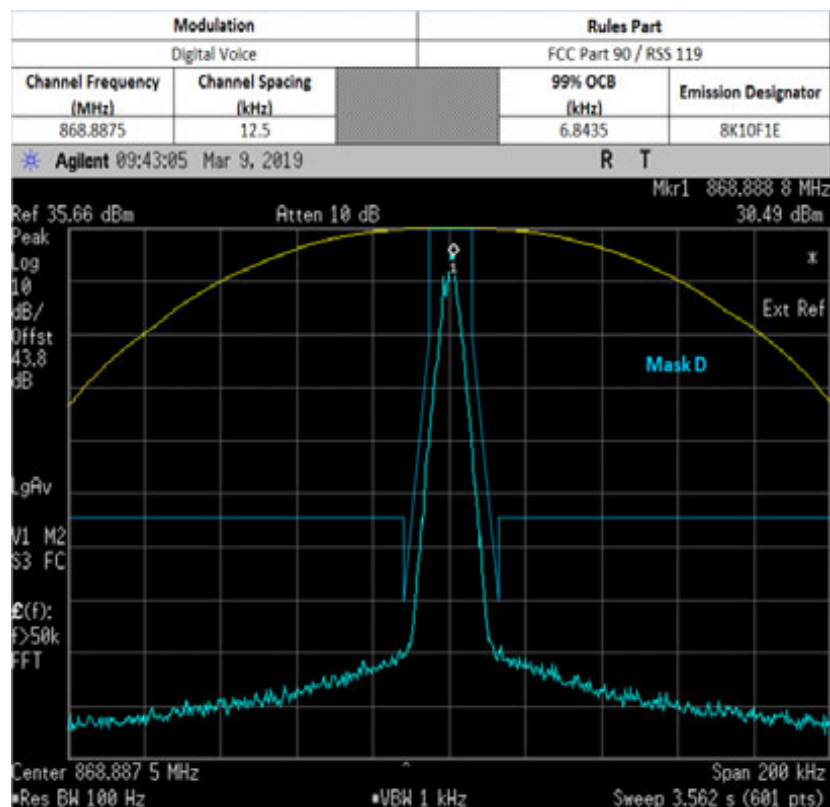
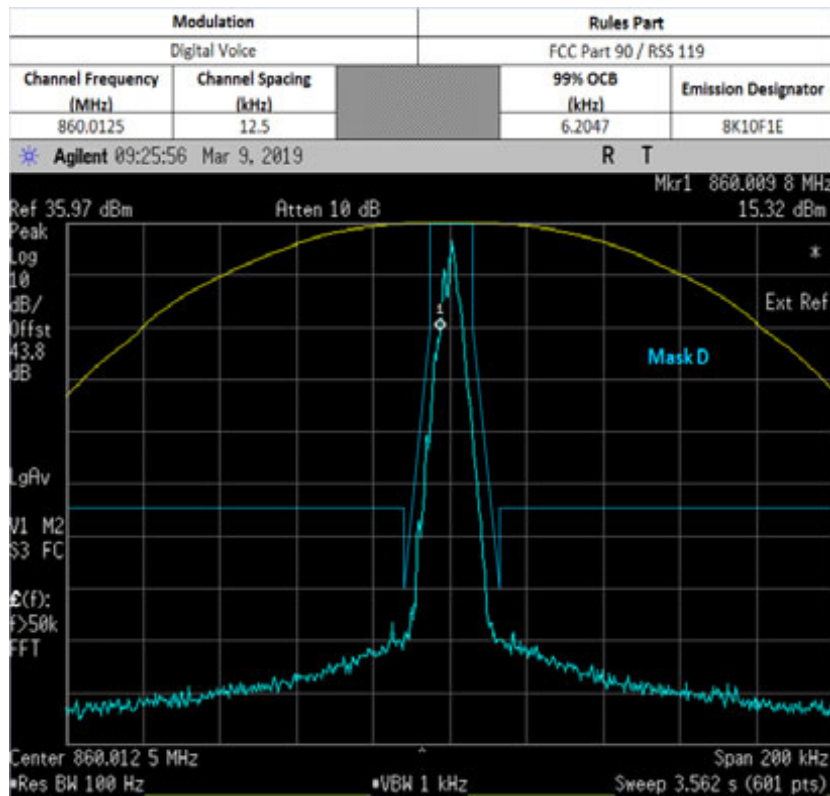

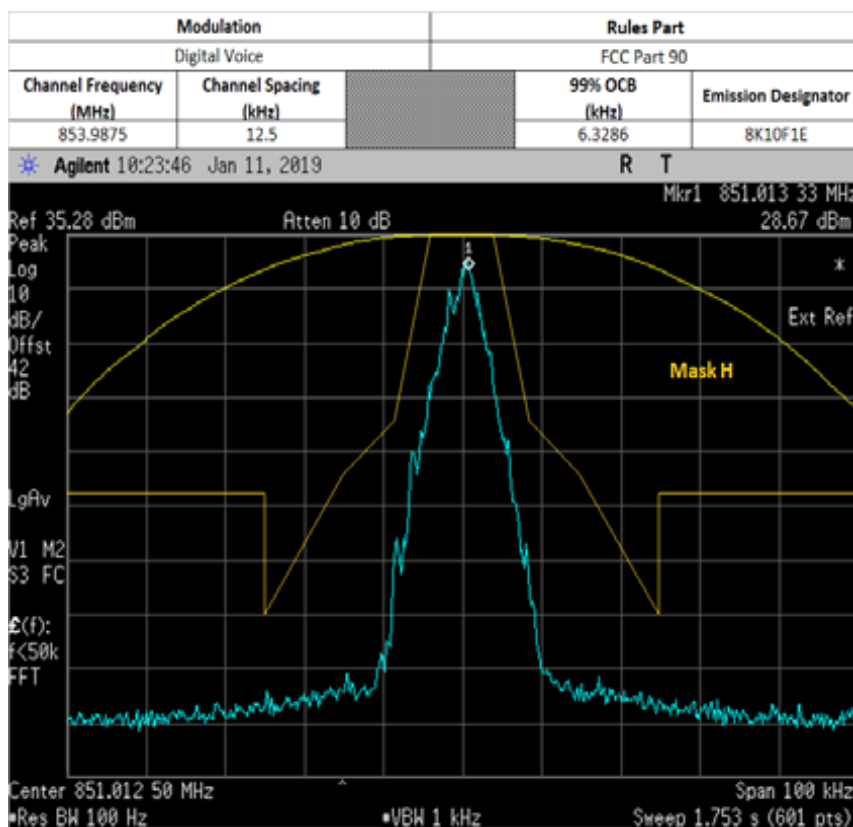
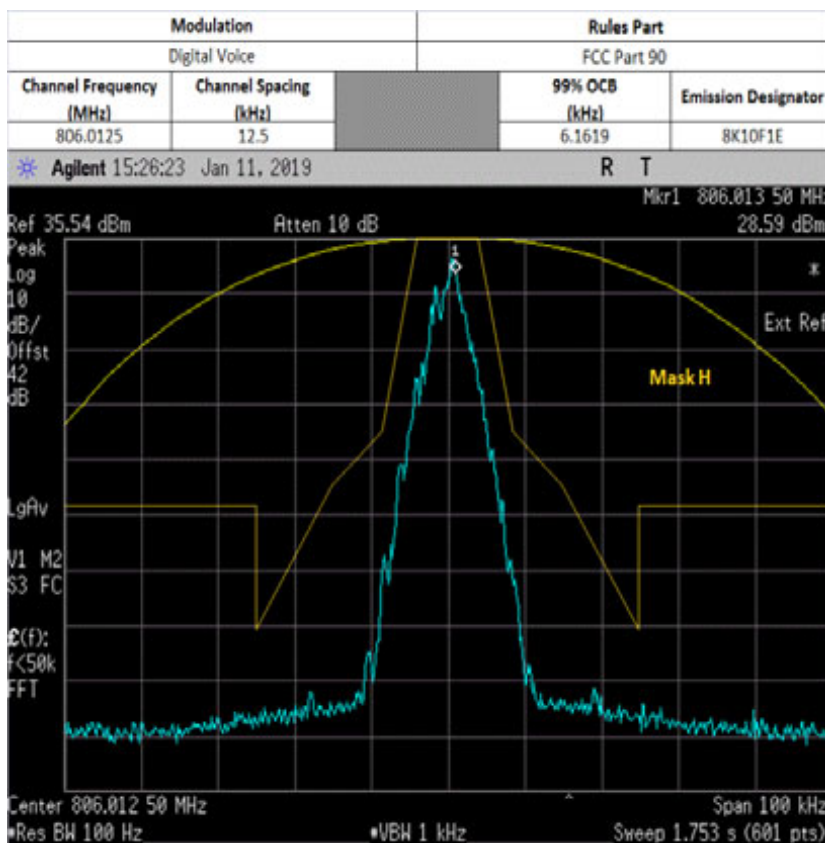

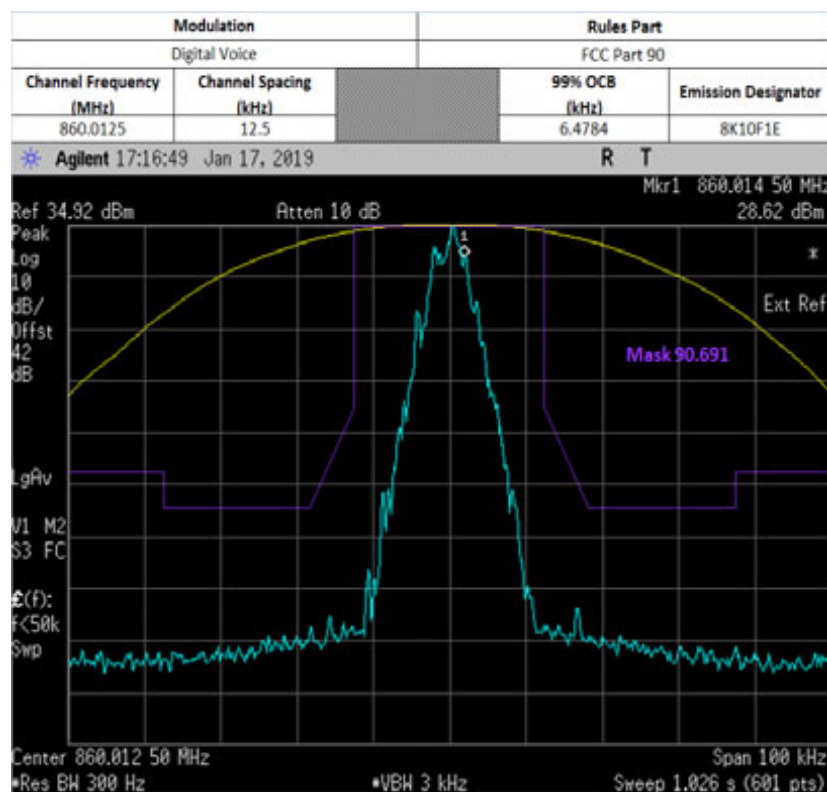
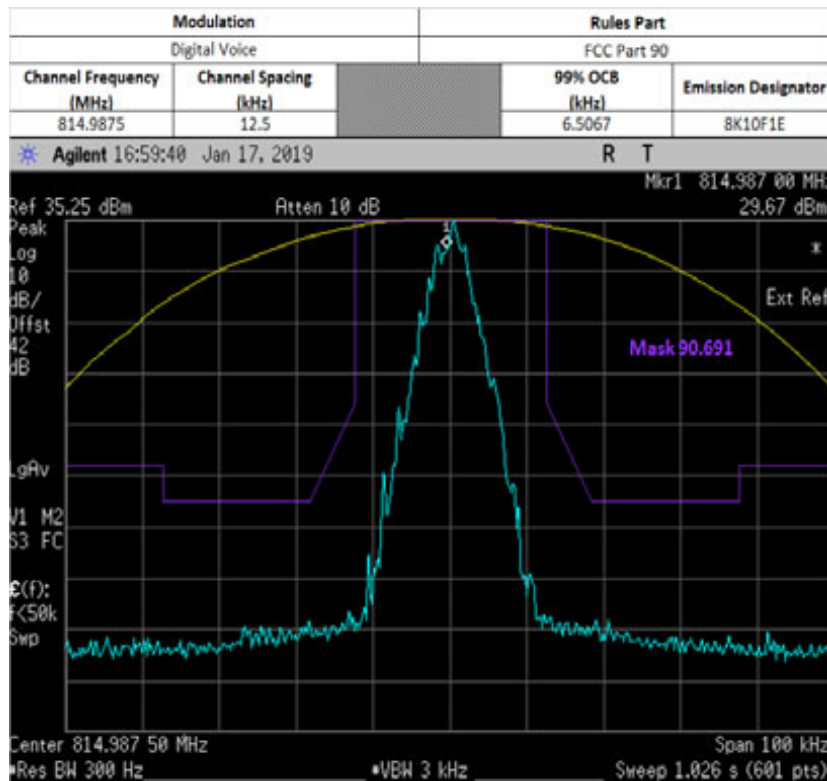

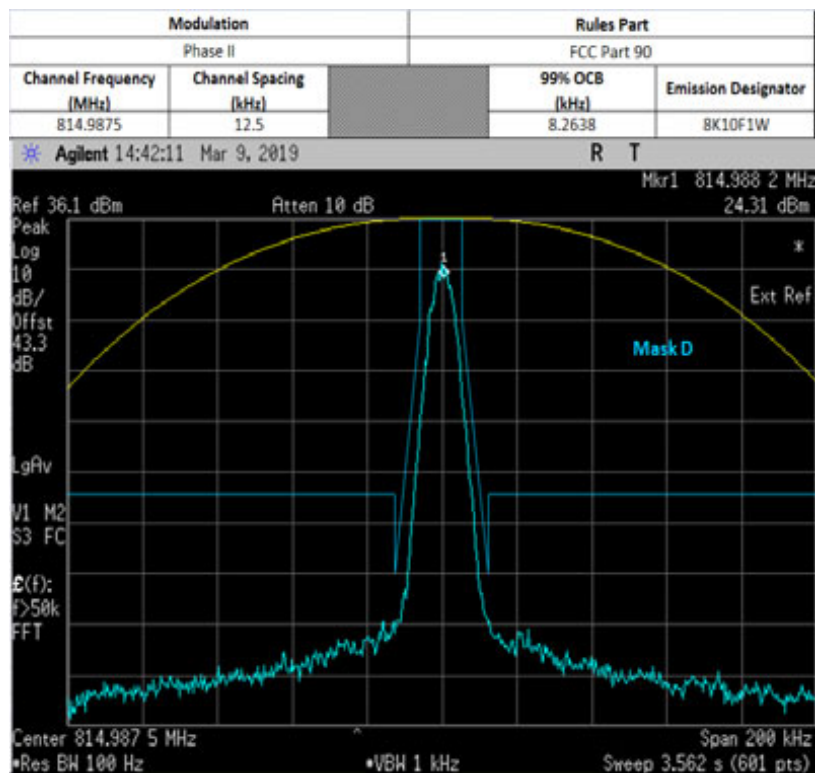
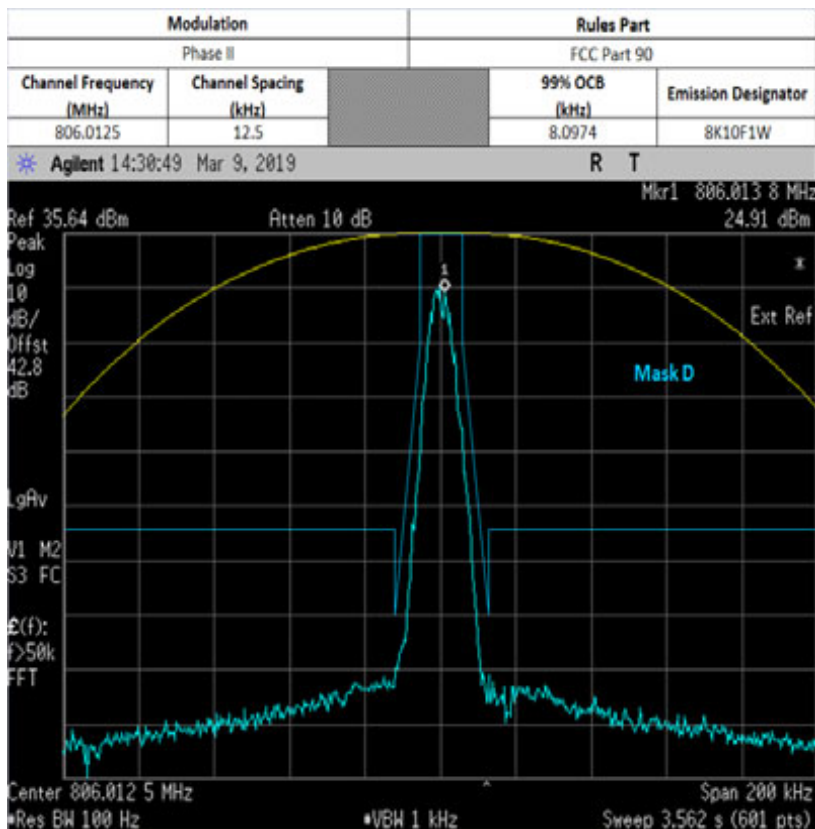

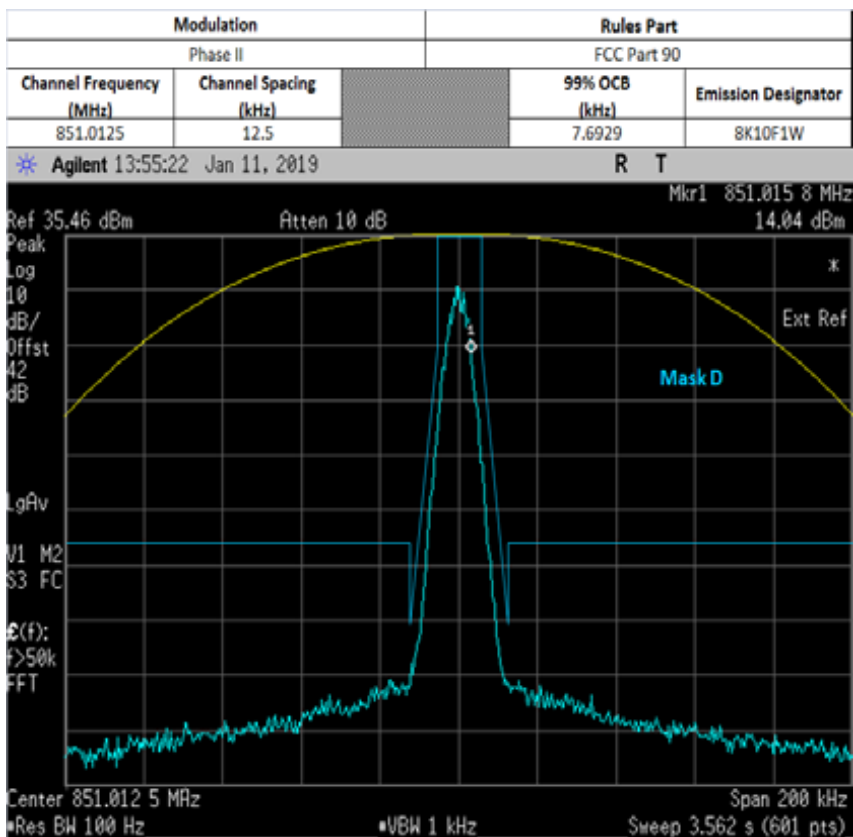
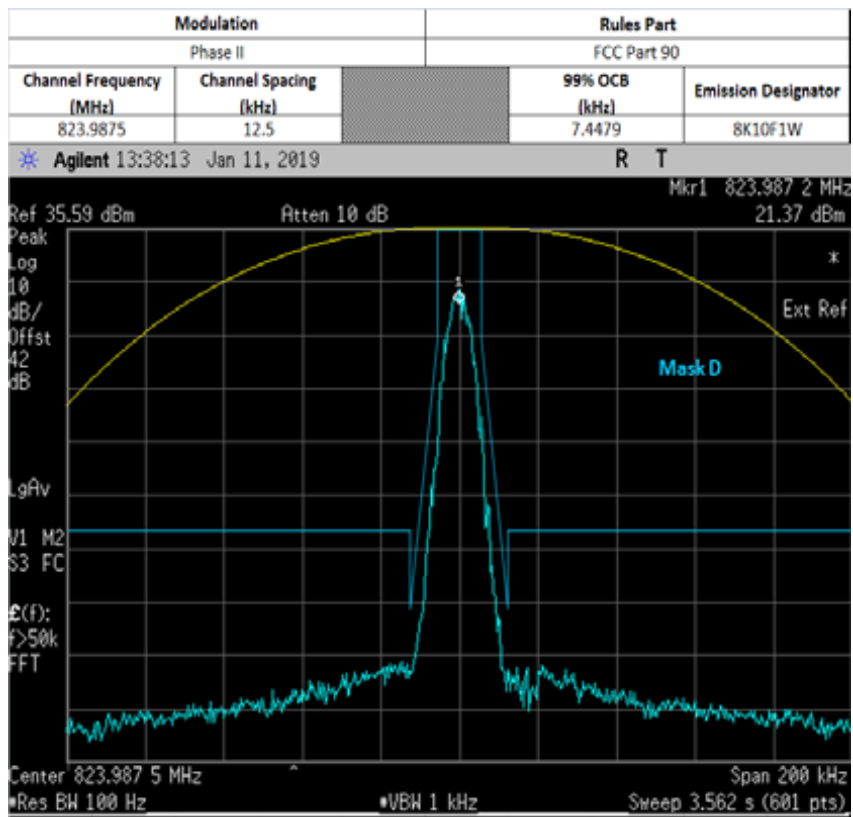

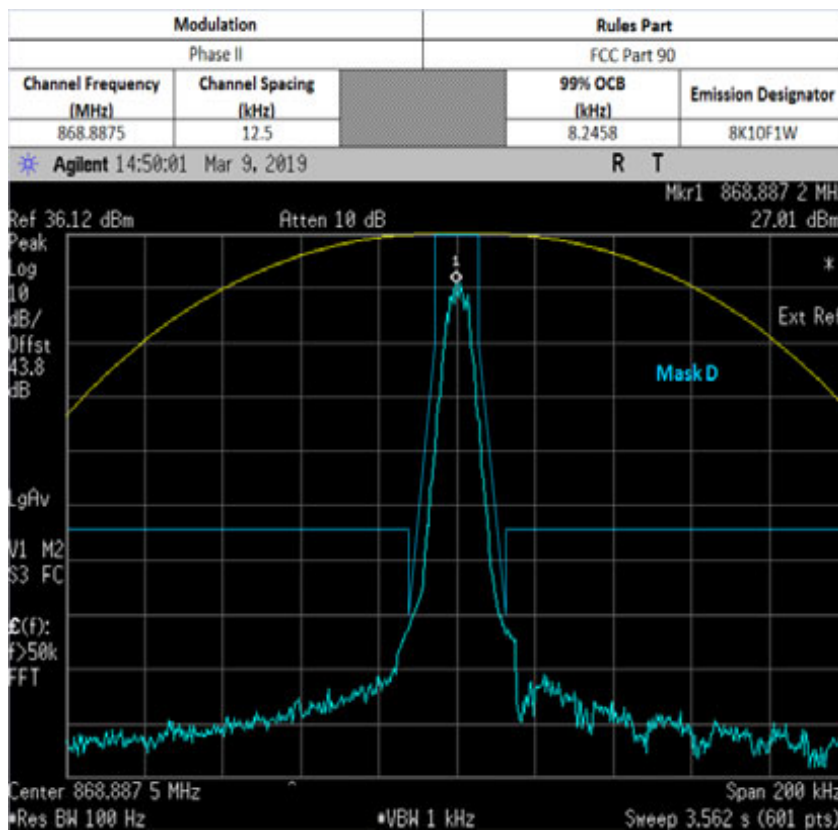
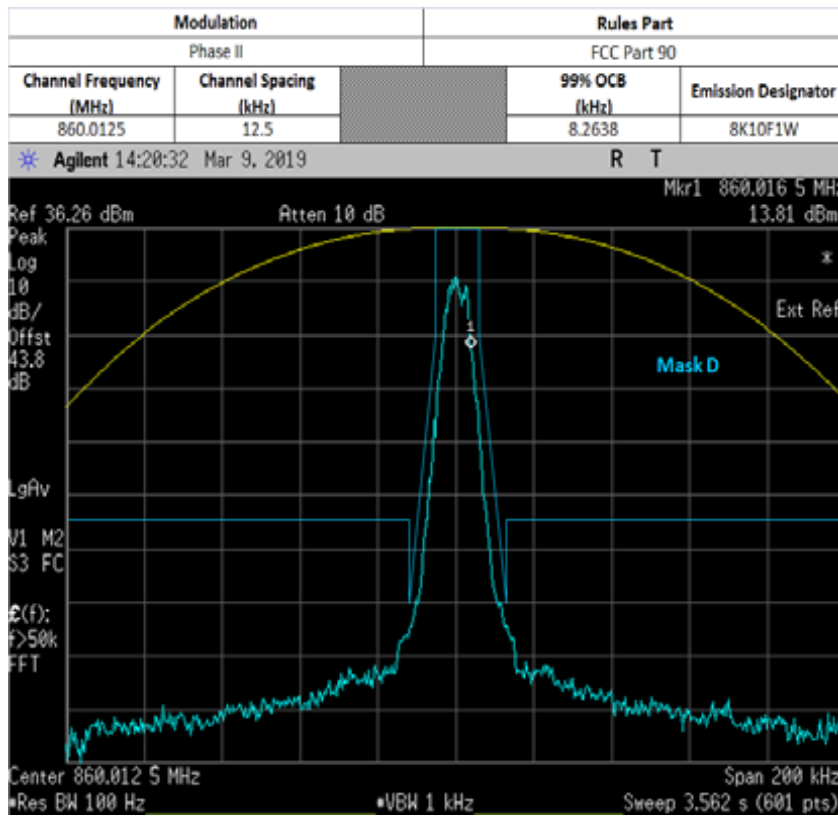

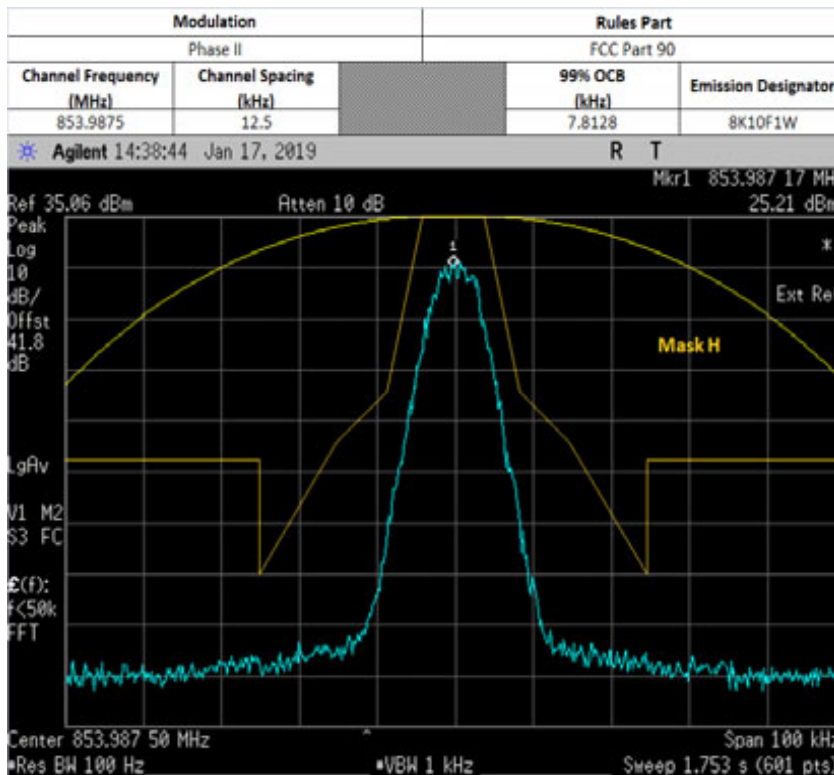
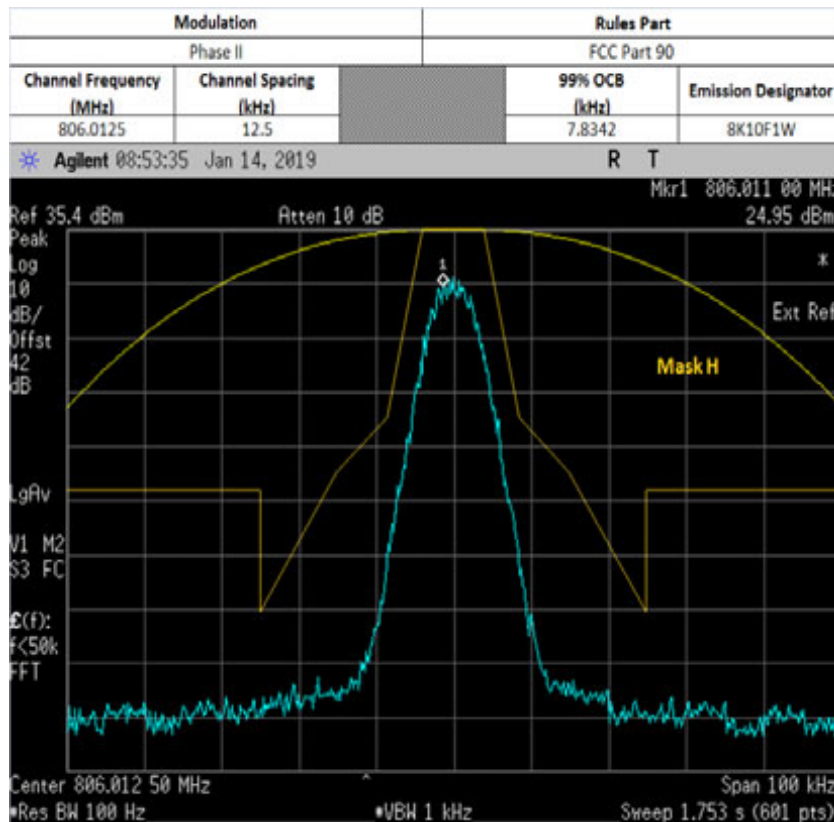

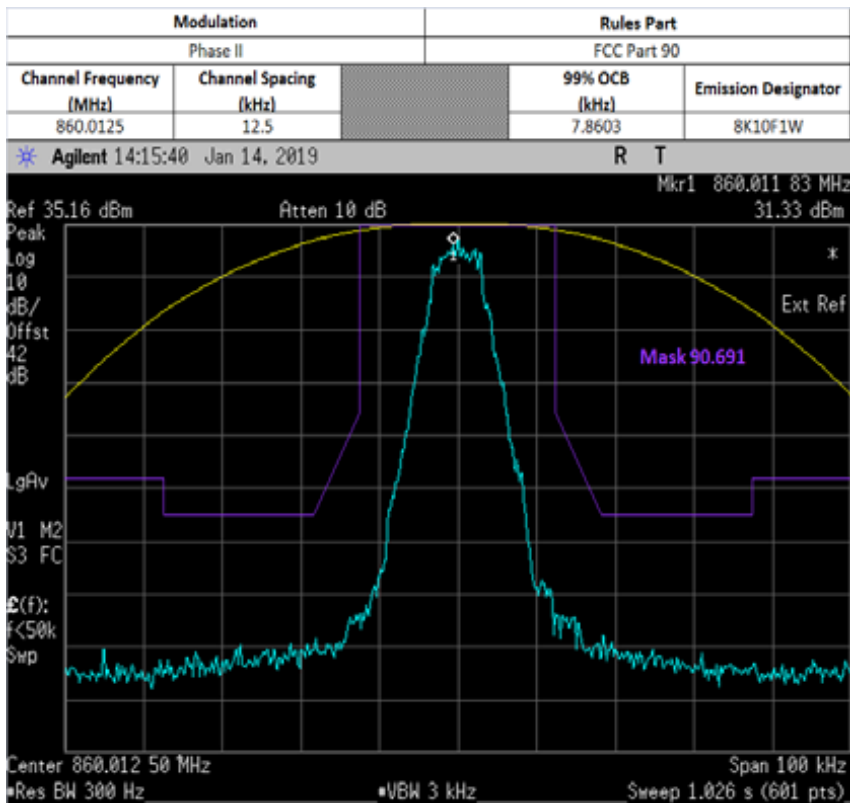
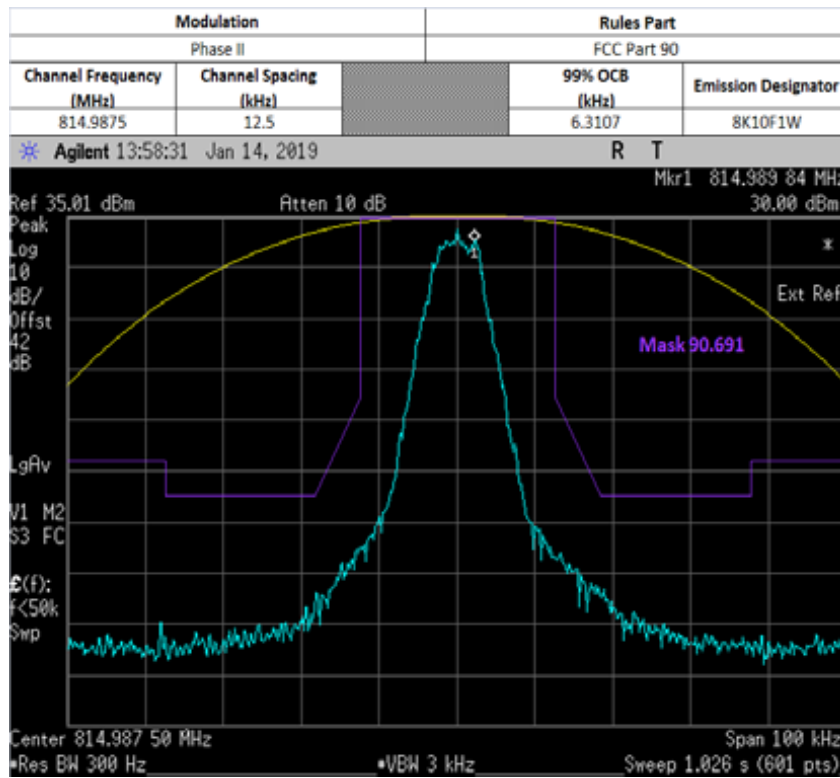

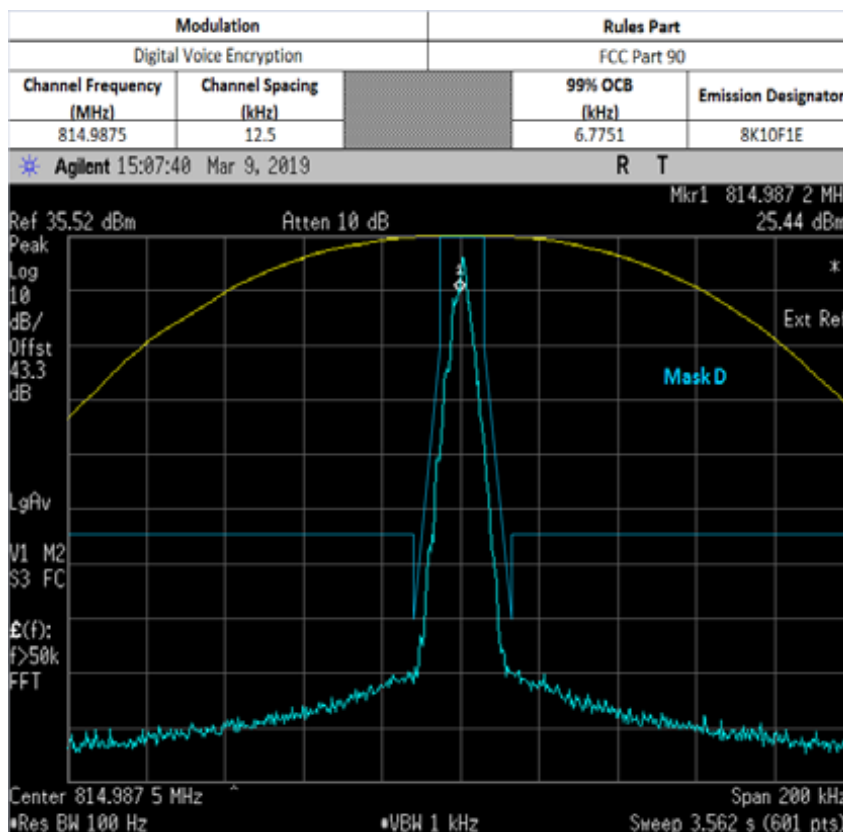
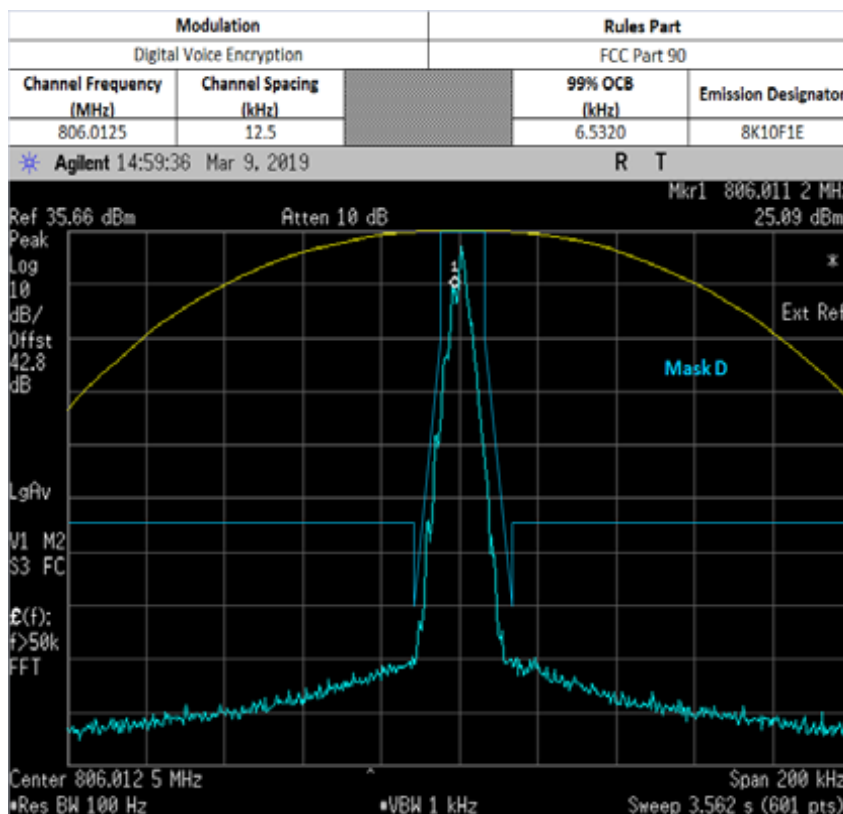

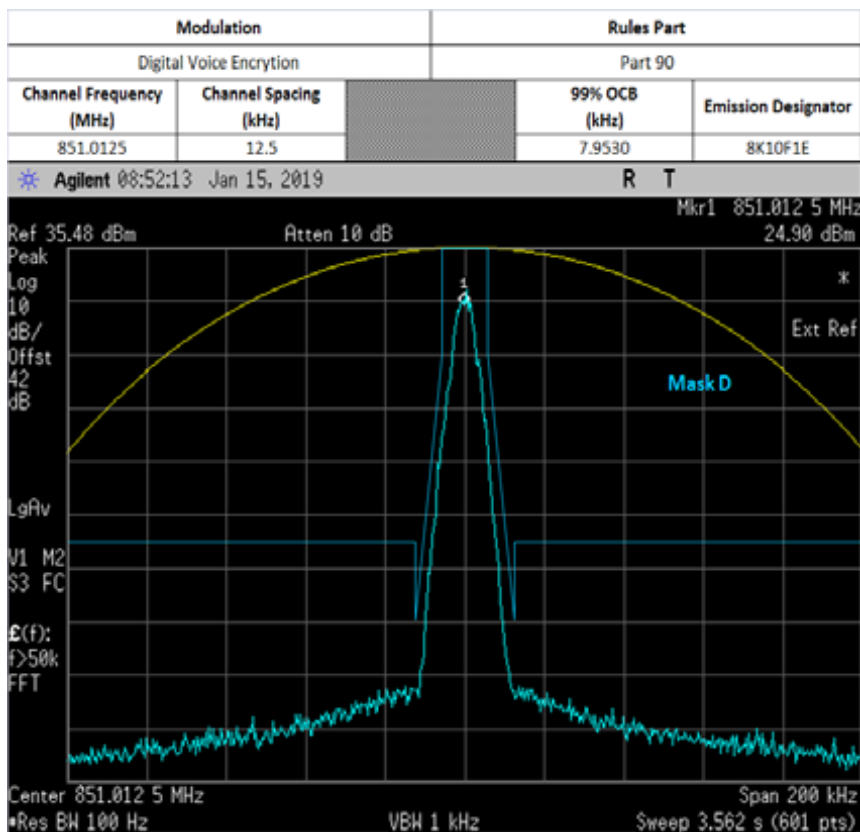
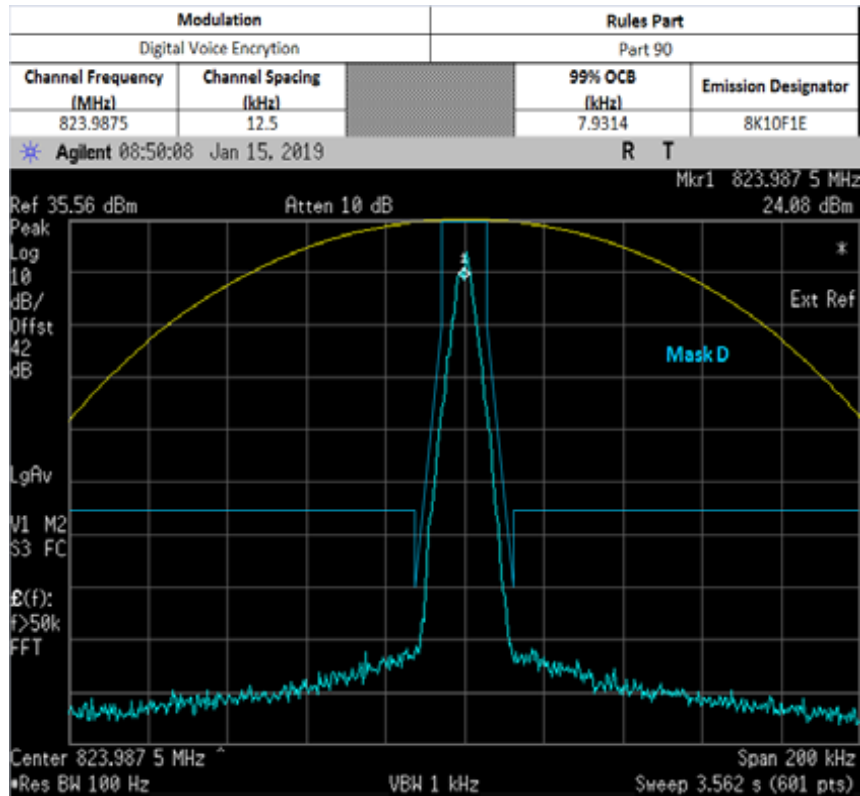

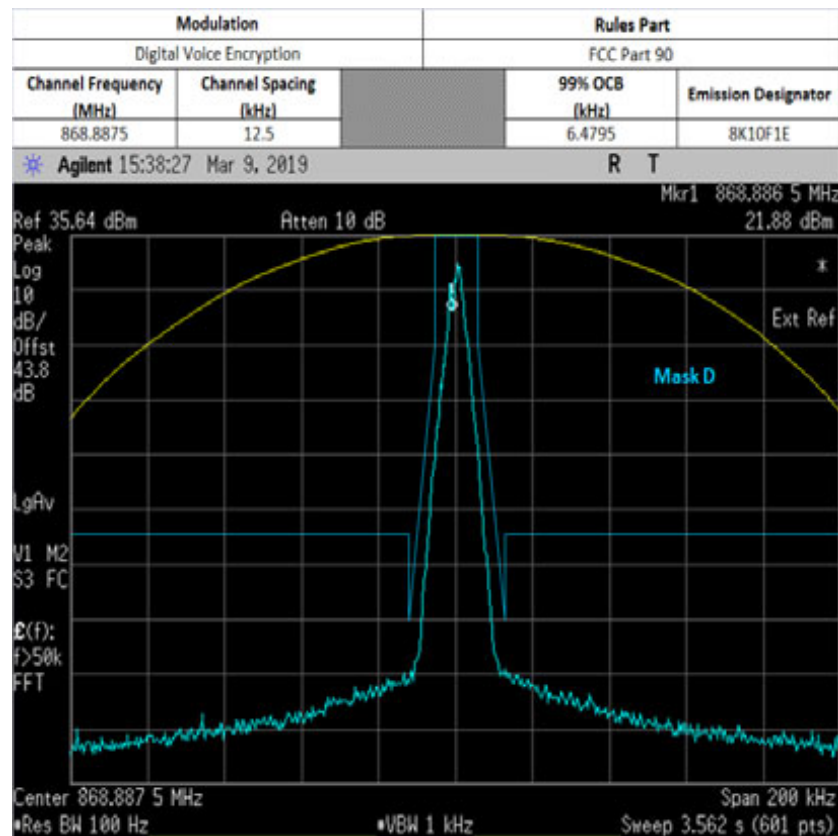
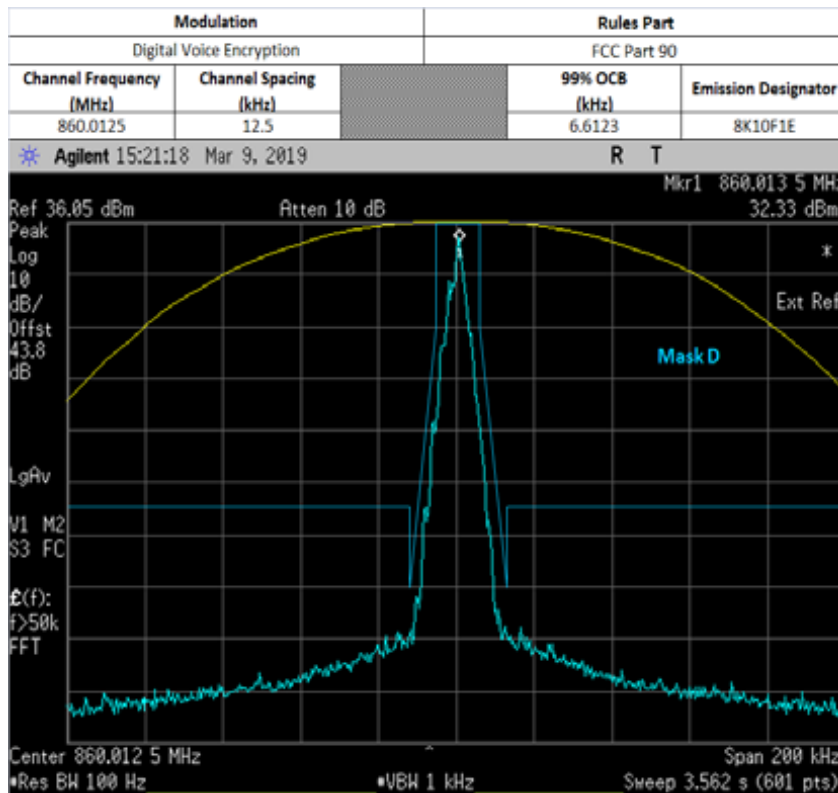

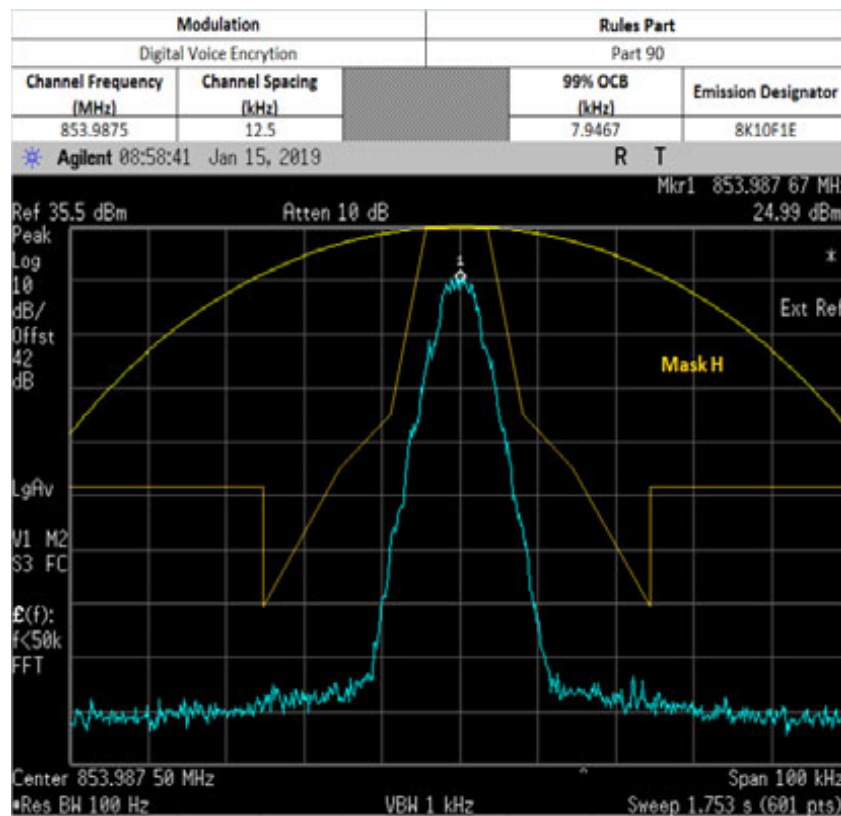
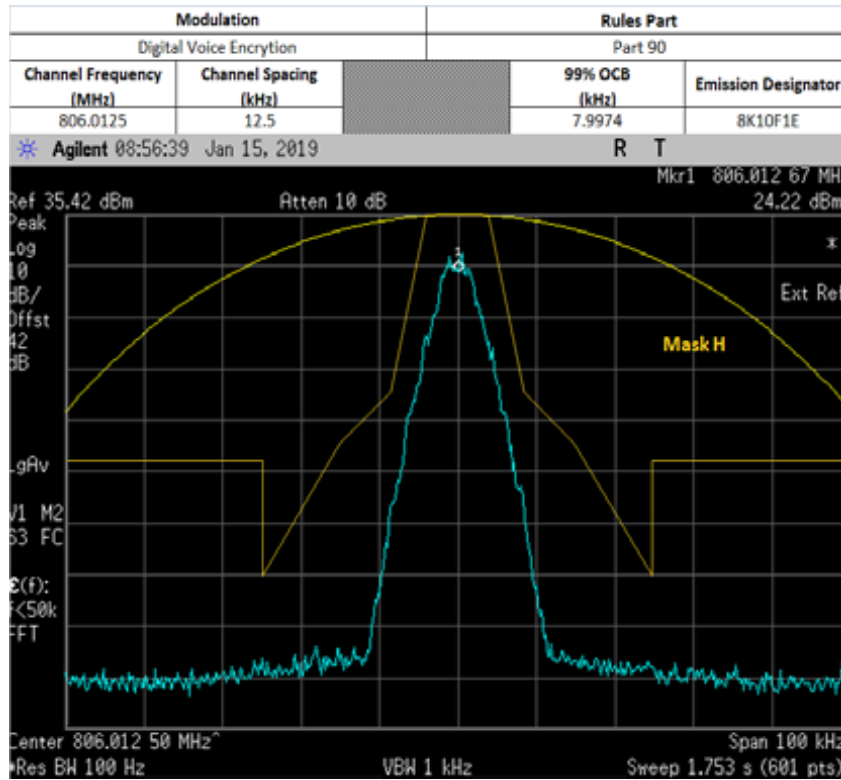

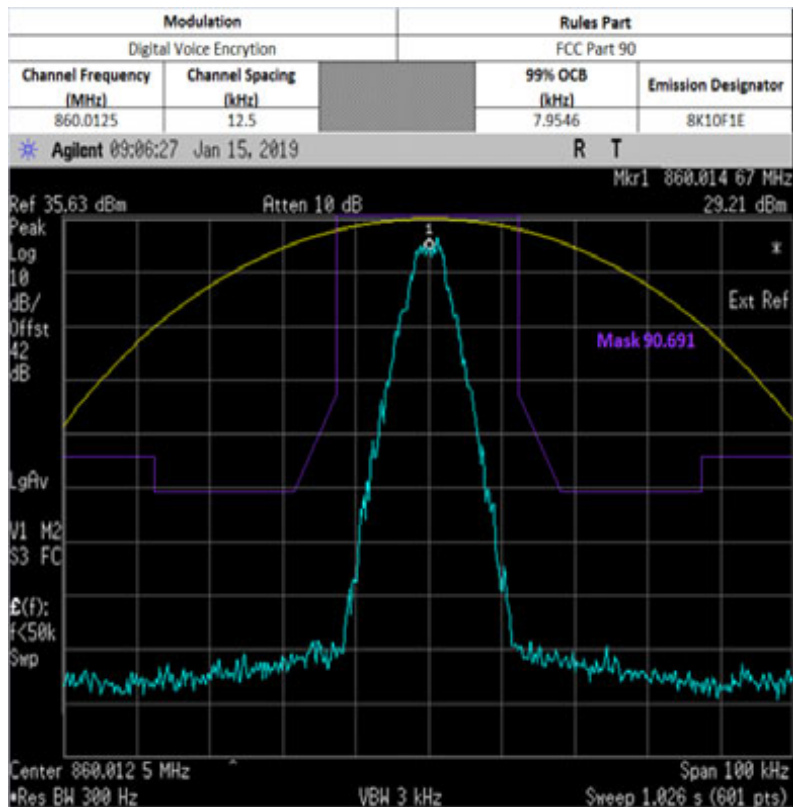
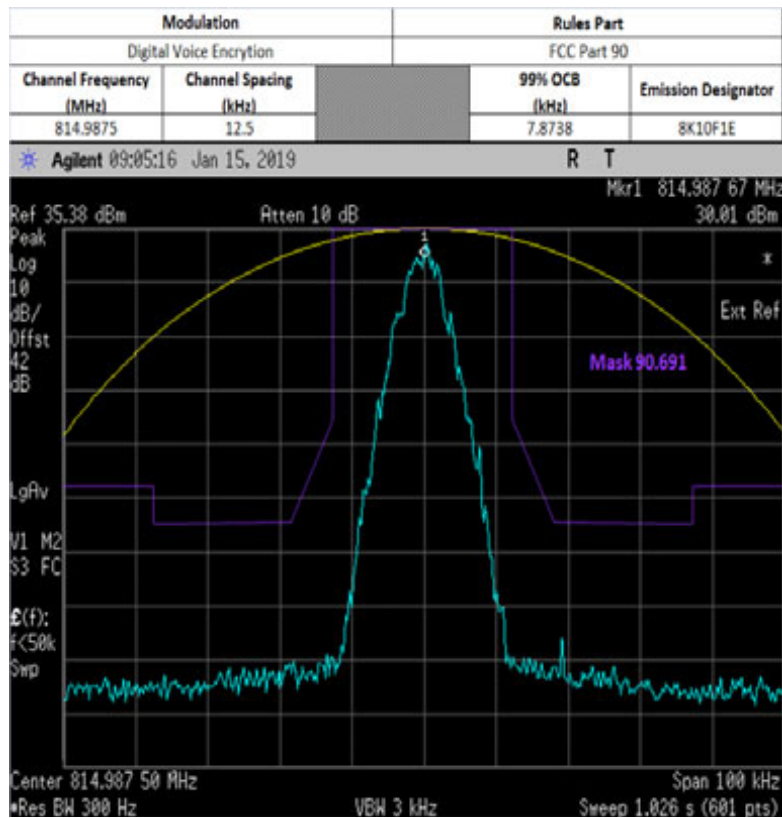

6.7. Test Limit

The 99% occupied bandwidth is the width of a frequency band such that, below the lower and above the upper frequency limits, the mean powers emitted are each equal to a specified percentage 0.5% of the total mean transmitted power.

6.8. Band Edge Conducted Spurious Emission (Part 22)

6.8.1. Test Setup (Analog)

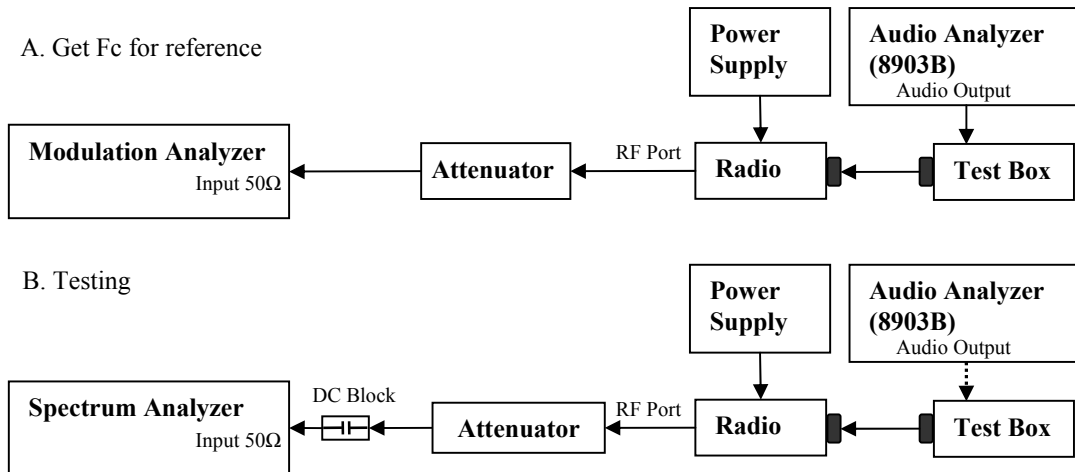

- 1) The DUT transmitter output port was connected to Modulation Analyzer.
- 2) Set the audio bandwidth filter to 15 kHz low pass filter and 50 kHz high pass filter.
- 3) Transmit the radio and set the audio analyzer to 2.5 kHz audio frequency and 50% of the rated deviation. Up the amplitude by 16 dB. Dekey the DUT.
- 4) Path loss for the measurement included.
- 5) Select the Occupied Bandwidth measurement for 99% and 26dB Emissions Bandwidth Measurement.
- 6) Key in the Fc and Resolution Bandwidth.
- 7) Transmit the DUT and record the occupied Bandwidth frequencies.
- 8) Preset the spectrum analyzer for band edge measurement.
- 9) The band edges of lowest and highest channels were measured.
- 10) Key in the Lowest and highest channel frequency, span is 60 kHz and Resolution Bandwidth is at least 1% of Emission Bandwidth.
- 11) Save the screen shot as modulated signal.
- 12) Remove the audio tone from audio analyzer to capture unmodulated signal.

*Note:

- For emission designator ending with F3E, 16K0F3E is the worst case and therefore only 16K0F3E will be shown.

6.8.2. Test Result (Analog)

NA → Not Applicable

6.8.3. Test Setup (Digital)

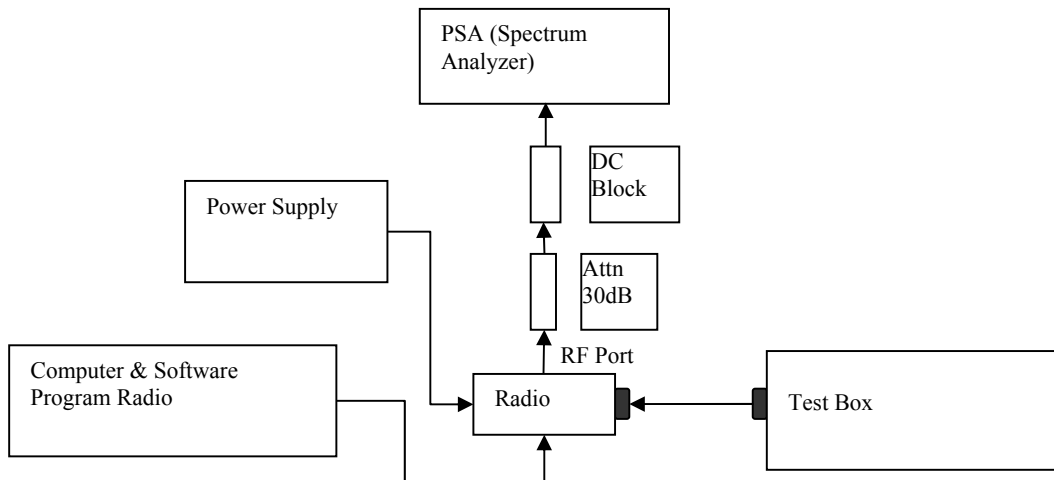

- 1) Program and set radio to operate in desire test frequency and digital mode with modulation. (*4FSK, C4FM or other digital modulation form).
- 2) Path loss for the measurement included.
- 3) Select the Occupied Bandwidth measurement for 99% and 26dB Emissions Bandwidth Measurement.
- 4) Key in the Fc and Resolution Bandwidth.
- 5) Transmit radio record the occupied Bandwidth frequencies.
- 6) Preset the spectrum analyzer for band edge measurement.
- 7) Key in the lowest and highest channels frequency, span is 60 kHz and Resolution Bandwidth is at least 1% of Emission Bandwidth.
- 8) Save the screen shot.

*Note:

- All digital modulation modes utilize the same high deviation test pattern, and they are therefore identical. Hence, only F1D plots will be shown.

6.8.4. Test Result (Digital)

NA → Not Applicable

6.9. Test Limit

The power of any emission outside of the authorized operating frequency ranges must be attenuated below the transmitting power (P) by a factor of at least $43 + 10 \log(P)$ dB.

6.10. Transient Frequency Behavior

6.10.1. Test Setup

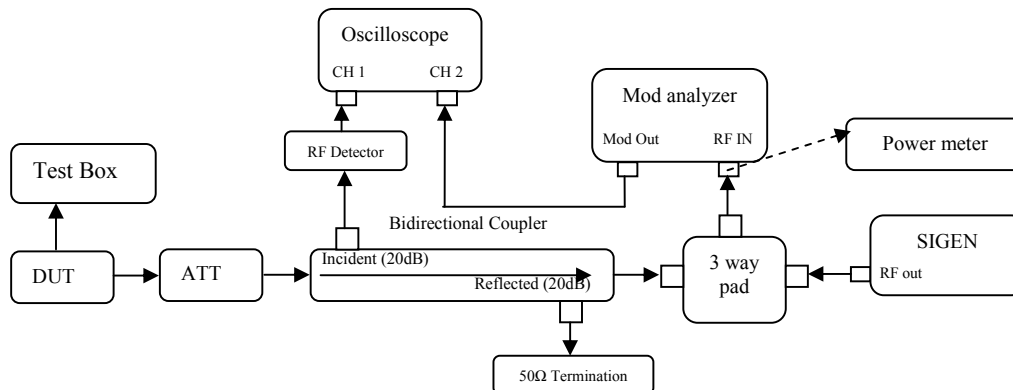

- 1) Connect the setup as figure above.
- 2) Path loss for the measurement included.
- 3) Set on Sigen with the assigned center frequency, internal 1 kHz FM tone.
FM Deviation: Analog 25kHz Channel Spacing = 25 kHz
Analog 12.5 kHz Channel Spacing = 12.5 kHz
C4FM = 12.5 kHz
- 4) Turn on 50 kHz high pass filter and 15 kHz low pass filter on modulation analyzer.
- 5) Supply sufficient attenuation ATT to provide the output power of $\leq -11\text{dBm}$ into power meter when DUT is keying up.
- 6) Note the power level on power meter and dekey the DUT.
- 7) Adjust the amplitude of the signal generator to the level power meter, maintained the amplitude throughout the rest of the measurement.
- 8) Connect the output to modulation analyzer.
- 9) Reduce 30dB attenuation and transmit the radio to get the trigger line.
- 10) Capture the screen shot for key-up (rising edge) and de-key (falling edge) mode.

6.10.2. Test Result

NA → Not Applicable

6.10.3. Test Limit

Transmitters designed to operate in the 150-174 MHz and 421-512 MHz frequency bands must maintain transient frequencies within the maximum frequency difference limits during the time intervals indicated:

Time intervals ^{1 2}	Maximum frequency difference ³	All equipment	
		150 to 174 MHz	421 to 512 MHz
Transient Frequency Behavior for Equipment Designed to Operate on 25 kHz Channels			
t ₁ ⁴	±25.0 kHz	5.0 ms	10.0 ms
t ₂	±12.5 kHz	20.0 ms	25.0 ms
t ₃ ⁴	±25.0 kHz	5.0 ms	10.0 ms
Transient Frequency Behavior for Equipment Designed to Operate on 12.5 kHz Channels			
t ₁ ⁴	±12.5 kHz	5.0 ms	10.0 ms
t ₂	±6.25 kHz	20.0 ms	25.0 ms
t ₃ ⁴	±12.5 kHz	5.0 ms	10.0 ms
Transient Frequency Behavior for Equipment Designed to Operate on 6.25 kHz Channels			
t ₁ ⁴	±6.25 kHz	5.0 ms	10.0 ms
t ₂	±3.125 kHz	20.0 ms	25.0 ms
t ₃ ⁴	±6.25 kHz	5.0 ms	10.0 ms

¹_{on} is the instant when a 1 kHz test signal is completely suppressed, including any capture time due to phasing.

t₁ is the time period immediately following t_{on}.

t₂ is the time period immediately following t₁.

t₃ is the time period from the instant when the transmitter is turned off until t_{off}.

t_{off} is the instant when the 1 kHz test signal starts to rise.

² During the time from the end of t₂ to the beginning of t₃, the frequency difference must not exceed the limits specified in §90.213.

³ Difference between the actual transmitter frequency and the assigned transmitter frequency.

⁴ If the transmitter carrier output power rating is 6 watts or less, the frequency difference during this time period may exceed the maximum frequency difference for this time period.

6.11. Adjacent Channel Power

6.11.1. Test Setup (Analog)

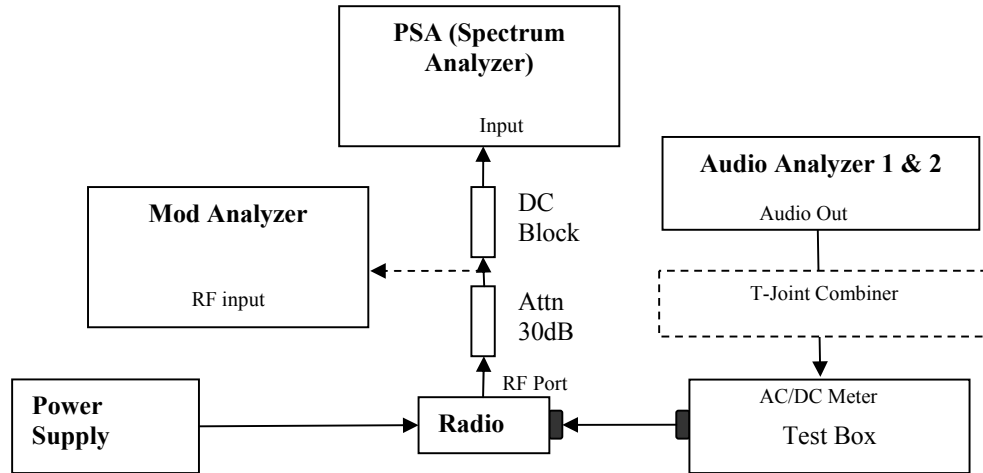

- 1) The DUT transmitter output port was connected to modulation analyzer.
- 2) Transmit the radio and turn on 1st audio analyzer with audio frequency 650Hz, 50% rated deviation, and record the amplitude value as AmpT1.
- 3) Turn off Audio analyzer 1 and turn on audio analyzer 2, set the audio frequency to 2.2 kHz and 50% deviation. Record the amplitude as AmpT2.
- 4) Turn both audio analyzers ON and up 10dB amplitude level.
- 5) Connect the output to PSA and set to assigned center frequency.
- 6) Set Span, Resolution Bandwidth and Video Bandwidth per rules part.
- 7) Transmit the radio and record the Adjacent Channel Power value in dBc.

6.11.2. Test Result

NA → Not Applicable

6.11.3. Test Setup (Digital)

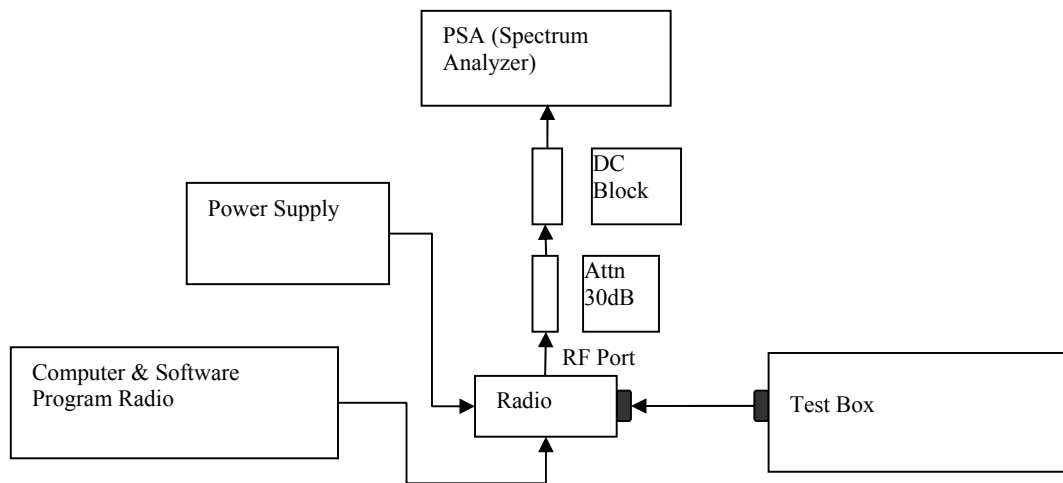

- 1) Program and set radio to operate in desire test frequency and digital mode with modulation. (4FSK, C4FM or other digital modulation form).
- 2) Prepare setup as per picture.
- 3) Turn on the ACP Measurement – Press Measure, ACP.
- 4) Set Span, Resolution Bandwidth and Video Bandwidth as per rules part.
- 5) Transmit the radio and record the Adjacent Channel Power value in dBc.

6.11.4. Test Result NA → Not Applicable

Test Limit

12.5 kHz MOBILE TRANSMITTER ACP REQUIREMENTS

Offset from center frequency (kHz)	Measurement bandwidth (kHz)	Maximum ACP relative (dBc)
9.375	6.25	-40
15.625	6.25	-60
21.875	6.25	-60
37.50	25.00	-60
62.50	25.00	-65
87.50	25.00	-65
150.00	100	-65
250.00	100	-65
350.00	100	-65
>400 to 12 MHz	30 (s)	-75
12 MHz to paired receive band	30 (s)	-75
In the paired receive band	30 (s)	-100

25 kHz MOBILE TRANSMITTER ACP REQUIREMENTS

Offset from center frequency (kHz)	Measurement bandwidth (kHz)	Maximum ACP relative (dBc)
15.625	6.25	-40
21.875	6.25	-60
37.50	25	-60
62.50	25	-65
87.50	25	-65
150.00	100	-65
250.00	100	-65
350.00	100	-65
>400 kHz to 12 MHz	30 (s)	-75
12 MHz to paired receive band	30 (s)	-75
In the paired receive band	30 (s)	-100

12.5 kHz BASE TRANSMITTER ACP REQUIREMENTS

Offset from center frequency (kHz)	Measurement bandwidth (kHz)	Maximum ACP (dBc)
9.375	6.25	-40
15.625	6.25	-60
21.875	6.25	-60
37.5	25	-60
62.5	25	-65
87.5	25	-65
150	100	-65
250	100	-65
350.00	100	-65
>400 kHz to 12 MHz	30 (s)	-80
12 MHz to paired receive band	30 (s)	-80
In the paired receive band	30 (s)	-85

25 kHz BASE TRANSMITTER ACP REQUIREMENTS

Offset from center frequency (kHz)	Measurement bandwidth (kHz)	Maximum ACP (dBc)
15.625	6.25	-40
21.875	6.25	-60
37.5	25	-60
62.5	25	-65
87.5	25	-65
150	100	-65
250	100	-65
350	100.00	-65
>400 kHz to 12 MHz	30 (s)	-80
12 MHz to paired receive band	30 (s)	-80
In the paired receive band	30 (s)	-85

6.12. Conducted Spurious Emission

6.12.1. Test Setup

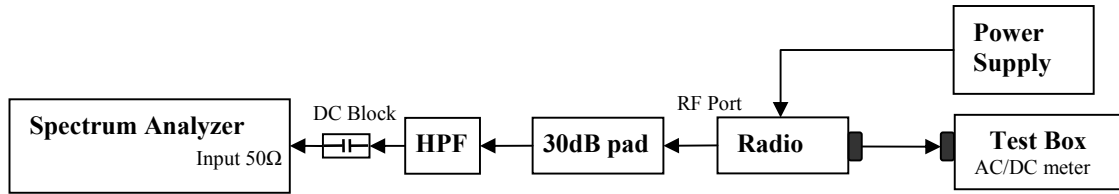

- 1) The DUT transmitter output port was connected to Spectrum Analyzer with above setup.
- 2) Program and set radio to operate in desire test frequency and mode. (Analog / digital modulation form).
- 3) Path loss for the measurement included.
- 4) Set the PSA Resolution Bandwidth as per rules part.
- 5) Set the Ref offset from the pathloss offset calibration file.
- 6) Adjust the center frequency of the spectrum analyzer for incremental coverage of the range from:
 - a. 9 KHz to $F_c - \text{Test Bandwidth}$
 - b. $F_c + \text{Test Bandwidth}$ to $2F_c - 5\text{MHz}$.
- 7) Key up the DUT, Peak Search the highest Spur and record the levels of spurious emissions
- 8) Dekey the DUT.
- 9) Turn On High Pass Filter path and Key up the DUT.
- 10) Adjust the PSA Freq for incremental coverage of range from $2F_c$ to $10F_c$
- 11) Key up the DUT and record the highest spur levels of spurious emissions.

6.12.2. Test Result (Analog)

Analog: 806.0125 MHz, 25.0kHz Channel Spacing, Max Power

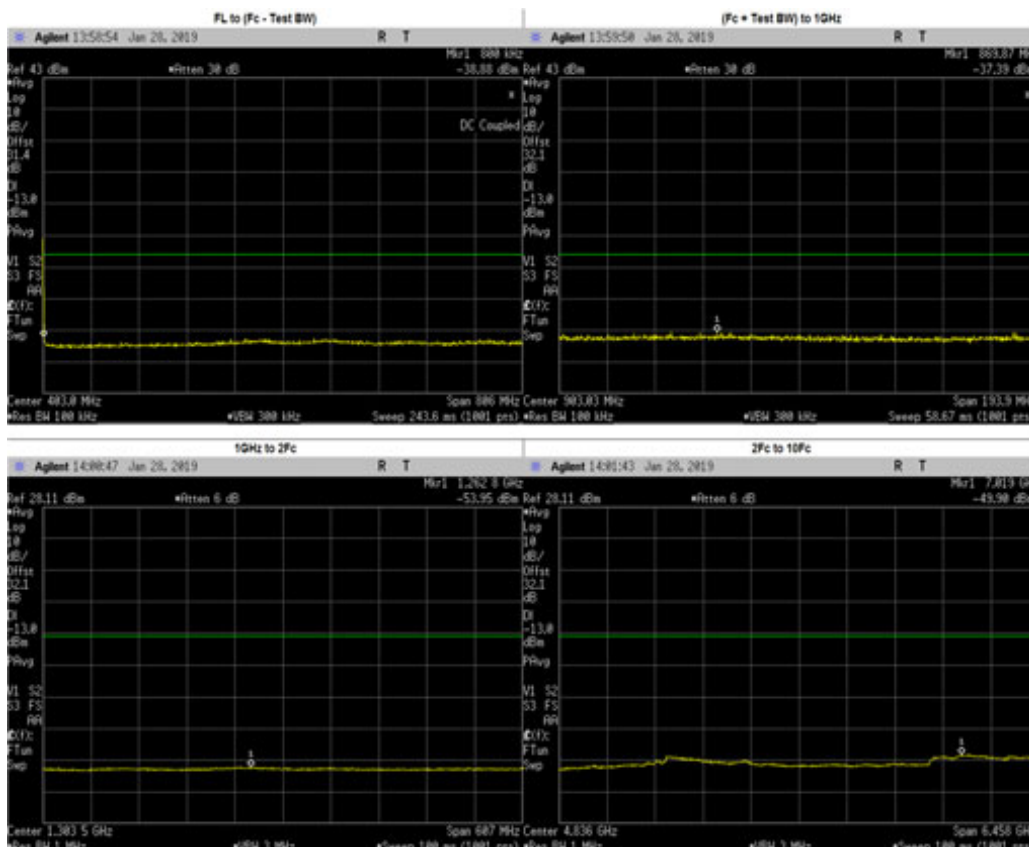

Frequency Range	Highest Spur Frequency (MHz)	Spurious Level (MHz)	Failing Limit (dBm)	Results
FL to (Fc - Test BW)	455.3727	-39.56	-13	PASS
(Fc + Test BW) to 1GHz	869.8679	-37.39	-13	PASS
1GHz to 2Fc	1262.8420	-53.95	-13	PASS
2Fc to 10Fc	7018.9130	-49.90	-13	PASS
	1612.0250	-54.75	-13	PASS
	2418.0370	-53.68	-13	PASS
	3224.0500	-51.31	-13	PASS
	4030.0620	-52.54	-13	PASS
	4836.0750	-53.63	-13	PASS
	5642.0870	-53.65	-13	PASS
	6448.1000	-53.35	-13	PASS
	7254.1130	-50.69	-13	PASS
	8060.1250	-51.45	-13	PASS

Analog: 814.9875 MHz, 25.0kHz Channel Spacing, Max Power

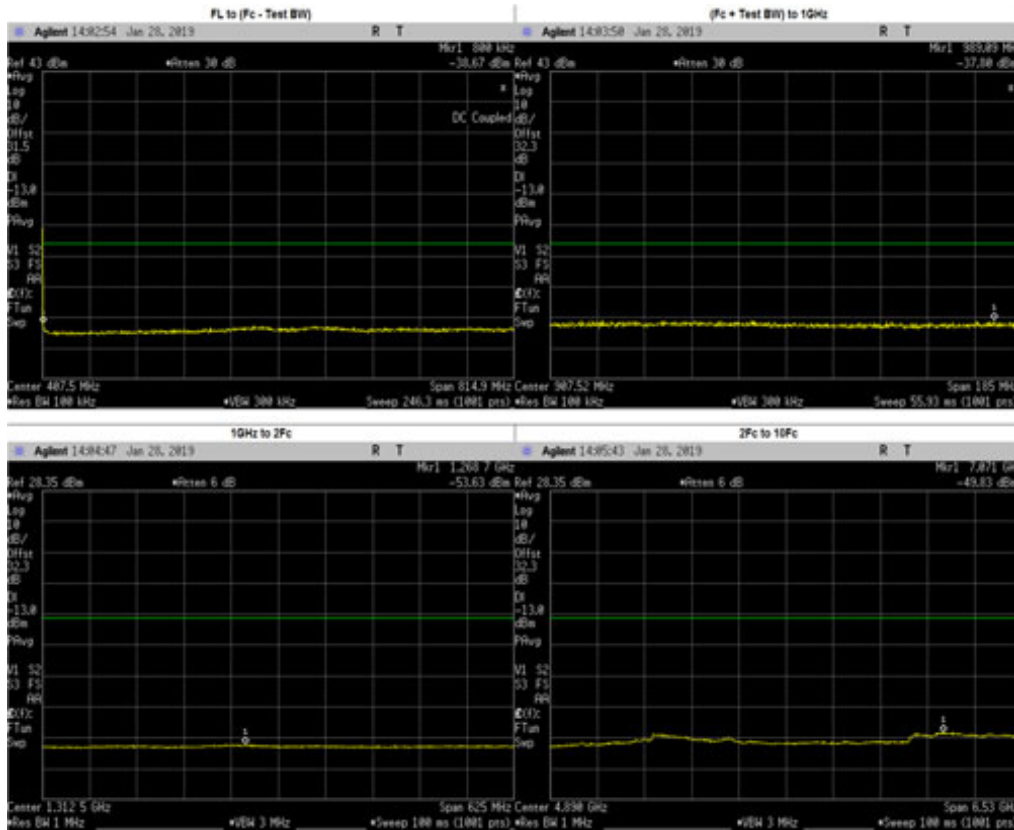

Frequency Range	Highest Spur Frequency (MHz)	Spurious Level (MHz)	Failing Limit (dBm)	Results
FL to (Fc - Test BW)	365.9119	-39.62	-13	PASS
(Fc + Test BW) to 1GHz	989.0872	-37.80	-13	PASS
1GHz to 2Fc	1268.7390	-53.63	-13	PASS
2Fc to 10Fc	7070.9120	-49.83	-13	PASS
	1629.9750	-54.46	-13	PASS
	2444.9630	-53.38	-13	PASS
	3259.9500	-51.06	-13	PASS
	4074.9370	-52.06	-13	PASS
	4889.9250	-53.42	-13	PASS
	5704.9130	-53.10	-13	PASS
	6519.9000	-52.97	-13	PASS
	7334.8870	-50.65	-13	PASS
8149.8750	-51.50	-13	PASS	

Analog: 823.9875 MHz, 25.0kHz Channel Spacing, Max Power

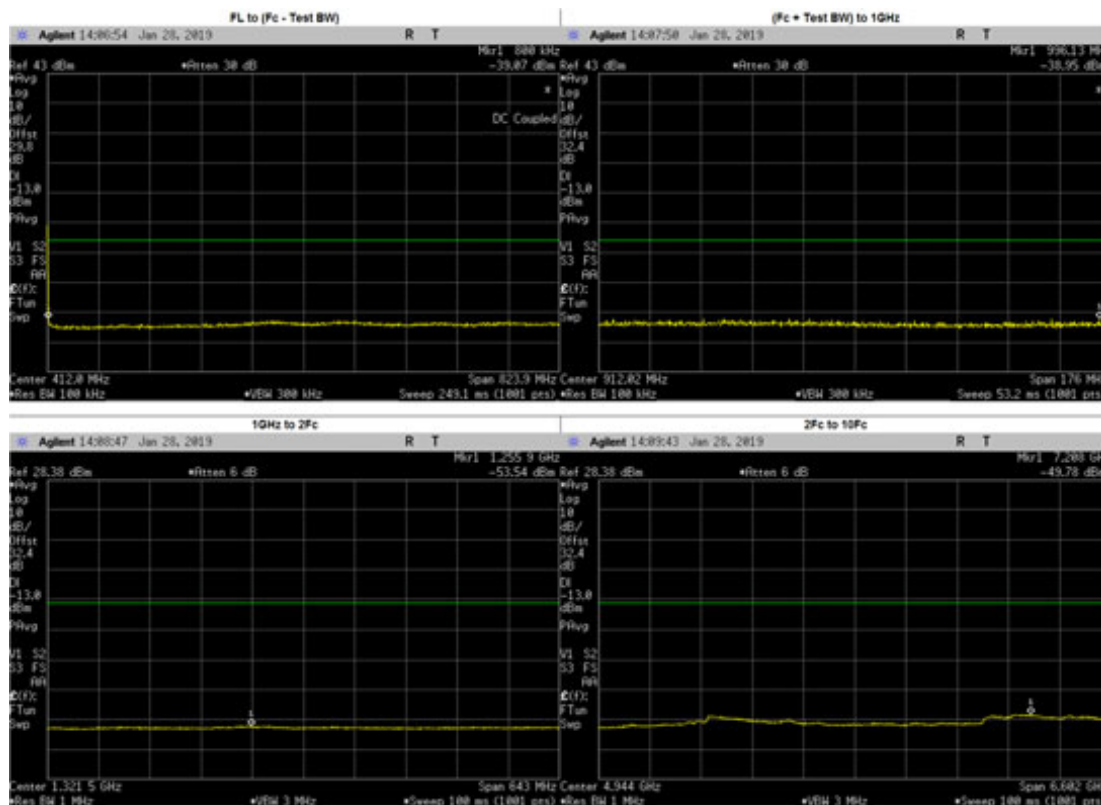

Frequency Range	Highest Spur Frequency (MHz)	Spurious Level (MHz)	Failing Limit (dBm)	Results
FL to (Fc - Test BW)	495.1900	-39.68	-13	PASS
(Fc + Test BW) to 1GHz	996.1288	-38.95	-13	PASS
1GHz to 2Fc	1255.9040	-53.54	-13	PASS
2Fc to 10Fc	7208.3770	-49.78	-13	PASS
	1647.9750	-54.32	-13	PASS
	2471.9630	-53.35	-13	PASS
	3295.9500	-51.13	-13	PASS
	4119.9370	-52.00	-13	PASS
	4943.9250	-53.16	-13	PASS
	5767.9130	-52.96	-13	PASS
	6591.9000	-52.73	-13	PASS
	7415.8870	-51.01	-13	PASS
8239.8750	-51.59	-13	PASS	

Analog: 851.0125 MHz, 25.0kHz Channel Spacing, Max Power

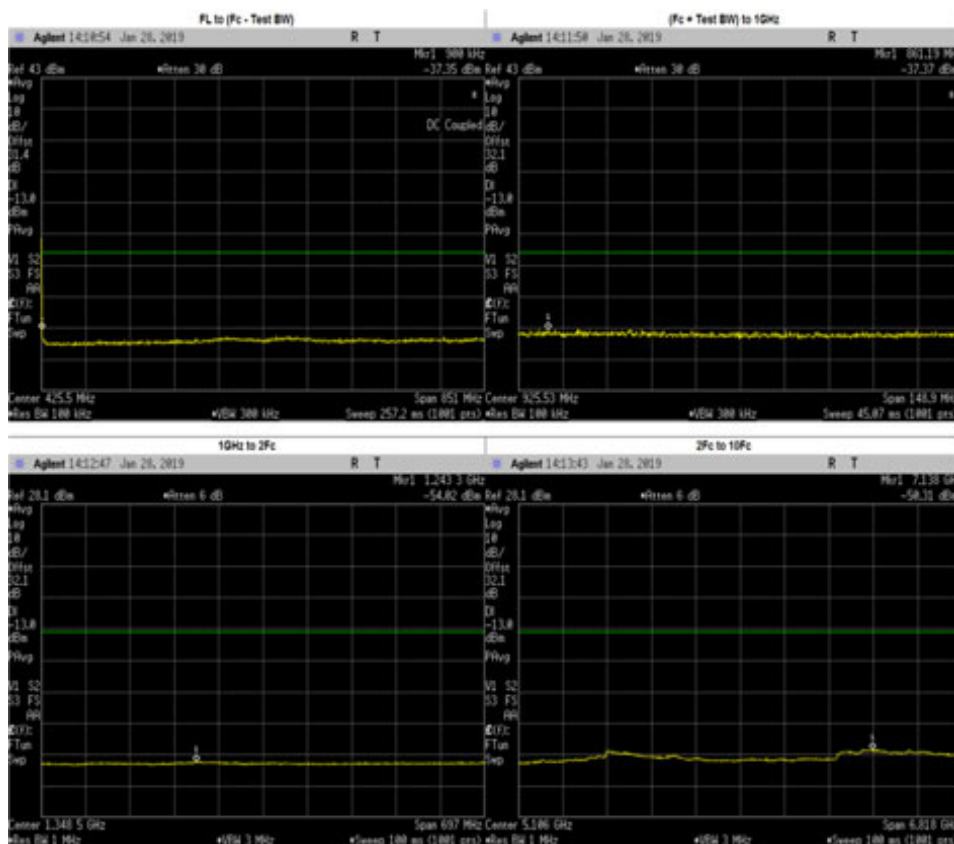

Frequency Range	Highest Spur Frequency (MHz)	Spurious Level (MHz)	Failing Limit (dBm)	Results
FL to (Fc - Test BW)	450.1634	-39.54	-13	PASS
(Fc + Test BW) to 1GHz	861.1902	-37.37	-13	PASS
1GHz to 2Fc	1243.2620	-54.02	-13	PASS
2Fc to 10Fc	7137.8690	-50.31	-13	PASS
	1702.0250	-54.69	-13	PASS
	2553.0370	-53.69	-13	PASS
	3404.0500	-51.56	-13	PASS
	4255.0620	-53.32	-13	PASS
	5106.0750	-53.60	-13	PASS
	5957.0870	-53.60	-13	PASS
	6808.1000	-50.90	-13	PASS
	7659.1130	-51.11	-13	PASS
8510.1250	-51.36	-13	PASS	

Analog: 860.0125 MHz, 25.0kHz Channel Spacing, Max Power

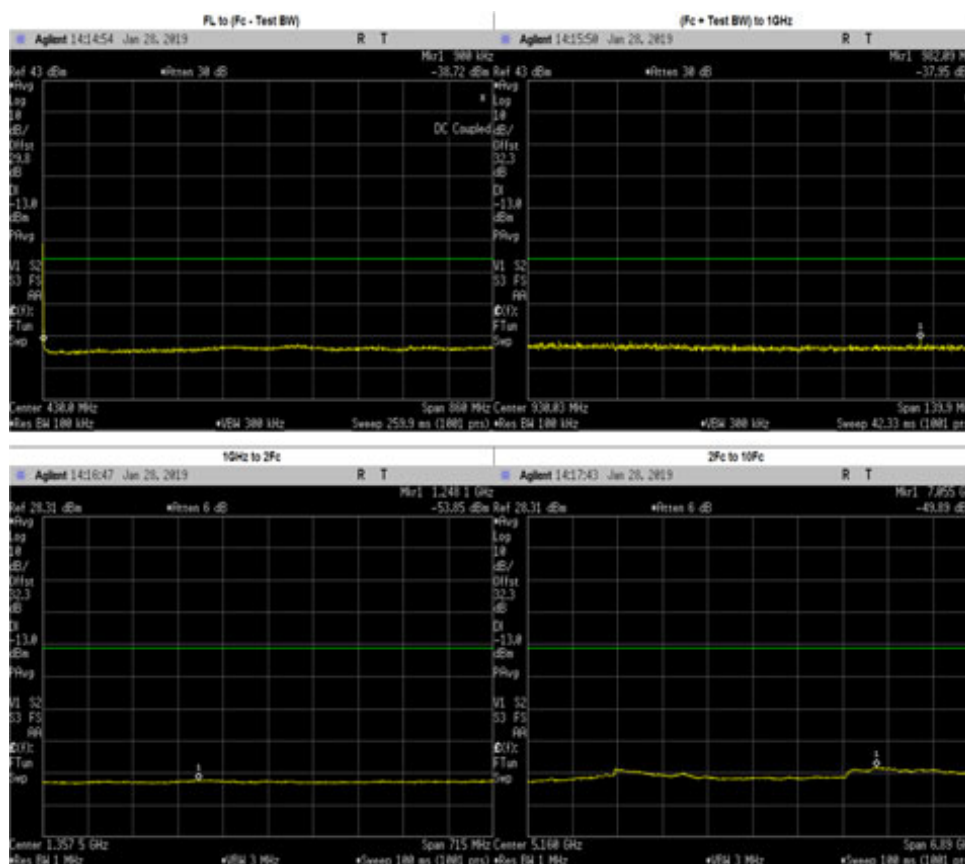

Frequency Range	Highest Spur Frequency (MHz)	Spurious Level (MHz)	Failing Limit (dBm)	Results
FL to (Fc - Test BW)	487.6026	-39.55	-13	PASS
(Fc + Test BW) to 1GHz	982.0880	-37.95	-13	PASS
1GHz to 2Fc	1248.1140	-53.85	-13	PASS
2Fc to 10Fc	7054.8520	-49.89	-13	PASS
	1720.0250	-54.21	-13	PASS
	2580.0370	-53.13	-13	PASS
	3440.0500	-51.36	-13	PASS
	4300.0620	-53.22	-13	PASS
	5160.0750	-53.33	-13	PASS
	6020.0870	-53.13	-13	PASS
	6880.1000	-51.09	-13	PASS
	7740.1130	-50.76	-13	PASS
	8600.1250	-51.42	-13	PASS

Analog: 868.8875 MHz, 25.0kHz Channel Spacing, Max Power

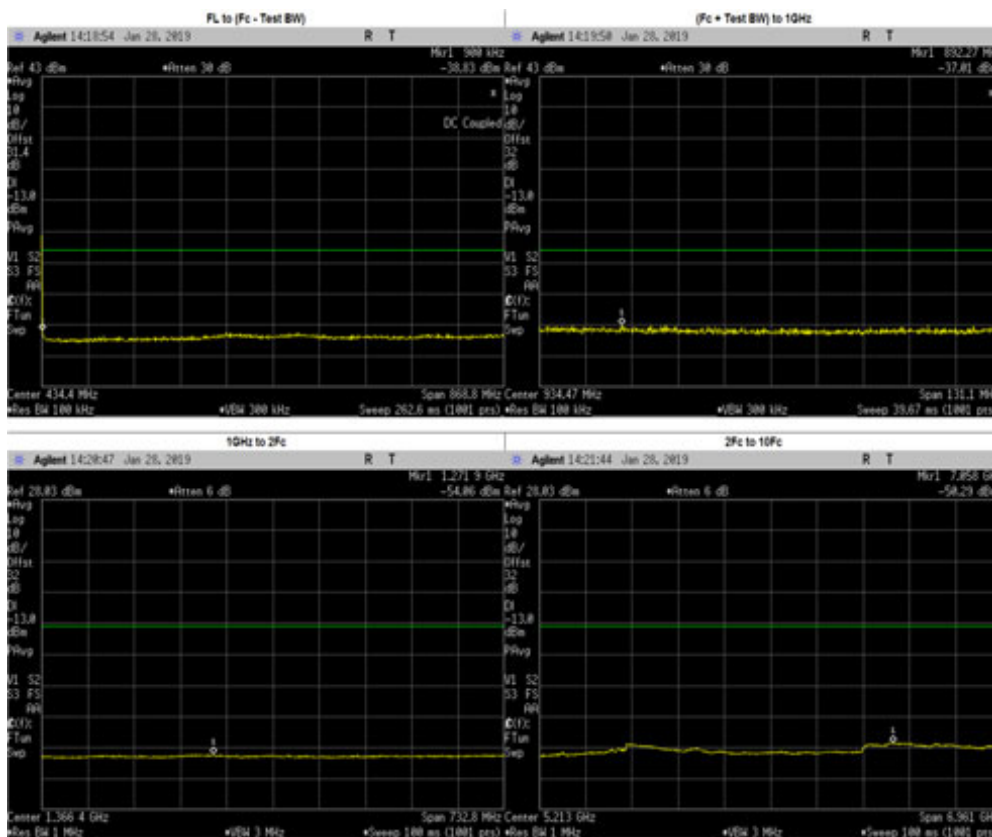

Frequency Range	Highest Spur Frequency (MHz)	Spurious Level (MHz)	Failing Limit (dBm)	Results
FL to (Fc - Test BW)	481.3400	-39.53	-13	PASS
(Fc + Test BW) to 1GHz	892.2666	-37.01	-13	PASS
1GHz to 2Fc	1271.8600	-54.06	-13	PASS
2Fc to 10Fc	7058.0160	-50.29	-13	PASS
	1737.7750	-54.77	-13	PASS
	2606.6620	-53.63	-13	PASS
	3475.5500	-51.84	-13	PASS
	4344.4370	-53.36	-13	PASS
	5213.3250	-53.46	-13	PASS
	6082.2120	-53.40	-13	PASS
	6951.1000	-51.21	-13	PASS
	7819.9880	-51.24	-13	PASS
8688.8750	-51.42	-13	PASS	

6.12.3. Test Result (Digital)

Digital: 806.0125 MHz, 12.5kHz Channel Spacing, Max Power

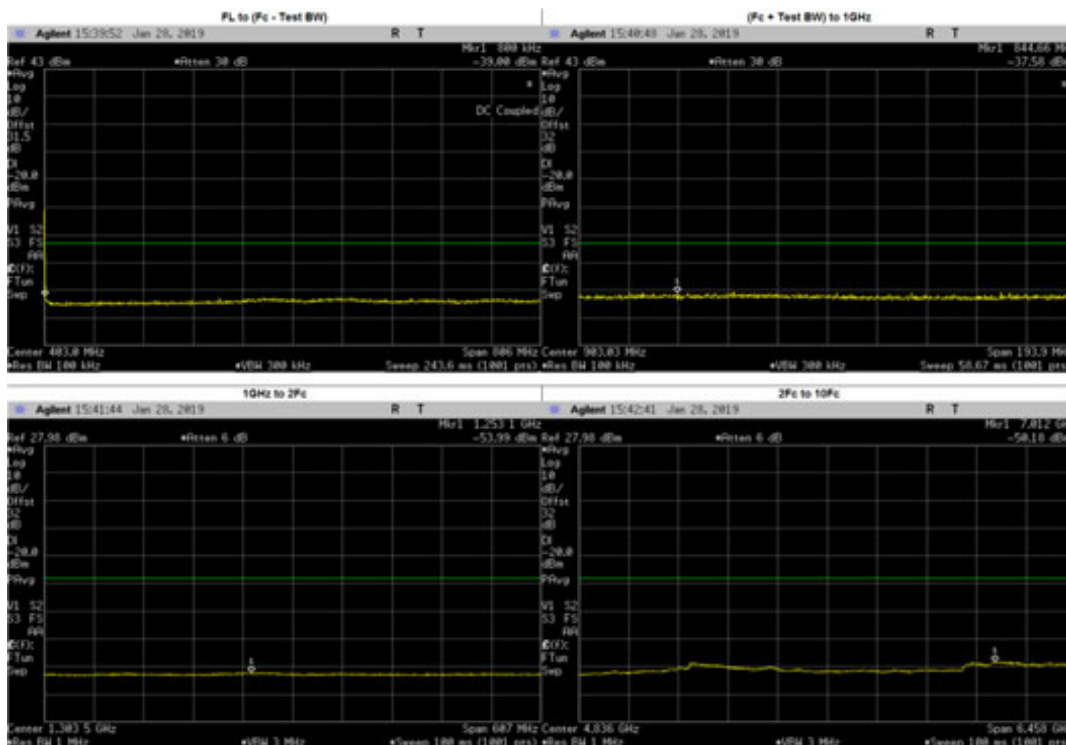

Frequency Range	Highest Spur Frequency (MHz)	Spurious Level (MHz)	Failing Limit (dBm)	Results
FL to (Fc - Test BW)	370.7476	-39.85	-20	PASS
(Fc + Test BW) to 1GHz	844.6561	-37.58	-20	PASS
1GHz to 2Fc	1253.1290	-53.99	-20	PASS
2Fc to 10Fc	7012.4550	-50.18	-20	PASS
	1612.0250	-54.79	-20	PASS
	2418.0370	-54.01	-20	PASS
	3224.0500	-51.46	-20	PASS
	4030.0620	-52.55	-20	PASS
	4836.0750	-53.72	-20	PASS
	5642.0870	-53.73	-20	PASS
	6448.1000	-53.12	-20	PASS
	7254.1130	-50.76	-20	PASS
8060.1250	-51.74	-20	PASS	

Digital: 814.9875 MHz, 12.5kHz Channel Spacing, Max Power

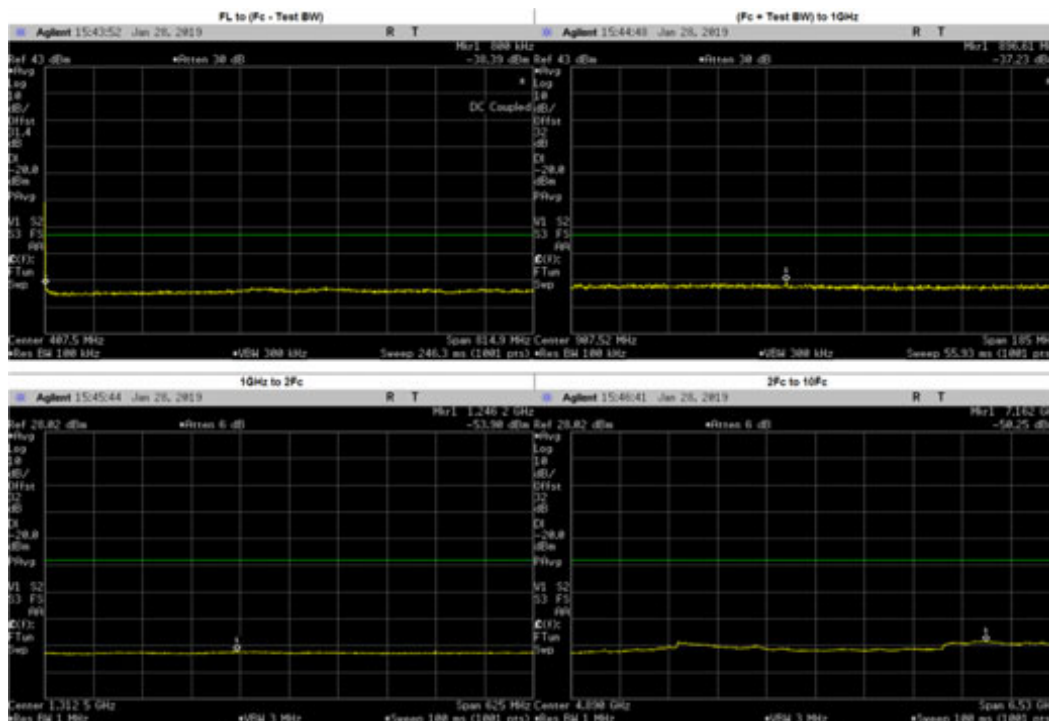

Frequency Range	Highest Spur Frequency (MHz)	Spurious Level (MHz)	Failing Limit (dBm)	Results
FL to (Fc - Test BW)	468.5929	-39.50	-20	PASS
(Fc + Test BW) to 1GHz	896.6060	-37.23	-20	PASS
1GHz to 2Fc	1246.2400	-53.90	-20	PASS
2Fc to 10Fc	7162.3300	-50.25	-20	PASS
	1629.9750	-54.77	-20	PASS
	2444.9630	-53.82	-20	PASS
	3259.9500	-51.43	-20	PASS
	4074.9370	-52.43	-20	PASS
	4889.9250	-53.59	-20	PASS
	5704.9130	-53.31	-20	PASS
	6519.9000	-53.45	-20	PASS
	7334.8870	-50.96	-20	PASS
8149.8750	-51.89	-20	PASS	

Digital: 823.9875 MHz, 12.5kHz Channel Spacing, Max Power

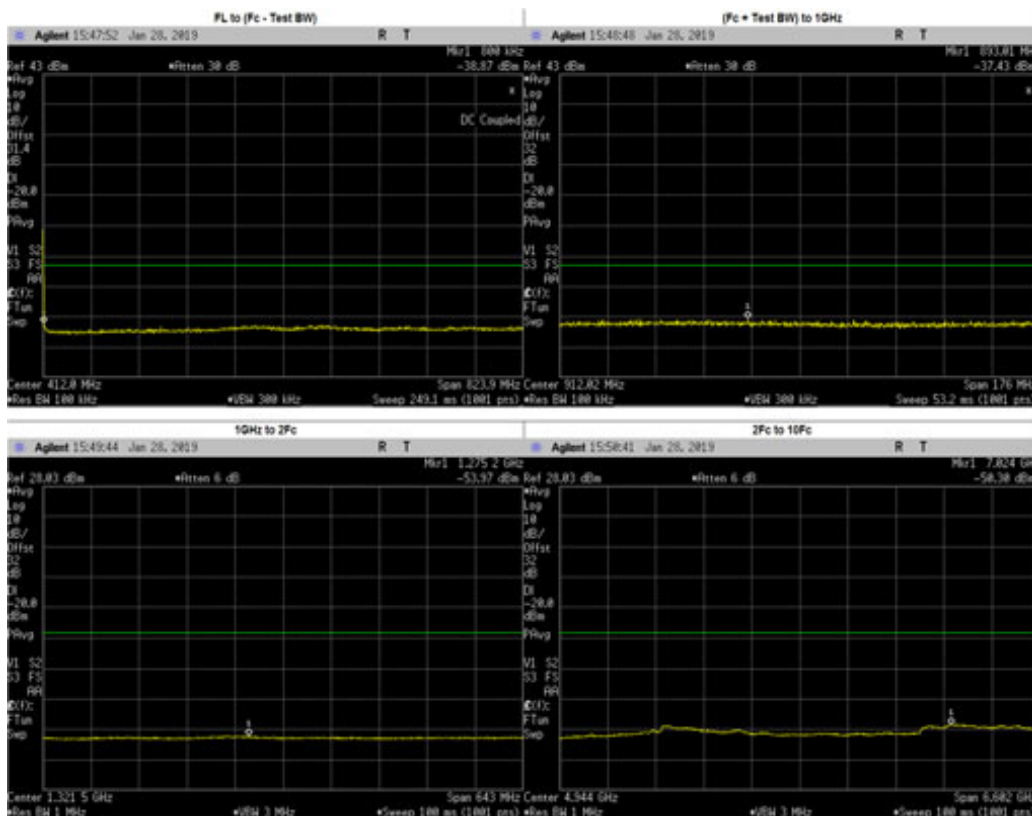

Frequency Range	Highest Spur Frequency (MHz)	Spurious Level (MHz)	Failing Limit (dBm)	Results
FL to (Fc - Test BW)	473.7679	-39.85	-20	PASS
(Fc + Test BW) to 1GHz	893.0148	-37.43	-20	PASS
1GHz to 2Fc	1275.1930	-53.97	-20	PASS
2Fc to 10Fc	7023.5240	-50.30	-20	PASS
	1647.9750	-54.90	-20	PASS
	2471.9630	-53.65	-20	PASS
	3295.9500	-51.60	-20	PASS
	4119.9370	-52.27	-20	PASS
	4943.9250	-53.69	-20	PASS
	5767.9130	-53.24	-20	PASS
	6591.9000	-53.32	-20	PASS
	7415.8870	-51.28	-20	PASS
	8239.8750	-51.68	-20	PASS

Digital: 851.0125 MHz, 12.5kHz Channel Spacing, Max Power

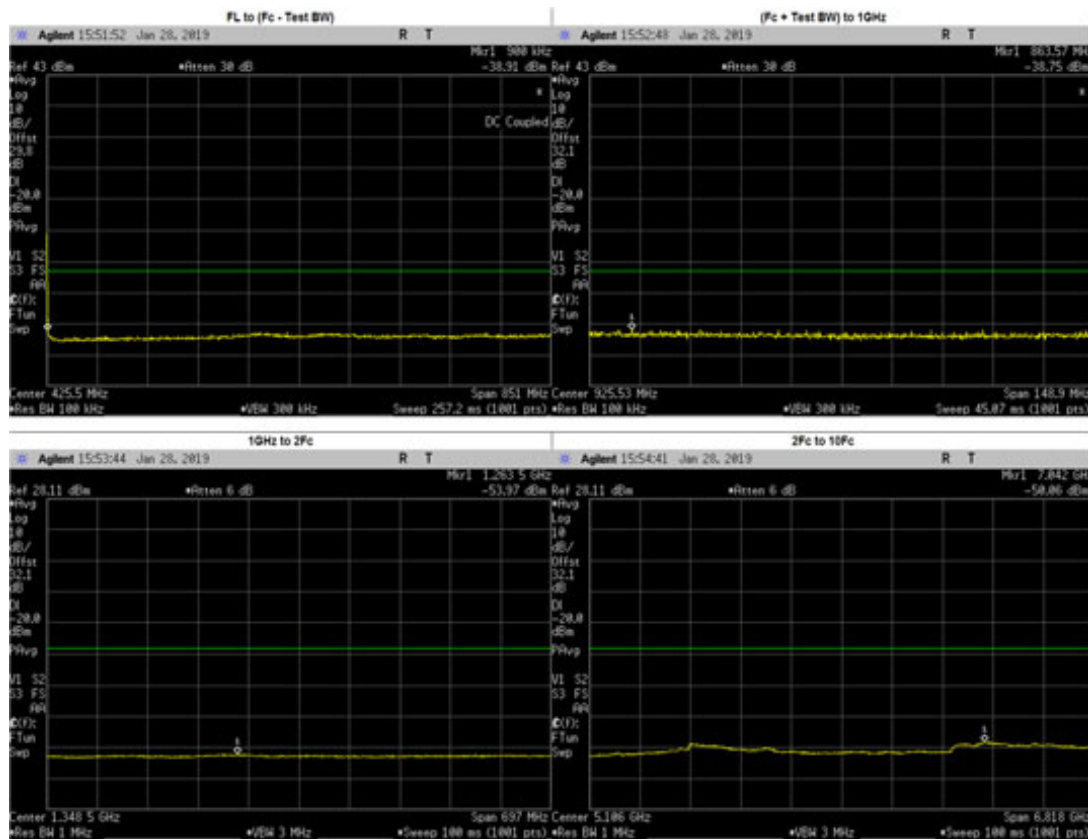

Frequency Range	Highest Spur Frequency (MHz)	Spurious Level (MHz)	Failing Limit (dBm)	Results
FL to (Fc - Test BW)	742.0405	-37.74	-20	PASS
(Fc + Test BW) to 1GHz	863.5733	-38.75	-20	PASS
1GHz to 2Fc	1263.4750	-53.97	-20	PASS
2Fc to 10Fc	7042.4150	-50.06	-20	PASS
	1702.0250	-54.59	-20	PASS
	2553.0370	-53.49	-20	PASS
	3404.0500	-51.70	-20	PASS
	4255.0620	-53.12	-20	PASS
	5106.0750	-53.68	-20	PASS
	5957.0870	-53.56	-20	PASS
	6808.1000	-50.99	-20	PASS
	7659.1130	-51.07	-20	PASS
8510.1250	-51.17	-20	PASS	

Digital: 860.0125 MHz, 12.5kHz Channel Spacing, Max Power

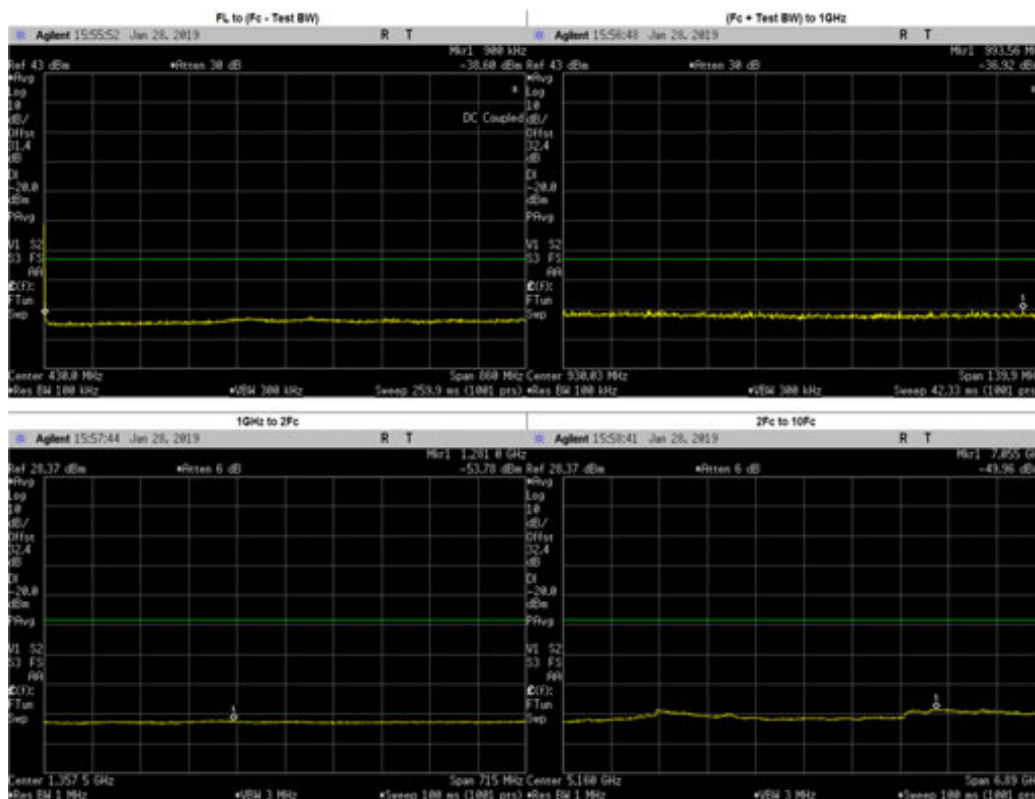

Frequency Range	Highest Spur Frequency (MHz)	Spurious Level (MHz)	Failing Limit (dBm)	Results
FL to (Fc - Test BW)	475.5633	-39.39	-20	PASS
(Fc + Test BW) to 1GHz	993.5629	-36.92	-20	PASS
1GHz to 2Fc	1281.0050	-53.78	-20	PASS
2Fc to 10Fc	7054.8520	-49.96	-20	PASS
	1720.0250	-54.39	-20	PASS
	2580.0370	-53.30	-20	PASS
	3440.0500	-51.25	-20	PASS
	4300.0620	-53.01	-20	PASS
	5160.0750	-52.93	-20	PASS
	6020.0870	-52.69	-20	PASS
	6880.1000	-51.10	-20	PASS
	7740.1130	-50.66	-20	PASS
8600.1250	-51.30	-20	PASS	

Digital: 868.8875 MHz, 12.5kHz Channel Spacing, Max Power

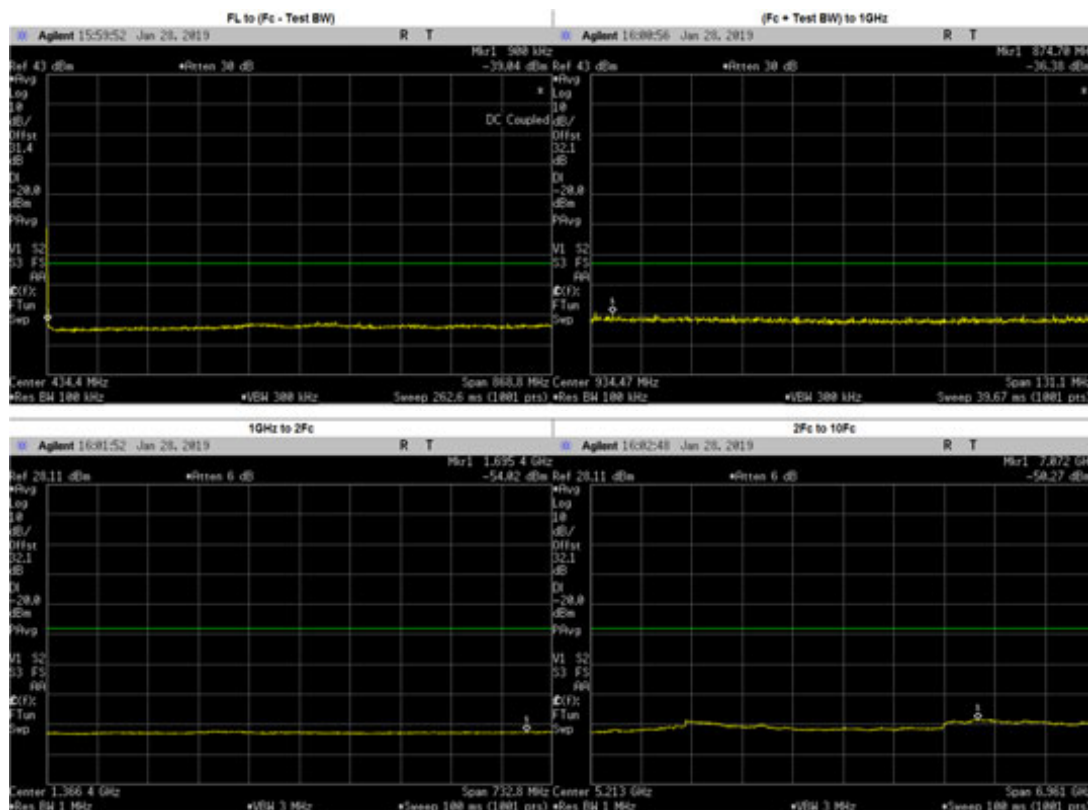

Frequency Range	Highest Spur Frequency (MHz)	Spurious Level (MHz)	Failing Limit (dBm)	Results
FL to (Fc - Test BW)	465.7011	-39.43	-20	PASS
(Fc + Test BW) to 1GHz	874.7043	-36.38	-20	PASS
1GHz to 2Fc	1695.4030	-54.02	-20	PASS
2Fc to 10Fc	7071.9390	-50.27	-20	PASS
	1737.7750	-54.41	-20	PASS
	2606.6620	-53.55	-20	PASS
	3475.5500	-51.63	-20	PASS
	4344.4370	-53.11	-20	PASS
	5213.3250	-53.27	-20	PASS
	6082.2120	-53.10	-20	PASS
	6951.1000	-51.11	-20	PASS
	7819.9880	-51.13	-20	PASS
8688.8750	-51.42	-20	PASS	

Phase II: 806.0125 MHz, 12.5kHz Channel Spacing, Max Power

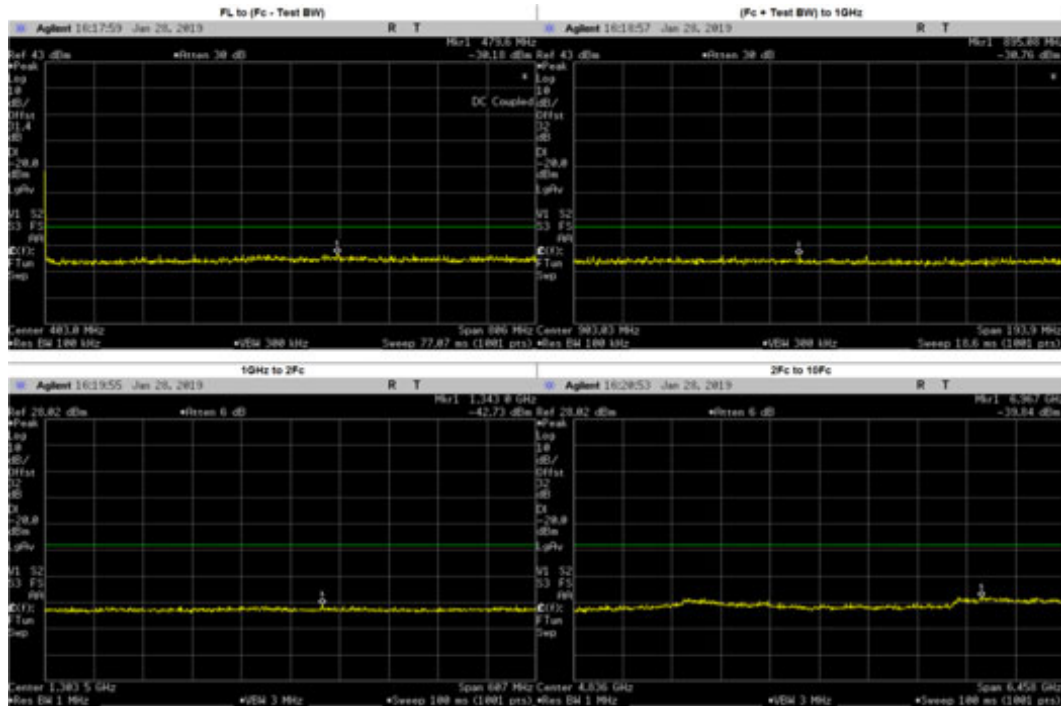

Frequency Range	Highest Spur Frequency (MHz)	Spurious Level (MHz)	Failing Limit (dBm)	Results
FL to (Fc - Test BW)	479.5513	-30.18	-20	PASS
(Fc + Test BW) to 1GHz	895.0798	-30.76	-20	PASS
1GHz to 2Fc	1342.9690	-42.73	-20	PASS
2Fc to 10Fc	6967.2480	-39.84	-20	PASS
	1612.0250	-44.67	-20	PASS
	2418.0370	-43.92	-20	PASS
	3224.0500	-41.54	-20	PASS
	4030.0620	-43.16	-20	PASS
	4836.0750	-44.15	-20	PASS
	5642.0870	-43.93	-20	PASS
	6448.1000	-43.51	-20	PASS
	7254.1130	-41.33	-20	PASS
8060.1250	-41.08	-20	PASS	

Phase II: 814.9875 MHz, 12.5kHz Channel Spacing, Max Power

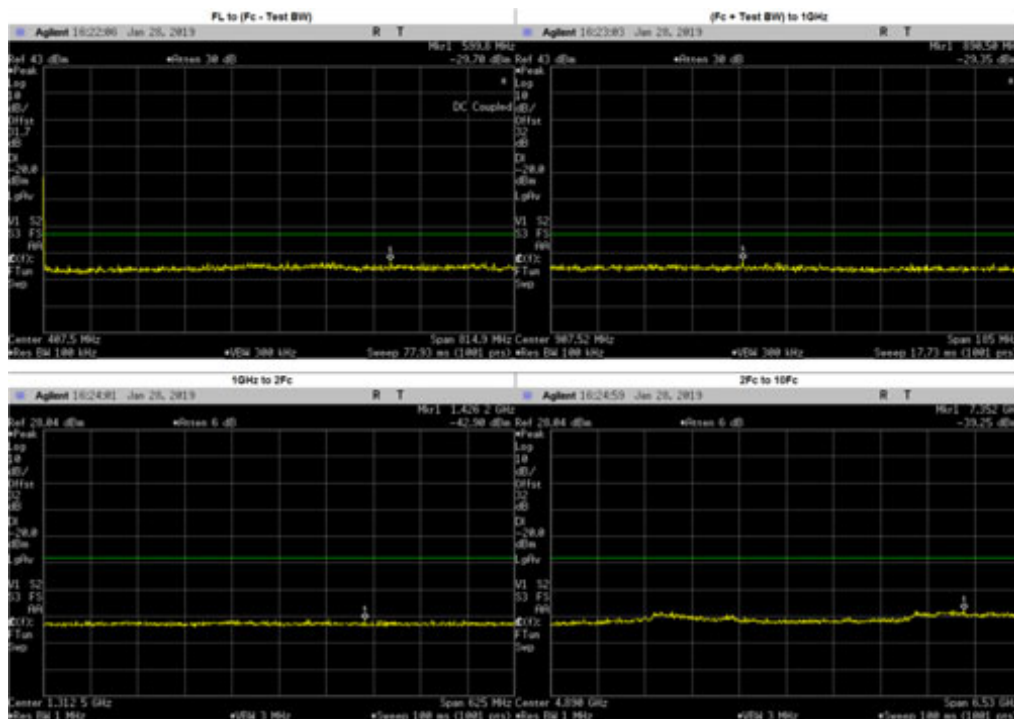

Frequency Range	Highest Spur Frequency (MHz)	Spurious Level (MHz)	Failing Limit (dBm)	Results
FL to (Fc - Test BW)	599.7964	-29.70	-20	PASS
(Fc + Test BW) to 1GHz	890.5022	-29.35	-20	PASS
1GHz to 2Fc	1426.2330	-42.90	-20	PASS
2Fc to 10Fc	7351.6970	-39.25	-20	PASS
	1629.9750	-45.32	-20	PASS
	2444.9630	-44.23	-20	PASS
	3259.9500	-41.81	-20	PASS
	4074.9370	-42.98	-20	PASS
	4889.9250	-43.96	-20	PASS
	5704.9130	-43.80	-20	PASS
	6519.9000	-43.50	-20	PASS
	7334.8870	-40.72	-20	PASS
8149.8750	-42.55	-20	PASS	

Phase II: 823.9875 MHz, 12.5kHz Channel Spacing, Max Power

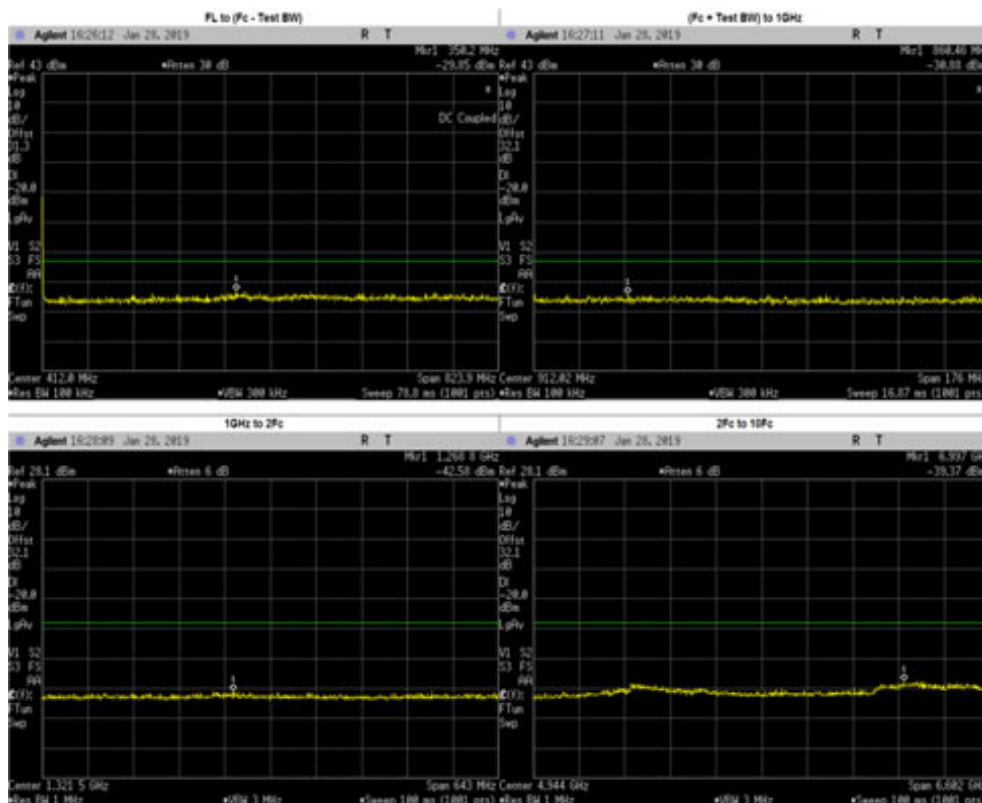

Frequency Range	Highest Spur Frequency (MHz)	Spurious Level (MHz)	Failing Limit (dBm)	Results
FL to (Fc - Test BW)	350.1786	-29.85	-20	PASS
(Fc + Test BW) to 1GHz	860.4617	-30.88	-20	PASS
1GHz to 2Fc	1268.7640	-42.58	-20	PASS
2Fc to 10Fc	6997.1160	-39.37	-20	PASS
	1647.9750	-45.09	-20	PASS
	2471.9630	-43.87	-20	PASS
	3295.9500	-41.32	-20	PASS
	4119.9370	-42.55	-20	PASS
	4943.9250	-43.89	-20	PASS
	5767.9130	-43.59	-20	PASS
	6591.9000	-42.32	-20	PASS
	7415.8870	-41.63	-20	PASS
8239.8750	-42.38	-20	PASS	

Phase II: 851.0125 MHz, 12.5kHz Channel Spacing, Max Power

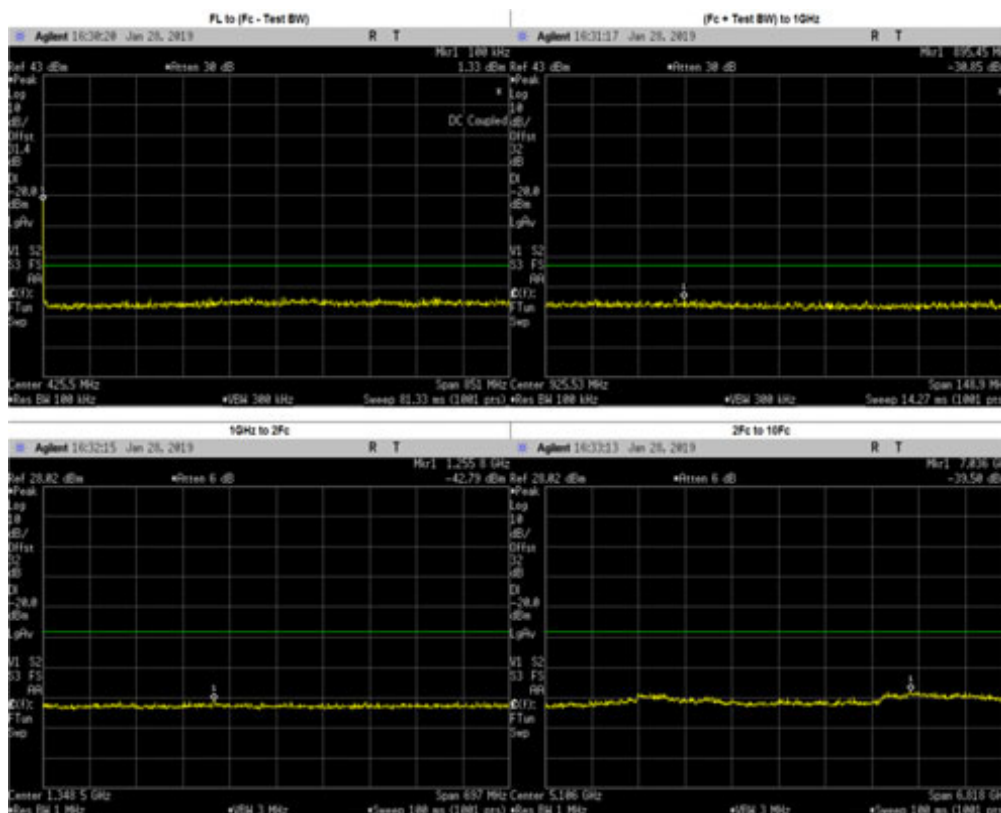

Frequency Range	Highest Spur Frequency (MHz)	Spurious Level (MHz)	Failing Limit (dBm)	Results
FL to (Fc - Test BW)	713.9590	-30.08	-20	PASS
(Fc + Test BW) to 1GHz	895.4459	-30.85	-20	PASS
1GHz to 2Fc	1255.8080	-42.79	-20	PASS
2Fc to 10Fc	7035.5970	-39.50	-20	PASS
	1702.0250	-45.09	-20	PASS
	2553.0370	-44.07	-20	PASS
	3404.0500	-40.94	-20	PASS
	4255.0620	-42.61	-20	PASS
	5106.0750	-43.46	-20	PASS
	5957.0870	-44.33	-20	PASS
	6808.1000	-41.11	-20	PASS
	7659.1130	-41.52	-20	PASS
8510.1250	-41.44	-20	PASS	

Phase II: 860.0125 MHz, 12.5kHz Channel Spacing, Max Power

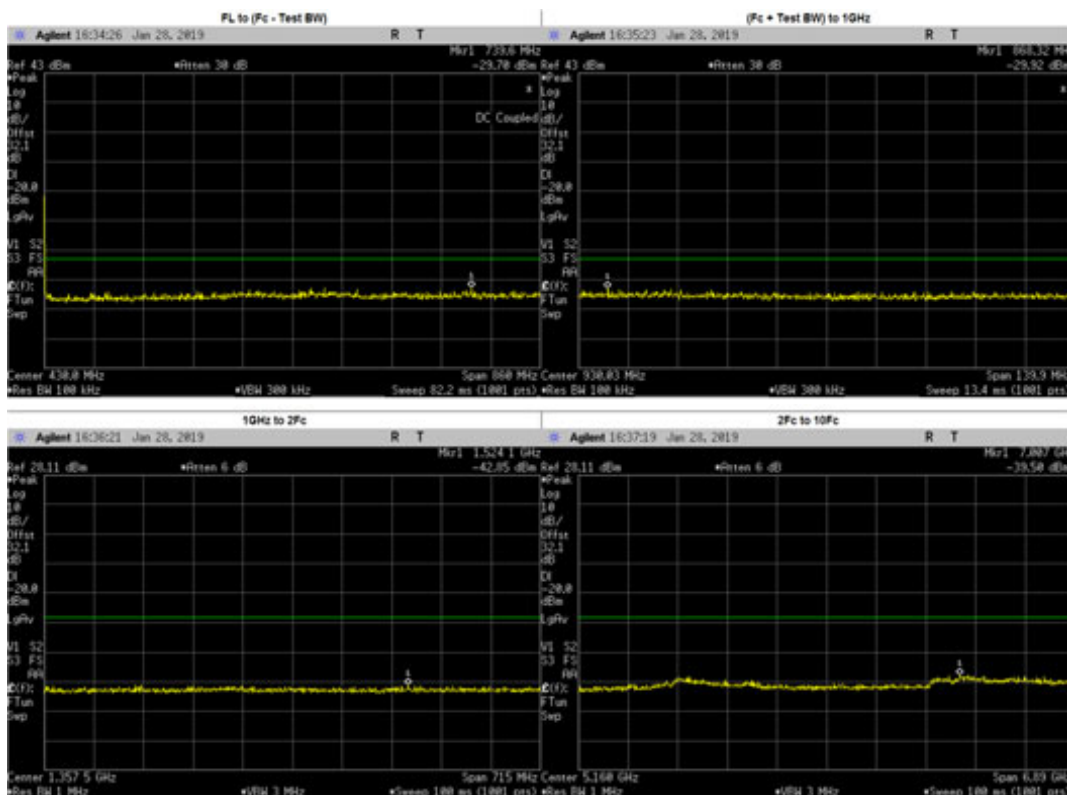

Frequency Range	Highest Spur Frequency (MHz)	Spurious Level (MHz)	Failing Limit (dBm)	Results
FL to (Fc - Test BW)	739.5690	-29.70	-20	PASS
(Fc + Test BW) to 1GHz	868.3188	-29.92	-20	PASS
1GHz to 2Fc	1524.1130	-42.85	-20	PASS
2Fc to 10Fc	7006.6220	-39.50	-20	PASS
	1720.0250	-45.00	-20	PASS
	2580.0370	-44.19	-20	PASS
	3440.0500	-41.69	-20	PASS
	4300.0620	-44.07	-20	PASS
	5160.0750	-43.88	-20	PASS
	6020.0870	-43.53	-20	PASS
	6880.1000	-41.64	-20	PASS
	7740.1130	-41.07	-20	PASS
8600.1250	-42.06	-20	PASS	

Phase II: 868.8875 MHz, 12.5kHz Channel Spacing, Max Power

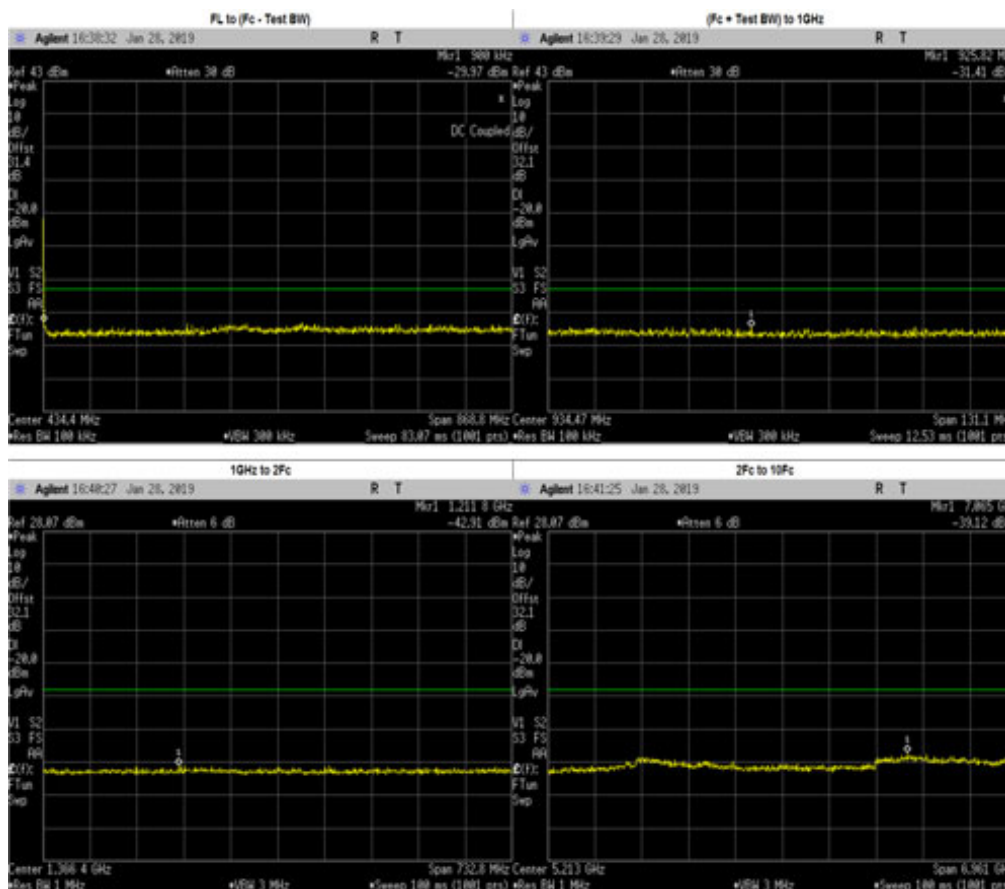

Frequency Range	Highest Spur Frequency (MHz)	Spurious Level (MHz)	Failing Limit (dBm)	Results
FL to (Fc - Test BW)	480.4712	-30.41	-20	PASS
(Fc + Test BW) to 1GHz	925.8186	-31.41	-20	PASS
1GHz to 2Fc	1211.7720	-42.91	-20	PASS
2Fc to 10Fc	7064.9780	-39.12	-20	PASS
	1737.7750	-44.81	-20	PASS
	2606.6620	-44.51	-20	PASS
	3475.5500	-42.66	-20	PASS
	4344.4370	-43.57	-20	PASS
	5213.3250	-42.73	-20	PASS
	6082.2120	-43.16	-20	PASS
	6951.1000	-41.73	-20	PASS
	7819.9880	-41.73	-20	PASS
8688.8750	-42.06	-20	PASS	

6.12.4. Test Limit

Table below summarized the power of any emission outside a licensee’s frequency block shall be attenuated below the transmitter power (P) by at least

Channel Spacing	Part 22	Part 24D	Part 74	Part 80	Part 90 (UHF, VHF, 800, 900)	Part 90 (700)
12.5kHz	43 + log10(P) (-13 dBm)	43 + log10(P) (-13 dBm)	43 + log10(P) (-13 dBm)	Not Applicable	50 + log10(P) (-20 dBm)	43 + log10(P) (-13 dBm)
25kHz		Not Applicable		43 + log10(P) (-13 dBm)	43 + log10(P) (-13 dBm)	43 + log10(P) (-13 dBm)

Channel Spacing	RSS 134	RSS 182	RSS 119 (UHF, VHF, 800, 900)	RSS 119 (700)
12.5kHz	43 + log10(P) (-13 dBm)	Not Applicable	50 + log10(P) (-20 dBm)	43 + log10(P) (-13 dBm)
25kHz	Not Applicable	43 + log10(P) (-13 dBm)	43 + log10(P) (-13 dBm)	43 + log10(P) (-13 dBm)

6.13. Radiated Spurious Emission

6.13.1. Test Setup

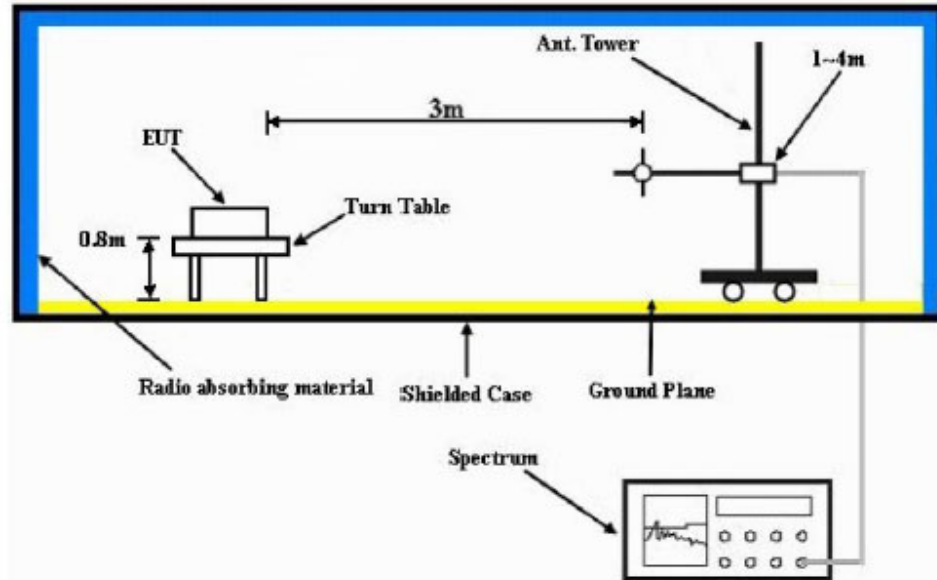

- 1) The Resolution Bandwidth for scanning Radiated Emission below 1 GHz is 100 kHz with Video Bandwidth = 300 kHz and Resolution Bandwidth for above 1 GHz is 1 MHz with Video Bandwidth = 3 MHz. Detector mode is positive peak.
- 2) In the semi- anechoic chamber, setup as illustrated above the DUT placed on the 0.8m height (for frequencies < 1GHz) or 1.5m (for frequencies > 1GHz) of Turn Table, rotated the table around 360 degrees to search the maximum radiation power and receiver antenna shall be rotated vertical and horizontal polarization and moved height from 1m to 4m to find the maximum polar radiated power. The “Read Value” is the spectrum reading the maximum power value.
- 3) The substitution antenna is substituted for DUT at the same position and signals generator (S.G) export the CW signal to the substitution antenna via a TX cable. The receiver antenna shall be rotated vertical and horizontal polarization and moved height from 1m to 4m to find the maximum radiation power. Record the power level of maximum radiation power from spectrum. So, the measured substitution value = Ref level of S.G + TX cables loss – Substituted Antenna Gain.
- 4) Final Radiated Spurious Emission = “Read Value” + Measured substitution value.

6.13.2. Test Result (Analog)

SAC Transmitter Radiated Emission:

Model Number: H55TGT9PW8AN S/N: 437TUX0086 SR:12464-EMC-00077
 Battery Part No: NNTN9089A Accy Part No: NA
 Test Mode: TX Analog
 806.012500 MHz 25 kHz 1.000 Watt(s) /Low Power

Frequency (MHz)	Limit	Horizontal Measured Emission Equiv Pwr Into Ideal Dipole (dBm)	Vertical Measured Emission Equiv Pwr Into ideal Dipole (dBm)
1612.0250	-13.0000	-57.0872 **	-57.5760 **
2418.0375	-13.0000	-56.2034 **	-53.4191 **
3224.0500	-13.0000	-51.9363 **	-52.4718 **
4030.0625	-13.0000	-50.2969 **	-51.6911 **
4836.0750	-13.0000	-48.4179 **	-48.5288 **
5642.0875	-13.0000	-48.3574 **	-48.5336 **
6448.1000	-13.0000	-46.6971 **	-45.6140 **
7254.1125	-13.0000	-45.1114 **	-43.3304 **
8060.1250	-13.0000	-44.7935 **	-45.1998 **

RADIATED SPURIOUS EMISSIONS

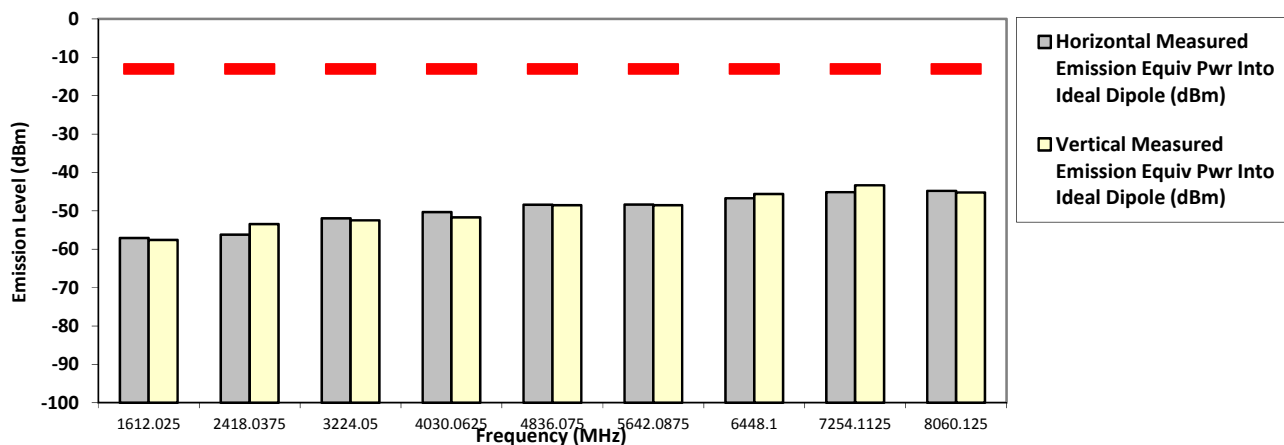

The data presented here was taken using the substitution method as found in the ANSI C63.26-2015 document.
 Motorola Penang EMC Lab - Test Performed by: Nazrin&Qawiman Wed, Dec 26, 2018

Remarks: ** Indicates the spurious emission could not be detected due to noise limitations or ambient.
 *Pursuant to CFR 47 Part 2.1057 (c), emissions attenuated more than 20 dB below the permissible limit are not reported
 Temp(Deg): 23.5 Hum(%RH): 70.1

System MU: 5.01 dB

Remarks: Passed Results Marginal Results Failed Results

SAC Transmitter Radiated Emission:

Model Number: H55TGT9PW8AN S/N: 437TUX0086 SR:12464-EMC-00077
 Battery Part No: NNTN9089A Accy Part No: NA
 Test Mode: TX Analog
 806.012500 MHz 25 kHz 3.600 Watt(s) /Max Power

Frequency (MHz)	Limit	Horizontal Measured Emission Equiv Pwr Into Ideal Dipole (dBm)	Vertical Measured Emission Equiv Pwr Into ideal Dipole (dBm)
1612.0250	-13.0000	-51.4400 *	-54.8400 *
2418.0375	-13.0000	-54.2820 **	-55.5021 **
3224.0500	-13.0000	-51.0930 **	-50.3045 **
4030.0625	-13.0000	-51.7355 **	-51.5932 **
4836.0750	-13.0000	-49.7448 **	-49.2287 **
5642.0875	-13.0000	-48.3307 **	-47.0332 **
6448.1000	-13.0000	-46.6841 **	-46.4005 **
7254.1125	-13.0000	-44.1072 **	-44.2553 **
8060.1250	-13.0000	-43.9317 **	-42.4315 **

RADIATED SPURIOUS EMISSIONS

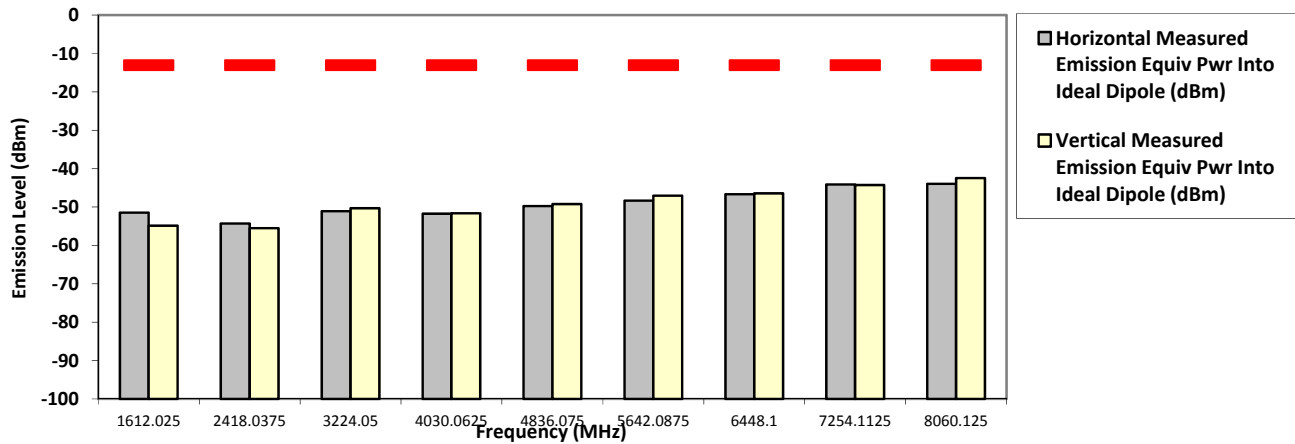

The data presented here was taken using the substitution method as found in the ANSI C63.26-2015 document.
 Motorola Penang EMC Lab - Test Performed by: Nazrin&Qawiman Wed, Dec 26, 2018

Remarks: ** Indicates the spurious emission could not be detected due to noise limitations or ambient.
 *Pursuant to CFR 47 Part 2.1057 (c), emissions attenuated more than 20 dB below the permissible limit are not reported
 Temp(Deg): 23.5 Hum(%RH): 70.1

System MU: 5.01 dB

Remarks: Passed Results Marginal Results Failed Results

SAC Transmitter Radiated Emission:

Model Number: H55TGT9PW8AN S/N: 437TUX0086 SR:12464-EMC-00077
 Battery Part No: NNTN9089A Accy Part No: NA
 Test Mode: TX Analog
 814.987500 MHz 25 kHz 1.000 Watt(s) /Low Power

Frequency (MHz)	Limit	Horizontal Measured Emission Equiv Pwr Into Ideal Dipole (dBm)	Vertical Measured Emission Equiv Pwr Into ideal Dipole (dBm)
1629.9750	-13.0000	-56.5562 **	-57.6203 **
2444.9625	-13.0000	-55.8501 **	-55.7493 **
3259.9500	-13.0000	-52.6924 **	-52.2227 **
4074.9375	-13.0000	-51.8775 **	-51.5570 **
4889.9250	-13.0000	-48.2891 **	-49.0195 **
5704.9125	-13.0000	-49.3339 **	-48.1192 **
6519.9000	-13.0000	-45.3911 **	-46.5906 **
7334.8875	-13.0000	-44.0282 **	-43.8173 **
8149.8750	-13.0000	-46.7713 **	-46.4926 **

RADIATED SPURIOUS EMISSIONS

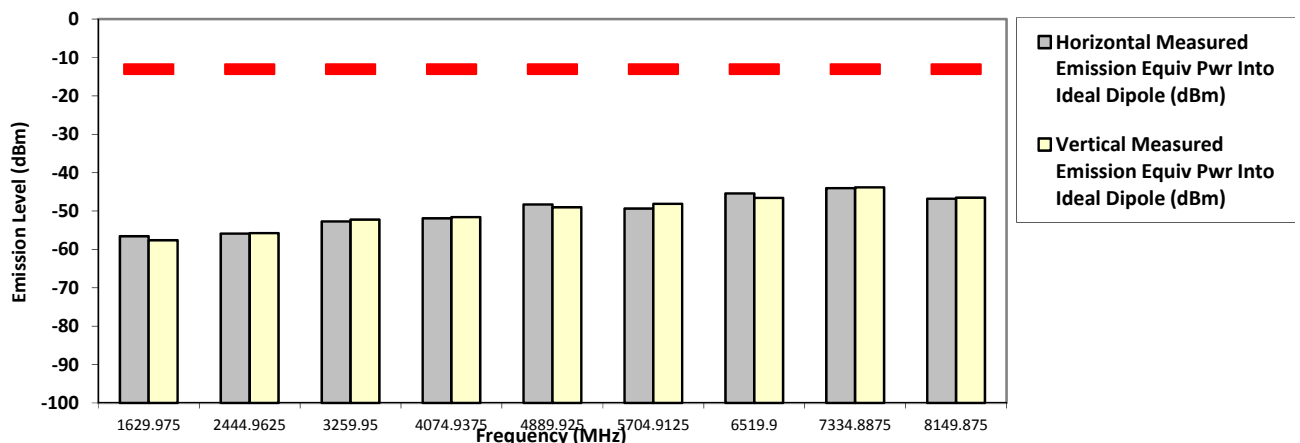

The data presented here was taken using the substitution method as found in the ANSI C63.26-2015 document.
 Motorola Penang EMC Lab - Test Performed by: Nazrin&Qawiman Wed, Dec 26, 2018

Remarks: ** Indicates the spurious emission could not be detected due to noise limitations or ambient.
 *Pursuant to CFR 47 Part 2.1057 (c), emissions attenuated more than 20 dB below the permissible limit are not reported
 Temp(Deg): 23.5 Hum(%RH): 70.1

System MU: 5.01 dB

Remarks: Passed Results Marginal Results Failed Results

SAC Transmitter Radiated Emission:

Model Number: H55TGT9PW8AN **S/N: 437TUX0086** **SR:12464-EMC-00077**
Battery Part No: NNTN9089A **Accy Part No: NA**
Test Mode: TX Analog
814.987500 MHz **25 kHz** **3.600 Watt(s) /Max Power**

Frequency (MHz)	Limit	Horizontal Measured Emission Equiv Pwr Into Ideal Dipole (dBm)	Vertical Measured Emission Equiv Pwr Into ideal Dipole (dBm)
1629.9750	-13.0000	-50.8400 *	-55.2600 *
2444.9625	-13.0000	-54.1119 **	-54.4638 **
3259.9500	-13.0000	-46.4400 *	-45.5600 *
4074.9375	-13.0000	-50.9496 **	-50.9683 **
4889.9250	-13.0000	-48.5255 **	-47.0318 **
5704.9125	-13.0000	-48.9556 **	-47.7577 **
6519.9000	-13.0000	-46.2076 **	-46.0071 **
7334.8875	-13.0000	-43.3076 **	-44.2573 **
8149.8750	-13.0000	-43.7720 **	-42.4990 **

RADIATED SPURIOUS EMISSIONS

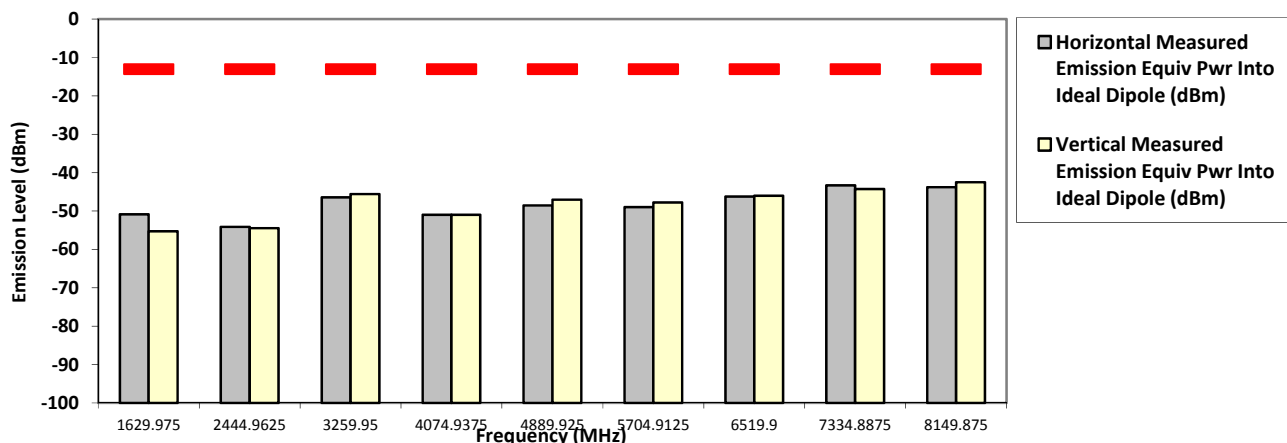

The data presented here was taken using the substitution method as found in the ANSI C63.26-2015 document.
 Motorola Penang EMC Lab - Test Performed by: Nazrin&Qawiman Wed, Dec 26, 2018

Remarks: ** Indicates the spurious emission could not be detected due to noise limitations or ambient.
 *Pursuant to CFR 47 Part 2.1057 (c), emissions attenuated more than 20 dB below the permissible limit are not reported
 Temp(Deg): 23.5 Hum(%RH): 70.1

System MU: 5.01 dB

Remarks: Passed Results Marginal Results Failed Results

SAC Transmitter Radiated Emission:

Model Number: H55TGT9PW8AN S/N: 437TUX0086 SR:12464-EMC-00077
 Battery Part No: NNTN9089A Accy Part No: NA
 Test Mode: TX Analog
 823.987500 MHz 25 kHz 1.000 Watt(s) /Low Power

Frequency (MHz)	Limit	Horizontal Measured Emission Equiv Pwr Into Ideal Dipole (dBm)	Vertical Measured Emission Equiv Pwr Into ideal Dipole (dBm)
1647.9750	-13.0000	-55.9186 **	-57.0401 **
2471.9625	-13.0000	-54.8339 **	-55.6880 **
3295.9500	-13.0000	-52.0113 **	-52.0319 **
4119.9375	-13.0000	-51.0116 **	-51.7443 **
4943.9250	-13.0000	-49.2637 **	-49.2472 **
5767.9125	-13.0000	-48.1289 **	-46.9866 **
6591.9000	-13.0000	-45.1327 **	-43.9077 **
7415.8875	-13.0000	-43.5402 **	-43.0919 **
8239.8750	-13.0000	-46.1459 **	-44.9909 **

RADIATED SPURIOUS EMISSIONS

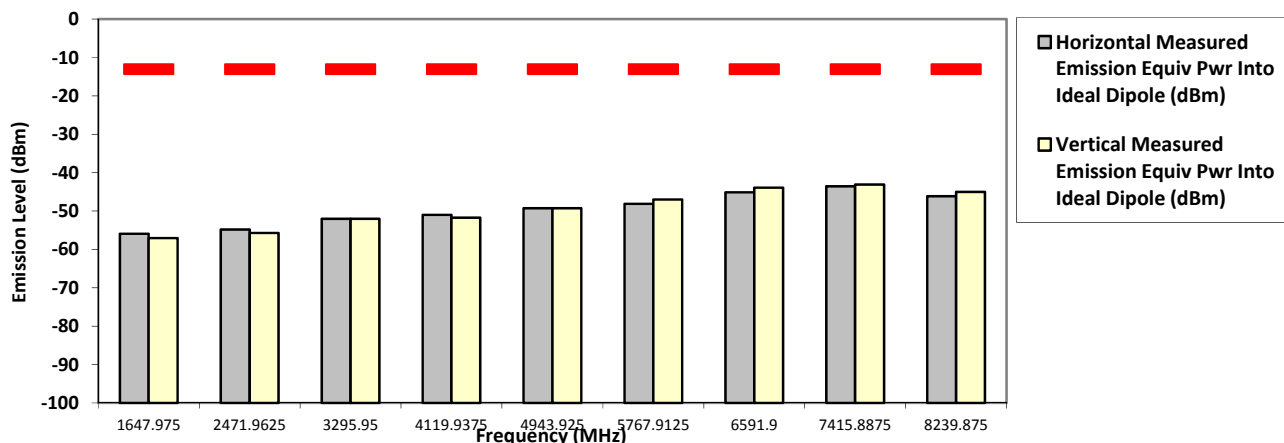

The data presented here was taken using the substitution method as found in the ANSI C63.26-2015 document.
 Motorola Penang EMC Lab - Test Performed by: Nazrin&Qawiman Wed, Dec 26, 2018

Remarks: ** Indicates the spurious emission could not be detected due to noise limitations or ambient.
 *Pursuant to CFR 47 Part 2.1057 (c), emissions attenuated more than 20 dB below the permissible limit are not reported
 Temp(Deg): 23.5 Hum(%RH): 70.1

System MU: 5.01 dB

Remarks: Passed Results Marginal Results Failed Results

SAC Transmitter Radiated Emission:

Model Number: H55TGT9PW8AN **S/N: 437TUX0086** **SR:12464-EMC-00077**
Battery Part No: NNTN9089A **Accy Part No: NA**
Test Mode: TX Analog
823.987500 MHz **25 kHz** **3.600 Watt(s) /Max Power**

Frequency (MHz)	Limit	Horizontal Measured Emission Equiv Pwr Into Ideal Dipole (dBm)	Vertical Measured Emission Equiv Pwr Into ideal Dipole (dBm)
1647.9750	-13.0000	-48.6600 *	-50.9300 *
2471.9625	-13.0000	-54.8270 **	-54.0629 **
3295.9500	-13.0000	-52.0332 **	-50.1159 **
4119.9375	-13.0000	-51.3301 **	-50.3872 **
4943.9250	-13.0000	-48.6445 **	-48.7510 **
5767.9125	-13.0000	-48.2456 **	-48.0258 **
6591.9000	-13.0000	-45.1972 **	-44.7346 **
7415.8875	-13.0000	-44.2388 **	-43.9477 **
8239.8750	-13.0000	-44.1530 **	-42.1979 **

RADIATED SPURIOUS EMISSIONS

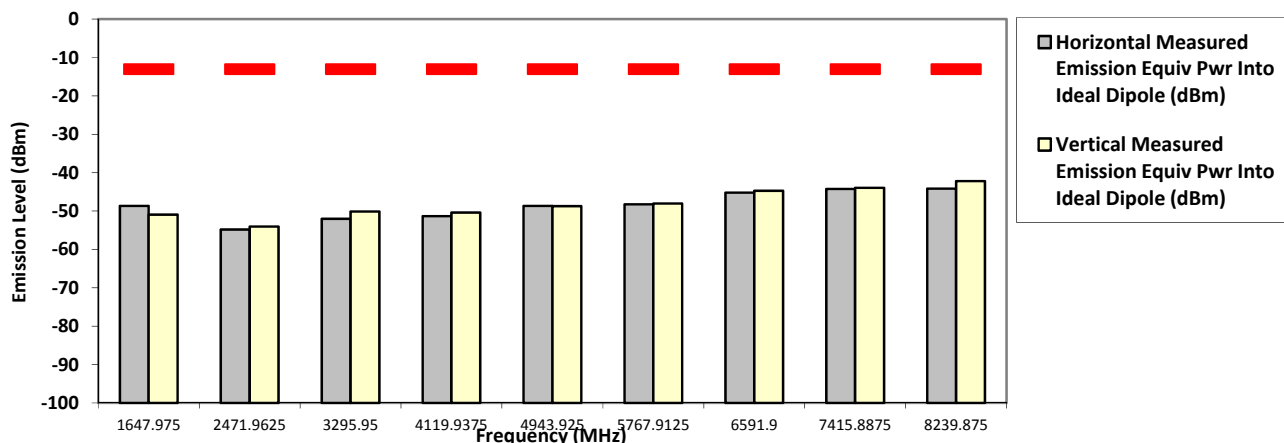

The data presented here was taken using the substitution method as found in the ANSI C63.26-2015 document.
 Motorola Penang EMC Lab - Test Performed by: Nazrin&Qawiman Thu, Jan 03, 2019

Remarks: ** Indicates the spurious emission could not be detected due to noise limitations or ambient.
 *Pursuant to CFR 47 Part 2.1057 (c), emissions attenuated more than 20 dB below the permissible limit are not reported
 Temp(Deg): 23.2 Hum(%RH): 70.0

System MU: 5.01 dB

Remarks: Passed Results Marginal Results Failed Results

SAC Transmitter Radiated Emission:

Model Number: H55TGT9PW8AN **S/N: 437TUX0086** **SR:12464-EMC-00077**
Battery Part No: NNTN9089A **Accy Part No: NA**
Test Mode: TX Analog
851.012500 MHz **25 kHz** **1.000 Watt(s) /Low Power**

Frequency (MHz)	Limit	Horizontal Measured Emission Equiv Pwr Into Ideal Dipole (dBm)	Vertical Measured Emission Equiv Pwr Into ideal Dipole (dBm)
1702.0250	-13.0000	-55.8196 **	-55.7623 **
2553.0375	-13.0000	-55.6785 **	-54.5356 **
3404.0500	-13.0000	-52.8074 **	-51.9481 **
4255.0625	-13.0000	-50.3984 **	-50.6812 **
5106.0750	-13.0000	-48.0150 **	-48.2209 **
5957.0875	-13.0000	-46.2390 **	-46.6691 **
6808.1000	-13.0000	-45.3507 **	-44.9678 **
7659.1125	-13.0000	-43.6326 **	-43.6054 **
8510.1250	-13.0000	-41.7547 **	-42.9000 **

RADIATED SPURIOUS EMISSIONS

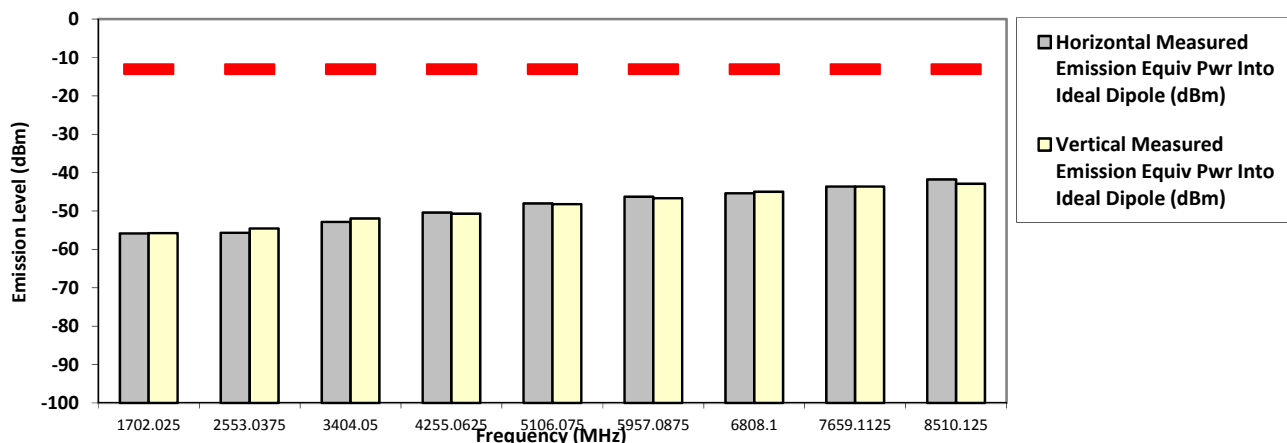

The data presented here was taken using the substitution method as found in the ANSI C63.26-2015 document.
 Motorola Penang EMC Lab - Test Performed by: Nazrin&Qawiman Wed, Dec 26, 2018

Remarks: ** Indicates the spurious emission could not be detected due to noise limitations or ambient.
 *Pursuant to CFR 47 Part 2.1057 (c), emissions attenuated more than 20 dB below the permissible limit are not reported
 Temp(Deg): 23.5 Hum(%RH): 70.1

System MU: 5.01 dB

Remarks: Passed Results Marginal Results Failed Results

SAC Transmitter Radiated Emission:

Model Number: H55TGT9PW8AN **S/N: 437TUX0086** **SR:12464-EMC-00077**
Battery Part No: NNTN9089A **Accy Part No: NA**
Test Mode: TX Analog
851.012500 MHz **25 kHz** **3.600 Watt(s) /Max Power**

Frequency (MHz)	Limit	Horizontal Measured Emission Equiv Pwr Into Ideal Dipole (dBm)	Vertical Measured Emission Equiv Pwr Into ideal Dipole (dBm)
1702.0250	-13.0000	-50.3900 *	-52.6200 *
2553.0375	-13.0000	-53.1825 **	-53.9607 **
3404.0500	-13.0000	-52.5904 **	-52.2768 **
4255.0625	-13.0000	-50.8320 **	-50.9944 **
5106.0750	-13.0000	-46.4754 **	-48.4059 **
5957.0875	-13.0000	-46.2515 **	-46.8892 **
6808.1000	-13.0000	-45.5090 **	-45.8389 **
7659.1125	-13.0000	-43.9947 **	-43.3884 **
8510.1250	-13.0000	-42.7137 **	-42.5899 **

RADIATED SPURIOUS EMISSIONS

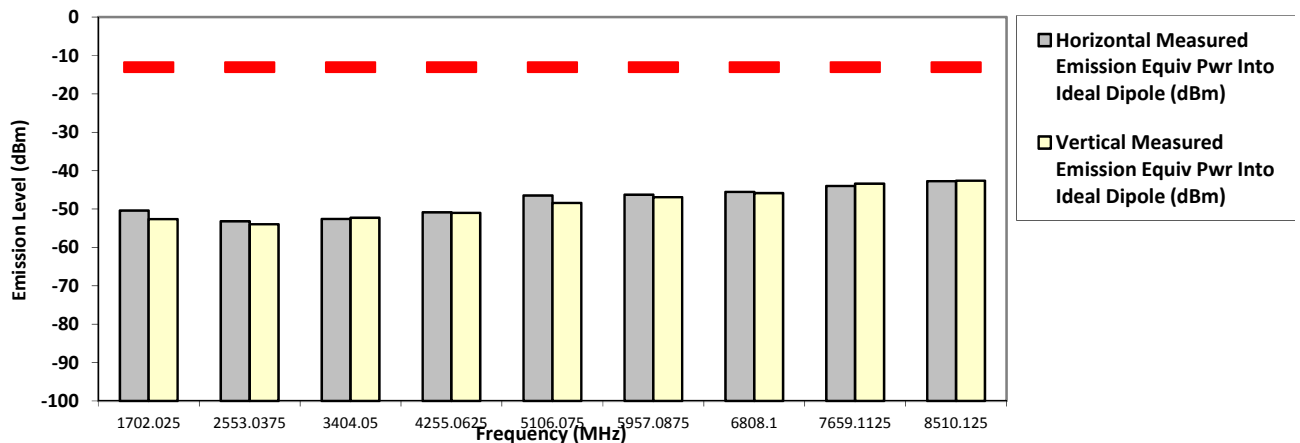

The data presented here was taken using the substitution method as found in the ANSI C63.26-2015 document.
 Motorola Penang EMC Lab - Test Performed by: Nazrin&Qawiman Thu, Jan 03, 2019

Remarks: ** Indicates the spurious emission could not be detected due to noise limitations or ambient.
 *Pursuant to CFR 47 Part 2.1057 (c), emissions attenuated more than 20 dB below the permissible limit are not reported
 Temp(Deg): 23.2 Hum(%RH): 70.0

System MU: 5.01 dB

Remarks: Passed Results Marginal Results Failed Results

SAC Transmitter Radiated Emission:

Model Number: H55TGT9PW8AN **S/N: 437TUX0086** **SR:12464-EMC-00077**
Battery Part No: NNTN9089A **Accy Part No: NA**
Test Mode: TX Analog
860.012500 MHz **25 kHz** **1.000 Watt(s) /Low Power**

Frequency (MHz)	Limit	Horizontal Measured Emission Equiv Pwr Into Ideal Dipole (dBm)	Vertical Measured Emission Equiv Pwr Into ideal Dipole (dBm)
1720.0250	-13.0000	-56.2121 **	-57.7004 **
2580.0375	-13.0000	-54.9631 **	-55.1886 **
3440.0500	-13.0000	-53.3794 **	-52.8998 **
4300.0625	-13.0000	-50.3597 **	-51.2532 **
5160.0750	-13.0000	-49.0049 **	-48.3973 **
6020.0875	-13.0000	-47.0382 **	-47.2535 **
6880.1000	-13.0000	-44.8913 **	-45.5654 **
7740.1125	-13.0000	-43.3689 **	-43.3871 **
8600.1250	-13.0000	-42.9357 **	-41.8312 **

RADIATED SPURIOUS EMISSIONS

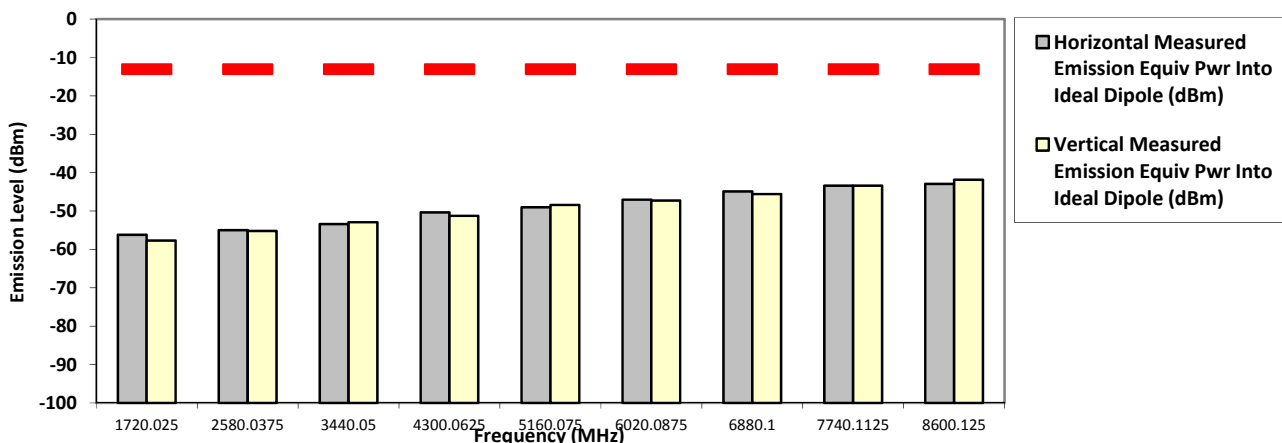

The data presented here was taken using the substitution method as found in the ANSI C63.26-2015 document.
 Motorola Penang EMC Lab - Test Performed by: Nazrin&Qawiman Wed, Dec 26, 2018

Remarks: ** Indicates the spurious emission could not be detected due to noise limitations or ambient.
 *Pursuant to CFR 47 Part 2.1057 (c), emissions attenuated more than 20 dB below the permissible limit are not reported
 Temp(Deg): 23.5 Hum(%RH): 70.1

System MU: 5.01 dB

Remarks: Passed Results Marginal Results Failed Results

SAC Transmitter Radiated Emission:

Model Number: H55TGT9PW8AN **S/N: 437TUX0086** **SR:12464-EMC-00077**
Battery Part No: NNTN9089A **Accy Part No: NA**
Test Mode: TX Analog
860.012500 MHz **25 kHz** **3.600 Watt(s) /Max Power**

Frequency (MHz)	Limit	Horizontal Measured Emission Equiv Pwr Into Ideal Dipole (dBm)	Vertical Measured Emission Equiv Pwr Into ideal Dipole (dBm)
1720.0250	-13.0000	-50.2400 *	-52.0700 *
2580.0375	-13.0000	-53.0336 **	-52.7749 **
3440.0500	-13.0000	-52.5320 **	-52.7459 **
4300.0625	-13.0000	-51.1471 **	-51.0365 **
5160.0750	-13.0000	-48.2929 **	-49.0435 **
6020.0875	-13.0000	-45.8748 **	-47.6935 **
6880.1000	-13.0000	-45.6128 **	-44.2818 **
7740.1125	-13.0000	-45.0166 **	-43.5410 **
8600.1250	-13.0000	-43.1885 **	-42.2267 **

RADIATED SPURIOUS EMISSIONS

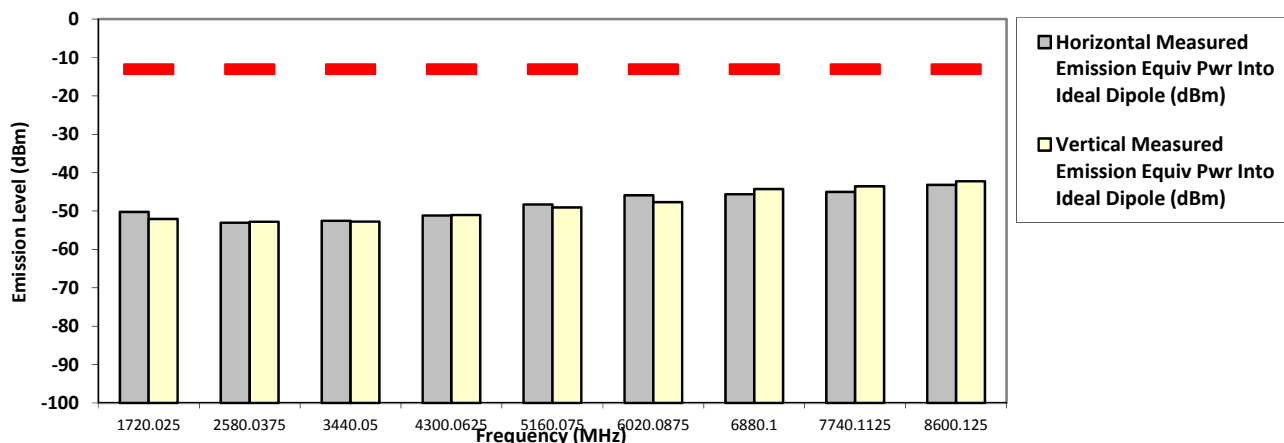

The data presented here was taken using the substitution method as found in the ANSI C63.26-2015 document.
 Motorola Penang EMC Lab - Test Performed by: Nazrin&Qawiman Thu, Jan 03, 2019

Remarks: ** Indicates the spurious emission could not be detected due to noise limitations or ambient.
 *Pursuant to CFR 47 Part 2.1057 (c), emissions attenuated more than 20 dB below the permissible limit are not reported
 Temp(Deg): 23.2 Hum(%RH): 70.0

System MU: 5.01 dB

Remarks: Passed Results Marginal Results Failed Results

SAC Transmitter Radiated Emission:

Model Number: H55TGT9PW8AN **S/N: 437TUX0086** **SR:12464-EMC-00077**
Battery Part No: NNTN9089A **Accy Part No: NA**
Test Mode: TX Analog
868.887500 MHz **25 kHz** **1.000 Watt(s) /Low Power**

Frequency (MHz)	Limit	Horizontal Measured Emission Equiv Pwr Into Ideal Dipole (dBm)	Vertical Measured Emission Equiv Pwr Into ideal Dipole (dBm)
1737.7750	-13.0000	-57.6954 **	-58.7099 **
2606.6625	-13.0000	-54.0114 **	-55.1326 **
3475.5500	-13.0000	-52.2396 **	-52.7468 **
4344.4375	-13.0000	-50.4189 **	-50.5833 **
5213.3250	-13.0000	-48.5368 **	-48.4718 **
6082.2125	-13.0000	-47.4438 **	-46.3914 **
6951.1000	-13.0000	-45.3534 **	-45.1687 **
7819.9875	-13.0000	-43.1624 **	-43.6040 **
8688.8750	-13.0000	-43.0303 **	-42.7887 **

RADIATED SPURIOUS EMISSIONS

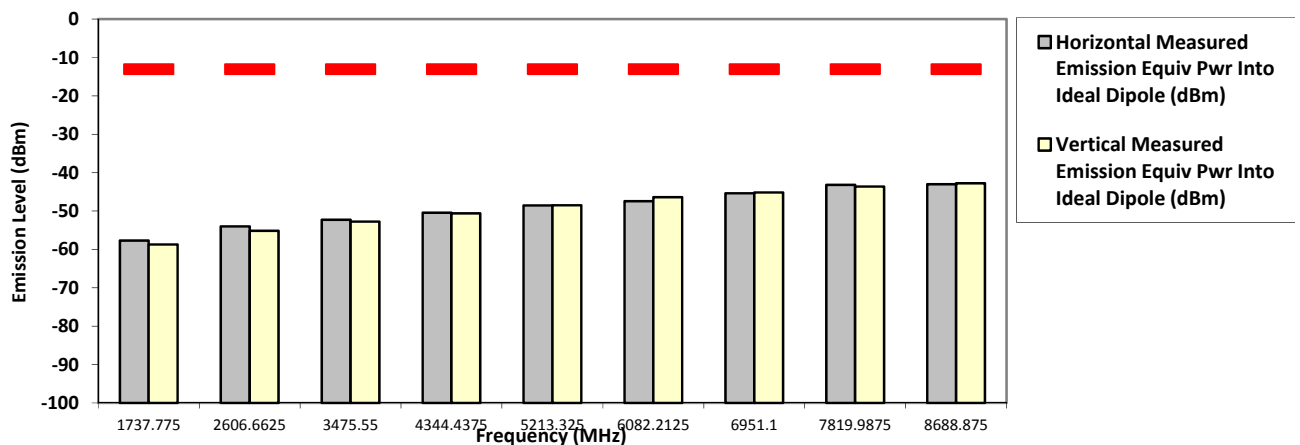

The data presented here was taken using the substitution method as found in the ANSI C63.26-2015 document.
 Motorola Penang EMC Lab - Test Performed by: Nazrin&Qawiman Wed, Dec 26, 2018

Remarks: ** Indicates the spurious emission could not be detected due to noise limitations or ambient.
 *Pursuant to CFR 47 Part 2.1057 (c), emissions attenuated more than 20 dB below the permissible limit are not reported
 Temp(Deg): 23.5 Hum(%RH): 70.1

System MU: 5.01 dB

Remarks: Passed Results Marginal Results Failed Results

SAC Transmitter Radiated Emission:

Model Number: H55TGT9PW8AN **S/N: 437TUX0086** **SR:12464-EMC-00077**
Battery Part No: NNTN9089A **Accy Part No: NA**
Test Mode: TX Analog
868.887500 MHz **25 kHz** **3.600 Watt(s) /Max Power**

Frequency (MHz)	Limit	Horizontal Measured Emission Equiv Pwr Into Ideal Dipole (dBm)	Vertical Measured Emission Equiv Pwr Into ideal Dipole (dBm)
1737.7750	-13.0000	-52.2000 *	-53.1500 *
2606.6625	-13.0000	-51.6739 **	-53.2491 **
3475.5500	-13.0000	-52.3799 **	-52.7658 **
4344.4375	-13.0000	-50.7466 **	-50.7092 **
5213.3250	-13.0000	-48.5287 **	-48.2574 **
6082.2125	-13.0000	-46.6786 **	-46.7224 **
6951.1000	-13.0000	-44.5521 **	-45.3592 **
7819.9875	-13.0000	-43.9563 **	-44.7785 **
8688.8750	-13.0000	-42.9618 **	-42.4837 **

RADIATED SPURIOUS EMISSIONS

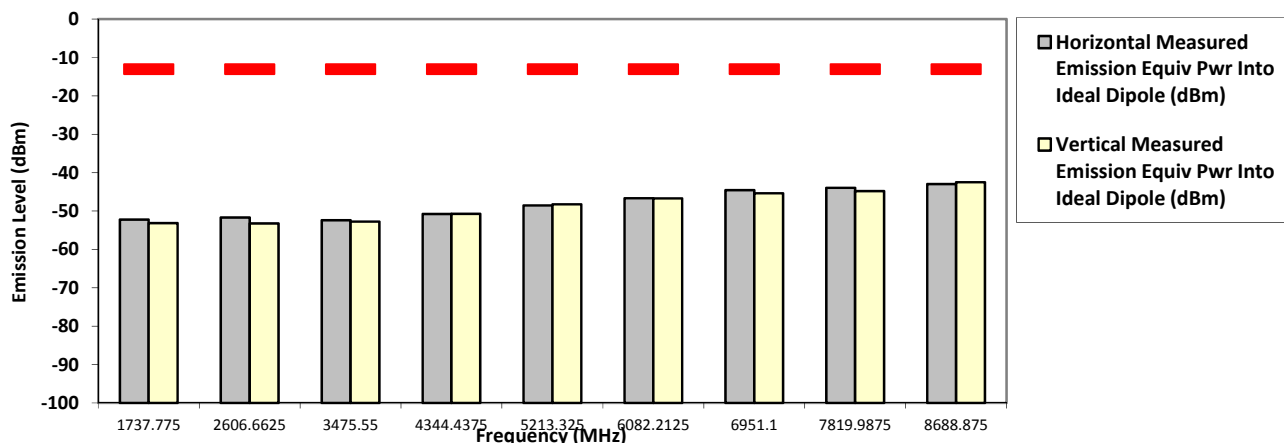

The data presented here was taken using the substitution method as found in the ANSI C63.26-2015 document.
 Motorola Penang EMC Lab - Test Performed by: Nazrin&Qawiman Wed, Dec 26, 2018

Remarks: ** Indicates the spurious emission could not be detected due to noise limitations or ambient.
 *Pursuant to CFR 47 Part 2.1057 (c), emissions attenuated more than 20 dB below the permissible limit are not reported
 Temp(Deg): 23.5 Hum(%RH): 70.1

System MU: 5.01 dB

Remarks: Passed Results Marginal Results Failed Results

6.13.3. Test Result (Digital)

SAC Transmitter Radiated Emission:

Model Number: H55TGT9PW8AN **S/N: 437TUX0086** **SR:12464-EMC-00077**
Battery Part No: NNTN9089A **Accy Part No: NA**
Test Mode: TX APCO Digital C4FM
806.012500 MHz **12.5 kHz** **1.000 Watt(s) /Low Power**

Frequency (MHz)	Limit	Horizontal Measured Emission Equiv Pwr Into Ideal Dipole (dBm)	Vertical Measured Emission Equiv Pwr Into ideal Dipole (dBm)
1612.0250	-13.0000	-55.0421 **	-56.6332 **
2418.0375	-13.0000	-54.2366 **	-56.5816 **
3224.0500	-13.0000	-52.0768 **	-51.7917 **
4030.0625	-13.0000	-51.6947 **	-51.7355 **
4836.0750	-13.0000	-48.4576 **	-49.2405 **
5642.0875	-13.0000	-49.0119 **	-48.6102 **
6448.1000	-13.0000	-46.2436 **	-45.7837 **
7254.1125	-13.0000	-42.3128 **	-43.3744 **
8060.1250	-13.0000	-45.5009 **	-45.6866 **

RADIATED SPURIOUS EMISSIONS

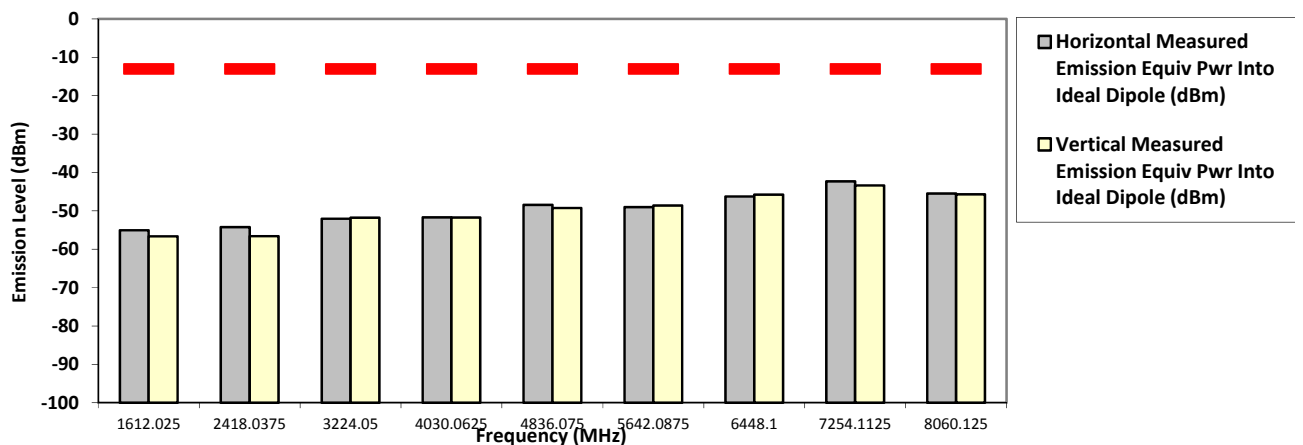

The data presented here was taken using the substitution method as found in the ANSI C63.26-2015 document.
 Motorola Penang EMC Lab - Test Performed by: Nazrin&Qawiman Wed, Dec 26, 2018

Remarks: ** Indicates the spurious emission could not be detected due to noise limitations or ambient.
 *Pursuant to CFR 47 Part 2.1057 (c), emissions attenuated more than 20 dB below the permissible limit are not reported
 Temp(Deg): 23.5 Hum(%RH): 70.1

System MU: 5.01 dB

Remarks: Passed Results Marginal Results Failed Results

SAC Transmitter Radiated Emission:
Model Number: H55TGT9PW8AN **S/N: 437TUX0086** **SR:12464-EMC-00077**
Battery Part No: NNTN9089A **Accy Part No: NA**
Test Mode: TX APCO Digital C4FM
806.012500 MHz **12.5 kHz** **3.600 Watt(s) /Max Power**

Frequency (MHz)	Limit	Horizontal Measured Emission Equiv Pwr Into Ideal Dipole (dBm)	Vertical Measured Emission Equiv Pwr Into ideal Dipole (dBm)
1612.0250	-13.0000	-51.2400 *	-55.0400 *
2418.0375	-13.0000	-55.0548 **	-54.7420 **
3224.0500	-13.0000	-46.8700 *	-46.3500 *
4030.0625	-13.0000	-51.8730 **	-51.7403 **
4836.0750	-13.0000	-49.2794 **	-49.2179 **
5642.0875	-13.0000	-48.9065 **	-48.0288 **
6448.1000	-13.0000	-46.3454 **	-46.5111 **
7254.1125	-13.0000	-43.9644 **	-43.4587 **
8060.1250	-13.0000	-43.4812 **	-42.9825 **

RADIATED SPURIOUS EMISSIONS

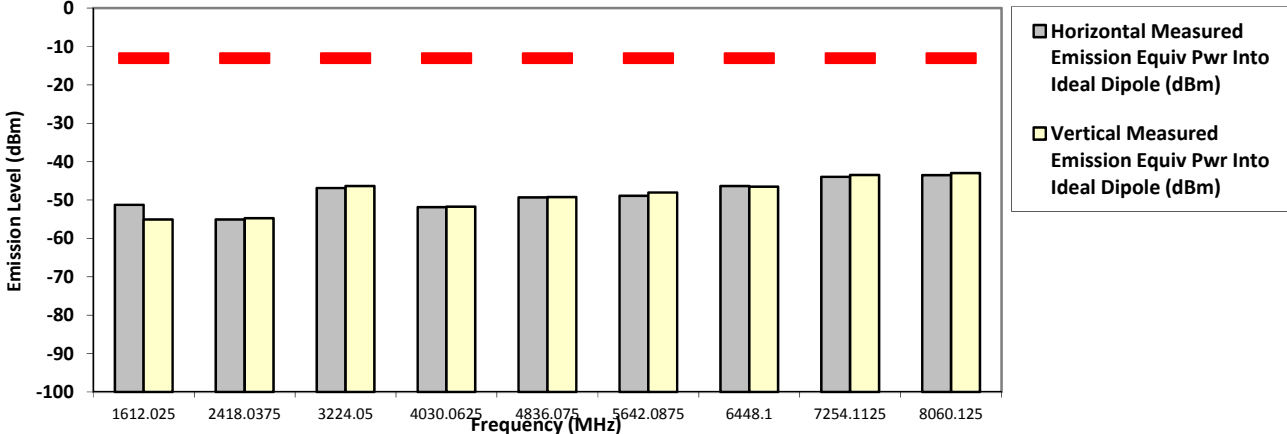

The data presented here was taken using the substitution method as found in the ANSI C63.26-2015 document.
 Motorola Penang EMC Lab - Test Performed by: Nazrin&Qawiman Wed, Dec 26, 2018

Remarks: ** Indicates the spurious emission could not be detected due to noise limitations or ambient.
 *Pursuant to CFR 47 Part 2.1057 (c), emissions attenuated more than 20 dB below the permissible limit are not reported
 Temp(Deg): 23.5 Hum(%RH): 70.1

System MU: 5.01 dB

Remarks:

Passed Results	Marginal Results	Failed Results
----------------	------------------	----------------

SAC Transmitter Radiated Emission:
Model Number: H55TGT9PW8AN **S/N: 437TUX0086** **SR:12464-EMC-00077**
Battery Part No: NNTN9089A **Accy Part No: NA**
Test Mode: TX APCO Digital C4FM
814.987500 MHz **12.5 kHz** **3.600 Watt(s) /Max Power**

Frequency (MHz)	Limit	Horizontal Measured Emission Equiv Pwr Into Ideal Dipole (dBm)	Vertical Measured Emission Equiv Pwr Into ideal Dipole (dBm)
1629.9750	-13.0000	-51.7100 *	-55.4200 *
2444.9625	-13.0000	-53.9377 **	-54.9521 **
3259.9500	-13.0000	-46.6400 *	-47.1100 *
4074.9375	-13.0000	-51.7482 **	-51.8600 **
4889.9250	-13.0000	-47.6657 **	-47.6753 **
5704.9125	-13.0000	-48.4415 **	-48.1043 **
6519.9000	-13.0000	-45.8554 **	-45.5856 **
7334.8875	-13.0000	-44.0936 **	-41.0787 **
8149.8750	-13.0000	-42.3852 **	-42.5582 **

RADIATED SPURIOUS EMISSIONS

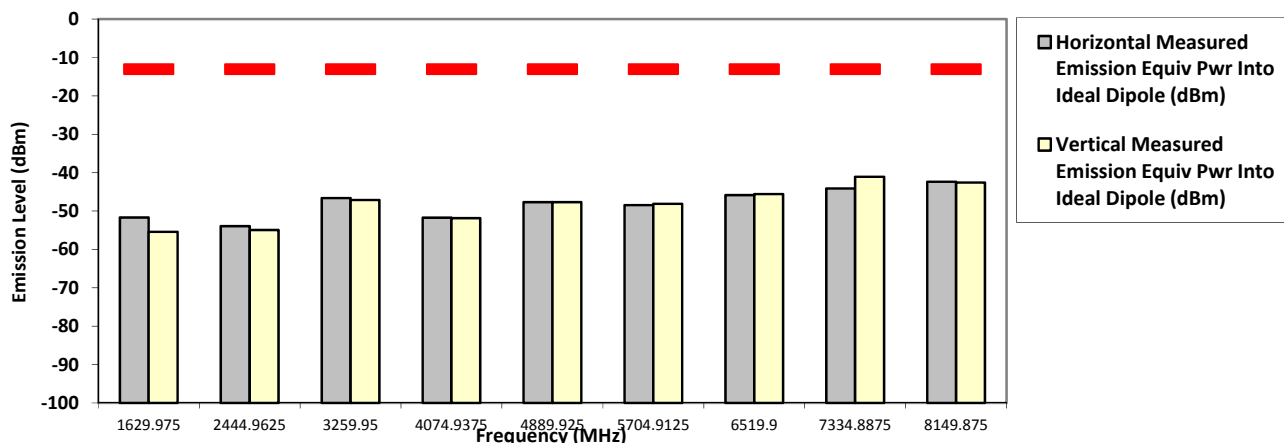

The data presented here was taken using the substitution method as found in the ANSI C63.26-2015 document.
 Motorola Penang EMC Lab - Test Performed by: Nazrin&Qawiman Wed, Dec 26, 2018

Remarks: ** Indicates the spurious emission could not be detected due to noise limitations or ambient.
 *Pursuant to CFR 47 Part 2.1057 (c), emissions attenuated more than 20 dB below the permissible limit are not reported
 Temp(Deg): 23.5 Hum(%RH): 70.1

System MU: 5.01 dB

Remarks: Passed Results Marginal Results Failed Results

SAC Transmitter Radiated Emission:
Model Number: H55TGT9PW8AN **S/N: 437TUX0086** **SR:12464-EMC-00077**
Battery Part No: NNTN9089A **Accy Part No: NA**
Test Mode: TX APCO Digital C4FM
823.987500 MHz **12.5 kHz** **1.000 Watt(s) /Low Power**

Frequency (MHz)	Limit	Horizontal Measured Emission Equiv Pwr Into Ideal Dipole (dBm)	Vertical Measured Emission Equiv Pwr Into ideal Dipole (dBm)
1647.9750	-13.0000	-60.0831 **	-58.5100 **
2471.9625	-13.0000	-55.9239 **	-54.9296 **
3295.9500	-13.0000	-51.9946 **	-52.0327 **
4119.9375	-13.0000	-50.4359 **	-50.3819 **
4943.9250	-13.0000	-47.7523 **	-48.6055 **
5767.9125	-13.0000	-47.6747 **	-47.0095 **
6591.9000	-13.0000	-44.1886 **	-45.0809 **
7415.8875	-13.0000	-42.5309 **	-42.9786 **
8239.8750	-13.0000	-45.9552 **	-45.7652 **

RADIATED SPURIOUS EMISSIONS

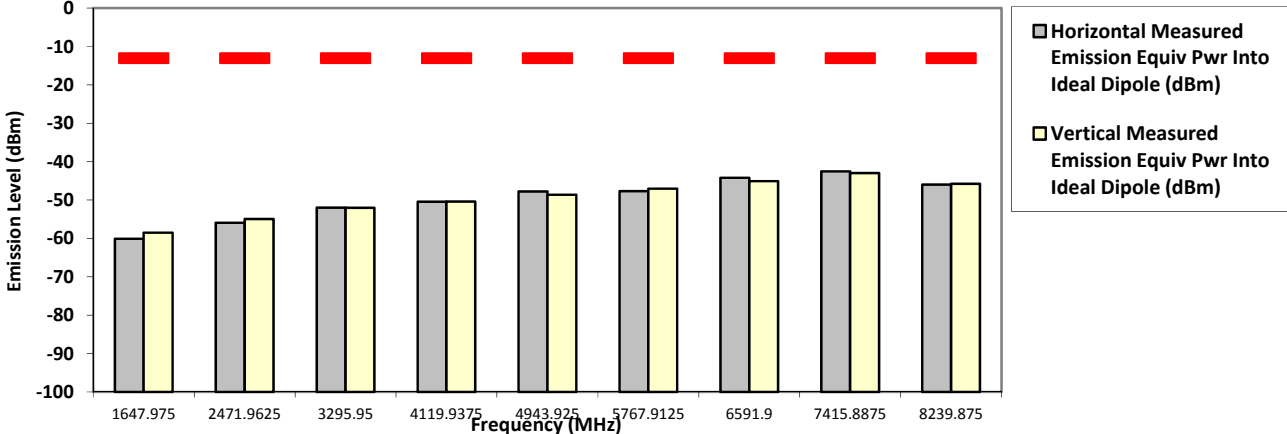

The data presented here was taken using the substitution method as found in the ANSI C63.26-2015 document.
 Motorola Penang EMC Lab - Test Performed by: Nazrin&Qawiman Wed, Dec 26, 2018

Remarks: ** Indicates the spurious emission could not be detected due to noise limitations or ambient.
 *Pursuant to CFR 47 Part 2.1057 (c), emissions attenuated more than 20 dB below the permissible limit are not reported
 Temp(Deg): 23.5 Hum(%RH): 70.1

System MU: 5.01 dB

Remarks:

Passed Results	Marginal Results	Failed Results
----------------	------------------	----------------

SAC Transmitter Radiated Emission:
Model Number: H55TGT9PW8AN **S/N: 437TUX0086** **SR:12464-EMC-00077**
Battery Part No: NNTN9089A **Accy Part No: NA**
Test Mode: TX APCO Digital C4FM
823.987500 MHz **12.5 kHz** **3.600 Watt(s) /Max Power**

Frequency (MHz)	Limit	Horizontal Measured Emission Equiv Pwr Into Ideal Dipole (dBm)	Vertical Measured Emission Equiv Pwr Into ideal Dipole (dBm)
1647.9750	-13.0000	-51.7700 *	-53.7700 *
2471.9625	-13.0000	-54.5786 **	-55.1751 **
3295.9500	-13.0000	-50.1690 **	-49.7433 **
4119.9375	-13.0000	-50.9038 **	-51.6426 **
4943.9250	-13.0000	-49.3067 **	-48.2699 **
5767.9125	-13.0000	-48.1340 **	-46.4530 **
6591.9000	-13.0000	-45.6030 **	-45.7370 **
7415.8875	-13.0000	-43.2847 **	-42.8998 **
8239.8750	-13.0000	-46.2684 **	-46.1077 **

RADIATED SPURIOUS EMISSIONS

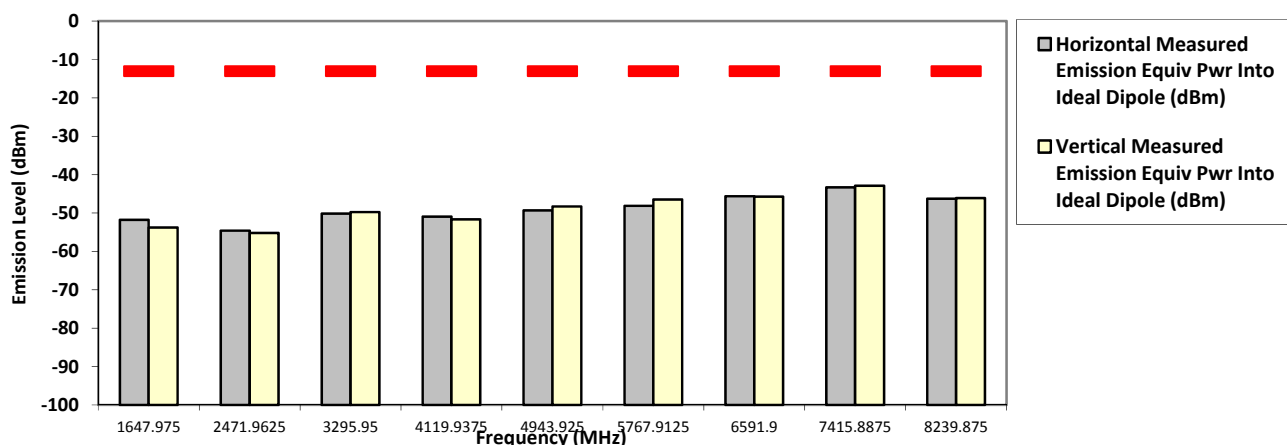

The data presented here was taken using the substitution method as found in the ANSI C63.26-2015 document.
 Motorola Penang EMC Lab - Test Performed by: Nazrin&Qawiman Wed, Dec 26, 2018

Remarks: ** Indicates the spurious emission could not be detected due to noise limitations or ambient.
 *Pursuant to CFR 47 Part 2.1057 (c), emissions attenuated more than 20 dB below the permissible limit are not reported
 Temp(Deg): 23.5 Hum(%RH): 70.1

System MU: 5.01 dB

Remarks: Passed Results Marginal Results Failed Results

SAC Transmitter Radiated Emission:

Model Number: H55TGT9PW8AN S/N: 437TUX0086 SR:12464-EMC-00077
 Battery Part No: NNTN9089A Accy Part No: NA
 Test Mode: TX APCO Digital C4FM
 851.012500 MHz 12.5 kHz 1.000 Watt(s) /Low Power

Frequency (MHz)	Limit	Horizontal Measured Emission Equiv Pwr Into Ideal Dipole (dBm)	Vertical Measured Emission Equiv Pwr Into ideal Dipole (dBm)
1702.0250	-13.0000	-59.0098 **	-58.9626 **
2553.0375	-13.0000	-54.5658 **	-55.3229 **
3404.0500	-13.0000	-54.0347 **	-52.9457 **
4255.0625	-13.0000	-51.3136 **	-51.2928 **
5106.0750	-13.0000	-47.2413 **	-47.4709 **
5957.0875	-13.0000	-46.3700 **	-46.5745 **
6808.1000	-13.0000	-45.1127 **	-45.4521 **
7659.1125	-13.0000	-43.7787 **	-43.7502 **
8510.1250	-13.0000	-43.7644 **	-42.8308 **

RADIATED SPURIOUS EMISSIONS

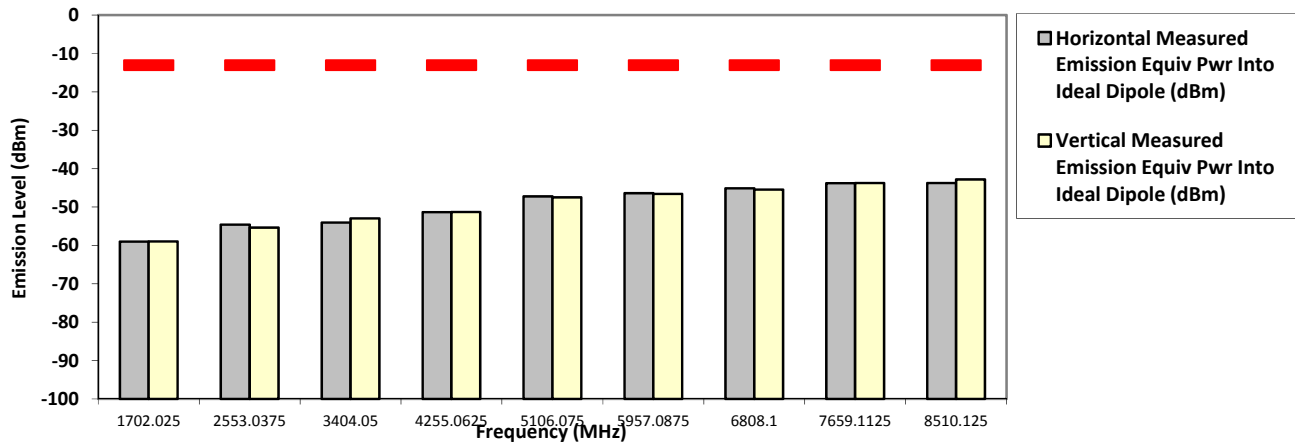

The data presented here was taken using the substitution method as found in the ANSI C63.26-2015 document.
 Motorola Penang EMC Lab - Test Performed by: Nazrin&Qawiman Wed, Dec 26, 2018

Remarks: ** Indicates the spurious emission could not be detected due to noise limitations or ambient.
 *Pursuant to CFR 47 Part 2.1057 (c), emissions attenuated more than 20 dB below the permissible limit are not reported
 Temp(Deg): 23.5 Hum(%RH): 70.1

System MU: 5.01 dB

Remarks:

Passed Results	Marginal Results	Failed Results
----------------	------------------	----------------

SAC Transmitter Radiated Emission:
Model Number: H55TGT9PW8AN **S/N: 437TUX0086** **SR:12464-EMC-00077**
Battery Part No: NNTN9089A **Accy Part No: NA**
Test Mode: TX APCO Digital C4FM
851.012500 MHz **12.5 kHz** **3.600 Watt(s) /Max Power**

Frequency (MHz)	Limit	Horizontal Measured Emission Equiv Pwr Into Ideal Dipole (dBm)	Vertical Measured Emission Equiv Pwr Into ideal Dipole (dBm)
1702.0250	-13.0000	-51.8500 *	-55.1900 *
2553.0375	-13.0000	-49.5200 *	-47.5000 *
3404.0500	-13.0000	-52.1563 **	-52.1042 **
4255.0625	-13.0000	-50.8456 **	-51.0808 **
5106.0750	-13.0000	-48.0756 **	-47.8094 **
5957.0875	-13.0000	-46.3272 **	-46.8623 **
6808.1000	-13.0000	-44.6770 **	-45.4525 **
7659.1125	-13.0000	-42.9891 **	-43.2262 **
8510.1250	-13.0000	-42.4702 **	-43.4543 **

RADIATED SPURIOUS EMISSIONS

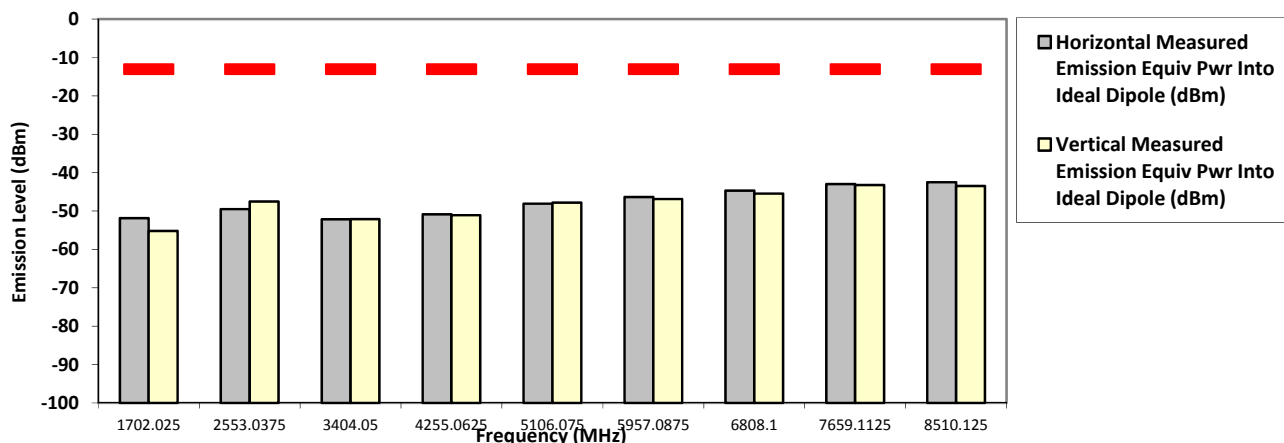

The data presented here was taken using the substitution method as found in the ANSI C63.26-2015 document.
 Motorola Penang EMC Lab - Test Performed by: Nazrin&Qawiman Wed, Dec 26, 2018

Remarks: ** Indicates the spurious emission could not be detected due to noise limitations or ambient.
 *Pursuant to CFR 47 Part 2.1057 (c), emissions attenuated more than 20 dB below the permissible limit are not reported
 Temp(Deg): 23.5 Hum(%RH): 70.1

System MU: 5.01 dB

Remarks: Passed Results Marginal Results Failed Results

SAC Transmitter Radiated Emission:
Model Number: H55TGT9PW8AN **S/N: 437TUX0086** **SR:12464-EMC-00077**
Battery Part No: NNTN9089A **Accy Part No: NA**
Test Mode: TX APCO Digital C4FM
860.012500 MHz **12.5 kHz** **1.000 Watt(s) /Low Power**

Frequency (MHz)	Limit	Horizontal Measured Emission Equiv Pwr Into Ideal Dipole (dBm)	Vertical Measured Emission Equiv Pwr Into ideal Dipole (dBm)
1720.0250	-13.0000	-59.7585 **	-58.5403 **
2580.0375	-13.0000	-54.3941 **	-54.9665 **
3440.0500	-13.0000	-52.9511 **	-53.6502 **
4300.0625	-13.0000	-51.7344 **	-50.9986 **
5160.0750	-13.0000	-49.2185 **	-48.6270 **
6020.0875	-13.0000	-46.1806 **	-46.5774 **
6880.1000	-13.0000	-45.4724 **	-44.0129 **
7740.1125	-13.0000	-44.7421 **	-43.5580 **
8600.1250	-13.0000	-42.7858 **	-42.2978 **

RADIATED SPURIOUS EMISSIONS

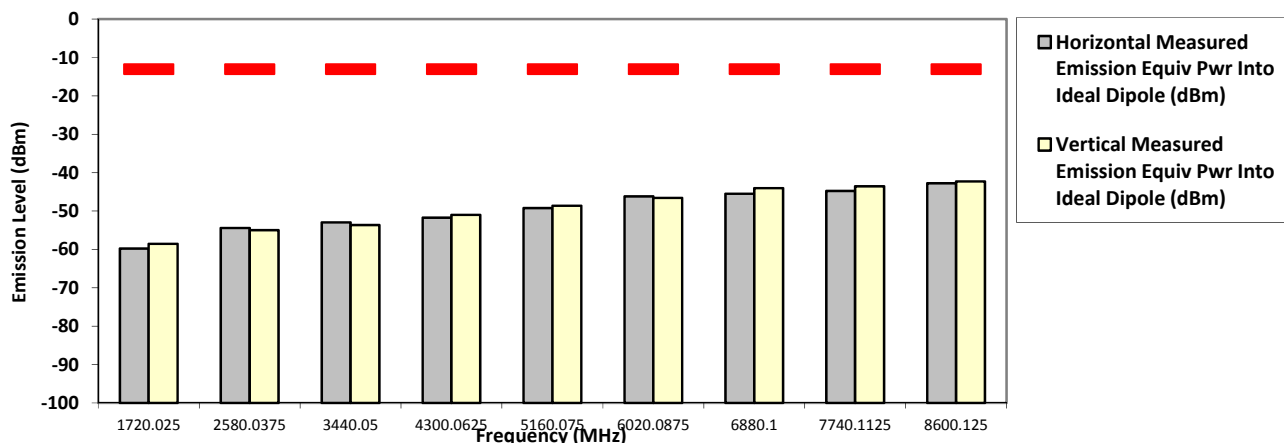

The data presented here was taken using the substitution method as found in the ANSI C63.26-2015 document.
 Motorola Penang EMC Lab - Test Performed by: Nazrin&Qawiman Wed, Dec 26, 2018

Remarks: ** Indicates the spurious emission could not be detected due to noise limitations or ambient.
 *Pursuant to CFR 47 Part 2.1057 (c), emissions attenuated more than 20 dB below the permissible limit are not reported
 Temp(Deg): 23.5 Hum(%RH): 70.1

System MU: 5.01 dB

Remarks: Passed Results Marginal Results Failed Results

SAC Transmitter Radiated Emission:

Model Number: H55TGT9PW8AN **S/N: 437TUX0086** **SR:12464-EMC-00077**
Battery Part No: NNTN9089A **Accy Part No: NA**
Test Mode: TX APCO Digital C4FM
860.012500 MHz **12.5 kHz** **3.600 Watt(s) /Max Power**

Frequency (MHz)	Limit	Horizontal Measured Emission Equiv Pwr Into Ideal Dipole (dBm)	Vertical Measured Emission Equiv Pwr Into ideal Dipole (dBm)
1720.0250	-13.0000	-52.7400 *	-53.6100 *
2580.0375	-13.0000	-52.8944 **	-53.0529 **
3440.0500	-13.0000	-51.5161 **	-52.2238 **
4300.0625	-13.0000	-50.8267 **	-48.5713 **
5160.0750	-13.0000	-47.2206 **	-48.0895 **
6020.0875	-13.0000	-46.9003 **	-47.4706 **
6880.1000	-13.0000	-44.3787 **	-45.4982 **
7740.1125	-13.0000	-42.9803 **	-44.9145 **
8600.1250	-13.0000	-42.8585 **	-42.4611 **

RADIATED SPURIOUS EMISSIONS

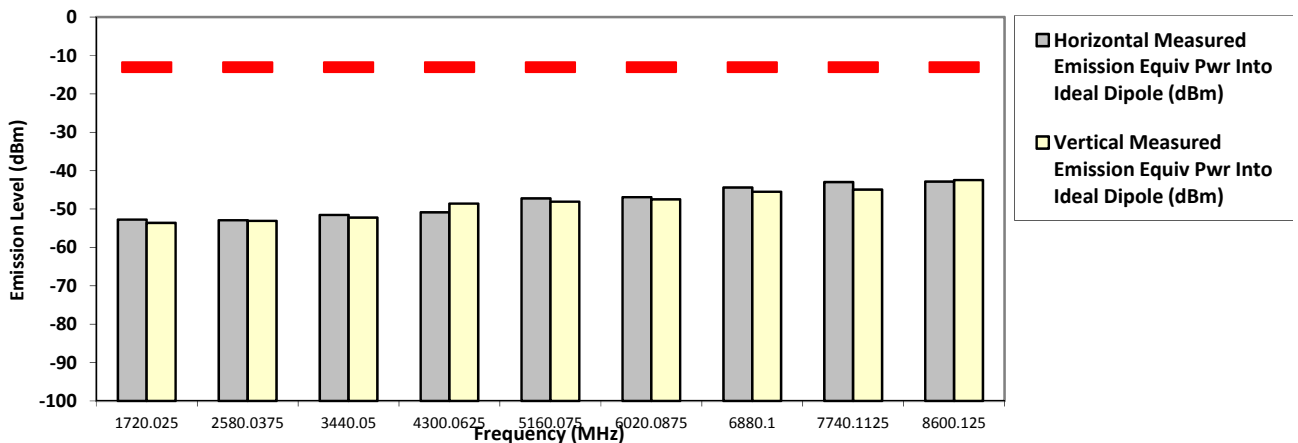

The data presented here was taken using the substitution method as found in the ANSI C63.26-2015 document.
 Motorola Penang EMC Lab - Test Performed by: Nazrin&Qawiman Wed, Dec 26, 2018

Remarks: ** Indicates the spurious emission could not be detected due to noise limitations or ambient.
 *Pursuant to CFR 47 Part 2.1057 (c), emissions attenuated more than 20 dB below the permissible limit are not reported
 Temp(Deg): 23.5 Hum(%RH): 70.1

System MU: 5.01 dB

Remarks:

Passed Results	Marginal Results	Failed Results
----------------	------------------	----------------

SAC Transmitter Radiated Emission:
Model Number: H55TGT9PW8AN **S/N: 437TUX0086** **SR:12464-EMC-00077**
Battery Part No: NNTN9089A **Accy Part No: NA**
Test Mode: TX APCO Digital C4FM
868.887500 MHz **12.5 kHz** **1.000 Watt(s) /Low Power**

Frequency (MHz)	Limit	Horizontal Measured Emission Equiv Pwr Into Ideal Dipole (dBm)	Vertical Measured Emission Equiv Pwr Into ideal Dipole (dBm)
1737.7750	-13.0000	-58.9010 **	-59.1207 **
2606.6625	-13.0000	-55.6279 **	-54.4103 **
3475.5500	-13.0000	-54.0401 **	-52.2341 **
4344.4375	-13.0000	-50.8242 **	-50.6939 **
5213.3250	-13.0000	-46.8374 **	-47.7626 **
6082.2125	-13.0000	-46.5407 **	-46.1142 **
6951.1000	-13.0000	-44.9659 **	-44.3015 **
7819.9875	-13.0000	-43.5780 **	-43.4912 **
8688.8750	-13.0000	-42.9176 **	-42.6592 **

RADIATED SPURIOUS EMISSIONS

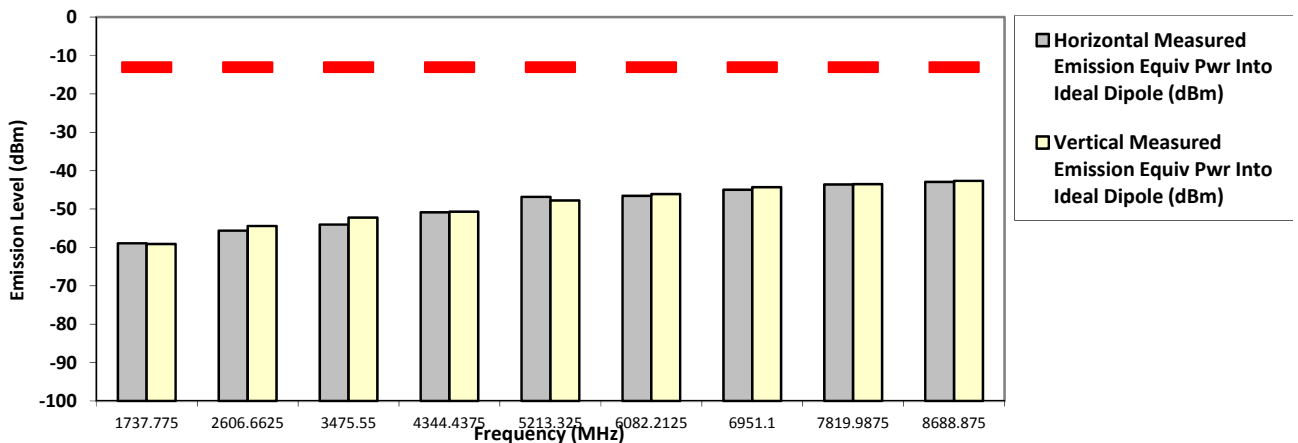

The data presented here was taken using the substitution method as found in the ANSI C63.26-2015 document.
 Motorola Penang EMC Lab - Test Performed by: Nazrin&Qawiman Wed, Dec 26, 2018

Remarks: ** Indicates the spurious emission could not be detected due to noise limitations or ambient.
 *Pursuant to CFR 47 Part 2.1057 (c), emissions attenuated more than 20 dB below the permissible limit are not reported
 Temp(Deg): 23.5 Hum(%RH): 70.1

System MU: 5.01 dB

Remarks: Passed Results Marginal Results Failed Results

SAC Transmitter Radiated Emission:

Model Number: H55TGT9PW8AN **S/N: 437TUX0086** **SR:12464-EMC-00077**
Battery Part No: NNTN9089A **Accy Part No: NA**
Test Mode: TX APCO Digital C4FM
868.887500 MHz **12.5 kHz** **3.600 Watt(s) /Max Power**

Frequency (MHz)	Limit	Horizontal Measured Emission Equiv Pwr Into Ideal Dipole (dBm)	Vertical Measured Emission Equiv Pwr Into ideal Dipole (dBm)
1737.7750	-13.0000	-49.6500 *	-53.2600 *
2606.6625	-13.0000	-52.0723 **	-53.3629 **
3475.5500	-13.0000	-52.0813 **	-51.6169 **
4344.4375	-13.0000	-50.1816 **	-49.5576 **
5213.3250	-13.0000	-47.4814 **	-47.6043 **
6082.2125	-13.0000	-46.8432 **	-47.3246 **
6951.1000	-13.0000	-45.0182 **	-44.7807 **
7819.9875	-13.0000	-42.8692 **	-42.9988 **
8688.8750	-13.0000	-43.2647 **	-43.0964 **

RADIATED SPURIOUS EMISSIONS

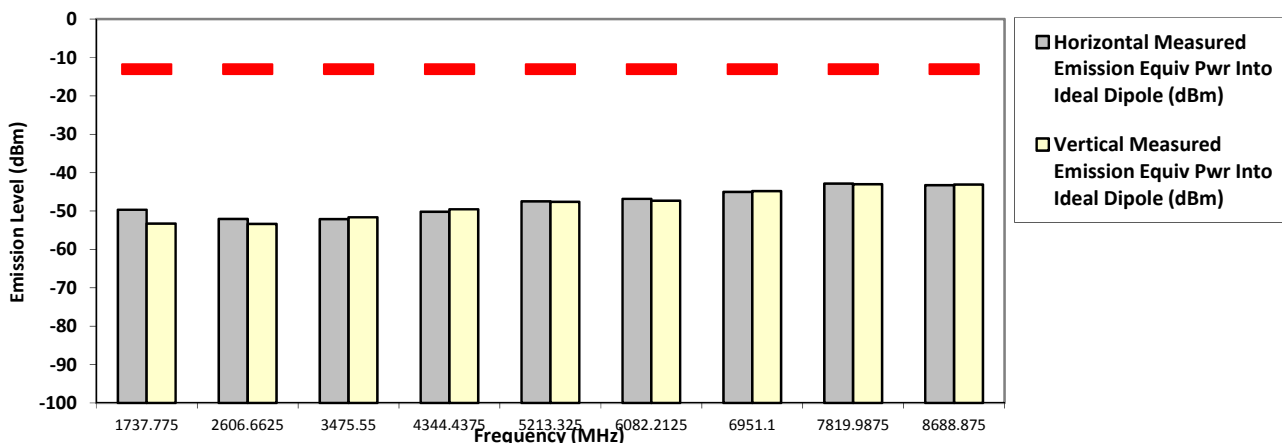

The data presented here was taken using the substitution method as found in the ANSI C63.26-2015 document.
 Motorola Penang EMC Lab - Test Performed by: Nazrin&Qawiman Thu, Jan 03, 2019

Remarks: ** Indicates the spurious emission could not be detected due to noise limitations or ambient.
 *Pursuant to CFR 47 Part 2.1057 (c), emissions attenuated more than 20 dB below the permissible limit are not reported
 Temp(Deg): 23.2 Hum(%RH): 70.0

System MU: 5.01 dB

Remarks: Passed Results Marginal Results Failed Results

SAC Transmitter Radiated Emission:
Model Number: H55TGT9PW8AN **S/N: 437TUX0086** **SR:12464-EMC-00077**
Battery Part No: NNTN9089A **Accy Part No: NA**
Test Mode: TX APCO Digital Phase II
806.012500 MHz **12.5 kHz** **1.000 Watt(s) /Low Power**

Frequency (MHz)	Limit	Horizontal Measured Emission Equiv Pwr Into Ideal Dipole (dBm)	Vertical Measured Emission Equiv Pwr Into ideal Dipole (dBm)
1612.0250	-13.0000	-55.4752 **	-55.8779 **
2418.0375	-13.0000	-55.7892 **	-55.4755 **
3224.0500	-13.0000	-51.6415 **	-51.3915 **
4030.0625	-13.0000	-52.5541 **	-51.6916 **
4836.0750	-13.0000	-49.1334 **	-49.3868 **
5642.0875	-13.0000	-47.9688 **	-48.7228 **
6448.1000	-13.0000	-46.7500 **	-46.2155 **
7254.1125	-13.0000	-43.9145 **	-43.8299 **
8060.1250	-13.0000	-45.7780 **	-45.2045 **

RADIATED SPURIOUS EMISSIONS

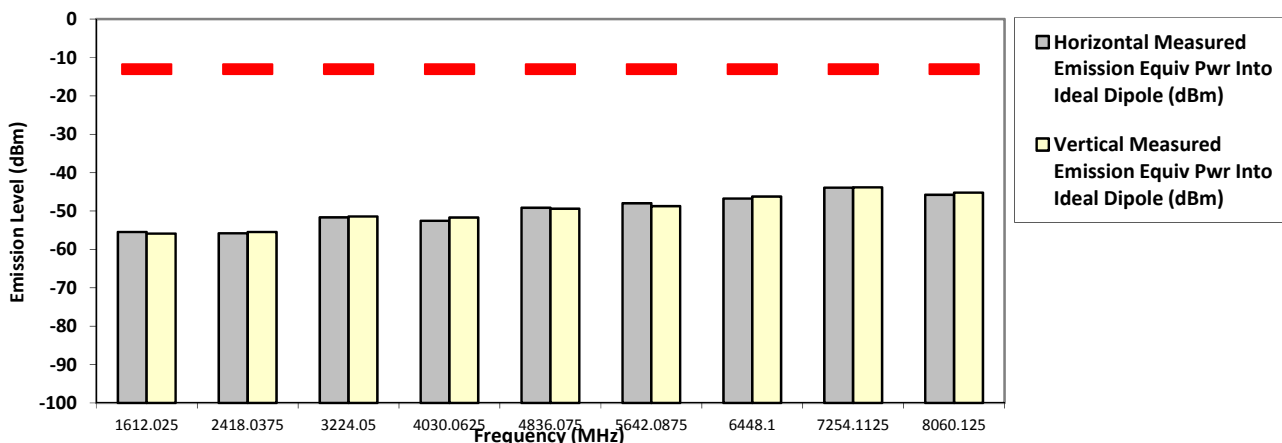

The data presented here was taken using the substitution method as found in the ANSI C63.26-2015 document.
 Motorola Penang EMC Lab - Test Performed by: Nazrin&Qawiman Wed, Dec 26, 2018

Remarks: ** Indicates the spurious emission could not be detected due to noise limitations or ambient.
 *Pursuant to CFR 47 Part 2.1057 (c), emissions attenuated more than 20 dB below the permissible limit are not reported
 Temp(Deg): 23.5 Hum(%RH): 70.1

System MU: 5.01 dB

Remarks: Passed Results Marginal Results Failed Results

SAC Transmitter Radiated Emission:
Model Number: H55TGT9PW8AN **S/N: 437TUX0086** **SR:12464-EMC-00077**
Battery Part No: NNTN9089A **Accy Part No: NA**
Test Mode: TX APCO Digital Phase II
806.012500 MHz **12.5 kHz** **3.600 Watt(s) /Max Power**

Frequency (MHz)	Limit	Horizontal Measured Emission Equiv Pwr Into Ideal Dipole (dBm)	Vertical Measured Emission Equiv Pwr Into ideal Dipole (dBm)
1612.0250	-13.0000	-52.3000 *	-54.2300 *
2418.0375	-13.0000	-53.5277 **	-55.3496 **
3224.0500	-13.0000	-46.0600 *	-46.6400 *
4030.0625	-13.0000	-51.4201 **	-51.3372 **
4836.0750	-13.0000	-48.0300 **	-49.3957 **
5642.0875	-13.0000	-48.7186 **	-48.2543 **
6448.1000	-13.0000	-46.1837 **	-46.2750 **
7254.1125	-13.0000	-43.4065 **	-44.0956 **
8060.1250	-13.0000	-43.3896 **	-43.2383 **

RADIATED SPURIOUS EMISSIONS

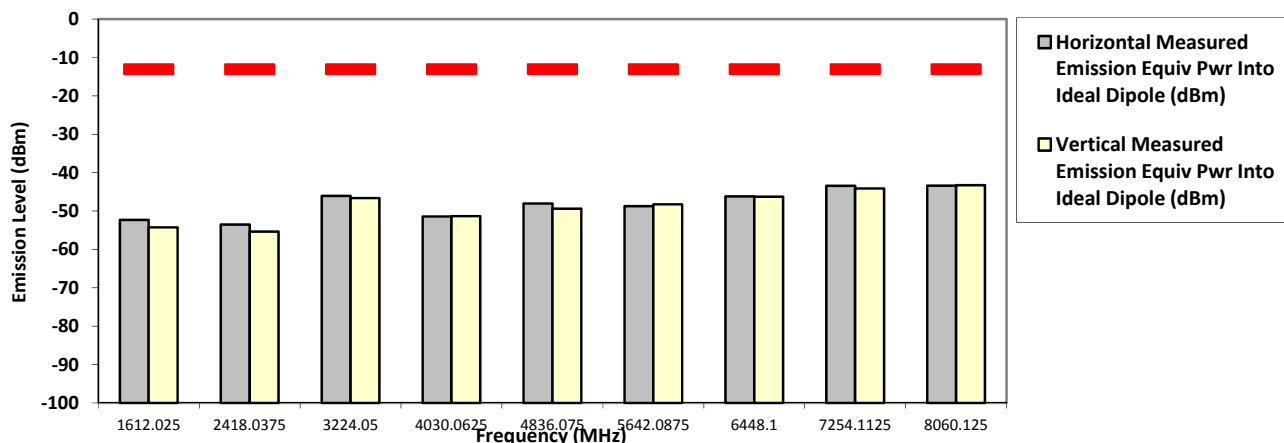

The data presented here was taken using the substitution method as found in the ANSI C63.26-2015 document.
 Motorola Penang EMC Lab - Test Performed by: Nazrin&Qawiman Wed, Dec 26, 2018

Remarks: ** Indicates the spurious emission could not be detected due to noise limitations or ambient.
 *Pursuant to CFR 47 Part 2.1057 (c), emissions attenuated more than 20 dB below the permissible limit are not reported
 Temp(Deg): 23.5 Hum(%RH): 70.1

System MU: 5.01 dB

Remarks: Passed Results Marginal Results Failed Results

SAC Transmitter Radiated Emission:
Model Number: H55TGT9PW8AN **S/N: 437TUX0086** **SR:12464-EMC-00077**
Battery Part No: NNTN9089A **Accy Part No: NA**
Test Mode: TX APCO Digital Phase II
814.987500 MHz **12.5 kHz** **1.000 Watt(s) /Low Power**

Frequency (MHz)	Limit	Horizontal Measured Emission Equiv Pwr Into Ideal Dipole (dBm)	Vertical Measured Emission Equiv Pwr Into ideal Dipole (dBm)
1629.9750	-13.0000	-59.7780 **	-59.1065 **
2444.9625	-13.0000	-55.9685 **	-55.6179 **
3259.9500	-13.0000	-53.1488 **	-52.8788 **
4074.9375	-13.0000	-50.5003 **	-51.2261 **
4889.9250	-13.0000	-48.9954 **	-49.7634 **
5704.9125	-13.0000	-47.1929 **	-48.9707 **
6519.9000	-13.0000	-45.5542 **	-46.0910 **
7334.8875	-13.0000	-43.4887 **	-43.6463 **
8149.8750	-13.0000	-47.3596 **	-46.8677 **

RADIATED SPURIOUS EMISSIONS

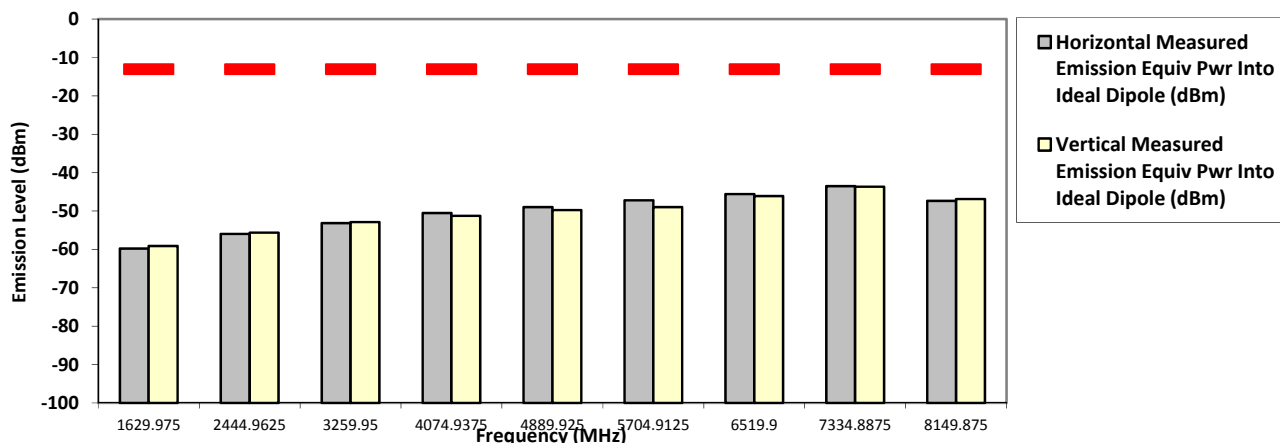

The data presented here was taken using the substitution method as found in the ANSI C63.26-2015 document.
 Motorola Penang EMC Lab - Test Performed by: Nazrin&Qawiman Wed, Dec 26, 2018

Remarks: ** Indicates the spurious emission could not be detected due to noise limitations or ambient.
 *Pursuant to CFR 47 Part 2.1057 (c), emissions attenuated more than 20 dB below the permissible limit are not reported
 Temp(Deg): 23.5 Hum(%RH): 70.1

System MU: 5.01 dB

Remarks: Passed Results Marginal Results Failed Results

SAC Transmitter Radiated Emission:

Model Number: H55TGT9PW8AN S/N: 437TUX0086 SR:12464-EMC-00077
 Battery Part No: NNTN9089A Accy Part No: NA
 Test Mode: TX APCO Digital Phase II
 823.987500 MHz 12.5 kHz 1.000 Watt(s) /Low Power

Frequency (MHz)	Limit	Horizontal Measured Emission Equiv Pwr Into Ideal Dipole (dBm)	Vertical Measured Emission Equiv Pwr Into ideal Dipole (dBm)
1647.9750	-13.0000	-58.7344 **	-59.2123 **
2471.9625	-13.0000	-56.6074 **	-55.3019 **
3295.9500	-13.0000	-52.7799 **	-51.6115 **
4119.9375	-13.0000	-51.3442 **	-51.1742 **
4943.9250	-13.0000	-48.5239 **	-49.3238 **
5767.9125	-13.0000	-48.1391 **	-47.0871 **
6591.9000	-13.0000	-45.2148 **	-45.9644 **
7415.8875	-13.0000	-43.7671 **	-42.9791 **
8239.8750	-13.0000	-45.8751 **	-45.0785 **

RADIATED SPURIOUS EMISSIONS

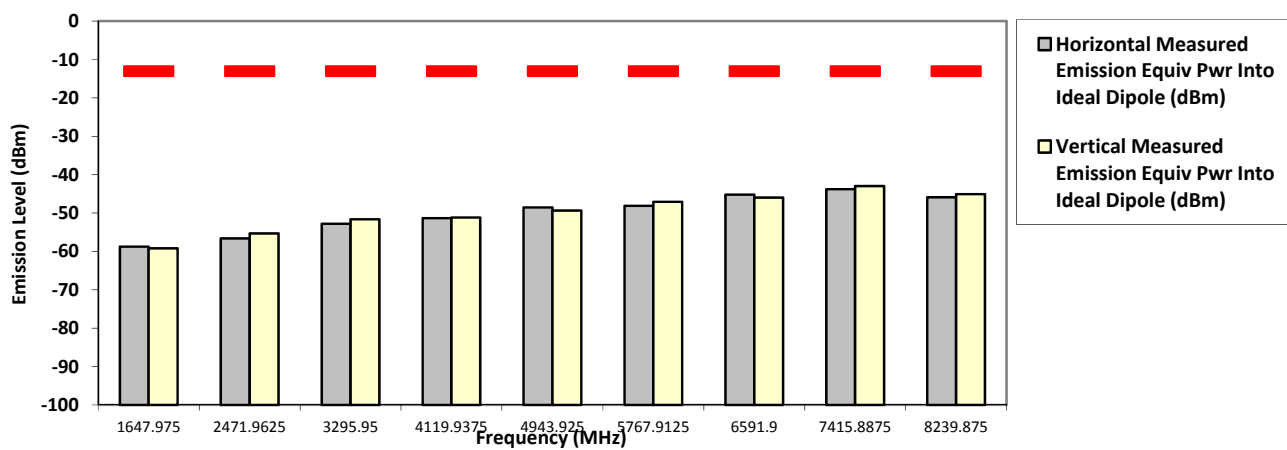

The data presented here was taken using the substitution method as found in the ANSI C63.26-2015 document.
 Motorola Penang EMC Lab - Test Performed by: Nazrin&Qawiman Wed, Dec 26, 2018

Remarks: ** Indicates the spurious emission could not be detected due to noise limitations or ambient.
 *Pursuant to CFR 47 Part 2.1057 (c), emissions attenuated more than 20 dB below the permissible limit are not reported
 Temp(Deg): 23.5 Hum(%RH): 70.1

System MU: 5.01 dB

Remarks: Passed Results Marginal Results Failed Results

SAC Transmitter Radiated Emission:
Model Number: H55TGT9PW8AN **S/N: 437TUX0086** **SR:12464-EMC-00077**
Battery Part No: NNTN9089A **Accy Part No: NA**
Test Mode: TX APCO Digital Phase II
823.987500 MHz **12.5 kHz** **3.600 Watt(s) /Max Power**

Frequency (MHz)	Limit	Horizontal Measured Emission Equiv Pwr Into Ideal Dipole (dBm)	Vertical Measured Emission Equiv Pwr Into ideal Dipole (dBm)
1647.9750	-13.0000	-50.4600 *	-51.8700 *
2471.9625	-13.0000	-54.6609 **	-54.8631 **
3295.9500	-13.0000	-52.2862 **	-50.1567 **
4119.9375	-13.0000	-50.5355 **	-51.6133 **
4943.9250	-13.0000	-49.0274 **	-49.0951 **
5767.9125	-13.0000	-48.4893 **	-47.4626 **
6591.9000	-13.0000	-45.0714 **	-45.2468 **
7415.8875	-13.0000	-43.2853 **	-43.6977 **
8239.8750	-13.0000	-46.3116 **	-45.9214 **

RADIATED SPURIOUS EMISSIONS

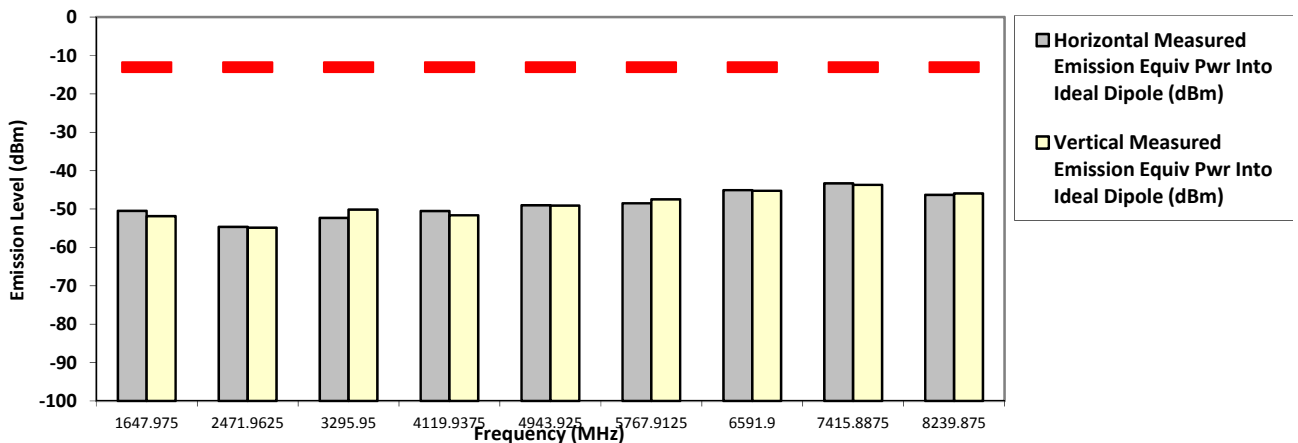

The data presented here was taken using the substitution method as found in the ANSI C63.26-2015 document.
 Motorola Penang EMC Lab - Test Performed by: Nazrin&Qawiman Wed, Dec 26, 2018

Remarks: ** Indicates the spurious emission could not be detected due to noise limitations or ambient.
 *Pursuant to CFR 47 Part 2.1057 (c), emissions attenuated more than 20 dB below the permissible limit are not reported
 Temp(Deg): 23.5 Hum(%RH): 70.1

System MU: 5.01 dB

Remarks:

Passed Results	Marginal Results	Failed Results
----------------	------------------	----------------

SAC Transmitter Radiated Emission:
Model Number: H55TGT9PW8AN **S/N: 437TUX0086** **SR:12464-EMC-00077**
Battery Part No: NNTN9089A **Accy Part No: NA**
Test Mode: TX APCO Digital Phase II
851.012500 MHz **12.5 kHz** **1.000 Watt(s) /Low Power**

Frequency (MHz)	Limit	Horizontal Measured Emission Equiv Pwr Into Ideal Dipole (dBm)	Vertical Measured Emission Equiv Pwr Into ideal Dipole (dBm)
1702.0250	-13.0000	-58.7785 **	-58.0599 **
2553.0375	-13.0000	-54.4631 **	-54.8280 **
3404.0500	-13.0000	-53.2939 **	-52.2167 **
4255.0625	-13.0000	-51.4884 **	-51.0812 **
5106.0750	-13.0000	-47.9118 **	-48.4162 **
5957.0875	-13.0000	-46.8756 **	-45.8976 **
6808.1000	-13.0000	-45.6924 **	-45.8314 **
7659.1125	-13.0000	-43.8018 **	-43.3683 **
8510.1250	-13.0000	-43.0018 **	-43.5287 **

RADIATED SPURIOUS EMISSIONS

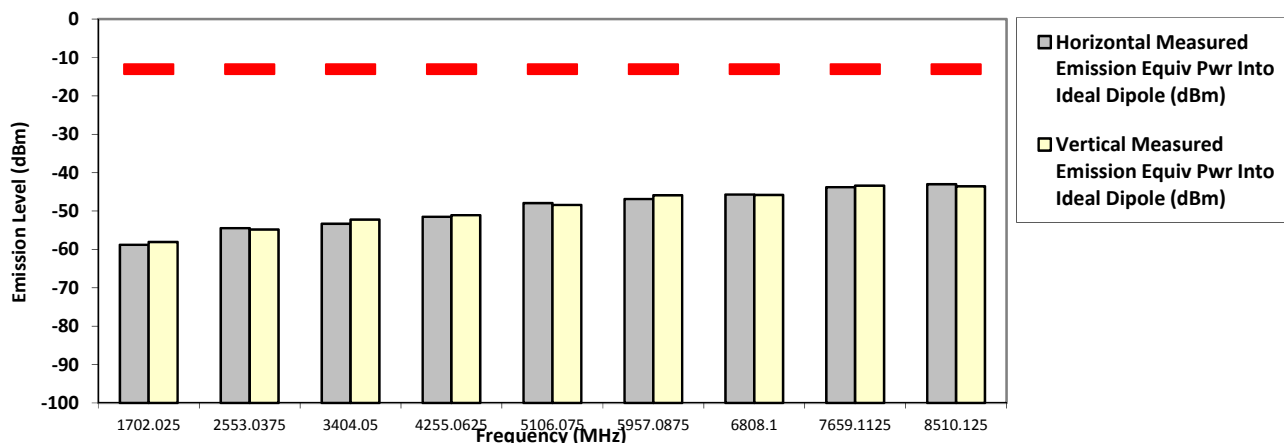

The data presented here was taken using the substitution method as found in the ANSI C63.26-2015 document.
 Motorola Penang EMC Lab - Test Performed by: Nazrin&Qawiman Wed, Dec 26, 2018

Remarks: ** Indicates the spurious emission could not be detected due to noise limitations or ambient.
 *Pursuant to CFR 47 Part 2.1057 (c), emissions attenuated more than 20 dB below the permissible limit are not reported
 Temp(Deg): 23.5 Hum(%RH): 70.1

System MU: 5.01 dB

Remarks: Passed Results Marginal Results Failed Results

SAC Transmitter Radiated Emission:
Model Number: H55TGT9PW8AN **S/N: 437TUX0086** **SR:12464-EMC-00077**
Battery Part No: NNTN9089A **Accy Part No: NA**
Test Mode: TX APCO Digital Phase II
851.012500 MHz **12.5 kHz** **3.600 Watt(s) /Max Power**

Frequency (MHz)	Limit	Horizontal Measured Emission Equiv Pwr Into Ideal Dipole (dBm)	Vertical Measured Emission Equiv Pwr Into ideal Dipole (dBm)
1702.0250	-13.0000	-50.8200 *	-51.9200 *
2553.0375	-13.0000	-49.1100 *	-49.0000 *
3404.0500	-13.0000	-50.7750 **	-52.3042 **
4255.0625	-13.0000	-51.8371 **	-50.8301 **
5106.0750	-13.0000	-48.0584 **	-47.5336 **
5957.0875	-13.0000	-46.2665 **	-47.1375 **
6808.1000	-13.0000	-45.1814 **	-45.0885 **
7659.1125	-13.0000	-43.6435 **	-43.6648 **
8510.1250	-13.0000	-42.9174 **	-43.4182 **

RADIATED SPURIOUS EMISSIONS

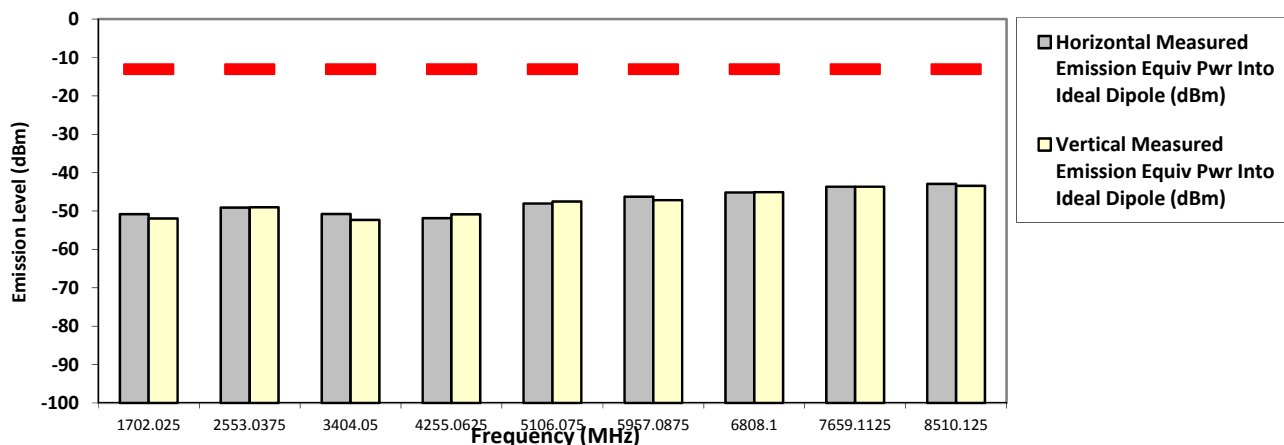

The data presented here was taken using the substitution method as found in the ANSI C63.26-2015 document.
 Motorola Penang EMC Lab - Test Performed by: Nazrin&Qawiman Wed, Dec 26, 2018

Remarks: ** Indicates the spurious emission could not be detected due to noise limitations or ambient.
 *Pursuant to CFR 47 Part 2.1057 (c), emissions attenuated more than 20 dB below the permissible limit are not reported
 Temp(Deg): 23.5 Hum(%RH): 70.1

System MU: 5.01 dB

Remarks: Passed Results Marginal Results Failed Results

SAC Transmitter Radiated Emission:
Model Number: H55TGT9PW8AN **S/N: 437TUX0086** **SR:12464-EMC-00077**
Battery Part No: NNTN9089A **Accy Part No: NA**
Test Mode: TX APCO Digital Phase II
860.012500 MHz **12.5 kHz** **1.000 Watt(s) /Low Power**

Frequency (MHz)	Limit	Horizontal Measured Emission Equiv Pwr Into Ideal Dipole (dBm)	Vertical Measured Emission Equiv Pwr Into ideal Dipole (dBm)
1720.0250	-13.0000	-59.6590 **	-59.2968 **
2580.0375	-13.0000	-54.9923 **	-55.0891 **
3440.0500	-13.0000	-53.9298 **	-52.2032 **
4300.0625	-13.0000	-51.4792 **	-50.8347 **
5160.0750	-13.0000	-48.3485 **	-48.8779 **
6020.0875	-13.0000	-46.8048 **	-46.7341 **
6880.1000	-13.0000	-44.3106 **	-45.2829 **
7740.1125	-13.0000	-43.5417 **	-44.6184 **
8600.1250	-13.0000	-42.8408 **	-42.4947 **

RADIATED SPURIOUS EMISSIONS

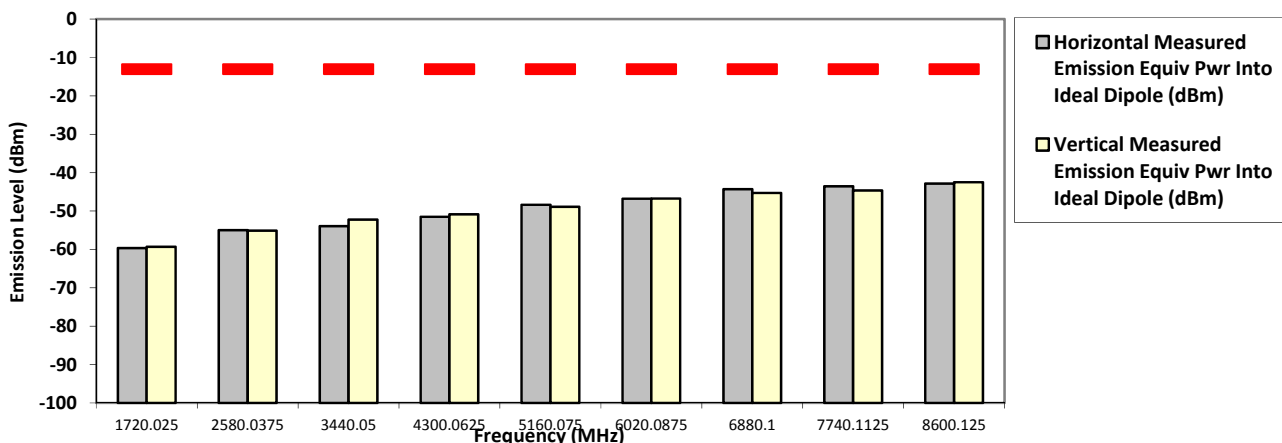

The data presented here was taken using the substitution method as found in the ANSI C63.26-2015 document.
 Motorola Penang EMC Lab - Test Performed by: Nazrin&Qawiman Wed, Dec 26, 2018

Remarks: ** Indicates the spurious emission could not be detected due to noise limitations or ambient.
 *Pursuant to CFR 47 Part 2.1057 (c), emissions attenuated more than 20 dB below the permissible limit are not reported
 Temp(Deg): 23.5 Hum(%RH): 70.1

System MU: 5.01 dB

Remarks: Passed Results Marginal Results Failed Results

SAC Transmitter Radiated Emission:
Model Number: H55TGT9PW8AN **S/N: 437TUX0086** **SR:12464-EMC-00077**
Battery Part No: NNTN9089A **Accy Part No: NA**
Test Mode: TX APCO Digital Phase II
860.012500 MHz **12.5 kHz** **3.600 Watt(s) /Max Power**

Frequency (MHz)	Limit	Horizontal Measured Emission Equiv Pwr Into Ideal Dipole (dBm)	Vertical Measured Emission Equiv Pwr Into ideal Dipole (dBm)
1720.0250	-13.0000	-56.1843 **	-57.4152 **
2580.0375	-13.0000	-52.3181 **	-53.7282 **
3440.0500	-13.0000	-51.3877 **	-53.3507 **
4300.0625	-13.0000	-51.2671 **	-51.0970 **
5160.0750	-13.0000	-47.4338 **	-47.9332 **
6020.0875	-13.0000	-44.9876 **	-47.6579 **
6880.1000	-13.0000	-45.5173 **	-45.6590 **
7740.1125	-13.0000	-43.2827 **	-44.2957 **
8600.1250	-13.0000	-42.6529 **	-42.2271 **

RADIATED SPURIOUS EMISSIONS

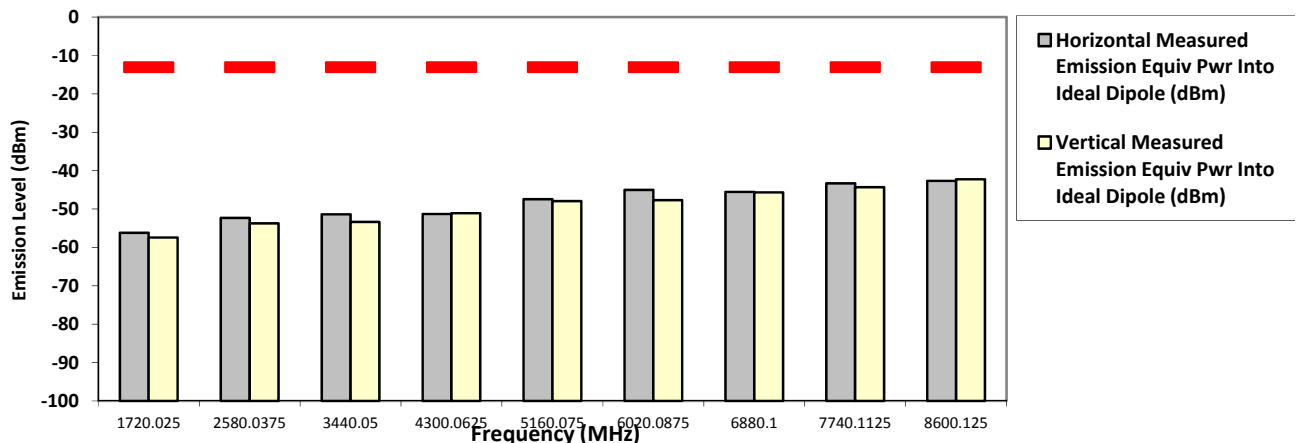

The data presented here was taken using the substitution method as found in the ANSI C63.26-2015 document.
 Motorola Penang EMC Lab - Test Performed by: Nazrin&Qawiman Wed, Dec 26, 2018

Remarks: ** Indicates the spurious emission could not be detected due to noise limitations or ambient.
 *Pursuant to CFR 47 Part 2.1057 (c), emissions attenuated more than 20 dB below the permissible limit are not reported
 Temp(Deg): 23.5 Hum(%RH): 70.1

System MU: 5.01 dB

Remarks: Passed Results Marginal Results Failed Results

SAC Transmitter Radiated Emission:

Model Number: H55TGT9PW8AN S/N: 437TUX0086 SR:12464-EMC-00077
 Battery Part No: NNTN9089A Accy Part No: NA
 Test Mode: TX APCO Digital Phase II
 868.887500 MHz 12.5 kHz 1.000 Watt(s) /Low Power

Frequency (MHz)	Limit	Horizontal Measured Emission Equiv Pwr Into Ideal Dipole (dBm)	Vertical Measured Emission Equiv Pwr Into ideal Dipole (dBm)
1737.7750	-13.0000	-58.7099 **	-58.1784 **
2606.6625	-13.0000	-55.0977 **	-53.9496 **
3475.5500	-13.0000	-53.6412 **	-53.9142 **
4344.4375	-13.0000	-51.2935 **	-51.6750 **
5213.3250	-13.0000	-48.2642 **	-48.0190 **
6082.2125	-13.0000	-46.3240 **	-46.7018 **
6951.1000	-13.0000	-45.1181 **	-44.8338 **
7819.9875	-13.0000	-43.0359 **	-43.3588 **
8688.8750	-13.0000	-42.3414 **	-42.4825 **

RADIATED SPURIOUS EMISSIONS

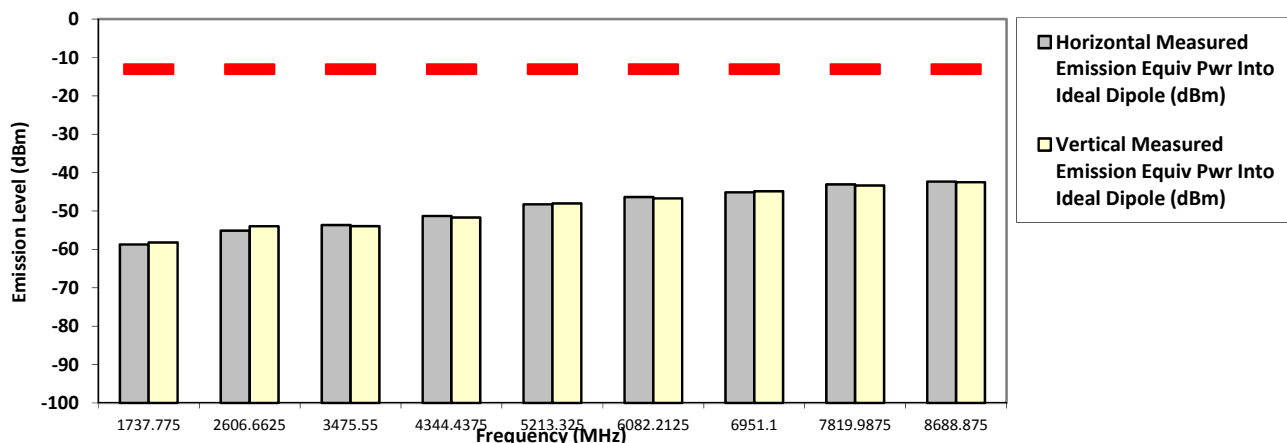

The data presented here was taken using the substitution method as found in the ANSI C63.26-2015 document.
 Motorola Penang EMC Lab - Test Performed by: Nazrin&Qawiman Wed, Dec 26, 2018

Remarks: ** Indicates the spurious emission could not be detected due to noise limitations or ambient.
 *Pursuant to CFR 47 Part 2.1057 (c), emissions attenuated more than 20 dB below the permissible limit are not reported
 Temp(Deg): 23.5 Hum(%RH): 70.1

System MU: 5.01 dB

Remarks: Passed Results Marginal Results Failed Results

SAC Transmitter Radiated Emission:
Model Number: H55TGT9PW8AN **S/N: 437TUX0086** **SR:12464-EMC-00077**
Battery Part No: NNTN9089A **Accy Part No: NA**
Test Mode: TX APCO Digital Phase II
868.887500 MHz **12.5 kHz** **3.600 Watt(s) /Max Power**

Frequency (MHz)	Limit	Horizontal Measured Emission Equiv Pwr Into Ideal Dipole (dBm)	Vertical Measured Emission Equiv Pwr Into ideal Dipole (dBm)
1737.7750	-13.0000	-52.1300 *	-54.0300 *
2606.6625	-13.0000	-53.6433 **	-53.7386 **
3475.5500	-13.0000	-52.8770 **	-50.6850 **
4344.4375	-13.0000	-50.4188 **	-50.4060 **
5213.3250	-13.0000	-48.0765 **	-47.8361 **
6082.2125	-13.0000	-45.9053 **	-46.3398 **
6951.1000	-13.0000	-44.7528 **	-44.4792 **
7819.9875	-13.0000	-42.9367 **	-43.2338 **
8688.8750	-13.0000	-42.8738 **	-41.8575 **

RADIATED SPURIOUS EMISSIONS

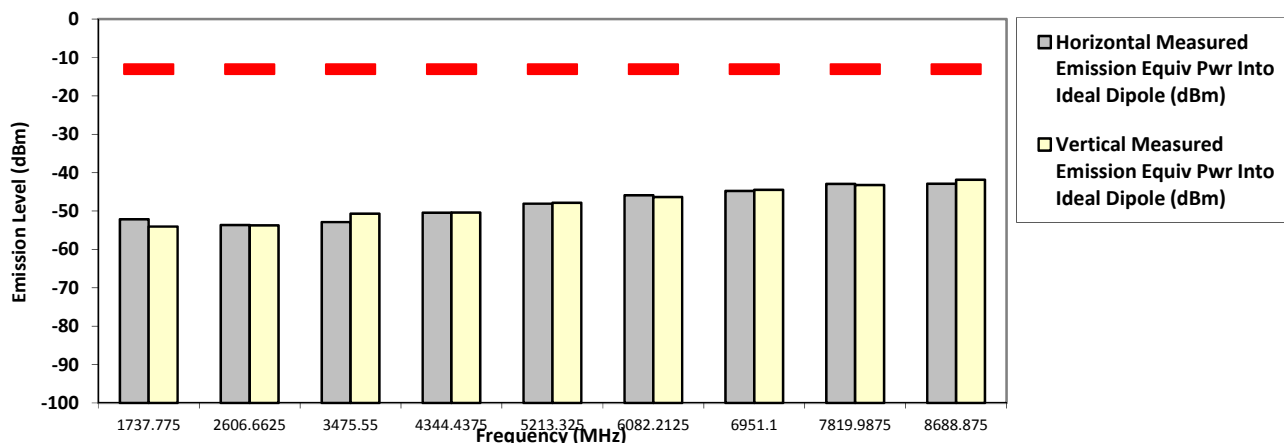

The data presented here was taken using the substitution method as found in the ANSI C63.26-2015 document.
 Motorola Penang EMC Lab - Test Performed by: Nazrin&Qawiman Thu, Jan 03, 2019

Remarks: ** Indicates the spurious emission could not be detected due to noise limitations or ambient.
 *Pursuant to CFR 47 Part 2.1057 (c), emissions attenuated more than 20 dB below the permissible limit are not reported
 Temp(Deg): 23.2 Hum(%RH): 70.0

System MU: 5.01 dB

Remarks: Passed Results Marginal Results Failed Results

6.13.4. Test Limit

Table below summarized the power of any emission outside a licensee’s frequency block shall be attenuated below the transmitter power (P) by at least

Channel Spacing	Part 22	Part 24D	Part 74	Part 80	Part 90 (UHF, VHF, 800, 900)	Part 90 (700)
12.5kHz	43 + log10(P) (-13 dBm)	43 + log10(P) (-13 dBm)	43 + log10(P) (-13 dBm)	Not Applicable	50 + log10(P) (-20 dBm)	43 + log10(P) (-13 dBm)
25kHz		Not Applicable		43 + log10(P) (-13 dBm)	43 + log10(P) (-13 dBm)	43 + log10(P) (-13 dBm)

Channel Spacing	RSS 134	RSS 182	RSS 119 (UHF, VHF, 800, 900)	RSS 119 (700)
12.5kHz	43 + log10(P) (-13 dBm)	Not Applicable	50 + log10(P) (-20 dBm)	43 + log10(P) (-13 dBm)
25kHz	Not Applicable	43 + log10(P) (-13 dBm)	43 + log10(P) (-13 dBm)	43 + log10(P) (-13 dBm)

6.14. Effective Radiated Power (ERP)

6.14.1. Test Setup

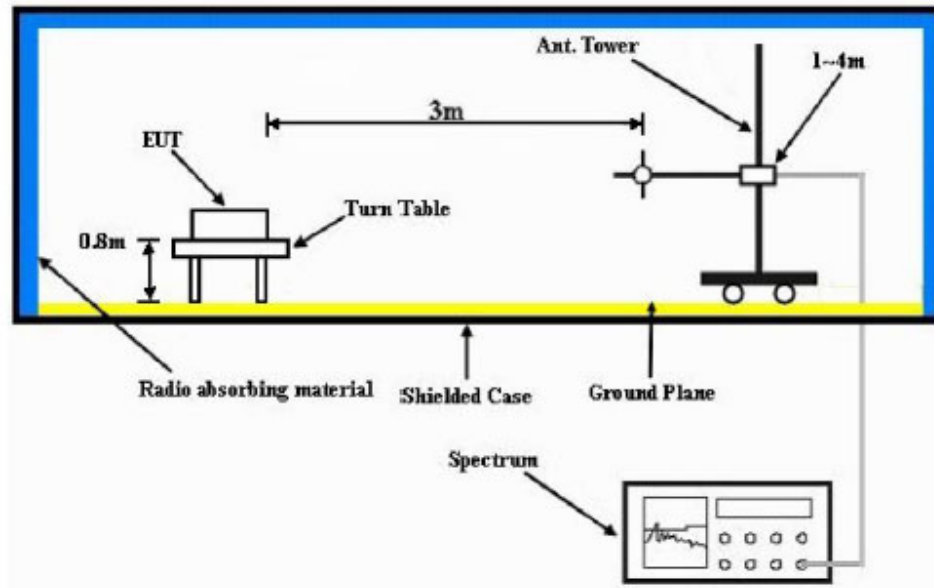

- 1) The Resolution Bandwidth for Equivalent Radiated Power (ERP) below 1 GHz is 100 kHz with Video Bandwidth = 300 kHz and Resolution Bandwidth for EIRP above 1 GHz is 1 MHz with Video Bandwidth = 3 MHz. Detector Mode is RMS.
- 2) In the semi-anechoic chamber, setup as illustrated above the DUT placed on the 0.8m height of Turn Table, rotated the table 45 degree each interval to search the maximum radiation power and receiver antenna shall be rotated vertical and horizontal polarization and moved height from 1m to 4m to find the maximum polar radiated power for each degree interval. The “Read Value” is the spectrum reading of maximum power value.
- 3) The substitution antenna is substituted for DUT at the same position and signals generator (S.G) export the CW signal to the substitution antenna via a TX cable. The receiver antenna shall be rotated vertical and horizontal polarization and moved height from 1m to 4m to find the maximum radiation power. Record the power level of maximum radiation power from spectrum. So, the Measured substitution value = Ref level of S.G + TX cables loss – Substituted Antenna Gain.

6.14.2. Test Result

NA → Not Applicable

6.14.3. Test Limit

The maximum output power of the transmitter for mobile stations is 100 watts (20 dB). Power is given in terms of effective radiated power (ERP).

6.15. GNSS (EIRP for 1559 - 1610MHz)

6.15.1. Test Setup

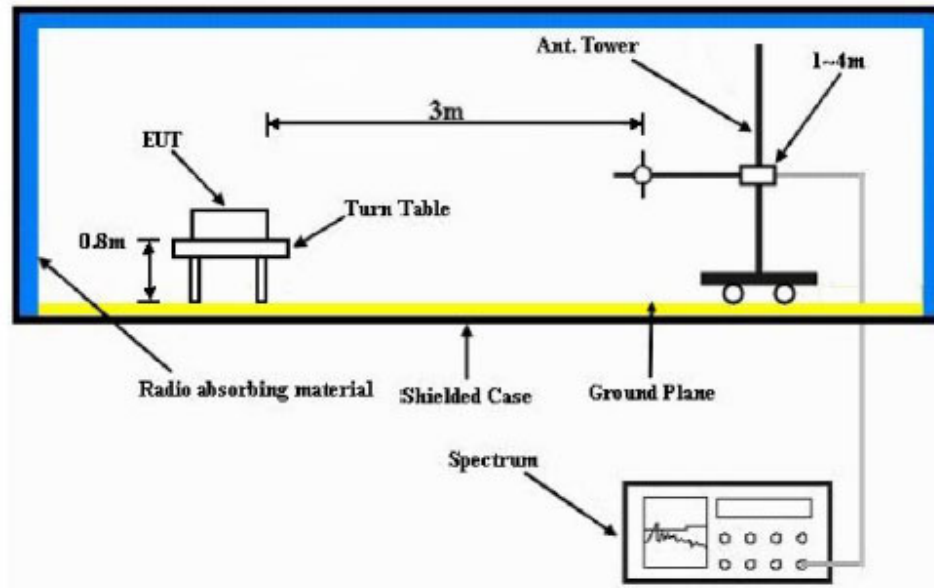

- 4) The Resolution Bandwidth for Equivalent Isotropically Radiated Power (EIRP) below 1 GHz is 100 kHz with Video Bandwidth = 300 kHz and Resolution Bandwidth for EIRP above 1 GHz is 1 MHz with Video Bandwidth = 3 MHz. Detector Mode is RMS.
- 5) In the semi-anechoic chamber, setup as illustrated above the DUT placed on the 0.8m height of Turn Table, rotated the table 45 degree each interval to search the maximum radiation power and receiver antenna shall be rotated vertical and horizontal polarization and moved height from 1m to 4m to find the maximum polar radiated power for each degree interval. The “Read Value” is the spectrum reading of maximum power value.
- 6) The substitution antenna is substituted for DUT at the same position and signals generator (S.G) export the CW signal to the substitution antenna via a TX cable. The receiver antenna shall be rotated vertical and horizontal polarization and moved height from 1m to 4m to find the maximum radiation power. Record the power level of maximum radiation power from spectrum. So, the Measured substitution value = Ref level of S.G + TX cables loss – Substituted Antenna Gain.
- 7) $EIRP = \text{“Read Value”} + \text{Measured substitution value} + 2.15$.

6.15.1. Test Result

NA → Not Applicable

6.15.2. Test Limit

For operations in the 758-775 MHz and 788-805 MHz bands, all emissions including harmonics in the band 1559-1610 MHz shall be limited to -70 dBW/MHz equivalent isotropically radiated power (EIRP) for wideband signals, and -80 dBW EIRP for discrete emissions of less than 700 Hz bandwidth.

~ End of Report ~