 MS ISO/IEC 17025 TESTING SMM No. 0825
---	--

<b>MOTOROLA PENANG ADV. COMM. LABORATORY</b> Motorola Solutions Malaysia Sdn Bhd Innoplex Plot 2A, Medan Bayan Lepas, Mukim 12 S.W.D, 11900 Bayan Lepas, Penang, Malaysia.	<b>FCC / ISED TEST REPORT</b> <b>Report Revision : Rev.A</b>
--	---

<p><b>Date/s Tested</b> : 24-DEC-2018 - 8-MAR-2019 <b>Report Issue Date</b> : 13-MAR-2019 <b>Manufacturer/Location</b> : Motorola Solutions Malaysia Sdn Bhd <b>Manufacturer Address</b> : Innoplex, 2A, Medan Bayan Lepas, 11900 Bayan Lepas Penang, Malaysia <b>Requestor</b> : HOPKINS, SEAN <b>Product Type</b> : Portable <b>Model Number</b> : H55TGT9PW8AN <b>Frequency Band</b> : 762-776MHz, 792-806MHz <b>Low / Max RF Output Power</b> : 1 Watts / 2.99 Watts <b>Application Name</b> : Motorola Solutions Inc <b>ISED Registrations</b> : 109AK <b>FCC Registrations</b> : 461337 <b>Firmware Version</b> : D19.70.35</p> <p><b>The equipment was tested accordance to the requirement listed below:</b></p> <p>(LMR) FCC 47 CFR Part 22 / 74 / 80 / 90 ISED RSS- Gen / 119</p>	
---	--

This report shall not be reproduced without written approval from an officially designated representative of the Motorola Penang Adv. Comm. Laboratory. The results and statements contained in this report pertain only to the device(s) evaluated.

Prepared By:  <hr/> <b>Khor Wei Loong</b> <b>Test Personnel</b>	Approved By:  <hr/> <b>Vincent Foong</b> <b>Responsible Engineer</b>
--	---

## Table of Contents

Report Revision History .....	3
1.0 General Information.....	4
2.0 Summary of Test Results .....	5
3.0 Measurement Uncertainty.....	6
4.0 Equipment List.....	7
5.0 Test Condition.....	10
5.1. Transmitter Test Conditions .....	10
6.0 Transmitter Test Parameters .....	11
6.1. RF Output Power .....	11
6.1.1. Test Setup.....	11
6.1.2. Test Result .....	11
6.2. Frequency Stability .....	12
6.2.1. Test Setup.....	12
6.2.2. Test Result .....	13
6.2.3. Test Limit.....	14
6.3. Audio Frequency Response .....	15
6.3.1. Test Setup.....	15
6.3.2. Test Result .....	15
6.3.3. Test Limit.....	16
6.4. Audio Low Pass Filter Response .....	17
6.4.1. Test Setup.....	17
6.4.2. Test Result .....	17
6.4.3. Test Limit.....	19
6.5. Modulation Limiting.....	20
6.5.1. Test Setup.....	20
6.5.2. Test Result .....	20
6.5.3. Test Limit.....	20
6.6. Occupied Bandwidth.....	21
6.6.1. Test Setup (Analog) .....	21
6.6.2. Test Result (Analog).....	21
6.6.3. Test Setup (Digital).....	22
6.6.4. Test Result (Digital).....	22
6.6.5. Test Limit.....	22
6.7. Band Edge Conducted Spurious Emission (Part 22) .....	23
6.7.1. Test Setup (Analog) .....	23
6.7.2. Test Result (Analog).....	23
6.7.3. Test Setup (Digital).....	24
6.7.4. Test Result (Digital).....	24
6.7.5. Test Limit.....	24
6.8. Transient Frequency Behavior.....	25
6.8.1. Test Setup.....	25
6.8.2. Test Result .....	25
6.8.3. Test Limit.....	25

6.9. Adjacent Channel Power..... 27

6.9.1. Test Setup (Analog) ..... 27

6.9.2. Test Result ..... 28

6.9.3. Test Setup (Digital)..... 30

6.9.4. Test Result ..... 31

6.10. Conducted Spurious Emission ..... 41

6.10.1. Test Setup..... 41

6.10.2. Test Result (Analog)..... 42

6.10.3. Test Result (Digital)..... 49

6.10.4. Test Limit..... 63

6.11. Radiated Spurious Emission ..... 64

6.11.1. Test Setup..... 64

6.11.2. Test Result (Analog)..... 65

6.11.3. Test Result (Digital)..... 78

6.11.4. Test Limit..... 78

6.12. Effective Radiated Power (ERP) ..... 105

6.12.1. Test Setup..... 105

6.12.2. Test Result ..... 105

6.12.3. Test Limit..... 105

6.13. GNSS (EIRP for 1559 - 1610MHz)..... 106

6.13.1. Test Setup..... 106

6.13.1. Test Result ..... 107

6.13.2. Test Limit..... 107

**Report Revision History**

<b>Revision History</b>	<b>Description</b>	<b>Date</b>	<b>Originator</b>
Rev. A	Initial Report	11-Mar-2019	Khor Wei Loong

## **1.0 General Information**

### **EUT Description:**

<b>Technologies</b>	Land Mobile Radio (LMR)
<b>Modulation Type</b>	Analog, C4FM , Phase II

### **General Description of Applied Standards**

The EUT is a RF Product. According to the specifications of the manufacturer, the EUT is to comply with the requirements of the following standards:

**ANSI C63.4-2014**

**ANSI C63.26-2015**

## 2.0 Summary of Test Results

FCC General Rules Part (47CFR)	ISED General Rules Part	Test Item	Result	Remark
2.1046,22.565, 74.461,74.534, 80.215	RSS-119	RF Power Output	NA	-
2.1055, 90.213,22.355	-	Frequency Stability	Pass	-
2.1047, 74.463, 80.213, RSS 119	RSS-119	Audio Frequency Response	Pass	-
2.1047, 74.463, 80.213, RSS 119	RSS-119	Audio Low Pass Filter Response	Pass	-
2.1047, 74.463, 80.213, RSS 119	RSS-119	Modulation limiting	Pass	-
2.1049, 90.210, 22.359, 74.462, 74.535, 80.211(c), 80.211(f)	RSS-119	Occupied Bandwidth	NA	-
90.543	RSS-119	Band Edge Conducted Spurious Emission	Pass	-
90.214	-	Transient Frequency Behavior	NA	-
90.543	RSS-119	Adjacent Channel Power	Pass	-
2.1051,22.359	RSS-119	Conducted Spurious Emissions	Pass	Highest Spur Level -42.25dBm
2.1053, 90.543	RSS-119	Radiated Spurious Emission	Pass	Highest Radiated Emission Level -42.38dBm
-	-	GNSS (EIRP for 1559 – 1610MHz)	NA	-
-	-	Effective Radiated Power (ERP)	NA	-

NA → Not Applicable

### 3.0 Measurement Uncertainty

Measurement	Frequency	Expanded Uncertainty (k=1.96) (±)
AC Power Line Conducted Spurious Emission	150KHz ~ 30MHz	3.43
Radiated Emissions up to 1 GHz	30MHz ~ 200MHz	5.01
	200MHz ~ 1000MHz	5.01
Radiated Emissions above 1 GHz	1GHz ~ 18GHz	5.01
	18GHz ~ 25GHz	5.01

#### 4.0 Equipment List

##### FCC Analog ATE#1: (SW version: 2.4.5 & FCC\_Frequency Stability 1.0.3 rev.)

Description	Model	Serial Number	Calibration Date	Calibration Due Date
Audio Analyzer	8903B	3011A10475	9-Jul-18	9-Jul-19
SIGNAL GENERATOR	2042	203001/904	8-Mar-18	9-Mar-19
MODULATION ANALYZER	8901B	3538A03696	3-Apr-18	3-Apr-19
DSA	36570A	MY42506781	6-Jul-18	6-Jul-19
POWER SENSOR	E9031A	MY41498969	17-Apr-18	17-Apr-19
POWER METER	E4416A	MY45101016	16-Jan-18	16-Jan-19
POWER SUPPLY	6031A	2430A00146	09-Apr-18	09-Apr-19
CHAMBER	SH-641	92009188	3-Apr-18	3-Apr-19
N to N RF Cable # 1	M17/128-RG400	NA	NA	NA
BNC to N RF Cable # 1	RG 58	NA	NA	NA
BNC to BNC RF Cable # 1	RG 58	NA	NA	NA
BNC to BNC RF Cable # 2	RG 58	NA	NA	NA
BNC to BNC RF Cable # 3	RG 58	NA	NA	NA
BNC to BNC RF Cable # 4	RG 58	NA	NA	NA
BNC to BNC RF Cable # 5	RG 58	NA	NA	NA
BNC to BNC RF Cable # 6	RG 58	NA	NA	NA
BNC to BNC RF Cable # 7	RG 58	NA	NA	NA
N to SMA RF Cable # 1	RG 58	NA	NA	NA
N to SMA RF Cable # 2	RG 58	NA	NA	NA
N to SMA RF Cable # 3	RG 58	NA	NA	NA
Aeroflex Attenuator 30dB	49-30-34-LIM	NA	NA	NA

**FCC Transient ATE #1: (SW version: FCC Transient ATE\_R1.1.2)**

Description	Model	Serial Number	Calibration Date	Calibration Due Date
POWER SUPPLY	6032A	2818A03549	11-Jul-18	11-Jul-19
POWER SENSOR	E4412A	MY41498918	29-Jul-18	29-Jul-19
POWER METER	E4416A	GB41293240	2-Mar-18	2-Mar-19
ATTENUATORS/SWITCH DRIVER	11713A	2508A10141	CNR	CNR
STEP ATTENUATOR/11dB	8494G	MY42143006	16-Apr-18	16-Apr-19
STEP ATTENUATOR/110dB	8496G	MY421430125	16-Apr-18	16-Apr-19
OSCILLOSCOPE	MSO8104A	MY45002372	26-Jun-18	26-Jun-19
AUDIO ANALYZER	8903B	3729A17409	18-Jul-18	18-Jul-19
AUDIO ANALYZER	8903B	3413A14586	7-Jul-18	7-Jul-19
MODULATION ANALYZER	8901B	3403A04772	31-Mar-18	31-Mar-19
SIGNAL GENERATOR	8657A	3039A3205	5-Jul-18	5-Jul-19
SPECTRUM ANALYZER	E4440A	MY46185415	16-Aug-17	16-Aug-19
N to N RF Cable # 1	SF126/11N/11N	NA	NA	NA
N to N RF Cable # 2	M17/128-RG400	NA	NA	NA
N to N RF Cable # 3	M17/128-RG400	NA	NA	NA
N to N RF Cable # 4	M17/128-RG400	NA	NA	NA
N to N RF Cable # 5	M17/128-RG400	NA	NA	NA
N to N RF Cable # 6	M17/128-RG400	NA	NA	NA
N to N RF Cable # 7	M17/128-RG400	NA	NA	NA
N to N RF Cable # 8	M17/128-RG400	NA	NA	NA
N to N RF Cable # 9	M17/128-RG400	NA	NA	NA
BNC to BNC RF Cable # 1	RG 58	NA	NA	NA
BNC to BNC RF Cable # 2	RG 58	NA	NA	NA
BNC to BNC RF Cable # 3	RG 58	NA	NA	NA
BNC to BNC RF Cable # 4	RG 58	NA	NA	NA
BNC to BNC RF Cable # 5	RG 58	NA	NA	NA
BNC to BNC RF Cable # 6	RG 58	NA	NA	NA
BNC to N RF Cable # 1	RG 58	NA	NA	NA
Aeroflex Attenuator 10dB	49-10-43-LIM	NA	NA	NA
Aeroflex Attenuator 10dB	33-10-34-LIM	NA	NA	NA
SWITCH CONTROL UNIT	3488A	2719A36210	CNR	CNR



**CONDUCTED SPUR EMISSION ATE # 1 (SW version: Conducted Spur ATE rev 1.23.02)**

Description	Model	Serial Number	Calibration Date	Calibration Due Date
SWITCH CONTROL UNIT	3488A	2719A32735	CNR	CNR
PSA Series Spectrum Analyzer	E4445A	MY46181732	16-Feb-17	16-Feb-19
POWER SUPPLY	6032A	3232A08203	9-Apr-18	9-Apr-19
HIGH PASS FILTER SWITCH BOX	-	CS001	5-Jul-18	5-Jul-19
N to N RF Cable # 1	SF126/11N/11N	NA	NA	NA
N to N RF Cable # 2	SF126/11N/11N	NA	NA	NA
BNC to BNC RF Cable # 1	RG 58	NA	NA	NA
Aeroflex Attenuator 30dB	49-30-43-LIM	NA	NA	NA
Aeroflex Attenuator 10dB	33-10-34-LIM	NA	NA	NA
Vector Signal Generator	SMU200A	103537	22-Jul-17	22-Jul-20

**EMC Chamber 1**

DESCRIPTION	MODEL	SERIAL NUMBER	CALIBRATION DATE	CALIBRATION DUE DATE
DRG HORN FREQ.	SAS-571	719	18-Jul-17	18-Jul-19
DRG HORN FREQ.	SAS-571	720	2-Mar-17	2-Mar-19
POWER SUPPLY	6032A	2615A-01178	13-Jun-18	13-Jun-19
MICROWAVE SIGNAL GENERATOR	SMP04	100131	12-Jul-18	11-Jul-19
EMI TEST RECEIVER	ESIB26	100017	11-Apr-18	11-Apr-19
EMI TEST RECEIVER	ESW44	101750	25-Jun-18	25-Jun-19
5m Semi-anechoic Chamber	S800-HX	J2308	CNR	CNR
BILOG ANTENNA	CBL6112D	30991	23-Apr-18	23-Apr-19
BILOG ANTENNA	CBL6112B	2964	16-Feb-18	16-Feb-20
DATA LOGGER	SDL500	A.016776	18-Mar-17	18-Mar-19
SYSTEM CONTROLLER	SC104V	050806-1	CNR	CNR
TURNTABLE FLUSH MOUNT 2M	FM2011	NA	CNR	CNR
ANTENNA POSITIONING TOWER	TLT2	NA	CNR	CNR
18 - 40GHz PREAMPLIFIER	Miteq Hi Gain Sucoflex	002	CNR	CNR
PREAMPLIFIER	PAM-0118P	361	CNR	CNR
Test Software	EMC_FCC_IC_Bluetooth_RE_Test			
Version	EMC_FCC_RE_v1.5.1			

**CNR → Calibration Not Require**

## 5.0 Test Condition

### 5.1. Transmitter Test Conditions

Test Item, (Channel Spacing)	Power (W)	Modulation	Test Frequency (MHz)	Tested By
RF Output Power	Low & Max	Analog	762.0125, 764.0125, 768.0125, 769.0125, 769.0875, 774.8875, 775.9875, 798.0125, 799.0875, 804.9125, 805.9875	Khor Wei Loong
Frequency Stability	Max	Analog	769.0875	Khor Wei Loong
Audio Frequency Response (12.5kHz / 25kHz)	Max	Analog	769.0875	Khor Wei Loong
Audio Low Pass Filter Response (12.5kHz / 25kHz)	Max	Analog	769.0875	Khor Wei Loong
Modulation limiting (12.5kHz / 25kHz)	Max	Analog	769.0875	Khor Wei Loong
Occupied Bandwidth (12.5kHz / 25kHz)	Max	Analog	NA	NA
Band Edge Conducted Spurious Emissions (Part 22) (12.5kHz / 20kHz / 25kHz)	Max	Analog	NA	NA
Transient Frequency Behavior (UHF & VHF Band) (12.5kHz / 25kHz)	Max	Analog	NA	NA
Adjacent Channel Power (700MHz Band) (12.5kHz)	Max	Analog	769.0875, 774.8875, 799.0875, 804.9125	Khor Wei Loong
Conducted Spurious Emissions- (12.5kHz / 25kHz)	Low / Max	Analog	762.0125, 769.0125, 774.8875, 794.0125, 799.0875, 804.9125	Khor Wei Loong
Radiated Spurious Emission (12.5kHz / 25kHz)	Low / Max	Analog	762.0125, 769.0125, 774.8875, 794.0125, 799.0875, 804.9125	Nazrin & Qawiman
GNSS (EIRP for 1559 - 1610MHz) (12.5kHz / 25kHz)	Max	Analog	NA	NA
Effective Radiated Power (ERP) (12.5kHz / 25kHz)	Max	Analog	NA	NA

NA → Not Applicable

## 6.0 Transmitter Test Parameters

### 6.1 RF Output Power

#### 6.1.1 Test Setup

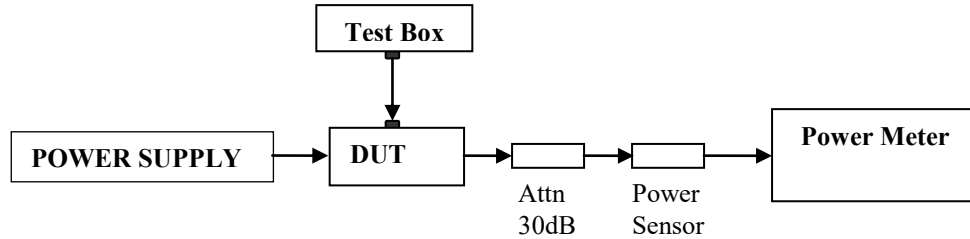

- 1) The DUT transmitter connected to Power Meter using the 30 dB attenuator and power sensor with above setup.
- 2) Path loss for the measurement included.
- 3) All the measurement was done at low, mid, high frequency for each band.
- 4) Record the power into the test report.

#### 6.1.2 Test Result

Temperature	25°C				Remarks
Voltage (V)	7.5V				
Frequency (MHz)	Low Power (W)	Current (A)	Max Power (W)	Current (A)	
762.0125	1.03	0.70	2.91	1.20	Not for FCC Review
764.0125	1.02	0.71	2.9	1.20	Not for FCC Review
768.0125	1.02	0.78	2.9	1.20	Not for FCC Review
769.0125	1.02	0.79	2.9	1.20	
769.0875	1.02	0.75	2.9	1.15	
774.8875	1.02	0.84	2.9	1.09	
775.9875	1.02	0.80	2.9	1.18	Not for FCC Review
798.0125	1.01	0.79	2.88	1.26	Not for FCC Review
799.0875	1.01	0.76	2.87	1.23	
804.9125	1.01	0.81	2.87	1.22	
805.9875	1.01	0.84	2.86	1.28	Not for FCC Review

## 6.2. Frequency Stability

### 6.2.1. Test Setup

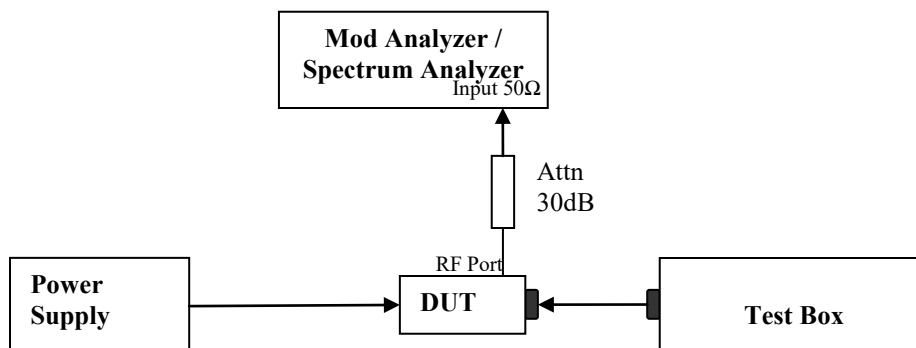

- 1) The DUT transmitter output port was connected to Modulation / Spectrum Analyzer.
- 2) Path loss for the measurement included.
- 3) Transmit the DUT and record the freq in  $MCF_{MHz}$ .
- 4) Test in 2 conditions:
  - Temperature: The frequency of the transmitter was measured from  $-30^{\circ}C$  to  $50^{\circ}C$ .
  - Supply Voltage:
    - Mobile: The frequency of the transmitter was measured from 85% to 115% of the nominal operating input voltage.
    - Portable: The frequency of the transmitter was measured from nominal  $\pm x\%$  as specified by the manufacturer
- 5) Calculate the ppm frequency error by the following:

$$ppm\ error = \left( \frac{MCF_{MHz}}{ACF_{MHz}} - 1 \right) * 10^6$$

Where:  $MCF_{MHz}$  is the Measured Carrier Frequency in MHz  
 $ACF_{MHz}$  is the Assigned Carrier Frequency in MHz

### 6.2.2. Test Result

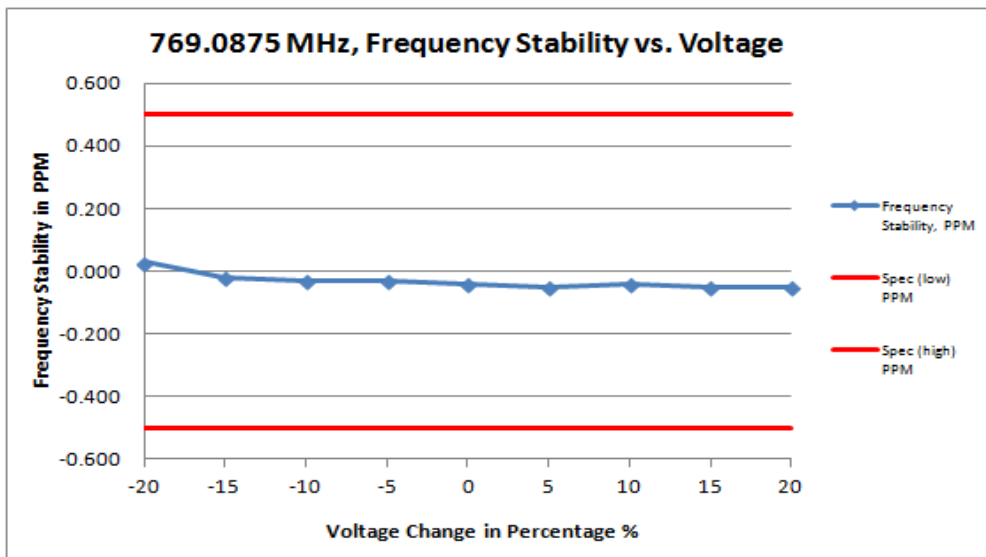

Frequency / Channel Spacing	769.0875 MHz / 12.5 kHz				
Temperature, °C	25				
Voltage %	Voltage, V	Frequency, MHz	Frequency Stability, PPM	Spec (low) PPM	Spec (high) PPM
-20	6.000	769.087523	0.030	-0.500	0.500
-15	6.370	769.087485	-0.020	-0.500	0.500
-10	6.750	769.087477	-0.030	-0.500	0.500
-5	7.120	769.087477	-0.030	-0.500	0.500
0	7.500	769.087469	-0.040	-0.500	0.500
5	7.870	769.087462	-0.050	-0.500	0.500
10	8.250	769.087469	-0.040	-0.500	0.500
15	8.620	769.087462	-0.050	-0.500	0.500
20	9.000	769.087462	-0.050	-0.500	0.500

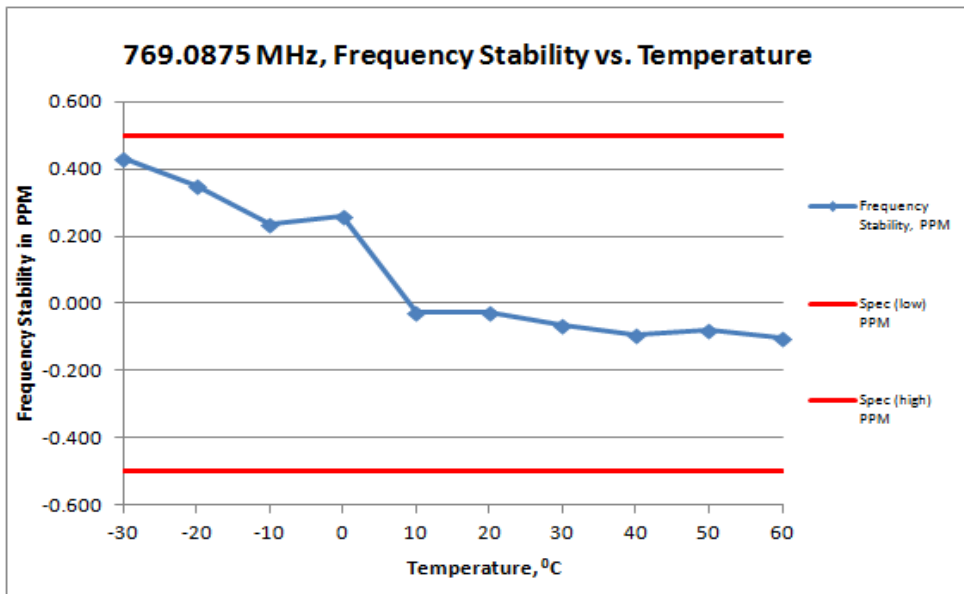

Frequency / Channel Spacing	769.0875 MHz / 12.5 kHz			
Voltage, V	7.5			
Temperature, °C	Frequency, MHz	Frequency Stability, PPM	Spec (low) PPM	Spec (high) PPM
-30	769.087950	0.429	-0.500	0.500
-20	769.087770	0.351	-0.500	0.500
-10	769.087680	0.234	-0.500	0.500
0	769.087700	0.260	-0.500	0.500
10	769.087480	-0.026	-0.500	0.500
20	769.087480	-0.026	-0.500	0.500
30	769.087450	-0.065	-0.500	0.500
40	769.087430	-0.091	-0.500	0.500
50	769.087440	-0.078	-0.500	0.500
60	769.087420	-0.104	-0.500	0.500

**6.2.3. Test Limit**

As per manufacturer declared spec +/- 0.5ppm

### 6.3. Audio Frequency Response

#### 6.3.1. Test Setup

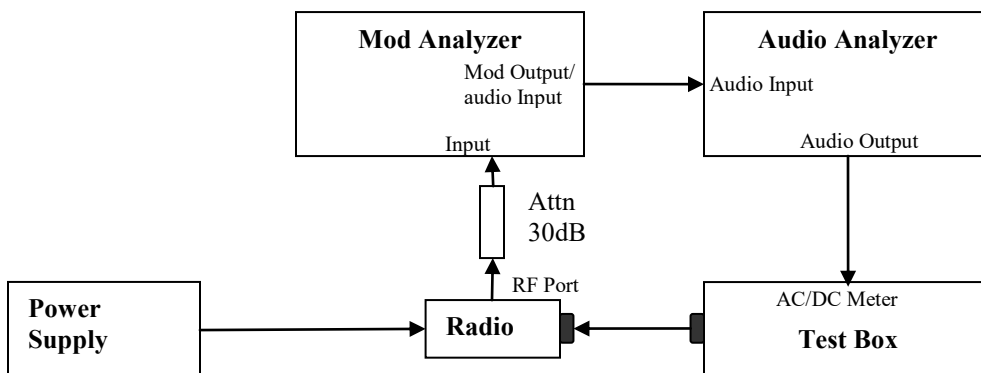

- 1) The DUT transmitter output port was connected to Modulation Analyzer.
- 2) Path loss for the measurement included.
- 3) Set the audio bandwidth filter to 15 kHz and 50 kHz.
- 4) Transmit the radio and set the audio analyzer to 1 kHz audio frequency and 20% of the Full rated system deviation.
- 5) On audio analyzer, set the rated level as reference to zero.
- 6) Vary the audio frequency from 300 Hz to 3 kHz. Record the change in dB on the audio analyzer.

#### 6.3.2. Test Result

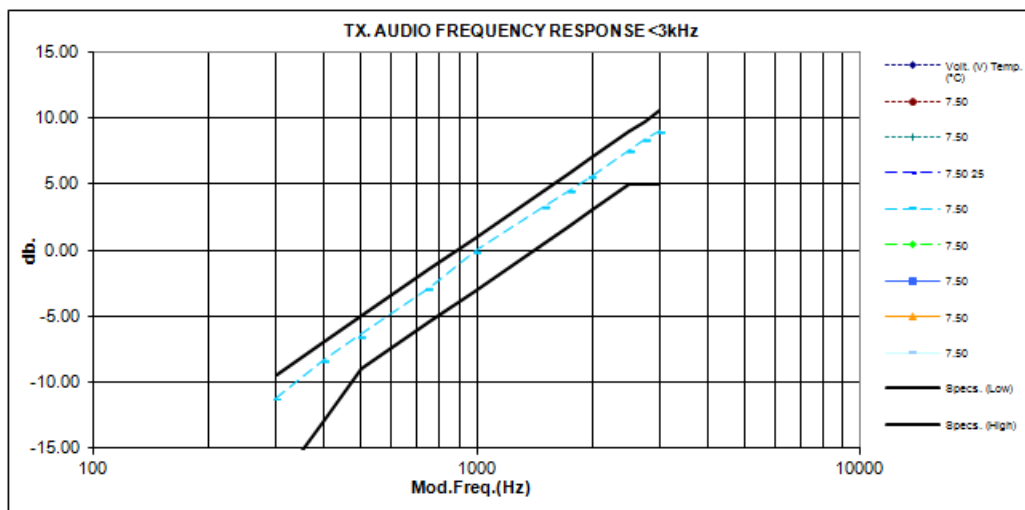

### 6.3.3. Test Limit

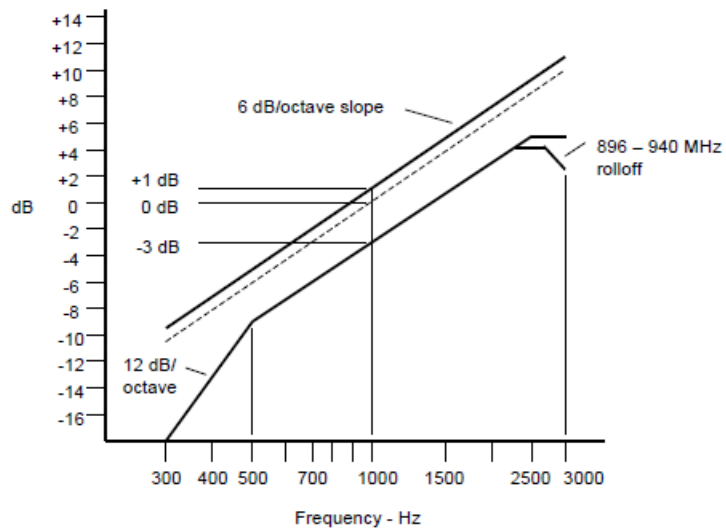

**Note:**

- o There are additional 6 dB per octave attenuation is allowed from 2.5KHz to 3KHz in equipment 25MHz to 869MHz radio.
- o Additional 6 dB per octave attenuation is allowed from 2.3KHz to 2.7KHz & additional 12 dB per octave attenuation is allowed from 2.7KHz to 3KHz in equipment 896MHz to 940MHz radio.



## 6.4. Audio Low Pass Filter Response

### 6.4.1. Test Setup

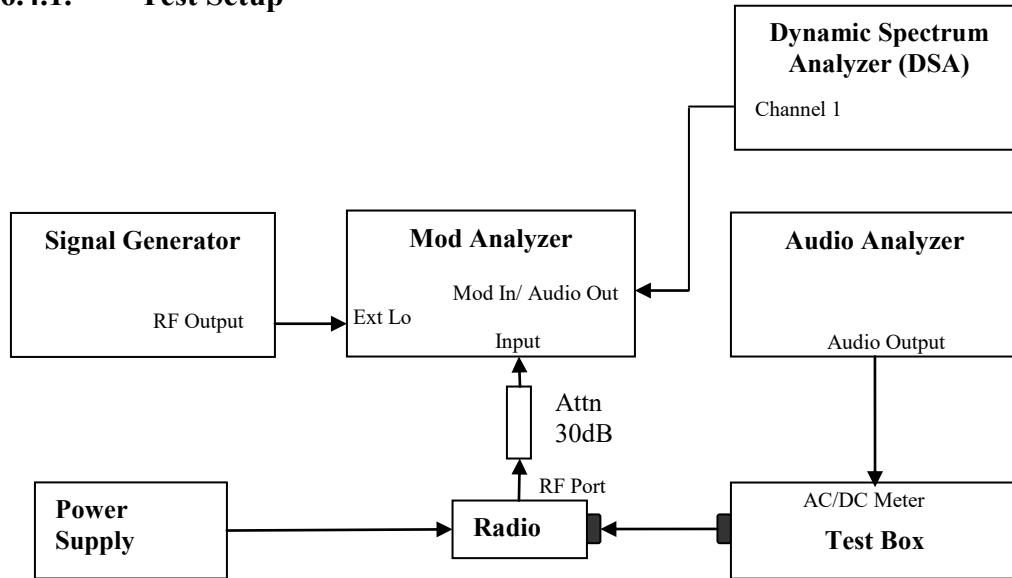

- 1) The DUT transmitter output port was connected to Modulation Analyzer.
- 2) Path loss for the measurement included.
- 3) Press 23.1SPCL on modulation analyzer to enable the external LO from Sigen.
- 4) Set the Sigen frequency to  $F_c + 1.5$  MHz, RF output level to 0dBm without modulation.
- 5) Transmit the radio and set the audio analyzer to 1 kHz audio frequency and 60% of the Full rated system deviation.
- 6) Up the amplitude by 20dB.
- 7) On DSA, get the reference point to 0dB.
- 8) Vary the frequency on audio analyzer from 3 kHz to 20 kHz, record the audio tone from DSA.

### 6.4.2. Test Result

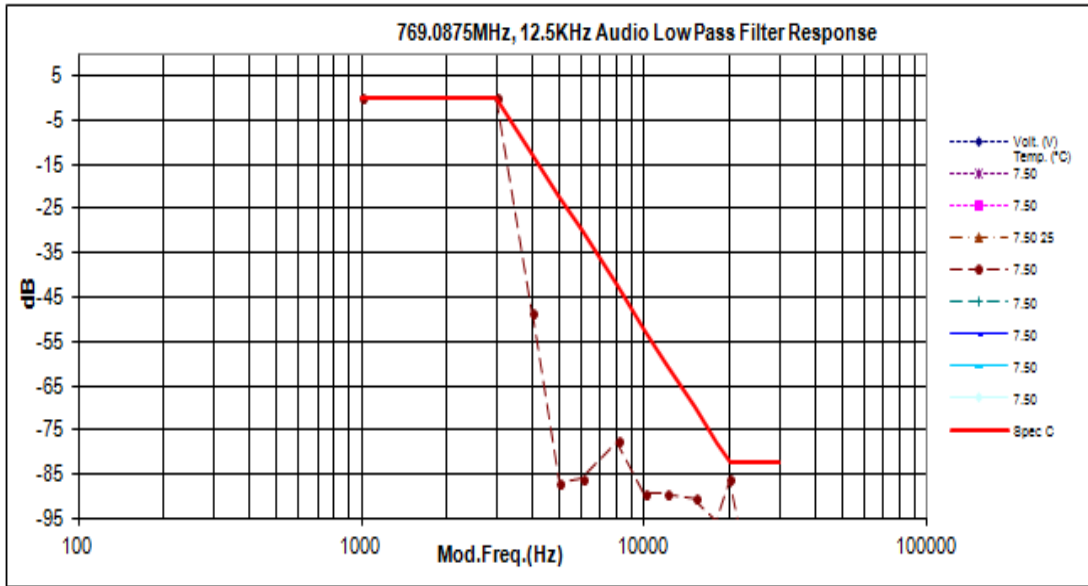

### 6.4.3. Test Limit

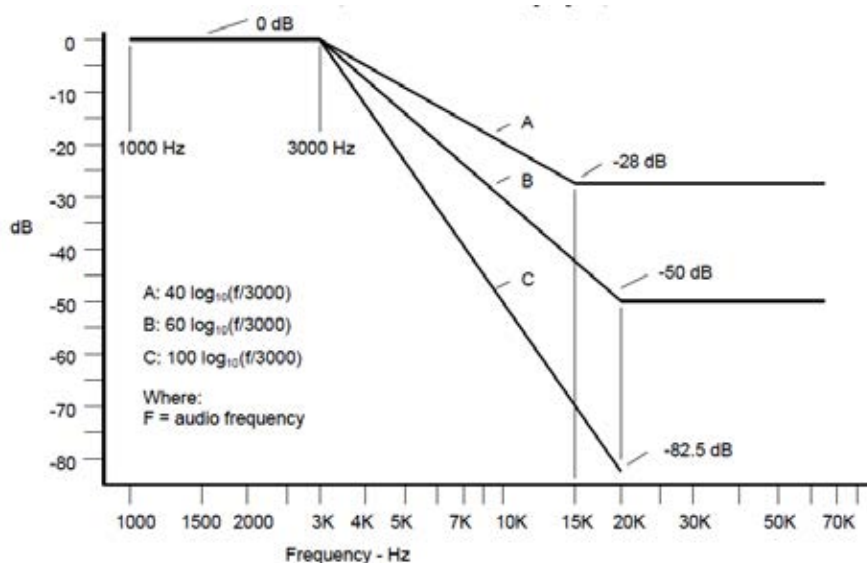

For audio frequencies above 3000 Hz, the audio response of the post limiter low-pass filter shall meet or exceed the following requirements:

- a) For equipment operating on 20, 25 or 30 kHz channel bandwidth in the 25 MHz to 174 MHz range:

At frequencies from 3000 Hz through 15,000 Hz the attenuation shall be greater than the attenuation at 1000 Hz by at least:  $40 \log_{10}(f / 3000)$  dB

where:  $f$  is the audio frequency in Hz.

At frequencies above 15,000 Hz, the attenuation shall be greater than the attenuation at 1000 Hz, by at least: 28 dB.

- b) For equipment operating with 25 kHz bandwidth channels between 406 and 512 MHz through 896 MHz, and between 929 MHz through 930 MHz:

At frequencies from 3000 Hz through 20,000 Hz, the attenuation shall be greater than the attenuation at 1000 Hz by at least:  $60 \log_{10}(f / 3000)$  dB

where:  $f$  is the audio frequency in Hz.

At frequencies above 20,000 Hz the attenuation shall be greater than the attenuation at 1000 Hz by at least: 50 dB.

- c) For equipment operating on channels between 896 MHz through 901 MHz, between 935 MHz through 940 MHz, and 12.5 or 15 kHz spaced channels in the frequency range 138-174 MHz and 406-512 MHz.

At frequencies from 3000 Hz through 20,000 Hz the attenuation shall be greater than the attenuation at 1000 Hz by at least:  $100 \log_{10}(f / 3000)$  dB

where:  $f$  is the audio frequency in Hz.

## 6.5. Modulation Limiting

### 6.5.1. Test Setup

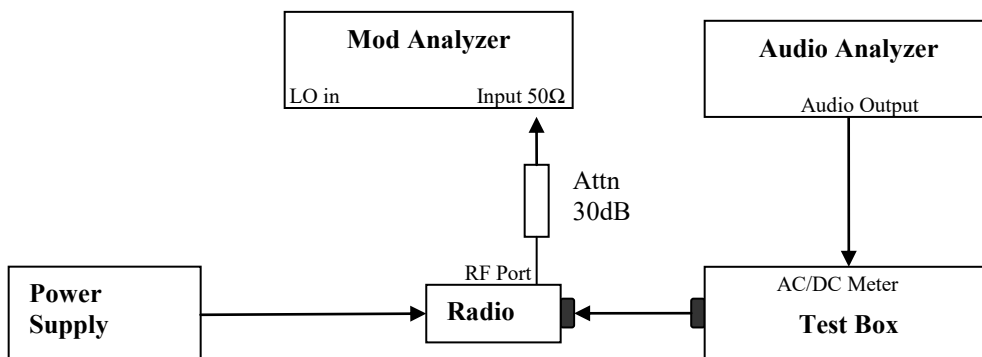

- 1) The DUT transmitter output port was connected to Modulation Analyzer.
- 2) Path loss for the measurement included.
- 3) Set the audio bandwidth filter to 15 kHz.
- 4) Transmit the radio and set the audio analyzer to 1 kHz audio frequency and 60% of the Full rated system deviation.
- 5) Record the frequency deviation as 0dB input level at 1kHz audio frequency.
- 6) Repeat the step and record the frequency deviation from -20 dB to 20dB by 5 dB increments and different audio freq 300 Hz, 2.5 kHz and 3 kHz.

### 6.5.2. Test Result

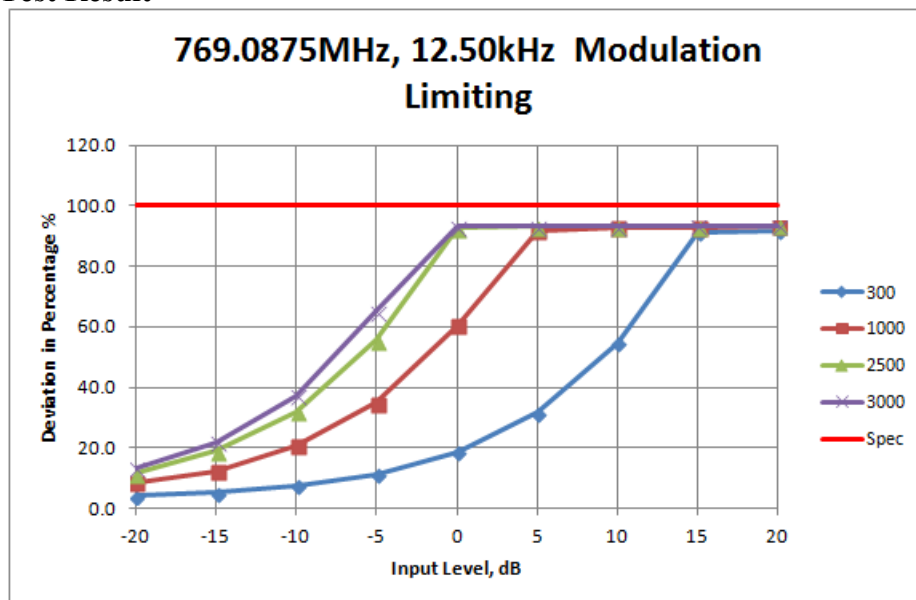

### 6.5.3. Test Limit

Modulation Limiting shall not exceed 100 percent.

## 6.6. Occupied Bandwidth

### 6.6.1. Test Setup (Analog)

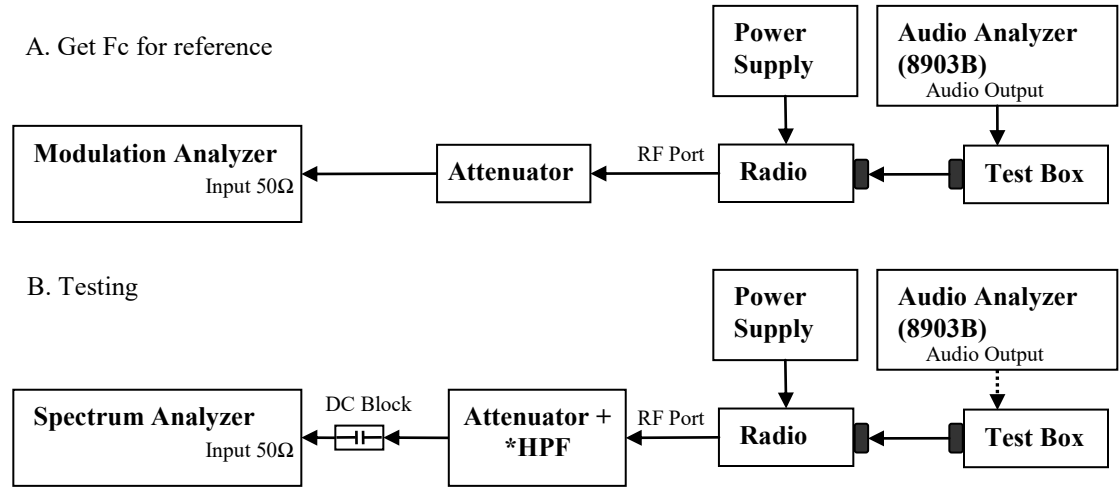

- 1) The DUT transmitter output port was connected to Modulation Analyzer.
- 2) Set the audio bandwidth filter to 15 kHz low pass filter and 50 kHz high pass filter.
- 3) Transmit the radio and set the audio analyzer to 2.5 kHz audio frequency and 50% of the rated deviation. Up the amplitude by 16 dB. Dekey the DUT.
- 4) Path loss for the measurement included.
- 5) Select the Occupied Bandwidth measurement for 99% Emissions Bandwidth Measurement.
- 6) Key in the Fc and Resolution Bandwidth (1 ~ 5 % of emission designator).
- 7) Transmit the DUT and record the occupied Bandwidth frequency.
- 8) Preset the spectrum analyzer for sideband spectrum measurement.
- 9) Set the span and Resolution Bandwidth (according to FCC/ ISED standard).
- 10) Save the screen shot as modulated signal
- 11) Remove the audio tone from audio analyzer to capture unmodulated signal.

\* Only HPF added for Mask 80.211 measurement with attenuator.

### 6.6.2. Test Result (Analog) NA → Not Applicable

### 6.6.3. Test Setup (Digital)

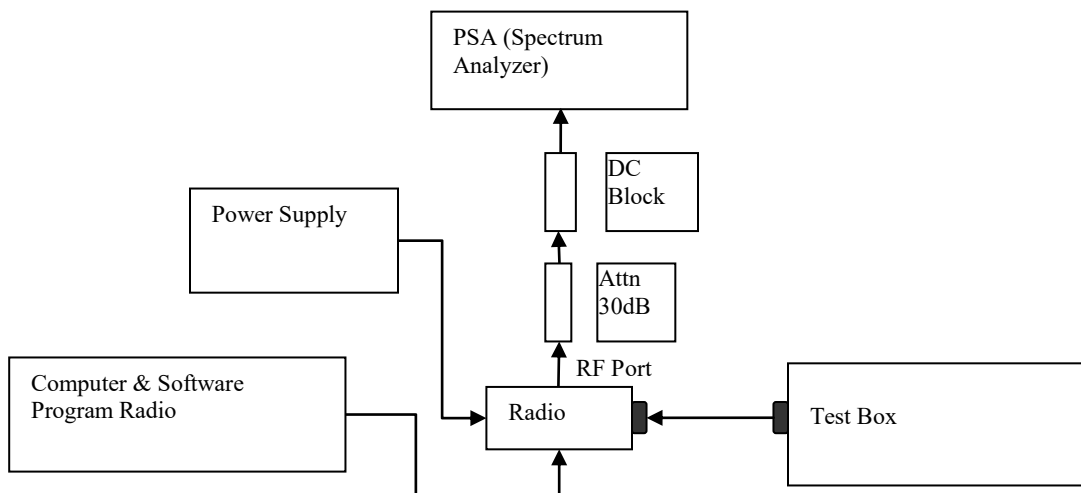

- 1) Program and set radio to operate in desire test frequency and digital mode with modulation. (\*4FSK, C4FM or other digital modulation form).
- 2) Path loss for the measurement included.
- 3) Select the Occupied Bandwidth measurement for 99% Emissions Bandwidth Measurement.
- 4) Key in the Fc and Resolution Bandwidth (1 ~ 5 % of emission designator).
- 5) Transmit the DUT and record the occupied Bandwidth frequency.
- 6) Preset the spectrum analyzer for modulation emission spectrum measurement.
- 7) Set the span and Resolution Bandwidth (according to FCC/ ISED standard).
- 8) Capture the screen shot as modulated signal.

\*Note:

- For Digital Modulation, 12.5 kHz Data F1D & FXD would be the same. Therefore only measurements with F1D modulation shown below.
- For Digital Modulation, 12.5 kHz Data F1E & FXE would be the same. Therefore only measurements with F1E modulation shown below.

### 6.6.4. Test Result (Digital)

**NA → Not Applicable**

### 6.7. Test Limit

The 99% occupied bandwidth is the width of a frequency band such that, below the lower and above the upper frequency limits, the mean powers emitted are each equal to a specified percentage 0.5% of the total mean transmitted power.

## 6.8. Band Edge Conducted Spurious Emission (Part 22)

### 6.8.1. Test Setup (Analog)

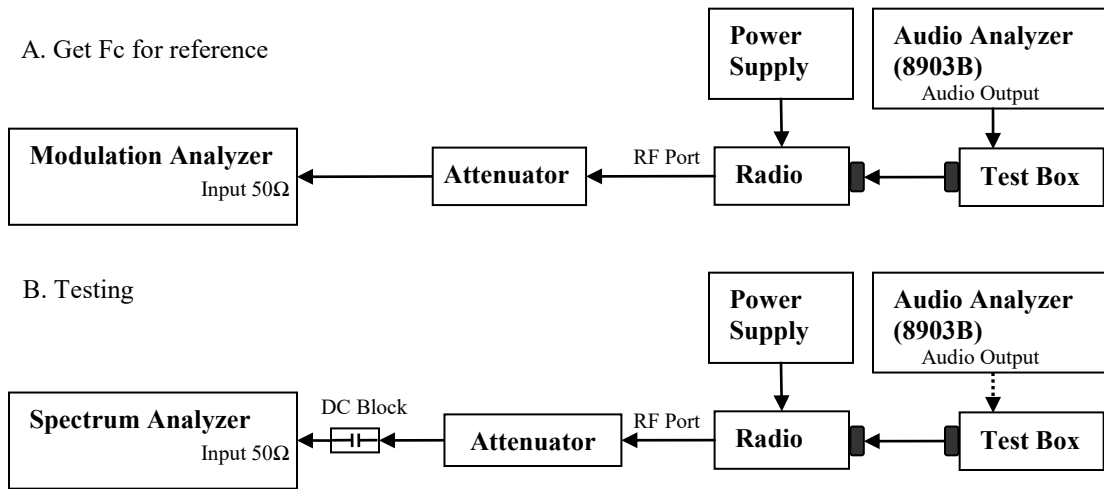

- 1) The DUT transmitter output port was connected to Modulation Analyzer.
- 2) Set the audio bandwidth filter to 15 kHz low pass filter and 50 kHz high pass filter.
- 3) Transmit the radio and set the audio analyzer to 2.5 kHz audio frequency and 50% of the rated deviation. Up the amplitude by 16 dB. Dekey the DUT.
- 4) Path loss for the measurement included.
- 5) Select the Occupied Bandwidth measurement for 99% and 26dB Emissions Bandwidth Measurement.
- 6) Key in the Fc and Resolution Bandwidth.
- 7) Transmit the DUT and record the occupied Bandwidth frequencies.
- 8) Preset the spectrum analyzer for band edge measurement.
- 9) The band edges of lowest and highest channels were measured.
- 10) Key in the Lowest and highest channel frequency, span is 60 kHz and Resolution Bandwidth is at least 1% of Emission Bandwidth.
- 11) Save the screen shot as modulated signal.
- 12) Remove the audio tone from audio analyzer to capture unmodulated signal.

\*Note:

- For emission designator ending with F3E, 16K0F3E is the worst case and therefore only 16K0F3E will be shown.

### 6.8.2. Test Result (Analog)

NA → Not Applicable

### 6.8.3. Test Setup (Digital)

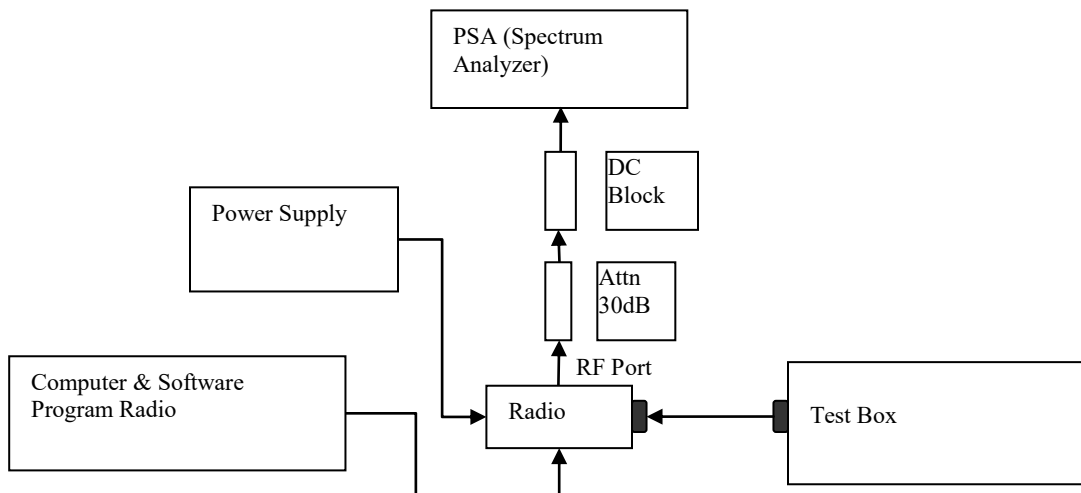

- 1) Program and set radio to operate in desire test frequency and digital mode with modulation. (\*4FSK, C4FM or other digital modulation form).
- 2) Path loss for the measurement included.
- 3) Select the Occupied Bandwidth measurement for 99% and 26dB Emissions Bandwidth Measurement.
- 4) Key in the Fc and Resolution Bandwidth.
- 5) Transmit radio record the occupied Bandwidth frequencies.
- 6) Preset the spectrum analyzer for band edge measurement.
- 7) Key in the lowest and highest channels frequency, span is 60 kHz and Resolution Bandwidth is at least 1% of Emission Bandwidth.
- 8) Save the screen shot.

\*Note:

- All digital modulation modes utilize the same high deviation test pattern, and they are therefore identical. Hence, only FID plots will be shown.

### 6.8.4. Test Result (Digital)

**NA → Not Applicable**

### 6.9. Test Limit

The power of any emission outside of the authorized operating frequency ranges must be attenuated below the transmitting power (P) by a factor of at least  $43 + 10 \log(P)$  dB.



## 6.10. Transient Frequency Behavior

### 6.10.1. Test Setup

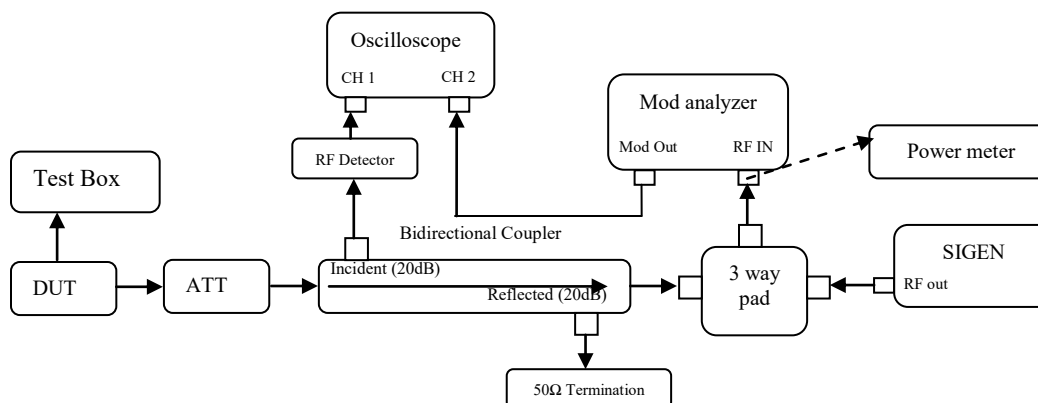

- 1) Connect the setup as figure above.
- 2) Path loss for the measurement included.
- 3) Set on Sigen with the assigned center frequency, internal 1 kHz FM tone.  
 FM Deviation: Analog 25kHz Channel Spacing = 25 kHz  
 Analog 12.5 kHz Channel Spacing = 12.5 kHz  
 C4FM = 12.5 kHz
- 4) Turn on 50 kHz high pass filter and 15 kHz low pass filter on modulation analyzer.
- 5) Supply sufficient attenuation ATT to provide the output power of  $\leq -11$  dBm into power meter when DUT is keying up.
- 6) Note the power level on power meter and dekey the DUT.
- 7) Adjust the amplitude of the signal generator to the level power meter, maintained the amplitude throughout the rest of the measurement.
- 8) Connect the output to modulation analyzer.
- 9) Reduce 30dB attenuation and transmit the radio to get the trigger line.
- 10) Capture the screen shot for key-up (rising edge) and de-key (falling edge) mode.

### 6.10.2. Test Result NA → Not Applicable

### 6.10.3. Test Limit

Transmitters designed to operate in the 150-174 MHz and 421-512 MHz frequency bands must maintain transient frequencies within the maximum frequency difference limits during the time intervals indicated:

Time intervals <sup>1 2</sup>	Maximum frequency difference <sup>3</sup>	All equipment	
		150 to 174 MHz	421 to 512 MHz
Transient Frequency Behavior for Equipment Designed to Operate on 25 kHz Channels			
t <sub>1</sub> <sup>4</sup>	±25.0 kHz	5.0 ms	10.0 ms
t <sub>2</sub>	±12.5 kHz	20.0 ms	25.0 ms

$t_3^4$	$\pm 25.0$ kHz	5.0 ms	10.0 ms
Transient Frequency Behavior for Equipment Designed to Operate on 12.5 kHz Channels			
$t_1^4$	$\pm 12.5$ kHz	5.0 ms	10.0 ms
$t_2$	$\pm 6.25$ kHz	20.0 ms	25.0 ms
$t_3^4$	$\pm 12.5$ kHz	5.0 ms	10.0 ms
Transient Frequency Behavior for Equipment Designed to Operate on 6.25 kHz Channels			
$t_1^4$	$\pm 6.25$ kHz	5.0 ms	10.0 ms
$t_2$	$\pm 3.125$ kHz	20.0 ms	25.0 ms
$t_3^4$	$\pm 6.25$ kHz	5.0 ms	10.0 ms

<sup>1</sup>  $t_{on}$  is the instant when a 1 kHz test signal is completely suppressed, including any capture time due to phasing.

$t_1$  is the time period immediately following  $t_{on}$ .

$t_2$  is the time period immediately following  $t_1$ .

$t_3$  is the time period from the instant when the transmitter is turned off until  $t_{off}$ .

$t_{off}$  is the instant when the 1 kHz test signal starts to rise.

<sup>2</sup> During the time from the end of  $t_2$  to the beginning of  $t_3$ , the frequency difference must not exceed the limits specified in §90.213.

<sup>3</sup> Difference between the actual transmitter frequency and the assigned transmitter frequency.

<sup>4</sup> If the transmitter carrier output power rating is 6 watts or less, the frequency difference during this time period may exceed the maximum frequency difference for this time period.

## 6.11. Adjacent Channel Power

### 6.11.1. Test Setup (Analog)

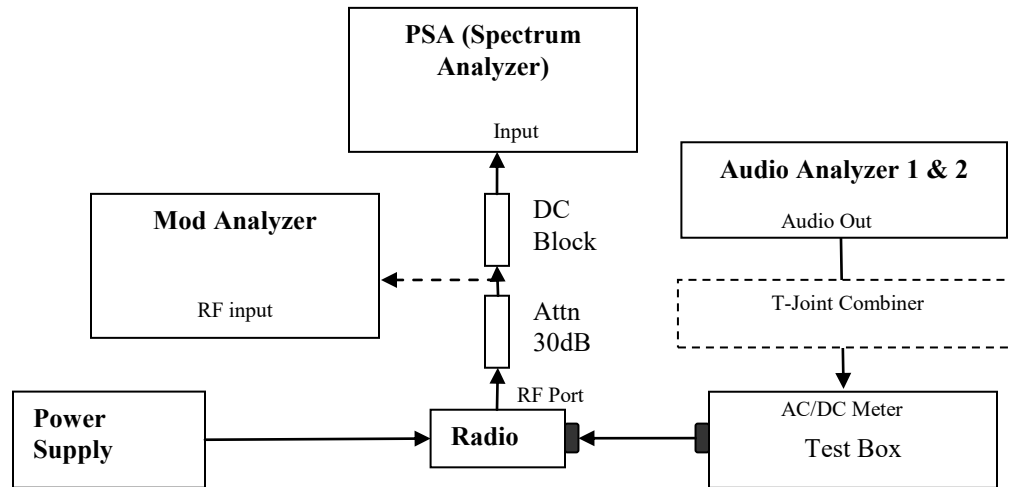

- 1) The DUT transmitter output port was connected to modulation analyzer.
- 2) Transmit the radio and turn on 1<sup>st</sup> audio analyzer with audio frequency 650Hz, 50% rated deviation, and record the amplitude value as AmpT1.
- 3) Turn off Audio analyzer 1 and turn on audio analyzer 2, set the audio frequency to 2.2 kHz and 50% deviation. Record the amplitude as AmpT2.
- 4) Turn both audio analyzers ON and up 10dB amplitude level.
- 5) Connect the output to PSA and set to assigned center frequency.
- 6) Set Span, Resolution Bandwidth and Video Bandwidth per rules part.
- 7) Transmit the radio and record the Adjacent Channel Power value in dBc.

**6.11.2. Test Result**

Mode	Analog			
Frequency, MHz	769.0875			
Channel Spacing, kHz	12.5			
Offset (kHz)	Meas BW (kHz)	Lower	Upper	Spec (dB)
9.375	6.25	-71.298	-70.868	-40
15.625	6.25	-75.458	-75.377	-60
21.875	6.25	-76.541	-76.438	-60
37.500	25	-72.828	-72.428	-65
62.500	25	-74.114	-74.190	-65
87.500	25	-76.074	-76.352	-65
150.000	100	-74.093	-73.996	-65
250.000	100	-79.584	-79.394	-65
350.000	100	-82.409	-82.368	-65
400k	30	-88.330	-88.083	-75
12M	30	-90.436	-90.742	-75

Mode	Analog			
Frequency, MHz	774.8875			
Channel Spacing, kHz	12.5			
Offset (kHz)	Meas BW (kHz)	Lower	Upper	Spec (dB)
9.375	6.25	-71.035	-71.000	-40
15.625	6.25	-76.043	-76.006	-60
21.875	6.25	-76.815	-76.886	-60
37.500	25	-72.254	-72.364	-65
62.500	25	-74.415	-74.253	-65
87.500	25	-76.591	-76.526	-65
150.000	100	-74.445	-74.468	-65
250.000	100	-79.627	-79.545	-65
350.000	100	-82.248	-82.420	-65
400k	30	-87.816	-88.751	-75
12M	30	-90.283	-90.584	-75

Mode	Analog			
Frequency, MHz	799.0875			
Channel Spacing, kHz	12.5			
Offset (kHz)	Meas BW (kHz)	Lower	Upper	Spec (dB)
9.375	6.25	-69.967	-70.774	-40
15.625	6.25	-74.983	-75.839	-60
21.875	6.25	-76.343	-76.358	-60
37.500	25	-72.356	-72.097	-65
62.500	25	-74.425	-74.676	-65
87.500	25	-76.820	-76.838	-65
150.000	100	-74.636	-74.898	-65
250.000	100	-79.956	-80.092	-65
350.000	100	-82.850	-82.885	-65
400k	30	-88.012	-89.084	-75
12M	30	-90.748	-90.103	-75

Mode	Analog			
Frequency, MHz	804.9125			
Channel Spacing, kHz	12.5			
Offset (kHz)	Meas BW (kHz)	Lower	Upper	Spec (dB)
9.375	6.25	-69.420	-70.145	-40
15.625	6.25	-75.410	-75.088	-60
21.875	6.25	-76.848	-76.659	-60
37.500	25	-72.617	-72.266	-65
62.500	25	-74.389	-74.432	-65
87.500	25	-76.910	-76.951	-65
150.000	100	-74.581	-74.836	-65
250.000	100	-79.798	-79.999	-65
350.000	100	-82.453	-82.670	-65
400k	30	-88.583	-88.494	-75
12M	30	-90.061	-89.799	-75

### 6.11.3. Test Setup (Digital)

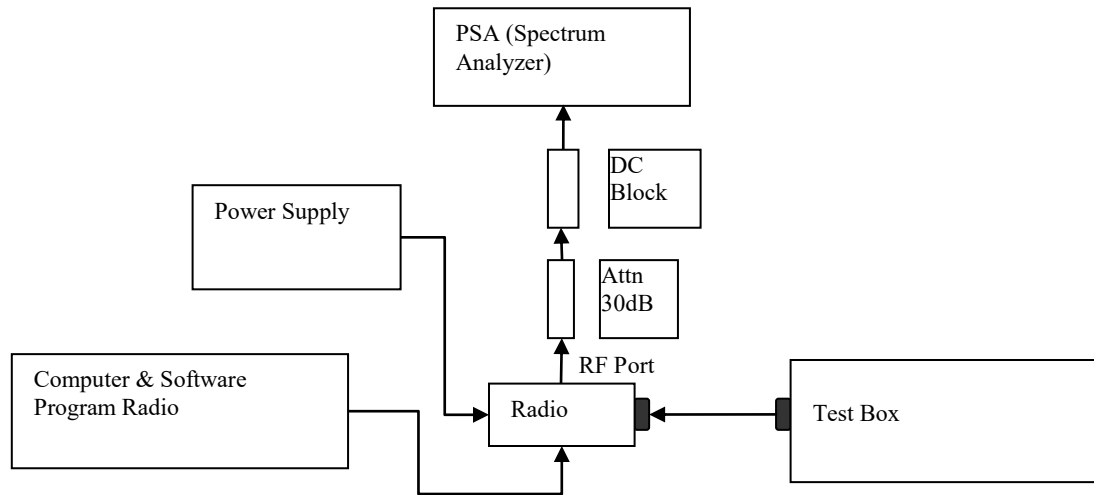

- 1) Program and set radio to operate in desire test frequency and digital mode with modulation. (4FSK, C4FM or other digital modulation form).
- 2) Prepare setup as per picture.
- 3) Turn on the ACP Measurement – Press Measure, ACP.
- 4) Set Span, Resolution Bandwidth and Video Bandwidth as per rules part.
- 5) Transmit the radio and record the Adjacent Channel Power value in dBc.

**6.11.4. Test Result**

Mode	Digital Data			
Frequency, MHz	769.0875			
Channel Spacing, kHz	12.5			
Offset (kHz)	Meas BW (kHz)	Lower	Upper	Spec (dB)
9.375	6.25	-41.510	-40.475	-40
15.625	6.25	-75.479	-75.357	-60
21.875	6.25	-77.031	-76.723	-60
37.500	25	-72.499	-72.498	-65
62.500	25	-74.049	-74.371	-65
87.500	25	-76.514	-76.557	-65
150.000	100	-74.281	-74.437	-65
250.000	100	-79.548	-79.660	-65
350.000	100	-82.395	-82.476	-65
400k	30	-88.164	-87.976	-75
12M	30	-89.884	-90.397	-75

Mode	Digital Data			
Frequency, MHz	774.8875			
Channel Spacing, kHz	12.5			
Offset (kHz)	Meas BW (kHz)	Lower	Upper	Spec (dB)
9.375	6.25	-41.636	-42.961	-40
15.625	6.25	-76.101	-75.207	-60
21.875	6.25	-76.240	-76.911	-60
37.500	25	-72.260	-72.533	-65
62.500	25	-74.598	-74.380	-65
87.500	25	-76.990	-76.608	-65
150.000	100	-74.432	-74.430	-65
250.000	100	-79.593	-79.687	-65
350.000	100	-82.372	-82.198	-65
400k	30	-88.371	-88.352	-75
12M	30	-89.853	-90.364	-75

Mode	Digital Data			
Frequency, MHz	799.0875			
Channel Spacing, kHz	12.5			
Offset (kHz)	Meas BW (kHz)	Lower	Upper	Spec (dB)
9.375	6.25	-41.775	-42.916	-40
15.625	6.25	-75.267	-75.361	-60
21.875	6.25	-76.840	-76.563	-60
37.500	25	-72.295	-72.460	-65
62.500	25	-74.484	-74.805	-65
87.500	25	-76.557	-77.148	-65
150.000	100	-74.928	-74.907	-65
250.000	100	-80.068	-79.947	-65
350.000	100	-82.799	-82.762	-65
400k	30	-88.747	-88.832	-75
12M	30	-90.695	-89.972	-75

Mode	Digital Data			
Frequency, MHz	804.9125			
Channel Spacing, kHz	12.5			
Offset (kHz)	Meas BW (kHz)	Lower	Upper	Spec (dB)
9.375	6.25	-41.649	-43.485	-40
15.625	6.25	-74.907	-75.277	-60
21.875	6.25	-75.980	-76.079	-60
37.500	25	-72.290	-72.368	-65
62.500	25	-74.165	-74.367	-65
87.500	25	-76.890	-77.061	-65
150.000	100	-74.718	-74.686	-65
250.000	100	-79.805	-79.851	-65
350.000	100	-82.559	-82.460	-65
400k	30	-88.413	-88.865	-75
12M	30	-89.900	-89.459	-75



Mode	Digital Voice			
Frequency, MHz	769.0875			
Channel Spacing, kHz	12.5			
Offset (kHz)	Meas BW (kHz)	Lower	Upper	Spec (dB)
9.375	6.25	-54.109	-43.747	-40
15.625	6.25	-75.764	-75.586	-60
21.875	6.25	-76.255	-75.909	-60
37.500	25	-72.614	-72.629	-65
62.500	25	-74.111	-74.447	-65
87.500	25	-76.530	-76.550	-65
150.000	100	-74.266	-74.629	-65
250.000	100	-79.580	-79.545	-65
350.000	100	-82.365	-82.417	-65
400k	30	-88.727	-88.692	-75
12M	30	-90.803	-90.479	-75

Mode	Digital Voice			
Frequency, MHz	774.8875			
Channel Spacing, kHz	12.5			
Offset (kHz)	Meas BW (kHz)	Lower	Upper	Spec (dB)
9.375	6.25	-48.553	-47.663	-40
15.625	6.25	-75.436	-75.335	-60
21.875	6.25	-76.688	-76.270	-60
37.500	25	-72.363	-72.171	-65
62.500	25	-74.454	-74.316	-65
87.500	25	-76.597	-76.480	-65
150.000	100	-74.524	-74.654	-65
250.000	100	-79.664	-79.504	-65
350.000	100	-82.334	-82.269	-65
400k	30	-88.033	-88.622	-75
12M	30	-90.091	-90.414	-75

Mode	Digital Voice			
Frequency, MHz	799.0875			
Channel Spacing, kHz	12.5			
Offset (kHz)	Meas BW (kHz)	Lower	Upper	Spec (dB)
9.375	6.25	-44.225	-42.681	-40
15.625	6.25	-74.943	-75.097	-60
21.875	6.25	-76.044	-75.585	-60
37.500	25	-72.362	-72.377	-65
62.500	25	-74.612	-74.809	-65
87.500	25	-77.247	-77.175	-65
150.000	100	-75.016	-74.929	-65
250.000	100	-80.196	-80.257	-65
350.000	100	-82.885	-82.882	-65
400k	30	-88.846	-89.013	-75
12M	30	-90.785	-90.327	-75

Mode	Digital Voice			
Frequency, MHz	804.9125			
Channel Spacing, kHz	12.5			
Offset (kHz)	Meas BW (kHz)	Lower	Upper	Spec (dB)
9.375	6.25	-41.853	-44.176	-40
15.625	6.25	-74.641	-74.840	-60
21.875	6.25	-75.966	-75.783	-60
37.500	25	-72.315	-72.567	-65
62.500	25	-74.470	-74.747	-65
87.500	25	-76.927	-76.725	-65
150.000	100	-74.836	-74.604	-65
250.000	100	-79.543	-79.702	-65
350.000	100	-82.308	-82.326	-65
400k	30	-87.816	-88.057	-75
12M	30	-90.041	-89.696	-75

Mode	Phase II			
Frequency, MHz	769.0875			
Channel Spacing, kHz	12.5			
Offset (kHz)	Meas BW (kHz)	Lower	Upper	Spec (dB)
9.375	6.25	-51.079	-53.017	-40
15.625	6.25	-78.114	-75.681	-60
21.875	6.25	-81.846	-84.571	-60
37.500	25	-75.310	-75.554	-65
62.500	25	-77.367	-77.245	-65
87.500	25	-79.322	-79.363	-65
150.000	100	-77.245	-76.947	-65
250.000	100	-81.851	-81.932	-65
350.000	100	-84.124	-84.139	-65
400k	30	-89.343	-90.188	-75
12M	30	-89.572	-89.733	-75

Mode	Phase II			
Frequency, MHz	774.8875			
Channel Spacing, kHz	12.5			
Offset (kHz)	Meas BW (kHz)	Lower	Upper	Spec (dB)
9.375	6.25	-45.154	-49.627	-40
15.625	6.25	-79.186	-76.099	-60
21.875	6.25	-78.929	-82.682	-60
37.500	25	-75.305	-75.488	-65
62.500	25	-77.247	-77.606	-65
87.500	25	-79.548	-79.363	-65
150.000	100	-76.852	-77.127	-65
250.000	100	-81.802	-81.667	-65
350.000	100	-83.946	-83.848	-65
400k	30	-89.936	-89.408	-75
12M	30	-89.972	-89.776	-75

Mode	Phase II			
Frequency, MHz	799.0875			
Channel Spacing, kHz	12.5			
Offset (kHz)	Meas BW (kHz)	Lower	Upper	Spec (dB)
9.375	6.25	-42.125	-44.628	-40
15.625	6.25	-76.634	-75.891	-60
21.875	6.25	-81.943	-81.591	-60
37.500	25	-74.922	-74.973	-65
62.500	25	-77.106	-77.477	-65
87.500	25	-79.811	-79.449	-65
150.000	100	-77.409	-77.198	-65
250.000	100	-81.774	-81.835	-65
350.000	100	-83.981	-84.016	-65
400k	30	-89.762	-89.806	-75
12M	30	-90.105	-90.080	-75

Mode	Phase II			
Frequency, MHz	804.9125			
Channel Spacing, kHz	12.5			
Offset (kHz)	Meas BW (kHz)	Lower	Upper	Spec (dB)
9.375	6.25	-41.473	-44.848	-40
15.625	6.25	-76.873	-76.410	-60
21.875	6.25	-78.992	-79.816	-60
37.500	25	-74.286	-74.722	-65
62.500	25	-76.921	-76.693	-65
87.500	25	-78.936	-79.167	-65
150.000	100	-76.629	-76.724	-65
250.000	100	-81.406	-81.207	-65
350.000	100	-83.632	-83.367	-65
400k	30	-89.230	-89.602	-75
12M	30	-89.830	-89.467	-75

Mode	Digital Voice Encrytion			
Frequency, MHz	769.0875			
Channel Spacing, kHz	12.5			
Offset (kHz)	Meas BW (kHz)	Lower	Upper	Spec (dB)
9.375	6.25	-42.641	-43.134	-40
15.625	6.25	-75.251	-75.116	-60
21.875	6.25	-76.471	-76.752	-60
37.500	25	-72.580	-72.556	-65
62.500	25	-74.448	-74.215	-65
87.500	25	-76.540	-76.481	-65
150.000	100	-74.568	-74.744	-65
250.000	100	-79.609	-79.792	-65
350.000	100	-82.399	-82.357	-65
400k	30	-88.121	-88.961	-75
12M	30	-90.484	-90.675	-75

Mode	Digital Voice Encrytion			
Frequency, MHz	774.8875			
Channel Spacing, kHz	12.5			
Offset (kHz)	Meas BW (kHz)	Lower	Upper	Spec (dB)
9.375	6.25	-48.064	-49.866	-40
15.625	6.25	-75.436	-75.504	-60
21.875	6.25	-76.810	-76.086	-60
37.500	25	-72.428	-72.588	-65
62.500	25	-74.665	-74.683	-65
87.500	25	-76.613	-76.782	-65
150.000	100	-74.653	-74.691	-65
250.000	100	-79.784	-79.666	-65
350.000	100	-82.525	-82.588	-65
400k	30	-87.777	-88.146	-75
12M	30	-89.921	-89.964	-75

Mode	Digital Voice Encrytion			
Frequency, MHz	799.0875			
Channel Spacing, kHz	12.5			
Offset (kHz)	Meas BW (kHz)	Lower	Upper	Spec (dB)
9.375	6.25	-40.110	-41.351	-40
15.625	6.25	-74.733	-75.246	-60
21.875	6.25	-76.462	-76.437	-60
37.500	25	-72.445	-72.555	-65
62.500	25	-74.564	-74.381	-65
87.500	25	-77.045	-76.880	-65
150.000	100	-74.776	-75.145	-65
250.000	100	-80.254	-79.931	-65
350.000	100	-83.027	-82.854	-65
400k	30	-88.742	-89.269	-75
12M	30	-90.809	-90.036	-75

Mode	Digital Voice Encrytion			
Frequency, MHz	804.9125			
Channel Spacing, kHz	12.5			
Offset (kHz)	Meas BW (kHz)	Lower	Upper	Spec (dB)
9.375	6.25	-40.063	-42.517	-40
15.625	6.25	-75.449	-75.061	-60
21.875	6.25	-76.488	-76.756	-60
37.500	25	-72.170	-72.425	-65
62.500	25	-74.496	-74.722	-65
87.500	25	-76.961	-76.714	-65
150.000	100	-74.608	-74.720	-65
250.000	100	-79.679	-79.845	-65
350.000	100	-82.362	-82.601	-65
400k	30	-88.120	-88.062	-75
12M	30	-89.873	-89.352	-75

Test Limit

**12.5 kHz MOBILE TRANSMITTER ACP REQUIREMENTS**

Offset from center frequency (kHz)	Measurement bandwidth (kHz)	Maximum ACP relative (dBc)
9.375	6.25	-40
15.625	6.25	-60
21.875	6.25	-60
37.50	25.00	-60
62.50	25.00	-65
87.50	25.00	-65
150.00	100	-65
250.00	100	-65
350.00	100	-65
>400 to 12 MHz	30 (s)	-75
12 MHz to paired receive band	30 (s)	-75
In the paired receive band	30 (s)	-100

**25 kHz MOBILE TRANSMITTER ACP REQUIREMENTS**

Offset from center frequency (kHz)	Measurement bandwidth (kHz)	Maximum ACP relative (dBc)
15.625	6.25	-40
21.875	6.25	-60
37.50	25	-60
62.50	25	-65
87.50	25	-65
150.00	100	-65
250.00	100	-65
350.00	100	-65
>400 kHz to 12 MHz	30 (s)	-75
12 MHz to paired receive band	30 (s)	-75
In the paired receive band	30 (s)	-100

**12.5 kHz BASE TRANSMITTER ACP REQUIREMENTS**

Offset from center frequency (kHz)	Measurement bandwidth (kHz)	Maximum ACP (dBc)
9.375	6.25	-40
15.625	6.25	-60
21.875	6.25	-60
37.5	25	-60
62.5	25	-65
87.5	25	-65
150	100	-65
250	100	-65
350.00	100	-65
>400 kHz to 12 MHz	30 (s)	-80
12 MHz to paired receive band	30 (s)	-80
In the paired receive band	30 (s)	1-85

**25 kHz BASE TRANSMITTER ACP REQUIREMENTS**

Offset from center frequency (kHz)	Measurement bandwidth (kHz)	Maximum ACP (dBc)
15.625	6.25	-40
21.875	6.25	-60
37.5	25	-60
62.5	25	-65
87.5	25	-65
150	100	-65
250	100	-65
350	100.00	-65
>400 kHz to 12 MHz	30 (s)	-80
12 MHz to paired receive band	30 (s)	-80
In the paired receive band	30 (s)	1-85



## 6.12. Conducted Spurious Emission

### 6.12.1. Test Setup

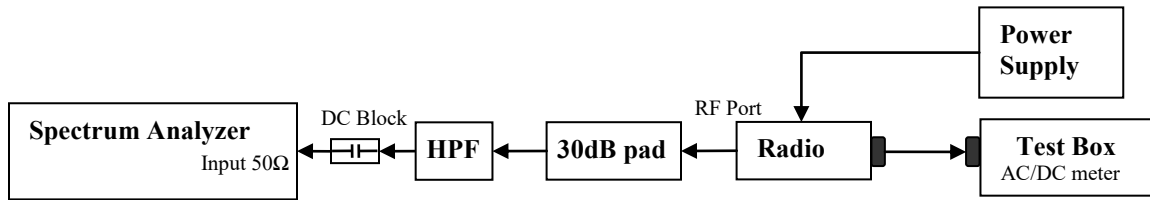

- 1) The DUT transmitter output port was connected to Spectrum Analyzer with above setup.
- 2) Program and set radio to operate in desire test frequency and mode. (Analog / digital modulation form).
- 3) Path loss for the measurement included.
- 4) Set the PSA Resolution Bandwidth as per rules part.
- 5) Set the Ref offset from the pathloss offset calibration file.
- 6) Adjust the center frequency of the spectrum analyzer for incremental coverage of the range from:
  - a. 9 KHz to  $F_c - \text{Test Bandwidth}$
  - b.  $F_c + \text{Test Bandwidth}$  to  $2F_c - 5\text{MHz}$ .
- 7) Key up the DUT, Peak Search the highest Spur and record the levels of spurious emissions
- 8) Dekey the DUT.
- 9) Turn On High Pass Filter path and Key up the DUT.
- 10) Adjust the PSA Freq for incremental coverage of range from  $2F_c$  to  $10F_c$
- 11) Key up the DUT and record the highest spur levels of spurious emissions.

### 6.12.2. Test Result (Analog)

#### Analog: 762.0125 MHz, 12.5kHz Channel Spacing, Max Power (Not For FCC Review)

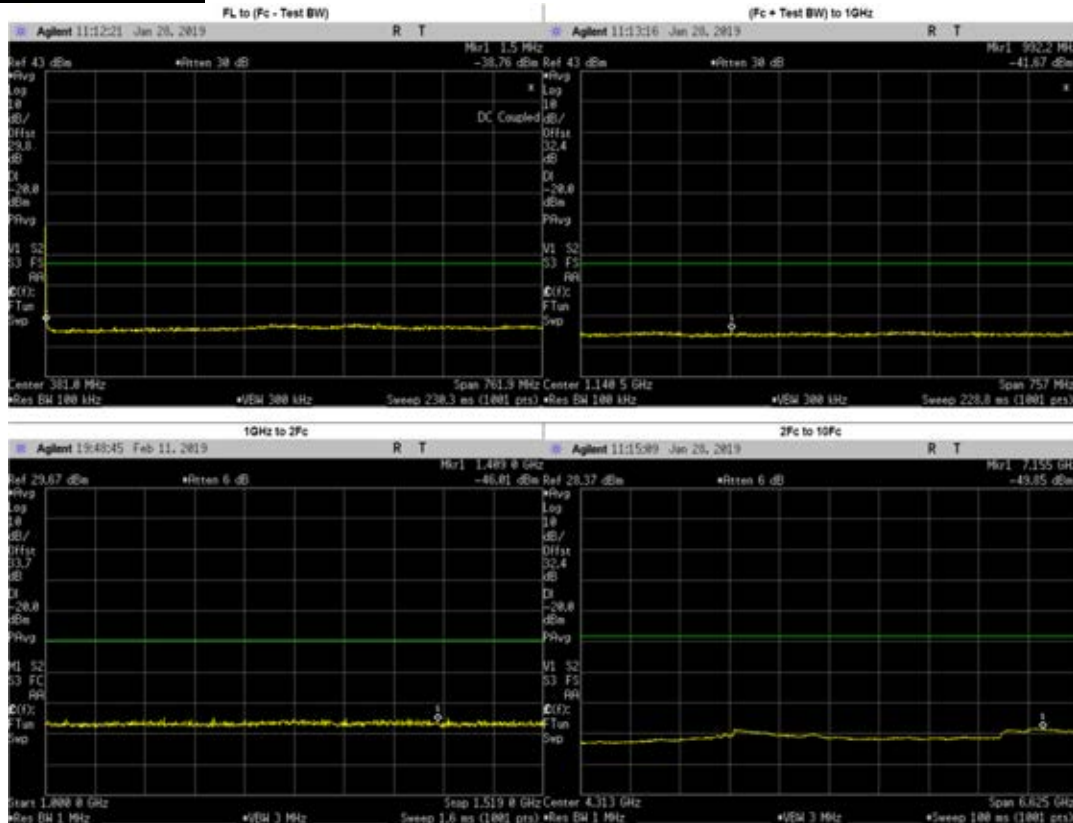

Frequency Range	Highest Spur Frequency (MHz)	Spurious Level (MHz)	Failing Limit (dBm)	Results
FL to (Fc - Test BW)	1.500	-38.76	-20	PASS
(Fc + Test BW) to 1GHz	992.1830	-41.67	-20	PASS
1GHz to 2Fc	1409.0000	-46.01	-20	PASS
2Fc to 10Fc	7154.7410	-49.85	-20	PASS
	1524.0250	-54.56	-20	PASS
	2286.0370	-53.84	-20	PASS
	3048.0500	-50.50	-20	PASS
	3810.0620	-52.43	-20	PASS
	4572.0750	-53.12	-20	PASS
	5334.0870	-53.15	-20	PASS
	6096.1000	-53.01	-20	PASS
	6858.1130	-51.07	-20	PASS
7620.1250	-51.22	-20	PASS	

**Analog: 769.0125 MHz, 12.5kHz Channel Spacing, Max Power**

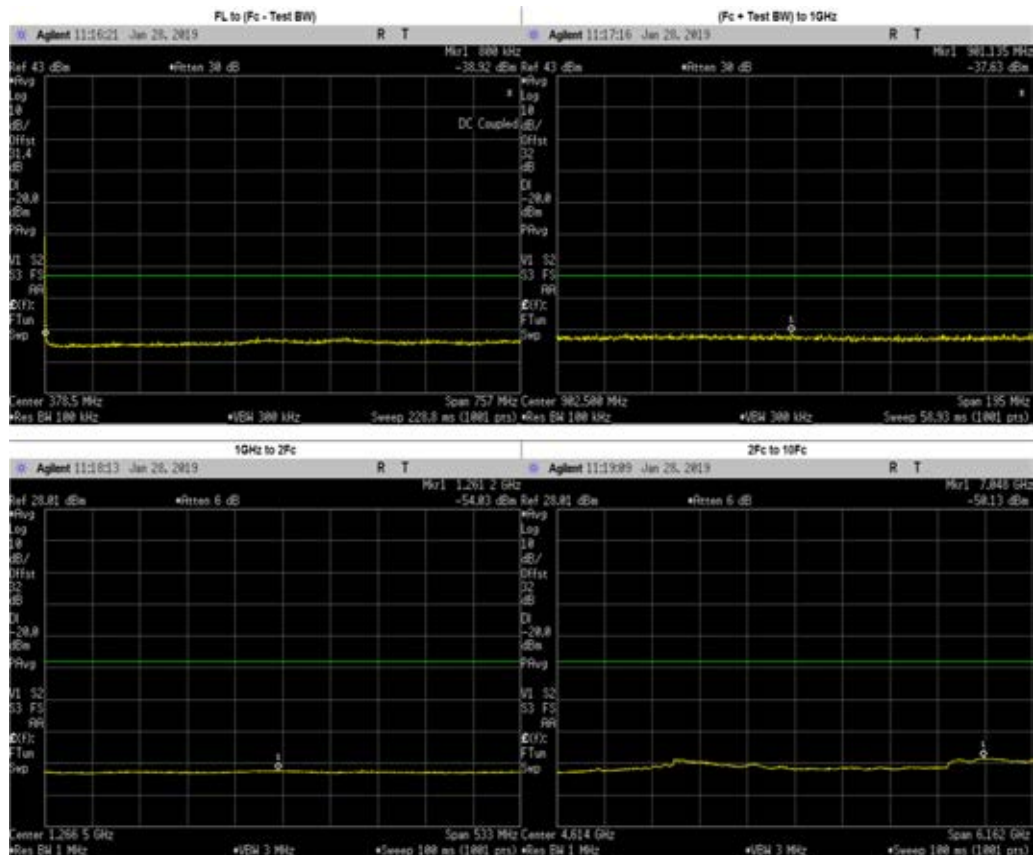

Frequency Range	Highest Spur Frequency (MHz)	Spurious Level (MHz)	Failing Limit (dBm)	Results
FL to (Fc - Test BW)	473.1284	-39.44	-20	PASS
(Fc + Test BW) to 1GHz	901.1350	-37.63	-20	PASS
1GHz to 2Fc	1261.1820	-54.03	-20	PASS
2Fc to 10Fc	7048.1050	-50.13	-20	PASS
	1538.0250	-54.88	-20	PASS
	2307.0370	-54.18	-20	PASS
	3076.0500	-50.95	-20	PASS
	3845.0620	-53.06	-20	PASS
	4614.0750	-53.80	-20	PASS
	5383.0870	-53.60	-20	PASS
	6152.1000	-53.35	-20	PASS
	6921.1130	-51.40	-20	PASS
7690.1250	-50.94	-20	PASS	

**Analog: 769.0875 MHz, 12.5kHz Channel Spacing, Max Power**

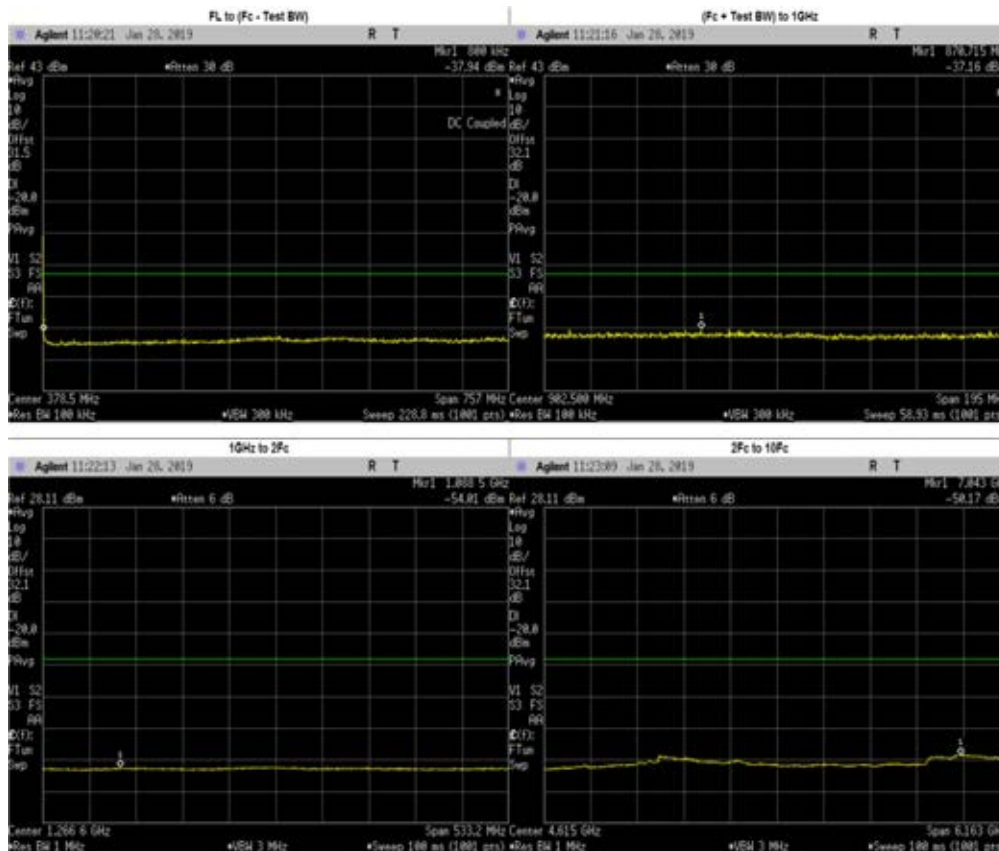

Frequency Range	Highest Spur Frequency (MHz)	Spurious Level (MHz)	Failing Limit (dBm)	Results
FL to (Fc - Test BW)	383.0464	-39.58	-20	PASS
(Fc + Test BW) to 1GHz	870.7150	-37.16	-20	PASS
1GHz to 2Fc	1088.5070	-54.01	-20	PASS
2Fc to 10Fc	7042.6290	-50.17	-20	PASS
	1538.1750	-54.53	-20	PASS
	2307.2620	-54.01	-20	PASS
	3076.3500	-50.88	-20	PASS
	3845.4370	-52.59	-20	PASS
	4614.5250	-53.47	-20	PASS
	5383.6130	-53.43	-20	PASS
	6152.7000	-53.15	-20	PASS
	6921.7880	-51.25	-20	PASS
	7690.8750	-50.75	-20	PASS

**Analog: 774.8875 MHz, 12.5kHz Channel Spacing, Max Power**

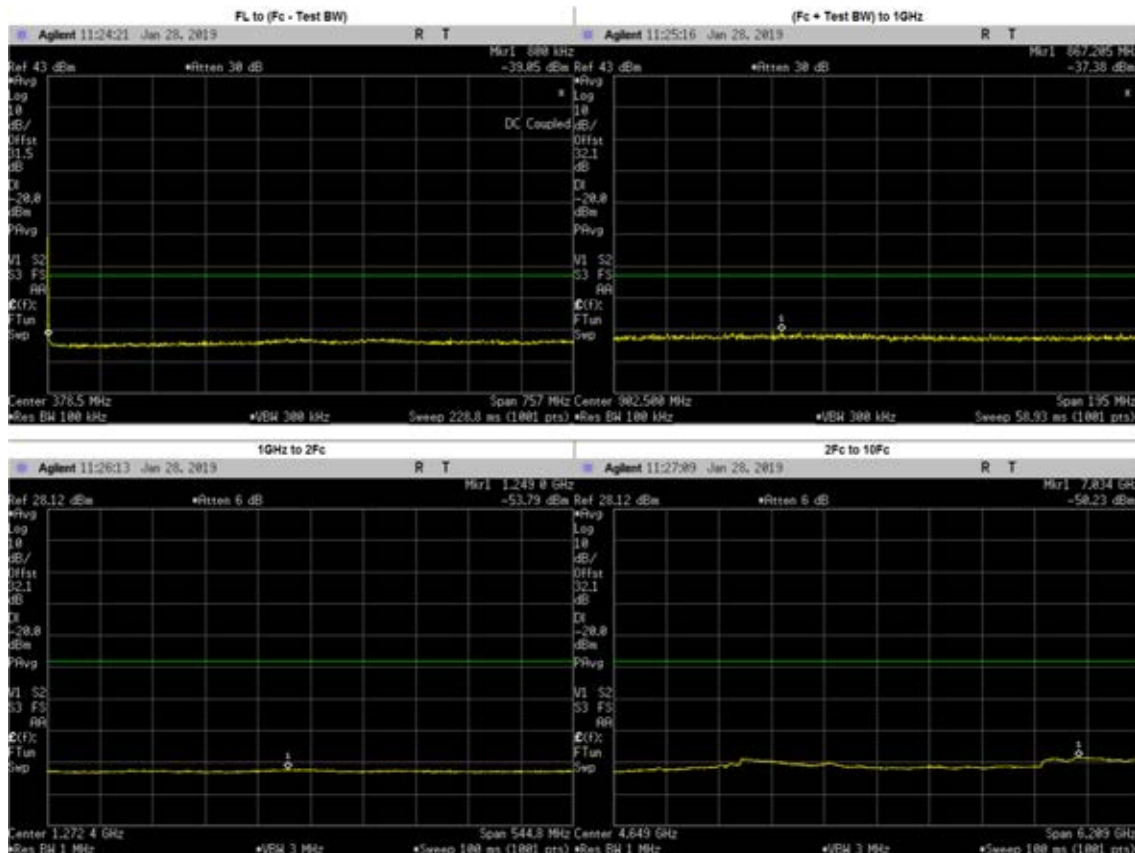

Frequency Range	Highest Spur Frequency (MHz)	Spurious Level (MHz)	Failing Limit (dBm)	Results
FL to (Fc - Test BW)	364.8787	-39.66	-20	PASS
(Fc + Test BW) to 1GHz	867.2050	-37.38	-20	PASS
1GHz to 2Fc	1248.9620	-53.79	-20	PASS
2Fc to 10Fc	7033.6190	-50.23	-20	PASS
	1549.7750	-54.67	-20	PASS
	2324.6620	-53.85	-20	PASS
	3099.5500	-50.77	-20	PASS
	3874.4370	-52.88	-20	PASS
	4649.3250	-53.43	-20	PASS
	5424.2120	-53.24	-20	PASS
	6199.1000	-53.27	-20	PASS
	6973.9880	-50.63	-20	PASS
7748.8750	-50.97	-20	PASS	

**Analog: 794.0125 MHz, 12.5kHz Channel Spacing, Max Power**  
**(Not For FCC Review)**

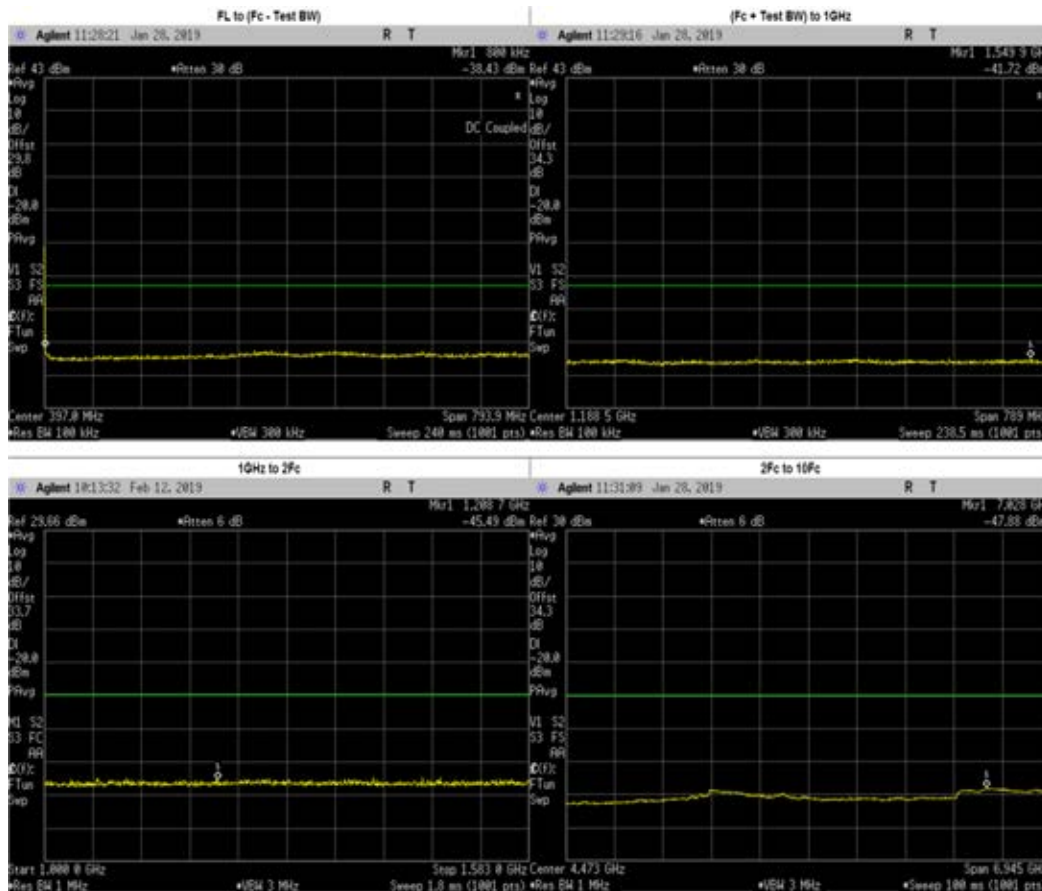

Frequency Range	Highest Spur Frequency (MHz)	Spurious Level (MHz)	Failing Limit (dBm)	Results
FL to (Fc - Test BW)	344.5824	-38.21	-20	PASS
(Fc + Test BW) to 1GHz	1549.8890	-41.72	-20	PASS
1GHz to 2Fc	1208.7000	-45.49	-20	PASS
2Fc to 10Fc	7028.3680	-47.88	-20	PASS
	1588.0250	-52.53	-20	PASS
	2382.0370	-51.84	-20	PASS
	3176.0500	-49.02	-20	PASS
	3970.0620	-50.63	-20	PASS
	4764.0750	-51.67	-20	PASS
	5558.0870	-51.56	-20	PASS
	6352.1000	-51.22	-20	PASS
	7146.1130	-48.41	-20	PASS
7940.1250	-48.98	-20	PASS	

**Analog: 799.0875 MHz, 25.0kHz Channel Spacing, Max Power**

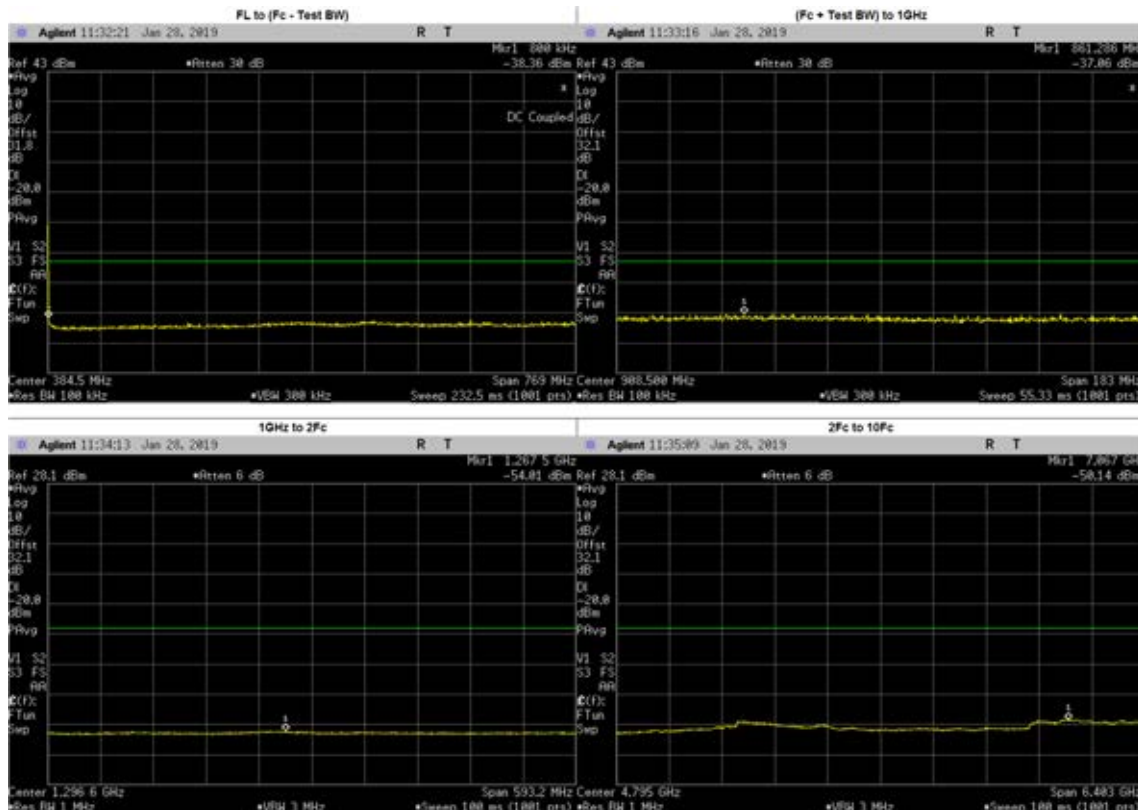

Frequency Range	Highest Spur Frequency (MHz)	Spurious Level (MHz)	Failing Limit (dBm)	Results
FL to (Fc - Test BW)	615.2018	-39.54	-20	PASS
(Fc + Test BW) to 1GHz	861.2860	-37.06	-20	PASS
1GHz to 2Fc	1267.5220	-54.01	-20	PASS
2Fc to 10Fc	7067.4840	-50.14	-20	PASS
	1598.1750	-54.70	-20	PASS
	2397.2620	-53.85	-20	PASS
	3196.3500	-51.19	-20	PASS
	3995.4370	-52.66	-20	PASS
	4794.5250	-53.73	-20	PASS
	5593.6130	-53.74	-20	PASS
	6392.7000	-53.23	-20	PASS
	7191.7880	-50.56	-20	PASS
7990.8750	-50.88	-20	PASS	

**Analog: 804.9125 MHz, 12.5kHz Channel Spacing, Max Power**

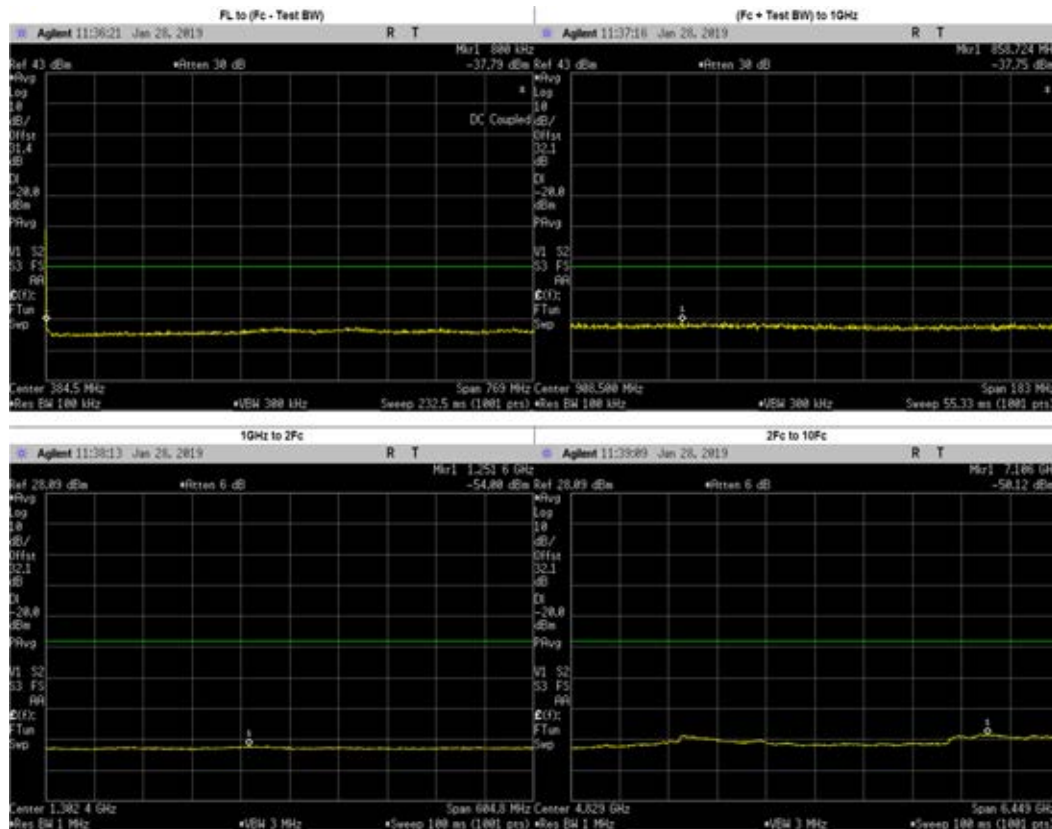

Frequency Range	Highest Spur Frequency (MHz)	Spurious Level (MHz)	Failing Limit (dBm)	Results
FL to (Fc - Test BW)	489.8563	-39.66	-20	PASS
(Fc + Test BW) to 1GHz	858.7240	-37.75	-20	PASS
1GHz to 2Fc	1251.6070	-54.00	-20	PASS
2Fc to 10Fc	7106.0780	-50.12	-20	PASS
	1609.8250	-54.75	-20	PASS
	2414.7380	-53.78	-20	PASS
	3219.6500	-51.16	-20	PASS
	4024.5620	-52.48	-20	PASS
	4829.4750	-53.79	-20	PASS
	5634.3870	-53.87	-20	PASS
	6439.3000	-53.20	-20	PASS
	7244.2120	-50.57	-20	PASS
8049.1250	-51.52	-20	PASS	



### 6.12.3. Test Result (Digital)

#### Digital: 762.0125 MHz, 12.5kHz Channel Spacing, Max Power (Not For FCC Review)

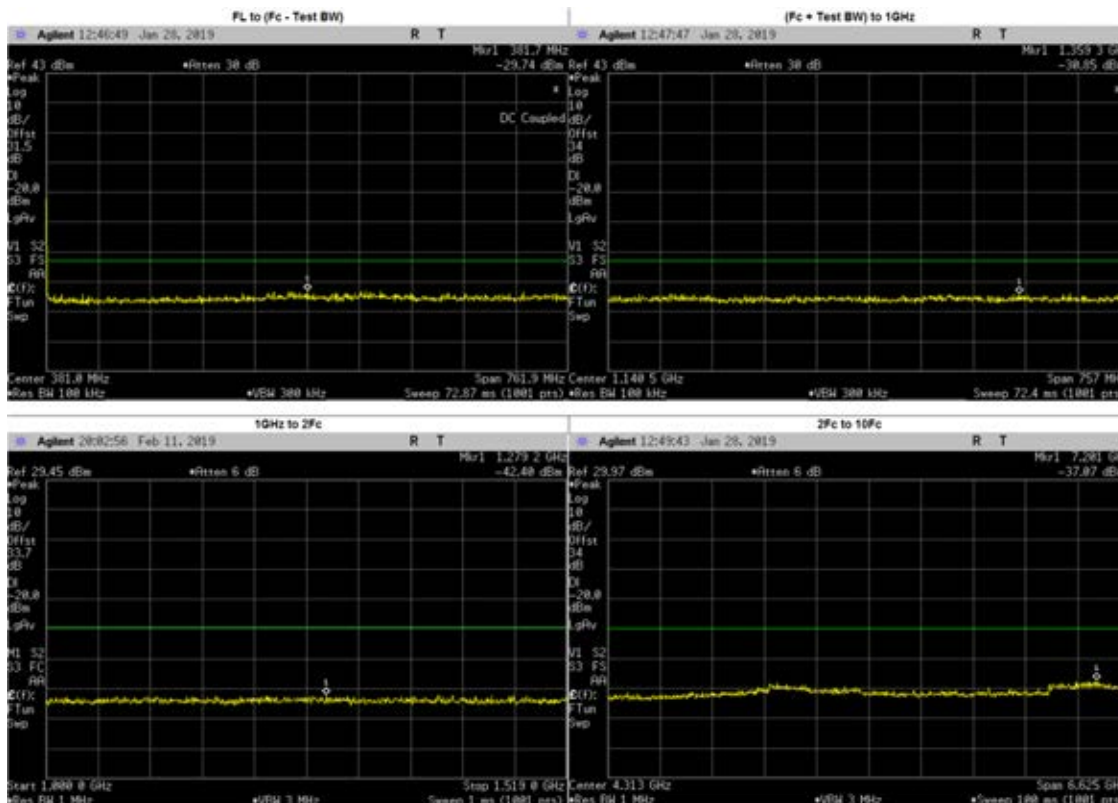

Frequency Range	Highest Spur Frequency (MHz)	Spurious Level (MHz)	Failing Limit (dBm)	Results
FL to (Fc - Test BW)	381.7449	-29.74	-20	PASS
(Fc + Test BW) to 1GHz	1359.3070	-30.85	-20	PASS
1GHz to 2Fc	1279.2000	-42.40	-20	PASS
2Fc to 10Fc	7201.1170	-37.07	-20	PASS
	1524.0250	-43.53	-20	PASS
	2286.0370	-42.41	-20	PASS
	3048.0500	-46.24	-20	PASS
	3810.0620	-41.06	-20	PASS
	4572.0750	-42.08	-20	PASS
	5334.0870	-40.97	-20	PASS
	6096.1000	-40.52	-20	PASS
	6858.1130	-39.73	-20	PASS
7620.1250	-40.03	-20	PASS	

**Digital: 769.0125 MHz, 12.5kHz Channel Spacing, Max Power**

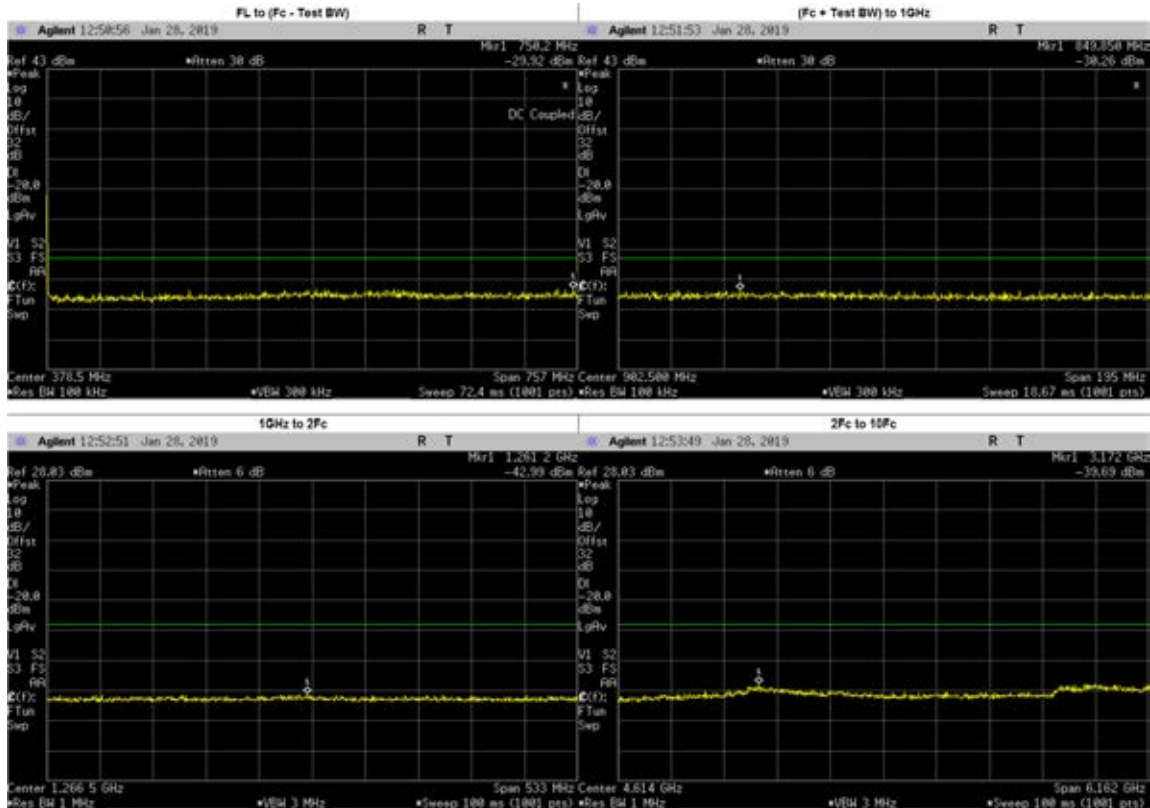

Frequency Range	Highest Spur Frequency (MHz)	Spurious Level (MHz)	Failing Limit (dBm)	Results
FL to (Fc - Test BW)	750.1871	-29.92	-20	PASS
(Fc + Test BW) to 1GHz	849.8500	-30.26	-20	PASS
1GHz to 2Fc	1261.1820	-42.99	-20	PASS
2Fc to 10Fc	3172.1440	-39.69	-20	PASS
	1538.0250	-45.33	-20	PASS
	2307.0370	-43.44	-20	PASS
	3076.0500	-41.24	-20	PASS
	3845.0620	-43.04	-20	PASS
	4614.0750	-44.38	-20	PASS
	5383.0870	-43.84	-20	PASS
	6152.1000	-43.81	-20	PASS
	6921.1130	-41.82	-20	PASS
7690.1250	-41.04	-20	PASS	

**Digital: 769.0875 MHz, 12.5kHz Channel Spacing, Max Power**

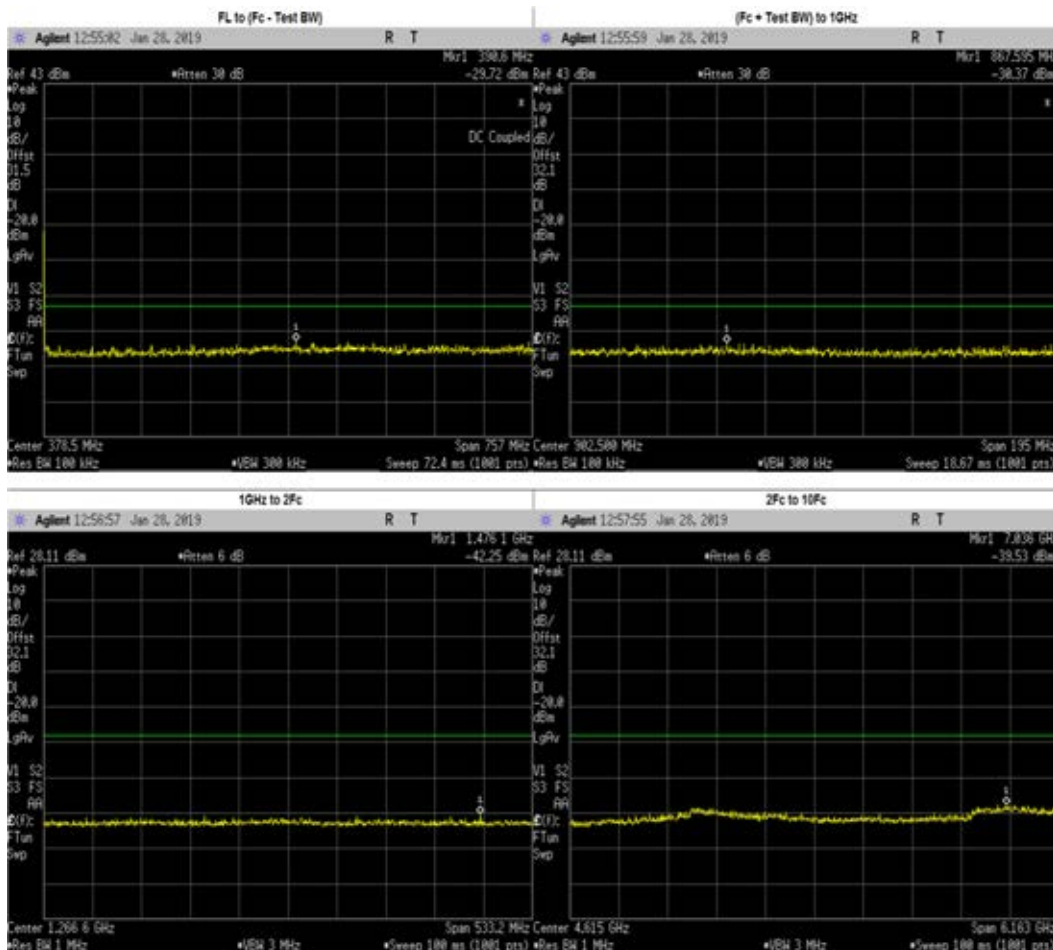

Frequency Range	Highest Spur Frequency (MHz)	Spurious Level (MHz)	Failing Limit (dBm)	Results
FL to (Fc - Test BW)	390.6164	-29.72	-20	PASS
(Fc + Test BW) to 1GHz	867.5950	-30.37	-20	PASS
1GHz to 2Fc	1476.1250	<b>-42.25</b>	-20	PASS
2Fc to 10Fc	7301.4620	-42.46	-20	PASS
	1538.1750	-44.50	-20	PASS
	2307.2620	-44.06	-20	PASS
	3076.3500	-40.88	-20	PASS
	3845.4370	-42.93	-20	PASS
	4614.5250	-44.57	-20	PASS
	5383.6130	-43.46	-20	PASS
	6152.7000	-44.01	-20	PASS
	6921.7880	-40.90	-20	PASS
7690.8750	-41.45	-20	PASS	

**Digital: 774.8875 MHz, 12.5kHz Channel Spacing, Max Power**

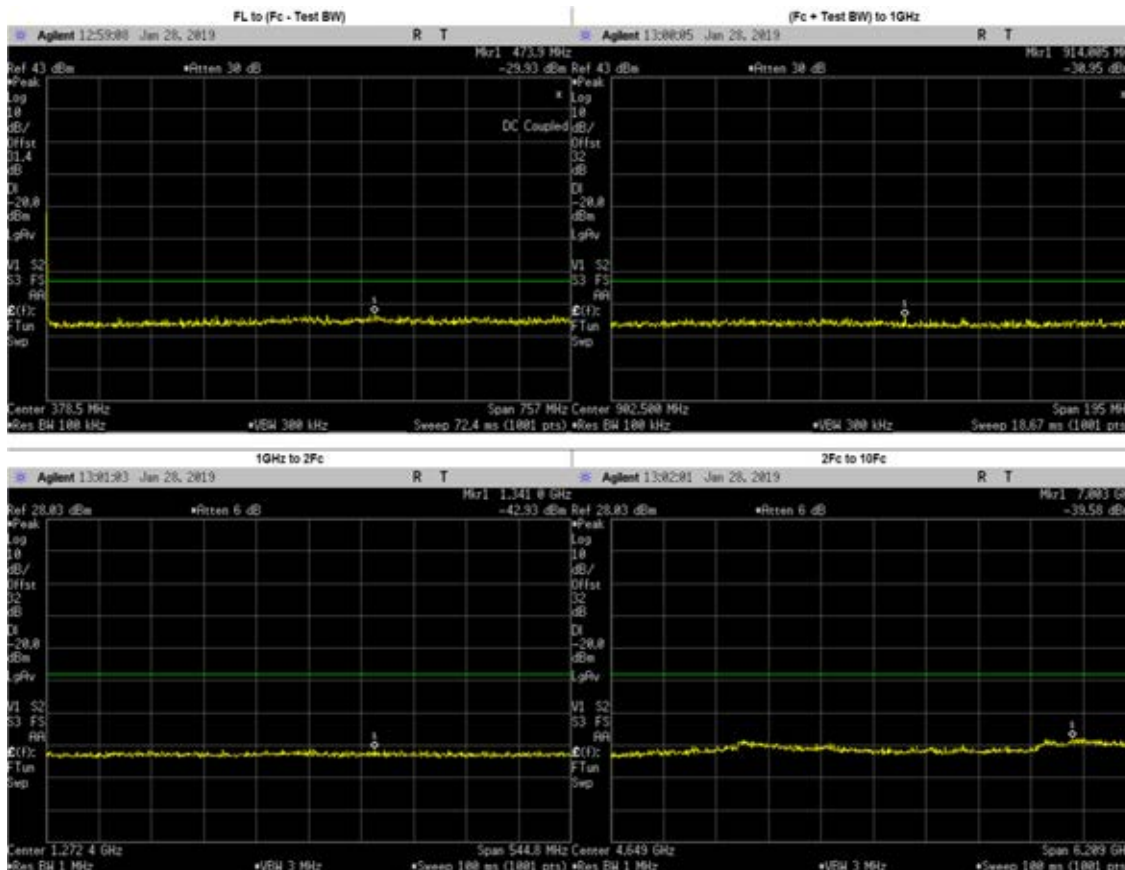

Frequency Range	Highest Spur Frequency (MHz)	Spurious Level (MHz)	Failing Limit (dBm)	Results
FL to (Fc - Test BW)	473.8854	-29.93	-20	PASS
(Fc + Test BW) to 1GHz	914.0050	-30.95	-20	PASS
1GHz to 2Fc	1341.0290	-42.93	-20	PASS
2Fc to 10Fc	7002.5740	-39.58	-20	PASS
	1549.7750	-45.42	-20	PASS
	2324.6620	-44.61	-20	PASS
	3099.5500	-41.06	-20	PASS
	3874.4370	-42.58	-20	PASS
	4649.3250	-44.34	-20	PASS
	5424.2120	-43.78	-20	PASS
	6199.1000	-42.76	-20	PASS
6973.9880	-40.85	-20	PASS	
7748.8750	-41.22	-20	PASS	

**Digital: 794.0125 MHz, 12.5kHz Channel Spacing, Max Power**  
**(Not For FCC Review)**

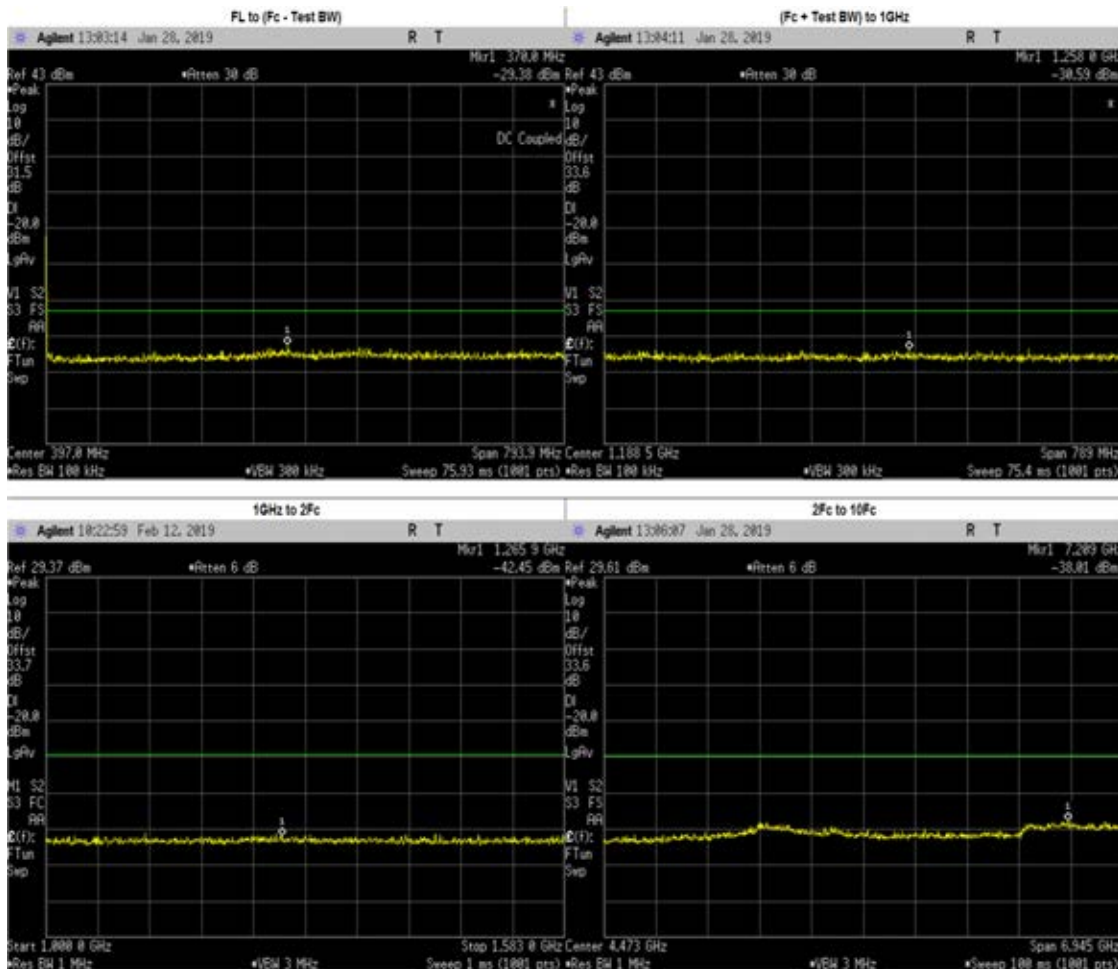

Frequency Range	Highest Spur Frequency (MHz)	Spurious Level (MHz)	Failing Limit (dBm)	Results
FL to (Fc - Test BW)	369.9887	-29.38	-20	PASS
(Fc + Test BW) to 1GHz	1257.9750	-30.59	-20	PASS
1GHz to 2Fc	1265.9000	-42.45	-20	PASS
2Fc to 10Fc	7208.9420	-38.01	-20	PASS
	1588.0250	-43.83	-20	PASS
	2382.0370	-43.33	-20	PASS
	3970.0620	-41.19	-20	PASS
	4764.0750	-42.42	-20	PASS
	5558.0870	-43.04	-20	PASS
	6352.1000	-42.19	-20	PASS
	3176.0500	-47.60	-20	PASS
	7146.1130	-42.80	-20	PASS
7940.1250	-42.29	-20	PASS	

**Digital: 799.0875 MHz, 12.5kHz Channel Spacing, Max Power**

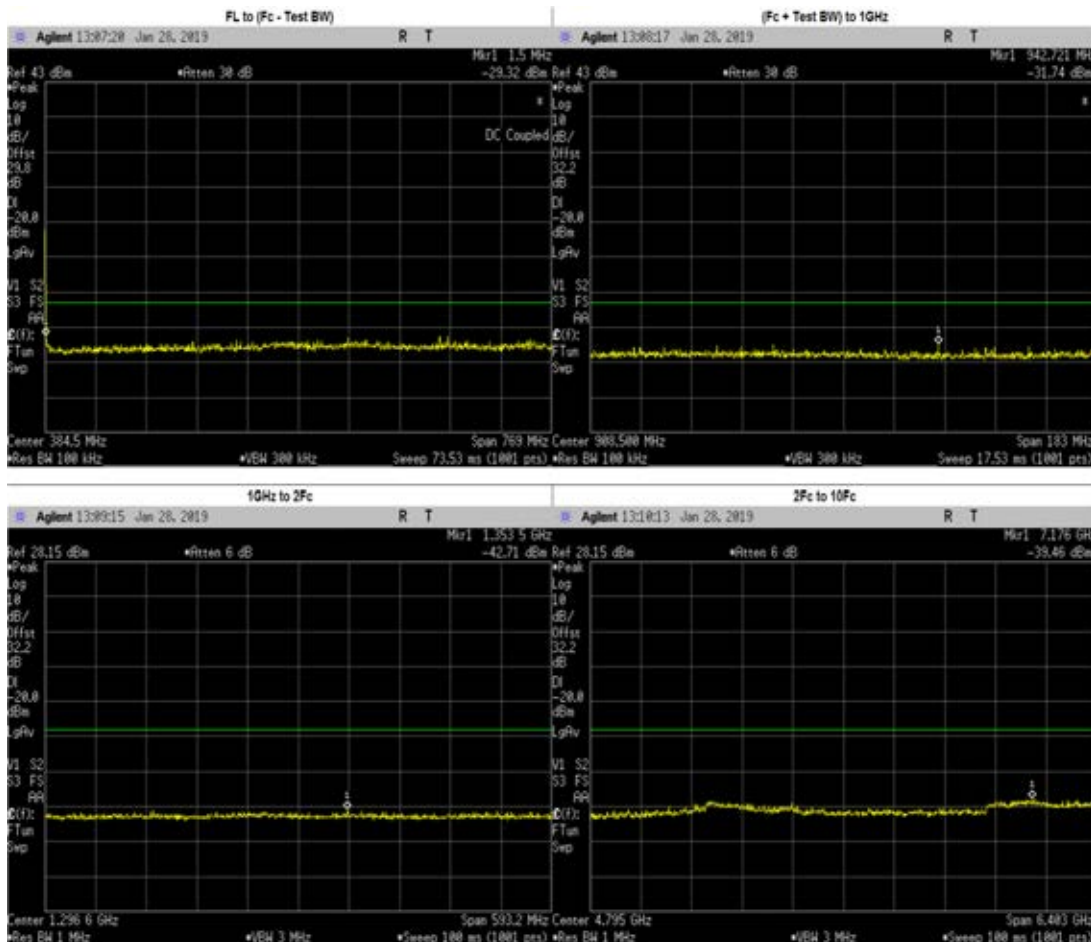

Frequency Range	Highest Spur Frequency (MHz)	Spurious Level (MHz)	Failing Limit (dBm)	Results
FL to (Fc - Test BW)	1.5470	-29.32	-20	PASS
(Fc + Test BW) to 1GHz	942.7210	-31.74	-20	PASS
1GHz to 2Fc	1353.5320	-42.71	-20	PASS
2Fc to 10Fc	7176.3290	-39.46	-20	PASS
	1598.1750	-45.30	-20	PASS
	2397.2620	-44.17	-20	PASS
	3196.3500	-40.97	-20	PASS
	3995.4370	-41.90	-20	PASS
	4794.5250	-43.96	-20	PASS
	5593.6130	-44.06	-20	PASS
	6392.7000	-43.27	-20	PASS
	7191.7880	-40.77	-20	PASS
7990.8750	-41.75	-20	PASS	

**Digital: 804.9125 MHz, 12.5kHz Channel Spacing, Max Power**

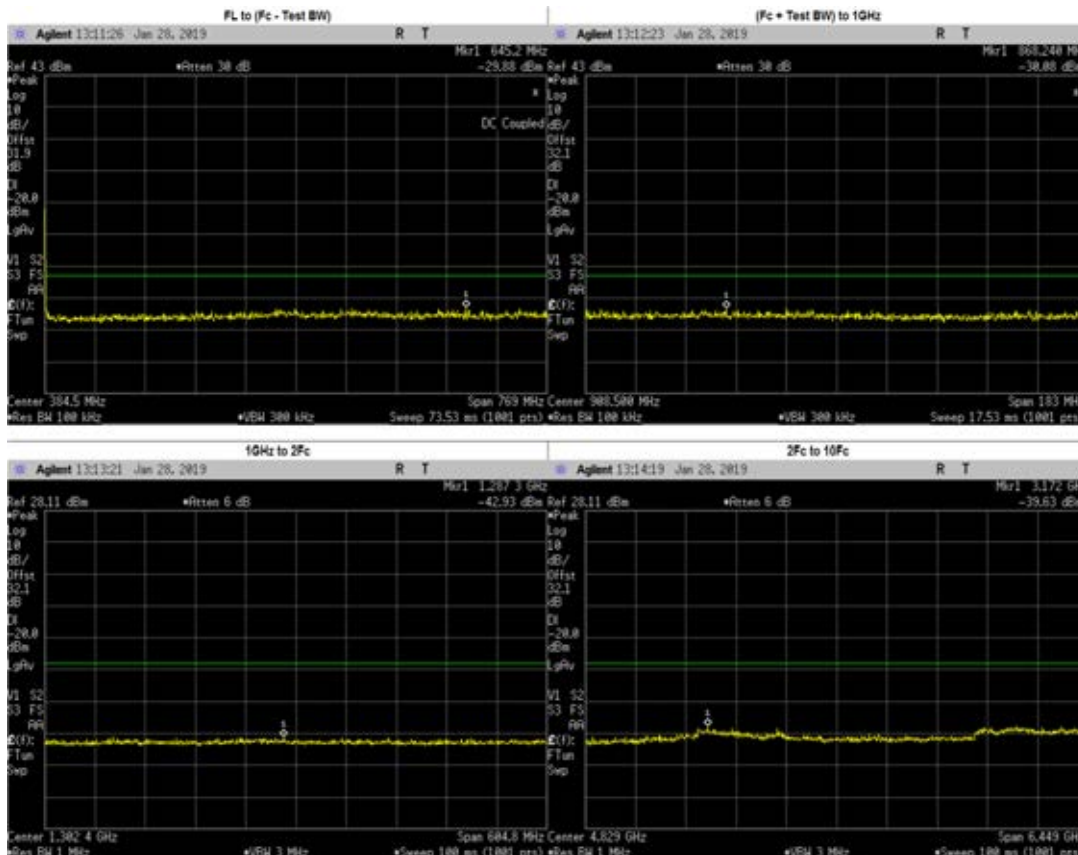

Frequency Range	Highest Spur Frequency (MHz)	Spurious Level (MHz)	Failing Limit (dBm)	Results
FL to (Fc - Test BW)	645.1924	-29.88	-20	PASS
(Fc + Test BW) to 1GHz	868.2400	-30.08	-20	PASS
1GHz to 2Fc	1287.2920	-42.93	-20	PASS
2Fc to 10Fc	3172.0050	-39.63	-20	PASS
	1609.8250	-44.71	-20	PASS
	2414.7380	-43.86	-20	PASS
	3219.6500	-41.95	-20	PASS
	4024.5620	-43.16	-20	PASS
	4829.4750	-43.21	-20	PASS
	5634.3870	-43.90	-20	PASS
	6439.3000	-43.88	-20	PASS
	7244.2120	-40.58	-20	PASS
8049.1250	-41.90	-20	PASS	

**Phase II: 762.0125 MHz, 12.5kHz Channel Spacing, Max Power**  
**(Not For FCC Review)**

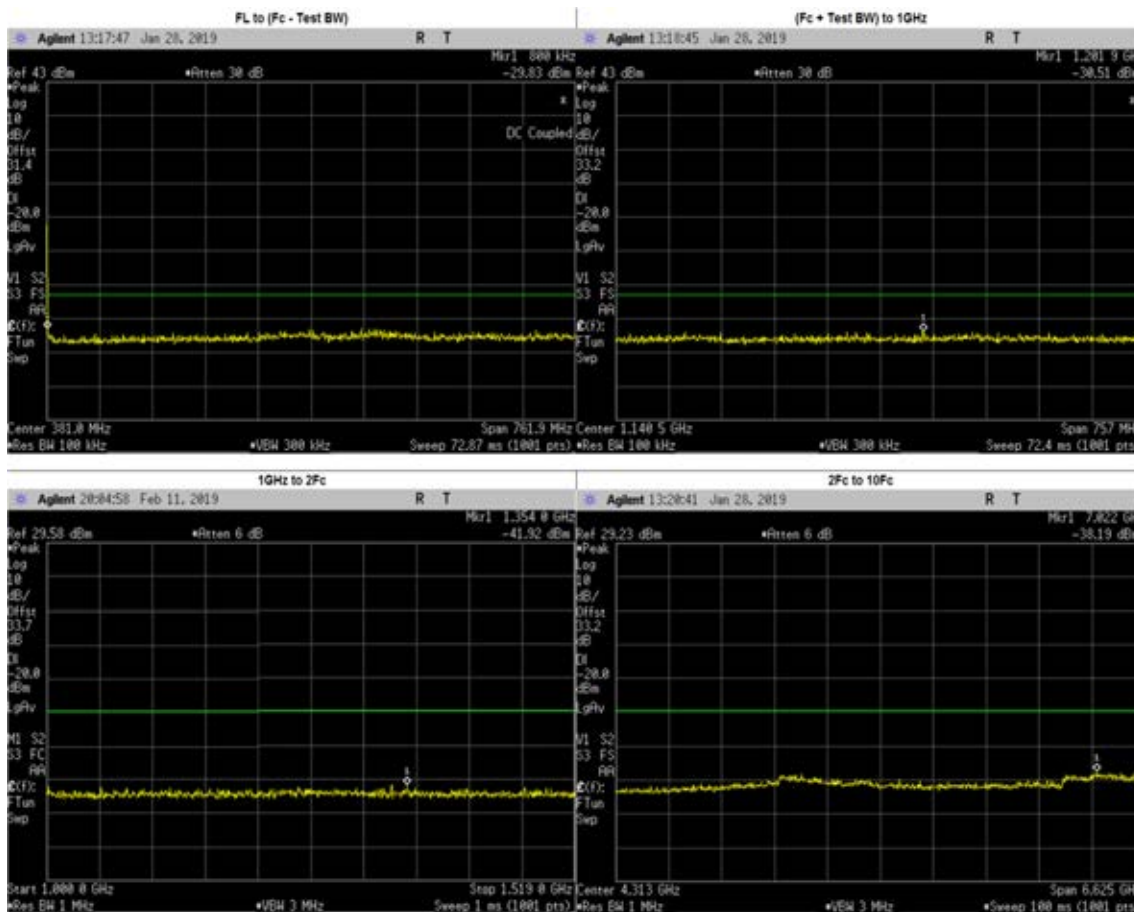

Frequency Range	Highest Spur Frequency (MHz)	Spurious Level (MHz)	Failing Limit (dBm)	Results
FL to (Fc - Test BW)	453.3680	-30.15	-20	PASS
(Fc + Test BW) to 1GHz	1201.8600	-30.51	-20	PASS
1GHz to 2Fc	1354.0000	-41.92	-20	PASS
2Fc to 10Fc	7022.2390	-38.19	-20	PASS
	1524.0250	-43.93	-20	PASS
	2286.0370	-43.07	-20	PASS
	3048.0500	-48.53	-20	PASS
	3810.0620	-41.64	-20	PASS
	4572.0750	-42.75	-20	PASS
	5334.0870	-42.52	-20	PASS
	6096.1000	-42.13	-20	PASS
	6858.1130	-40.65	-20	PASS
7620.1250	-40.84	-20	PASS	



**PhaseII: 769.0125 MHz, 12.5kHz Channel Spacing, Max Power**

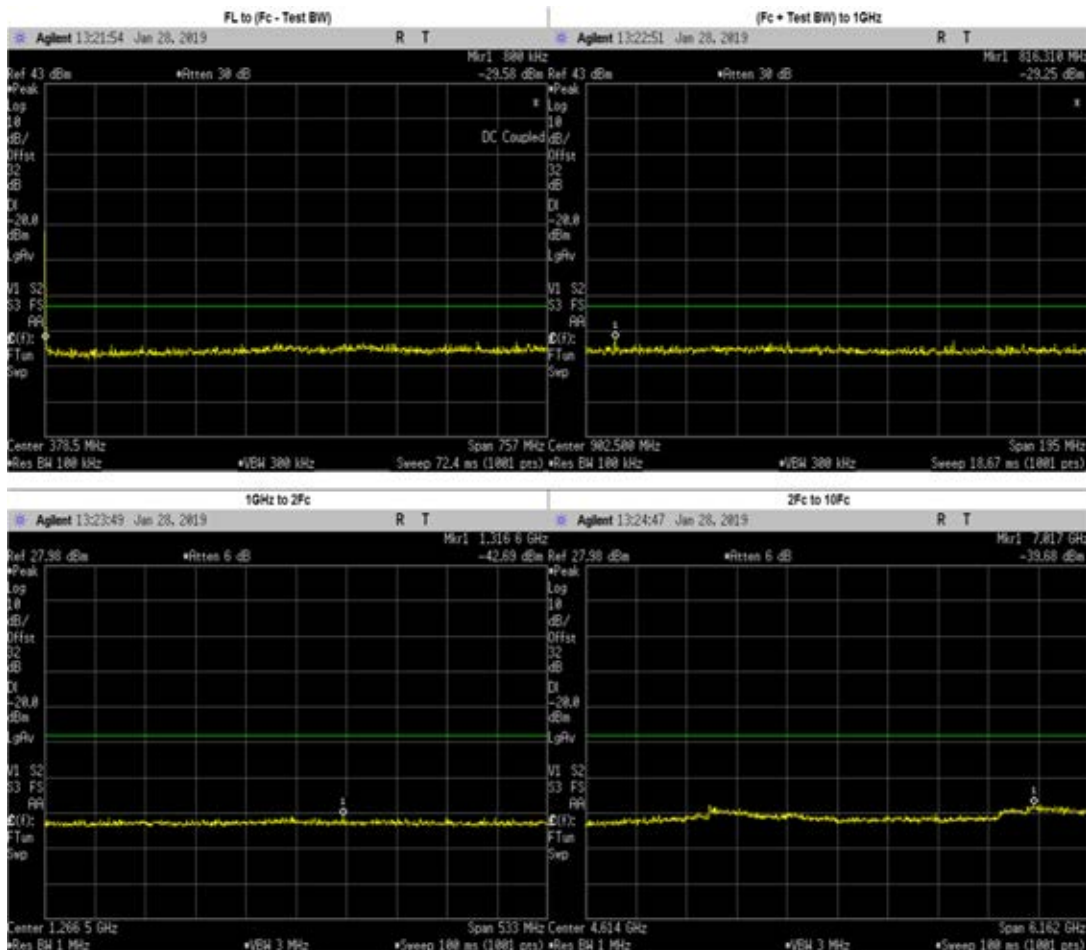

Frequency Range	Highest Spur Frequency (MHz)	Spurious Level (MHz)	Failing Limit (dBm)	Results
FL to (Fc - Test BW)	479.1843	-31.30	-20	PASS
(Fc + Test BW) to 1GHz	816.3100	-29.25	-20	PASS
1GHz to 2Fc	1316.6170	-42.69	-20	PASS
2Fc to 10Fc	7017.2940	-39.68	-20	PASS
	1538.0250	-45.18	-20	PASS
	2307.0370	-44.27	-20	PASS
	3076.0500	-41.43	-20	PASS
	3845.0620	-42.86	-20	PASS
	4614.0750	-44.84	-20	PASS
	5383.0870	-43.70	-20	PASS
	6152.1000	-43.94	-20	PASS
	6921.1130	-41.96	-20	PASS
7690.1250	-41.61	-20	PASS	

**PhaseII: 769.0875 MHz, 12.5kHz Channel Spacing, Max Power**

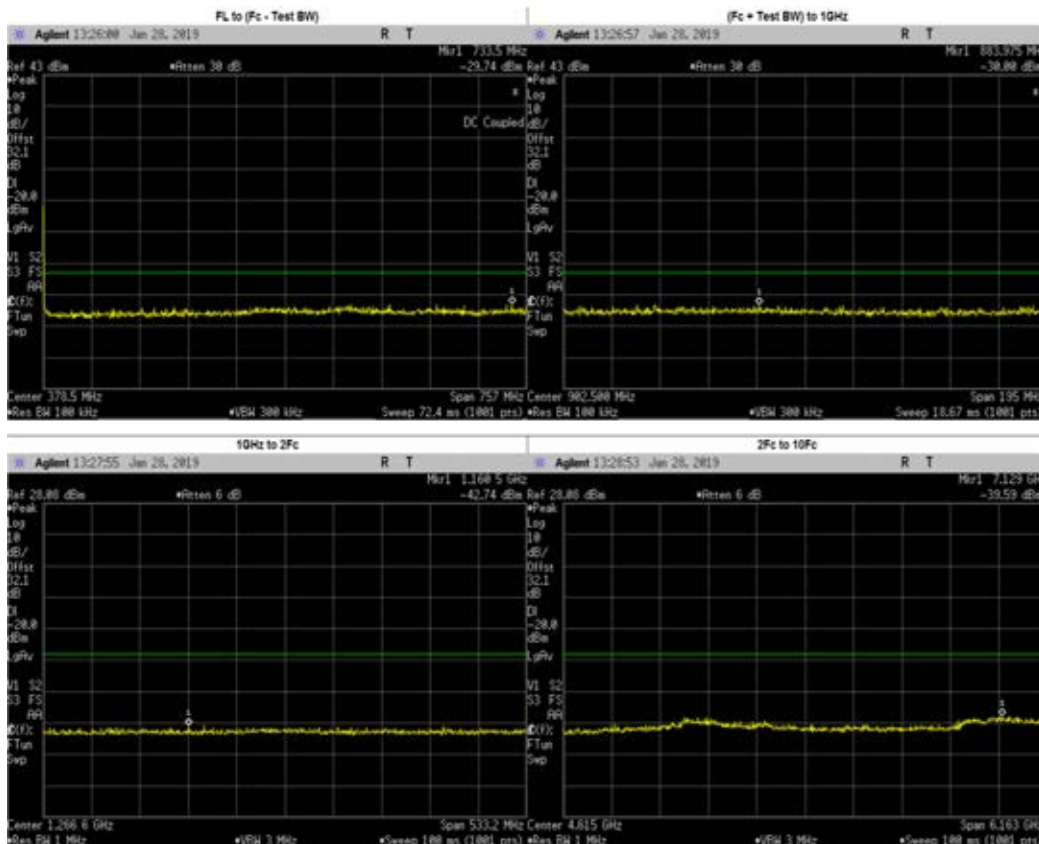

Frequency Range	Highest Spur Frequency (MHz)	Spurious Level (MHz)	Failing Limit (dBm)	Results
FL to (Fc - Test BW)	733.5333	-29.74	-20	PASS
(Fc + Test BW) to 1GHz	883.9750	-30.00	-20	PASS
1GHz to 2Fc	1160.4860	-42.74	-20	PASS
2Fc to 10Fc	7128.9070	-39.59	-20	PASS
	1538.1750	-45.03	-20	PASS
	2307.2620	-43.89	-20	PASS
	3076.3500	-40.53	-20	PASS
	3845.4370	-42.79	-20	PASS
	4614.5250	-43.90	-20	PASS
	5383.6130	-43.45	-20	PASS
	6152.7000	-43.28	-20	PASS
	6921.7880	-41.94	-20	PASS
7690.8750	-41.77	-20	PASS	

**PhaseII: 774.8875 MHz, 12.5kHz Channel Spacing, Max Power**

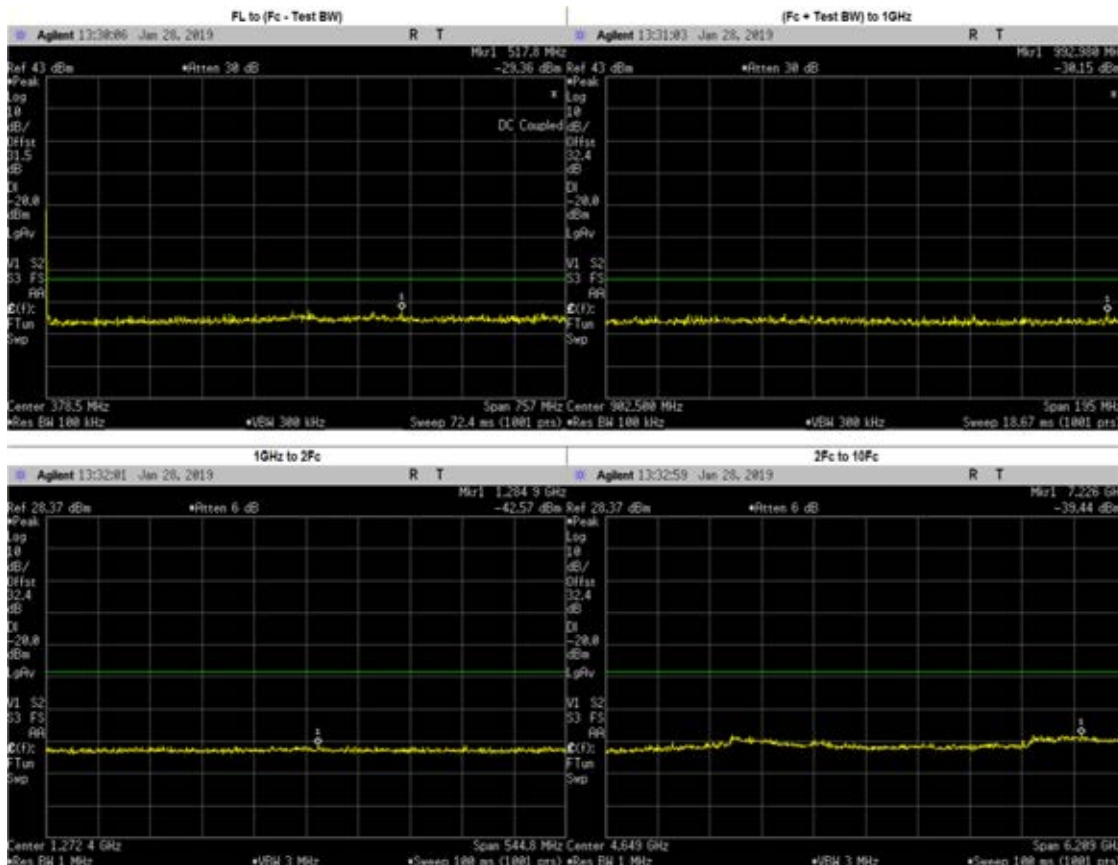

Frequency Range	Highest Spur Frequency (MHz)	Spurious Level (MHz)	Failing Limit (dBm)	Results
FL to (Fc - Test BW)	517.7908	-29.36	-20	PASS
(Fc + Test BW) to 1GHz	992.9800	-30.15	-20	PASS
1GHz to 2Fc	1284.9170	-42.57	-20	PASS
2Fc to 10Fc	7226.1010	-39.44	-20	PASS
	1549.7750	-44.72	-20	PASS
	2324.6620	-44.29	-20	PASS
	3099.5500	-40.68	-20	PASS
	3874.4370	-42.92	-20	PASS
	4649.3250	-43.06	-20	PASS
	5424.2120	-42.26	-20	PASS
	6199.1000	-42.63	-20	PASS
	6973.9880	-40.80	-20	PASS
7748.8750	-41.32	-20	PASS	

**Phase II: 794.0125 MHz, 12.5kHz Channel Spacing, Max Power**  
**(Not For FCC Review)**

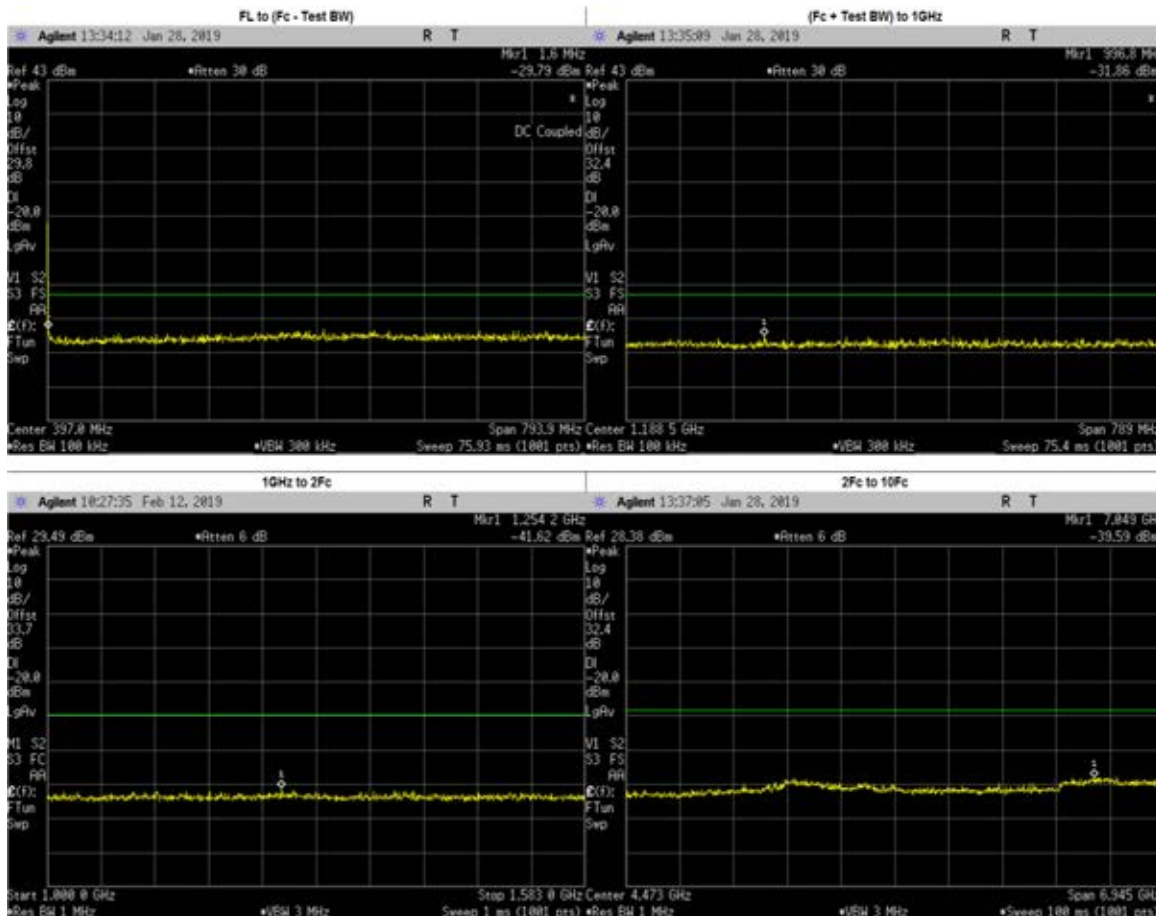

Frequency Range	Highest Spur Frequency (MHz)	Spurious Level (MHz)	Failing Limit (dBm)	Results
FL to (Fc - Test BW)	1.5969	-29.79	-20	PASS
(Fc + Test BW) to 1GHz	996.8300	-31.86	-20	PASS
1GHz to 2Fc	1254.2000	-41.62	-20	PASS
2Fc to 10Fc	7049.2040	-39.59	-20	PASS
	1588.0250	-44.87	-20	PASS
	2382.0370	-43.20	-20	PASS
	3176.0500	-40.87	-20	PASS
	3970.0620	-42.62	-20	PASS
	4764.0750	-43.43	-20	PASS
	5558.0870	-44.22	-20	PASS
	6352.1000	-43.24	-20	PASS
	7146.1130	-40.72	-20	PASS
7940.1250	-40.24	-20	PASS	

**PhaseII: 799.0875 MHz, 12.5kHz Channel Spacing, Max Power**

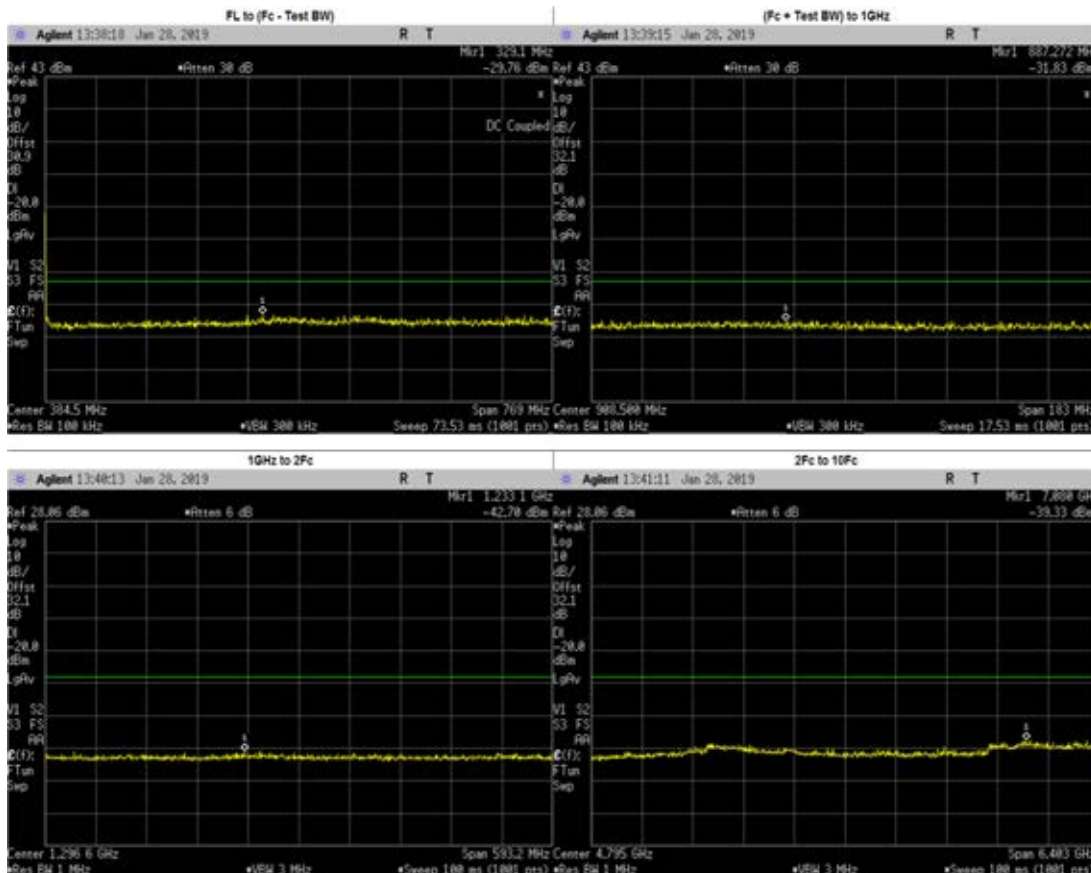

Frequency Range	Highest Spur Frequency (MHz)	Spurious Level (MHz)	Failing Limit (dBm)	Results
FL to (Fc - Test BW)	329.1371	-29.76	-20	PASS
(Fc + Test BW) to 1GHz	887.2720	-31.83	-20	PASS
1GHz to 2Fc	1233.1180	-42.70	-20	PASS
2Fc to 10Fc	7080.2890	-39.33	-20	PASS
	1598.1750	-45.25	-20	PASS
	2397.2620	-44.45	-20	PASS
	3196.3500	-41.23	-20	PASS
	3995.4370	-43.40	-20	PASS
	4794.5250	-44.04	-20	PASS
	5593.6130	-44.53	-20	PASS
	6392.7000	-43.46	-20	PASS
	7191.7880	-41.52	-20	PASS
7990.8750	-41.83	-20	PASS	

**PhaseII: 804.9125 MHz, 12.5kHz Channel Spacing, Max Power**

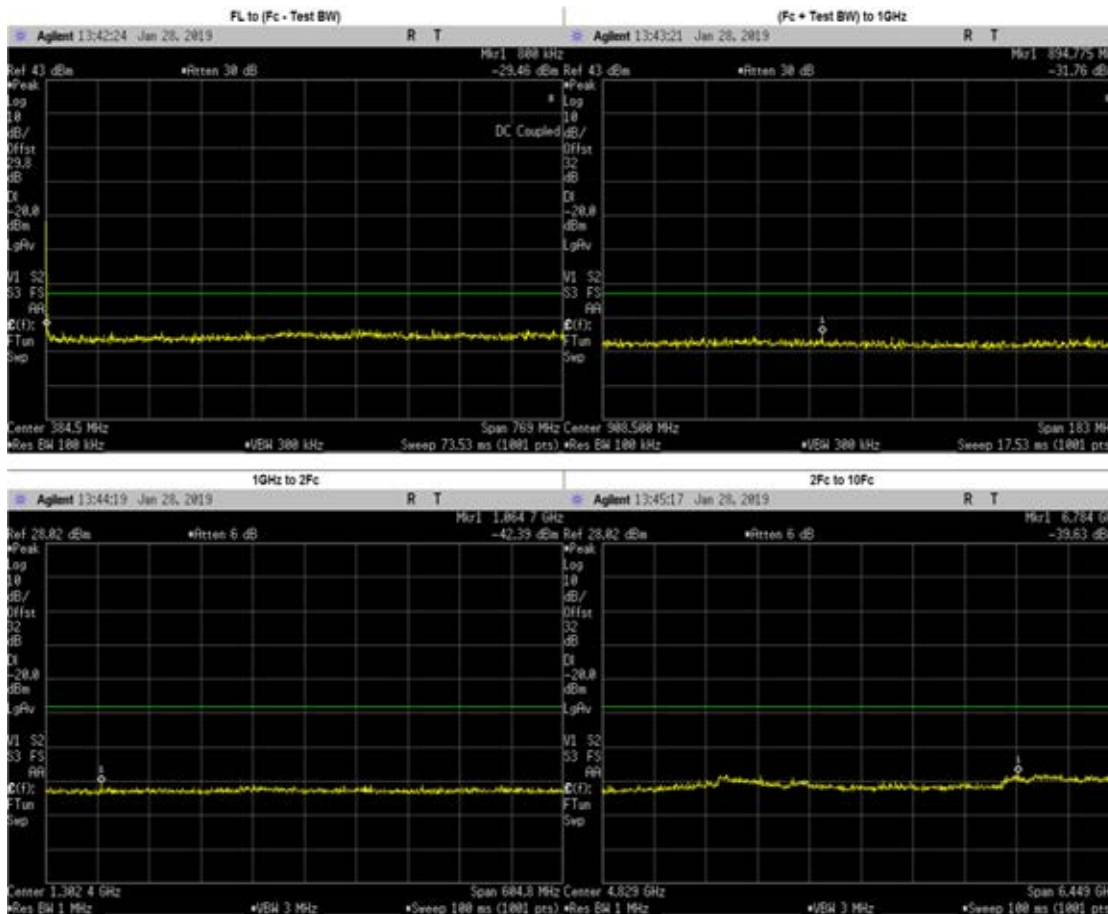

Frequency Range	Highest Spur Frequency (MHz)	Spurious Level (MHz)	Failing Limit (dBm)	Results
FL to (Fc - Test BW)	2.3160	-30.13	-20	PASS
(Fc + Test BW) to 1GHz	894.7750	-31.76	-20	PASS
1GHz to 2Fc	1064.7160	-42.39	-20	PASS
2Fc to 10Fc	6783.6130	-39.63	-20	PASS
	1609.8250	-45.26	-20	PASS
	2414.7380	-44.31	-20	PASS
	3219.6500	-42.00	-20	PASS
	4024.5620	-42.44	-20	PASS
	4829.4750	-44.23	-20	PASS
	5634.3870	-43.67	-20	PASS
	6439.3000	-43.89	-20	PASS
	7244.2120	-40.51	-20	PASS
8049.1250	-41.50	-20	PASS	

**6.12.4. Test Limit**

Table below summarized the power of any emission outside a licensee’s frequency block shall be attenuated below the transmitter power (P) by at least

Channel Spacing	Part 22	Part 24D	Part 74	Part 80	Part 90 (UHF, VHF, 800, 900)	Part 90 (700)
12.5kHz	43 + log <sub>10</sub> (P) (-13 dBm)	43 + log <sub>10</sub> (P) (-13 dBm)	43 + log <sub>10</sub> (P) (-13 dBm)	Not Applicable	50 + log <sub>10</sub> (P) (-20 dBm)	43 + log <sub>10</sub> (P) (-13 dBm)
25kHz		Not Applicable		43 + log <sub>10</sub> (P) (-13 dBm)	43 + log <sub>10</sub> (P) (-13 dBm)	43 + log <sub>10</sub> (P) (-13 dBm)

Channel Spacing	RSS 134	RSS 182	RSS 119 (UHF, VHF, 800, 900)	RSS 119 (700)
12.5kHz	43 + log <sub>10</sub> (P) (-13 dBm)	Not Applicable	50 + log <sub>10</sub> (P) (-20 dBm)	43 + log <sub>10</sub> (P) (-13 dBm)
25kHz	Not Applicable	43 + log <sub>10</sub> (P) (-13 dBm)	43 + log <sub>10</sub> (P) (-13 dBm)	43 + log <sub>10</sub> (P) (-13 dBm)

## 6.13. Radiated Spurious Emission

### 6.13.1. Test Setup

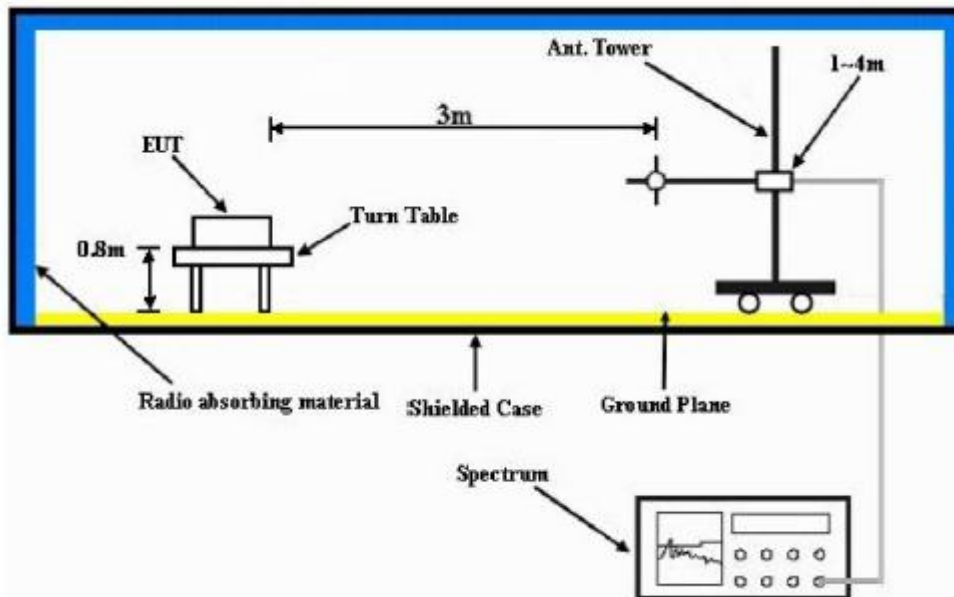

- 1) The Resolution Bandwidth for scanning Radiated Emission below 1 GHz is 100 kHz with Video Bandwidth = 300 kHz and Resolution Bandwidth for above 1 GHz is 1 MHz with Video Bandwidth = 3 MHz. Detector mode is positive peak.
- 2) In the semi- anechoic chamber, setup as illustrated above the DUT placed on the 0.8m height (for frequencies < 1GHz) or 1.5m (for frequencies > 1GHz) of Turn Table, rotated the table around 360 degrees to search the maximum radiation power and receiver antenna shall be rotated vertical and horizontal polarization and moved height from 1m to 4m to find the maximum polar radiated power. The “Read Value” is the spectrum reading the maximum power value.
- 3) The substitution antenna is substituted for DUT at the same position and signals generator (S.G) export the CW signal to the substitution antenna via a TX cable. The receiver antenna shall be rotated vertical and horizontal polarization and moved height from 1m to 4m to find the maximum radiation power. Record the power level of maximum radiation power from spectrum. So, the measured substitution value = Ref level of S.G + TX cables loss – Substituted Antenna Gain.
- 4) Final Radiated Spurious Emission = “Read Value” + Measured substitution value.



### 6.13.2. Test Result (Analog)

SAC Transmitter Radiated Emission:

Model Number: H55TGT9PW8AN

S/N: 437TUX0086

SR:12464-EMC-00073

Battery Part No: NNTN9089A

Accy Part No: NA

Test Mode: TX Analog

762.012500 MHz

12.5 kHz

1.000 Watt(s) /Low Power

Frequency (MHz)	Limit	Horizontal Measured Emission Equiv Pwr Into Ideal Dipole (dBm)	Vertical Measured Emission Equiv Pwr Into ideal Dipole (dBm)
1524.0250	-13.0000	-48.2600 *	-53.3200 *
2286.0375	-13.0000	-56.4309 **	-56.6398 **
3048.0500	-13.0000	-53.3076 **	-53.6181 **
3810.0625	-13.0000	-52.4769 **	-52.3075 **
4572.0750	-13.0000	-50.5606 **	-50.0739 **
5334.0875	-13.0000	-49.0842 **	-48.0130 **
6096.1000	-13.0000	-46.7883 **	-46.8309 **
6858.1125	-13.0000	-44.9269 **	-45.8285 **
7620.1250	-13.0000	-44.5521 **	-43.5780 **

RADIATED SPURIOUS EMISSIONS

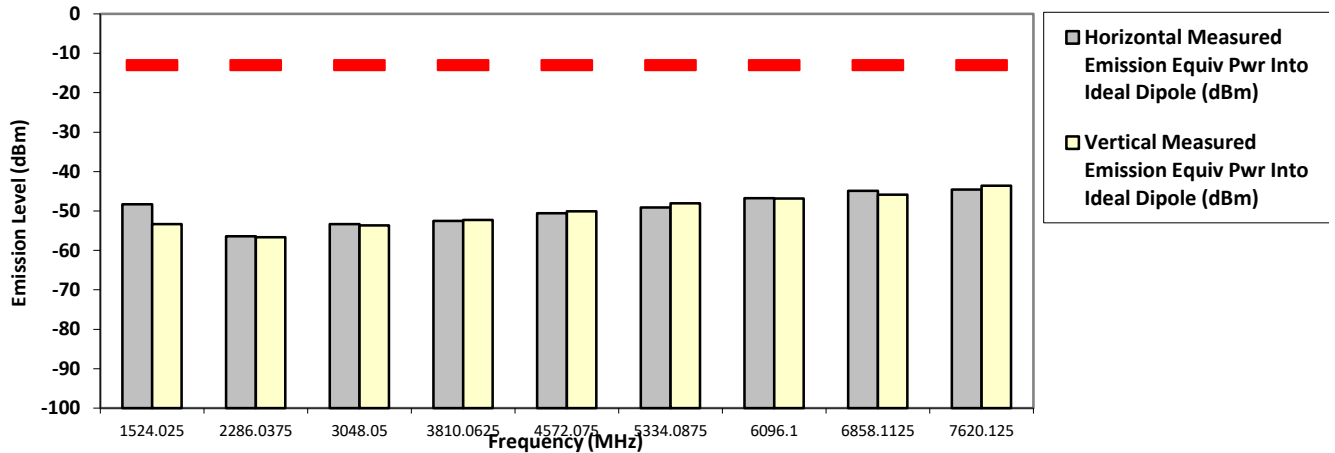

The data presented here was taken using the substitution method as found in the ANSI C63.26-2015 document.  
 Motorola Penang EMC Lab - Test Performed by: Nazrin&Qawiman Wed, Jan 09, 2019

Remarks: \*\* Indicates the spurious emission could not be detected due to noise limitations or ambient.  
 \*Pursuant to CFR 47 Part 2.1057 ( c ), emissions attenuated more than 20 dB below the permissible limit are not reported  
 Temp(Deg): 23.6 Hum(%RH): 70.3

System MU: 5.01 dB

Remarks:	Passed Results	Marginal Results	Failed Results
----------	----------------	------------------	----------------

**SAC Transmitter Radiated Emission:**

**Model Number: H55TGT9PW8AN**      **S/N: 437TUX0086**      **SR:12464-EMC-00073**  
**Battery Part No: NNTN9089A**      **Accy Part No: NA**  
**Test Mode: TX Analog**  
**762.012500 MHz**      **12.5 kHz**      **2.990 Watt(s) /Max Power**

Frequency (MHz)	Limit	Horizontal Measured Emission Equiv Pwr Into Ideal Dipole (dBm)	Vertical Measured Emission Equiv Pwr Into ideal Dipole (dBm)
1524.0250	-13.0000	-45.5100 *	-46.6100 *
2286.0375	-13.0000	-55.0773 **	-55.9523 **
3048.0500	-13.0000	-52.6315 **	-52.0866 **
3810.0625	-13.0000	-52.0393 **	-52.5346 **
4572.0750	-13.0000	-51.1056 **	-50.2674 **
5334.0875	-13.0000	-48.7173 **	-48.6222 **
6096.1000	-13.0000	-47.4768 **	-47.2436 **
6858.1125	-13.0000	-46.0058 **	-44.5549 **
7620.1250	-13.0000	-43.4529 **	-44.2488 **

**RADIATED SPURIOUS EMISSIONS**

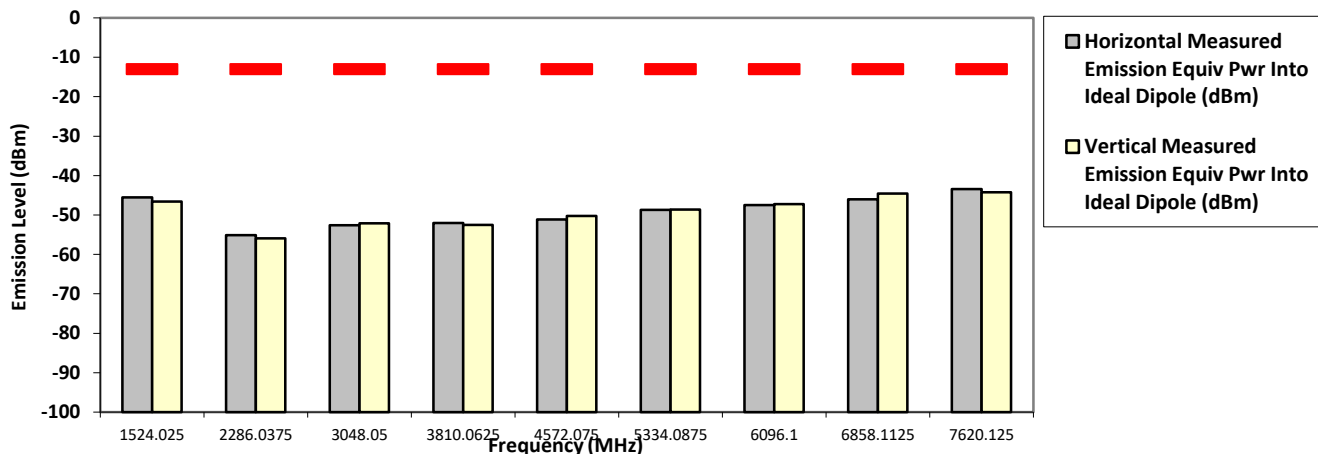

The data presented here was taken using the substitution method as found in the ANSI C63.26-2015 document.  
 Motorola Penang EMC Lab - Test Performed by: Nazrin&Qawiman      Wed, Jan 09, 2019

Remarks: \*\* Indicates the spurious emission could not be detected due to noise limitations or ambient.  
 \*Pursuant to CFR 47 Part 2.1057 ( c ), emissions attenuated more than 20 dB below the permissible limit are not reported  
 Temp(Deg): 23.6 Hum(%RH): 70.3

System MU: 5.01 dB

<b>Remarks:</b>	Passed Results	Marginal Results	Failed Results
-----------------	----------------	------------------	----------------

**SAC Transmitter Radiated Emission:**

**Model Number: H55TGT9PW8AN**      **S/N: 437TUX0086**      **SR:12464-EMC-00073**  
**Battery Part No: NNTN9089A**      **Accy Part No: NA**  
**Test Mode: TX Analog**  
**769.012500 MHz**      **12.5 kHz**      **2.990 Watt(s) /Max Power**

Frequency (MHz)	Limit	Horizontal Measured Emission Equiv Pwr Into Ideal Dipole (dBm)	Vertical Measured Emission Equiv Pwr Into ideal Dipole (dBm)
1538.0250	-13.0000	-44.7200 *	-44.0000 *
2307.0375	-13.0000	-56.9105 **	-56.7329 **
3076.0500	-13.0000	-50.5902 **	-52.8958 **
3845.0625	-13.0000	-52.6820 **	-52.8257 **
4614.0750	-13.0000	-48.7202 **	-50.9589 **
5383.0875	-13.0000	-49.7747 **	-49.0162 **
6152.1000	-13.0000	-47.4545 **	-46.8739 **
6921.1125	-13.0000	-45.8632 **	-45.3539 **
7690.1250	-13.0000	-43.5878 **	-43.5995 **

**RADIATED SPURIOUS EMISSIONS**

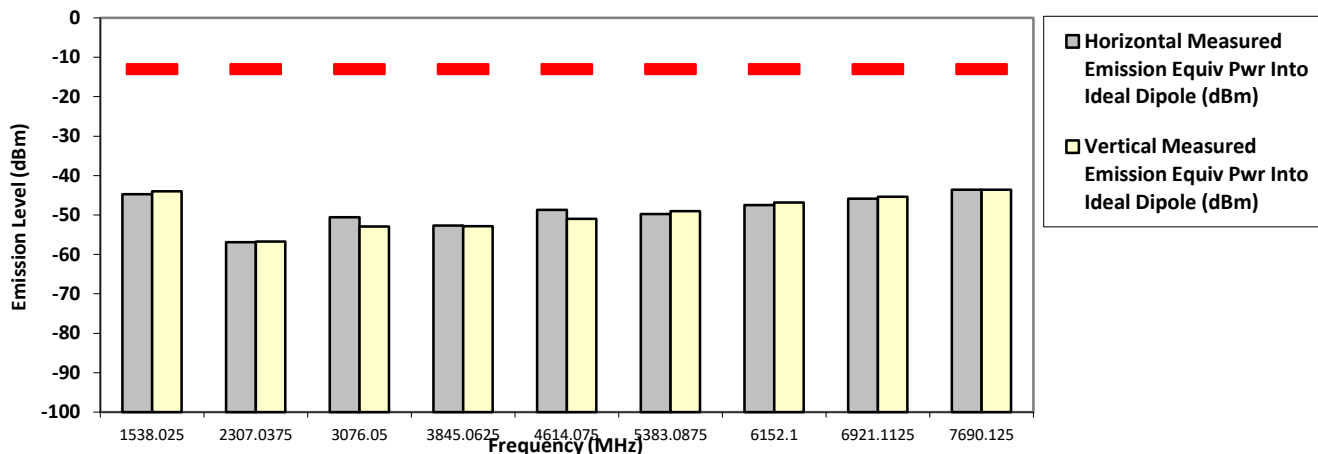

The data presented here was taken using the substitution method as found in the ANSI C63.26-2015 document.  
 Motorola Penang EMC Lab - Test Performed by: Nazrin&Qawiman      Wed, Jan 09, 2019

Remarks: \*\* Indicates the spurious emission could not be detected due to noise limitations or ambient.  
 \*Pursuant to CFR 47 Part 2.1057 ( c ), emissions attenuated more than 20 dB below the permissible limit are not reported  
 Temp(Deg): 23.6 Hum(%RH): 70.3

System MU: 5.01 dB

<b>Remarks:</b>	Passed Results	Marginal Results	Failed Results
-----------------	----------------	------------------	----------------

**SAC Transmitter Radiated Emission:**

**Model Number: H55TGT9PW8AN**      **S/N: 437TUX0086**      **SR:12464-EMC-00073**  
**Battery Part No: NNTN9089A**      **Accy Part No: NA**  
**Test Mode: TX Analog**  
**769.087500 MHz**      **12.5 kHz**      **1.000 Watt(s) /Low Power**

Frequency (MHz)	Limit	Horizontal Measured Emission Equiv Pwr Into Ideal Dipole (dBm)	Vertical Measured Emission Equiv Pwr Into ideal Dipole (dBm)
1538.0250	-13.0000	-45.4500 *	-49.7400 *
2307.2625	-13.0000	-56.0359 **	-54.9799 **
3076.3500	-13.0000	-51.1512 **	-53.1772 **
3845.4375	-13.0000	-52.1569 **	-51.5373 **
4614.5250	-13.0000	-49.6184 **	-49.9099 **
5383.6125	-13.0000	-48.3501 **	-47.8466 **
6152.7000	-13.0000	-46.8090 **	-45.5034 **
6921.7875	-13.0000	-45.2512 **	-44.2146 **
7690.8750	-13.0000	-42.1402 **	-44.3312 **

**RADIATED SPURIOUS EMISSIONS**

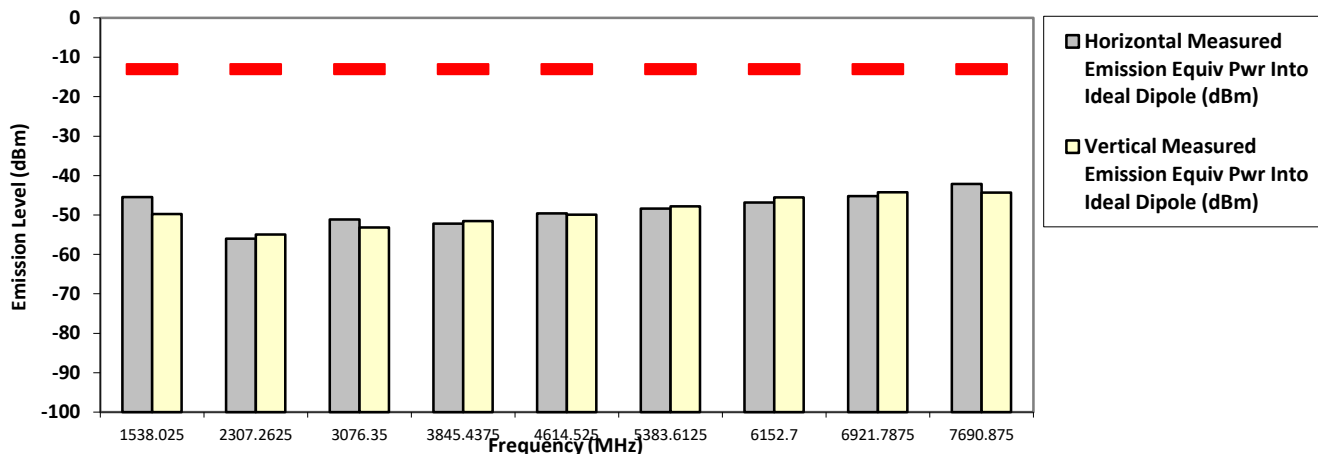

The data presented here was taken using the substitution method as found in the ANSI C63.26-2015 document.  
 Motorola Penang EMC Lab - Test Performed by: Nazrin&Qawiman      Wed, Jan 09, 2019

Remarks: \*\* Indicates the spurious emission could not be detected due to noise limitations or ambient.  
 \*Pursuant to CFR 47 Part 2.1057 ( c ), emissions attenuated more than 20 dB below the permissible limit are not reported  
 Temp(Deg): 23.6 Hum(%RH): 70.3

System MU: 5.01 dB

<b>Remarks:</b>	Passed Results	Marginal Results	Failed Results
-----------------	----------------	------------------	----------------

**SAC Transmitter Radiated Emission:**

**Model Number: H55TGT9PW8AN**      **S/N: 437TUX0086**      **SR:12464-EMC-00073**  
**Battery Part No: NNTN9089A**      **Accy Part No: NA**  
**Test Mode: TX Analog**  
**769.087500 MHz**      **12.5 kHz**      **2.990 Watt(s) /Max Power**

Frequency (MHz)	Limit	Horizontal Measured Emission Equiv Pwr Into Ideal Dipole (dBm)	Vertical Measured Emission Equiv Pwr Into ideal Dipole (dBm)
1538.1750	-13.0000	-44.6400 *	-44.3800 *
2307.2625	-13.0000	-55.6714 **	-57.2291 **
3076.3500	-13.0000	-51.1772 **	-53.0298 **
3845.4375	-13.0000	-51.4017 **	-52.1888 **
4614.5250	-13.0000	-50.7553 **	-51.4925 **
5383.6125	-13.0000	-48.4654 **	-48.5735 **
6152.7000	-13.0000	-47.1851 **	-46.9977 **
6921.7875	-13.0000	-44.8917 **	-45.8213 **
7690.8750	-13.0000	-44.0081 **	-44.6373 **

**RADIATED SPURIOUS EMISSIONS**

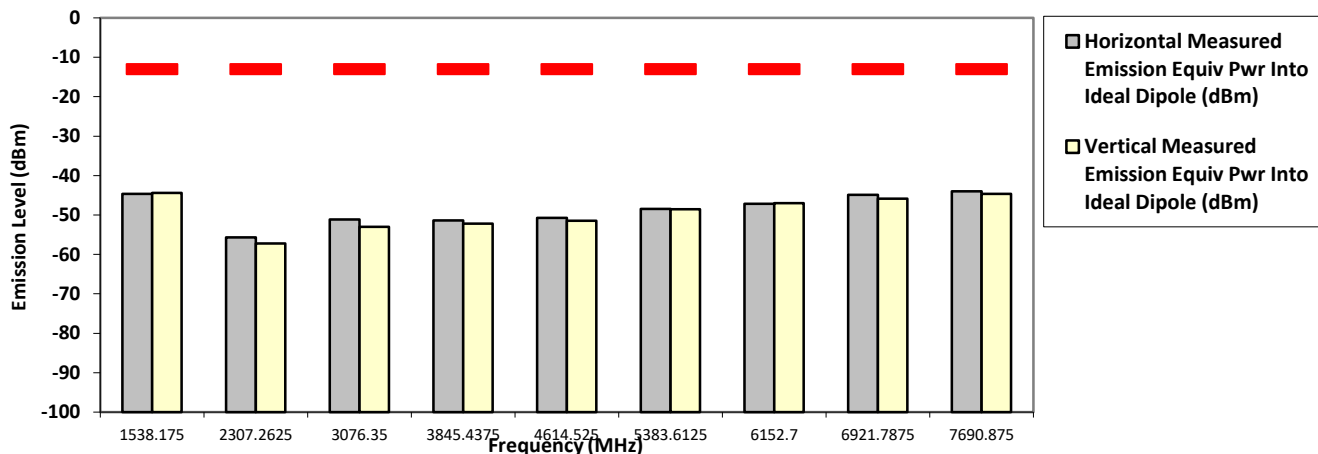

The data presented here was taken using the substitution method as found in the ANSI C63.26-2015 document.  
 Motorola Penang EMC Lab - Test Performed by: Nazrin&Qawiman      Wed, Jan 09, 2019

Remarks: \*\* Indicates the spurious emission could not be detected due to noise limitations or ambient.  
 \*Pursuant to CFR 47 Part 2.1057 ( c ), emissions attenuated more than 20 dB below the permissible limit are not reported  
 Temp(Deg): 23.6 Hum(%RH): 70.3

System MU: 5.01 dB

<b>Remarks:</b>	Passed Results	Marginal Results	Failed Results
-----------------	----------------	------------------	----------------

**SAC Transmitter Radiated Emission:**

**Model Number: H55TGT9PW8AN**      **S/N: 437TUX0086**      **SR:12464-EMC-00073**  
**Battery Part No: NNTN9089A**      **Accy Part No: NA**  
**Test Mode: TX Analog**  
**774.887500 MHz**      **12.5 kHz**      **1.000 Watt(s) /Low Power**

Frequency (MHz)	Limit	Horizontal Measured Emission Equiv Pwr Into Ideal Dipole (dBm)	Vertical Measured Emission Equiv Pwr Into ideal Dipole (dBm)
1549.7750	-13.0000	-49.4100 *	-49.9100 *
2324.6625	-13.0000	-56.0287 **	-56.8802 **
3099.5500	-13.0000	-52.5491 **	-53.8778 **
3874.4375	-13.0000	-52.7340 **	-51.3084 **
4649.3250	-13.0000	-50.0475 **	-49.2535 **
5424.2125	-13.0000	-47.9859 **	-48.5594 **
6199.1000	-13.0000	-46.6507 **	-45.9883 **
6973.9875	-13.0000	-45.3237 **	-44.0388 **
7748.8750	-13.0000	-42.7945 **	-43.7297 **

**RADIATED SPURIOUS EMISSIONS**

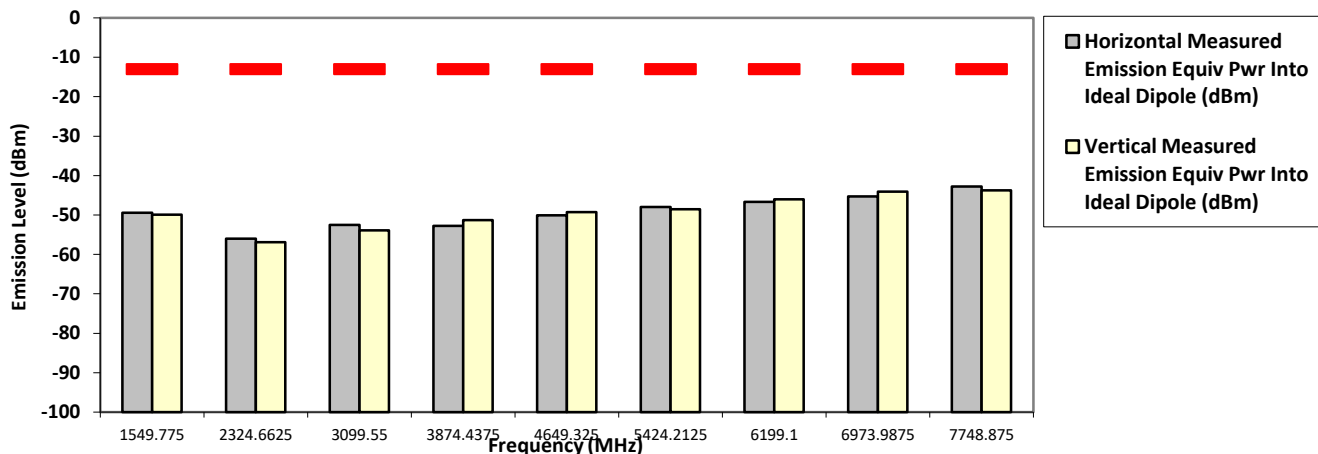

The data presented here was taken using the substitution method as found in the ANSI C63.26-2015 document.  
 Motorola Penang EMC Lab - Test Performed by: Nazrin&Qawiman      Wed, Jan 09, 2019

Remarks: \*\* Indicates the spurious emission could not be detected due to noise limitations or ambient.  
 \*Pursuant to CFR 47 Part 2.1057 ( c ), emissions attenuated more than 20 dB below the permissible limit are not reported  
 Temp(Deg): 23.6 Hum(%RH): 70.3

System MU: 5.01 dB

<b>Remarks:</b>	Passed Results	Marginal Results	Failed Results
-----------------	----------------	------------------	----------------

**SAC Transmitter Radiated Emission:**

**Model Number: H55TGT9PW8AN**      **S/N: 437TUX0086**      **SR:12464-EMC-00073**  
**Battery Part No: NNTN9089A**      **Accy Part No: NA**  
**Test Mode: TX Analog**  
**774.887500 MHz**      **12.5 kHz**      **2.990 Watt(s) /Max Power**

Frequency (MHz)	Limit	Horizontal Measured Emission Equiv Pwr Into Ideal Dipole (dBm)	Vertical Measured Emission Equiv Pwr Into ideal Dipole (dBm)
1549.7750	-13.0000	-44.5600 *	-46.5000 *
2324.6625	-13.0000	-55.2562 **	-55.4591 **
3099.5500	-13.0000	-51.1327 **	-52.8174 **
3874.4375	-13.0000	-51.6468 **	-51.1170 **
4649.3250	-13.0000	-49.7383 **	-49.5981 **
5424.2125	-13.0000	-47.6973 **	-46.3771 **
6199.1000	-13.0000	-46.6075 **	-46.1519 **
6973.9875	-13.0000	-45.3473 **	-45.1556 **
7748.8750	-13.0000	-43.4178 **	-44.1250 **

**RADIATED SPURIOUS EMISSIONS**

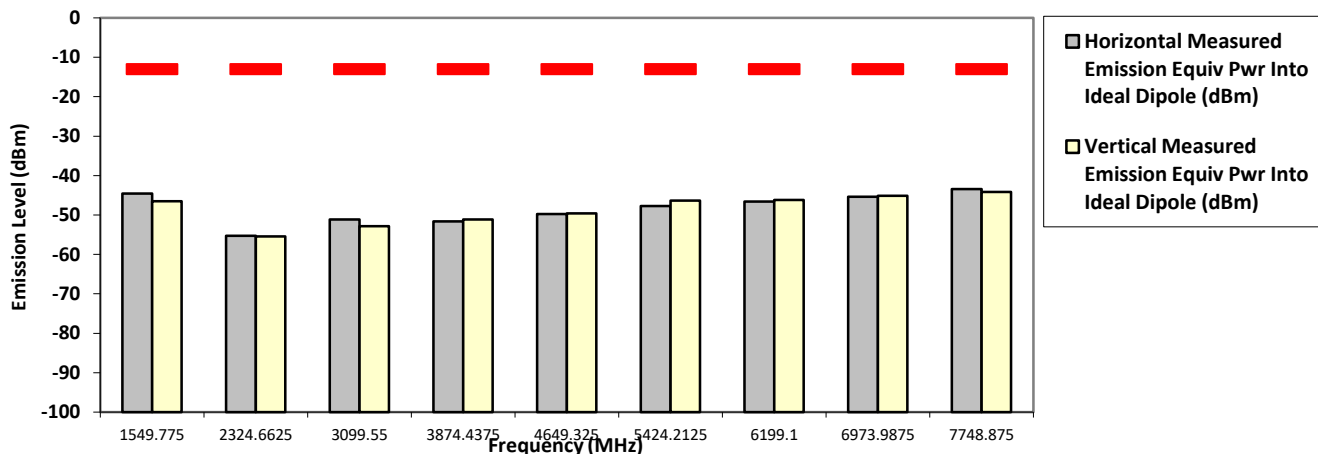

The data presented here was taken using the substitution method as found in the ANSI C63.26-2015 document.  
 Motorola Penang EMC Lab - Test Performed by: Nazrin&Qawiman      Wed, Jan 09, 2019

Remarks: \*\* Indicates the spurious emission could not be detected due to noise limitations or ambient.  
 \*Pursuant to CFR 47 Part 2.1057 ( c ), emissions attenuated more than 20 dB below the permissible limit are not reported  
 Temp(Deg): 23.6 Hum(%RH): 70.3

System MU: 5.01 dB

<b>Remarks:</b>	Passed Results	Marginal Results	Failed Results
-----------------	----------------	------------------	----------------

**SAC Transmitter Radiated Emission:**

**Model Number: H55TGT9PW8AN**      **S/N: 437TUX0086**      **SR:12464-EMC-00073**  
**Battery Part No: NNTN9089A**      **Accy Part No: NA**  
**Test Mode: TX Analog**  
**794.012500 MHz**      **12.5 kHz**      **1.000 Watt(s)/Low Power**

Frequency (MHz)	Limit	Horizontal Measured Emission Equiv Pwr Into Ideal Dipole (dBm)	Vertical Measured Emission Equiv Pwr Into ideal Dipole (dBm)
1588.0250	-13.0000	-47.2000 *	-51.4400 *
2382.0375	-13.0000	-55.5208 **	-55.7617 **
3176.0500	-13.0000	-52.4902 **	-52.6698 **
3970.0625	-13.0000	-52.1789 **	-50.9859 **
4764.0750	-13.0000	-48.3489 **	-49.3474 **
5558.0875	-13.0000	-47.3234 **	-47.7519 **
6352.1000	-13.0000	-45.5683 **	-46.2675 **
7146.1125	-13.0000	-44.9434 **	-44.3796 **
7940.1250	-13.0000	-42.7680 **	-42.7713 **

**RADIATED SPURIOUS EMISSIONS**

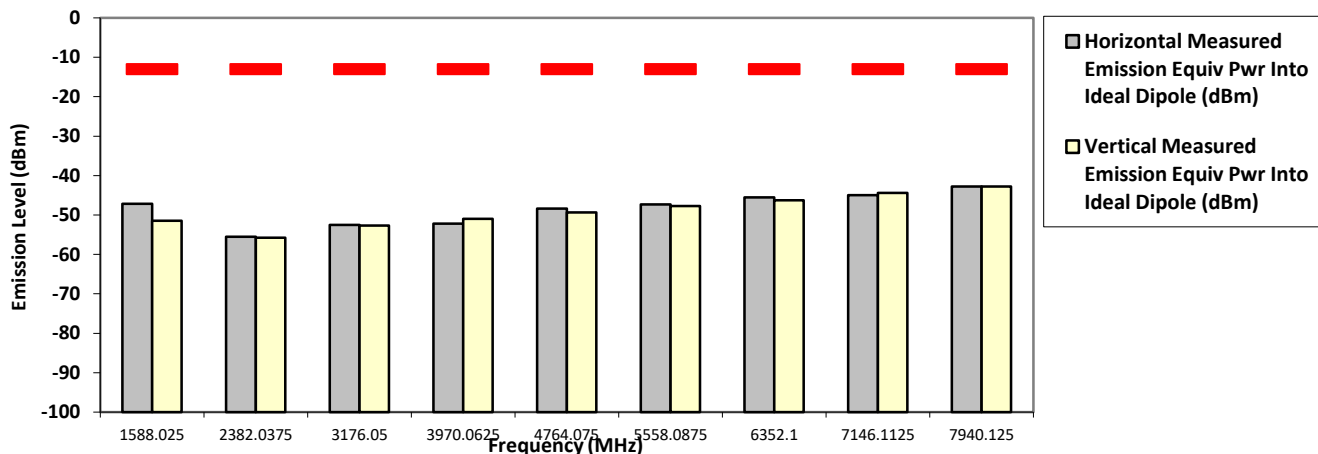

The data presented here was taken using the substitution method as found in the ANSI C63.26-2015 document.  
 Motorola Penang EMC Lab - Test Performed by: Nazrin&Qawiman      Wed, Jan 09, 2019

Remarks: \*\* Indicates the spurious emission could not be detected due to noise limitations or ambient.  
 \*Pursuant to CFR 47 Part 2.1057 ( c ), emissions attenuated more than 20 dB below the permissible limit are not reported  
 Temp(Deg): 23.6 Hum(%RH): 70.3

System MU: 5.01 dB

<b>Remarks:</b>	Passed Results	Marginal Results	Failed Results
-----------------	----------------	------------------	----------------



**SAC Transmitter Radiated Emission:**

**Model Number: H55TGT9PW8AN**      **S/N: 437TUX0086**      **SR:12464-EMC-00073**  
**Battery Part No: NNTN9089A**      **Test Mode: TX Analog**      **Accy Part No: NA**  
**794.012500 MHz**      **12.5 kHz**      **2.990 Watt(s) /Max Power**

Frequency (MHz)	Limit	Horizontal Measured Emission Equiv Pwr Into Ideal Dipole (dBm)	Vertical Measured Emission Equiv Pwr Into ideal Dipole (dBm)
1588.0250	-13.0000	-46.3500 *	-48.9200 *
2382.0375	-13.0000	-55.2755 **	-56.6642 **
3176.0500	-13.0000	-50.7309 **	-51.9804 **
3970.0625	-13.0000	-50.7351 **	-51.6334 **
4764.0750	-13.0000	-49.4043 **	-48.7118 **
5558.0875	-13.0000	-48.3713 **	-48.4952 **
6352.1000	-13.0000	-46.7239 **	-46.7211 **
7146.1125	-13.0000	-43.6657 **	-44.1534 **
7940.1250	-13.0000	-43.2462 **	-42.2079 **

**RADIATED SPURIOUS EMISSIONS**

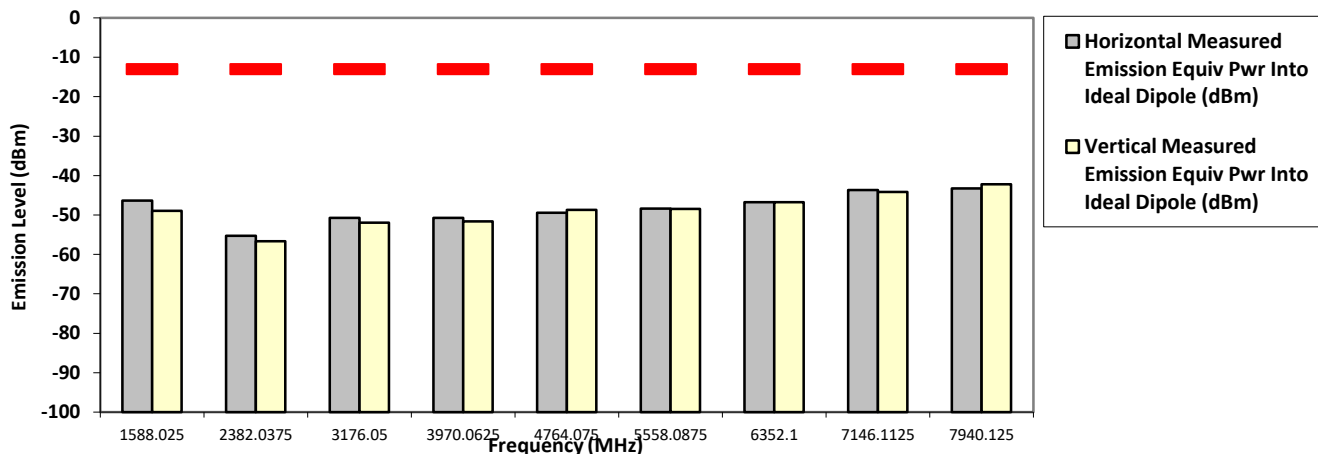

The data presented here was taken using the substitution method as found in the ANSI C63.26-2015 document.  
 Motorola Penang EMC Lab - Test Performed by: Nazrin&Qawiman      Wed, Jan 09, 2019

Remarks: \*\* Indicates the spurious emission could not be detected due to noise limitations or ambient.  
 \*Pursuant to CFR 47 Part 2.1057 ( c ), emissions attenuated more than 20 dB below the permissible limit are not reported  
 Temp(Deg): 23.6 Hum(%RH): 70.3

System MU: 5.01 dB

<b>Remarks:</b>	Passed Results	Marginal Results	Failed Results
-----------------	----------------	------------------	----------------

**SAC Transmitter Radiated Emission:**

**Model Number: H55TGT9PW8AN**      **S/N: 437TUX0086**      **SR:12464-EMC-00073**  
**Battery Part No: NNTN9089A**      **Test Mode: TX Analog**      **Accy Part No: NA**  
**799.087500 MHz**      **12.5 kHz**      **1.000 Watt(s) /Low Power**

Frequency (MHz)	Limit	Horizontal Measured Emission Equiv Pwr Into Ideal Dipole (dBm)	Vertical Measured Emission Equiv Pwr Into ideal Dipole (dBm)
1598.1750	-13.0000	-47.1900 *	-52.0100 *
2397.2625	-13.0000	-54.8368 **	-56.4993 **
3196.3500	-13.0000	-51.9135 **	-52.1921 **
3995.4375	-13.0000	-51.5467 **	-51.2700 **
4794.5250	-13.0000	-50.2151 **	-48.8812 **
5593.6125	-13.0000	-47.5170 **	-47.9247 **
6392.7000	-13.0000	-45.4363 **	-46.3522 **
7191.7875	-13.0000	-44.3517 **	-44.7998 **
7990.8750	-13.0000	-43.0904 **	-42.7749 **

**RADIATED SPURIOUS EMISSIONS**

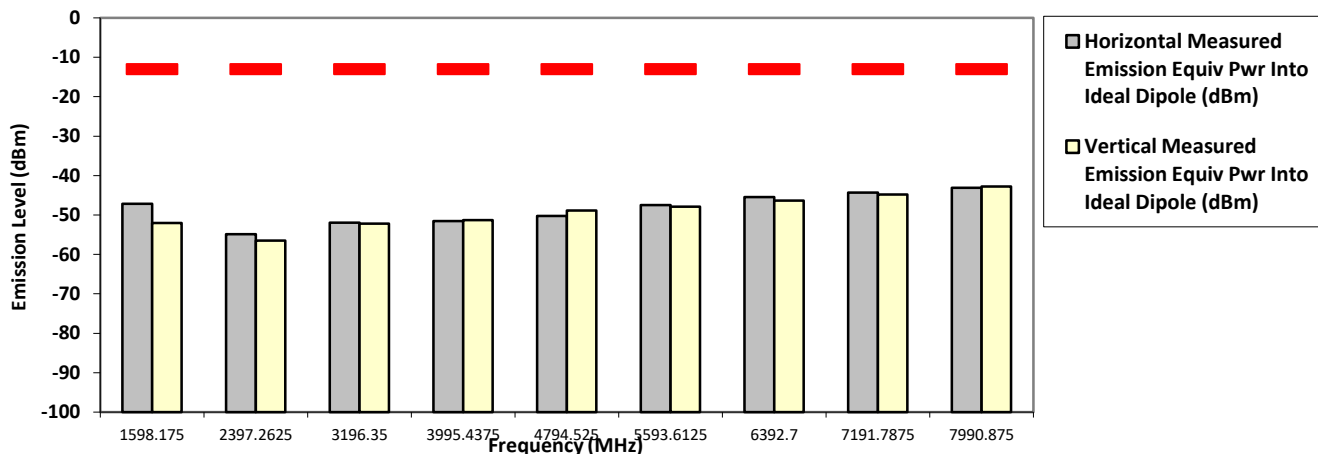

The data presented here was taken using the substitution method as found in the ANSI C63.26-2015 document.  
 Motorola Penang EMC Lab - Test Performed by: Nazrin&Qawiman      Wed, Jan 09, 2019

Remarks: \*\* Indicates the spurious emission could not be detected due to noise limitations or ambient.  
 \*Pursuant to CFR 47 Part 2.1057 ( c ), emissions attenuated more than 20 dB below the permissible limit are not reported  
 Temp(Deg): 23.6 Hum(%RH): 70.3

System MU: 5.01 dB

<b>Remarks:</b>	Passed Results	Marginal Results	Failed Results
-----------------	----------------	------------------	----------------

**SAC Transmitter Radiated Emission:**

**Model Number: H55TGT9PW8AN**      **S/N: 437TUX0086**      **SR:12464-EMC-00073**  
**Battery Part No: NNTN9089A**      **Accy Part No: NA**  
**Test Mode: TX Analog**  
**799.087500 MHz**      **12.5 kHz**      **2.990 Watt(s) /Max Power**

Frequency (MHz)	Limit	Horizontal Measured Emission Equiv Pwr Into Ideal Dipole (dBm)	Vertical Measured Emission Equiv Pwr Into ideal Dipole (dBm)
1598.1750	-13.0000	-46.7000 *	-49.9500 *
2397.2625	-13.0000	-54.0728 **	-56.0565 **
3196.3500	-13.0000	-51.1432 **	-51.7516 **
3995.4375	-13.0000	-50.6572 **	-51.9407 **
4794.5250	-13.0000	-48.4921 **	-48.3378 **
5593.6125	-13.0000	-47.7378 **	-46.8748 **
6392.7000	-13.0000	-46.1144 **	-46.5520 **
7191.7875	-13.0000	-44.6280 **	-42.3196 **
7990.8750	-13.0000	-40.5311 **	-43.5013 **

**RADIATED SPURIOUS EMISSIONS**

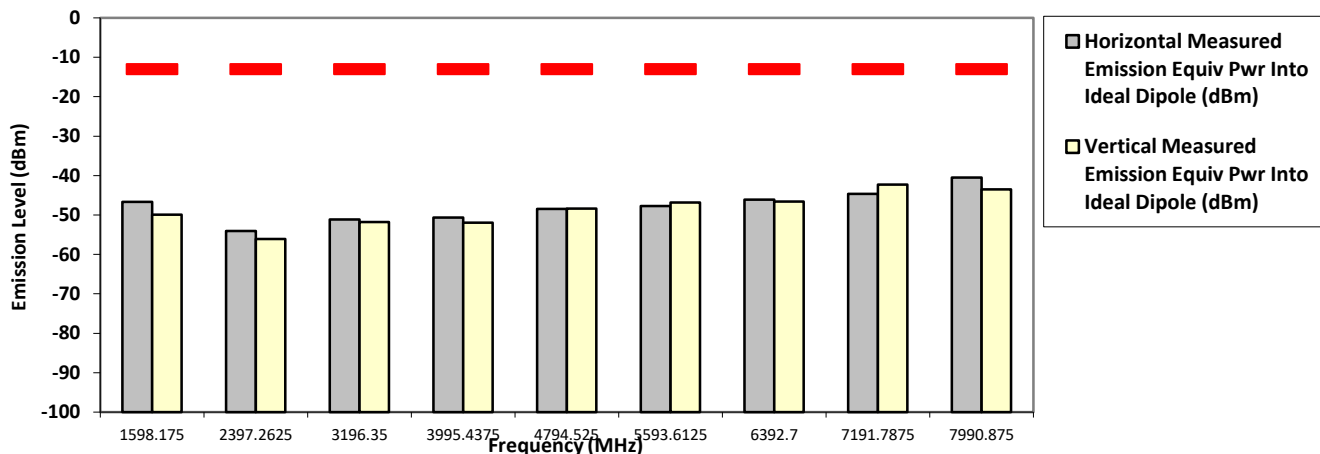

The data presented here was taken using the substitution method as found in the ANSI C63.26-2015 document.  
 Motorola Penang EMC Lab - Test Performed by: Nazrin&Qawiman      Wed, Jan 09, 2019

Remarks: \*\* Indicates the spurious emission could not be detected due to noise limitations or ambient.  
 \*Pursuant to CFR 47 Part 2.1057 ( c ), emissions attenuated more than 20 dB below the permissible limit are not reported  
 Temp(Deg): 23.6 Hum(%RH): 70.3

System MU: 5.01 dB

<b>Remarks:</b>	Passed Results	Marginal Results	Failed Results
-----------------	----------------	------------------	----------------

**SAC Transmitter Radiated Emission:**

**Model Number: H55TGT9PW8AN**      **S/N: 437TUX0086**      **SR:12464-EMC-00073**  
**Battery Part No: NNTN9089A**      **Accy Part No: NA**  
**Test Mode: TX Analog**  
**804.912500 MHz**      **12.5 kHz**      **1.000 Watt(s) /Low Power**

Frequency (MHz)	Limit	Horizontal Measured Emission Equiv Pwr Into Ideal Dipole (dBm)	Vertical Measured Emission Equiv Pwr Into ideal Dipole (dBm)
1609.8250	-13.0000	-47.6900 *	-52.1900 *
2414.7375	-13.0000	-56.4652 **	-57.2189 **
3219.6500	-13.0000	-51.8652 **	-51.9117 **
4024.5625	-13.0000	-51.4131 **	-51.0118 **
4829.4750	-13.0000	-48.9277 **	-50.0799 **
5634.3875	-13.0000	-48.6241 **	-47.8876 **
6439.3000	-13.0000	-45.1321 **	-45.9840 **
7244.2125	-13.0000	-44.3680 **	-43.9728 **
8049.1250	-13.0000	-42.6873 **	-43.4346 **

**RADIATED SPURIOUS EMISSIONS**

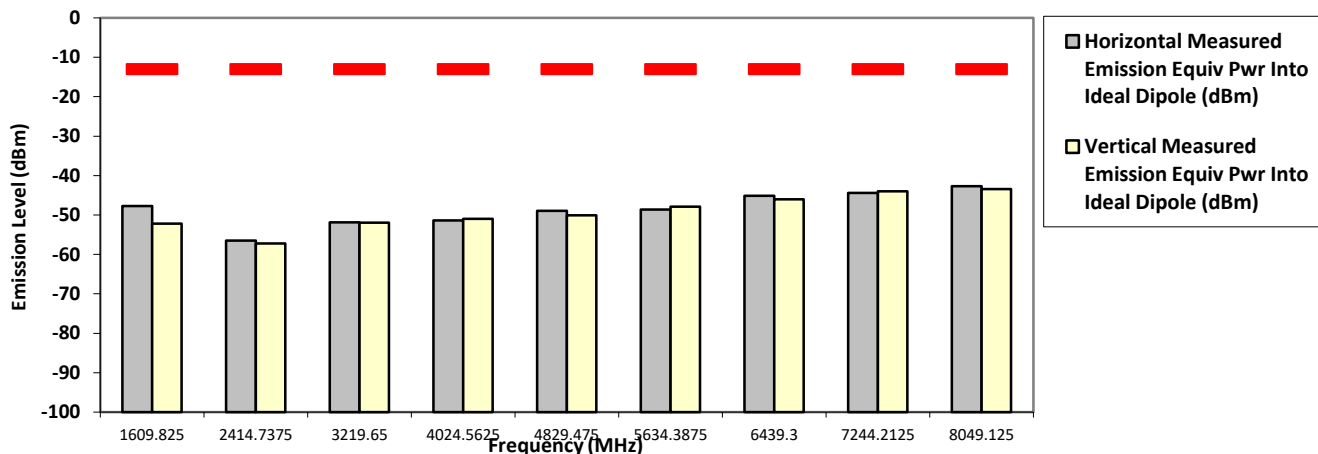

The data presented here was taken using the substitution method as found in the ANSI C63.26-2015 document.  
 Motorola Penang EMC Lab - Test Performed by: Nazrin&Qawiman      Wed, Jan 09, 2019

Remarks: \*\* Indicates the spurious emission could not be detected due to noise limitations or ambient.  
 \*Pursuant to CFR 47 Part 2.1057 ( c ), emissions attenuated more than 20 dB below the permissible limit are not reported  
 Temp(Deg): 23.6 Hum(%RH): 70.3

System MU: 5.01 dB

<b>Remarks:</b>	Passed Results	Marginal Results	Failed Results
-----------------	----------------	------------------	----------------

**SAC Transmitter Radiated Emission:**

**Model Number: H55TGT9PW8AN**      **S/N: 437TUX0086**      **SR:12464-EMC-00073**  
**Battery Part No: NNTN9089A**      **Test Mode: TX Analog**      **Accy Part No: NA**  
**804.912500 MHz**      **12.5 kHz**      **2.990 Watt(s) /Max Power**

Frequency (MHz)	Limit	Horizontal Measured Emission Equiv Pwr Into Ideal Dipole (dBm)	Vertical Measured Emission Equiv Pwr Into ideal Dipole (dBm)
1609.8250	-13.0000	-47.6900 *	-47.3300 *
2414.7375	-13.0000	-54.7842 **	-55.9615 **
3219.6500	-13.0000	-50.9118 **	-51.0256 **
4024.5625	-13.0000	-51.8309 **	-52.2054 **
4829.4750	-13.0000	-49.6358 **	-48.5698 **
5634.3875	-13.0000	-47.2571 **	-47.9923 **
6439.3000	-13.0000	-46.4118 **	-45.8914 **
7244.2125	-13.0000	-43.3590 **	-43.5486 **
8049.1250	-13.0000	-42.5544 **	-42.7086 **

**RADIATED SPURIOUS EMISSIONS**

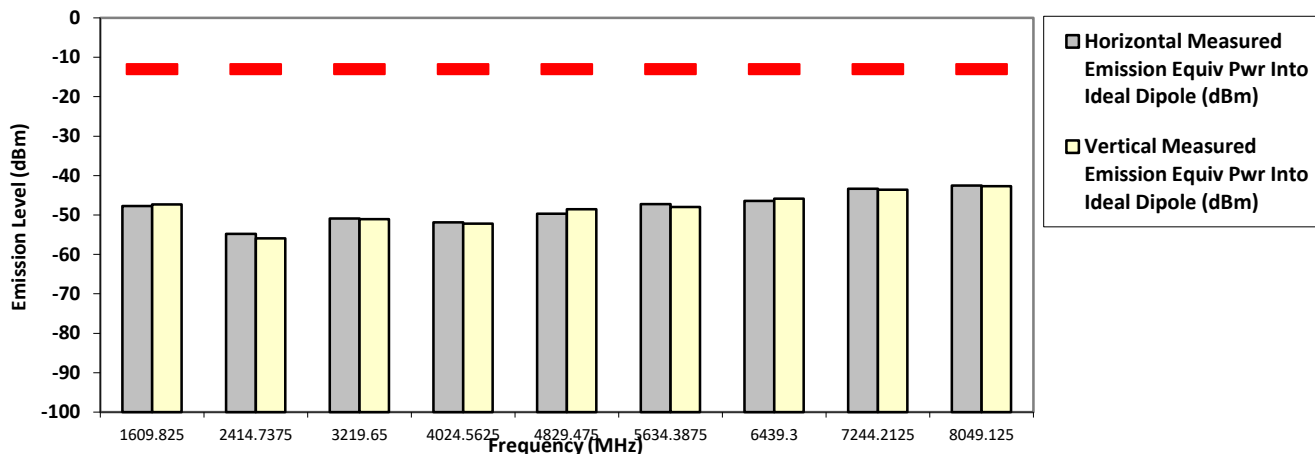

The data presented here was taken using the substitution method as found in the ANSI C63.26-2015 document.  
 Motorola Penang EMC Lab - Test Performed by: Nazrin&Qawiman      Wed, Jan 09, 2019

Remarks: \*\* Indicates the spurious emission could not be detected due to noise limitations or ambient.  
 \*Pursuant to CFR 47 Part 2.1057 ( c ), emissions attenuated more than 20 dB below the permissible limit are not reported  
 Temp(Deg): 23.6 Hum(%RH): 70.3

System MU: 5.01 dB

<b>Remarks:</b>	Passed Results	Marginal Results	Failed Results
-----------------	----------------	------------------	----------------



**SAC Transmitter Radiated Emission:**

**Model Number: H55TGT9PW8AN**      **S/N: 437TUX0086**      **SR:12464-EMC-00073**  
**Battery Part No: NNTN9089A**      **Accy Part No: NA**  
**Test Mode: TX APCO Digital C4FM**  
**762.012500 MHz**      **12.5 kHz**      **2.990 Watt(s) /Max Power**

Frequency (MHz)	Limit	Horizontal Measured Emission Equiv Pwr Into Ideal Dipole (dBm)	Vertical Measured Emission Equiv Pwr Into ideal Dipole (dBm)
1524.0250	-13.0000	-43.4700 *	-50.8800 *
2286.0375	-13.0000	-53.3661 **	-55.4655 **
3048.0500	-13.0000	-51.8905 **	-52.9512 **
3810.0625	-13.0000	-52.0786 **	-51.8277 **
4572.0750	-13.0000	-50.4522 **	-50.1766 **
5334.0875	-13.0000	-49.3205 **	-48.1856 **
6096.1000	-13.0000	-46.5760 **	-45.7585 **
6858.1125	-13.0000	-45.2984 **	-45.8330 **
7620.1250	-13.0000	-43.6474 **	-44.2750 **

**RADIATED SPURIOUS EMISSIONS**

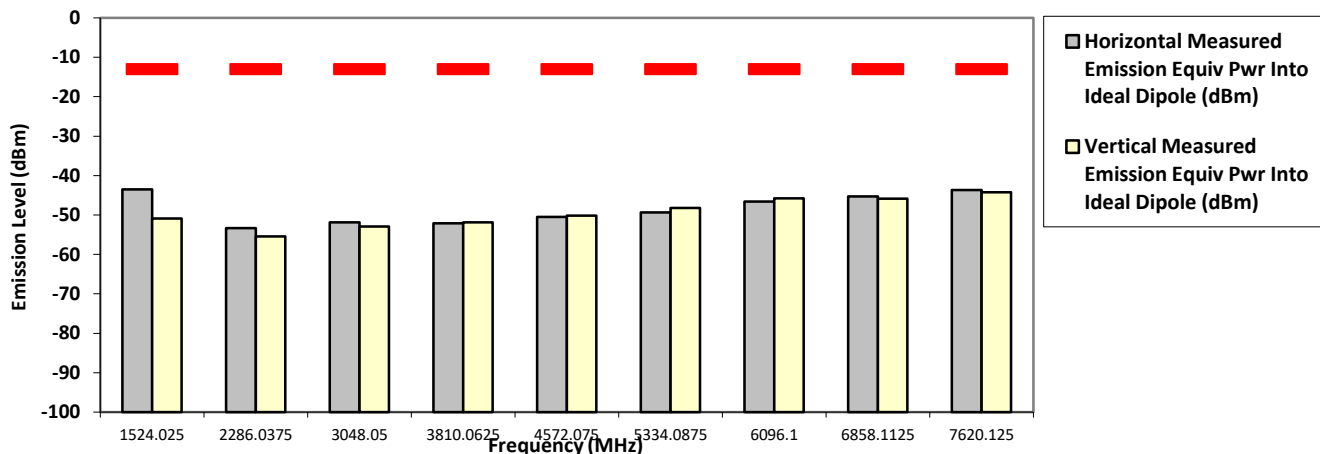

The data presented here was taken using the substitution method as found in the ANSI C63.26-2015 document.  
 Motorola Penang EMC Lab - Test Performed by: Nazrin&Qawiman      Wed, Jan 09, 2019

Remarks: \*\* Indicates the spurious emission could not be detected due to noise limitations or ambient.  
 \*Pursuant to CFR 47 Part 2.1057 ( c ), emissions attenuated more than 20 dB below the permissible limit are not reported  
 Temp(Deg): 23.6 Hum(%RH): 70.3

System MU: 5.01 dB

<b>Remarks:</b>	Passed Results	Marginal Results	Failed Results
-----------------	----------------	------------------	----------------

**SAC Transmitter Radiated Emission:**

**Model Number: H55TGT9PW8AN**      **S/N: 437TUX0086**      **SR:12464-EMC-00073**  
**Battery Part No: NNTN9089A**      **Accy Part No: NA**  
**Test Mode: TX APCO Digital C4FM**  
**769.012500 MHz**      **12.5 kHz**      **2.990 Watt(s) /Max Power**

Frequency (MHz)	Limit	Horizontal Measured Emission Equiv Pwr Into Ideal Dipole (dBm)	Vertical Measured Emission Equiv Pwr Into ideal Dipole (dBm)
1538.0250	-13.0000	-44.2600 *	-48.6600 *
2307.0375	-13.0000	-53.5275 **	-55.7719 **
3076.0500	-13.0000	-51.0633 **	-52.0871 **
3845.0625	-13.0000	-51.9893 **	-51.8981 **
4614.0750	-13.0000	-50.5152 **	-51.0029 **
5383.0875	-13.0000	-49.1867 **	-48.0152 **
6152.1000	-13.0000	-46.1930 **	-47.2529 **
6921.1125	-13.0000	-44.6915 **	-45.3174 **
7690.1250	-13.0000	-43.7987 **	-44.5966 **

**RADIATED SPURIOUS EMISSIONS**

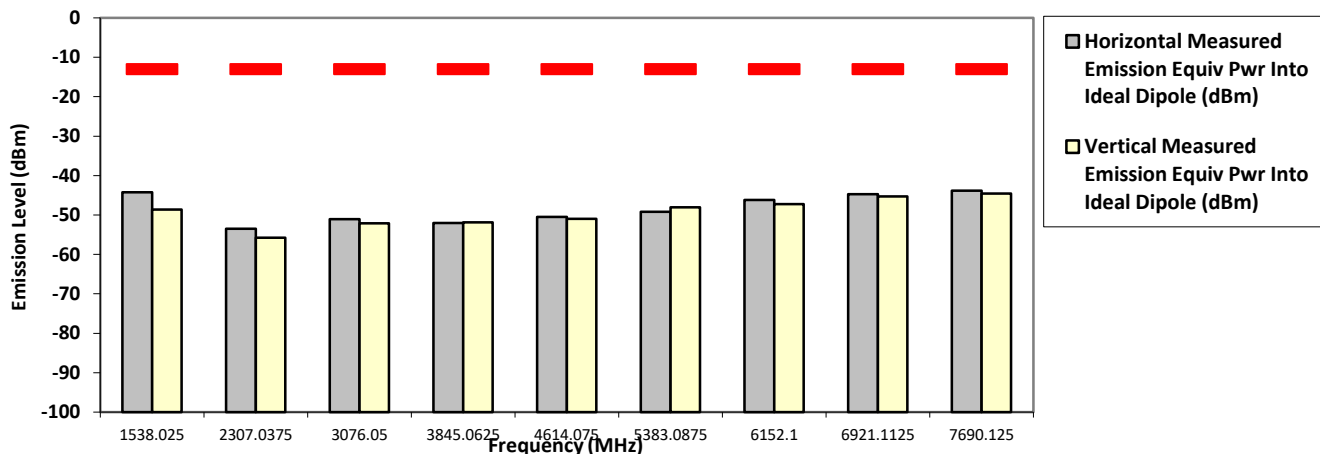

The data presented here was taken using the substitution method as found in the ANSI C63.26-2015 document.  
 Motorola Penang EMC Lab - Test Performed by: Nazrin&Qawiman      Wed, Jan 09, 2019

Remarks: \*\* Indicates the spurious emission could not be detected due to noise limitations or ambient.  
 \*Pursuant to CFR 47 Part 2.1057 ( c ), emissions attenuated more than 20 dB below the permissible limit are not reported  
 Temp(Deg): 23.6 Hum(%RH): 70.3

System MU: 5.01 dB

<b>Remarks:</b>	Passed Results	Marginal Results	Failed Results
-----------------	----------------	------------------	----------------



**SAC Transmitter Radiated Emission:**

**Model Number: H55TGT9PW8AN**      **S/N: 437TUX0086**      **SR:12464-EMC-00073**  
**Battery Part No: NNTN9089A**      **Accy Part No: NA**  
**Test Mode: TX APCO Digital C4FM**  
**769.087500 MHz**      **12.5 kHz**      **1.000 Watt(s) /Low Power**

Frequency (MHz)	Limit	Horizontal Measured Emission Equiv Pwr Into Ideal Dipole (dBm)	Vertical Measured Emission Equiv Pwr Into ideal Dipole (dBm)
1538.1750	-13.0000	-45.5900 *	-49.3000 *
2307.2625	-13.0000	-55.7322 **	-56.2758 **
3076.3500	-13.0000	-52.4741 **	-53.2612 **
3845.4375	-13.0000	-50.5604 **	-52.5619 **
4614.5250	-13.0000	-49.5282 **	-50.3702 **
5383.6125	-13.0000	-48.3282 **	-48.3089 **
6152.7000	-13.0000	-46.1908 **	-46.3717 **
6921.7875	-13.0000	-45.8095 **	-44.7862 **
7690.8750	-13.0000	-44.4907 **	-43.5077 **

**RADIATED SPURIOUS EMISSIONS**

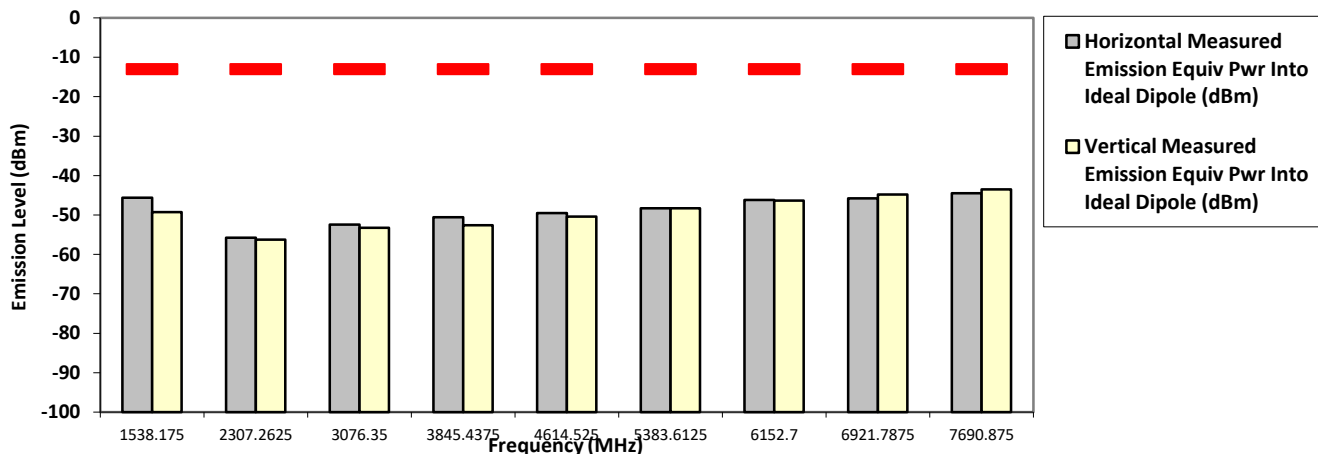

The data presented here was taken using the substitution method as found in the ANSI C63.26-2015 document.  
 Motorola Penang EMC Lab - Test Performed by: Nazrin&Qawiman      Wed, Jan 09, 2019

Remarks: \*\* Indicates the spurious emission could not be detected due to noise limitations or ambient.  
 \*Pursuant to CFR 47 Part 2.1057 ( c ), emissions attenuated more than 20 dB below the permissible limit are not reported  
 Temp(Deg): 23.6 Hum(%RH): 70.3

System MU: 5.01 dB

<b>Remarks:</b>	Passed Results	Marginal Results	Failed Results
-----------------	----------------	------------------	----------------



**SAC Transmitter Radiated Emission:**

**Model Number: H55TGT9PW8AN**      **S/N: 437TUX0086**      **SR:12464-EMC-00073**  
**Battery Part No: NNTN9089A**      **Accy Part No: NA**  
**Test Mode: TX APCO Digital C4FM**  
**774.887500 MHz**      **12.5 kHz**      **1.000 Watt(s) /Low Power**

Frequency (MHz)	Limit	Horizontal Measured Emission Equiv Pwr Into Ideal Dipole (dBm)	Vertical Measured Emission Equiv Pwr Into ideal Dipole (dBm)
1549.7750	-13.0000	-47.8900 *	-49.4000 *
2324.6625	-13.0000	-54.7755 **	-55.9402 **
3099.5500	-13.0000	-51.9342 **	-52.1304 **
3874.4375	-13.0000	-51.8376 **	-51.1626 **
4649.3250	-13.0000	-50.0874 **	-49.4108 **
5424.2125	-13.0000	-47.6441 **	-48.4276 **
6199.1000	-13.0000	-46.4385 **	-46.6377 **
6973.9875	-13.0000	-44.9550 **	-44.8164 **
7748.8750	-13.0000	-43.9511 **	-44.1997 **

**RADIATED SPURIOUS EMISSIONS**

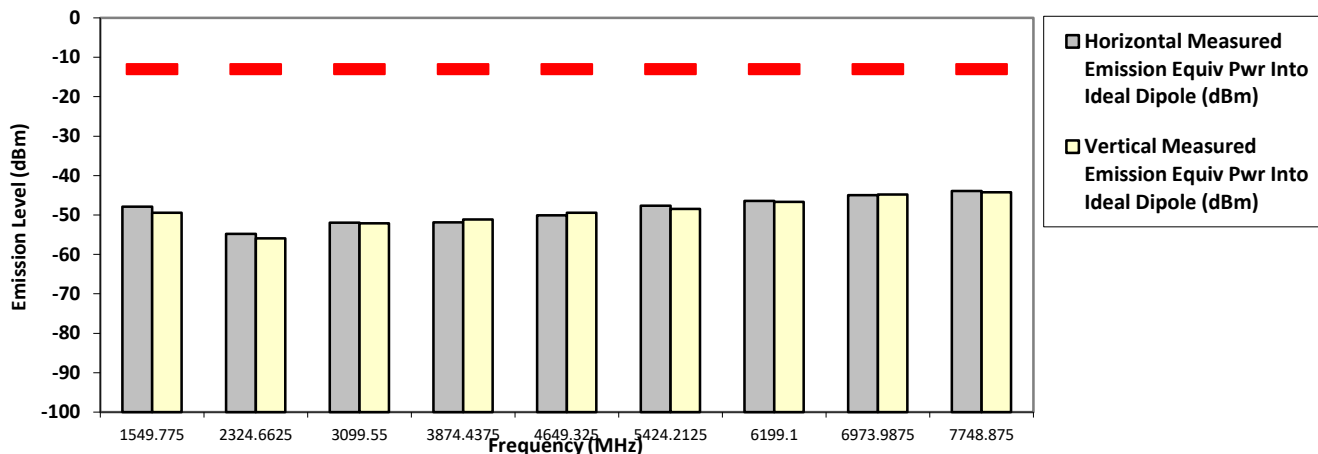

The data presented here was taken using the substitution method as found in the ANSI C63.26-2015 document.  
 Motorola Penang EMC Lab - Test Performed by: Nazrin&Qawiman      Wed, Jan 09, 2019

Remarks: \*\* Indicates the spurious emission could not be detected due to noise limitations or ambient.  
 \*Pursuant to CFR 47 Part 2.1057 ( c ), emissions attenuated more than 20 dB below the permissible limit are not reported  
 Temp(Deg): 23.6 Hum(%RH): 70.3

System MU: 5.01 dB

<b>Remarks:</b>	Passed Results	Marginal Results	Failed Results
-----------------	----------------	------------------	----------------

**SAC Transmitter Radiated Emission:**

**Model Number: H55TGT9PW8AN**      **S/N: 437TUX0086**      **SR:12464-EMC-00073**  
**Battery Part No: NNTN9089A**      **Accy Part No: NA**  
**Test Mode: TX APCO Digital C4FM**  
**774.887500 MHz**      **12.5 kHz**      **2.990 Watt(s) /Max Power**

Frequency (MHz)	Limit	Horizontal Measured Emission Equiv Pwr Into Ideal Dipole (dBm)	Vertical Measured Emission Equiv Pwr Into ideal Dipole (dBm)
1549.7750	-13.0000	-45.5700 *	-47.4300 *
2324.6625	-13.0000	-53.3974 **	-56.3180 **
3099.5500	-13.0000	-51.4204 **	-52.2925 **
3874.4375	-13.0000	-51.3725 **	-51.7967 **
4649.3250	-13.0000	-50.0060 **	-48.8884 **
5424.2125	-13.0000	-47.9947 **	-47.7278 **
6199.1000	-13.0000	-46.7356 **	-46.5116 **
6973.9875	-13.0000	-44.7340 **	-44.3317 **
7748.8750	-13.0000	-43.6385 **	-44.1331 **

**RADIATED SPURIOUS EMISSIONS**

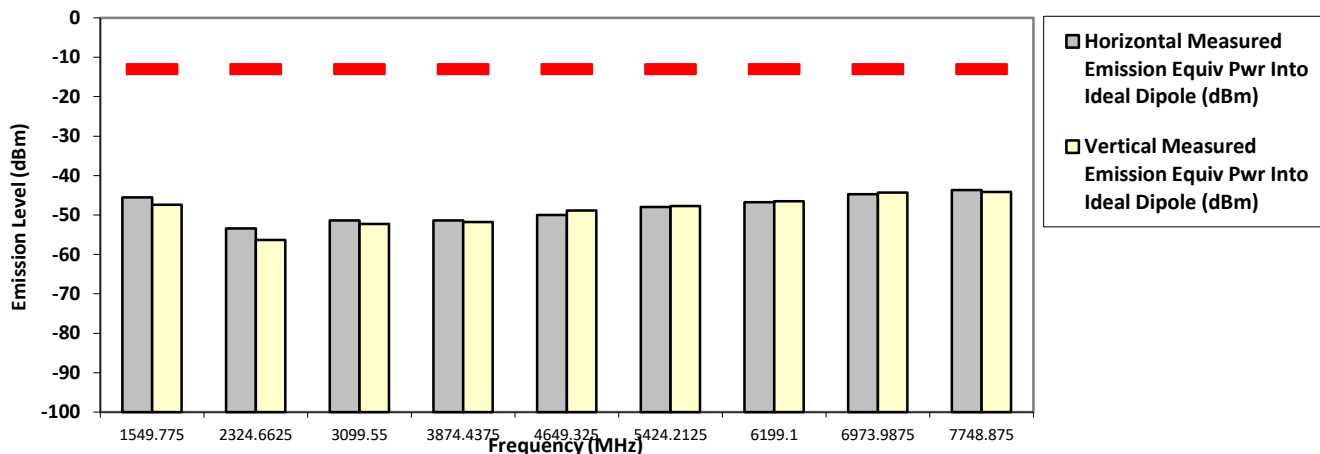

The data presented here was taken using the substitution method as found in the ANSI C63.26-2015 document.  
 Motorola Penang EMC Lab - Test Performed by: Nazrin&Qawiman      Wed, Jan 09, 2019

Remarks: \*\* Indicates the spurious emission could not be detected due to noise limitations or ambient.  
 \*Pursuant to CFR 47 Part 2.1057 ( c ), emissions attenuated more than 20 dB below the permissible limit are not reported  
 Temp(Deg): 23.6 Hum(%RH): 70.3

System MU: 5.01 dB

<b>Remarks:</b>	Passed Results	Marginal Results	Failed Results
-----------------	----------------	------------------	----------------

**SAC Transmitter Radiated Emission:**

**Model Number: H55TGT9PW8AN**      **S/N: 437TUX0086**      **SR:12464-EMC-00073**  
**Battery Part No: NNTN9089A**      **Accy Part No: NA**  
**Test Mode: TX APCO Digital C4FM**  
**794.012500 MHz**      **12.5 kHz**      **1.000 Watt(s) /Low Power**

Frequency (MHz)	Limit	Horizontal Measured Emission Equiv Pwr Into Ideal Dipole (dBm)	Vertical Measured Emission Equiv Pwr Into ideal Dipole (dBm)
1588.0250	-13.0000	-46.1300 *	-51.7200 *
2382.0375	-13.0000	-55.1918 **	-56.4613 **
3176.0500	-13.0000	-51.9874 **	-51.8605 **
3970.0625	-13.0000	-52.3553 **	-51.2799 **
4764.0750	-13.0000	-49.8666 **	-49.4363 **
5558.0875	-13.0000	-47.9745 **	-48.4587 **
6352.1000	-13.0000	-45.6907 **	-47.2521 **
7146.1125	-13.0000	-43.7510 **	-43.9034 **
7940.1250	-13.0000	-42.1889 **	-42.9158 **

**RADIATED SPURIOUS EMISSIONS**

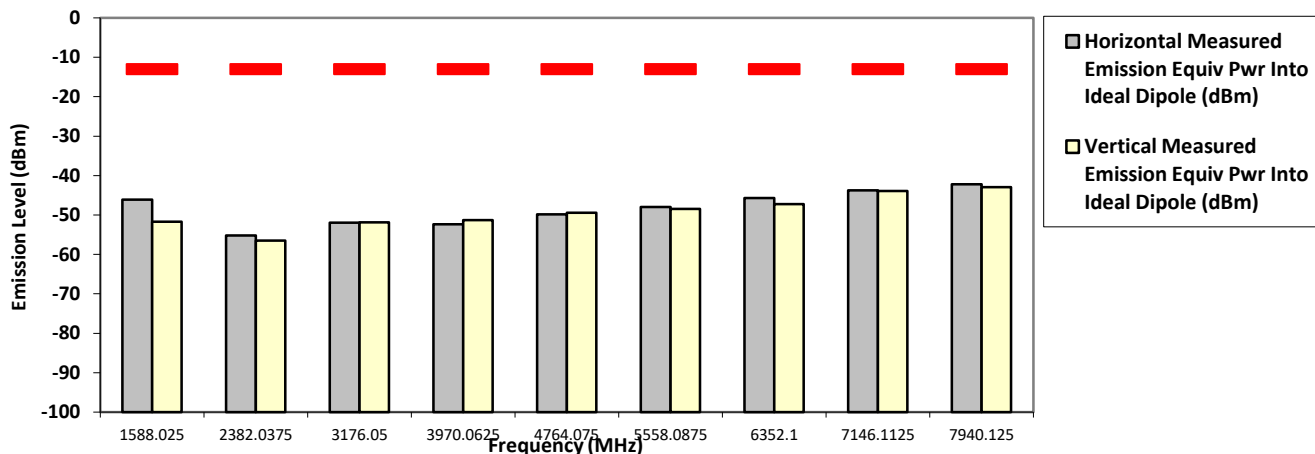

The data presented here was taken using the substitution method as found in the ANSI C63.26-2015 document.  
 Motorola Penang EMC Lab - Test Performed by: Nazrin&Qawiman      Wed, Jan 09, 2019

Remarks: \*\* Indicates the spurious emission could not be detected due to noise limitations or ambient.  
 \*Pursuant to CFR 47 Part 2.1057 ( c ), emissions attenuated more than 20 dB below the permissible limit are not reported  
 Temp(Deg): 23.6 Hum(%RH): 70.3

System MU: 5.01 dB

<b>Remarks:</b>	Passed Results	Marginal Results	Failed Results
-----------------	----------------	------------------	----------------

**SAC Transmitter Radiated Emission:**

**Model Number: H55TGT9PW8AN**      **S/N: 437TUX0086**      **SR:12464-EMC-00073**  
**Battery Part No: NNTN9089A**      **Accy Part No: NA**  
**Test Mode: TX APCO Digital C4FM**  
**794.012500 MHz**      **12.5 kHz**      **2.990 Watt(s) /Max Power**

Frequency (MHz)	Limit	Horizontal Measured Emission Equiv Pwr Into Ideal Dipole (dBm)	Vertical Measured Emission Equiv Pwr Into ideal Dipole (dBm)
1588.0250	-13.0000	-42.4300 *	-50.0400 *
2382.0375	-13.0000	-55.3837 **	-54.2188 **
3176.0500	-13.0000	-50.7366 **	-51.4534 **
3970.0625	-13.0000	-51.2030 **	-51.7812 **
4764.0750	-13.0000	-49.5843 **	-47.7927 **
5558.0875	-13.0000	-48.3010 **	-48.6095 **
6352.1000	-13.0000	-47.3323 **	-46.5509 **
7146.1125	-13.0000	-44.2617 **	-44.5320 **
7940.1250	-13.0000	-43.0774 **	-43.2548 **

**RADIATED SPURIOUS EMISSIONS**

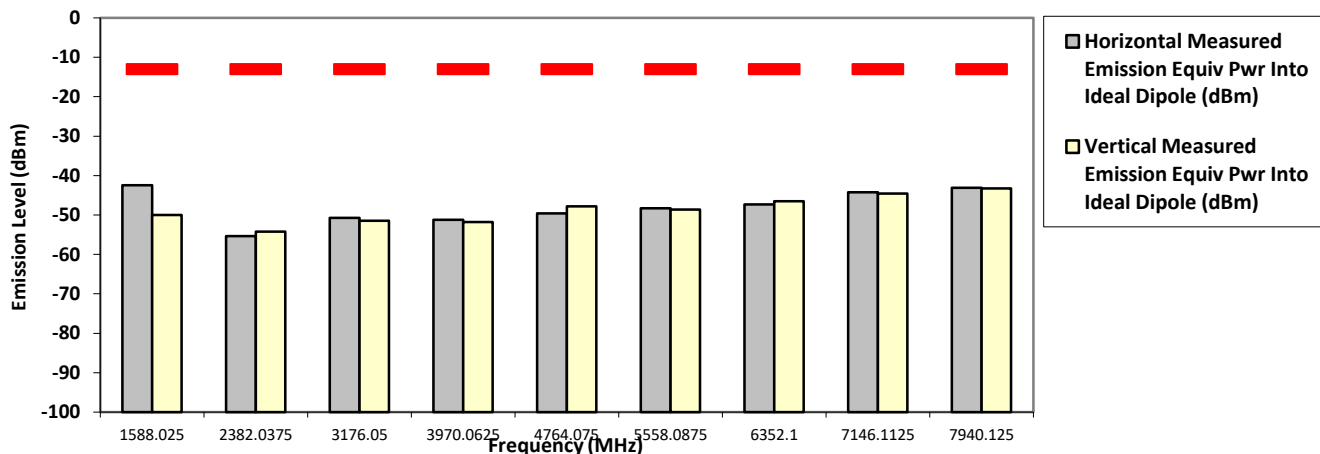

The data presented here was taken using the substitution method as found in the ANSI C63.26-2015 document.  
 Motorola Penang EMC Lab - Test Performed by: Nazrin&Qawiman      Wed, Jan 09, 2019

Remarks: \*\* Indicates the spurious emission could not be detected due to noise limitations or ambient.  
 \*Pursuant to CFR 47 Part 2.1057 ( c ), emissions attenuated more than 20 dB below the permissible limit are not reported  
 Temp(Deg): 23.6 Hum(%RH): 70.3

System MU: 5.01 dB

<b>Remarks:</b>	Passed Results	Marginal Results	Failed Results
-----------------	----------------	------------------	----------------



**SAC Transmitter Radiated Emission:**

**Model Number: H55TGT9PW8AN**      **S/N: 437TUX0086**      **SR:12464-EMC-00073**  
**Battery Part No: NNTN9089A**      **Accy Part No: NA**  
**Test Mode: TX APCO Digital C4FM**  
**799.087500 MHz**      **12.5 kHz**      **2.990 Watt(s) /Max Power**

Frequency (MHz)	Limit	Horizontal Measured Emission Equiv Pwr Into Ideal Dipole (dBm)	Vertical Measured Emission Equiv Pwr Into ideal Dipole (dBm)
1598.1750	-13.0000	-45.2900 *	-50.9800 *
2397.2625	-13.0000	-55.4369 **	-55.9626 **
3196.3500	-13.0000	-49.7783 **	-50.0922 **
3995.4375	-13.0000	-52.5493 **	-52.0092 **
4794.5250	-13.0000	-49.5120 **	-49.5202 **
5593.6125	-13.0000	-48.3373 **	-48.5005 **
6392.7000	-13.0000	-46.8710 **	-46.8148 **
7191.7875	-13.0000	-44.7477 **	-43.7032 **
7990.8750	-13.0000	-43.7104 **	-42.4986 **

**RADIATED SPURIOUS EMISSIONS**

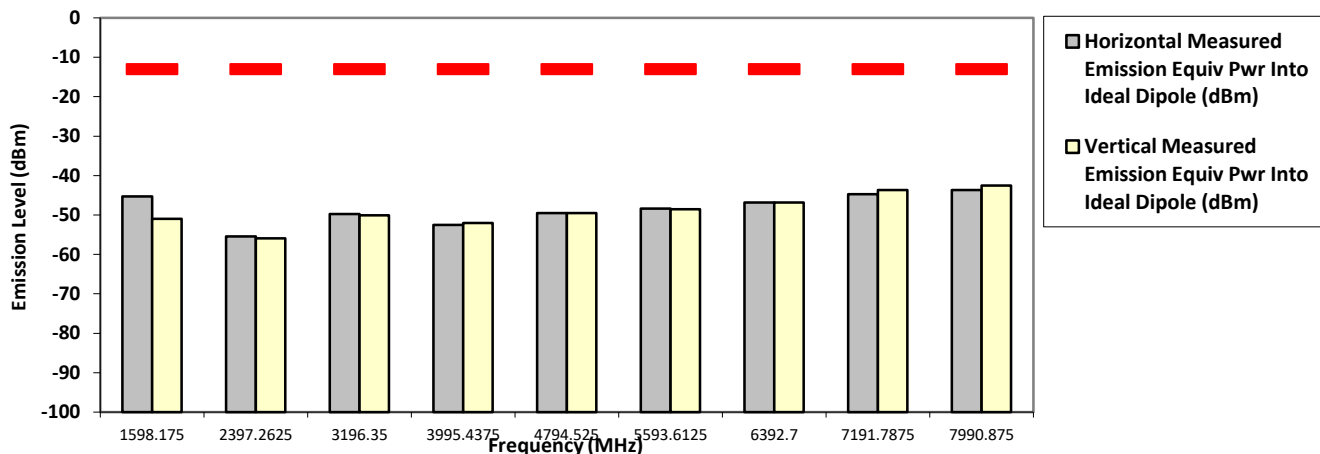

The data presented here was taken using the substitution method as found in the ANSI C63.26-2015 document.  
 Motorola Penang EMC Lab - Test Performed by: Nazrin&Qawiman      Wed, Jan 09, 2019

Remarks: \*\* Indicates the spurious emission could not be detected due to noise limitations or ambient.  
 \*Pursuant to CFR 47 Part 2.1057 ( c ), emissions attenuated more than 20 dB below the permissible limit are not reported  
 Temp(Deg): 23.6 Hum(%RH): 70.3

System MU: 5.01 dB

<b>Remarks:</b>	Passed Results	Marginal Results	Failed Results
-----------------	----------------	------------------	----------------



**SAC Transmitter Radiated Emission:**

**Model Number: H55TGT9PW8AN**      **S/N: 437TUX0086**      **SR:12464-EMC-00073**  
**Battery Part No: NNTN9089A**      **Accy Part No: NA**  
**Test Mode: TX APCO Digital C4FM**  
**804.912500 MHz**      **12.5 kHz**      **1.000 Watt(s) /Low Power**

Frequency (MHz)	Limit	Horizontal Measured Emission Equiv Pwr Into Ideal Dipole (dBm)	Vertical Measured Emission Equiv Pwr Into ideal Dipole (dBm)
1609.8250	-13.0000	-46.0300 *	-51.8200 *
2414.7375	-13.0000	-56.1705 **	-56.0081 **
3219.6500	-13.0000	-51.1119 **	-52.3983 **
4024.5625	-13.0000	-52.0573 **	-52.0339 **
4829.4750	-13.0000	-50.4794 **	-49.8417 **
5634.3875	-13.0000	-49.5176 **	-49.0779 **
6439.3000	-13.0000	-46.7472 **	-47.6984 **
7244.2125	-13.0000	-44.0247 **	-44.3629 **
8049.1250	-13.0000	-43.4636 **	-44.1560 **

**RADIATED SPURIOUS EMISSIONS**

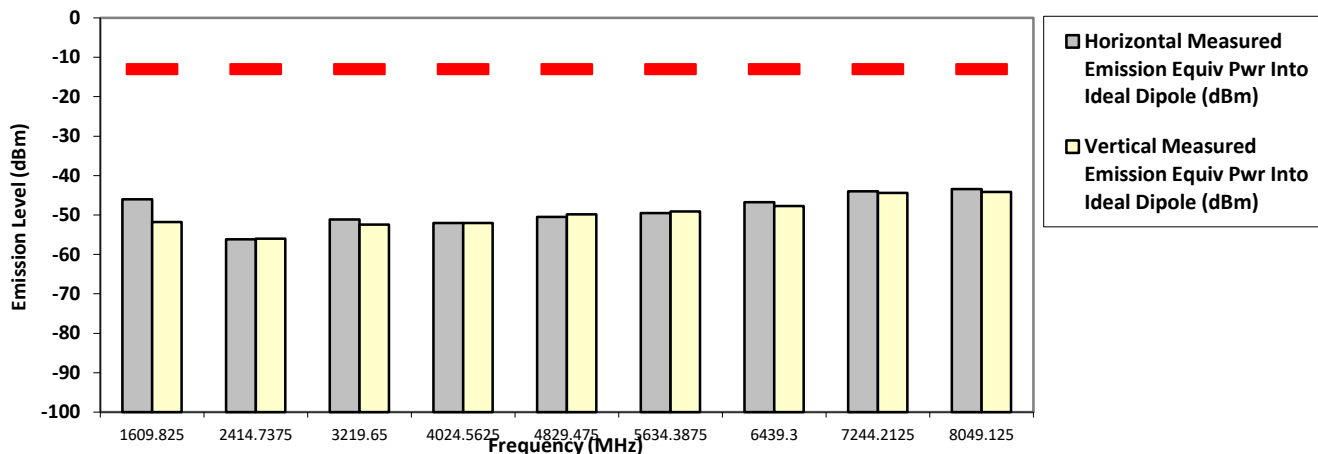

The data presented here was taken using the substitution method as found in the ANSI C63.26-2015 document.  
 Motorola Penang EMC Lab - Test Performed by: Nazrin&Qawiman      Wed, Jan 09, 2019

Remarks: \*\* Indicates the spurious emission could not be detected due to noise limitations or ambient.  
 \*Pursuant to CFR 47 Part 2.1057 ( c ), emissions attenuated more than 20 dB below the permissible limit are not reported  
 Temp(Deg): 23.6 Hum(%RH): 70.3

System MU: 5.01 dB

<b>Remarks:</b>	Passed Results	Marginal Results	Failed Results
-----------------	----------------	------------------	----------------

**SAC Transmitter Radiated Emission:**

**Model Number: H55TGT9PW8AN**      **S/N: 437TUX0086**      **SR:12464-EMC-00073**  
**Battery Part No: NNTN9089A**      **Accy Part No: NA**  
**Test Mode: TX APCO Digital C4FM**  
**804.912500 MHz**      **12.5 kHz**      **2.990 Watt(s) /Max Power**

Frequency (MHz)	Limit	Horizontal Measured Emission Equiv Pwr Into Ideal Dipole (dBm)	Vertical Measured Emission Equiv Pwr Into ideal Dipole (dBm)
1609.8250	-13.0000	-42.9900 *	-49.1800 *
2414.7375	-13.0000	-55.2875 **	-56.1963 **
3219.6500	-13.0000	-50.1097 **	-50.9467 **
4024.5625	-13.0000	-52.1195 **	-51.9585 **
4829.4750	-13.0000	-49.6424 **	-50.1903 **
5634.3875	-13.0000	-48.3018 **	-49.2474 **
6439.3000	-13.0000	-47.4758 **	-46.7856 **
7244.2125	-13.0000	-44.1893 **	-44.4473 **
8049.1250	-13.0000	-43.4199 **	-42.4452 **

**RADIATED SPURIOUS EMISSIONS**

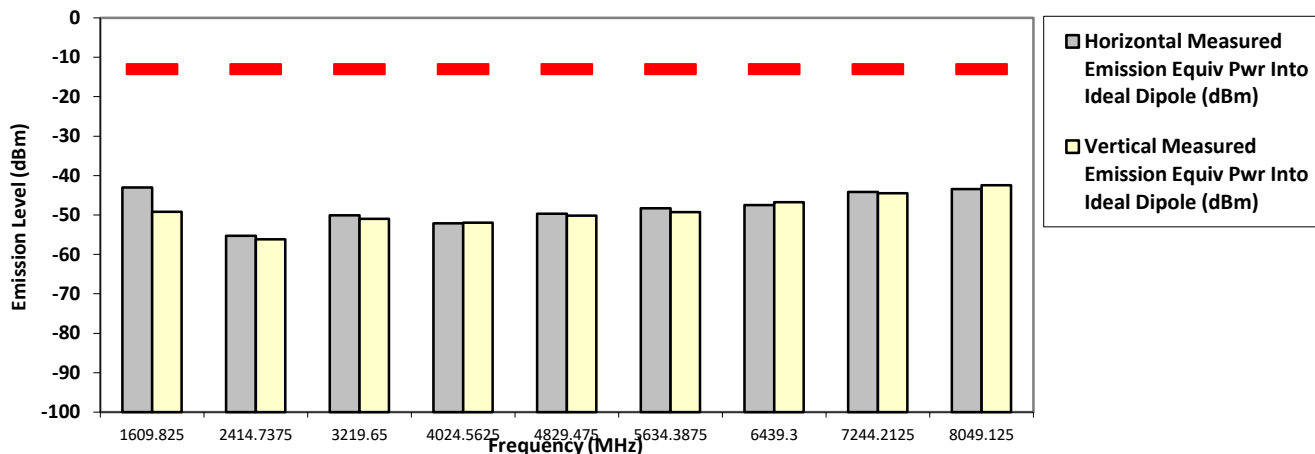

The data presented here was taken using the substitution method as found in the ANSI C63.26-2015 document.  
 Motorola Penang EMC Lab - Test Performed by: Nazrin&Qawiman      Wed, Jan 09, 2019

Remarks: \*\* Indicates the spurious emission could not be detected due to noise limitations or ambient.  
 \*Pursuant to CFR 47 Part 2.1057 ( c ), emissions attenuated more than 20 dB below the permissible limit are not reported  
 Temp(Deg): 23.6 Hum(%RH): 70.3

System MU: 5.01 dB

<b>Remarks:</b>	Passed Results	Marginal Results	Failed Results
-----------------	----------------	------------------	----------------



**SAC Transmitter Radiated Emission:**

**Model Number: H55TGT9PW8AN**      **S/N: 437TUX0086**      **SR:12464-EMC-00073**  
**Battery Part No: NNTN9089A**      **Accy Part No: NA**  
**Test Mode: TX APCO Digital Phase II**  
**762.012500 MHz**      **12.5 kHz**      **2.990 Watt(s) /Max Power**

Frequency (MHz)	Limit	Horizontal Measured Emission Equiv Pwr Into Ideal Dipole (dBm)	Vertical Measured Emission Equiv Pwr Into ideal Dipole (dBm)
1524.0250	-13.0000	-44.5900 *	-52.2900 *
2286.0375	-13.0000	-54.9257 **	-57.8724 **
3048.0500	-13.0000	-50.3440 **	-52.7271 **
3810.0625	-13.0000	-53.1418 **	-51.0021 **
4572.0750	-13.0000	-50.3906 **	-51.2289 **
5334.0875	-13.0000	-48.7783 **	-46.7004 **
6096.1000	-13.0000	-46.0108 **	-47.3837 **
6858.1125	-13.0000	-45.1433 **	-46.0327 **
7620.1250	-13.0000	-43.3251 **	-42.9644 **

**RADIATED SPURIOUS EMISSIONS**

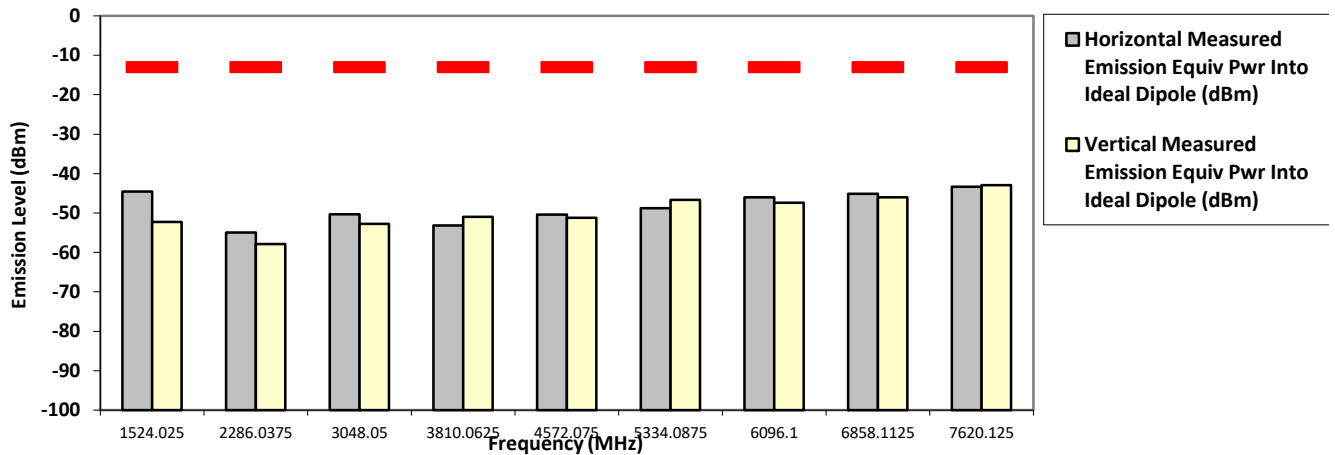

The data presented here was taken using the substitution method as found in the ANSI C63.26-2015 document.  
 Motorola Penang EMC Lab - Test Performed by: Nazrin&Qawiman      Wed, Jan 09, 2019

Remarks: \*\* Indicates the spurious emission could not be detected due to noise limitations or ambient.  
 \*Pursuant to CFR 47 Part 2.1057 ( c ), emissions attenuated more than 20 dB below the permissible limit are not reported  
 Temp(Deg): 23.6 Hum(%RH): 70.3

System MU: 5.01 dB

<b>Remarks:</b>	Passed Results	Marginal Results	Failed Results
-----------------	----------------	------------------	----------------

**SAC Transmitter Radiated Emission:**

**Model Number: H55TGT9PW8AN**      **S/N: 437TUX0086**      **SR:12464-EMC-00073**  
**Battery Part No: NNTN9089A**      **Accy Part No: NA**  
**Test Mode: TX APCO Digital Phase II**  
**769.012500 MHz**      **12.5 kHz**      **2.990 Watt(s) /Max Power**

Frequency (MHz)	Limit	Horizontal Measured Emission Equiv Pwr Into Ideal Dipole (dBm)	Vertical Measured Emission Equiv Pwr Into ideal Dipole (dBm)
1538.0250	-13.0000	-43.6900 *	-48.5500 *
2307.0375	-13.0000	-53.4744 **	-57.1125 **
3076.0500	-13.0000	-51.8946 **	-52.1750 **
3845.0625	-13.0000	-51.3252 **	-50.7512 **
4614.0750	-13.0000	-50.0057 **	-50.2061 **
5383.0875	-13.0000	-47.2752 **	-48.1498 **
6152.1000	-13.0000	-46.4979 **	-47.0046 **
6921.1125	-13.0000	-45.8099 **	-45.0227 **
7690.1250	-13.0000	-43.5231 **	-43.8357 **

**RADIATED SPURIOUS EMISSIONS**

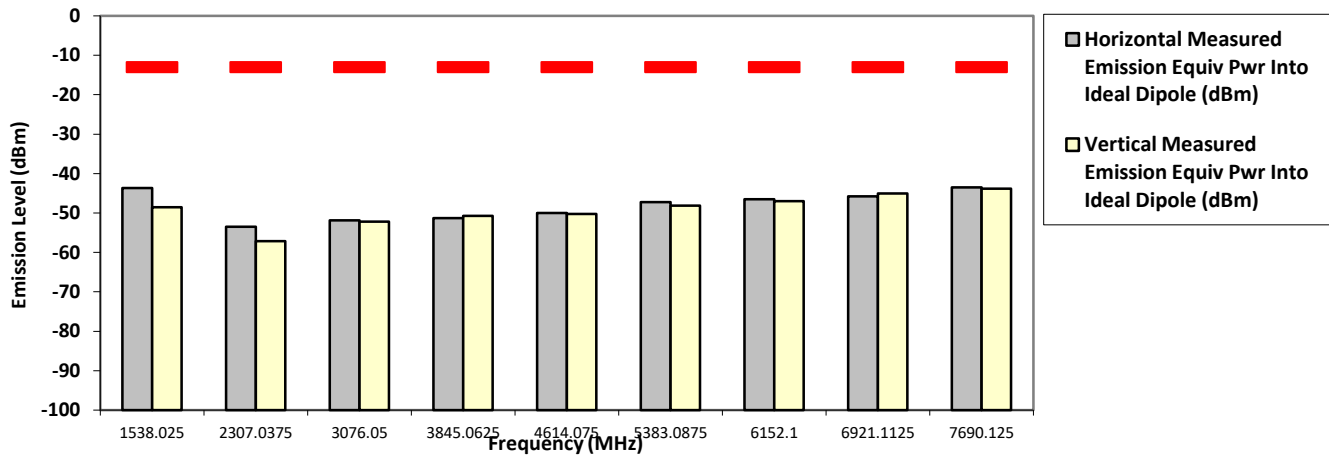

The data presented here was taken using the substitution method as found in the ANSI C63.26-2015 document.  
 Motorola Penang EMC Lab - Test Performed by: Nazrin&Qawiman      Wed, Jan 09, 2019

Remarks: \*\* Indicates the spurious emission could not be detected due to noise limitations or ambient.  
 \*Pursuant to CFR 47 Part 2.1057 ( c ), emissions attenuated more than 20 dB below the permissible limit are not reported  
 Temp(Deg): 23.6 Hum(%RH): 70.3

System MU: 5.01 dB

<b>Remarks:</b>	Passed Results	Marginal Results	Failed Results
-----------------	----------------	------------------	----------------









**SAC Transmitter Radiated Emission:**

**Model Number: H55TGT9PW8AN**      **S/N: 437TUX0086**      **SR:12464-EMC-00073**  
**Battery Part No: NNTN9089A**      **Accy Part No: NA**  
**Test Mode: TX APCO Digital Phase II**  
**774.887500 MHz**      **12.5 kHz**      **2.990 Watt(s) /Max Power**

Frequency (MHz)	Limit	Horizontal Measured Emission Equiv Pwr Into Ideal Dipole (dBm)	Vertical Measured Emission Equiv Pwr Into ideal Dipole (dBm)
1549.7750	-13.0000	-43.4300 *	-51.7100 *
2324.6625	-13.0000	-54.5303 **	-56.6441 **
3099.5500	-13.0000	-51.6599 **	-52.4960 **
3874.4375	-13.0000	-50.5950 **	-51.5989 **
4649.3250	-13.0000	-48.9576 **	-49.3479 **
5424.2125	-13.0000	-48.3778 **	-48.1704 **
6199.1000	-13.0000	-47.0600 **	-46.8936 **
6973.9875	-13.0000	-45.1379 **	-44.5404 **
7748.8750	-13.0000	-42.2268 **	-43.0258 **

**RADIATED SPURIOUS EMISSIONS**

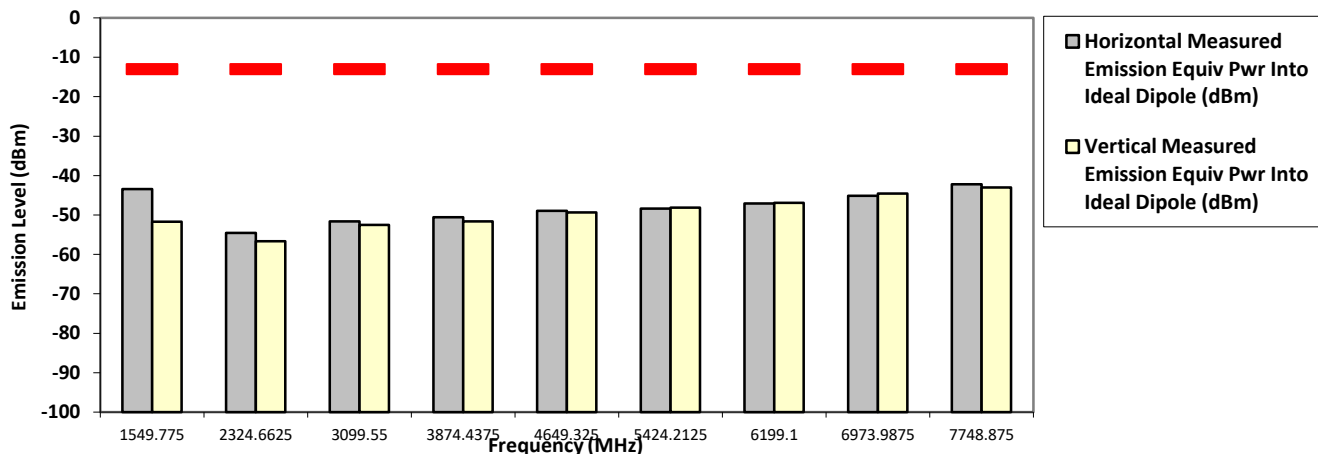

The data presented here was taken using the substitution method as found in the ANSI C63.26-2015 document.  
 Motorola Penang EMC Lab - Test Performed by: Nazrin&Qawiman      Thu, Jan 10, 2019

Remarks: \*\* Indicates the spurious emission could not be detected due to noise limitations or ambient.  
 \*Pursuant to CFR 47 Part 2.1057 ( c ), emissions attenuated more than 20 dB below the permissible limit are not reported  
 Temp(Deg): 23.6 Hum(%RH): 70.3

System MU: 5.01 dB

<b>Remarks:</b>	Passed Results	Marginal Results	Failed Results
-----------------	----------------	------------------	----------------

**SAC Transmitter Radiated Emission:**

**Model Number: H55TGT9PW8AN**      **S/N: 437TUX0086**      **SR:12464-EMC-00073**  
**Battery Part No: NNTN9089A**      **Accy Part No: NA**  
**Test Mode: TX APCO Digital Phase II**  
**794.012500 MHz**      **12.5 kHz**      **1.000 Watt(s) /Low Power**

Frequency (MHz)	Limit	Horizontal Measured Emission Equiv Pwr Into Ideal Dipole (dBm)	Vertical Measured Emission Equiv Pwr Into ideal Dipole (dBm)
1588.0250	-13.0000	-49.6500 *	-53.1000 *
2382.0375	-13.0000	-56.9502 **	-56.8842 **
3176.0500	-13.0000	-52.4554 **	-53.1207 **
3970.0625	-13.0000	-51.8554 **	-51.3038 **
4764.0750	-13.0000	-49.0901 **	-49.5459 **
5558.0875	-13.0000	-47.4403 **	-46.6918 **
6352.1000	-13.0000	-46.2254 **	-46.7692 **
7146.1125	-13.0000	-42.9779 **	-43.8421 **
7940.1250	-13.0000	-42.1665 **	-42.8694 **

**RADIATED SPURIOUS EMISSIONS**

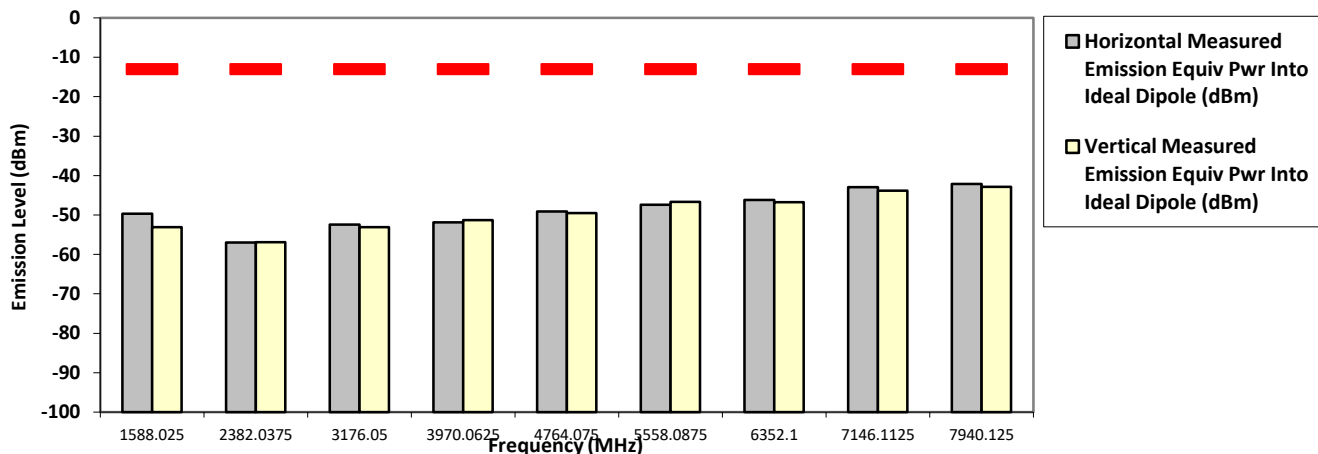

The data presented here was taken using the substitution method as found in the ANSI C63.26-2015 document.  
 Motorola Penang EMC Lab - Test Performed by: Nazrin&Qawiman      Thu, Jan 10, 2019

Remarks: \*\* Indicates the spurious emission could not be detected due to noise limitations or ambient.  
 \*Pursuant to CFR 47 Part 2.1057 ( c ), emissions attenuated more than 20 dB below the permissible limit are not reported  
 Temp(Deg): 23.6 Hum(%RH): 70.3

System MU: 5.01 dB

<b>Remarks:</b>	Passed Results	Marginal Results	Failed Results
-----------------	----------------	------------------	----------------



**SAC Transmitter Radiated Emission:**  
**Model Number: H55TGT9PW8AN**      **S/N: 437TUX0086**      **SR:12464-EMC-00073**  
**Battery Part No: NNTN9089A**      **Accy Part No: NA**  
**Test Mode: TX APCO Digital Phase II**  
**799.087500 MHz**      **12.5 kHz**      **1.000 Watt(s)/Low Power**

Frequency (MHz)	Limit	Horizontal Measured Emission Equiv Pwr Into Ideal Dipole (dBm)	Vertical Measured Emission Equiv Pwr Into ideal Dipole (dBm)
1598.1750	-13.0000	-50.7800 *	-54.3500 *
2397.2625	-13.0000	-56.5134 **	-56.5193 **
3196.3500	-13.0000	-50.6641 **	-52.1402 **
3995.4375	-13.0000	-52.2581 **	-51.7929 **
4794.5250	-13.0000	-49.1067 **	-49.1685 **
5593.6125	-13.0000	-47.6392 **	-48.8354 **
6392.7000	-13.0000	-46.5616 **	-46.1799 **
7191.7875	-13.0000	-44.5719 **	-44.1236 **
7990.8750	-13.0000	-42.5338 **	-42.6621 **

**RADIATED SPURIOUS EMISSIONS**

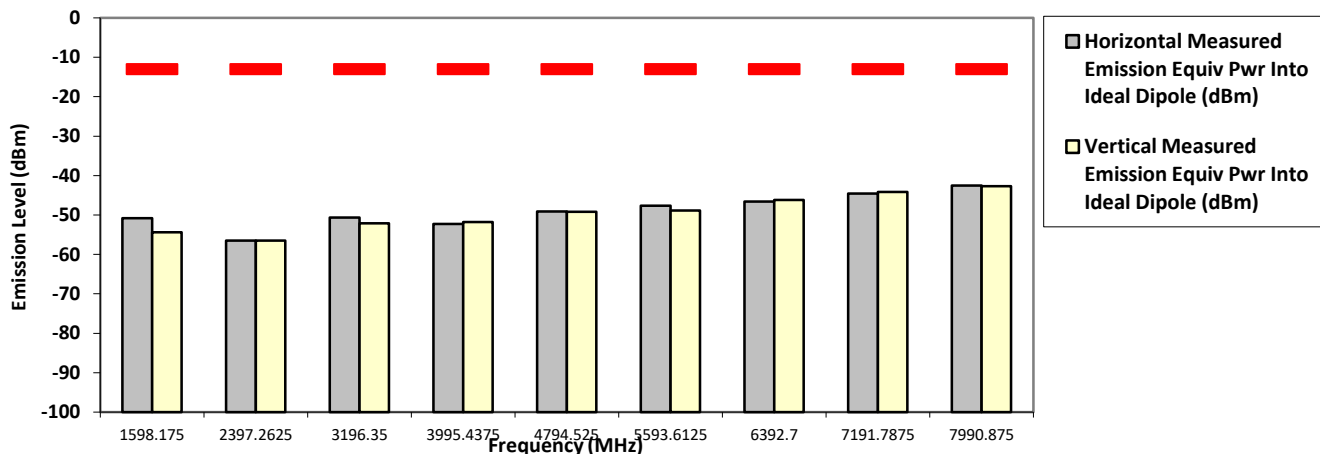

The data presented here was taken using the substitution method as found in the ANSI C63.26-2015 document.  
 Motorola Penang EMC Lab - Test Performed by: Nazrin&Qawiman      Thu, Jan 10, 2019

Remarks: \*\* Indicates the spurious emission could not be detected due to noise limitations or ambient.  
 \*Pursuant to CFR 47 Part 2.1057 ( c ), emissions attenuated more than 20 dB below the permissible limit are not reported  
 Temp(Deg): 23.6 Hum(%RH): 70.3

System MU: 5.01 dB

<b>Remarks:</b>	Passed Results	Marginal Results	Failed Results
-----------------	----------------	------------------	----------------

**SAC Transmitter Radiated Emission:**

**Model Number: H55TGT9PW8AN**      **S/N: 437TUX0086**      **SR:12464-EMC-00073**  
**Battery Part No: NNTN9089A**      **Accy Part No: NA**  
**Test Mode: TX APCO Digital Phase II**  
**799.087500 MHz**      **12.5 kHz**      **2.990 Watt(s) /Max Power**

Frequency (MHz)	Limit	Horizontal Measured Emission Equiv Pwr Into Ideal Dipole (dBm)	Vertical Measured Emission Equiv Pwr Into ideal Dipole (dBm)
1598.1750	-13.0000	-46.0700 *	-50.4300 *
2397.2625	-13.0000	-55.4260 **	-55.8056 **
3196.3500	-13.0000	-46.1500 *	-47.0600 *
3995.4375	-13.0000	-51.7891 **	-51.8496 **
4794.5250	-13.0000	-49.5863 **	-49.7859 **
5593.6125	-13.0000	-48.7141 **	-48.4323 **
6392.7000	-13.0000	-46.6733 **	-46.4430 **
7191.7875	-13.0000	-44.6342 **	-43.7410 **
7990.8750	-13.0000	-42.4707 **	-42.5754 **

**RADIATED SPURIOUS EMISSIONS**

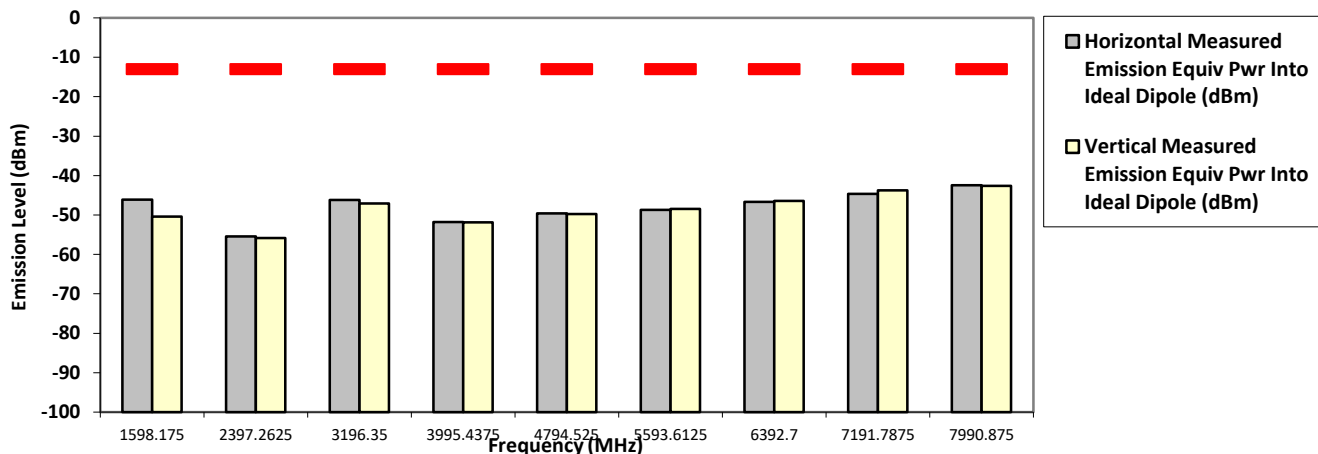

The data presented here was taken using the substitution method as found in the ANSI C63.26-2015 document.  
 Motorola Penang EMC Lab - Test Performed by: Nazrin&Qawiman      Thu, Jan 10, 2019

Remarks: \*\* Indicates the spurious emission could not be detected due to noise limitations or ambient.  
 \*Pursuant to CFR 47 Part 2.1057 ( c ), emissions attenuated more than 20 dB below the permissible limit are not reported  
 Temp(Deg): 23.6 Hum(%RH): 70.3

System MU: 5.01 dB

<b>Remarks:</b>	Passed Results	Marginal Results	Failed Results
-----------------	----------------	------------------	----------------



**SAC Transmitter Radiated Emission:**

**Model Number: H55TGT9PW8AN**      **S/N: 437TUX0086**      **SR:12464-EMC-00073**  
**Battery Part No: NNTN9089A**      **Accy Part No: NA**  
**Test Mode: TX APCO Digital Phase II**  
**804.912500 MHz**      **12.5 kHz**      **2.990 Watt(s) /Max Power**

Frequency (MHz)	Limit	Horizontal Measured Emission Equiv Pwr Into Ideal Dipole (dBm)	Vertical Measured Emission Equiv Pwr Into ideal Dipole (dBm)
1609.8250	-13.0000	-45.5700 *	-49.7200 *
2414.7375	-13.0000	-55.2860 **	-55.9123 **
3219.6500	-13.0000	-49.2280 **	-51.5043 **
4024.5625	-13.0000	-51.1686 **	-49.9724 **
4829.4750	-13.0000	-50.1748 **	-49.3998 **
5634.3875	-13.0000	-47.9194 **	-48.1509 **
6439.3000	-13.0000	-45.5302 **	-45.5740 **
7244.2125	-13.0000	-44.0560 **	-43.7510 **
8049.1250	-13.0000	-42.5708 **	-42.3656 **

**RADIATED SPURIOUS EMISSIONS**

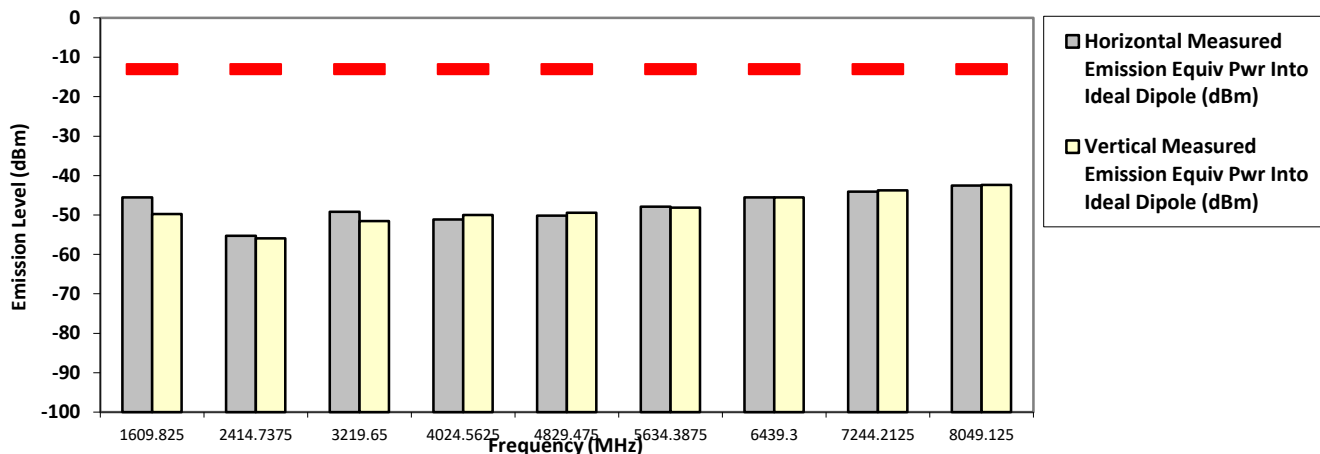

The data presented here was taken using the substitution method as found in the ANSI C63.26-2015 document.  
 Motorola Penang EMC Lab - Test Performed by: Nazrin&Qawiman      Thu, Jan 10, 2019

Remarks: \*\* Indicates the spurious emission could not be detected due to noise limitations or ambient.  
 \*Pursuant to CFR 47 Part 2.1057 ( c ), emissions attenuated more than 20 dB below the permissible limit are not reported  
 Temp(Deg): 23.6 Hum(%RH): 70.3

System MU: 5.01 dB

<b>Remarks:</b>	Passed Results	Marginal Results	Failed Results
-----------------	----------------	------------------	----------------

### 6.13.4. Test Limit

Table below summarized the power of any emission outside a licensee's frequency block shall be attenuated below the transmitter power (P) by at least

Channel Spacing	Part 22	Part 24D	Part 74	Part 80	Part 90 (UHF, VHF, 800, 900)	Part 90 (700)
12.5kHz	43 + log <sub>10</sub> (P) (-13 dBm)	43 + log <sub>10</sub> (P) (-13 dBm)	43 + log <sub>10</sub> (P) (-13 dBm)	Not Applicable	50 + log <sub>10</sub> (P) (-20 dBm)	43 + log <sub>10</sub> (P) (-13 dBm)
25kHz		Not Applicable		43 + log <sub>10</sub> (P) (-13 dBm)	43 + log <sub>10</sub> (P) (-13 dBm)	43 + log <sub>10</sub> (P) (-13 dBm)

Channel Spacing	RSS 134	RSS 182	RSS 119 (UHF, VHF, 800, 900)	RSS 119 (700)
12.5kHz	43 + log <sub>10</sub> (P) (-13 dBm)	Not Applicable	50 + log <sub>10</sub> (P) (-20 dBm)	43 + log <sub>10</sub> (P) (-13 dBm)
25kHz	Not Applicable	43 + log <sub>10</sub> (P) (-13 dBm)	43 + log <sub>10</sub> (P) (-13 dBm)	43 + log <sub>10</sub> (P) (-13 dBm)



## 6.14. Effective Radiated Power (ERP)

### 6.14.1. Test Setup

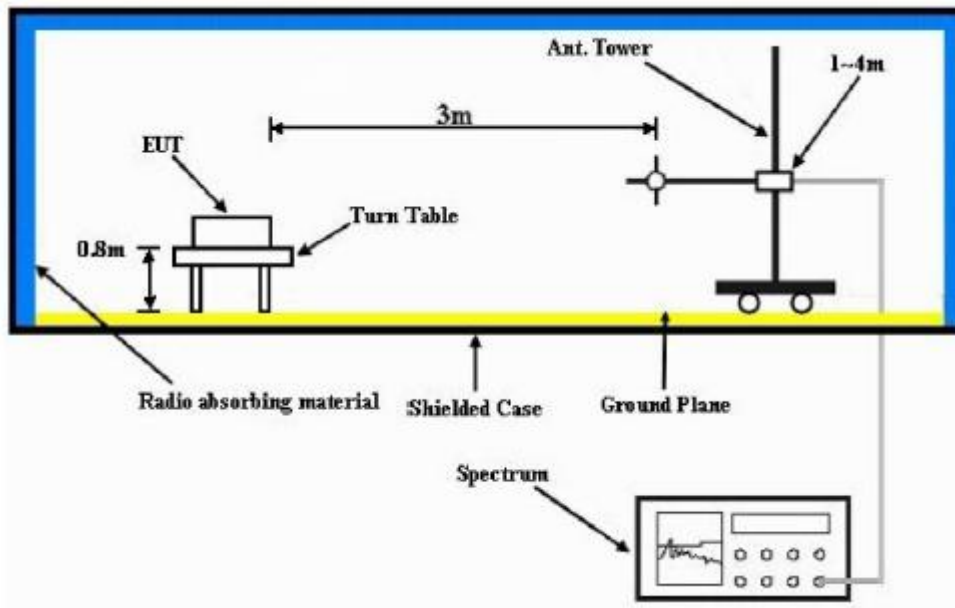

- 1) The Resolution Bandwidth for Equivalent Radiated Power (ERP) below 1 GHz is 100 kHz with Video Bandwidth = 300 kHz and Resolution Bandwidth for EIRP above 1 GHz is 1 MHz with Video Bandwidth = 3 MHz. Detector Mode is RMS.
- 2) In the semi-anechoic chamber, setup as illustrated above the DUT placed on the 0.8m height of Turn Table, rotated the table 45 degree each interval to search the maximum radiation power and receiver antenna shall be rotated vertical and horizontal polarization and moved height from 1m to 4m to find the maximum polar radiated power for each degree interval. The “Read Value” is the spectrum reading of maximum power value.
- 3) The substitution antenna is substituted for DUT at the same position and signals generator (S.G) export the CW signal to the substitution antenna via a TX cable. The receiver antenna shall be rotated vertical and horizontal polarization and moved height from 1m to 4m to find the maximum radiation power. Record the power level of maximum radiation power from spectrum. So, the Measured substitution value = Ref level of S.G + TX cables loss – Substituted Antenna Gain.

### 6.14.2. Test Result

**NA → Not Applicable**

### 6.14.3. Test Limit

The maximum output power of the transmitter for mobile stations is 100 watts (20 dB). Power is given in terms of effective radiated power (ERP).

## 6.15. GNSS (EIRP for 1559 - 1610MHz)

### 6.15.1. Test Setup

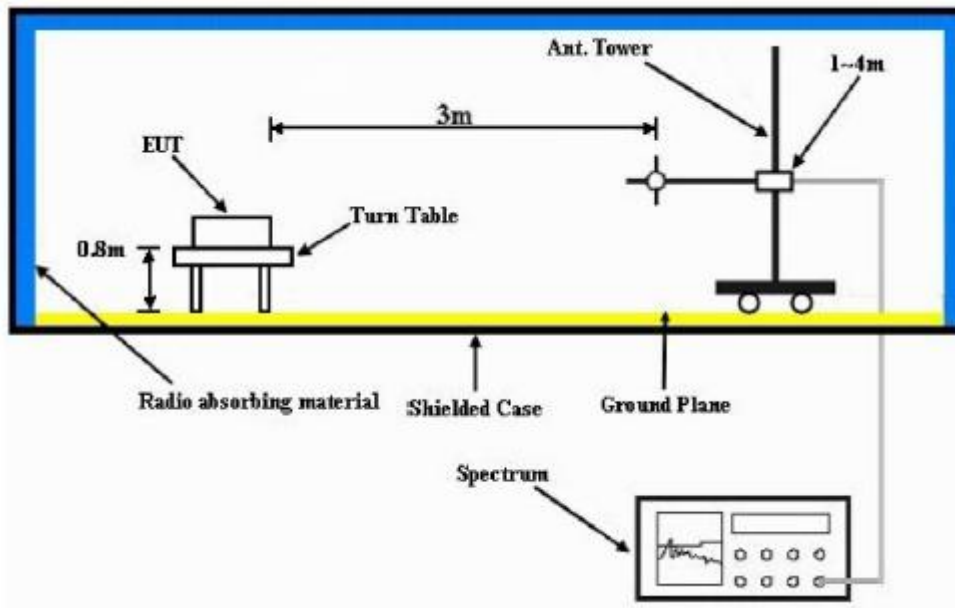

- 4) The Resolution Bandwidth for Equivalent Isotropically Radiated Power (EIRP) below 1 GHz is 100 kHz with Video Bandwidth = 300 kHz and Resolution Bandwidth for EIRP above 1 GHz is 1 MHz with Video Bandwidth = 3 MHz. Detector Mode is RMS.
- 5) In the semi-anechoic chamber, setup as illustrated above the DUT placed on the 0.8m height of Turn Table, rotated the table 45 degree each interval to search the maximum radiation power and receiver antenna shall be rotated vertical and horizontal polarization and moved height from 1m to 4m to find the maximum polar radiated power for each degree interval. The “Read Value” is the spectrum reading of maximum power value.
- 6) The substitution antenna is substituted for DUT at the same position and signals generator (S.G) export the CW signal to the substitution antenna via a TX cable. The receiver antenna shall be rotated vertical and horizontal polarization and moved height from 1m to 4m to find the maximum radiation power. Record the power level of maximum radiation power from spectrum. So, the Measured substitution value = Ref level of S.G + TX cables loss – Substituted Antenna Gain.
- 7)  $EIRP = \text{“Read Value”} + \text{Measured substitution value} + 2.15$ .

**6.15.1. Test Result**

**S/N: 437TUX0086**  
**Channel Spacing: 12.5 kHz**  
**Accessory: AN000296A01**

**Tx Power: 2.990 Watts**  
**Modulation: FM**

**Frequency Channel: 799.0875 MHz**

Antenna Polarization	2Fc (MHz)	EIRP (dBm)	Limit (dBm)
Horizontal	1598.175	-42.91	-40
Vertical	1598.175	-44.39	-40

**Frequency Channel: 804.9125 MHz**

Antenna Polarization	2Fc (MHz)	EIRP (dBm)	Limit (dBm)
Horizontal	1609.825	-45.91	-40
Vertical	1609.825	-44.87	-40

**6.15.2. Test Limit**

For operations in the 758-775 MHz and 788-805 MHz bands, all emissions including harmonics in the band 1559-1610 MHz shall be limited to  $-70$  dBW/MHz equivalent isotropically radiated power (EIRP) for wideband signals, and  $-80$  dBW EIRP for discrete emissions of less than 700 Hz bandwidth.

~ End of Report ~