

# APX 7000 User Guide

Top Display

6875952M01-D





# ASTRO® APX™ 7000 Series Digital Portable Radios Quick Reference Card

## Product Safety and RF Exposure Compliance



Before using this product, read the operating instructions for safe usage contained in the Product Safety and RF Exposure booklet enclosed with your radio.

### ATTENTION!

This radio is restricted to occupational use only to satisfy FCC RF energy exposure requirements. Before using this product, read the RF energy awareness information and operating instructions in the Product Safety and RF Exposure booklet enclosed with your radio (Motorola Publication part number 6881095C98) to ensure compliance with RF energy exposure limits.

## Radio Controls

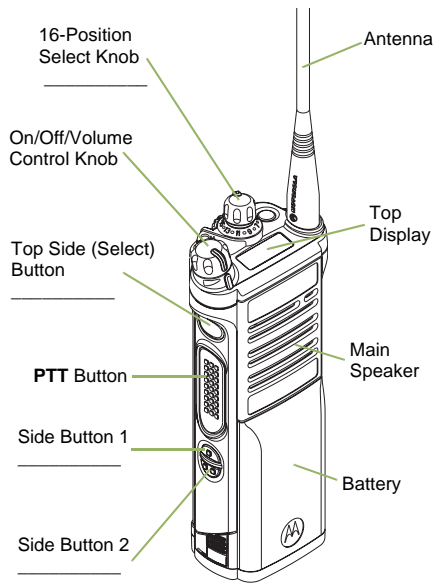
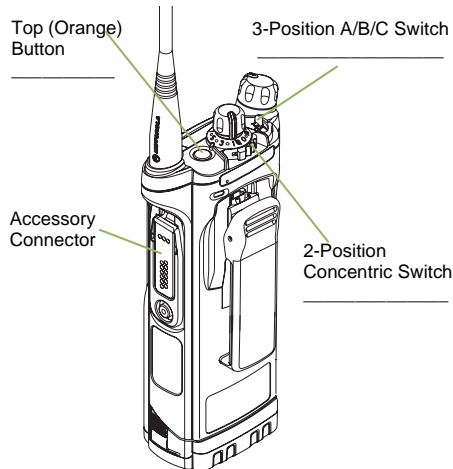

## Radio On/Off

- **On** – On/Off/Volume knob clockwise.
- **Off** – On/Off/Volume knob counterclockwise.

## Zones and Channels

- **Zone** – Zone switch to desired zone.
- **Channel** – Channel switch to desired channel.

## Receiving and Transmitting

- 1 Select zone/channel.
- 2 Listen for a transmission.  
**OR**  
Press and hold **Volume Set** button.  
**OR**  
Press **Monitor** button and listen for activity.
- 3 Adjust volume, if necessary.
- 4 Press the **PTT** button to transmit; release to receive.

## Sending an Emergency Alarm

- 1 Press the **Emergency** button.
- 2 The display shows **EMERGENCY** and the current zone/channel. A short, medium-pitched tone sounds, and the LED rapidly blinks red.
- 3 When acknowledgment is received, you hear four beeps; alarm ends; and radio exits emergency.

*To exit emergency at any time, press and hold the **Emergency** button.*



68007024033-A



## ■ Sending an Emergency Call

- 1 Press the **Emergency** button.
- 2 Press and hold the **PTT** button. Speak clearly into the microphone.
- 3 Release the **PTT** button to end call.
- 4 Press and hold **Emergency** button to exit emergency.









*To exit emergency at any time, press and hold the **Emergency** button.*





## ■ Sending a Silent Emergency Call

- 1 Press the **Emergency** button.
- 2 The display does not change; the LED does not light up, and there is no tone.
- 3 Silent emergency continues until you:  
Press and hold the **Emergency** button to exit emergency state.  
**OR**  
Press and release the **PTT** button to exit silent emergency mode and enter regular emergency (alarm, call, or alarm with call) mode.

*To exit emergency at any time, press and hold the **Emergency** button.*

## ■ Display Status Icons

	Blinks when the battery is low.
	The more stripes, the stronger the signal strength for the current site (trunking only).
	Direct radio to radio communication or connected through a repeater. <b>On</b> = Direct <b>Off</b> = Repeater
	This channel is being monitored.
	<b>L</b> = Radio is set at Low power. <b>H</b> = Radio is set at High power.
	Scanning a scan list.
	<b>Blinking dot</b> = Detects activity on the Priority-One Channel during scan. <b>Steady dot</b> = Detects activity on the Priority-Two Channel during scan.
	The vote scan feature is enabled.

	<b>On</b> = Secure operation. <b>Off</b> = Clear operation. <b>Blinking</b> = Receiving an encrypted voice call.
	<b>On steady</b> = View mode <b>Blinking</b> = Program mode
	<b>Zone Bank 1</b> <b>A</b> = Radio is in Zone 1. <b>B</b> = Radio is in Zone 2. <b>C</b> = Radio is in Zone 3.
	<b>Zone Bank 2</b> <b>D</b> = Radio is in Zone 4. <b>E</b> = Radio is in Zone 5. <b>F</b> = Radio is in Zone 6.

## Declaration of Conformity

This declaration is applicable to your radio **only** if your radio is labeled with the FCC logo shown below.

<p><b>DECLARATION OF CONFORMITY</b> Per FCC CFR 47 Part 2 Section 2.1077(a)</p> <p style="text-align: center;"></p> <p>Responsible Party Name: Motorola, Inc. Address: 1301 East Algonquin Road, Schaumburg, IL 60196-1078, U.S.A. Phone Number: 1-800-927-2744</p> <p>Hereby declares that the product:     Model Name: <b>APX 7000</b></p> <p>conforms to the following regulations:     FCC Part 15, subpart B, section 15.107(a), 15.107(d) and section 15.109(a)</p> <p><b>Class B Digital Device</b></p> <p>As a personal computer peripheral, this device complies with Part 15 of the FCC Rules. Operation is subject to the following two conditions:</p> <ol style="list-style-type: none"><li>1. This device may not cause harmful interference, and</li><li>2. This device must accept any interference received, including interference that may cause undesired operation.</li></ol>
---

**Note:** This equipment has been tested and found to comply with the limits for a Class B digital device, pursuant to part 15 of the FCC Rules. These limits are designed to provide reasonable protection against harmful interference in a residential installation. This equipment generates, uses and can radiate radio frequency energy and, if not installed and used in accordance with the instructions, may cause harmful interference to radio communications. However, there is no guarantee that interference will not occur in a particular installation.

If this equipment does cause harmful interference to radio or television reception, which can be determined by turning the equipment off and on, the user is encouraged to try to correct the interference by one or more of the following measures:

- Reorient or relocate the receiving antenna.
- Increase the separation between the equipment and receiver.
- Connect the equipment into an outlet on a circuit different from that to which the receiver is connected.
- Consult the dealer or an experienced radio/TV technician for help.

## Contents

This User Guide contains all the information you need to use the APX™ 7000 Series Digital Portable Radios.

<b>Declaration of Conformity</b> .....	<b>i</b>
<b>Important Safety Information</b> .....	<b>vii</b>
Product Safety and RF Exposure Compliance .....	vii
<b>Software Version</b> .....	<b>vii</b>
<b>Computer Software Copyrights</b> .....	<b>viii</b>
<b>Documentation Copyrights</b> .....	<b>viii</b>
<b>Disclaimer</b> .....	<b>viii</b>
<b>Getting Started</b> .....	<b>1</b>
How to Use This Guide .....	1
Notations Used in This Manual .....	1
What Your Dealer/System Administrator Can Tell You .....	2

<b>Preparing Your Radio for Use</b> .....	<b>2</b>
Charging the Battery .....	3
Battery Charger .....	3
Attaching the Battery .....	3
Attaching the Antenna .....	4
Attaching the Accessory Connector Cover .....	5
Attaching the Belt Clip .....	5
Turning On the Radio .....	6
Adjusting the Volume .....	7
<b>Identifying Radio Controls</b> .....	<b>7</b>
Radio Parts and Controls .....	8
Programmable Features .....	9
Assignable Radio Functions .....	9
Assignable Settings or Utility Functions .....	10
Accessing the Preprogrammed Functions .....	10
Push-To-Talk (PTT) Button .....	10
<b>Identifying Status Indicators</b> .....	<b>11</b>
Status Icons .....	11
LED Indicator .....	12
Intelligent Lighting Indicators .....	13

Alert Tones .....	14	Classifying Regrouped Radios .....	25
<b>General Radio Operation .....</b>	<b>17</b>	Scan Lists .....	25
Selecting a Zone .....	17	Viewing a Scan List .....	25
Selecting a Radio Channel .....	18	Viewing and Changing the Priority Status .....	25
Receiving and Responding to a Radio Call .....	18	Scan .....	26
Receiving and Responding to a Talkgroup Call ...	19	Turning Scan On or Off .....	26
Receiving and Responding to a Private Call		Making a Dynamic Priority Change (Conventional	
(Trunking Only) .....	19	Scan Only) .....	27
Receiving and Responding to a Telephone Call		Deleting a Nuisance Channel .....	27
(Trunking Only) .....	20	Restoring a Nuisance Channel .....	27
Making a Radio Call .....	21	Call Alert Paging .....	28
Making a Talkgroup Call .....	21	Receiving a Call Alert Page .....	28
Repeater or Direct Operation .....	21	Emergency Operation .....	28
Monitoring Features .....	22	Sending an Emergency Alarm .....	29
Monitoring a Channel .....	22	Sending an Emergency Call (Trunking Only) .....	29
Conventional Mode Operation .....	22	Sending an Emergency Alarm with Emergency	
<b>Advanced Features .....</b>	<b>23</b>	Call .....	30
Advanced Call Features .....	23	Sending a Silent Emergency Alarm .....	31
Receiving and Responding to a Selective Call		Using the Emergency Keep-Alive Feature .....	31
(ASTRO Conventional Only) .....	23	Secure Operations .....	32
Using the Dynamic Regrouping Feature (Trunking		Selecting Secure Transmissions .....	32
Only) .....	24	Selecting Clear Transmissions .....	32
Requesting a Reprogram (Trunking Only) .....	24	Managing Encryption .....	33
		Loading an Encryption Key .....	33
		Using the Multikey Feature .....	33



Erasing the Selected Encryption Keys . . . . .	34
Requesting an Over-the-Air Rekey (ASTRO Conventional Only) . . . . .	34
Trunking System Controls . . . . .	35
Using the Failsoft System . . . . .	35
Going Out of Range . . . . .	35
Using the Site Trunking Feature . . . . .	36
Locking and Unlocking a Site . . . . .	36
Viewing and Changing a Site . . . . .	36
Viewing the Current Site . . . . .	36
Changing the Current Site . . . . .	36
Utilities . . . . .	37
Using the Flip Display . . . . .	37
Selecting a Zone Bank . . . . .	37
Selecting the Power Level . . . . .	37
Controlling the Display Backlight . . . . .	38
Turning Voice Mute On or Off . . . . .	38
Using the Time-Out Timer . . . . .	38
Using the Conventional Squelch Operation Features . . . . .	39
Analog Options . . . . .	39
Digital Options . . . . .	40
Using the PL Defeat Feature . . . . .	40
Using the Digital PTT ID Feature . . . . .	41
Using the Smart PTT Feature (Conventional Only) . . . . .	41
Voice Announcement . . . . .	42

<b>Helpful Tips . . . . .</b>	<b>44</b>
Caring for Your Radio . . . . .	44
Cleaning Your Radio . . . . .	45
Handling Your Radio . . . . .	45
Servicing Your Radio . . . . .	46
Taking Care of the Battery . . . . .	46
Checking the Battery Charge Status . . . . .	46
LED and Sounds . . . . .	46
Fuel Gauge Icon . . . . .	46
Battery Recycling and Disposal . . . . .	47

**Accessories . . . . . 48**

<b>Appendix: Maritime Radio Use in the VHF Frequency Range . . . . .</b>	<b>49</b>
Special Channel Assignments . . . . .	49
Emergency Channel . . . . .	49
Non-Commercial Call Channel . . . . .	49
Operating Frequency Requirements . . . . .	50

**Glossary** .....52

**Commercial Warranty** .....56

**Notes** .....59

## Important Safety Information

### Product Safety and RF Exposure Compliance



Caution

Before using this product, read the operating instructions for safe usage contained in the Product Safety and RF Exposure booklet enclosed with your radio.

### ATTENTION!

**This radio is restricted to occupational use only to satisfy FCC RF energy exposure requirements.**

Before using this product, read the RF energy awareness information and operating instructions in the Product Safety and RF Exposure booklet enclosed with your radio (Motorola Publication part number 6881095C98) to ensure compliance with RF energy exposure limits.

For a list of Motorola-approved antennas, batteries, and other accessories, visit the following website:

<http://www.motorola.com/governmentandenterprise>

## Software Version

All the features described in the following sections are supported by the radio's software version **R02.00.00** or later.

Check with your dealer or system administrator for more details of all the features supported.

---

## Computer Software Copyrights

The Motorola products described in this manual may include copyrighted Motorola computer programs stored in semiconductor memories or other media. Laws in the United States and other countries preserve for Motorola certain exclusive rights for copyrighted computer programs, including, but not limited to, the exclusive right to copy or reproduce in any form the copyrighted computer program. Accordingly, any copyrighted Motorola computer programs contained in the Motorola products described in this manual may not be copied, reproduced, modified, reverse-engineered, or distributed in any manner without the express written permission of Motorola. Furthermore, the purchase of Motorola products shall not be deemed to grant either directly or by implication, estoppel, or otherwise, any license under the copyrights, patents or patent applications of Motorola, except for the normal non-exclusive license to use that arises by operation of law in the sale of a product.

---

## Documentation Copyrights

No duplication or distribution of this document or any portion thereof shall take place without the express written permission of Motorola. No part of this manual may be reproduced, distributed, or transmitted in any form or by any means, electronic or mechanical, for any purpose without the express written permission of Motorola.

---

## Disclaimer

The information in this document is carefully examined, and is believed to be entirely reliable. However, no responsibility is assumed for inaccuracies. Furthermore, Motorola reserves the right to make changes to any products herein to improve readability, function, or design. Motorola does not assume any liability arising out of the applications or use of any product or circuit described herein; nor does it cover any license under its patent rights, nor the rights of others.

## Getting Started

Take a moment to review the following:

How to Use This Guide . . . . .	page 1
Notations Used in This Manual . . . . .	page 1
What Your Dealer/System Administrator Can Tell You. . . . .	page 2

## How to Use This Guide

This User Guide covers the basic operation of the APX™ 7000 Portables.

However, your dealer or system administrator may have customized your radio for your specific needs. Check with your dealer or system administrator for more information.

## Notations Used in This Manual

Throughout the text in this publication, you will notice the use of **WARNING**, **Caution**, and **Note**. These notations are used to emphasize that safety hazards exist, and the care that must be taken or observed.



An operational procedure, practice, or condition, etc., which may result in injury or death if not carefully observed.



An operational procedure, practice, or condition, etc., which may result in damage to the equipment if not carefully observed.

**Note:** An operational procedure, practice, or condition, etc., which is essential to emphasize.

## ■ What Your Dealer/System Administrator Can Tell You

Check with your dealer or system administrator, if the radio is to be operated in extremely cold temperatures (less than -20°C), for the correct radio settings to ensure proper top display operation.

You can also consult your dealer or system administrator about the following:

- Is your radio preprogrammed with any preset conventional channels?
- Which buttons have been preprogrammed to access other features?
- What optional accessories may suit your needs?

## ----- Preparing Your Radio for Use

Assemble your radio by following these steps:

Charging the Battery . . . . . page 3  
     Battery Charger . . . . . page 3  
 Attaching the Battery . . . . . page 3  
 Attaching the Antenna . . . . . page 4  
 Attaching the Belt Clip . . . . . page 5  
 Attaching the Accessory Connector Cover . . . . . page 5  
 Turning On the Radio. . . . . page 6  
 Adjusting the Volume . . . . . page 7

## ■ Charging the Battery



WARNING

To avoid a possible explosion:

- **DO NOT** replace the battery in any area labeled “hazardous atmosphere”.
- **DO NOT** discard batteries in a fire.

The Motorola-approved battery shipped with your radio is uncharged. Prior to using a new battery, charge it for a minimum of 16 hours to ensure optimum capacity and performance.

For a list of Motorola-authorized batteries available for use with your radio, see **Accessories** on page 48.

**Note:** When charging a battery attached to a radio, turn the radio off to ensure a full charge.

### Battery Charger

To charge the battery, place the battery, with or without the radio, in a Motorola-approved charger. The charger’s LED indicates the charging progress; see your charger’s user guide.

For a list of chargers, see **Accessories** on page 48.

## ■ Attaching the Battery

With the radio turned off, slide the battery into the radio’s frame until side latches click into place.

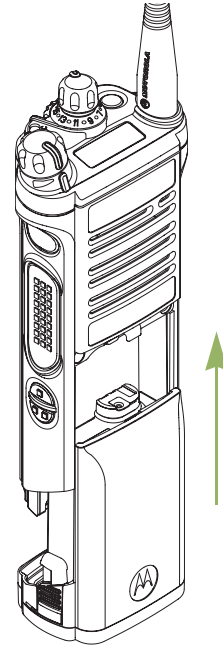

Battery  
Latch

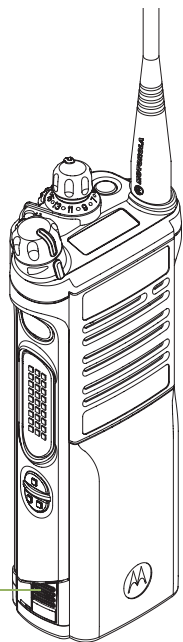

*To remove the battery, turn the radio off. Squeeze the release latches on the bottom of the battery until the battery releases from the radio. Remove the battery from the radio.*

**Note:** If your radio is preprogrammed with volatile-key retention, the encryption keys are retained for approximately 30 seconds after battery removal. Check with your dealer or system administrator for more information.

## ■ Attaching the Antenna

With the radio turned off, set the antenna in its receptacle and turn clockwise to attach it to the radio.

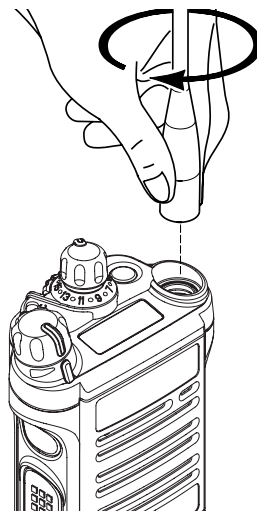

*To remove the antenna, turn the antenna counterclockwise. Make sure you turn off the radio first.*



## ■ Attaching the Accessory Connector Cover

The accessory connector is located on the antenna side of the radio. It is used to connect accessories to the radio.

**Note:** To prevent damage to the connector, shield it with the connector cover when not in use.

Insert the hooked end of the cover into the slot above the connector. Press downward on the cover's top to seat it in the slot. Once in place, rotate the thumbscrew clockwise by hand until tight.

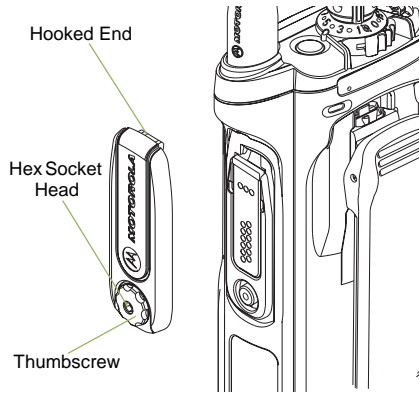

*To remove the accessory connector cover, rotate the thumbscrew counterclockwise until it disengages from the radio. If the thumbscrew is too tight, use an Allen wrench to loosen it first.*

*Rotate and lift the connector cover to disengage it from the radio.*

## ■ Attaching the Belt Clip

Align the grooves of the belt clip with those of the radio and press upward until you hear a click.

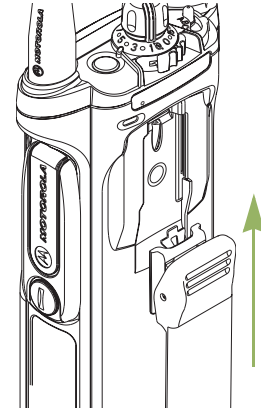

*To remove the clip, use a flat-bladed object to press the belt clip tab away from the radio. Then, slide the clip downward and away from the radio.*



## ■ Turning On the Radio

Rotate the **On/Off/Volume Control Knob** clockwise until you hear a click.

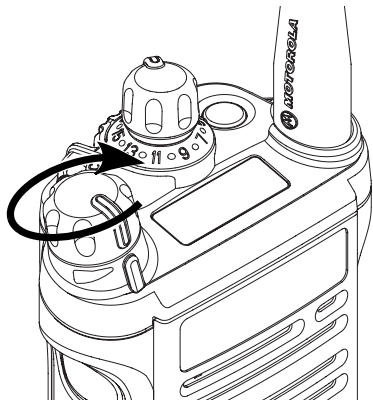

If the power-up test is successful, you see **SELFTEST** on the radio's display momentarily, followed by the Home screen.

**Note:** If the power-up test is unsuccessful, you see **ERROR XX/YY** (**XX/YY** is an alphanumeric code).

Turn off the radio, check the battery, and turn the radio back on. If the radio fails the power-up test again, record the **ERROR XX/YY** code and contact your dealer.

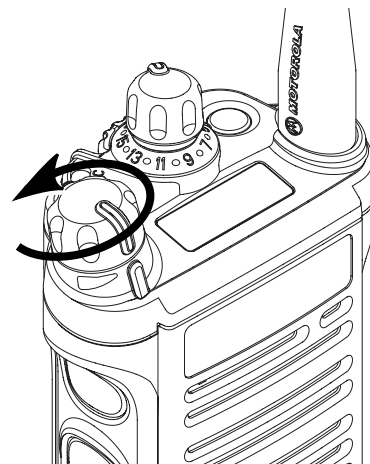

To turn off the radio, rotate the **On/Off/Volume Control Knob** counterclockwise until you hear a click.

## ■ Adjusting the Volume

To increase the volume, turn the **On/Off/Volume Control Knob** clockwise.

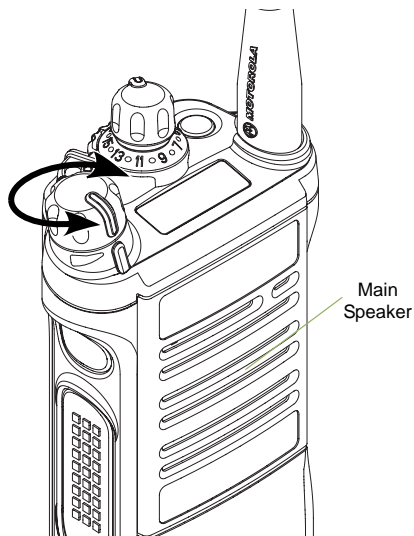

To decrease the volume, turn this knob counterclockwise.

**Note:** Ensure that the main speaker is pointed towards you for increased loudness and intelligibility, especially in areas with loud background noises.

## Identifying Radio Controls

Take a moment to review the following:

Radio Parts and Controls . . . . .	page 8
Programmable Features . . . . .	page 9
Assignable Radio Functions . . . . .	page 9
Assignable Settings or Utility Functions . . . . .	page 10
Accessing the Preprogrammed Functions . . . . .	page 10
Push-To-Talk (PTT) Button . . . . .	page 10

## Radio Parts and Controls

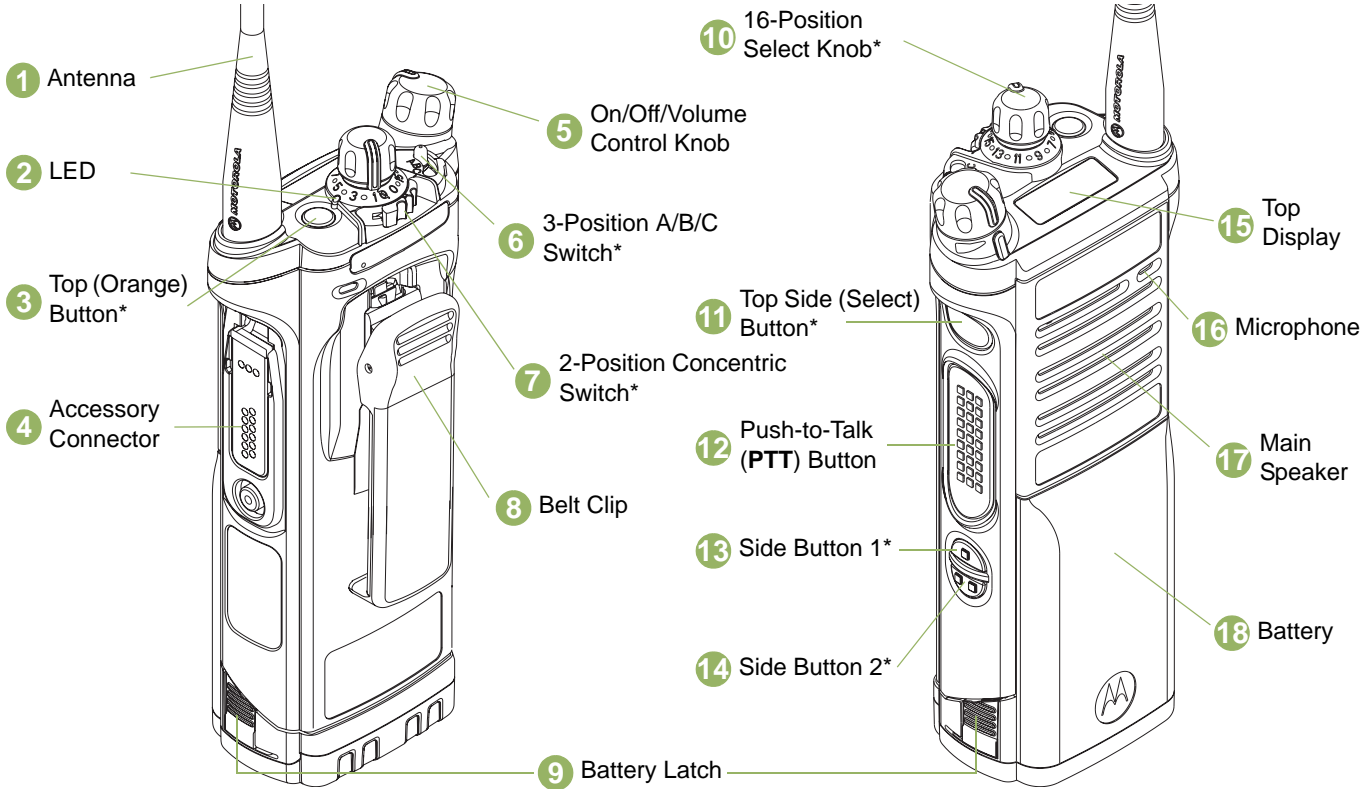

\* These radio controls/buttons are programmable.

## ■ Programmable Features

---

Any reference in this manual to controls that are “preprogrammed” means that a qualified radio technician must use the radio’s programming software to assign a feature to a control.

Your dealer can program the programmable buttons as shortcuts to radio functions or preset channels/groups depending on the duration of a button press:

- **Press** – Pressing and releasing rapidly.
- **Long press** – Pressing and holding for the preprogrammed duration (between 0.25 seconds and 3.75 seconds).
- **Hold down** – Keeping the button pressed.

### Assignable Radio Functions

**Call Response** – Allows you to answer a private call.

**Channel** – Selects a channel.

**Dynamic Priority (Conventional Only)** – Allows any channel in a scan list (except for the Priority-One channel) to temporarily replace the Priority-Two channel.

**Emergency** – Depending on the programming, initiates or cancels an emergency alarm or call.

**Internet Protocol** – Displays the Internet Protocol(IP) address, device name and status of the radio.

**Message** – Enters the current message list.

**Monitor (Conventional Only)** – Monitors a selected channel for all radio traffic until function is disabled.

**Multiple Private Line (Conventional Only)** – Selects the Multiple Private Line lists.

**Nuisance Delete** – Temporarily removes an unwanted channel, except for priority channels or the designated transmit channel, from the scan list.

**One Touch 1 – 4** – Launches a specific feature with one single button-press. You can setup as much as four separately programmed buttons for four different features.

**Private Line Defeat** – Overrides any coded squelch (DPL or PL) that is preprogrammed to a channel.

**Rekey Request** – Notifies the dispatcher that you require a new encryption key.

**Repeater Access Button (RAB) (Conventional Only)** – Allows to manually send a repeater access codeword.

**Reprogram Request (Trunking Only)** – Notifies the dispatcher that you want a new dynamic regrouping assignment.

**Request-To-Talk (Conventional Only)** – Notifies the dispatcher that you want to send a voice call.

**Scan** – Toggles scan on or off.

**Scan List Programming** – Selects the scan list for editing.

**Secure/Clear** – Toggles secure operation on or off.

**Site Display** – Displays the current site ID and RSSI value.

**Site Lock/Unlock** – Locks onto a specific site.

**Site Search** – Performs site search for AMSS (Automatic Multiple Site Select) or SmartZone operation.

**Talkaround/Direct** – Toggles between using a repeater and communicating directly with another radio.

**Zone Select** – Allows selection from a list of zones.

**Zone Bank** – Allows selection from a larger list of zones.

#### Assignable Settings or Utility Functions

**Flip** – Flips the content of the top display.

**Light** – Toggles display backlight on or off.

**TX Power Level** – Toggles transmit power level between high and low.

**Voice Mute** – Toggles voice mute on or off.

**Volume Set** – Sets the volume set tone.

## ■ Accessing the Preprogrammed Functions

You can access various radio functions through a short or long press of the relevant programmable buttons.

## ■ Push-To-Talk (PTT) Button

The **PTT** button on the side of the radio serves two basic purposes:

- While a call is in progress, the **PTT** button allows the radio to transmit to other radios in the call.

Press and hold down **PTT** button to talk. Release the **PTT** button to listen.

The microphone is activated when the **PTT** button is pressed.

- While a call is not in progress, the **PTT** button is used to make a new call. See **Making a Radio Call** on page 21 for more information.

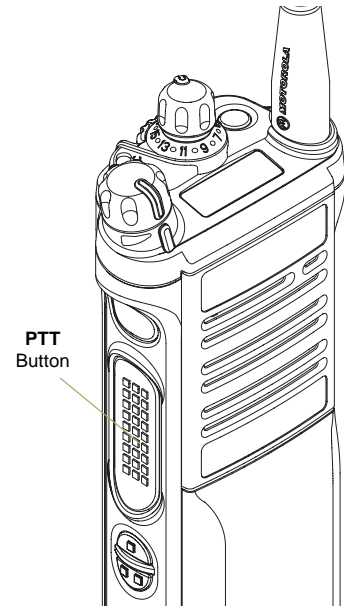

## Identifying Status Indicators

Your radio indicates its operational status through the following:

Status Icons . . . . .	page 11
LED Indicator. . . . .	page 12
Intelligent Lighting Indicators. . . . .	page 13
Alert Tones . . . . .	page 14

### ■ Status Icons

The 112 x 32 pixel top monochrome display screen of your radio shows the radio status and operating conditions.



#### Battery

The icon shown indicates the charge remaining in the battery. Blinks when the battery is low.



#### Received Signal Strength Indicator (RSSI)

The number of bars displayed represents the received signal strength for the current site, for trunking only. The more stripes in the icon, the stronger the signal.



#### Direct

- **On** = Radio is currently configured for direct radio to radio communication (during conventional operation only).
- **Off** = Radio is connected with other radios through a repeater.



#### Monitor (Carrier Squelch)

Selected channel is being monitored (during conventional operation only).

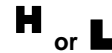

#### Power Level

- **L** = Radio is set at Low power.
- **H** = Radio is set at High power.



#### Scan

Radio is scanning a scan list.



#### Priority Channel Scan

- **Blinking dot** = Radio detects activity on channel designated as Priority-One.
- **Steady dot** = Radio detects activity on channel designated as Priority-Two.



### Vote Scan Enabled

The vote scan feature is enabled.

Top Display



### View/Program Mode

Radio is in the view or program mode.

- **On steady** = View mode
- **Blinking** = Program mode



or



or

### Zone Bank 1

- **A** = Radio is in Zone 1.
- **B** = Radio is in Zone 2.
- **C** = Radio is in Zone 3.



or



or

### Zone Bank 2

- **D** = Radio is in Zone 4.
- **E** = Radio is in Zone 5.
- **F** = Radio is in Zone 6.



### Secure Operation

- **On** = Secure operation.
- **Off** = Clear operation.
- **Blinking** = Receiving an encrypted voice call.

## LED Indicator

The LED indicator shows the operational status of your radio.

**Solid red** – Radio is transmitting.

**Blinking red** – Radio is transmitting at low battery condition.

**Double blinking red** – Radio is in Emergency Mode.

**Rapidly blinking red** – Radio has failed the self test upon powering up or encountered a fatal error.

**Solid yellow** – Channel is busy.

**Blinking yellow** – Radio is receiving a secured transmission.

**Solid green** – Radio is powering up, or is on a non-priority channel while in the Scan List Programming mode.

**Blinking green** – Radio is receiving an individual or telephone call, or is on a Priority-Two channel while in the Scan List Programming mode.

**Rapidly blinking green** – Radio is on a Priority-One channel while in the Scan List Programming mode.

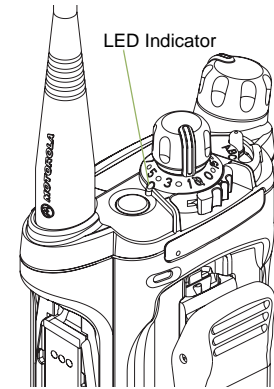



## ■ Intelligent Lighting Indicators

This feature temporary changes the backlight of the top display screen to help signal that a radio event has occurred.

**Note:** This feature must be preprogrammed by a qualified radio technician.

Backlight	Notification	When
Orange	Emergency Alerts	The radio initiates an emergency alarm or call.
		The radio receives an emergency alarm or call.
Red	Critical Alerts	The radio battery is low.
		The radio is out of range.
		The radio enters failsoft mode.
		The radio is unable to establish a full connection with the system.
Green	Call Alerts	The radio receives a private call.
		The radio receives a phone call.
		The radio receives a call alert.
		The radio receives a selective call.

## ■ Alert Tones

An alert tone is a sound or group of sounds. Your radio uses alert tones to inform you of your radio's conditions. The following table lists these tones and when they occur.

You Hear	Tone Name	Heard
<b>Short, Low-Pitched Tone</b>	Radio Self Test Fail	When radio fails its power-up self test.
	Reject	When unauthorized request is made.
	Time-Out Timer Warning	Four seconds before time out.
	No ACK Received	When radio fails to receive an acknowledgment.
	Individual Call Warning Tone	When radio is in an individual call for greater than 6 seconds without any activity.
<b>Long, Low-Pitched Tone</b>	Time-Out Timer Timed Out	After time out.
	Talk Prohibit/ <b>PTT</b> Inhibit	(When <b>PTT</b> button is pressed) transmissions are not allowed.
	Out of Range	(When <b>PTT</b> button is pressed) the radio is out of range of the system.
	Invalid Mode	When radio is on an unpreprogrammed channel.
<b>A Group of Low-Pitched Tones</b>	Busy	When the system is busy.

You Hear	Tone Name	Heard
<b>Short, Medium-Pitched Tone</b>	Valid Key-Press	When correct key is pressed.
	Radio Self Test Pass	When radio passes its power-up self test.
	Clear Voice	At beginning of a non-coded communication.
	Priority Channel Received	When activity on a priority channel is received.
	Emergency Alarm Entry	When entering the emergency state.
	Central Echo	When central controller has received a request from a radio.
<b>Long, Medium-Pitched Tone</b>	Volume Set	When volume is changed on a quiet channel.
	Emergency Exit	When exiting the emergency state.
<b>A Group of Medium-Pitched Tones</b>	Failsoft	When the trunking system fails.
	Automatic Call Back	When voice channel is available from previous request.
	Talk Permit	(When <b>PTT</b> button is pressed) verifying system accepting transmissions.
	Keyfail	When encryption key has been lost.
	Console Acknowledge	When status, emergency alarm, or reprogram request ACK is received.
	Received Individual Call	When Call Alert or Private Call is received.
	Call Alert Sent	When Call Alert is received by the target radio.
Site Trunking	When a SmartZone trunking system fails.	

You Hear	Tone Name	Heard
<b>Short, High-Pitched Tone (Chirp)</b>	Low-Battery Chirp	When battery is below preset threshold value.
<b>Ringling</b>	Fast Ringing	When system is searching for target of Private Call.
	Enhanced Call Sent	When waiting for target of Private Call to answer the call.
	Phone Call Received	When a land-to-mobile phone call is received.
<b>Gurgle</b>	Dynamic Regrouping	(When the <b>PTT</b> button is pressed) a dynamic ID has been received.
<b>Unique, Low-Pitched Chirp</b>	New Message	When a new message is received.
<b>Unique, High-Pitched Chirp</b>	Priority Status	When a priority message is received.

## General Radio Operation

Once you understand how your APX 7000 Portable is configured, you are ready to use your radio.

Use this navigation guide to familiarize yourself with the basic Call features:

Selecting a Zone . . . . .	page 17
Selecting a Radio Channel . . . . .	page 18
Receiving and Responding to a Radio Call . . . . .	page 18
Making a Radio Call . . . . .	page 21
Repeater or Direct Operation . . . . .	page 21
Monitoring Features . . . . .	page 22

## Selecting a Zone

A zone is a group of channels.

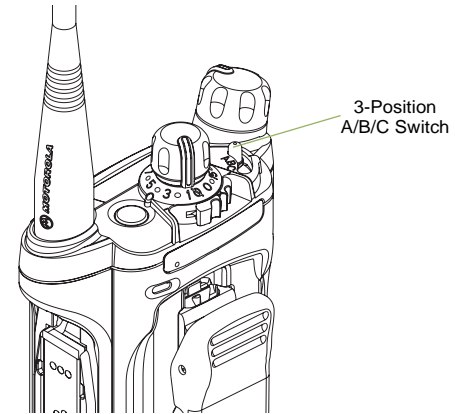

Use the following procedure to select a zone.

**Note:** Your radio must be preprogrammed to allow you to use this feature.

### Procedure:

- 1 Move the preprogrammed **Zone (3-Position A/B/C)** switch to the position of the required zone.
- 2 Press the **PTT** button to transmit on the displayed zone channel.

## ■ Selecting a Radio Channel

A channel is a group of radio characteristics, such as transmit/receive frequency pairs.

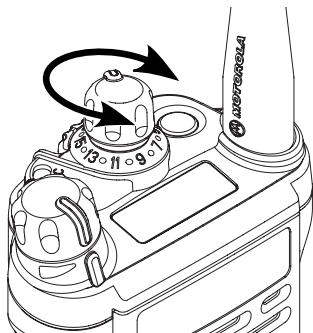

Use the following procedure to select a channel.

**Note:** Your radio must be preprogrammed to allow you to use this feature. If you select a channel that is not within the preprogrammed band, the radio indicates that it is on an unsupported frequency with an audio warning.

### Procedure:

- 1 Turn the preprogrammed **16-Position Select** knob to the desired channel.
- 2 Press the **PTT** button to transmit on the displayed zone channel.

## ■ Receiving and Responding to a Radio Call

Once you have selected the required channel and/or zone, you can proceed to receive and respond to calls.

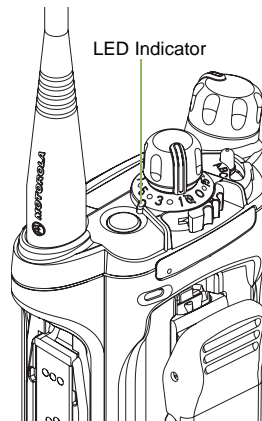

*The LED lights up solid red while the radio is transmitting, and solid yellow when the radio is receiving a transmission (conventional mode only). There is no LED indication when the radio receives a transmission in trunking mode.*

*If the radio is receiving a secure transmission, the LED blinks yellow.*

## Receiving and Responding to a Talkgroup Call

To receive a call from a group of users, your radio must be configured as part of that talkgroup.

### Procedure:

When you receive a talkgroup call (while on the Home screen), depending on how your radio is preprogrammed:

#### 1 **ASTRO Conventional Only:**

The LED lights up solid yellow.

**OR**

#### **Trunking Only:**

The display shows the caller alias or ID.

---

2 Hold the radio vertically 1 to 2 inches (2.5 to 5.0 cm) from your mouth.

---

3 Press the **PTT** button to respond to the call. The LED lights up solid red.

---

4 Release the **PTT** button to listen.

---

See ***Making a Talkgroup Call*** on page 21 for details on making a Talkgroup Call.

## Receiving and Responding to a Private Call (Trunking Only)

A Private Call is a call from an individual radio to another individual radio.

These one-to-one calls between two radios are not heard by others in the current talkgroup. The calling radio automatically verifies that the receiving radio is active on the system and can display the caller's ID.

**Note:** The radio automatically exits the feature, if the feature inactivity timer is enabled, when the radio is left idle and the timer expires. You will hear the Inactive Exit Tone upon feature exit.

### Procedure:

When you receive a Private Call:

1 You hear two alert tones and the LED blinks green. The backlight of the screen turns green and the display shows **CALL RCV**, alternating with the caller alias (name) or ID (number).

---

- 2 Press the **Call Response** button within 20 seconds after the call indicators begin.
- 3 Press and hold the **PTT** button to talk. Release the **PTT** button to listen.
- 4 Press the **Call Response** button to hang up and return to the Home screen.

*You cannot initiate a Private Call.*

### **Receiving and Responding to a Telephone Call (Trunking Only)**

This feature allows you to receive calls similar to standard phone calls from a landline phone.

**Note:** The radio automatically exits the feature, if the feature inactivity timer is enabled, when the radio is left idle and the timer expires. You will hear the Inactive Exit Tone upon feature exit.

#### **Procedure:**

When you receive a Telephone Call:

- 1 You hear a telephone-type ringing and the LED blinks green. The backlight of the screen turns green and the display shows **PHN CALL**.
- 2 Press the **Call Response** button within 20 seconds after the call indicators begin.
- 3 Press and hold the **PTT** button to talk. Release the **PTT** button to listen.
- 4 Press the **Call Response** button to hang up and return to the Home screen.

*You cannot initiate a Telephone Call.*



## ■ Making a Radio Call

---

You can select a zone, channel, or talkgroup by using:

- The preprogrammed Zone switch
- The Channel Selector Knob

### Making a Talkgroup Call

To make a call to a group of users, your radio must be configured as part of that talkgroup.

#### **Procedure:**

- 1** Turn the Channel Selector Knob to select the channel with the desired talkgroup.
- 2** Hold the radio vertically 1 to 2 inches (2.5 to 5.0 cm) from your mouth.
- 3** Press the **PTT** button to make the call.
- 4** **ASTRO Conventional Only:**  
The LED lights up solid red. The display shows the talkgroup alias or ID.  
**OR**  
**Trunking Only:**  
The LED lights up solid red.
- 5** Speak clearly into the microphone.
- 6** Release the **PTT** button to listen.

## ■ Repeater or Direct Operation

---

The **REPEATER** operation increases the radio's range by connecting with other radios through a repeater. The transmit and receive frequencies are different.

The **DIRECT** or "talkaround operation" allows you to bypass the repeater and connect directly to another radio. The transmit and receive frequencies are the same.

#### **Procedure:**

- 1** Press the preprogrammed **Repeater/Direct** switch to toggle between talkaround and repeater modes.
- 2** The display shows **RPTR MOD** if the radio is currently in Repeater mode.  
**OR**  
The display shows **DIR MODE** and the Talkaround icon if the radio is currently in Direct mode (during conventional operation only).

## ■ Monitoring Features

---

Radio users who switch from analog to digital radios often assume that the lack of static on a digital channel is an indication that the radio is not working properly. This is not the case. Digital technology quiets the transmission by removing the “noise” from the signal and allowing only the clear voice or data information to be heard.

Use the Monitor feature to make sure a channel is clear before transmitting.

### Monitoring a Channel

#### Procedure:

- 1 Press the preprogrammed **Monitor** button.
- 2 Press and hold the **Volume Set** button to hear the volume set tone.
- 3 Adjust the **Volume Control** knob if necessary.
- 4 Release the **Volume Set** button.
- 5 Press and hold the **PTT** button to transmit. The LED lights up solid red.
- 6 Release the **PTT** button to receive (listen).

*The Carrier Squelch indicator appears on the display when you monitor a channel via the preprogrammed **Monitor** button.*

### Conventional Mode Operation

Your radio may be preprogrammed to receive Private-Line® (PL) calls.

#### Procedure:

- 1 Momentarily press the **Monitor** button to listen for activity. The Carrier Squelch indicator appears on the display.
- 2 Press and hold the **Monitor** button to set continuous monitor operation. The duration of the button press is programmable.
- 3 Press the **Monitor** button again, or the **PTT** button, to return to the original squelch setting.

*If you try to transmit on a receive-only channel, you hear an invalid tone until you release the **PTT** button.*

## Advanced Features

Use this navigation guide to learn more about advanced features available with your radio:

Advanced Call Features . . . . .	page 23
Scan Lists . . . . .	page 25
Scan . . . . .	page 26
Call Alert Paging . . . . .	page 28
Emergency Operation . . . . .	page 28
Secure Operations. . . . .	page 32
Trunking System Controls . . . . .	page 35
Utilities. . . . .	page 37

## Advanced Call Features

### Receiving and Responding to a Selective Call (ASTRO Conventional Only)

This feature allows you to receive a call from or to call a specific individual. It is intended to provide privacy and to eliminate the annoyance of having to listen to conversations that are of no interest to you.

#### Procedure:

- 1 When you receive a Selective Call, you hear two alert tones and the LED lights up solid yellow. The backlight of the screen momentarily turns green and the display briefly shows **CALL RCV**.
- 2 The speaker unmutes.
- 3 Hold the radio vertically 1 to 2 inches (2.5 to 5.0 cm) from your mouth.
- 4 Press and hold the **PTT** button to talk. Release the **PTT** button to listen.

*You cannot initiate a Selective Call.*

## Using the Dynamic Regrouping Feature (Trunking Only)

This feature allows the dispatcher to temporarily reassign selected radios to a single special channel so they can communicate with each other. This feature is typically used during special operations and is enabled by a qualified radio technician.

You will not notice whether your radio has this feature enabled until a dynamic regrouping command is sent by the dispatcher.

**Note:** If you try to access a zone or channel that has been reserved by the dispatcher as a dynamically regrouped mode for other users, an invalid tone sounds.

### Procedure:

- 1 When your radio is dynamically regrouped, it automatically switches to the dynamically regrouped channel. A “gurgle” tone sounds and the display shows the dynamically regrouped channel’s name.
- 2 Press the **PTT** button to talk. Release **PTT** button to listen.

*When the dispatcher cancels dynamic regrouping, the radio automatically returns to the zone and channel that you were using before the radio was dynamically regrouped.*

## Requesting a Reprogram (Trunking Only)

This feature lets you notify the dispatcher that you want a new dynamic regrouping assignment.

### Procedure:

- 1 Press the preprogrammed **Reprogram Request** button to send reprogram request to the dispatcher.
- 2 The display alternates between **RPGM** and **PLS WAIT**.
- 3 If you hear five beeps, the dispatcher has acknowledged the reprogram request. The display shows **ACK RCVD** and the radio returns to the Home screen.

### OR

If the dispatcher does not acknowledge the reprogram request within six seconds, a low-pitched alert tone sounds and the display shows **NO ACK**. The radio returns to the Home screen.

## **Classifying Regrouped Radios**

The dispatcher can classify regrouped radios into either of two categories: **Select Enabled** or **Select Disabled**.

- Select-enabled radios are free to change to any available channel, including the dynamic-regrouping channel, once the user has selected the dynamic-regrouping position.
- Select-disabled radios cannot change channels while dynamically regrouped. The dispatcher has forced the radio to remain on the dynamic-regrouping channel.

The Scan or Private Call feature cannot be selected while your radio is Select Disabled.

## **Scan Lists**

---

Scan lists are created and assigned to individual channels/groups. Your radio scans for voice activity by cycling through the channel/group sequence specified in the scan list for the current channel/group.

Your radio can support up to 125 different scan lists. These lists must be preprogrammed by a qualified radio technician.

### **Viewing a Scan List**

#### **Procedure:**

Turn the **16-Position Select** knob to view the members on the list.

### **Viewing and Changing the Priority Status**

#### **Procedure:**

- 1 Press the **Top Side (Select)** button to change the priority status of the currently displayed channel or the scan list status icon of the currently displayed channel.
-

- 2 A Scan icon indicates that the current channel is in the scan list as a non-priority channel. The LED lights up solid green.

**OR**

A Priority-Two Channel Scan icon indicates that the current channel is in the scan list as the Priority-Two channel. The LED blinks green.

**OR**

A Priority-One Channel Scan icon indicates that the current channel is in the scan list as the Priority-One channel. The LED rapidly blinks green. You hear all traffic on the Priority-One channel, regardless of traffic on non-priority channels.

**OR**

No icon indicates that the current channel is deleted from the scan list.

---

## ■ Scan

---

This feature allows you to monitor traffic on different channels by scanning a preprogrammed list of channels.

### Turning Scan On or Off

#### **Procedure:**

- 1 Press the preprogrammed Scan button, or turn the preprogrammed Scan switch to the Scan on or Scan off position.
  - 2 The display shows **SCAN ON** and the scan icon, indicating that scan is enabled.

**OR**

The display shows **SCAN OFF**, indicating that scan is disabled.
-

## Making a Dynamic Priority Change (Conventional Scan Only)

While the radio is scanning, the dynamic priority change feature allows you to temporarily assign **any** channel in a scan list (except for the Priority-One channel) as the Priority-Two channel.

This change remains in effect until scan is turned off. Scan then reverts to the preprogrammed (original) setting.

### Procedure:

- 1 When the radio locks onto the channel designated as the new Priority-Two channel, press the preprogrammed **Dynamic Priority** button.
- 2 The radio continues scanning the remaining channels in the list.

## Deleting a Nuisance Channel

If a channel continually generates unwanted calls or noise (termed a “nuisance” channel), you can temporarily remove the unwanted channel from the scan list.

This capability does not apply to priority channels or the designated transmit channel.

**Note:** Deleting a “nuisance” channel is **only** possible through the preprogrammed **Nuisance Channel Delete** button.

### Procedure:

- 1 When the radio is locked onto the channel to be deleted, press the preprogrammed **Nuisance Delete** button.
- 2 The radio continues scanning the remaining channels in the list.

## Restoring a Nuisance Channel

### Procedure:

To restore the deleted nuisance channel, do **one** of the following:

- Turn the radio off and then turning it on again.  
**OR**
- Stop and restart a scan via the preprogrammed **Scan** button.  
**OR**
- Change the channel via the **16-Position Select** knob.

## ■ Call Alert Paging

---

This feature allows your radio to work like a pager.

**Note:** This feature must be preprogrammed by a qualified radio technician.

### Receiving a Call Alert Page

#### Procedure:

- 1 When you receive a Call Alert page, you hear four repeating alert tones and the LED blinks green.
- 2 The backlight of the screen turns green and the display briefly shows **PAGE RCV**.

*You cannot send a Call Alert page.*

## ■ Emergency Operation

---

The Emergency feature is used to indicate a critical situation.

If the **Top (Orange)** button is preprogrammed to send an emergency signal, this signal overrides any other communication over the selected channel.

Your radio supports the following Emergency modes:

- Emergency Alarm
- Emergency Call (Trunking Only)
- Emergency Alarm with Emergency Call
- Silent Emergency Alarm

Check with your dealer or system administrator for more information on the programming of this feature.

Only **one** of the Emergency modes above can be assigned to the preprogrammed **Emergency** button.

**Note:** To exit emergency at any time, press and hold the preprogrammed **Emergency** button for about a second.



## Sending an Emergency Alarm

This feature allows you to send a data transmission, which identifies the radio sending the emergency, to the dispatcher.

### Procedure:

- 1 Press the preprogrammed **Emergency** button.

---

- 2 The display shows **EMERGENCY** and the current zone or channel. A short, medium-pitched tone sounds and the LED rapidly blinks red.  
**OR**  
An invalid tone sounds, if the selected channel does not support emergency.

---

- 3 When you receive the dispatcher's acknowledgment, the display shows **ACK RCVD**. Four tones sound, the alarm ends, and the radio exits the Emergency Alarm mode.  
**OR**  
If no acknowledgement is received, the display shows **NO ACK**. The alarm ends and the radio exits the Emergency Alarm mode.

## Sending an Emergency Call (Trunking Only)

This feature gives your radio priority access on a channel.

**Note:** The radio operates in the normal dispatch manner while in Emergency Call, except, if enabled, it returns to one of the following:

- **Tactical/Non-Revert** – You talk on the channel you selected before you entered the emergency state.
- **Non-Tactical/Revert** – You talk on a preprogrammed emergency channel. The emergency alarm is sent on this same channel.

### Procedure:

- 1 Press the preprogrammed **Emergency** button.

---

- 2 The display shows **EMERGENCY** and the current zone or channel. A short, medium-pitched tone sounds and the LED rapidly blinks red.  
**OR**  
An invalid tone sounds, if the selected channel does not support emergency.

- 3 Hold the radio vertically 1 to 2 inches (2.5 to 5.0 cm) from your mouth.
- 4 Press and hold the **PTT** button. Speak clearly into the microphone.
- 5 Release the **PTT** button to end the transmission and wait for a response from the dispatcher.
- 6 Press and hold the preprogrammed **Emergency** button for about a second to exit the Emergency Call mode.

### Sending an Emergency Alarm with Emergency Call

#### Procedure:

- 1 Press the preprogrammed **Emergency** button.
- 2 The display shows **EMERGENCY** and the current zone or channel. A short, medium-pitched tone sounds and the LED rapidly blinks red.  
**OR**  
An invalid tone sounds, if the selected channel does not support emergency.

- 3 The radio enters the Emergency Call state when:  
You receive the dispatcher's acknowledgment. The display shows **ACK RCVD**.  
**OR**  
You press the **PTT** button while in the Emergency Alarm mode.
- 4 Hold the radio vertically 1 to 2 inches (2.5 to 5.0 cm) from your mouth.
- 5 Press and hold the **PTT** button. Speak clearly into the microphone.
- 6 Release the **PTT** button to end the transmission and wait for a response from the dispatcher.
- 7 Press and hold the preprogrammed **Emergency** button for about a second to exit the Emergency Call mode.

## Sending a Silent Emergency Alarm

This feature allows you to send an Emergency Alarm to another radio without any audio or visual indicators.

### Procedure:

- 1 Press the preprogrammed **Emergency** button.
- 2 The display shows no changes, the LED does not light up, and you hear no tones.
- 3 The silent emergency state continues until you:  
Press and hold the preprogrammed **Emergency** button for about a second to exit the Silent Emergency Alarm mode.  
**OR**  
Press and release the **PTT** button to exit the Silent Emergency Alarm mode and enter regular dispatch or Emergency Call mode.

**Note:** For **ALL** Emergency signals, when changing channels:

- If the new channel is also preprogrammed for Emergency, you can change channels while in Emergency operation. The emergency alarm or call continues on the new channel.
- If the new channel is **NOT** preprogrammed for Emergency, the display shows **NO EMERG**, and you hear an invalid tone until you exit the Emergency state or change to a channel preprogrammed for Emergency.

## Using the Emergency Keep-Alive Feature

This feature, when enabled, prevents the radio from being turned off via the **On/Off Control** knob when the radio is in the Emergency state.

**Note:** The radio only exits the Emergency state using one of the ways mentioned in the previous sections.

See ***Sending an Emergency Alarm*** on page 29, ***Sending an Emergency Call (Trunking Only)*** on page 29, ***Sending an Emergency Alarm with Emergency Call*** on page 30, or ***Sending a Silent Emergency Alarm*** on page 31.

## ■ Secure Operations

---

Secure radio operation provides the highest commercially available level of voice security on both trunked and conventional channels.

Unlike other forms of security, Motorola digital encryption provides signaling that makes it virtually impossible for others to decode any part of an encrypted message.

### Selecting Secure Transmissions

#### **Procedure:**

Turn the preprogrammed **Secure/Clear** switch to the secure position.

**Note:** If the selected channel is preprogrammed for clear-only operation – when you press the **PTT** button, an invalid mode tone sounds and the display shows **CLR TX**.

The radio will not transmit until you set the **Secure/Clear** switch to the clear position.

### Selecting Clear Transmissions

#### **Procedure:**

Turn the preprogrammed **Secure/Clear** switch to the clear position.

**Note:** If the selected channel is preprogrammed for secure-only operation – when you press the **PTT** button, an invalid mode tone sounds and the display shows **SEC TX**.

The radio will not transmit until you set the **Secure/Clear** switch to the secure position.

## Managing Encryption

### Loading an Encryption Key

**Note:** Refer to the key-variable loader (KVL) manual for equipment connections and setup.

#### Procedure:

- 1 Attach the KVL to your radio.
- 2 The display shows **KEYLOAD**, and all other radio functions, except for power down, backlight, and volume, are locked out.
- 3 Select the required keys and press the **Menu Select** button directly below **LOAD** on the KVL. This loads the encryption keys into your radio.
- 4 When the key has been loaded successfully, the radio sounds a short tone for single-key radios.

#### OR

When the key has been loaded successfully, the radio sounds an alternating tone for multikey radios.

### Using the Multikey Feature

This feature allows the radio to be equipped with as many as 48 different encryption keys and supports the DES-OFB algorithm.

There are two types:

- **Conventional Multikey** – The encryption keys can be tied (strapped), on a one-per-channel basis, through Customer Programming Software. In addition, you can have operator-selectable keys, operator-selectable keysets, and operator-selectable key erasure. If talkgroups are enabled in conventional, then the encryption keys are strapped to the talkgroups.
- **Trunked Multikey** – If you use your radio for both conventional and trunked applications, you have to strap your encryption keys for trunking on a per-talkgroup or announcement-group basis. In addition, you may strap a different key to other features, such as dynamic regrouping, failsoft, or emergency talkgroup. You can have operator-selectable key erasure.

## Erasing the Selected Encryption Keys

This feature allows you to erase all or selected encryption keys.

### Procedure:

Use the preprogrammed **Top Side (Select)** button and **Top (Orange)** button to erase the single key in radios with the single-key option, and to erase all keys in radios with the multikey option.

- 1 Press and hold the **Top Side (Select)** button.
- 2 While holding **Top Side (Select)** button down, press the **Top (Orange)** button.
- 3 The display shows **PLS WAIT**.
- 4 When all the encryption keys have been erased, the display shows **ALL ERASED**.

**Note:** **DO NOT** press the **Top (Orange)** button before pressing the **Top Side (Select)** button, unless you are in an emergency situation as this sends an emergency alarm.

## Requesting an Over-the-Air Rekey (ASTRO Conventional Only)

This feature, also known as **OTAR**, allows the dispatcher to reprogram the encryption keys in the radio remotely. The dispatcher performs the rekey operation upon receiving a rekey request from the user.

### Procedure:

- 1 Press and hold the preprogrammed **Rekey Request** button to send the rekey request.
- 2 If the rekey operation fails, a bad-key tone sounds and the display shows **RKY FAIL**.

**Note:** The rekey operation failure indicates that your radio does not contain the Unique Shadow Key (USK). This key must be loaded into the radio with the key-variable loader (KVL) before the rekey request can be sent.

Refer to your local key management supervisor for more information.

## ■ Trunking System Controls

---

### 📄 Using the Failsoft System

The failsoft system ensures continuous radio communications during a trunked system failure. If a trunking system fails completely, the radio goes into failsoft operation and automatically switches to its failsoft channel.

#### Procedure:

- 1 During failsoft operation, your radio transmits and receives in conventional operation on a predetermined frequency.
  - 2 A medium-pitched tone sounds every 10 seconds and the display shows **FAILSOFT**.
- 

*When the trunking system returns to normal operation, your radio automatically leaves failsoft operation and returns to trunked operation.*

### 📄 Going Out of Range

When your radio goes out of the range of the system, it can no longer lock onto a control channel.

#### Procedure:

- 1 A low-pitched tone sounds.  
**AND/OR**  
The display shows the currently selected zone/channel combination and **OUT RNG**.
  - 2 Your radio remains in this out-of-range condition until:  
It locks onto a control channel.  
**OR**  
It locks onto a failsoft channel.  
**OR**  
It is turned off.
-

## Using the Site Trunking Feature

If the zone controller loses communication with any site, that site reverts to site trunking.

The display shows the currently selected zone/channel combination and **STE TRNK**.

**Note:** When this occurs, you can communicate only with other radios within your trunking site.

## Locking and Unlocking a Site

This feature allows your radio to lock onto a specific site and not roam among wide-area talkgroup sites. This feature should be used with caution, since it inhibits roaming to another site in a wide-area system.

### Procedure:

- 1 Use the preprogrammed **Site Lock/Unlock** button to toggle the lock state between locked and unlocked.
- 2 The radio saves the new site lock state and returns to the Home screen.

## Viewing and Changing a Site

This feature allows you to view the number of the current site or force your radio to change to a new one.

### Viewing the Current Site

#### Procedure:

- 1 Press the preprogrammed **Site Search** button.
- 2 The display momentarily shows the name of the current site and its corresponding received signal strength indicator (RSSI).

### Changing the Current Site

#### Procedure:

- 1 Press and hold down the preprogrammed **Site Search** button.
- 2 A tone sounds and the display momentarily shows **SCANNING**.
- 3 When the radio finds a new site, it returns to the Home screen.



## ■ Utilities

---

### Using the Flip Display

This feature allows you to flip the content of the top display upside down. It is particularly useful when you would like to read the top display while the radio is still in the carry holder attached to your belt.

#### **Procedure:**

Press and hold the preprogrammed **Light** button to flip the display.

### Selecting a Zone Bank

This feature allows twice as many zones to be accessed from a switch, doubling the amount of switch positions.

**Note:** The Zone Select feature must be preprogrammed to the 3-position A-B-C switch, while the Zone Bank feature must be preprogrammed to any side button or **Top (Orange)** button before you can use this feature.

#### **Procedure:**

- 1 Use the preprogrammed **Zone Bank** button to toggle the position between Bank 1 and Bank 2.
- 2 The top display shows the status icons (**A, B, C, D, E** or **F**) or the zone name based on the bank and switch position selected.

See **Zone Bank 1** and **Zone Bank 2** on page 12 for more information on the status icons.

### Selecting the Power Level

You can select the power level at which your radio transmits. The radio always turns on to the default setting.

**Note:** This feature must be preprogrammed by a qualified radio technician.

#### **Settings:**

- Select **Low** for a shorter transmitting distance and to conserve power.
- Select **High** for a longer transmitting distance.

### Procedure:

- 1 Press the preprogrammed **Transmit Power Level Switch** to toggle the power level between low and high power.
- 2 The display shows **LOW PWR** and the low power icon.  
**OR**  
The display shows **HIGH PWR** and the high power icon.

### Controlling the Display Backlight

You can enable or disable the radio's display backlight as needed, if poor light conditions make the display difficult to read.

#### Procedure:

Press the preprogrammed **Light** button to toggle the backlight on or off.

**OR**

Press any programmable radio controls or buttons to turn the backlight on.

**Note:** The backlight remains on for a preprogrammed time before it automatically turns off completely or returns to the minimum backlight level.

### Turning Voice Mute On or Off

You can enable and disable voice transmission, if needed.

#### Procedure:

- 1 Press the preprogrammed **Voice Mute** button to turn the feature off or on.
- 2 The display momentarily shows **VMUT OFF**, and a short tone sounds, indicating that the feature is disabled.  
**OR**  
The display momentarily shows **VMUT ON**, and a short tone sounds, indicating that the feature is enabled.

### Using the Time-Out Timer

This feature turns off your radio's transmitter. You cannot transmit longer than the preset timer setting.

If you attempt to do so, the radio automatically stops your transmission, and you hear a talk-prohibit tone.

The timer is defaulted at 60 seconds, but it can be preprogrammed from 3 to 120 seconds, in 15-second intervals, or it can be disabled entirely for each radio mode, by a qualified radio technician.

**Note:** You will hear a brief, low-pitched, warning tone four seconds before the transmission times out.

**Procedure:**

- 1 Hold down the **PTT** button longer than the preprogrammed time. You hear a short, low-pitched warning tone, the transmission is cut-off, and the LED goes out until you release the **PTT** button.

---

- 2 Release the **PTT** button. The timer resets.

---

- 3 Press the **PTT** button to re-transmit. The time-out timer restarts and the LED lights up solid red.

---

## Using the Conventional Squelch Operation Features

This feature filters out unwanted calls with low signal strength or channels that have a higher than normal background noise.

### Analog Options

Tone Private Line (PL), Digital Private-Line (DPL), and carrier squelch can be available (preprogrammed) per channel.

Mode	Result
Carrier squelch (C)	You hear all traffic on a channel.
PL or DPL	The radio responds only to your messages.

 **Digital Options**

One or more of the following options may be preprogrammed in your radio. Check with your dealer or system administrator for more information.

Option	Result
Digital Carrier-Operated Squelch (COS)	You hear any digital traffic.
Normal Squelch	You hear any digital traffic having the correct network access code.
Selective Switch	You hear any digital traffic having the correct network access code and correct talkgroup.

 **Using the PL Defeat Feature**

This feature allows you to override any coded squelch (DPL or PL) that might be preprogrammed to a channel. The radio will also unmute to any digital activity on a digital channel.

**Procedure:**

Place the preprogrammed **PL Defeat** switch in the PL Defeat position. You hear any activity on the channel.

**OR**

The radio is muted if no activity is present.

**Note:** When this feature is active, the Carrier Squelch status indicator is displayed.

## Using the Digital PTT ID Feature

This feature allows you to see the radio ID (number) of the radio from whom you are currently receiving a transmission. This ID, consisting up to a maximum of eight characters, can be viewed by both the receiving radio and the dispatcher.

Your radio's ID number is also automatically sent every time the PTT button is pressed. This is a per-channel feature. For digital voice transmissions, your radio's ID is sent continuously during the voice message.

## Using the Smart PTT Feature (Conventional Only)

Smart **PTT** is a per-personality, programmable feature used in conventional radio systems to keep radio users from talking over other radio conversations.

When smart **PTT** is enabled in your radio, you cannot transmit on an active channel.

If you try to transmit on an active smart-**PTT** channel, you hear an alert tone, and the transmission is inhibited. The LED lights up solid yellow to indicate that the channel is busy.

Three variations of smart **PTT** are available:

Transmit Inhibit on Busy Channel with Carrier	You cannot transmit if any traffic is detected on the channel.
Transmit Inhibit on Busy Channel with Wrong Squelch Code	You cannot transmit on an active channel with a squelch code or (if secure-equipped) encryption key other than your own. If the PL code is the same as yours, the transmission is not prevented.
Quick-Key Override	This feature can work in conjunction with either of the two above variations. You can override the transmit-inhibit state by quick-keying the radio. In other words, two <b>PTT</b> button presses within the preprogrammed time limit.

## Voice Announcement

This feature enables the radio to audibly indicate the current feature mode, Zone or Channel the user has just assigned. This audio indicator can be customized per customer requirements. This is typically useful when the user is in a difficult condition to read the content shown on the display.

Each voice announcement is within a limit of three seconds maximum. As much as 2000 unique voice announcements are allowed in a radio. The sum total duration for all voice announcements in a radio shall be no more than 1000 seconds.

**Note:** This feature must be preprogrammed by a qualified radio technician.

The features which Voice Announcement supports are:

- Zone
- Channel
- Scan
- PL Disabled
- Talkaround/Direct
- Tx Inhibit

**Note:** Voice announcements support certain number of zone-channel, but not all.

Seek advice from your dealer or qualified technician for the best selections for this feature.

The two options of priority for the Voice Announcement available are:

- **High** – enables the voice of the feature to announce even when the radio is receiving calls.
- **Low** – disables the voice of the feature from announcing when the radio is receiving calls.

### **Procedure:**

You hear a voice announcement when the features below are preprogrammed in the radio.

- The radio powers up. The radio announces the current zone and channel it is transmitting.
- Press the preprogrammed voice announcement button (which specifically programmed to playback the current zone and channel). The radio announces the current zone and channel it is transmitting.

**Note:** Pressing this preprogrammed playback button will always enable the voice feature to announce in High priority.

All the three programmable buttons at the side of the radio support this feature.

- Change to a new zone. The radio announces the current zone and channel it is transmitting.

- Change to a new channel remaining within the current zone. The radio announces the current channel.
- Press either the preprogrammed button or switch of the radio to launch or terminate Scan, PL Disabled, Talkaround/Direct or Transmit Inhibit. The radio announces the corresponding feature activation.

## Helpful Tips

Take a moment to review the following:

Caring for Your Radio . . . . .	page 44
Cleaning Your Radio . . . . .	page 45
Handling Your Radio . . . . .	page 45
Servicing Your Radio . . . . .	page 46
Taking Care of the Battery. . . . .	page 46
Checking the Battery Charge Status . . . . .	page 46
Battery Recycling and Disposal. . . . .	page 47

## Caring for Your Radio



Caution

- The APX 7000 radio casting has a vent port that allows for pressure equalization in the radio. Never poke this vent with any objects, such as needles, tweezers, or screwdrivers. This could create leak paths into the radio and the radio's submergibility will be lost.

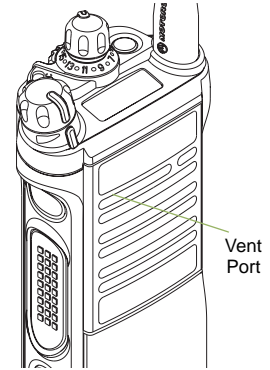

- **(For APX 7000 R Radios Only)**  
The APX 7000 R radio is designed to be submerged to a maximum depth of 6 feet, with a maximum submersion time of 2 hours. Exceeding either maximum limit may result in damage to the radio.





### Caution

- **(For APX 7000 R Radios Only)**  
Elastomer technology materials used for seals in rugged portable radios can age with time and environmental exposure. Therefore, Motorola recommends that rugged radios be checked annually as a preventive measure in order to assure the watertight integrity of the radio. Motorola details the disassembly, test, and reassembly procedures along with necessary test equipment needed to inspect, maintain and troubleshoot radio seals in the radio's service manual.
- If the radio battery contact area has been submerged in water, dry and clean the radio battery contacts before attaching a battery to the radio. Otherwise, the water could short-circuit the radio.
- If the radio has been submerged in water, shake the radio well so that any water that may be trapped inside the speaker grille and microphone port can be removed. Otherwise, the water will decrease the audio quality of the radio.
- Do not disassemble the radio. This could damage radio seals and result in leak paths into the radio. Any radio maintenance should be performed only by a qualified radio technician.

### Cleaning Your Radio

To clean the external surfaces of your radio:

- 1 Combine one teaspoon of mild dishwashing detergent to one gallon of water (0.5% solution).
- 2 Apply the solution sparingly with a stiff, non-metallic, short-bristled brush, making sure excess detergent does not get entrapped near the connectors, controls or crevices. Dry the radio thoroughly with a soft, lint-free cloth.
- 3 Clean battery contacts with a lint-free cloth to remove dirt or grease.



### Caution

Do not use solvents to clean your radio. Spirits may permanently damage the radio housing.

Do not submerge the radio in the detergent solution.

### Handling Your Radio

- Do not pound, drop, or throw the radio unnecessarily. Never carry the radio by the antenna.
- Avoid subjecting the radio to an excess of liquids. Do not submerge the radio unless it is a ruggedized, APX 7000 R model.

- Avoid subjecting the radio to corrosives, solvents or spirits.
- Do not disassemble the radio.
- Keep the accessory-connector cover in place until ready to use the connector. Replace the cover immediately once the accessory has been disconnected.

### **Servicing Your Radio**

Proper repair and maintenance procedures will assure efficient operation and long life for this product. A Motorola maintenance agreement will provide expert service to keep this and all other communication equipment in perfect operating condition. A nationwide service organization is provided by Motorola to support maintenance services. Through its maintenance and installation program, Motorola makes available the finest service to those desiring reliable, continuous communications on a contract basis. For a contract service agreement, please contact your nearest Motorola service or sales representative, or an authorized Motorola dealer.

Express Service Plus (ESP) is an optional extended service coverage plan, which provides for the repair of this product for an additional period of either one or two years beyond the normal expiration date of the standard warranty. For more information about ESP, contact the Motorola Radio Support Center at 3761 South Central Avenue, Rockford, IL 61102 (800) 227-6772 / (847)725-4200.

## **Taking Care of the Battery**

---

### **Checking the Battery Charge Status**

Your radio can indicate the battery's charge status through:

- the LED and sounds.
- the fuel gauge icon on the display.





### **LED and Sounds**

When your battery is low:

- the LED blinks red when the **PTT** button is pressed.
- you hear a low-battery “chirp” (short, high-pitched tone).

### **Fuel Gauge Icon**

A blinking fuel gauge icon (  ) is displayed only when the battery voltage drops to low level. In this case, replace the battery with a fully charged one.

Gauge	Battery Charge
	76% to 100% full
	51% to 75%
	26% to 50%
	11% to 25%
	10% or less (at 10%, the gauge begins blinking)

## Battery Recycling and Disposal

In the U.S. and Canada, Motorola participates in the nationwide Rechargeable Battery Recycling Corporation (RBRC) program for NiCd battery collection and recycling. Many retailers and dealers participate in this program.

For the location of the drop-off facility closest to you, access RBRC's Internet web site at [www.rbrc.com](http://www.rbrc.com) or call 1-800-8-BATTERY. This internet site and telephone number also provide other useful information concerning recycling options for consumers, businesses, and governmental agencies.

## Accessories

For a list of Motorola-approved antennas and other accessories, visit the following website:

<http://www.motorola.com/governmentandenterprise>

On the website, search for *APX 7000 Multi-Band Portable Radio*. You will see the accessories information besides the specifications of the radio. You can also contact your dealer for details. Contact your dealer for details.

The certifications for the accessories are as below.

UHF/700/800 MHz Band (FCC ID: AZ489FT7040)

VHF/700/800 MHz Band (FCC ID: AZ489FT7036)

UHF/VHF Band (FCC ID: AZ489FT4886)

UHF2/VHF Band (FCC ID: AZ489FT4893)

UHF2/700/800 MHz Band (FCC ID: AZ489FT7042)

## Appendix: Maritime Radio Use in the VHF Frequency Range

Take a moment to review the following:

Special Channel Assignments . . . . . page 49

Operating Frequency Requirements . . . . . page 50

### Special Channel Assignments

#### Emergency Channel

If you are in imminent and grave danger at sea and require emergency assistance, use **VHF Channel 16** to send a distress call to nearby vessels and the United States Coast Guard.

Transmit the following information, in this order:

- 1 "MAYDAY, MAYDAY, MAYDAY."
- 2 "THIS IS \_\_\_\_\_, CALL SIGN \_\_\_\_\_."

*State the name of the vessel in distress 3 times, followed by the call sign or other identification of the vessel, stated 3 times.*

- 3 Repeat "MAYDAY" and the name of the vessel.
- 4 "WE ARE LOCATED AT \_\_\_\_\_."

*State the position of the vessel in distress, using any information that will help responders to locate you, e.g.:*

- *latitude and longitude*
- *bearing (state whether you are using true or magnetic north)*
- *distance to a well-known landmark*
- *vessel course, speed or destination*

- 5 State the nature of the distress.
- 6 Specify what kind of assistance you need.
- 7 State the number of persons on board and the number needing medical attention, if any.
- 8 Mention any other information that would be helpful to responders, such as type of vessel, vessel length and/or tonnage, hull color, etc.
- 9 "OVER."
- 10 Wait for a response.
- 11 If you do not receive an immediate response, remain by the radio and repeat the transmission at intervals until you receive a response. Be prepared to follow any instructions given to you.

#### Non-Commercial Call Channel

For non-commercial transmissions, such as fishing reports, rendezvous arrangements, repair scheduling, or berthing information, use VHF Channel 9.

## ■ Operating Frequency Requirements

A radio designated for shipboard use must comply with Federal Communications Commission Rule Part 80 as follows:

- on ships subject to Part II of Title III of the Communications Act, the radio must be capable of operating on the 156.800 MHz frequency
- on ships subject to the Safety Convention, the radio must be capable of operating:
  - in the simplex mode on the ship station transmitting frequencies specified in the 156.025 – 157.425 MHz frequency band, and
  - in the semiduplex mode on the two frequency channels specified in the table below.

**Note:** Simplex channels 3, 21, 23, 61, 64, 81, 82, and 83 cannot be lawfully used by the general public in US waters.

Additional information about operating requirements in the Maritime Services can be obtained from the full text of FCC Rule Part 80 and from the US Coast Guard.

**Table A-1: VHF Marine Channel List**

Channel Number	Frequency (MHz)	
	Transmit	Receive
1	156.050	160.650
2	156.100	160.700

**Table A-1: VHF Marine Channel List (Continued)**

Channel Number	Frequency (MHz)	
	Transmit	Receive
*	156.150	160.750
4	156.200	160.800
5	156.250	160.850
6	156.300	–
7	156.350	160.950
8	156.400	–
9	156.450	156.450
10	156.500	156.500
11	156.550	156.550
12	156.600	156.600
13**	156.650	156.650
14	156.700	156.700
15**	156.750	156.750
16	156.800	156.800
17**	156.850	156.850
18	156.900	161.500
19	156.950	161.550
20	157.000	161.600
*	157.050	161.650
22	157.100	161.700

Table A-1: VHF Marine Channel List (Continued)

Channel Number	Frequency (MHz)	
	Transmit	Receive
*	157.150	161.750
24	157.200	161.800
25	157.250	161.850
26	157.300	161.900
27	157.350	161.950
28	157.400	162.000
60	156.025	160.625
*	156.075	160.675
62	156.125	160.725
63	156.175	160.775
*	156.225	160.825
65	156.275	160.875
66	156.325	160.925
67**	156.375	156.375
68	156.425	156.425
69	156.475	156.475
71	156.575	156.575
72	156.625	—
73	156.675	156.675
74	156.725	156.725

Table A-1: VHF Marine Channel List (Continued)

Channel Number	Frequency (MHz)	
	Transmit	Receive
75	***	***
76	***	***
77**	156.875	—
78	156.925	161.525
79	156.975	161.575
80	157.025	161.625
*	157.075	161.675
*	157.125	161.725
*	157.175	161.775
84	157.225	161.825
85	157.275	161.875
86	157.325	161.925
87	157.375	161.975
88	157.425	162.025

\* Simplex channels 3, 21, 23, 61, 64, 81, 82, and 83 **cannot be lawfully used** by the general public in US waters.

\*\* Low power (1 W) only

\*\*\* Guard band

**Note:** A — in the Receive column indicates that the channel is transmit only.

# Glossary

This glossary is a list of specialized terms used in this manual.

Term	Definition
<b>ACK</b>	Acknowledgment of communication.
<b>Active Channel</b>	A channel that has traffic on it.
<b>Analog Signal</b>	An RF signal that has a continuous nature rather than a pulsed or discrete nature.
<b>ARS</b>	Automatic Registration Service
<b>ASTRO 25 Trunking</b>	Motorola standard for wireless digital trunked communications.
<b>ASTRO Conventional</b>	Motorola standard for wireless digital conventional communications.
<b>Autoscan</b>	A feature that allows the radio to automatically scan the members of a scan list.
<b>Call Alert</b>	Privately page an individual by sending an audible tone.

Term	Definition
<b>Carrier Squelch</b>	Feature that responds to the presence of an RF carrier by opening or unmuting (turning on) a receiver's audio circuit. A squelch circuit silences the radio when no signal is being received so that the user does not have to listen to "noise."
<b>Central Controller</b>	A software-controlled, computer-driven device that receives and generates data for the trunked radios assigned to it. It monitors and directs the operations of the trunked repeaters.
<b>Channel</b>	A group of characteristics such as transmit/receive frequency pairs, radio parameters, and encryption encoding.
<b>Control Channel</b>	In a trunking system, one of the channels that is used to provide a continuous, two-way/data communications path between the central controller and all radios on the system.
<b>Conventional</b>	Typically refers to radio-to-radio communications, sometimes through a repeater (see Trunking).
<b>Conventional Scan List</b>	A scan list that includes only conventional channels.



Term	Definition
<b>Deadlock</b>	Displayed by the radio after three failed attempts to unlock the radio. The radio must be powered off and on prior to another attempt.
<b>Digital Private Line (DPL)</b>	A type of coded squelch using data bursts. Similar to PL except a digital code is used instead of a tone.
<b>Digital Signal</b>	An RF signal that has a pulsed, or discrete, nature, rather than a continuous nature.
<b>Dispatcher</b>	An individual who has radio system management duties.
<b>Dynamic Regrouping</b>	A feature that allows the dispatcher to temporarily reassign selected radios to a single special channel so they can communicate with each other.
<b>Failsoft</b>	A feature that allows communications to take place even though the central controller has failed. Each trunked repeater in the system transmits a data word informing every radio that the system has gone into failsoft.
<b>FCC</b>	Federal Communications Commission.
<b>Hang Up</b>	Disconnect.

Term	Definition
<b>Home screen</b>	The first display information after the radio completes its self test.
<b>KVL</b>	Key-variable loader: A device for loading encryption keys into the radio.
<b>LCD</b>	Liquid crystal display.
<b>LED</b>	Light-emitting diode.
<b>Monitor</b>	Check channel activity by pressing the Monitor button. If the channel is clear, you hear static. If the channel is in use, you hear conversation. It also serves as a way to check the volume level of the radio, since the radio “opens the squelch” when the monitor button is pressed.
<b>Multi-System Talkgroup Scan List</b>	A scan list that can include both talkgroups (trunked) and channels (conventional).
<b>Network Access Code</b>	Network Access Code (NAC) operates on digital channels to reduce voice channel interference between adjacent systems and sites.
<b>NiCd</b>	Nickel-cadmium
<b>NiMH</b>	Nickel-metal-hydride.

Term	Definition
<b>Non-Tactical/ Revert</b>	The user talks on a preprogrammed emergency channel. The emergency alarm is sent out on this same channel.
<b>OTAR</b>	Over-the-air rekeying.
<b>Page</b>	A one-way alert, with audio and/or display messages.
<b>Personality</b>	A set of unique features specific to a radio.
<b>Preprogrammed</b>	Refers to a software feature that has been activated by a qualified radio technician.
<b>Private Line (PL)</b>	A sub-audible tone that is transmitted such that only receivers decoding the tone receives it.
<b>Programmable</b>	Refers to a radio control that can have a radio feature assigned to it.
<b>PTT</b>	Push-To-Talk – the <b>PTT button</b> engages the transmitter and puts the radio in transmit (send) operation when pressed.
<b>Radio Frequency (RF)</b>	The part of the general frequency spectrum between the audio and infrared light regions (about 10 kHz to 10,000,000 MHz).

Term	Definition
<b>Repeater</b>	A conventional radio feature, where you talk through a receive/transmit facility that re-transmits received signals, in order to improve communications range and coverage.
<b>Selective Switch</b>	Any digital P25 traffic having the correct Network Access Code and the correct talkgroup.
<b>Squelch</b>	Special electronic circuitry, added to the receiver of a radio, that reduces, or cuts off, unwanted signals before they are heard in the speaker.
<b>Standby</b>	An operating condition whereby the radio's speaker is muted but still continues to receive data.
<b>Status Calls</b>	Pre-defined text messages that allow the user to send a conditional message without talking.
<b>Tactical/ Non-Revert</b>	The user talks on the channel that was selected before the radio entered the emergency state.
<b>Talkaround</b>	Bypass a repeater and talk directly to another unit for easy local unit-to-unit communications.

Term	Definition
<b>Talkgroup</b>	An organization or group of radio users who communicate with each other using the same communication path.
<b>Trunking</b>	The automatic sharing of communications paths between a large number of users (see Conventional).
<b>Trunking Priority Monitor Scan List</b>	A scan list that includes talkgroups that are all from the same trunking system.
<b>USK</b>	Unique Shadow Key.
<b>Zone</b>	A grouping of channels.

# Commercial Warranty

## Limited Warranty

### MOTOROLA COMMUNICATION PRODUCTS

#### I. WHAT THIS WARRANTY COVERS AND FOR HOW LONG:

MOTOROLA INC. ("MOTOROLA") warrants the MOTOROLA manufactured Communication Products listed below ("Product") against defects in material and workmanship under normal use and service for a period of time from the date of purchase as scheduled below:

ASTRO APX 7000 Portable Units	One (1) Year
Product Accessories	One (1) Year

MOTOROLA, at its option, will at no charge either repair the Product (with new or reconditioned parts), replace it (with a new or reconditioned Product), or refund the purchase price of the Product during the warranty period provided it is returned in accordance with the terms of this warranty. Replaced parts or boards are warranted for the balance of the original applicable warranty period. All replaced parts of Product shall become the property of MOTOROLA.

This express limited warranty is extended by MOTOROLA to the original end user purchaser only and is not assignable or transferable to any other party. This is the complete warranty for the

Product manufactured by MOTOROLA. MOTOROLA assumes no obligations or liability for additions or modifications to this warranty unless made in writing and signed by an officer of MOTOROLA.

Unless made in a separate agreement between MOTOROLA and the original end user purchaser, MOTOROLA does not warrant the installation, maintenance or service of the Product.

MOTOROLA cannot be responsible in any way for any ancillary equipment not furnished by MOTOROLA which is attached to or used in connection with the Product, or for operation of the Product with any ancillary equipment, and all such equipment is expressly excluded from this warranty. Because each system which may use the Product is unique, MOTOROLA disclaims liability for range, coverage, or operation of the system as a whole under this warranty.

#### II. GENERAL PROVISIONS:

This warranty sets forth the full extent of MOTOROLA'S responsibilities regarding the Product. Repair, replacement or refund of the purchase price, at MOTOROLA'S option, is the exclusive remedy. THIS WARRANTY IS GIVEN IN LIEU OF ALL OTHER EXPRESS WARRANTIES. IMPLIED WARRANTIES, INCLUDING WITHOUT LIMITATION, IMPLIED WARRANTIES OF MERCHANTABILITY AND FITNESS FOR A PARTICULAR PURPOSE, ARE LIMITED TO THE DURATION OF THIS LIMITED WARRANTY. IN NO EVENT SHALL MOTOROLA BE LIABLE FOR DAMAGES IN EXCESS OF THE PURCHASE PRICE OF THE PRODUCT, FOR ANY LOSS OF USE, LOSS OF TIME, INCONVENIENCE, COMMERCIAL LOSS, LOST PROFITS OR SAVINGS OR OTHER INCIDENTAL, SPECIAL OR CONSEQUENTIAL DAMAGES ARISING OUT OF THE USE OR

INABILITY TO USE SUCH PRODUCT, TO THE FULL EXTENT SUCH MAY BE DISCLAIMED BY LAW.

### III. STATE LAW RIGHTS:

SOME STATES DO NOT ALLOW THE EXCLUSION OR LIMITATION OF INCIDENTAL OR CONSEQUENTIAL DAMAGES OR LIMITATION ON HOW LONG AN IMPLIED WARRANTY LASTS, SO THE ABOVE LIMITATION OR EXCLUSIONS MAY NOT APPLY.

This warranty gives specific legal rights, and there may be other rights which may vary from state to state.

### IV. HOW TO GET WARRANTY SERVICE:

You must provide proof of purchase (bearing the date of purchase and Product item serial number) in order to receive warranty service and, also, deliver or send the Product item, transportation and insurance prepaid, to an authorized warranty service location. Warranty service will be provided by MOTOROLA through one of its authorized warranty service locations. If you first contact the company which sold you the Product (e.g., dealer or communication service provider), it can facilitate your obtaining warranty service. You can also call MOTOROLA at 1-800-927-2744 US/Canada.

### V. WHAT THIS WARRANTY DOES NOT COVER:

- A) Defects or damage resulting from use of the Product in other than its normal and customary manner.
- B) Defects or damage from misuse, accident, water, or neglect.

- C) Defects or damage from improper testing, operation, maintenance, installation, alteration, modification, or adjustment.
- D) Breakage or damage to antennas unless caused directly by defects in material workmanship.
- E) A Product subjected to unauthorized Product modifications, disassembles or repairs (including, without limitation, the addition to the Product of non-MOTOROLA supplied equipment) which adversely affect performance of the Product or interfere with MOTOROLA's normal warranty inspection and testing of the Product to verify any warranty claim.
- F) Product which has had the serial number removed or made illegible.
- G) Rechargeable batteries if:
  - (1) any of the seals on the battery enclosure of cells are broken or show evidence of tampering.
  - (2) the damage or defect is caused by charging or using the battery in equipment or service other than the Product for which it is specified.
- H) Freight costs to the repair depot.
- I) A Product which, due to illegal or unauthorized alteration of the software/firmware in the Product, does not function in accordance with MOTOROLA's published specifications or the FCC certification labeling in effect for the Product at the time the Product was initially distributed from MOTOROLA.
- J) Scratches or other cosmetic damage to Product surfaces that does not affect the operation of the Product.
- K) Normal and customary wear and tear.

## VI. PATENT AND SOFTWARE PROVISIONS:

MOTOROLA will defend, at its own expense, any suit brought against the end user purchaser to the extent that it is based on a claim that the Product or parts infringe a United States patent, and MOTOROLA will pay those costs and damages finally awarded against the end user purchaser in any such suit which are attributable to any such claim, but such defense and payments are conditioned on the following:

- A) that MOTOROLA will be notified promptly in writing by such purchaser of any notice of such claim;
- B) that MOTOROLA will have sole control of the defense of such suit and all negotiations for its settlement or compromise; and
- C) should the Product or parts become, or in MOTOROLA's opinion be likely to become, the subject of a claim of infringement of a United States patent, that such purchaser will permit MOTOROLA, at its option and expense, either to procure for such purchaser the right to continue using the Product or parts or to replace or modify the same so that it becomes non-infringing or to grant such purchaser a credit for the Product or parts as depreciated and accept its return. The depreciation will be an equal amount per year over the lifetime of the Product or parts as established by MOTOROLA.

MOTOROLA will have no liability with respect to any claim of patent infringement which is based upon the combination of the Product or parts furnished hereunder with software, apparatus or devices not furnished by MOTOROLA, nor will MOTOROLA have any liability for the use of ancillary equipment or software not furnished by MOTOROLA which is attached to or used in connection with the Product. The foregoing states the entire liability of MOTOROLA with respect to infringement of patents by the Product or any parts thereof.

Laws in the United States and other countries preserve for MOTOROLA certain exclusive rights for copyrighted MOTOROLA software such as the exclusive rights to reproduce in copies and distribute copies of such MOTOROLA software. MOTOROLA software may be used in only the Product in which the software was originally embodied and such software in such Product may not be replaced, copied, distributed, modified in any way, or used to produce any derivative thereof. No other use including, without limitation, alteration, modification, reproduction, distribution, or reverse engineering of such MOTOROLA software or exercise of rights in such MOTOROLA software is permitted. No license is granted by implication, estoppel or otherwise under MOTOROLA patent rights or copyrights.

## VII. GOVERNING LAW:

This Warranty is governed by the laws of the State of Illinois, U.S.A.