

# PROFESSIONAL DIGITAL TWO-WAY RADIO DTR600/DTR700 LIMITED KEYPAD PORTABLE RADIO USER GUIDE

en-US

fr-CA

June 2018

©2018 Motorola Solutions, Inc. All rights reserved.



MN004869A01-AA



**MOTOROLA SOLUTIONS**

# Contents

Product Safety and RF Exposure Compliance.....	5	Removing the Li-Ion Battery.....	16
Acoustic Safety.....	5	Holster.....	18
Introduction.....	6	Power Supply, Adapter, and Drop-In Tray Single Unit Charger (SUC).....	18
Package Contents.....	6	Battery Life.....	19
Notice to Users (FCC and Industry Canada).....	7	Battery Status Information.....	19
Batteries and Chargers Safety Information.....	8	Charging with the Drop-In Tray Single Unit Charger (SUC).....	19
Operational Safety Guidelines.....	8	Charging a Stand-Alone Battery.....	20
Chapter 1: Radio Overview.....	10	Estimated Charging Time.....	21
Parts of The Radio.....	10	Charging a Radio and Battery using a MUC.....	21
Radio Specifications.....	11	LED Indicator of Chargers.....	22
Status Indicators.....	12	Chapter 2: Getting Started.....	23
Display Icons.....	12	Turning the Radio On or Off.....	23
Tones.....	12	Adjusting Volume.....	23
Audio Tones.....	12	Checking Battery Status.....	23
Indicator Tones.....	13	Browsing and Selecting Channels.....	24
Battery Features.....	13	Programmable Button Options.....	24
About Li-Ion Battery.....	13	Talk Range.....	24
Battery Recycling and Disposal.....	14	Chapter 3: Radio Call Features.....	25
Installing the Li-Ion Battery.....	14	Talk Permit Tone (TPT).....	25

Canceling Queues.....	25	Viewing Call Log Details.....	34
Private Reply.....	25	Deleting Call Log.....	34
Starting a Private Reply.....	25	Storing Call Log.....	35
Direct Call.....	26	Chapter 5: Advanced Setting.....	36
Making a Direct Call.....	26	Power Save Mode.....	36
Private Reply and Direct Call Frequently Asked Questions.....	27	Enabling Power Save Mode.....	36
Private Call.....	29	Setting the Non-Interference or Privacy Feature.....	36
Making Private Calls.....	29	Configuring the Programmable Button.....	37
Group Call.....	30	Selecting Home Channel.....	37
Making Group Call.....	30	Resetting to Factory Defaults.....	37
Call All Available.....	30	Radio Factory Default Settings.....	38
Starting Call All Available.....	31	Chapter 6: Radio Settings.....	39
Page All Available.....	31	Adjusting Display Brightness.....	39
Starting Page All Available.....	32	Setting Backlight Timer.....	39
Ending a Call.....	32	Setting Menu Timer.....	39
Chapter 4: Advanced Features.....	33	Enabling All Tones.....	40
Contact List.....	33	Enabling Vibrate.....	40
Adding New Contacts.....	33	Enabling Keypad Tone.....	40
Editing Contacts.....	33	Enabling Power Up Tone.....	40
Deleting Contacts.....	34	Selecting Mic Gain for Radio.....	41
Call Log.....	34	Selecting Mic Gain for Accessory.....	41

Setting Languages.....	41	Who is Covered?.....	65
Selecting Configuration Channel List.....	41	How to Obtain Warranty Service or Other Information.....	65
Chapter 7: Customer Programming Software (CPS)...	43	Patent Notice.....	66
Programming the Radio to CPS.....	43	Export Law Assurances.....	66
CPS Basic Menu Instructions.....	43	Appendix A: Accessories.....	67
Chapter 8: Cloning Radios.....	50		
Cloning Mode.....	50		
Cloning with a MUC (Optional Accessory).....	51		
Cloning Radio using the Radio to Radio (R2R) Cloning Cable (Optional Accessory).....	53		
What To Do If Cloning Fails.....	54		
Cloning the Wireless PROFILE ID Number .....	55		
Chapter 9: Troubleshooting.....	56		
Symptoms and Solutions.....	56		
Chapter 10: Use and Care.....	61		
Maintenance.....	61		
Chapter 11: Motorola Solutions Limited Warranty for the United States and Canada.....	63		
What Does this Warranty Cover.....	63		
Products and Accessories.....	63		
Exclusions.....	64		
Software.....	65		

## Product Safety and RF Exposure Compliance



### CAUTION:

Before using this product, read the Product Safety and RF Exposure booklet enclosed with your radio which contains important operating instructions for safe usage and RF energy awareness and control for Compliance with applicable Standards and Regulations.

For a list of Motorola Solutions-approved antennas, batteries, and other accessories, visit the following web site: <http://www.motorolasolutions.com>

## Acoustic Safety



### CAUTION:

Exposure to loud noises from any source for extended periods of time may temporarily or permanently affect your hearing. The louder the radio volume, the less time is required before your hearing can be affected. Hearing damage from loud noises is sometimes undetectable at first and can have a cumulative effect.

To protect your hearing:

- Use the lowest volume necessary to do your job.
- Increase the volume only if you are in noisy surroundings.
- Reduce the volume before connecting headset or earpiece.
- Limit the amount of time you use headsets or earpieces at high volume.
- When using the radio without a headset or earpiece, do not place the radio speaker directly against your ear.
- If you experience hearing discomfort, ringing in your ears, or speeches that are muffled, you should stop listening to your radio through your headset or earpiece, and have your hearing checked by your doctor.

## Introduction

This user guide covers the operation of your radios.

This radio is a product of Motorola Solutions' 80 plus years of experience as a world leader in the designing and manufacturing of communications equipment. This series provides cost-effective communications for businesses such as retail stores, restaurants, schools, construction sites, manufacturing, property and hotel management, and more. Motorola Solutions professional two-way radios are the perfect communications solution for all modern fast-paced industries.

Your dealer or system administrator may have customized your radio for your specific needs. Check with your dealer or system administrator for more information.



### **NOTICE:**

Read this user guide carefully to ensure that you know how to properly operate the radio before use.

For product-related questions, contact: 1-800-448-6686 or visit us at: <http://www.motorolasolutions/DTR600> and <http://www.motorolasolutions/DTR700>.

## Package Contents

The following list encompasses the package content available:

- Radio
- Holster
- Lithium-Ion Battery
- Power Supply
- Quick Reference Guide
- Drop-in Tray Charger with Power Adapter
- Product Safety & RF Exposure Booklet

## Notice to Users (FCC and Industry Canada)

The business two-way radios operate in the license-free 900 MHz ISM Band (902 – 928 MHz) and are subject to the Rules and Regulations of the Federal Communications Commission (FCC).

This device complies with Part 15 of the FCC rules and Industry Canada's license-exempt RSS's per the following conditions:

- This device may not cause harmful interference.
- This device must accept any interference received, including interference that may cause undesired operation.
- Changes or modifications made to this device, not expressly approved by Motorola Solutions, could void the authority of the user to operate this equipment.

To comply with FCC/IC requirements, transmitter adjustments should be made only by or under the supervision of a technically qualified person to perform transmitter maintenance and repairs. Replacement of any transmitter component such as crystal, semiconductor, and

other that are not authorized by the FCC/IC equipment authorization for this radio violates FCC/IC rules.



### **NOTICE:**

Use of this radio outside the country where it was intended to be distributed is subject to government regulations and may be prohibited.

## Batteries and Chargers Safety Information

This document contains important safety and operating instructions. Read these instructions carefully and save them for future reference. Before using the battery charger, read all the instructions and cautionary markings on:

- the charger
- the battery
- the radio attached with battery
- To reduce risk of injury, charge only the rechargeable Motorola Solutions-authorized batteries. Charging the other batteries may cause explosion, personal injury, and damage.
- Use of accessories not recommended by Motorola Solutions may result in fire, electric shock, or injury.
- To reduce damage to the electric plug and cord, pull by plug rather than the cord when disconnecting the charger.
- An extension cord should not be used unless necessary. Use of an improper extension cord may result in fire and electric shock. If an extension cord must be used, make sure that the cord size is 18 AWG

for lengths up to 100 ft (30.48 m), and 16 AWG for lengths up to 150 ft (45.72 m).

- Do not operate the charger if it has been broken or damaged in any way. Take it to any qualified Motorola Solutions service representatives.
- Do not disassemble the charger; it is not repairable and replacement parts are not available. Disassembly of the charger may result in risk of electrical shock or fire.
- To reduce risk of electric shock, unplug the charger from the AC outlet before attempting any maintenance or cleaning.

## Operational Safety Guidelines

- Turn off the radio while charging.
- The charger is not suitable for outdoor use. Use only in dry locations/conditions.
- Connect charger to an appropriately fused and wired supply of the correct voltage (as specified on the product only).
- Disconnect charger from line voltage by removing main plug.



- Connect the equipment to an outlet which is easy to access and near.
- For equipment using fuses, replacements must comply with the type and rating specified in the equipment instructions.
- Maximum ambient temperature around the power supply equipment must not exceed 40 °C (104 °F).
- Power output from the power supply unit must not exceed the ratings stated on the product label located at the bottom of the charger.
- Make sure the cord is not stepped on, tripped over, subjected to water, damage or stress.

## Radio Overview

This chapter explains the buttons and functions to control the radio.

### Parts of The Radio

This chapter explains the buttons and functions to control the radio.

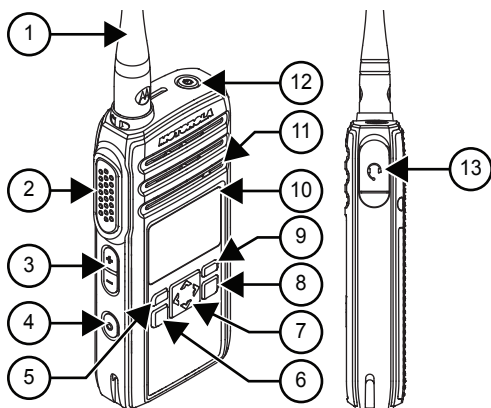

Table 1: Parts of the Radio

Label	Item	Description
1	Antenna	Provides the needed RF amplification when transmitting or receiving.
2	<b>Push-To-Talk (PTT) button</b>	Press to execute voice operations.
3	<b>Volume Up/Down Control buttons</b>	Press to adjust the volume level and to mute the radio.
4	<b>Programmable button</b>	These buttons are field programmable by using the Customer Programming Software (CPS).
5	<b>P1 button</b>	Press to select Info of the radio.
6	<b>Menu/OK button</b>	Press to enter Menu and to confirm selection.
7	<b>4-Way Navigation button</b>	Press to toggle to the left/right/up/down of the selections available in the menu.

Label	Item	Description
8	<b>Home/Back</b> button	Press to cancel and return to a previous menu level; press and hold to return to Home screen.
9	<b>P2</b> button	Press to view the contacts set in the radio.
10	Display	A display that provides visual information about radio features.
11	Speaker	Outputs all tones and audio that are generated by the radio (for example, keypad tones and voice audio).
12	<b>Power</b> button	Press to turn on and off your radio.
13	Audio Accessory Connector	Used to connect compatible audio accessories.

## Radio Specifications

The radio model is printed on the back of the radio with the following information.

**Table 2: Radio Specifications**

Model	Frequency Band	Transmit Power (Watts)	Number of Channels	Antenna
DTR600	ISM 900 MHz	1	30	Removable
DTR700	ISM 900 MHz	1	50	Removable





## Status Indicators

This chapter explains the status indicators and audio tones used in the radio.

## Display Icons

Your radio display shows radio status and menu entries. The following are the icons that appear on the radio display.

**Table 3: Display Icons**

	<p><b>Mute Mode</b> Mute Mode is enabled and speaker is muted.</p>
	<p><b>Tones Disable</b> Tones are turned off.</p>
	<p><b>Vibrate</b> Vibrate mode is enabled.</p>
	<p><b>Mini Negative Notice</b> Failed action taken.</p>



### Mini Positive Notice

Successful action taken.

## Tones

The following are the tones that sound through on the radio speaker.



High Pitched Tone



Low Pitched Tone

## Audio Tones

Audio tones provide you with audible indications of the status, or response to data received on the radio.



### Continuous Tone

A monotone sound. Sounds continuously until termination.



### Periodic Tone

Sounds periodically depending on the duration set by the radio. Tone starts, stops, and repeats itself.



### Repetitive Tone

A single tone that repeats itself until it is terminated by the user.



### Momentary Tone

Sounds once for a short duration set by the radio.

## Indicator Tones

Indicator tones provide you with audible indications of the status after an action to perform a task is taken.



Positive Indicator Tone



Negative Indicator Tone

## Battery Features

The radio comes with standard Lithium-Ion (Li-Ion) batteries.



### NOTICE:

Batteries with different capacities and operational life may be available in the future.

## About Li-Ion Battery

The radio comes with a rechargeable Li-Ion battery. This battery should be fully charged before initial use to ensure optimum capacity and performance.

Battery life is determined by several factors. The critical ones are overcharging of batteries and the average depth of discharge each cycle. Typically, the greater the overcharge and the deeper the average discharge, the fewer cycles a battery will last. For example, a battery which is overcharged and discharged 100% for several times a day, lasts fewer cycles than a battery that overcharges less and is discharged to 50% per day. Battery with minimal overcharge and has an average of 25% discharge, lasts even longer.

Motorola Solutions batteries are designed specifically to be used with a Motorola Solutions charger and vice versa.

Charging batteries with non-Motorola Solutions equipment may lead to battery damage and void the battery warranty. Whenever possible, maintain the battery temperature to 77 °F (25 °C) (room temperature). Charging a cold battery (below 50 °F [10 °C]) may result in leakage of electrolyte and ultimate failure of the battery. Charging a hot battery (above 95 °F [35 °C]) results in reducing discharge capacity and affecting the performance of the radio. Motorola Solutions rapid-rate battery chargers contain a temperature-sensing circuit to ensure that batteries are charged within the temperature limits stated above.

## Battery Recycling and Disposal

Li-Ion rechargeable batteries can be recycled. However, recycling facilities may not be available in all areas. Under various U.S. state laws and the laws of several other countries, batteries must be recycled and cannot be disposed of in landfills or incinerators. Contact your local waste management agency for specific requirements and information in your area. Motorola Solutions fully endorses and encourages the recycling of Li-Ion batteries.

In the U.S. and Canada, Motorola Solutions participates in the nationwide Call2Recycle program for battery collection and recycling. Many retailers and dealers participate in this program. For the location of the drop-off

facility closest to you, access Call2Recycle's Internet web site at <https://www.call2recycle.org/> or call 1-800-8-BATTERY. This internet site and telephone number also provide other useful information concerning recycling options for consumers, businesses, and governmental agencies.

## Installing the Li-Ion Battery



### **NOTICE:**

Ensure the position of the battery flap attached is on top of the battery when installing the battery.

- 1 Align the battery contacts with the contacts inside the battery compartment. Insert the contact side of the battery first. Gently push the battery into place.

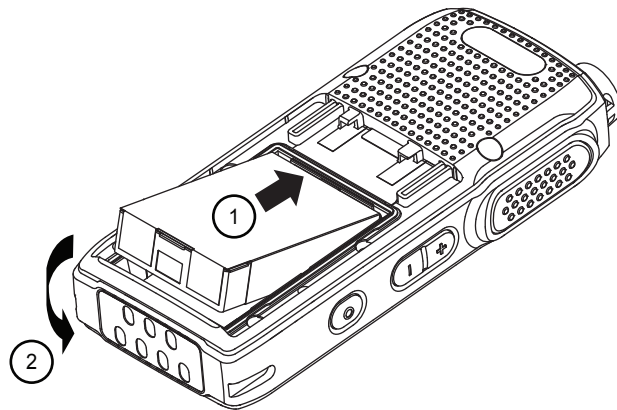

- 
- 2 To attach battery cover, align it in place and slide the battery latch until it snaps into place.

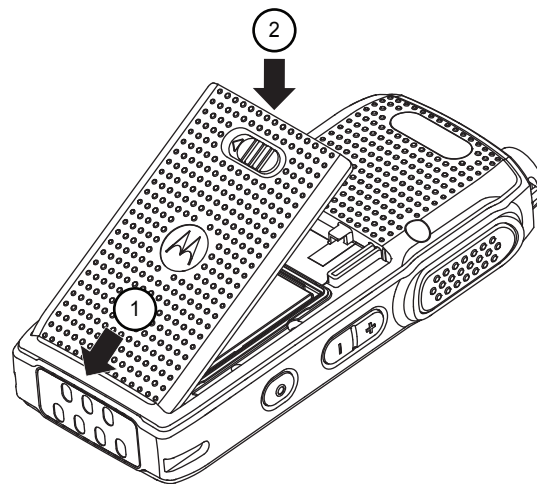

- 
- 3 Slide battery latch into lock position.

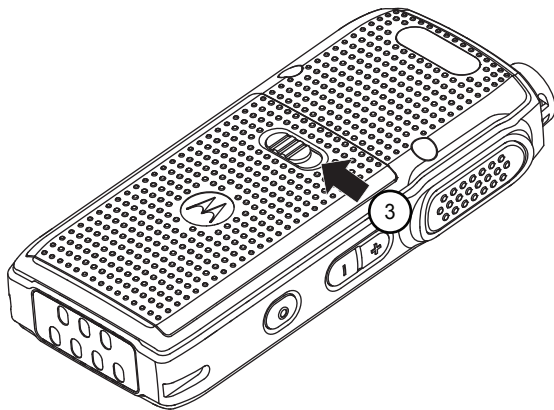

## Removing the Li-Ion Battery

The following steps explain how a Li-Ion battery is removed.

Ensure that the radio is turned off.

- 1 Move the battery latch to the unlock position.

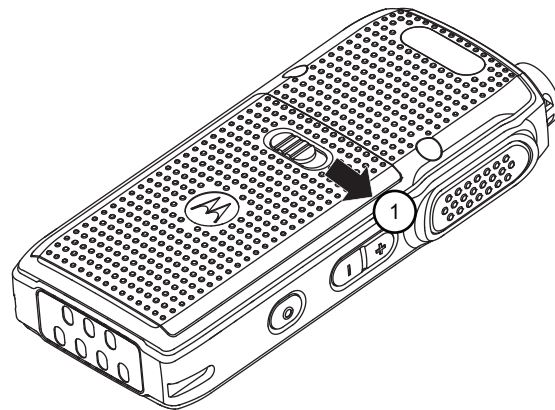

- 2 To remove the battery cover, lift the battery cover up.



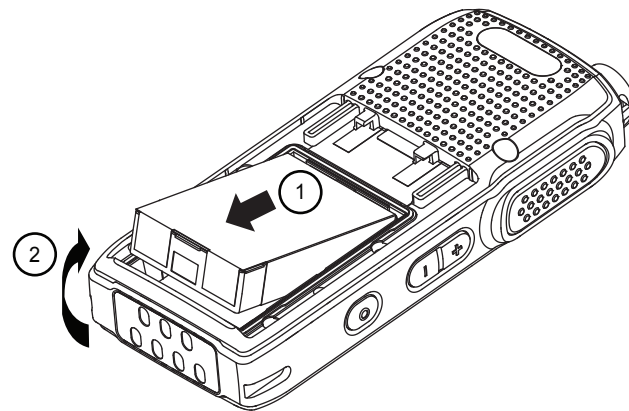
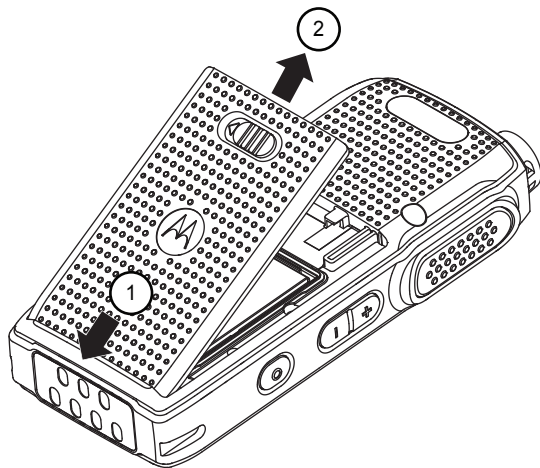

- 
- 3** To remove the battery, lift the battery up from the battery compartment.

## Holster

The following steps explain how to use a holster.

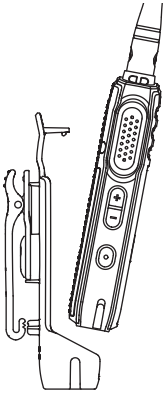

- 1 To insert the radio into the holster, press the radio against the back of the holster until the hooks on the holster are inserted in the top recesses of the battery.
- 2 To remove the radio from the holster, detach the hooks of the holster from the top recesses of the battery using the top tab and slide the radio out from the holster.

## Power Supply, Adapter, and Drop-In Tray Single Unit Charger (SUC)

The radio is equipped with one power supply, one adaptor, and one SUC.

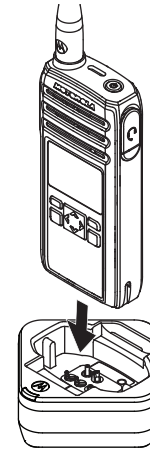

**Figure 1: Charging with SUC**

## Battery Life

The battery lasts longer when Battery Save feature is set to on (enabled by default).

**Table 4: Li-Ion Battery Life**

Battery Type	Battery Save OFF	Battery Save ON
Standard	10.0 – 12.0 Hours	Up to 14 hours







**NOTICE:**

Battery life is estimated based on 5% transmit/5% receive/90% standby standard duty cycle.

## Battery Status Information

Battery status icon displays on the top left of the radio screen.

**Table 5: Battery Status**

Battery Status	Battery Level	Battery Icon
Battery high	71%–100%	
Battery medium	41%–70%	
Battery low	11%–40%	
Battery very low	0%–10%	
Battery critical <sup>1</sup>	0%	



**NOTICE:**

Battery Saver is enabled by default.

## Charging with the Drop-In Tray Single Unit Charger (SUC)

The radio comes with a standard power supply and a SUC.

Turn off the radios before charging and charge best in room temperature.

<sup>1</sup> When the battery is on a critical level, a periodically alert tone sounds.

- 1 Place the SUC on a flat surface.
- 2 Insert the connector of the power supply into the port on the side of the SUC.
- 3 Plug the AC adapter into a power outlet.
- 4 Insert the radio into the SUC with the front of the radio facing the LED of the SUC. Ensure the radio is securely inserted all the way into the charger.

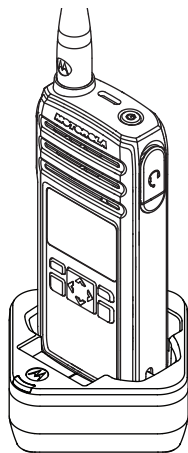

**NOTICE:**

To perform CPS programming, your radio needs to be turned on before placing into the SUC.

The red LED on the SUC illuminates to indicate that the battery is charging.

## Charging a Stand-Alone Battery

Insert the battery into the charging pocket with the front of the battery facing the LED of the Single Unit Charger (SUC).

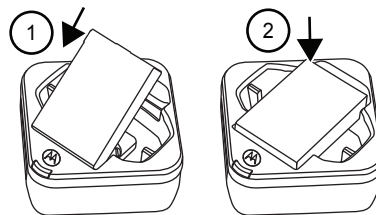

The charger LED flashes a few times to indicate the current battery charge when the radio is inserted in the tray rails. The light on the charger is red to

indicate that the battery is charging and turns green indicates the battery is fully charged.

## Estimated Charging Time

The following table provides the estimated charging time of the battery. For more information, see [Accessories on page 67](#).

**Table 6: Estimated Charging Time**

Charging Solutions	Estimated Charging Time
Standard Battery	≤ 3.50 Hours
Standard	

## Charging a Radio and Battery using a MUC

The Multi-Unit Charger (MUC) is an optional accessory and it has six charging pockets, which allows charging up to six radios or batteries. The batteries can be charged together with or without the radios or placed in the MUC separately.



### NOTICE:

Turn off the radios before charging and it is best to charge at room temperature.

- 1 Place the MUC on a flat surface.

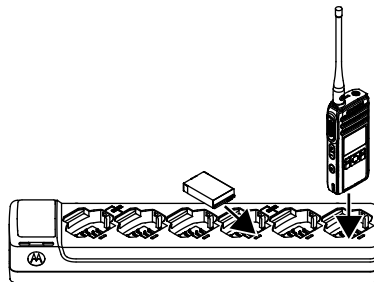

- 2 Insert the power cord plug into the dual pin connector at the bottom of the MUC.
- 3 Connect the power cord into an AC outlet.

- 4 Insert the radio or battery into the charging pocket with the front of the radio or battery facing the LED of the MUC.

The charger LED flashes a few times to indicate the current battery charge when the radio is inserted in the tray rails. The light on the charger is red to indicate that the battery is charging and turns green indicates that the battery is fully charged.

## LED Indicator of Chargers

The following table explains the LED Indicator shown on the chargers during that status.

**Table 7: Indicators**

Status	LED Indicator	Comments
Power On	Green for approximately one second	-
Charging	Steady red	-

<sup>2</sup> Normally, re-positioning the battery pack will correct this issue.

<sup>3</sup> Battery temperature is too warm or too cold or wrong power voltage is used.

Status	LED Indicator	Comments
Charged	Steady green	-
Error <sup>2</sup>	Fast-blinking red	-
Standby <sup>3</sup>	Slowly blinking amber	-
Battery Level Status	Blink red one time	Battery low
	Blink amber two times	Battery medium
	Blink green three times	Battery high

If there is no LED Indication:

- Check if the radio with battery, or the battery alone, is inserted correctly.
- Ensure the power supply cable is securely plugged into the charger socket using an appropriate AC outlet and there is power to the outlet.

## Getting Started

This section helps you to get familiar with the basic operation of the radio.

### Turning the Radio On or Off

- To turn on the radio, press and hold the **Power** button until the radio vibrates and the display shows *Motorola Logo*.
- To turn off the radio, press and hold the **Power** button (~3 seconds) until the power down screen is shown and the power down tone is heard.

### Adjusting Volume

- Press the **(+)** button to increase the volume, or the **(-)** button to decrease the volume,
- To mute, press, and hold the **(-)** button (~2 seconds) and the display shows *Mute icon*.
- To unmute, press, and hold the **(-)** button (~2 seconds) and the radio restores the previous volume.
- To maximize the volume, press and hold the **(+)** button (~2 seconds). The volume scrolls up fast to maximum

volume. You hear the volume beeps increment as the volume increases.



#### NOTICE:

- Do not hold the radio too close to the ear when the volume is high or when adjusting the volume. There are 16 increments of volume. As the **(+)**/**(-)** buttons are pressed, you hear a beep at the current volume level. If device is receiving during volume interaction, received audio is heard at the new volume instead of beeps.
- When using radio with earpiece, make sure to adjust the radio volume to the lowest volume before putting on the earpiece. For more information, refer to [Acoustic Safety on page 5](#). Use only Motorola Solutions approved accessories. For more information, refer to [Accessories on page 67](#).

### Checking Battery Status

Short press the **Power** button to check the battery status. For more information, refer to [Battery Status](#).

The following table describes the icons:

**NOTICE:**

The four levels available for battery status are: High, Medium, Low, and Critical.

## Browsing and Selecting Channels

To select a channel, press the **Up** or **Down** button on the home screen.

## Programmable Button Options

The programmable button comes pre-programmed with the Private Reply Feature.

By using Customer Programming Software (CPS) or the Advanced Settings feature in your radio, you can also configure the programmable button to allow other call features such as Page All Available, Call Available, Direct Call, and Mute. You can also configure to disable these options.

For more details on how to configure the Programmable Button, refer to Advanced Settings or CPS.

## Talk Range

You can communicate with a radio or a group of radios with the same configuration.

**Table 8: Talk Range**

Model	Steel or Concrete Industrial Buildings	Multi-Level Buildings
ISM 900 MHz	Up to 350,000 ft <sup>2</sup>	Up to 30 floors

### Channel

Current channel that your radio is using, depending on radio model.

### Profile ID Number

The default Profile ID number for all radios is **0000**.

All radios in your group (independent channels that users are assigned to) use the same Profile ID number. To avoid interference from other users using the default **0000**, customize your group Profile ID number.

To change the group Profile ID number, refer to the Advanced Settings.



## Radio Call Features

This chapter explains all radio call features available in this radio.

### Talk Permit Tone (TPT)

Talk Permit Tone (TPT) is a quick distinctive double beep tone that sounds after you press the **PTT** button, indicating the channel is free to talk.

TPT is useful in ensuring orderly communications by preventing radios from transmitting over ongoing conversations.

**NOTICE:**

To ensure that your words are not cut off, always wait for the TPT before you start to speak.

### Canceling Queues

To exit queue mode, long press **Programmable** button.

A tone sounds. Your radio exits queue mode and returns to the home screen.

---

### Private Reply

This radio **Top** button is programmed by default as “Private Reply”. Push the **Top** button to capture the radio ID of the person currently talking to your group and right after the transmission is over, push the **PTT** button to talk privately to that person.

Private Reply helps users free the radio channel from unnecessary back and forward chatter by allowing two people to instantly connect privately after a group transmission is over.

### Starting a Private Reply

The **Programmable** button is set to Private Reply feature by default. This feature allows two people to instantly connect privately after a group transmission is over.

**NOTICE:**

There is a channel Hangtime after a Private transmission. By default, the Hangtime is set to 10 seconds.

- 1 To initiate a Private Reply, press the **Programmable** button during a group call.

The display shows `Private Reply On`.

---

- 2 After a group call, press **PTT** button to call privately.

The display shows `Private Reply`.

---

- 3 Wait for the Talk Permit Tone to end and speak.
- 

## Direct Call

The Direct Call Feature allows a user to call another pre-determined user that has been mapped into the radio **Programmable** button one-on-one privately (this feature needs to be pre-programmed via CPS\*). Users also have the option to assign the Direct Call feature to any radio channel instead of the **Programmable** button. This allows the radio **Programmable** button to be available for other radio features (for example: Private Reply or Mute) and Direct Call to be set up in a special channel. (You can set up different direct calls in different channels).



### NOTICE:

To set up the Direct Call function for the first time in your radio, (either **Programmable** button or to a specific channel) you need to use the CPS (Customer Programming Software) which is available for free download at <http://www.motorolasolutions.com>. Once in the CPS, you must read and upload the radio IDs (identified in CPS as “privates”) into the CPS in order to enable Direct Call and assign direct calls to specific radios. For more information refer to [Customer Programming Software](#).

## Making a Direct Call

To initiate Direct Call, you must configure in Customer Programming Software (CPS) or Radio Advanced Setting Menu and select the Private Contact as a target radio.

- 1 Press **Programmable** button during hang time.

The display shows `Direct Call Queue` message and that you are in queue.

---

- 2 When you hear the distinctive Private Talk Permit Tone (TPT), press **PTT** button to reply.

The display shows a Private Call icon and **Direct Call**.

---

## Private Reply and Direct Call Frequently Asked Questions

- 1 Question: If I change my mind and want to exit the request for Private Call (or I pressed the **Programmable** button by mistake), how do I get out of the “private queue” status?

Answer: Long press the **Programmable** button. The radio exits the private queue request and the radio sounds an end tone, returning you to radio normal status.

- 2 Question: What happens if two people (for example user A and C) press their **Programmable** button at the same time to Private Reply or Direct Call User B?

Answer: Pressing the **Programmable** button only queues the radio B ID; therefore, there is no issue if two people press the **Programmable** button at the same time. The issue occurs when these two people press the

**PTT** button at the same time to talk privately to B. Then, whoever presses the **PTT** button faster gets to talk privately to B. The other user hears a “busy” or rejection tone.

- 3 Question: What happens if a person Private Reply or Direct Call User B, but User B does not want to engage in the Private conversation?

Answer: The nature of the radio communication is to allow instant communication without the option to decline radio calls. Therefore, if you are concerned about users disrupting group communications or misusing the Private Reply or Direct Call features, make sure that these features are enabled only on authorized radio users.

- 4 Question: I pressed the Private Reply button but nothing happened (for example, **Programmable** button and instead the radio gives out a busy tone.

Answer: It can be due to different causes such as the **Programmable** button is disabled or the radio could not store the radio ID you wanted to reply to (this is if the **Programmable** button was pressed outside the four seconds Group Hang Time).

- 5 Question: What happens if I want to Private Reply to a person that just finished talking?

Answer: The radios allow for “Group Hang Time” (around four seconds) for you to be able to Private Reply to someone who had just finished talking. Push the **Programmable** button within the hang time window and you hear you hear the distinctive Private Talk Permit Tone (TPT). You can then press the **PTT** button to talk privately.

**6** Question: How exactly does Private Reply work?

Answer: When you press the radio **Programmable** button while User B is talking, your radio “captures” the ID of radio B. Once user B finished talking and you press the **PTT** button, your radio calls radio B privately.

**7** Question: What happens if I want to end the call during a Private Call or Direct Call conversation?

Answer: If you are the user who initiated the Private Reply or Direct Call, you can end the call by long pressing the **Programmable** button. However, if you are the call receiver, you have to wait for the radio to time out (i.e. no communications detected for more than 10 seconds) OR change the channel.

**8** Question: I pressed the **Programmable** button to queue to talk privately to the last person transmitting, but when the user finished talking and I push the **PTT** button to

talk, the radio gave me a busy tone or other strange tones and I could not initiate my conversation.

Answer: It is likely there are other users who were waiting as well to talk to the last person transmitting and someone else pressed the **PTT** button before you, giving you a busy or error tone. Another reason is that the last person transmitting has gone out of transmission range.

**9** If I press the **Programmable** button (either for Private Reply or Direct Call) and I forgot that I wanted to talk privately and I did not push the **PTT** button:

- Question: Would I be still able hear the group conversations in my channel if I do not press the **PTT** button?

Answer: Yes, you should be able to still hear conversations in your channel.

- Question: How long do I have to talk privately to User B?

Answer: There is no time restriction on how long you can take to press the **PTT** button to talk privately to user A, as long as the display shows a Private Reply icon and Private Reply.

- Question: Does the radio gives me any alert to know that I am in still in the private queue mode?

Answer: Yes. While waiting in queue to talk privately, you will receive a call reminder tone after 1 minute of being in queue, followed by another reminder tone 4 minutes after that. No other reminder is heard afterwards, but you remain in queue until Private Reply mode is exited.

- Question: How do I respond to group conversation if I have already pushed the **Programmable** Button (for either Private Reply or Direct Call) ?

Answer: Long Press the **Programmable** button to exit the private queue mode and press the **PTT** button to reply to the group call.

- 10** Question: What happens if I am in queue to talk privately, then the person that was transmitting finished talking and I press the **PTT** button to talk?

Answer: The radio lets you know you are ready for a private communication by playing a distinctive Talk Permit Tone. This prompts from the radio need to happen to ensure there is a private communication established. If you do not have this prompt, it means that you do not have private communication established and you need to try again.

- 11** Question: How do I know when the radio is no longer in Private Mode conversation?

Answer: You are no longer in a private conversation if the radio sounds an end tone.



**NOTICE:**

Remember that the Private Reply and the Direct Call time out after 10 seconds of inactivity in which both users are sent back to the group call mode.

## Private Call

A private call is a call from an individual radio to another individual radio.

When you receive a private call, your radio display shows the call icon, call type, and the contact alias or contact ID.

## Making Private Calls

- 1** To call a private contact, press **P2** → **Contact Alias/Contact ID** → **PTT**.

The display shows the call icon, call type, and the contact alias or contact ID.

- 2** Wait for the Talk Permit Tone to end and speak into the microphone.

**NOTICE:**

If you receive a busy tone and your radio display shows **Call Failed**, the channel is either not available, busy, or there are no users reachable within transmission range.

- 
- 3 Release the **PTT** button to listen.
- 

## Group Call

A group call is a call to or from a group of users.

There are three types of Group Call:

- Profile ID Group
- Public Group
- Private Group

To receive or make calls to a group, configure your radio as part of the group. When the caller group ID matches the configured group ID in your radio, you successfully receive a group call. When the group IDs do not match, your radio ignores the group call request.

## Making Group Call

- 1 To call a group, press **P2** → **Contact Alias/Contact ID** → **PTT**.

The display shows the call icon, call type, and the contact alias or contact ID.

- 2 Wait for the Talk Permit Tone to end and speak into the microphone.

**NOTICE:**

If you receive a busy tone and your radio display shows **Call Failed**, the channel is either not available, busy, or there are no users reachable within transmission range.

- 
- 3 Release the **PTT** button to listen.
- 

## Call All Available

This feature is useful for users with more than one or two channels.

Call All Available feature allows the ability to communicate a message to all available radio users at once in a temporary “super channel group”, without having to change

through each channel individually. Call All Available is a group call to all users available in different channels and users who are not currently tied up in an on-going radio conversation<sup>4</sup>.

Any user who wants to respond to a Call All Available transmission can do so the same way they do when talking on a standard group conversation (by pressing the **PTT** button before talking).

If someone initiates a Call All Available transmission, all users engaged in the Call All Available will have their **Top** button disabled (no Private Reply or Direct Call allowed during this period).

The radio times out a Call All Available communication after four seconds of inactivity. This is to avoid all users being tied up indefinitely in an unnecessary group conversation. This is to avoid all users being tied up indefinitely in an unnecessary group conversation. Call All Available option can be assigned either to the **Top** button or to an extra channel<sup>5</sup>.

## Starting Call All Available

- 1 To turn on the Call All Available feature, press the **Programmable** button.

The display shows `Call All Available On`, indicating that you are in queue.

---

- 2 When your radio is in queue, press **PTT** button.

The display shows `Call All Available`.

---

- 3 Wait for the Talk Permit Tone to end and speak into the microphone.
- 

## Page All Available

This feature is useful for users with more than 1 or 2 channels.

Page All Available allows the ability to communicate a message to all available radio users at once without having

---

<sup>4</sup> This feature does not interrupt ongoing communications.

<sup>5</sup> Use CPS to assign Call All Available to a specific channel.

to change through each channel individually. Page All Available is a one-way group voice announcement to all users in different channels who are not currently tied up in an ongoing radio conversation<sup>6</sup>.

Any user who wants to respond to a Page All Available transmission can do so by replying privately (by pressing the **Top** button before talking). The Page All Available feature is set up this way to avoid all users getting tied up in an unwanted ongoing conversation.

Once the user transmitting in Page All Available mode stops transmitting by releasing the **PTT** button, the Page All Available mode is terminated. Page All Available option can be assigned either to the **Top** button or to an extra channel<sup>7</sup>.

## Starting Page All Available

- 1 To turn on the Page All Available feature, press the **Programmable** button.

The display shows `Page All Available On`, indicating that you are in queue.

---

<sup>6</sup> This feature does not interrupt ongoing communications.

<sup>7</sup> Use CPS to assign Page All Available to a specific channel.

- 2 When your radio is in queue, press **PTT** button.

The display shows `Page All Available`.

---

- 3 Wait for the Talk Permit Tone to end and speak into the microphone.
- 

## Ending a Call

To end a call, do one of the following:

- a Long press **Programmable** button.
  - b Wait for the hang time to expire.
- 

The radio exits and returns to the Home Screen. The radio sounds an end tone.



# Advanced Features

This chapter explains the operations of the features available in your radio.

## Contact List

This feature allows you to save contacts. Each entry corresponds to an alias or ID that you use to initiate a call.

Each entry, depending on context, associates with the different contact type: Private Contact, Private Group, and Public Group.

Each entry within Contacts displays the following information:

- Contact Alias
- Contact ID
- Hopset

**Table 9: Maximum Entries for Each Call Type**

Contact Type	Maximum Number of Entries
Private Contact	200

Contact Type	Maximum Number of Entries
Private Group	50
Public Group	50

## Adding New Contacts

- 1 To add new contacts, press **P2** → **New Contact**.

---

- 2 Enter the new radio ID.  
The display shows a positive mini notice.

---

- 3 Select frequency hopset.  
The display shows a positive mini notice.

---

## Editing Contacts

- 1 To edit contacts, press **P2** → **Edit** → **Contact Number**.

---

- 2 Enter the new contact number.

The display shows a positive mini notice.

---

## Deleting Contacts

- 1 To delete contacts, press **P2** → **Delete**.
- 

- 2 Select **Yes/No**.

The display shows a positive mini notice.

---

## Call Log

Your radio keeps track of all recent outgoing, answered, and missed Private Calls. Use the call log feature to view and manage recent calls.

You can perform the following tasks in each of your call lists:

- Delete
- View Details
- Store

## Viewing Call Log Details

- 1 To scroll through a list of menu items, press the **Menu/OK** button.
- 

- 2 Do one of the following:

- To view incoming call log, select **Call Log** → **Incoming** → **Call 1** → **View Details**
- To view outgoing call log, select **Call Log** → **Outgoing** → **Call 1** → **View Details**

The selected call log detail is shown.

---

## Deleting Call Log

- 1 To scroll through a list of menu items, press the **Menu/OK** button.
- 

- 2 Do one of the following:

- To delete incoming call log, select **Call Log** → **Incoming** → **Call 1** → **Delete** → **Yes**
- To delete outgoing call log, select **Call Log** → **Outgoing** → **Call 1** → **Delete** → **Yes**

- To delete all incoming or outgoing call log, select **Call Log** → **Incoming/Outgoing** → **Delete All** → **Yes**

A tick indicates the call log is deleted.

---

## Storing Call Log

- 1 To scroll through a list of menu items, press the **Menu/OK** button.
- 

- 2 Do one of the following:

- To store incoming call log, select **Call Log** → **Incoming** → **Call 1** → **Store**
- To store outgoing call log, select **Call Log** → **Outgoing** → **Call 1** → **Store**



### **NOTICE:**

Only Private Call can be stored. Do not use this method to store Group Call.

A tick indicates the call log is saved.

---

## Advanced Setting

The Advanced Configuration Mode allows you to configure special settings in your radio without the need of programming cables or additional software.

### Power Save Mode

This feature is designed to conserve radio power consumption and it automatically enables when low battery state occurs.

Power Save Mode can be configured in Customer Programming Software (CPS) and radio menu. It overrides the setting of backlight, vibrate and battery saver by disabling backlight, vibrate and turn on Battery Saver on the radio.

### Enabling Power Save Mode

- 1 To scroll through a list of menu items, press the **Menu/OK** button.
- 2 To enable the Power Save Mode, locate the **Advanced** → **PowerSave**.

- 3 To select, press the **Menu/OK** button.  
A tick indicates Power Save Mode is enabled.

## Setting the Non-Interference or Privacy Feature

This feature ensures improved private communications by configuring an appropriate PROFILE ID number.



### IMPORTANT:

By default, the PROFILE ID number is "0000". Ensure that all your radios are configured with the same PROFILE ID number and is easy to remember.

- 1 Press **Menu/OK** → **Advanced** → **PROFILE ID**.
- 2 Enter a four-digit radio PROFILE ID number.

## Configuring the Programmable Button

- 1 To scroll through a list of menu items, press the **Menu/OK** button.

---

- 2 To configure the Programmable button, locate the **Advanced** → **Prog. Button**.

---

- 3 To scroll through a list of feature to set for the Programmable button, press the **4-Way Navigation** Button.

---

- 4 To select, press the **Menu/OK** Button.  
A tick indicates the current selected feature for the Programmable button.

---

## Selecting Home Channel

- 1 To scroll through a list of menu items, press the **Menu/OK** button.

---

- 2 To select the Home Channel, locate the **Advanced** → **Home Channel**.

---

- 3 To scroll through a list of Home Channel, press the **4-Way Navigation** Button.

---

- 4 To select, press the **Menu/OK** Button.



### NOTICE:

The maximum characters for a Channel Name is 12 characters.

A tick indicates the current selected Home Channel.

---

## Resetting to Factory Defaults

- To reset your radios to the original factory defaults, power up using the **Power** button while pressing **PTT**, **(-)** and **(+)** buttons simultaneously.

The display shows `Factory Reset`.

## Radio Factory Default Settings

**Table 10: Radio Basic Feature Defaults**

Radio Basic Feature	Default
Quick press <b>Power</b> button	Battery Status
Number of channels	Set to maximum number of channels supported by the radio model
<b>Channel/Menu</b> button	Channel change only

**Table 11: Radio Advanced Configuration Mode Defaults**

Radio Advanced Configuration Mode	Default
PROFILE ID Number lock	Off
Radio PROFILE ID Number	0000
Maximum Channels	Set to maximum number of channels supported by the radio model

Radio Advanced Configuration Mode	Default
Direct Call	Off
MIC Gain	Medium
Home Channel	Disabled

**Table 12: Radio Special Mode Defaults**

Radio Special Mode	Default
Enable restore Factory Default reset	On
Enable Advanced Configuration Mode	On
Enable Cloning Mode	On



**NOTICE:**

For all other radio defaults, please refer to the CPS.

## Radio Settings

This sections explains on the basic operation of the radio.

### Adjusting Display Brightness

- 1 To scroll through a list of menu items, press the **Menu/OK** button.
- 2 To select the level of brightness, locate the **Settings** → **Display** → **Brightness**.
- 3 Press the **4-Way Navigation** Button.  
The level of the brightness adjusted.

### Setting Backlight Timer

- 1 To scroll through a list of menu items, press the **Menu/OK** button.
- 2 To select the Backlight Timer, locate the **Settings** → **Display** → **Backlight Timer**.

- 3 To scroll through a list of timer, press the **4-Way Navigation** Button.

- 4 To select, press the **Menu/OK** Button.  
A tick indicates the current selected timer.

### Setting Menu Timer

- 1 To scroll through a list of menu items, press the **Menu/OK** button.
- 2 To select the Menu Timer, locate the **Settings** → **Display** → **Menu Timer**.
- 3 To scroll through a list of timer, press the **4-Way Navigation** Button.
- 4 To select, press the **Menu/OK** Button.  
A tick indicates the current selected timer.

## Enabling All Tones

- 1 To scroll through a list of menu items, press the **Menu/OK** button.

---

- 2 To select the All Tones, locate the **Settings** → **Tones/Alerts** → **All Tones**.

---

- 3 To select, press the **Menu/OK** Button.  
A tick indicates All Tones is enabled.

---

## Enabling Vibrate

- 1 To scroll through a list of menu items, press the **Menu/OK** button.

---

- 2 To enable Vibrate, locate the **Settings** → **Vibrate**.

---

- 3 To select, press the **Menu/OK** Button.  
A tick indicates Vibrate is enabled.

---

## Enabling Keypad Tone

- 1 To scroll through a list of menu items, press the **Menu/OK** button.

---

- 2 To select the Keypad Tone, locate the **Settings** → **Tones/Alerts** → **Keypad Tone**.

---

- 3 To select, press the **Menu/OK** Button.  
A tick indicates Keypad Tone is enabled.

---

## Enabling Power Up Tone

- 1 To scroll through a list of menu items, press the **Menu/OK** button.

---

- 2 To select the Power Up Tone, locate the **Settings** → **Tones/Alerts** → **Power Up**.

---

- 3 To select, press the **Menu/OK** Button.  
A tick indicates Power Up Tone is enabled.

---



## Selecting Mic Gain for Radio

- 1 To scroll through a list of menu items, press the **Menu/OK** button.
- 2 To select the Mic Gain, locate the **Settings** → **Mic Gain** → **Radio**.
- 3 To scroll through a list of Mic Gain, press the **4-Way Navigation** Button.
- 4 To select, press the **Menu/OK** Button.  
A tick indicates the current selected Mic Gain.

## Selecting Mic Gain for Accessory

- 1 To scroll through a list of menu items, press the **Menu/OK** button.
- 2 To select the Mic Gain, locate the **Settings** → **Mic Gain** → **Accessory**.
- 3 To scroll through a list of Mic Gain, press the **4-Way Navigation** Button.

- 4 To select, press the **Menu/OK** Button.  
A tick indicates the current selected Mic Gain.

## Setting Languages

- 1 To scroll through a list of menu items, press the **Menu/OK** button.
- 2 To select the Language, locate the **Settings** → **Language**.
- 3 To scroll through a list of languages, press the **4-Way Navigation** Button.
- 4 To select, press the **Menu/OK** Button.  
A tick indicates the current selected language.

## Selecting Configuration Channel List

- 1 To scroll through a list of menu items, press the **Menu/OK** button.

- 2 To select the Config Channel List, locate the **Settings** → **Config CH List**.

---
- 3 To scroll through a list of channels, press the **4-Way Navigation** Button.

---
- 4 To select, press the **Menu/OK** Button.  
A bullet point indicates the selected enabled channel.

---

## Customer Programming Software (CPS)

To program or change a feature, a CPS is needed to be installed in a computer.

CPS allows to program on features such as Direct Call, Radio Menu Options, Private Groups, Direct Contacts, and Channel Announcement. It gives you the flexibility to disable some options such as Factory Reset and Advanced Configuration to prevent the radio features to be accidentally modified by users. You are allowed to set up a password for profile radio management on your CPS for security purpose.

The CPS software is available for download as free at: <http://www.motorolasolutions/DTR600> and <http://www.motorolasolutions/DTR700>.

## Programming the Radio to CPS

- 1 To connect the radio to the Customer Programming Software (CPS), place the radio into the Single Unit Charger (SUC).

---

- 2 Connect the CPS Programming Cable one side to the SUC and another to the computer.

---

- 3 Turn the switch on the CPS Programming Cable to the Flash position.

---

## CPS Basic Menu Instructions

- 1 Open the CPS software and click on the **RADIO** top tab.

---

- 2 Do one the following:
  - Click on the **READ** tab to read the radio<sup>8</sup>

---

<sup>8</sup> You only need to select the **Radio Type**, if you want to open a new or pre-determined profile. The CPS is smart enough to determine what model it is reading.

- On the drop down menu Radio Type, select DLR if you want to open a new profile or an existing one.

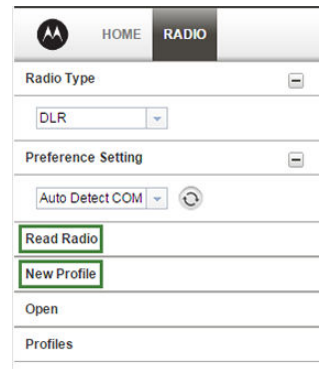
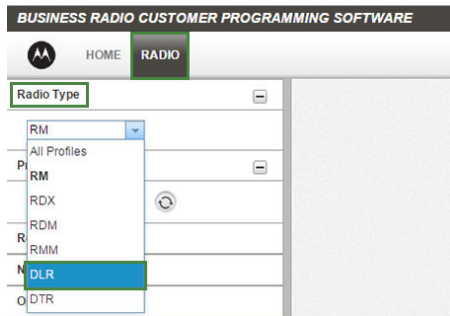

### 3 Do one the following:

- Click Read Radio. Radio sounds a series of beeps to indicate reading is in progress and will upload your radio profile settings.
- Click New Profile to create customized profile based on the default profile.

- 
- ### 4 Scroll down to see more feature options. Customize as necessary.

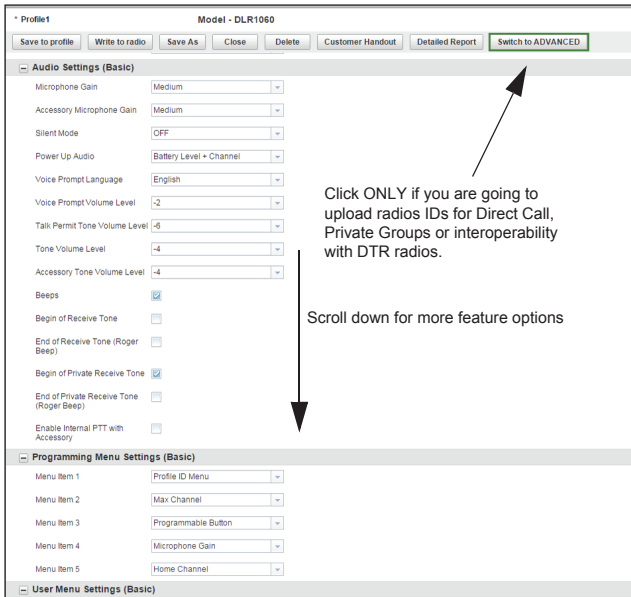

5 You can choose which options you want to be available in the Advanced Configuration Mode. You can add any of the features shown to be accessed by the radio **Channel/Menu** button in the radio basic

operation mode. You can also choose which function you want to have for **Power** button short press.

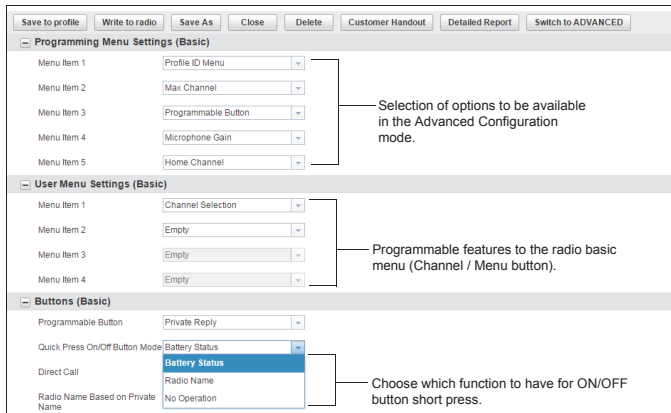

6 You can modify the radio **Top** Button feature by changing the default option.

Save to profile Write to radio Save As Close Delete Customer Handout Detailed Report Switch to ADVANCED

Menu Item 1 Channel Selection

Menu Item 2 Battery Status

Menu Item 3 Radio Name

Menu Item 4 Empty

Programmable features to the radio basic menu (Channel / Menu button).

Buttons (Basic)

Programmable Button Private Reply

Quick Press On/Off Button Mode Private Reply

Direct Call Call All Available

Radio Name Based on Private Name Mute

Radio Name Disabled

List of programmable features for the Top Button.

Profile ID Number information (Basic)

Profile ID 0000

- 7 To enable Direct Call feature in your Basic Menu options, you need to first upload the radio(s) unique private identification (12 digit) number. Click on the Switch to ADVANCED button. Under Privates (Advanced) tab, click Add for CPS to upload radio ID. You can customize the radio ID name under the Name column. Once a radio ID is uploaded, the CPS will give the option to enable Direct Call.

Save to profile Write to radio Save As Close Delete Customer Handout Detailed Report Switch to ADVANCED

Menu Item 1 Channel Selection

Menu Item 2 Battery Status

Menu Item 3 Radio Name

Menu Item 4 Empty

Buttons (Basic)

Programmable Button Private Reply

Quick Press On/Off Button Mode Private Reply

Direct Call Call All Available

Radio Name Based on Private Name Mute

Radio Name Disabled

Direct Call will be listed in this drop down menu of Top Button programmable features once it is enabled.

Profile ID Number information (Basic)

Profile ID 0000

- 8 Customize your PROFILE ID Number for any four digit number different from "0000" to differentiate your radios in a radio fleet.

Radio Name Based on Private Name

Radio Name

Profile ID Number information (Basic)

Profile ID 0000

Channels (Basic)

Home Channel OFF

- 9 The following steps are to assign Home Channel.

- a Home Channel is off by default. If you want to assign a specific channel as your Home Channel, select the channel using the drop down menu under Home Channel. CPS will enable the option to choose any channel<sup>9</sup> you want as your designated Home Channel for the radio you are programming.

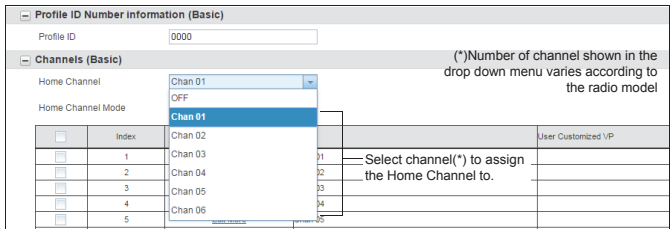

- b Upon setting your Home Channel, CPS will enable the option to set the Home Channel Mode. Select the mode using the drop down menu under Home Channel Mode.

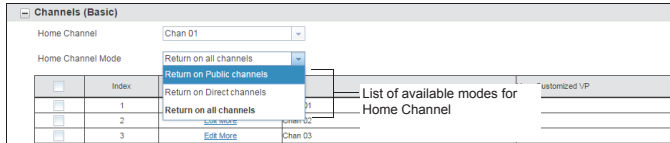

- 10 Customize the name of your channel (alias) by typing in each one of the channel boxes.

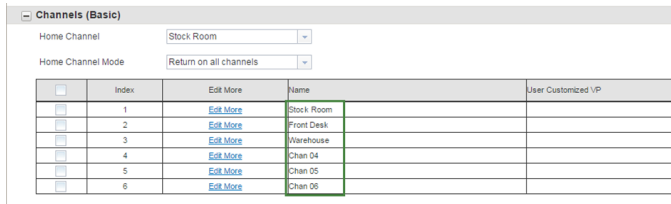

- 11 The following steps are to customized Channels Voice Prompt (VP).

- a You can set your own customized Channels Voice Prompt (VP) in order to enable your

<sup>9</sup> Number of channel shown in the drop down menu varies according to the radio model.

channel name to be announced by the radio.  
Click on **Edit More** to edit the voice prompt.

**Channels (Basic)**

Home Channel: Stock Room

Home Channel Mode: Return on all channels

	Index	Edit More	Name	User Customized VP
<input type="checkbox"/>	1	<a href="#">Edit More</a>	Stock Room	
<input type="checkbox"/>	2	<a href="#">Edit More</a>	Front Desk	
<input type="checkbox"/>	3	<a href="#">Edit More</a>	Warehouse	
<input type="checkbox"/>	4	<a href="#">Edit More</a>	Chan 04	
<input type="checkbox"/>	5	<a href="#">Edit More</a>	Chan 05	
<input type="checkbox"/>	6	<a href="#">Edit More</a>	Chan 06	

- b** After clicking **Edit More**, you will be brought into a different menu to customize your channel name. Select the check box **Enable User Customized VP** to enable the standard Voice Prompt. When there is a speaker icon in the menu, then that channel has customized voice prompt enabled. Click the speaker icon to preview the User Customized VP. If you want to include your own voice recording, click on **Import Voice File**<sup>10</sup>.

Save to profile Write to radio Save As Close Delete Customer Handout Detailed Report Switch to ADVANCED

**Channels - 1**

Name: Stock Room  [Import Voice File](#)

Enable User Customized VP

Disable Channel

Mode: Profile ID Channel Mapping: 1

Speaker icon indicates that customized voice prompt is enabled for this channel

- 12** Once you have changed all the settings, click **Write to radio** in order to program your radio with the new settings. The CPS will display a window confirming the writing (programming of your radio) is successful. You can also save your profile at any time in order to use the same settings when programming other radios by clicking on **Save to profile**. This will save the profile to current default path in your computer. To specify a different path to save the profile, click on the **Save As** button.

<sup>10</sup> .wav audio files supported.



\* Profile1                      Model - DLR1060

✔ Data successfully updated

Save to profile   Write to radio   **Save As**   Close   Delete   Customer Handout   Detailed Report   Switch to ADVANCED

Menu Item 1   Channel Selection

Menu Item 2   Battery Status

Menu Item 3   Radio Name

Menu Item 4   Empty

**Buttons (Basic)**

Programmable Button   Private Reply

Quick Press On/Off Button Mode   Battery Status

Direct Call   OFF

Radio Name Based on Private Name  

Radio Name  

**Profile ID Number information (Basic)**

Profile ID   0000

## Cloning Radios

You can clone radio profiles from one Source radio to a Target radio by using any one of these four methods:

- Using a Multi-Unit Charger (MUC- optional accessory)
- Using two Single Unit Chargers (SUC) and a Radio-to-Radio cloning cable (optional accessory)
- Using CPS (free software download)
- Using Wireless PIN cloning

### Cloning Mode

Power up using the **Power** button while pressing the **PTT** and **(-)** buttons simultaneously. Radio sounds cloning mode beeps followed by the voice prompt “Cloning Mode, Serial” to set your radios into Cloning Mode.

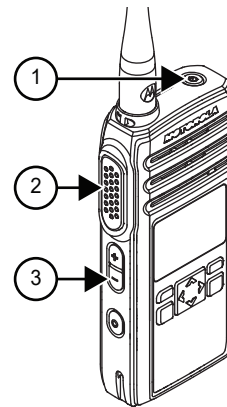

Label	Item
1	<b>Power</b> button
2	<b>PTT</b> button
3	<b>(-)</b> button

## Cloning with a MUC (Optional Accessory)

To clone radios using the Multi-Unit Charger, you must obtain at least two radios:

- a Source radio (radio from which the profiles will be cloned or copied)
- a Target radio (radio to which the profiles will be cloned from the source radio)

The Source radio has to be in Pocket 1, 4, 7, or 10 while the Target radio has to be in Pocket 2, 5, 8, or 11, matching in the MUCs pockets by pairs as follows:

- 1 and 2
- 4 and 5
- 7 and 8
- 10 and 11

MUC pockets numbers should be read from left to right with the Motorola Solutions logo facing front.

Paired Target radios and Source radios must be of the same band type in order for the cloning to run successfully.

When cloning, the MUC does not need to be plugged into a power source, but all radios require charged batteries.

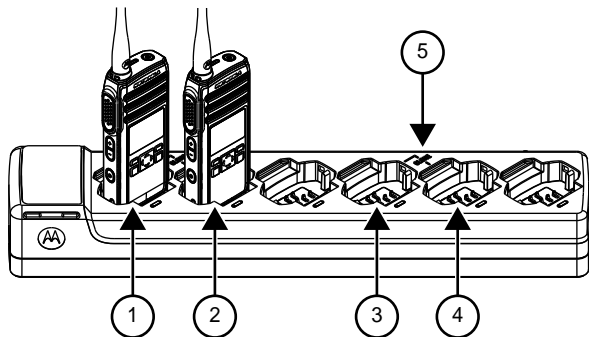

Label	Item
1	Pocket 1
2	Pocket 2
3	Pocket 4
4	Pocket 5
5	"CLONE" symbol

1 Turn on the Target radio and place it into one of the MUC Target Pockets.

---

2 Power the Source radio by performing the following actions:

- a Press the **PTT** button and the **(-)** button simultaneously while turning the radio on.
  - b Wait for three seconds before releasing the buttons until the audible tone and voice announcement “Clone Mode Serial” are heard.
- 

3 Place the Source radio in the source pocket that pairs with the target pocket you chose in [step 1](#) step 1. Press and release the **(+)** button.

After cloning is completed, the Source radio will announce either “pass” (cloning is successful) or “fail” (cloning has failed).

---

4 After completing the cloning process, perform one of the following actions:

- Turn the radios off and on.
  - Exit the 'cloning' mode by long pressing the **PTT** button
- 

5 If cloning fails, refer to [What To Do If Cloning Fails on page 54](#).

When ordering the MUC, refer to P/N# PMLN7136\_.

## Cloning Radio using the Radio to Radio (R2R) Cloning Cable (Optional Accessory)

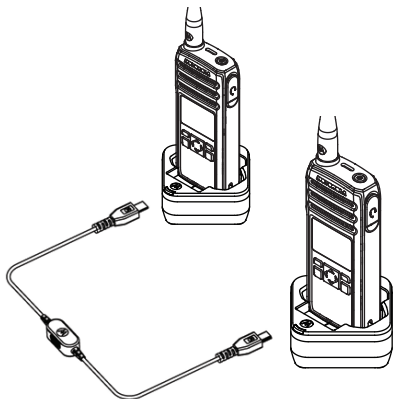

**Figure 2: Radio to Radio Cloning**

- 1 Before starting the cloning process, ensure that you have the following hardware:
  - A Cloning Cable (P/N# HKKN4028\_).
  - A fully charged battery in each of the radios.

- Two Single-Unit Chargers (SUC) for radio cloning.
- Ensure that the radios are turned off

- 
- 2 Unplug any cables (power supply or USB cables) from the SUCs.

- 
- 3 Plug one side of the cloning cable mini USB connector to the first SUC and the other end to the second SUC.



### NOTICE:

During the cloning process, no power is being applied to the SUC. The batteries are not charged. Only data communication is being established between the two radios.

- 
- 4 Turn on the Target Radio and place it into one of the SUCs.
- 
- 5 For the Source Radio, power on the radio with the following sequence:
    - 1 Press the **PTT** button and the **(-)** button simultaneously while turning the radio on. Wait three seconds before releasing the buttons and

you hear a distinctive audible tone saying the word “Clone Mode Serial”.

- 2 Place the Source Radio in its SUC. Press and release the **(+)** button.

- 
- 6 When the cloning is completed, the Source Radio audible voice will announce either “pass” (cloning is successful) or “fail” (cloning process has failed).

- 
- 7 Once the cloning process is completed, turn the Radios off and on or, long press the **PTT** button to exit the ‘cloning’ mode.

## What To Do If Cloning Fails

The radio audible voice announces “Fail” indicating that the cloning process has failed. In the event that the cloning fails, perform each of the following steps before attempting to start cloning process again:

- 1 Ensure that the batteries on both radios are fully charged.

- 
- 2 Check the cloning cable connection on both SUCs .

- 3 Ensure that the battery is engaged properly on the radio.

- 
- 4 Ensure that there is no debris in the charging tray or on the radio contacts.

- 
- 5 Ensure that the Target radio is turned on.

- 
- 6 Ensure that the Source radio is in cloning mode.

- 
- 7 Ensure that the two radios are both from the same frequency band, same region and have the same transmission power.



### **NOTICE:**

This cloning cable is designed to operate only with compatible Motorola Solutions SUC .

---

When ordering Cloning Cable Kit, please refer to P/N# HKKN4028\_. For more information about the accessories, see .

## Cloning the Wireless PROFILE ID Number

The PROFILE ID Number Wireless Cloning feature is useful when you want to clone the PROFILE ID Number for all the radios in your fleet but you do not want to clone particular radio settings that may be unique for each radio (like top button configuration, Microphone Gain, Radio Name etc) across. Wireless PROFILE ID helps to preserve each user radio setup but still ensure that all radios are under the same PROFILE ID Number. It is also useful if you do not have a programming Cable, Cloning Cable or PC easily available

- 1 Power the Source radio by performing the following actions:
    - a Press the **PTT** button and the **(-)** button simultaneously while turning the radio on.
    - b Wait three seconds before releasing the buttons until the audible tone and voice announcement "Clone Mode Serial" are heard.
    - c Press and release the **(-)** button.  
The Source Radio announces "Wireless".
- 

- 2 Power on Target radio by performing the following actions:
  - a Press the **PTT** button and the **(-)** button simultaneously while turning the radio on.
  - b Wait three seconds before releasing the buttons until the audible tone and voice announcement "Clone Mode Serial" are heard.



### NOTICE:

Avoid putting powered on radios (more than seven radios) in a container, other than the Multi-Unit Charger, bunched together, touching each other.

- 3 To start the wireless PROFILE ID Number cloning on the Source radio, press and release the **(+)** button .
    - The radio generates an audible tone.
    - After cloning is completed, the Source radio will announce either "pass" (cloning is successful) or "fail" (cloning has failed).
    - On the Target radio, the radio receives the PROFILE ID Number information. The Target radio will announce either "pass" (cloning is successful) or "fail" (cloning has failed).
-

## Troubleshooting

The following table explains the ways to troubleshoot if the symptom occurred:

### Symptoms and Solutions

If...	Then...
No Power	<p>Recharge or replace the Li-Ion battery.</p> <p>Extreme operating temperatures may affect battery life.</p> <p>Refer to <a href="#">About Li-Ion Battery on page 13</a></p>
Unable to read the radio (using the CPS)	<p>Ensure that one side of the programming cable is connected to the radio and the other side of the programming cable is connected to the USB port.</p> <p>Verify that the switch on the programming cable is set at "Digital"</p>

If...	Then...
	<p>position or "Flash" position in older version programming cable.</p> <p>Ensure that the radio is positioned correctly inside the Single Unit Charger (radio making proper contact with the charger).</p>
Radio generates continuous tone when <b>PTT</b> is pressed	<p>Radio does not transmit when it is receiving as receive mode has higher priority than transmit mode. Press the <b>PTT</b> button again when receive mode ends. Refer to <a href="#">Transmitting and Receiving</a>.</p>
Radio does not transmit when pressing the radio <b>PTT</b> button	<p>If there are other users who are using the channel, the radio does not transmit. Try again after verifying that nobody else is talking.</p> <p>By default, the <b>PTT</b> button is disabled on the radio whenever there is an earpiece connected to it.</p> <p>Make sure to use the earpiece inline <b>PTT</b> button to transmit instead.</p>



---

If...	Then...
Hearing conversation from other users that are not within your channel	<p>If you hear conversations from other users that do not belong to your radio fleet, it means that your radios are set up with the same Profile ID as your neighbors.</p> <p>Likely both of you have the radios set to the default PROFILE ID Number "0000".</p> <p>Customize your PROFILE ID with a 4-digit number for all your radios.</p> <p>Refer to <a href="#">PROFILE ID Number – Current Value</a> for more information.</p>

---

Hearing crackling noises when nobody is talking	Sometimes users inadvertently press the radio <b>PTT</b> button against objects while wearing the radio on their belts or pockets. When they do this, the radio starts transmitting and holding the channel therefore generating strange noises. Using earpieces reduce the likelihood of this happening.
---	---

---

---

If...	Then...
	Ensure that everybody in your team is aware of proper operation of the radios.
Audio quality not good enough	<p>Radio settings might not be matching up correctly. Double check to ensure that the radio settings are identical in all radios.</p> <p>Go into Advanced Configuration Mode and adjust the microphone sensitivity gain (MIC Gain).</p> <p>For more information, refer to <a href="#">Advanced Setting on page 36</a></p>
Audio sounds garbled/robotic	Digital technology gives you the advantage to experience clear audio up to the edge of the range. However, when maximum transmission range has been reached, audio may sound garbled just before the transmission is lost completely. To avoid this problem, ensure that you are within transmission range.

---

If...	Then...
Transmit audio is low	<p>Hold the radio vertically 1 inch to 2 inches from mouth when talking.</p> <p>For accessory, hold the accessory microphone 2 inches to 3 inches from mouth when talking.</p>
While talking on the radio, a loud tone interrupted the conversation	<p>When talking on the radio, make sure not to release the <b>PTT</b> button at any moment. Whether you are using the <b>PTT</b> button on the radio or using an in-line <b>PTT</b> in an earpiece accessory, always press the <b>PTT</b> button firmly until the transmission is finished.</p> <p>Releasing the <b>PTT</b> button while transmitting and trying to immediately press the <b>PTT</b> button again causes the radio to give you a loud denial tone.</p> <p>If you press the <b>PTT</b> button to transmit and a busy tone is received instead of a TPT, this means the channel is either not available, busy</p>

If...	Then...
	or there are no users reachable within transmission range.
Limited talk range	<p>Steel and/or concrete structures, heavy foliage, buildings, or vehicles decrease range. Check for clear line of sight to improve transmission.</p> <p>Wearing radio close to body such as in a pocket or on a belt decreases range. Change location of radio. To increase range and coverage, you can reduce obstructions. Radios provide greater coverage in industrial and commercial buildings</p> <p>Refer to <a href="#">Transmitting and Receiving</a>.</p>
Radio echo feedback	All radios produce strong voice/ audio feedback if they are too close to each other and their volume is set too high. Lower the volume in your radio. Using earpieces can also help reduce audio feedback if radios are too close.

---

If...	Then...
Message not transmitted or received	<p>Ensure that the <b>PTT</b> button is completely pressed when transmitting.</p> <p>Confirm that the radios have the same settings and PROFILE ID. Ensure that radios are on the same channel.</p> <p>Ensure that you hear the Talk Permit Tone before talking. Speaking before hearing the tone results in cutting out the first few words of the transmission. Refer to <a href="#">Transmitting and Receiving</a> for further information.</p> <p>Recharge, replace and/or reposition the batteries. See <a href="#">About Li-Ion Battery on page 13</a>.</p> <p>Obstructions and operating indoors, or in vehicles, may create interferences. Change locations. See <a href="#">Transmitting and Receiving</a>.</p>
Heavy static or interference	Radios are too close; they must be at least five feet apart.

---

---

If...	Then...
	<p>Radios are too far apart or obstacles are interfering with transmission.</p> <p>See <a href="#">Transmitting and Receiving</a>.</p>
Low batteries	<p>Recharge or replace Li-Ion battery.</p> <p>Extreme operating temperatures affect battery life.</p> <p>See <a href="#">About Li-Ion Battery on page 13</a>.</p>
Low battery indicator is blinking although new batteries are inserted	Refer to <a href="#">Installing Li-Ion Batteries</a> and <a href="#">About Li-Ion Battery on page 13</a> .
Battery does not charge although it has been placed in the drop-in charger for a while	<p>Verify that the drop-in tray charger is properly connected and corresponds with a compatible power supply.</p> <p>Refer to <a href="#">Charging with the Drop-In Tray Single Unit Charger (SUC)</a> on</p>

---

---

**If...**

**Then...**

---

[page 19](#) and [Charging A Stand-Alone Battery](#).

Check the charger LEDs indicators to see if the battery has a problem.

See [Radio Status](#).

---

# Use and Care

This chapter explains the maintenance of the radio.

## Maintenance



Do not immerse in water

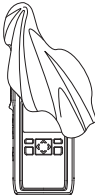

Use a soft damp cloth to clean the exterior



Do not use alcohol or cleaning solutions

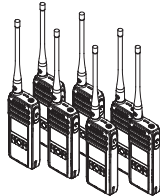

Do not place more than seven radios turned on, too close to each other in a container

### If the radio is submerged in water,



## English

Turn radio off and remove  
the battery

Dry with soft cloth

Do not use radio until com-  
pletely dry

-

---

# Motorola Solutions Limited Warranty for the United States and Canada

## What Does this Warranty Cover

Subject to the exclusions contained below, Motorola Solutions, Inc. warrants its telephones, pagers, and consumer and business two way radios (excluding commercial, government or industrial radios) that operate via Family Radio Service or General Mobile Radio Service, Motorola Solutions-branded or certified accessories sold for use with these Products (“Accessories”) and Motorola software contained on CD-ROMs or other tangible media and sold for use with these Products (“Software”) to be free from defects in materials and workmanship under normal consumer usage for the period(s) outlined below.

This limited warranty is a consumer's exclusive remedy, and applies as follows to new Motorola Products, Accessories and Software purchased by consumers in the United States, which are accompanied by this written warranty.

## Products and Accessories

The table shows the length of coverage of each of the products and accessories.

Products Covered	Length of Coverage
Products and Accessories as defined above, unless otherwise provided for below	One (1) year from the date of purchase by the first consumer purchaser of the product unless otherwise provided for below.
Decorative Accessories and Cases. Decorative covers, bezels, Phone-Wrap™ covers and cases	Limited lifetime warranty for the lifetime of ownership by the first consumer purchaser of the product.
Business Two-way Radio Accessories	One (1) year from the date of purchase by the first consumer purchaser of the product.
Products and Accessories that are Repaired or Replaced	The balance of the original warranty or for ninety (90) days from the date returned to the consumer, whichever is longer.

Products Covered	Length of Coverage
Two-way Radio	Two (2) years from the date of purchase by the first consumer purchaser of the product.

## Exclusions

### Normal Wear and Tear

Periodic maintenance, repair and replacement of parts due to normal wear and tear are excluded from coverage.

### Batteries

Only batteries whose fully charged capacity falls below 80% of their rated capacity and batteries that leak are covered by this limited warranty.

### Abuse and Misuse

Defects or damage that result from:

- improper operation, storage, misuse or abuse, accident or neglect, such as physical damage (cracks, scratches, etc.) to the surface of the product resulting from misuse

- contact with liquid, water, rain, extreme humidity or heavy perspiration, sand, dirt or the like, extreme heat, or food
- use of the Products or Accessories for commercial purposes or subjecting the Product or Accessory to abnormal usage or conditions
- other acts which are not the fault of Motorola Solutions, are excluded from coverage.

### Use of Non-Motorola Solutions Products and Accessories

Defects or damage that result from the use of Non-Motorola Solutions branded or certified Products, Accessories, Software or other peripheral equipment are excluded from coverage.

### Unauthorized Service or Modification

Defects or damages resulting from service, testing, adjustment, installation, maintenance, alteration, or modification in any way by someone other than Motorola Solutions, or its authorized service centers, are excluded from coverage.

### Altered Products

Products or Accessories with:

- serial numbers or date tags that have been removed, altered or obliterated



- broken seals or that show evidence of tampering
- mismatched board serial numbers
- nonconforming or non-Motorola Solutions housings, or parts, are excluded from coverage

**Communication Services**

Defects, damages, or the failure of Products, Accessories or Software due to any communication service or signal you may subscribe to or use with the Products Accessories or Software is excluded from coverage.

## Software

Products Covered	Length of Coverage
Software  Applies only to physical defects in the media that embodies the copy of the software (e.g. CDROM, or floppy disk).	Ninety (90) days from the date of purchase.

## Exclusions

### Software Embodied in Physical Media

No warranty is made that the software will meet your requirements or will work in combination with any hardware or software applications provided by third parties, that the operation of the software products will be uninterrupted or error free, or that all defects in the software products will be corrected.

### Software not Embodied in Physical Media

Software that is not embodied in physical media (e.g. software that is downloaded from the internet), is provided “as is” and without warranty.

## Who is Covered?

This warranty extends only to the first consumer purchaser, and is not transferable.

## How to Obtain Warranty Service or Other Information

Contact your Motorola Solutions point of purchase.

## Patent Notice

This product is covered by one or more of the following United States patents.

5896277 5894292 5864752 5699006 5742484 D408396  
D399821 D387758 D389158 5894592 5893027 5789098  
5734975 5861850 D395882 D383745 D389827 D389139  
5929825 5926514 5953640 6071640 D413022 D416252  
D416893 D433001

## Export Law Assurances

This product is controlled under the export regulations of the United States of America. The Government of the United States of America may restrict the exportation or re-exportation of this product to certain destinations. For further information, contact the U.S. Department of Commerce.

For questions or comments related to this product, please contact Motorola Solutions 1-800-448-6686 or visit us at: <http://www.motorolasolutions/DTR600> and <http://www.motorolasolutions/DTR700>.

# Accessories

The following tables are the accessories list.

**Table 13: Antenna**

Part No.	Description
PMAF4024_	Whip Antenna 900–928 MHz

**Table 14: Audio Accessories**

Part No.	Description
HKLN4599_	Earpiece with <b>PTT</b> , Mic, Slim Plug
HKLN4601_	Surveillance Earpiece with <b>PTT</b> , Slim Plug
HKLN4604_	Swivel Earpiece with <b>PTT</b> , Slim Plug
HKLN4608_	Transparent Acoustic Tube Replacement Part

**Table 15: Battery**

Part No.	Description
PMNN4578_	Li-Ion Battery 2500 mAh

**Table 16: Cables**

Part No.	Description
HKKN4027_	Business Radio CPS Cable Kit
HKKN4028_	Business Radio Cloning Cable Kit

**Table 17: Chargers**

Part No.	Description
PMPN4469_	DTR Single-Unit Charger (SUC), 3 W Power Supply, North America
PMLN4465_	DTR 6-Pocket Multi-Unit Charger (MUC), North America

**Table 18: Power Supplies**

Part No.	Description
PS000228A01_	3 W Power Supply, Micro-usb

<b>Part No.</b>	<b>Description</b>
PS000227A11_	5 W Power Supply, Micro-usb

**Table 19: Carry Accessories**

<b>Part No.</b>	<b>Description</b>
PMLN7939_	DTR Swivel Clip Holster Kit

MOTOROLA, MOTO, MOTOROLA SOLUTIONS and the Stylized M Logo are trademarks or registered trademarks of Motorola Trademark Holdings, LLC and are used under license. All other trademarks are the property of their respective owners. © 2018 Motorola Solutions, Inc. All rights reserved.

