

<p>MOTOROLA PENANG ADV. COMM. LABORATORY Motorola Solutions Malaysia SDN BHD, Plot 2A, Medan Bayan Lepas, Mukim 12 S.W.D, 11900 Bayan Lepas, Penang, Malaysia.</p>	<p>FCC/ISED TEST REPORT Report Revision : Rev.B</p>
<p>Date/s Tested : 5-AUG-2023 - 26-AUG-2023 Report Issue Date : 25-OCT-2023 Manufacturer : Motorola Solutions Malaysia SDN BHD Manufacturer Address : Plot 2A, Medan Bayan Lepas, Mukim 12 SWD, 11900 Bayan Lepas, Penang, Malaysia Requestor : TAI, WEN QI Product Type : Hand-held Product Version (PMN) : SL300 Model Number (HVIN) : AAH88QCP9JA2AN; IC Model: PMUE4541CAMNAA Frequency Band : 403-470MHz Max RF Output Power : 2.4 Watts (Analog) / 3.3 Watts (Digital) Applicant Name : Motorola Solutions Inc Applicant Address : 8000 West Sunrise Boulevard, Fort Lauderdale, Florida 33322</p> <p>ISED Registrations : MY0001 FCC Registrations : 461337 Firmware Version (FVIN) : D01.23.02.0018</p> <p>The equipment was tested accordance to the requirement listed below:</p> <p>(LMR) FCC 47 CFR Part 2/ 22 / 90 PASS ISED RSS- Gen Issue 5 / 119 Issue 12</p>	
<p>This report shall not be reproduced without written approval from an officially designated representative of the Motorola Penang Adv. Comm. Laboratory. The results and statements contained in this report pertain only to the device(s) evaluated.</p>	
<p>Prepared By:  _____ MUHAMMAD HAZIM Test Personnel</p>	<p>Approved Signatory:  _____ MAHESHVARAN A/L RAJAGOPAL Responsible Engineer</p>

Table of Contents

Report Revision History	3
1.0 General Information.....	4
2.0 Summary of Test Results	5
3.0 Measurement Uncertainty.....	6
4.0 Equipment List.....	7
5.0 Test Condition.....	10
5.1. Transmitter Test Conditions	10
6.0 Transmitter Test Parameters	11
6.1. RF Output Power	11
6.1.1. Test Setup	11
6.1.2. Test Result	11
6.2. Frequency Stability	12
6.2.1. Test Setup	12
6.2.2. Test Result	13
6.2.3. Test Limit.....	14
6.3. Modulation Characteristics	15
6.3.1. Test Setup	15
6.3.2. Test Result	16
6.3.3. Test Limit.....	18
6.4. Modulation Limiting.....	19
6.4.1. Test Setup	19
6.4.2. Test Result	20
6.4.3. Test Limit.....	21
6.5. Occupied Bandwidth.....	22
6.5.1. Test Setup (Analog).....	22
6.5.2. Test Result (Analog).....	23
6.5.3. Test Setup (Digital).....	27
6.5.4. Test Result (Digital).....	28
6.5.5. Test Limit.....	33
6.6. Band Edge Conducted Spurious Emission (Part 22)	34
6.6.1. Test Setup (Analog).....	34
6.6.2. Test Result (Analog).....	35
6.6.3. Test Setup (Digital).....	36
6.6.4. Test Result (Digital).....	37
6.6.5. Test Limit.....	37
6.7. Transient Frequency Behavior.....	38
6.7.1. Test Setup	38
6.7.2. Test Result	39
6.7.3. Test Limit.....	41
6.8. Adjacent Channel Power.....	42
6.8.1. Test Setup (Analog).....	42
6.8.2. Test Result	42
6.8.3. Test Setup (Digital).....	43

6.8.4. Test Result 43
 6.8.5. Test Limit..... 44
 6.9. Conducted Spurious Emission 46
 6.9.1. Test Setup 46
 6.9.2. Test Result (Analog)..... 47
 6.9.3. Test Result (Digital)..... 55
 6.9.4. Test Limit..... 62
 6.10. Radiated Spurious Emission 63
 6.10.1. Test Setup 63
 6.10.2. Test Result (Analog)..... 64
 6.10.3. Test Result (Digital)..... 72
 6.10.4. Test Limit..... 79
 6.11. Effective Radiated Power (ERP) 80
 6.11.1. Test Setup 80
 6.11.2. Test Result 80
 6.11.3. Test Limit..... 80
 6.12. GNSS (EIRP for 1559 - 1610MHz)..... 81
 6.12.1. Test Setup 81
 6.12.1. Test Result 81
 6.12.2. Test Limit..... 81

Report Revision History

Revision History	Description	Date	Originator
Rev. A	Initial Report	28-AUG-2023	HAZIM
Rev. B	Updated Model Number (HVIN)	24-OCT-2023	HAZIM

1.0 General Information

EUT Description:

Technologies	Land Mobile Radio (LMR)
Modulation Type	Analog, 4FSK

The EUT contains following accessory devices and data cable:

Item	Brand	Model or P/N
BATTERY PACK,BATT LIION 2300T	MOTOROLA	PMNN4468B
PROGRAMMING, TEST & ALIGNMENT CABLE	MOTOROLA	CB000262A01

General Description of Applied Standards

The EUT is a RF Product. According to the specifications of the manufacturer, the EUT is to comply with the requirements of the following standards:

ANSI C63.26-2015

No modifications were done to the UUT to facilitate the tests in this report.

Deviation from standard

Not applicable as no deviation from standard test method

Antenna gain disclaimer

Antenna gain information is provided by customer. The validity of the results is dependent upon this information. The lab will not be held accountable in the event the supplied information affects compliance.

Test configuration of EUT

All relevant configurations involving radio models and accessories (including chargers, batteries, and antennas) were assessed. Only worst case configurations will be included in this report.

2.0 Summary of Test Results

FCC General Rules Part (47CFR)	ISED General Rules Part	Test Item	Result	Remarks	Serial number tested
2.1046(a), 22.565(f)	RSS-119	RF Power Output	Pass		546TZP0420
2.1055, 22.355, 90.213	RSS-119	Frequency Stability	Pass		546TZP0420
2.1047	-	Audio Frequency Response	Pass		546TZP0420
-	-	Audio Low Pass Filter Response	NA		
2.1047	-	Modulation limiting	Pass		546TZP0420
2.1049, 22.359, 90.210	RSS-119	Occupied Bandwidth	Pass	16K0F3E – 15.002 kHz 11K0F3E – 9.8464kHz 7K60F1D/FXD – 6.972 kHz 7K60F1E/FXE – 6.5755 kHz 7K60F1W – 6.7430 kHz	546TZP0420
2.1051, 22.359 (a), (b)	-	Band Edge Conducted Spurious Emission	Pass		546TZP0420
90.214	RSS-119	Transient Frequency Behavior	Pass		546TZP0420
-	RSS-119	Adjacent Channel Power	NA		
2.1051, 22.359, 90.210	RSS-119	Conducted Spurious Emissions	Pass	Worst case: -39.94 dBm	546TZP0420
2.1051, 22.359, 90.210	RSS-119	Radiated Spurious Emission	Pass	Worst case: -47.0578 dBm (margin: -34.0578 dB) (Noise Floor)	546TZP0405
-	-	GNSS (EIRP for 1559 – 1610MHz)	NA		
-	-	Effective Radiated Power (ERP)	NA		

NA → Not Applicable

3.0 Measurement Uncertainty

Measurement	Frequency	Expended Uncertainty (k=1.96) (±)
AC Power Line Conducted Spurious Emission	150KHz ~ 30MHz	3.48 dB
Radiated Emissions up to 1 GHz dB μ V/m (Field Strength)	30MHz ~ 1000MHz	5.88 dB
Radiated Emissions above 1 GHz dB μ V/m (Field Strength)	1GHz ~ 18GHz	5.84 dB
	18GHz ~ 40GHz	6.02 dB
Radiated Emissions dBm (ERP/EiRP)	30MHz ~ 18GHz	4.03 dB
Conducted Spurious Emissions	9kHz ~ 12.75GHz	2.82 dB
Frequency Stability	9kHz ~ 12.75GHz	0.0085 ppm
Audio Frequency Response / Low Pass Filter Response	300Hz – 20kHz	4.09 %
Modulation Limiting	300Hz – 3kHz	1.15 %
Occupied Bandwidth	9kHz ~ 12.75GHz	2.82 dB
Band Edge Conducted Spurious Emission	9kHz ~ 12.75GHz	2.82 dB
Transient Frequency Behavior	9kHz ~ 12.75GHz	5.4 ms
Adjacent Channel Power	9kHz ~ 12.75GHz	2.82 dB

4.0 Equipment List

FCC Analog ATE#1: (SW version: FCC_Analog_v2.5.0)

Description	Model	Serial Number	Calibration Date	Calibration Due Date
CHAMBER	SH-641	92009188	09-Mar-23	09-Mar-24
POWER METER	E4416A	MY50000115	10-Feb-23	10-Feb-24
AUDIO ANALYZER	U8903B	MY62380007	04-Nov-22	04-Nov-23
POWER SENSOR	E4412A	MY49000115	08-Oct-22	08-Oct-23
POWER SUPPLY	6032A	3232A08410	20-Jun-23	20-Jun-24
CXA SIGNAL ANALYZER	N9000B	MY60251574	20-May-23	20-May-24
POWER SUPPLY	6023A	3236A05513	13-Jun-23	13-Jun-24
N to N RF Cable # 1	M17/128-RG400	NA	NA	NA
BNC to N RF Cable # 1	RG 58	NA	NA	NA
BNC to BNC RF Cable # 1	RG 58	NA	NA	NA
BNC to BNC RF Cable # 2	RG 58	NA	NA	NA
BNC to BNC RF Cable # 3	RG 58	NA	NA	NA
BNC to BNC RF Cable # 4	RG 58	NA	NA	NA
BNC to BNC RF Cable # 5	RG 58	NA	NA	NA
BNC to BNC RF Cable # 6	RG 58	NA	NA	NA
BNC to BNC RF Cable # 7	RG 58	NA	NA	NA
N to SMA RF Cable # 1	RG 58	NA	NA	NA
N to SMA RF Cable # 2	RG 58	NA	NA	NA
N to SMA RF Cable # 3	RG 58	NA	NA	NA
Aeroflex Attenuator 30dB	49-30-34-LIM	NA	NA	NA

FCC Transient ATE #1: (SW version: FCC Transient ATE_R1.2.1)

Description	Model	Serial Number	Calibration Date	Calibration Due Date
SWITCH CONTROL UNIT	3488A	2719A36210	CNR	CNR
ATTENUATOR / SWITCH DRIVER	11713A	3748A09090	CNR	CNR
POWER SENSOR	E9301B	MY50180003	20-Jun-23	20-Jun-24
SIGNAL GENERATOR	8657B	3315U04973	21-Sep-22	21-Sep-23
AUDIO ANALYZER	8903B	2836A05866	10-Nov-22	10-Nov-23
POWER METER	E4416A	MY45101016	01-Mar-23	01-Mar-24
STEP ATTENUATOR	8494G	MY52301411	16-Dec-22	16-Dec-23
POWER SUPPLY	6033A	3506A08076	10-Jan-23	10-Jan-24
ANALYZER SPECTRUM	E4445A	MY46181262	09-Jan-23	09-Jan-24
ATTENUATOR/110DB	8496G	MY52300757	20-Jun-23	20-Jun-24
AUDIO ANALYZER	8903B	3011A08952	12-Sep-22	12-Sep-23
ANALYZER MODULATION	8901B	2619A00845	20-Sep-22	20-Sep-23
OSCILLOSCOPE	M508064A	MY45003003	01-Nov-22	01-Nov-23
N to N RF Cable # 1	SF126/11N/11N	NA	NA	NA
N to N RF Cable # 1	SF126/11N/11N	NA	NA	NA
N to N RF Cable # 2	M17/128-RG400	NA	NA	NA
N to N RF Cable # 3	M17/128-RG400	NA	NA	NA
N to N RF Cable # 4	M17/128-RG400	NA	NA	NA
N to N RF Cable # 5	M17/128-RG400	NA	NA	NA
N to N RF Cable # 6	M17/128-RG400	NA	NA	NA
N to N RF Cable # 7	M17/128-RG400	NA	NA	NA
N to N RF Cable # 8	M17/128-RG400	NA	NA	NA
N to N RF Cable # 9	M17/128-RG400	NA	NA	NA
BNC to BNC RF Cable # 1	RG 58	NA	NA	NA
BNC to BNC RF Cable # 2	RG 58	NA	NA	NA
BNC to BNC RF Cable # 3	RG 58	NA	NA	NA
BNC to BNC RF Cable # 4	RG 58	NA	NA	NA
BNC to BNC RF Cable # 5	RG 58	NA	NA	NA
BNC to BNC RF Cable # 6	RG 58	NA	NA	NA
BNC to N RF Cable # 1	RG 58	NA	NA	NA
Aeroflex Attenuator 10dB	49-10-43-LIM	NA	NA	NA
Aeroflex Attenuator 10dB	33-10-34-LIM	NA	NA	NA

FCC CONDUCTED SPUR EMISSION ATE # 1 (SW version: Conducted Spur ATE_rev 1.23.04)

Description	Model	Serial Number	Calibration Date	Calibration Due Date
SWITCH CONTROL UNIT	3488A	2719A32735	CNR	CNR
POWER SUPPLY	6032A	US38323921	08-Dec-22	08-Dec-23
SPECTRUM ANALYZER	E4445A	MY46181250	20-May-23	20-May-24
INTERFACE BOX - FILTER	CNR	CS001	CNR	CNR
N to N RF Cable # 1	SF126/11N/11N	NA	NA	NA
N to N RF Cable # 2	SF126/11N/11N	NA	NA	NA
BNC to BNC RF Cable # 1	RG 58	NA	NA	NA
Aeroflex Attenuator 30dB	49-30-43-LIM	NA	NA	NA
Aeroflex Attenuator 10dB	33-10-34-LIM	NA	NA	NA

Radiated Emission

Description	Model #	Serial Number	Calibration Date	Calibration Due Date
EMI TEST RECEIVER	ESIB26	100017	09-Aug-22	08-Aug-23
3m Semi-anechoic Chamber	NA	888032	No Cal. Req'd	No Cal. Req'd
TURNTABLE FLUSH MOUNT 2M	T-200-S	N/A	No Cal. Req'd	No Cal. Req'd
PROGRAMMING CONTROLLER	MF-7802BS	N/A	No Cal. Req'd	No Cal. Req'd
POWER SUPPLY (0-60V/0-50A, 1000W)	6032A	2615A01178	18-Jun-23	18-Jun-24
SIGNAL ANALYZER	FSV40	101103	11-Apr-22	11-Sep-23
DATA LOGGER	SDL500	A.016800	21-Jun-23	21-Jun-24
BILOG ANTENNA	CBL6112D	55546	23-Jun-22	23-Sep-23
BILOG ANTENNA	CBL6112D	30991	5-Jan-23	5-Jan-24
DRG HORN FREQ.	SAS-571	566	22-Nov-22	22-Nov-23
DRG HORN FREQ.	SAS-571	720	18-Apr-23	18-Apr-25
PREAMPLIFIER	PAM-0118	427	18-Oct-21	18-Oct-24
SIGNAL GENERATOR	SMB100A	182511	04-Jun-21	04-Jun-24
LOOP ANTENNA	6502	00208416	12-Oct-22	12-Oct-23
BROAD-BAND HORN ANTENNA	BBHA9170	BBHA9170143	18-Aug-22	18-Aug-23
Test Software	EMC_FCC_IC_Bluetooth_RE_Test			
Version	EMC_FCC_RE_v1.6.5			

5.0 Test Condition

5.1. Transmitter Test Conditions

Test Item, (Channel Spacing)	Power (W)	Modulation	Test Frequency (MHz)	Tested By	Environmental conditions
RF Output Power	Low & Max	FM	403.0125, 406.2, 450.025, 459.125, 467.775, 469.9875	HAZIM	23.4°C, 50%RH
Frequency Stability	Max	FM	467.775	HAZIM	25.1°C, 54.3%RH, 60.3°C, 50%RH, -30.1°C, 51.2%RH
Audio Frequency Response (12.5kHz / 25kHz)	Max	FM	459.125, 467.775	HAZIM	23.4°C, 50%RH
Audio Low Pass Filter Response (12.5kHz / 25kHz)	Max	FM	NA		
Modulation limiting (12.5kHz / 25kHz)	Max	FM	459.125, 467.775	HAZIM	23.4°C, 50%RH
Occupied Bandwidth (12.5kHz / 20kHz / 25kHz)	Max	FM/4FSK	406.2, 450.025, 459.125, 467.775	HAZIM	23.4°C, 50%RH
Band Edge Conducted Spurious Emissions (Part 22) (12.5kHz / 20kHz / 25kHz)	Max	FM/4FSK	459.025, 459.65	HAZIM	23.4°C, 50%RH
Transient Frequency Behavior (UHF & VHF Band) (12.5kHz / 25kHz)	Max	FM	467.775	HAZIM	23.4°C, 50%RH
Adjacent Channel Power (700MHz Band) (12.5kHz / 25kHz)	Max	FM/4FSK	NA		
Conducted Spurious Emissions- (12.5kHz / 25kHz)	Low / Max	FM/4FSK	403.0125, 406.2, 450.025, 459.125, 467.775, 469.9875	HAZIM	23.4°C, 50%RH
Radiated Spurious Emission (12.5kHz / 25kHz)	Low / Max	FM/4FSK	403.0125, 406.2, 450.025, 459.125, 467.775, 469.9875	AIMAN	21.3°C, 59.3%RH
GNSS (EIRP for 1559 - 1610MHz) (12.5kHz / 25kHz)	Max	FM	NA		
Effective Radiated Power (ERP) (12.5kHz / 25kHz)	Max	FM	NA		

NA → Not Applicable

6.0 Transmitter Test Parameters

6.1. RF Output Power

6.1.1. Test Setup

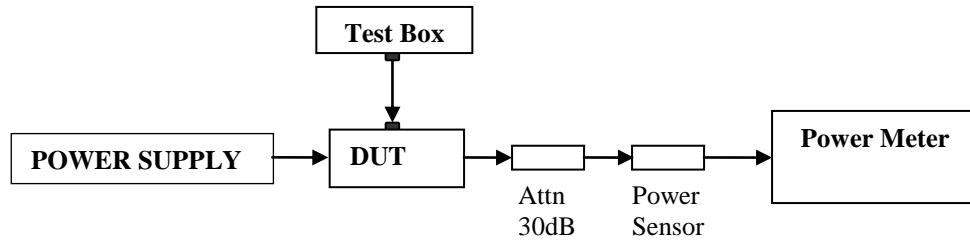

- 1) The DUT transmitter connected to Power Meter using the 30 dB attenuator and power sensor with above setup.
- 2) Path loss for the measurement included.
- 3) All the measurement was done at low, mid, high frequency for each band.
- 4) Record the power into the test report.

6.1.2. Test Result

Temperature	25°C					
Voltage (V)	7.5V					
Frequency (MHz)	Low Power (W)	Current (A)	Max Power (W)	Current (A)	Remark	Model
403.01250	1.00	1.15	2.40	1.70	Not for FCC Review	Analog
406.20000	1.00	1.15	2.40	1.78		
450.02500	1.00	1.16	2.38	1.83		
459.12500	1.01	1.16	2.39	1.84		
467.77500	1.00	1.16	2.40	1.85		
469.98750	1.00	1.16	2.40	1.85		
403.01250	1.00	1.25	3.29	2.23	Not for FCC Review	Digital
406.20000	1.00	1.31	3.25	2.06		
450.02500	1.00	1.29	3.25	2.10		
459.12500	1.00	1.33	3.27	2.14		
467.77500	1.00	1.22	3.27	2.08		
469.98750	1.00	1.28	3.29	2.13		

6.2. Frequency Stability

6.2.1. Test Setup

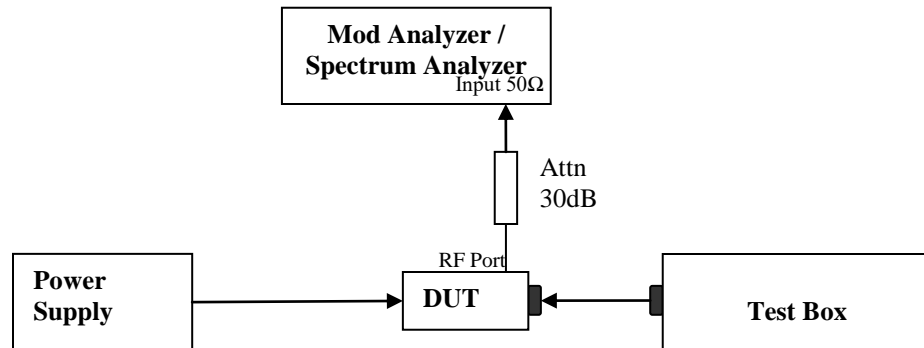

- 1) The DUT transmitter output port was connected to Modulation / Spectrum Analyzer.
- 2) Path loss for the measurement included.
- 3) Transmit the DUT and record the freq in MCF_{MHz} .
- 4) Test in 2 conditions:
 - Temperature: The frequency of the transmitter was measured from $-30^{\circ}C$ to $50^{\circ}C$.
 - Supply Voltage:
 - Mobile: The frequency of the transmitter was measured from 85% to 115% of the nominal operating input voltage.
 - Portable: The frequency of the transmitter was measured from nominal $\pm x\%$ as specified by the manufacturer
- 5) Calculate the ppm frequency error by the following:

$$ppm\ error = \left(\frac{MCF_{MHz}}{ACF_{MHz}} - 1 \right) * 10^6$$

Where: MCF_{MHz} is the Measured Carrier Frequency in MHz
 ACF_{MHz} is the Assigned Carrier Frequency in MHz

6.2.2. Test Result

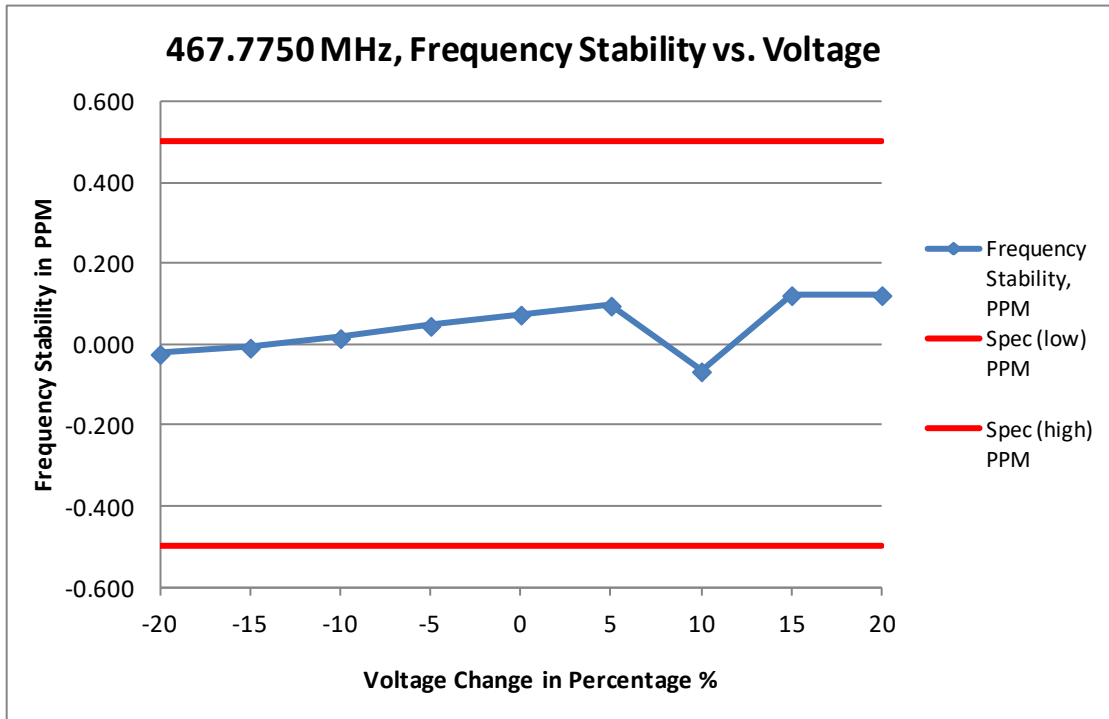

(i) Frequency Stability VS Voltage

Frequency / Channel Spacing		467.7750 MHz / 12.5 kHz			
Temperature, °C		25			
Voltage %	Voltage, V	Frequency, MHz	Frequency Stability, PPM	Spec (low) PPM	Spec (high) PPM
-20	3.330	467.774990	-0.022	-0.500	0.500
-15	3.520	467.774997	-0.007	-0.500	0.500
-10	3.700	467.775008	0.017	-0.500	0.500
-5	3.890	467.775022	0.047	-0.500	0.500
0	4.070	467.775035	0.075	-0.500	0.500
5	4.250	467.775045	0.097	-0.500	0.500
10	4.255	467.774969	-0.065	-0.500	0.500
15	4.440	467.775058	0.123	-0.500	0.500
20	4.440	467.775058	0.123	-0.500	0.500

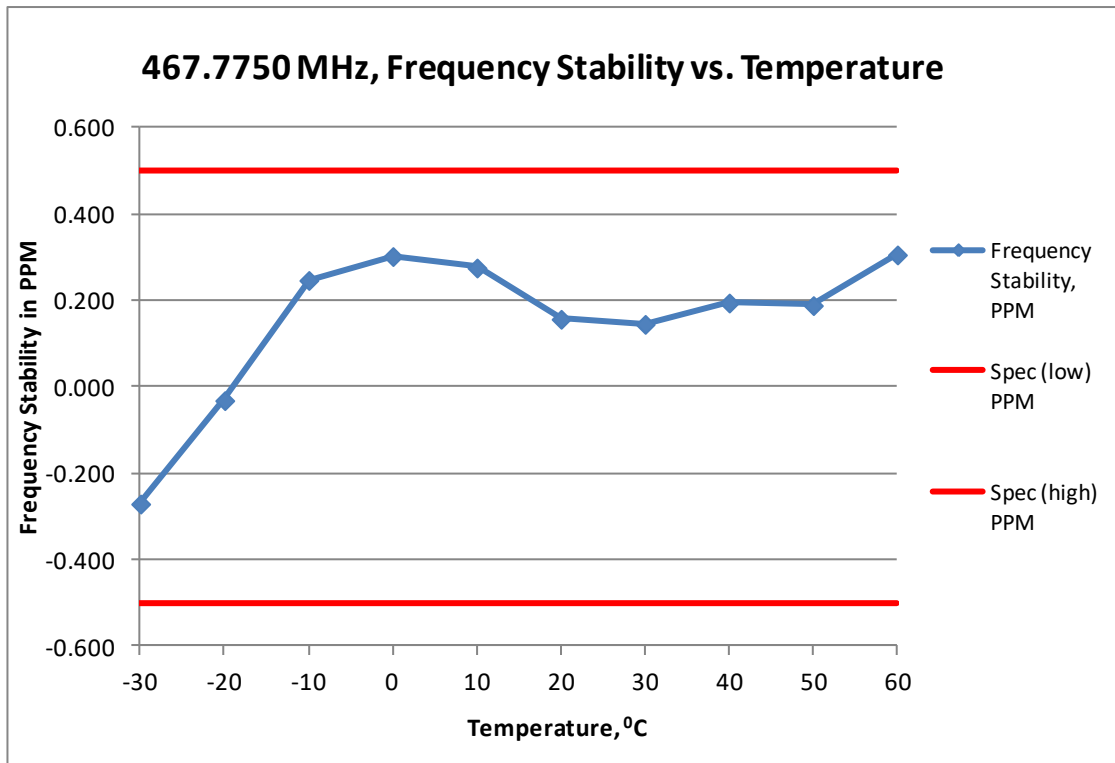

(ii) Frequency Stability VS temperature

Frequency / Channel Spacing		467.7750 MHz / 12.5 kHz		
Voltage, V		3.7		
Temperature, °C	Frequency, MHz	Frequency Stability, PPM	Spec (low) PPM	Spec (high) PPM
-30	467.774874	-0.269	-0.500	0.500
-20	467.774986	-0.030	-0.500	0.500
-10	467.775116	0.249	-0.500	0.500
0	467.775142	0.304	-0.500	0.500
10	467.775130	0.278	-0.500	0.500
20	467.775074	0.159	-0.500	0.500
30	467.775069	0.147	-0.500	0.500
40	467.775092	0.196	-0.500	0.500
50	467.775089	0.190	-0.500	0.500
60	467.775144	0.308	-0.500	0.500

6.2.3. Test Limit

As per manufacturer declared spec +/- 0.5ppm

6.3. Modulation Characteristics

6.3.1. Test Setup

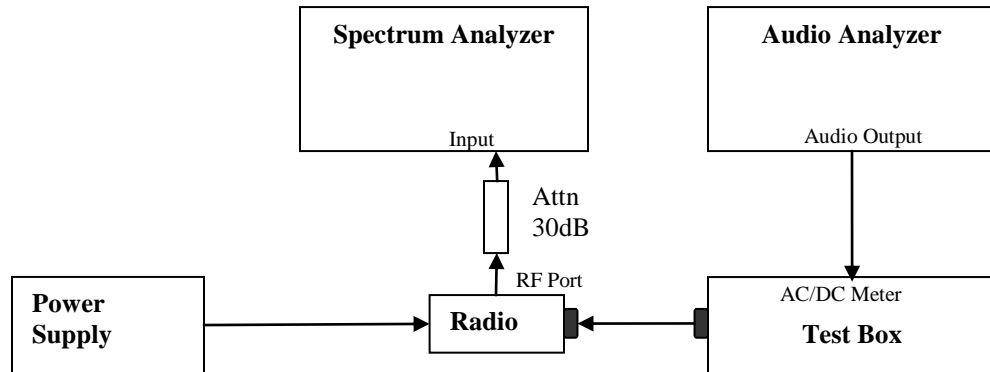

- 1) The DUT transmitter output port was connected to Modulation Analyzer.
- 2) Path loss for the measurement included.
- 3) Set the audio bandwidth filter to 15 kHz and 50 kHz.
- 4) Transmit the radio and set the audio analyzer to 1 kHz audio frequency and 20% of the Full rated system deviation.
- 5) On audio analyzer, set the rated level as 0dB reference
- 6) Vary the audio frequency from 300 Hz to 20 kHz. Record the change in modulation in reference to step 5.

6.3.2. Test Result

Not for FCC Review

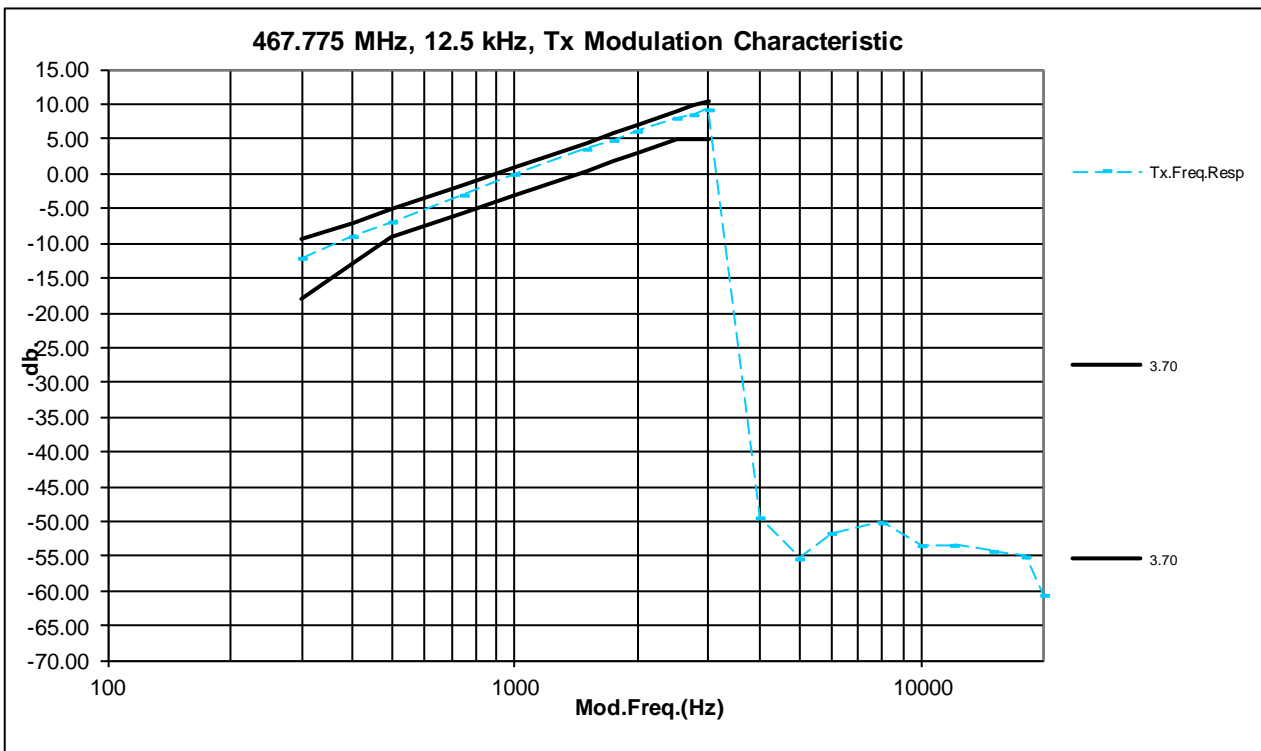
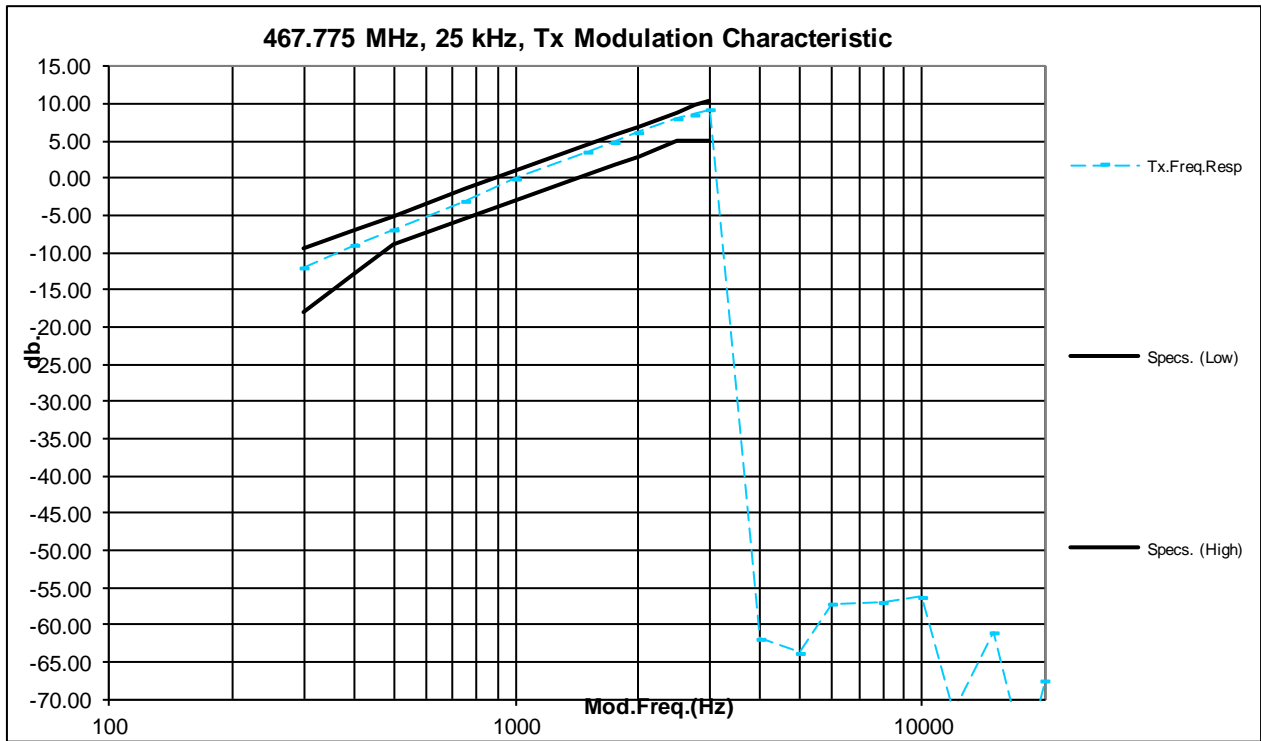

Not for FCC Review

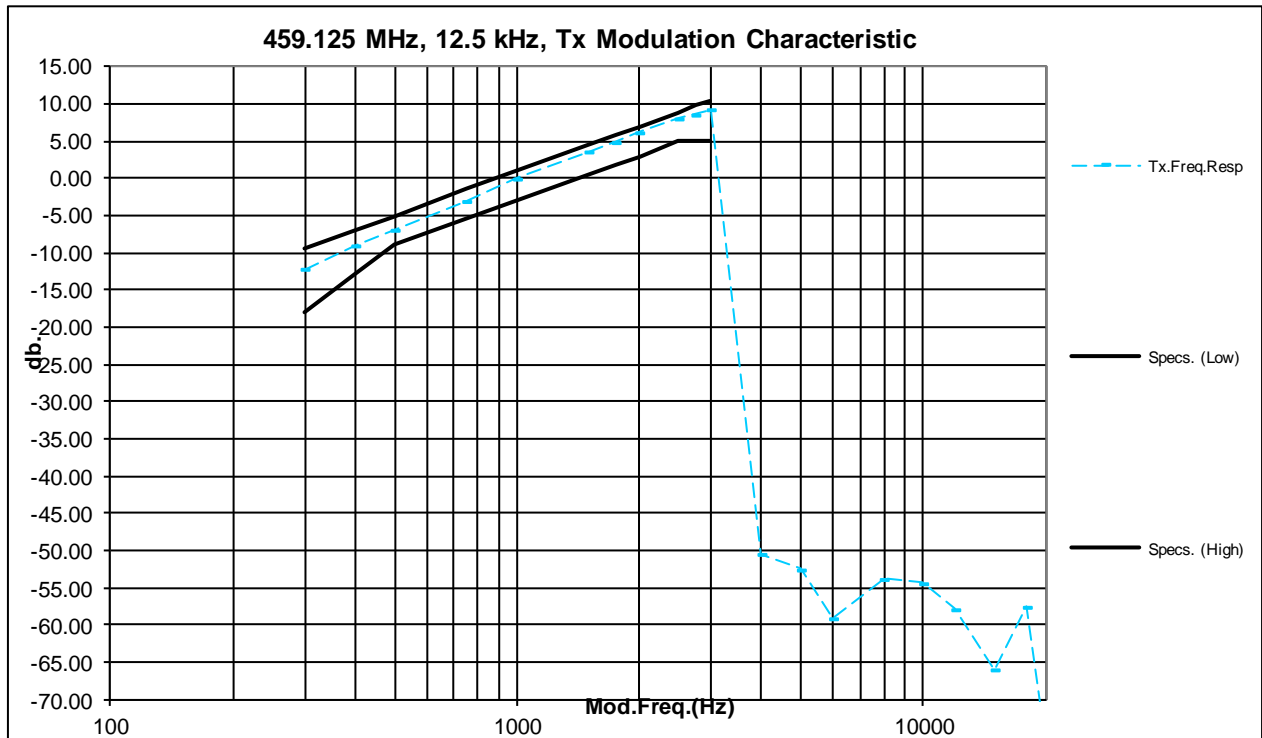
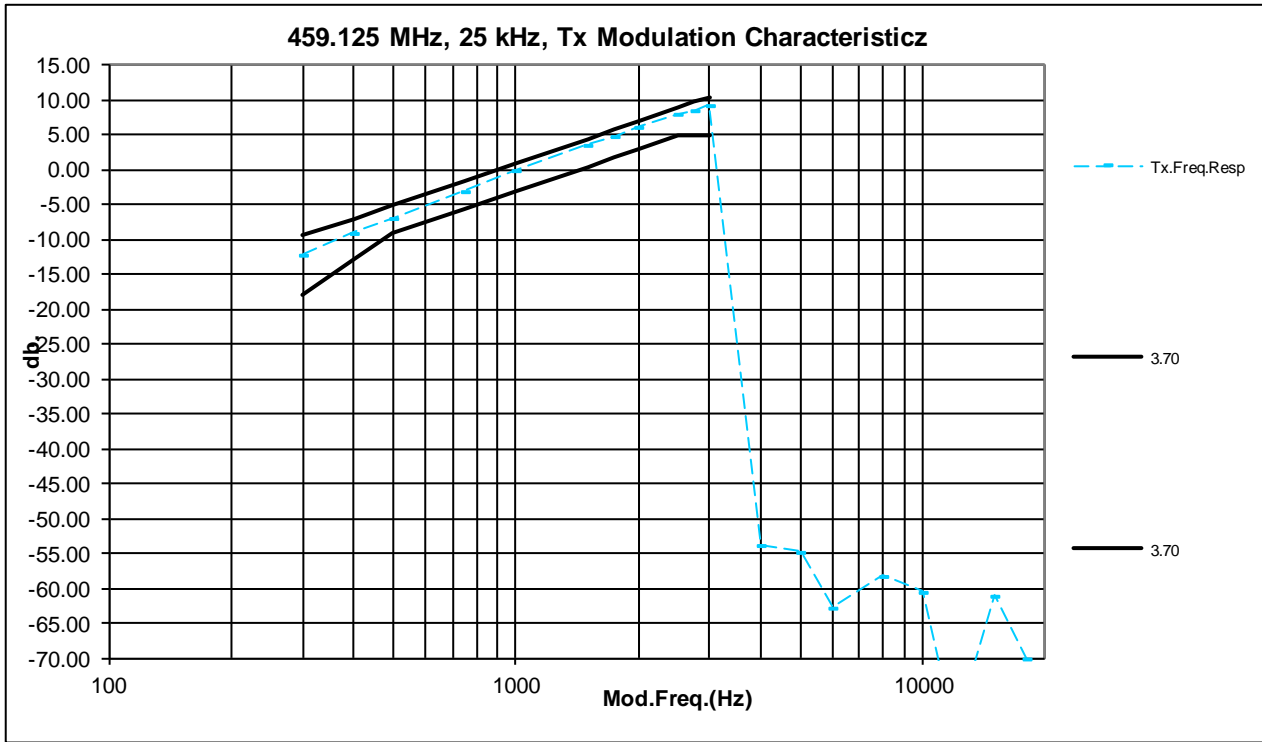

6.3.3. Test Limit

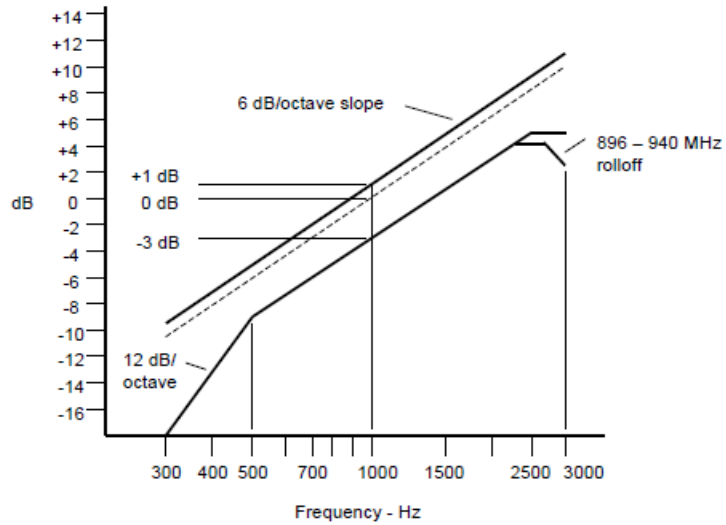

Note:

- o There are additional 6 dB per octave attenuation is allowed from 2.5KHz to 3KHz in equipment 25MHz to 869MHz radio.
- o Additional 6 dB per octave attenuation is allowed from 2.3KHz to 2.7KHz & additional 12 dB per octave attenuation is allowed from 2.7KHz to 3KHz in equipment 896MHz to 940MHz radio.

6.4. Modulation Limiting

6.4.1. Test Setup

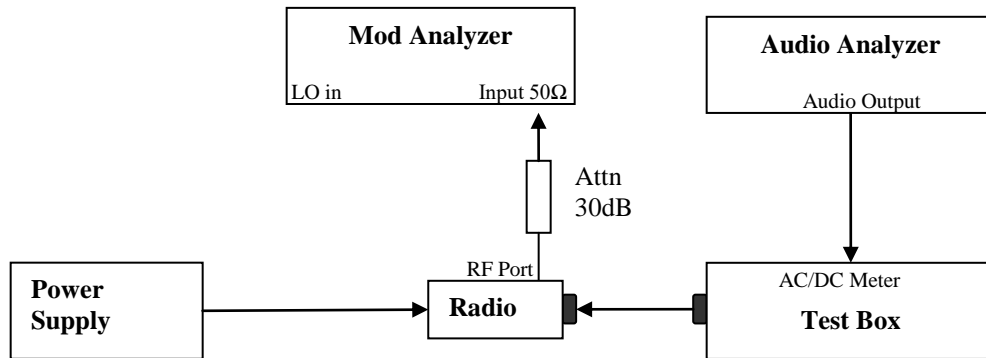

- 1) The DUT transmitter output port was connected to Modulation Analyzer.
- 2) Path loss for the measurement included.
- 3) Set the audio bandwidth filter to 15 kHz.
- 4) Transmit the radio and set the audio analyzer to 1 kHz audio frequency and 60% of the Full rated system deviation.
- 5) Record the frequency deviation as 0dB input level at 1kHz audio frequency.
- 6) Repeat the step and record the frequency deviation from -20 dB to 20dB by 5 dB increments and different audio freq 300 Hz, 2.5 kHz and 3 kHz.

6.4.2. Test Result

Not for FCC Review

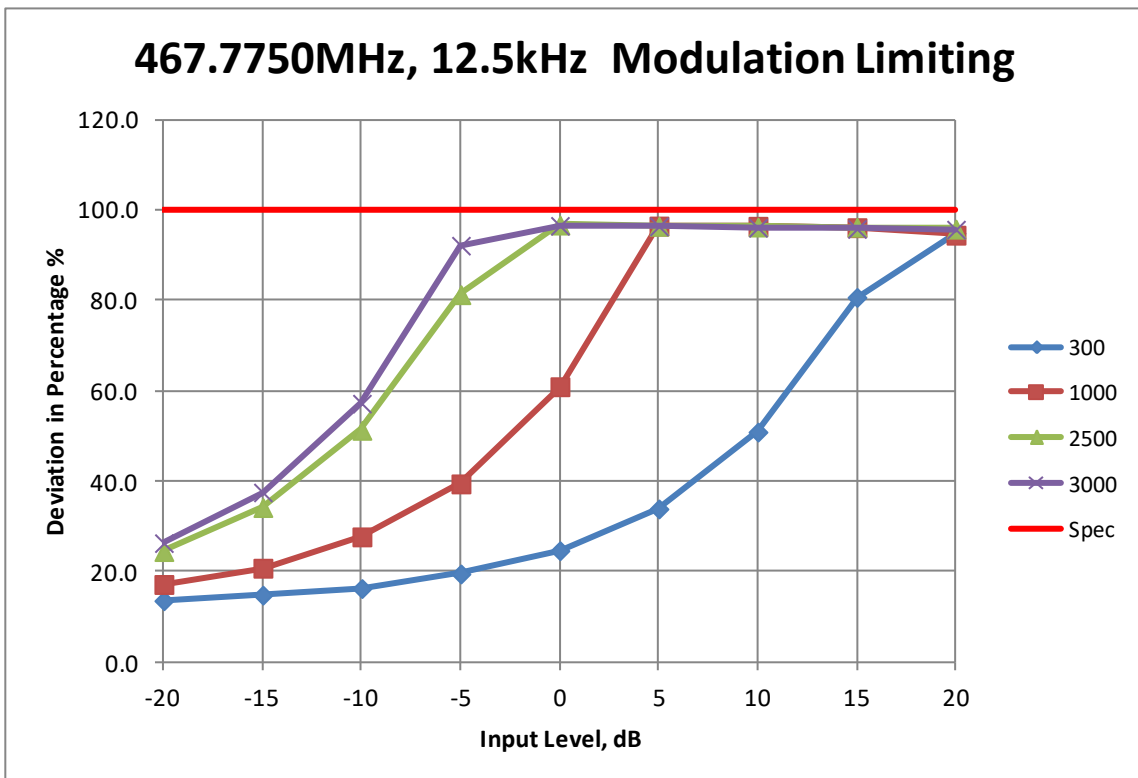
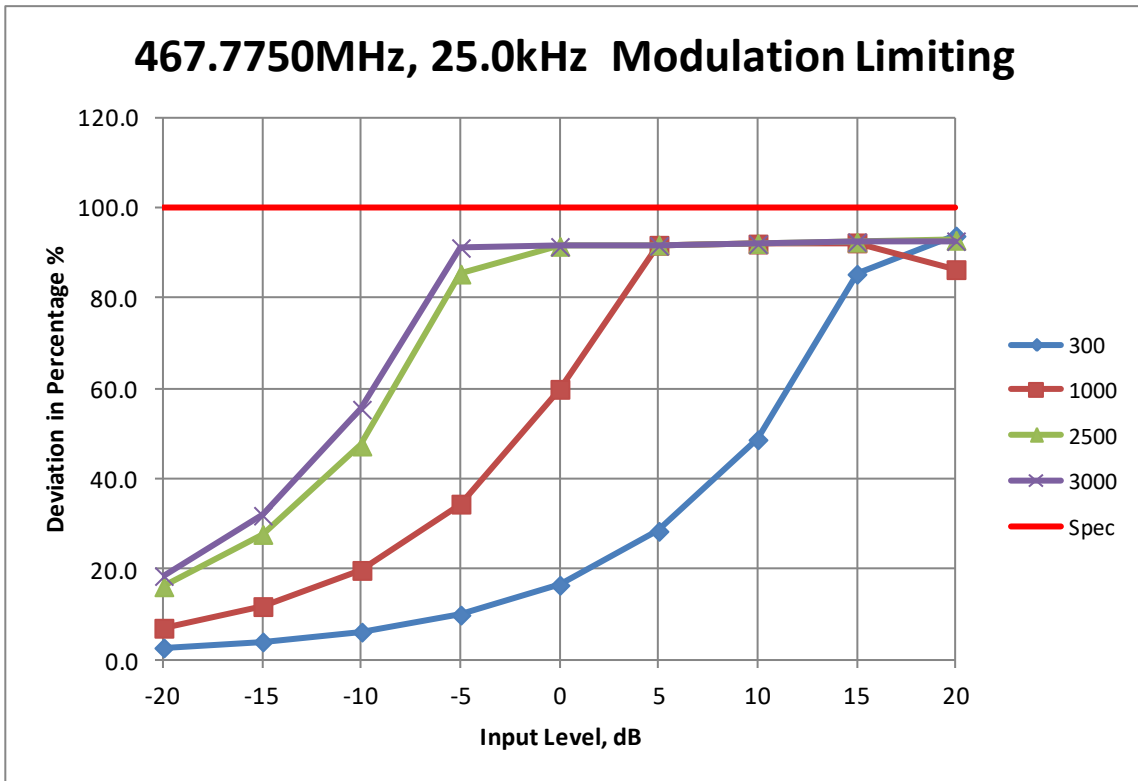

Not for FCC Review

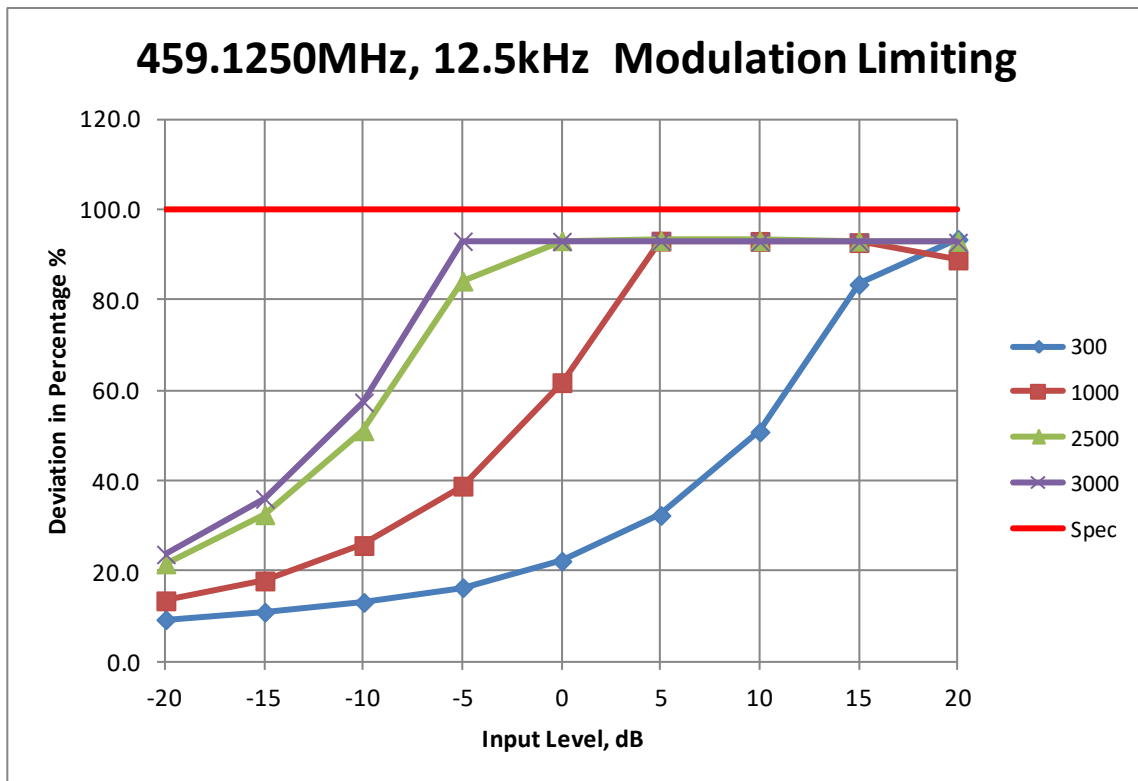
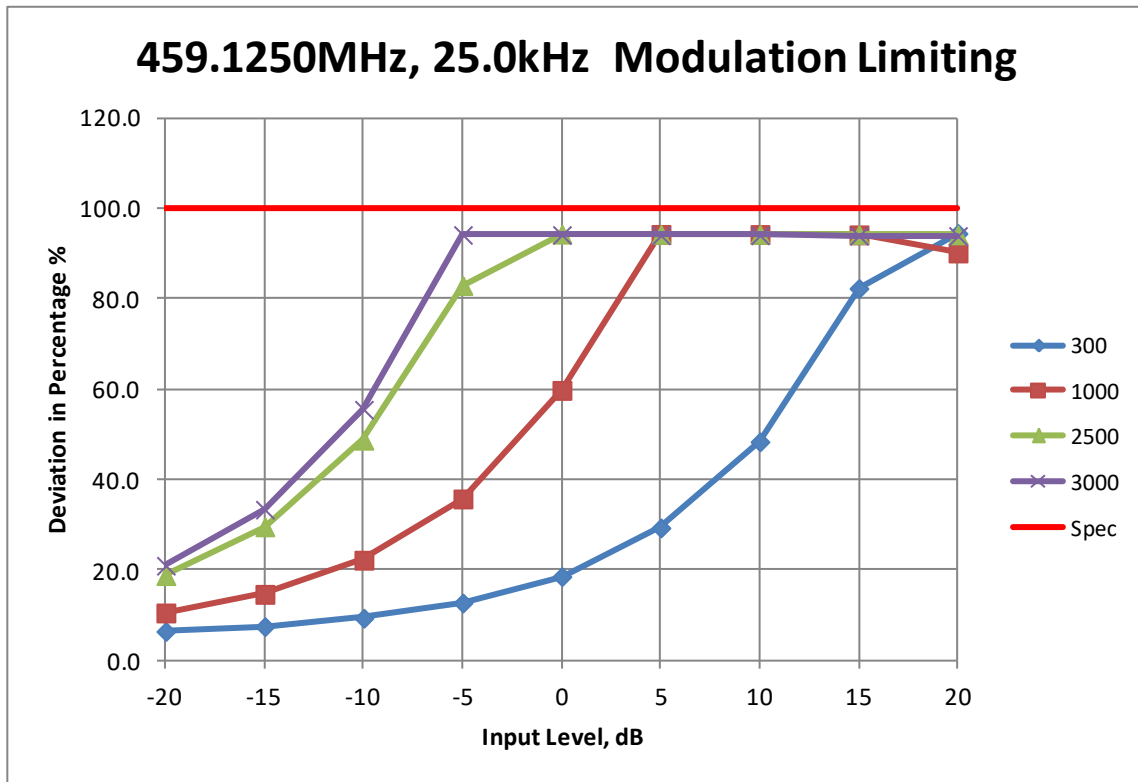

6.4.3. Test Limit
Modulation Limiting shall not exceed 100 percent.

6.5. Occupied Bandwidth

6.5.1. Test Setup (Analog)

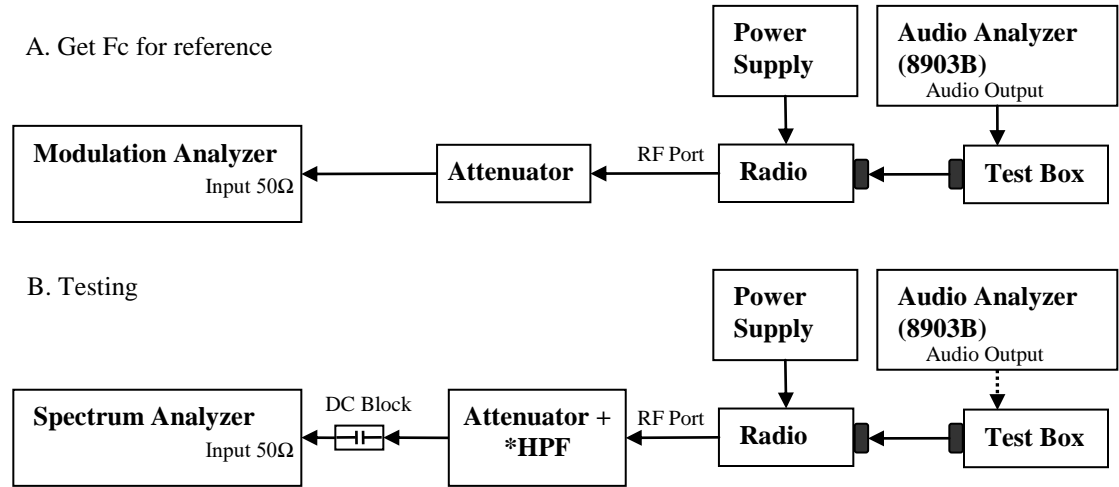

- 1) The DUT transmitter output port was connected to Modulation Analyzer.
- 2) Set the audio bandwidth filter to 15 kHz low pass filter and 50 kHz high pass filter.
- 3) Transmit the radio and set the audio analyzer to 2.5 kHz audio frequency and 50% of the rated deviation. Up the amplitude by 16 dB. Dekey the DUT.
- 4) Path loss for the measurement included.
- 5) Select the Occupied Bandwidth measurement for 99% Emissions Bandwidth Measurement.
- 6) Key in the Fc and Resolution Bandwidth (1 ~ 5 % of emission designator).
- 7) Transmit the DUT and record the occupied Bandwidth frequency.
- 8) Preset the spectrum analyzer for sideband spectrum measurement.
- 9) Set the span and Resolution Bandwidth (according to FCC/ ISED standard).
- 10) Save the screen shot as modulated signal
- 11) Remove the audio tone from audio analyzer to capture unmodulated signal.

* Only HPF added for Mask 80.211 measurement with attenuator.

* 99% Bandwidth measurement is computed by the spectrum analyzer and is consistent with the C63.26 5.4.4 method.

6.5.2. Test Result (Analog)

Standard Audio Modulation (25 kHz Channelization, Analog Voice):
 Emission Designator 16K0F3E

In this case, the maximum modulating frequency is 3 kHz with a 5 kHz deviation.

$BW = 2(M+D) = 2*(3 \text{ kHz} + 5 \text{ kHz}) = 16 \text{ kHz} = 16K0$
 F3E portion of the designator indicates voice.

Therefore, the entire designator for 25 kHz channelization analog voice is 16K0F3E.

Standard Audio Modulation (12.5 kHz Channelization, Analog Voice):
 Emission Designator 11K0F3E

In this case, the maximum modulating frequency is 3.0 kHz with a 2.5 kHz deviation.

$BW = 2(M+D) = 2*(3.0 \text{ kHz} + 2.5 \text{ kHz}) = 11 \text{ kHz} = 11K0$
 F3E portion of the designator indicates voice.

Therefore, the entire designator for 12.5 kHz channelization analog voice is 11K0F3E.

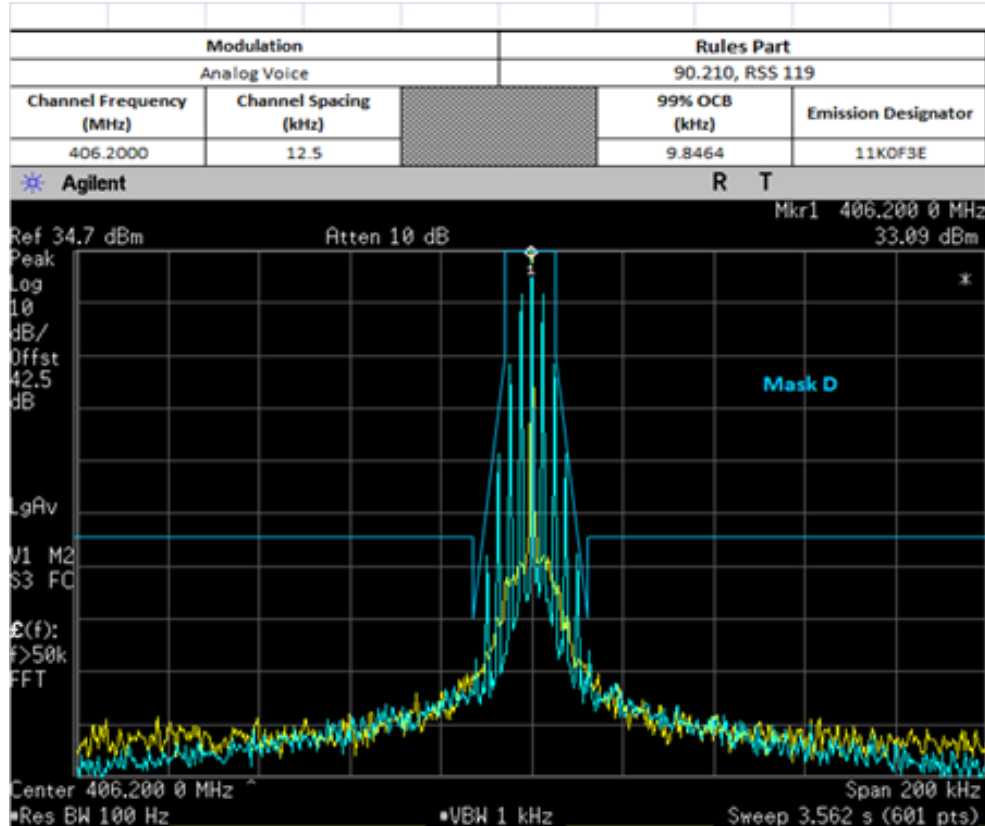

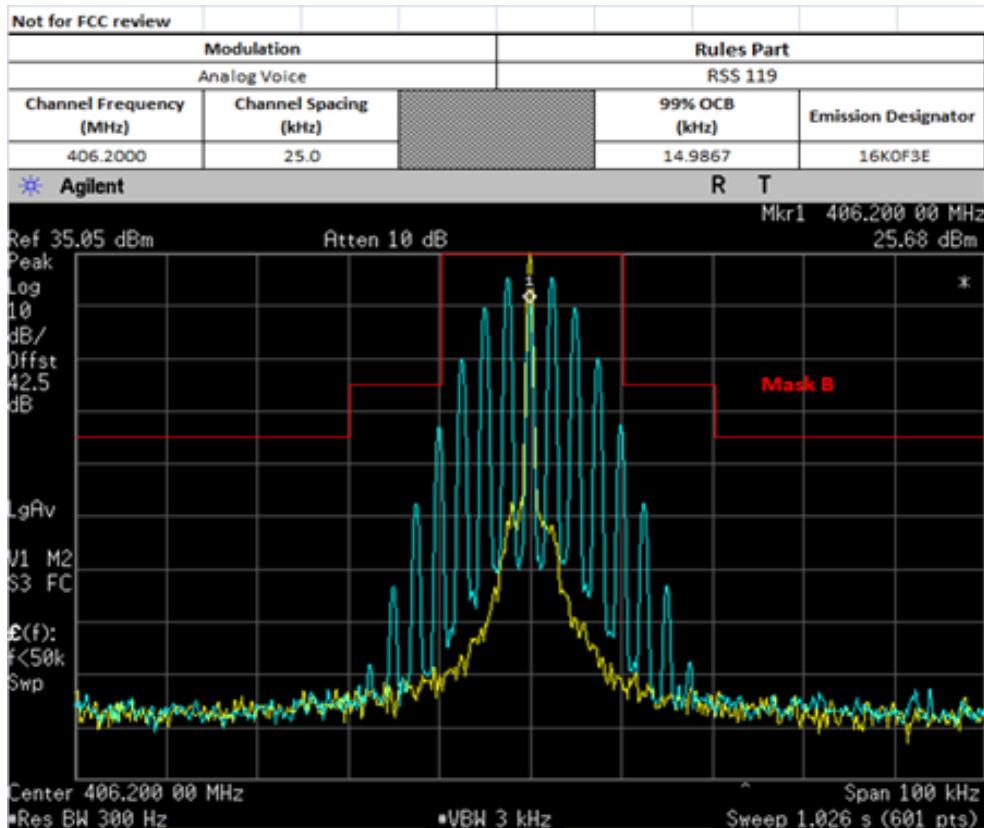
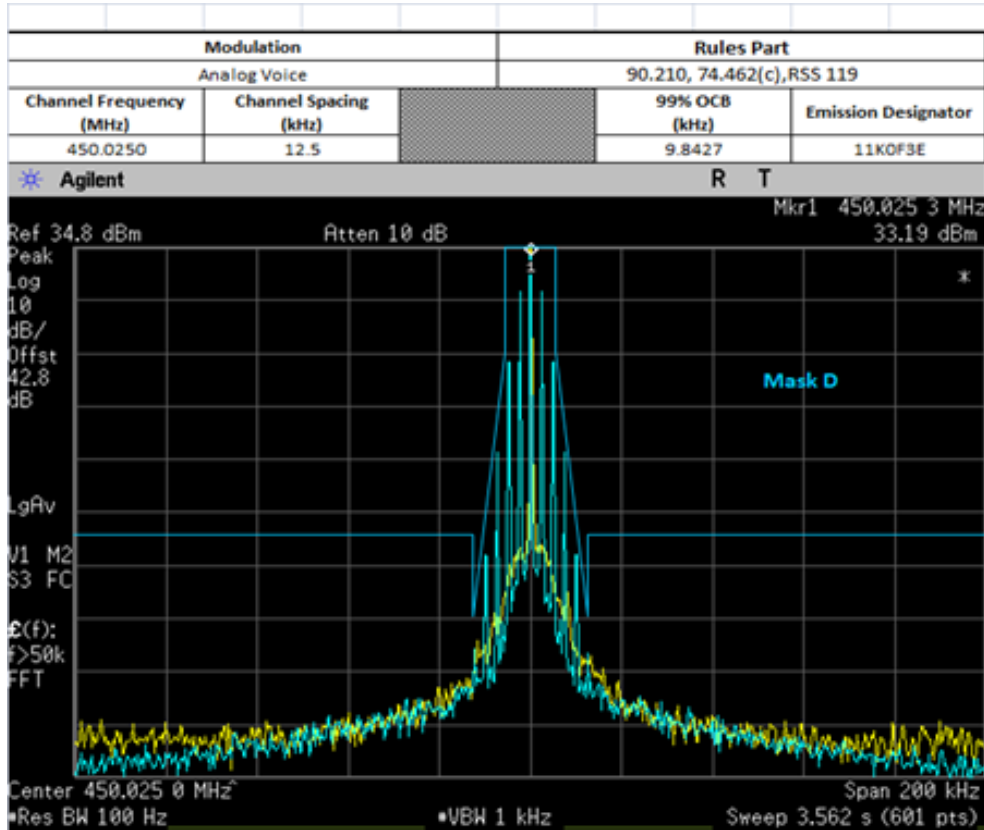

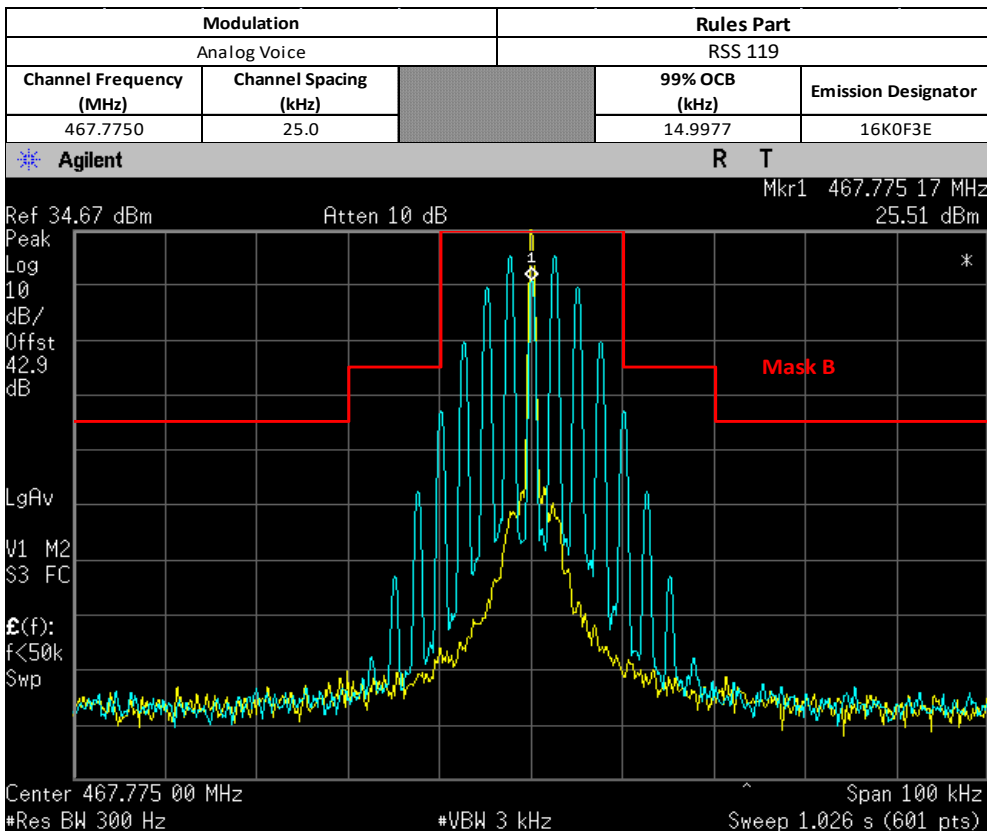
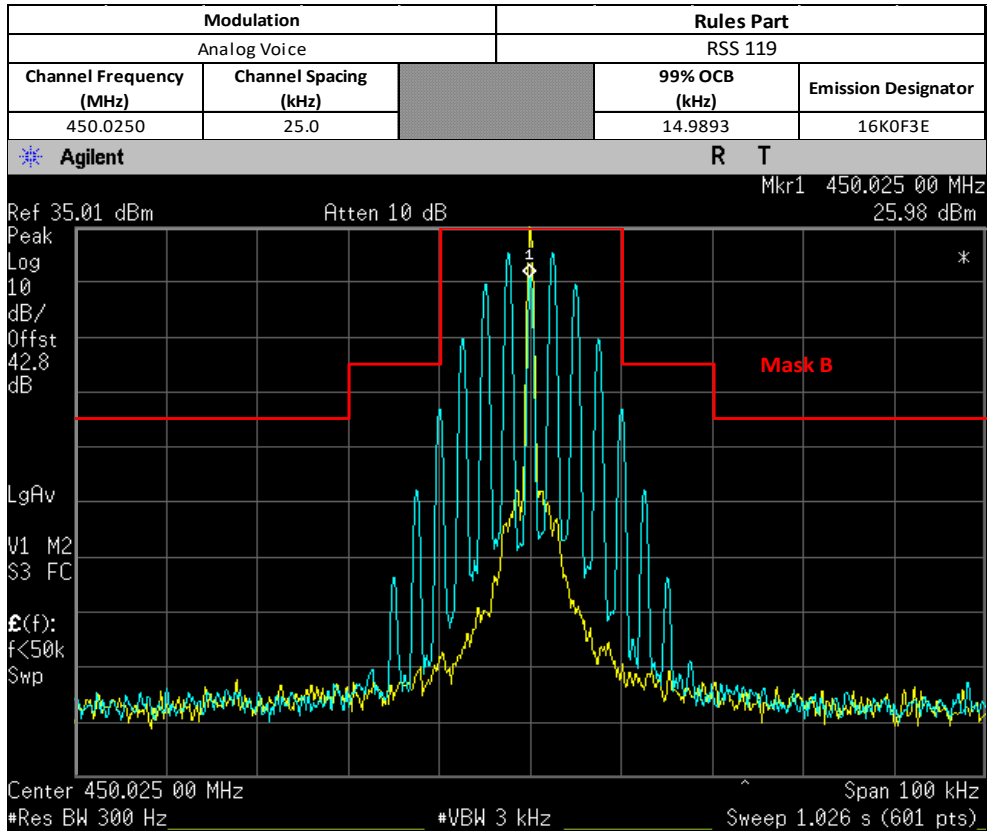

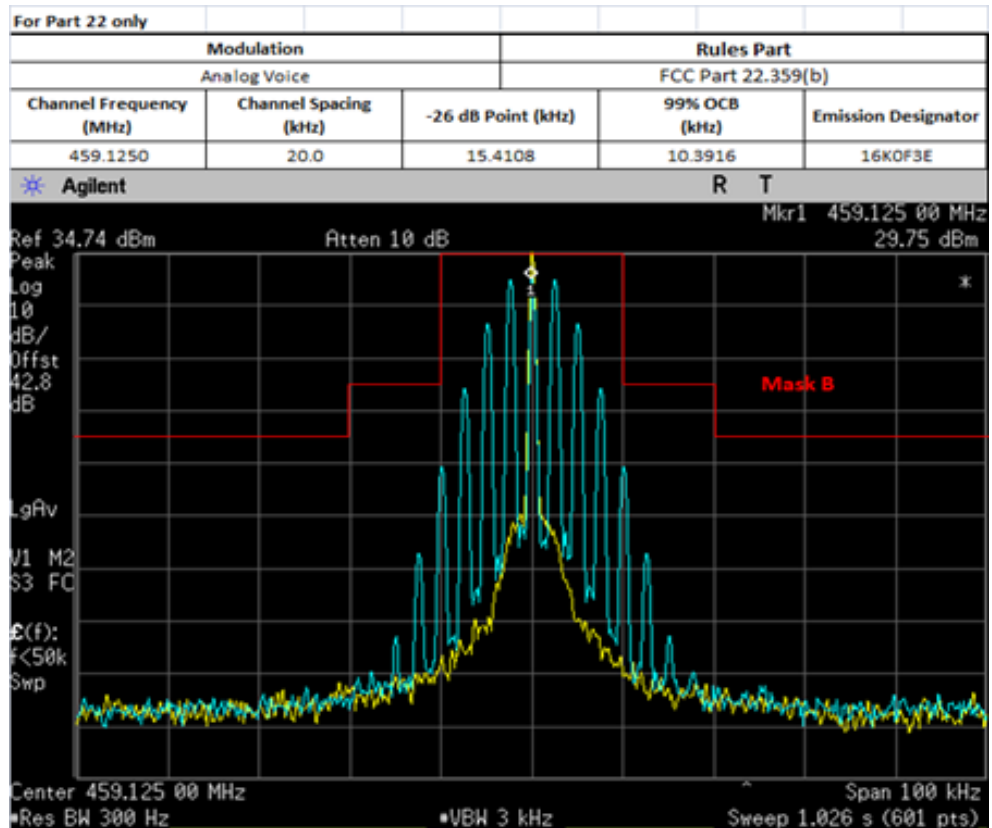
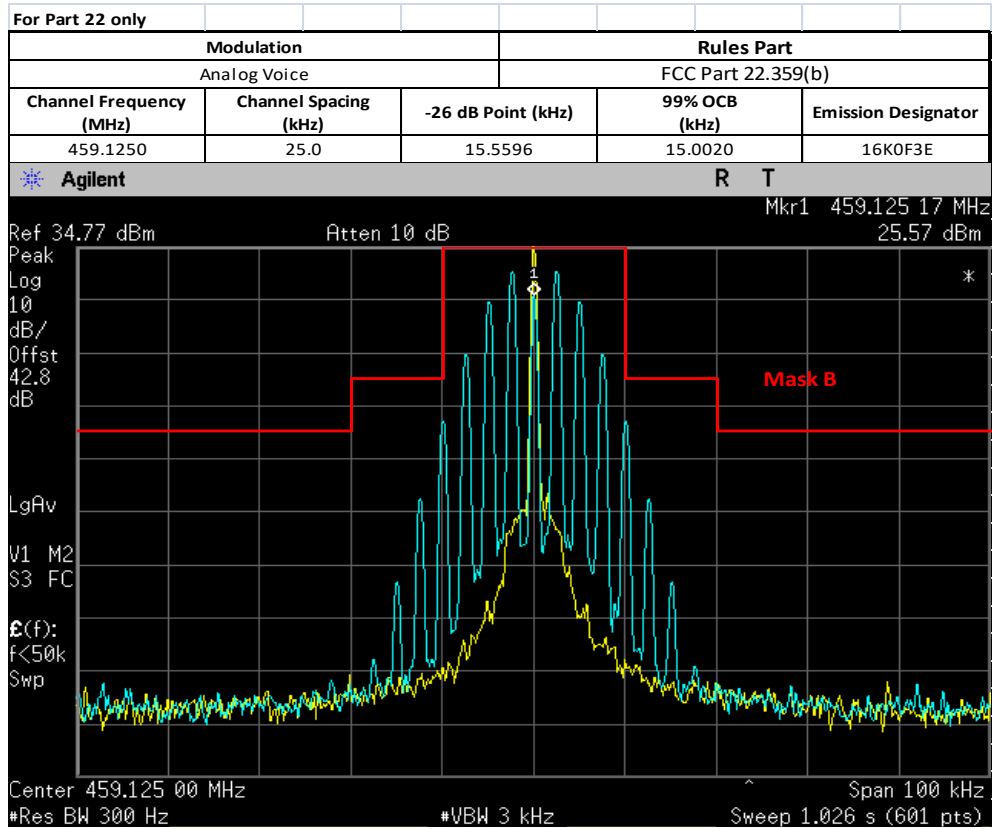

6.5.3. Test Setup (Digital)

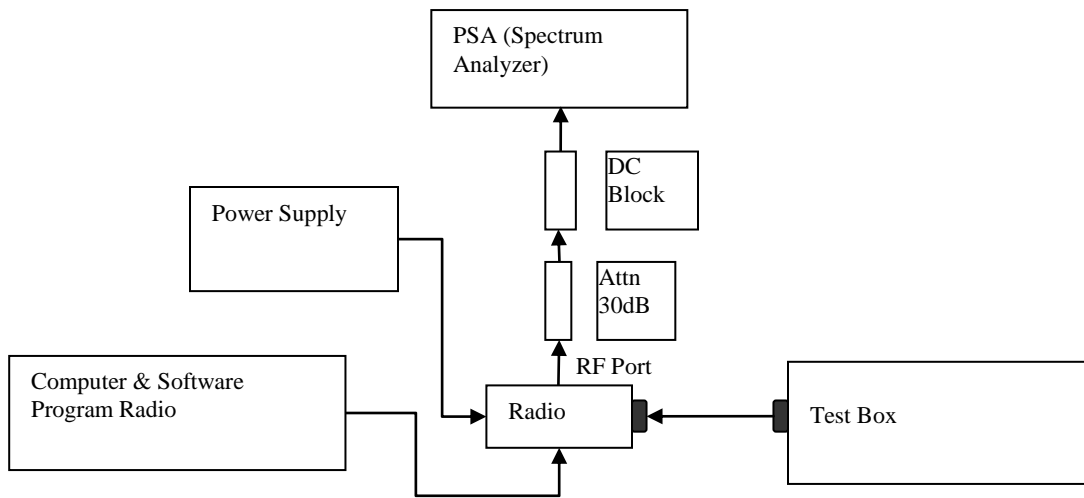

- 1) Program and set radio to operate in desire test frequency and digital mode with modulation. (*4FSK, C4FM or other digital modulation form).
- 2) Path loss for the measurement included.
- 3) Select the Occupied Bandwidth measurement for 99% Emissions Bandwidth Measurement.
- 4) Key in the Fc and Resolution Bandwidth (1 ~ 5 % of emission designator).
- 5) Transmit the DUT and record the occupied Bandwidth frequency.
- 6) Preset the spectrum analyzer for modulation emission spectrum measurement.
- 7) Set the span and Resolution Bandwidth (according to FCC/ ISED standard).
- 8) Capture the screen shot as modulated signal.

* 99% Bandwidth measurement is computed by the spectrum analyzer and is consistent with the C63.26 5.4.4 method.

*Note:

- For Digital Modulation, 12.5 kHz Data F1D & FXD would be the same. Therefore only measurements with F1D modulation shown below.
- For Digital Modulation, 12.5 kHz Data F1E & FXE would be the same. Therefore only measurements with F1E modulation shown below.

6.5.4. Test Result (Digital)

Digital (12.5 kHz Channelization, Digital Voice/Data/Voice+Data):
 Emission Designator 7K60F1E/D/W

The 99% energy rule (title 47CFR 2.989) was used for digital mode and is more accurate than Carson’s rule. It basically states that 99% of the modulation energy falls within X kHz, in this case, 7.60 kHz. Measurements were performed in accordance with TIA/EIA TSB102.CAAB Section 2.2.5.2. The emission mask was obtained from 47CFR 90.210(d).

F1E/D/W portion of the designator indicates digital voice/data/voice+data.

Therefore, the entire designator for 12.5 kHz channelization digital voice is 7K60F1E/D/W.

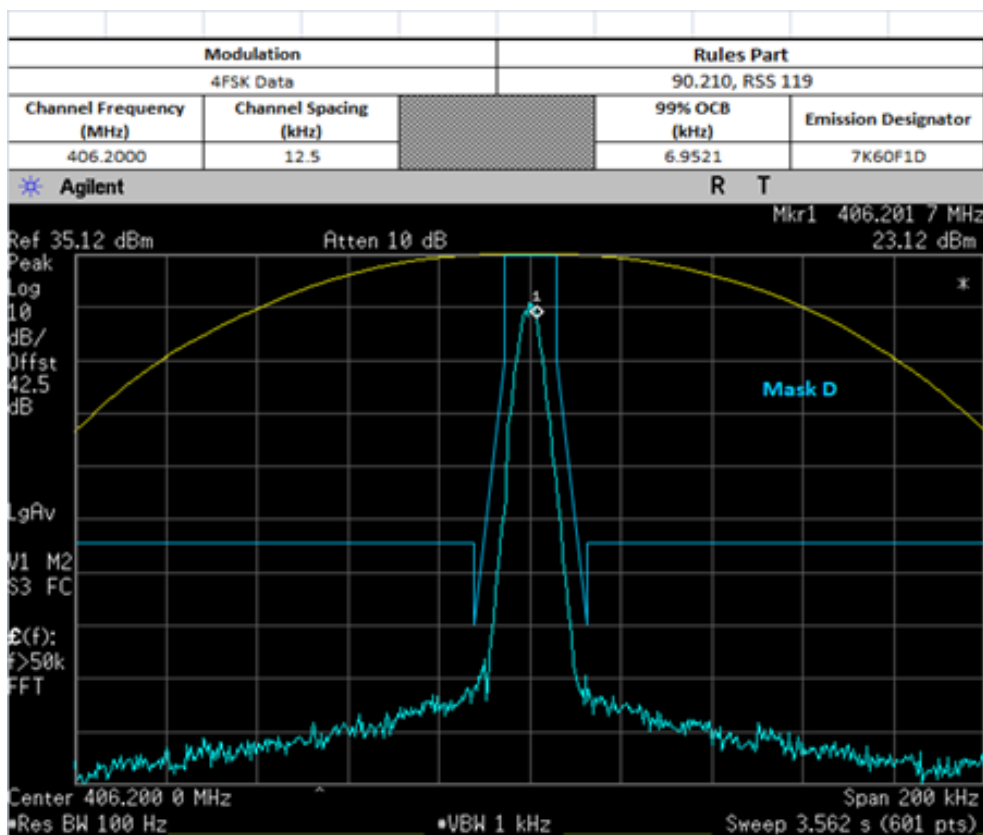

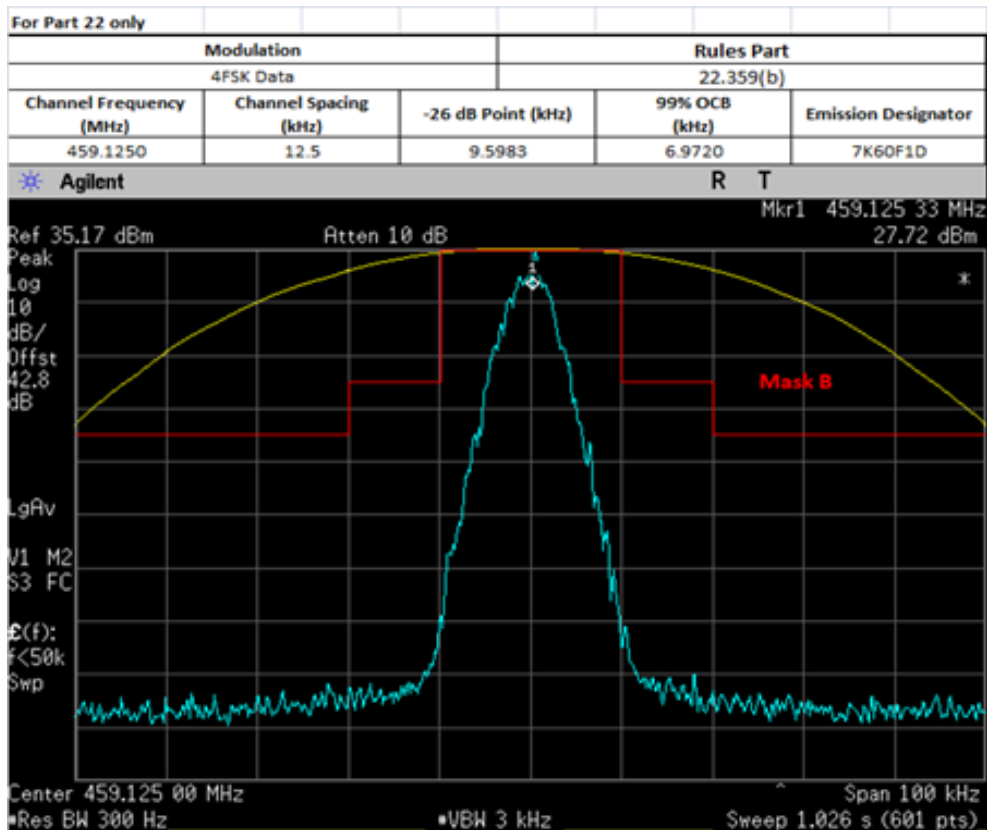
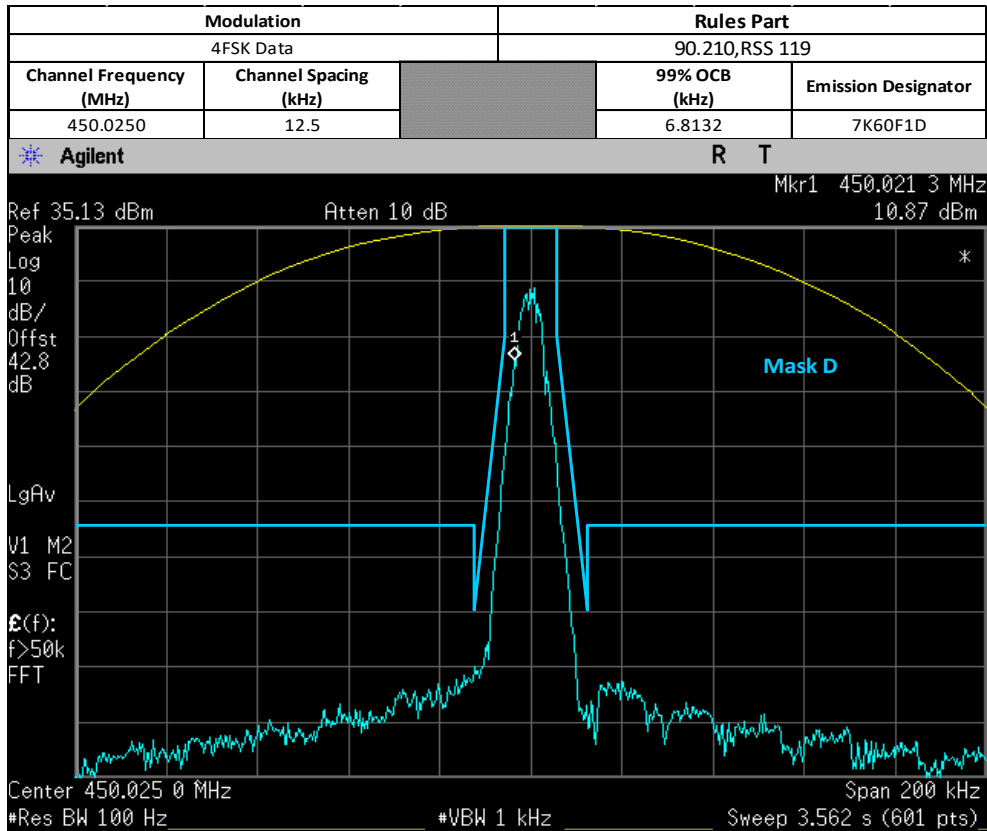

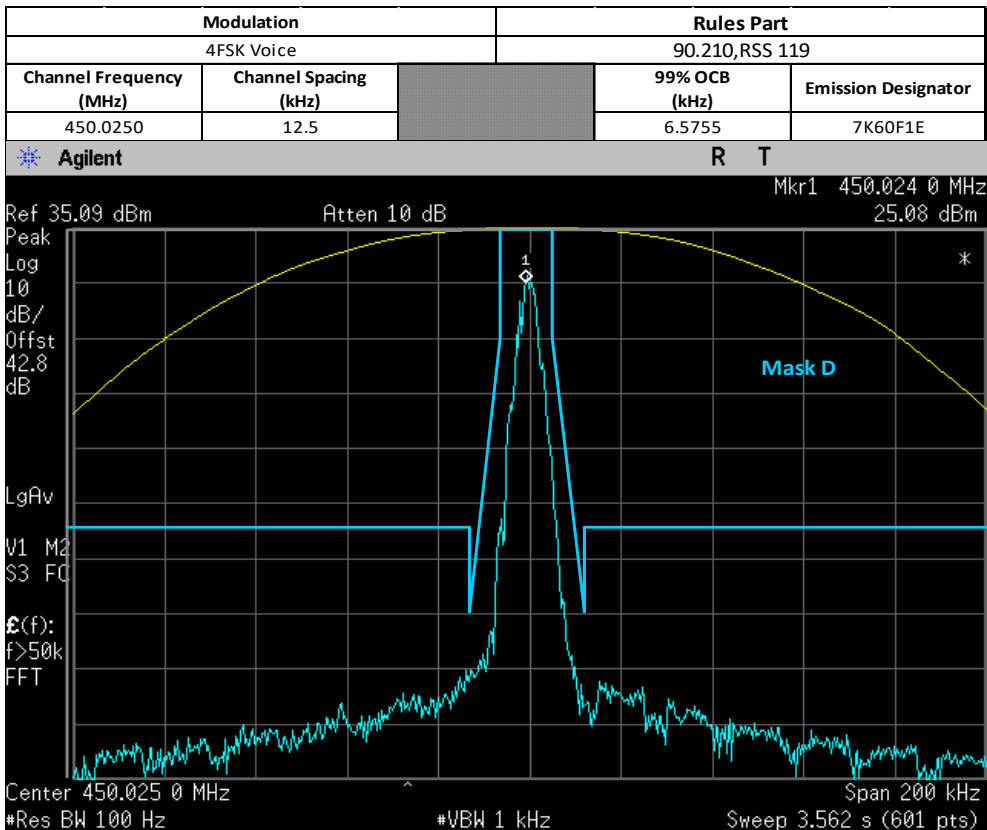
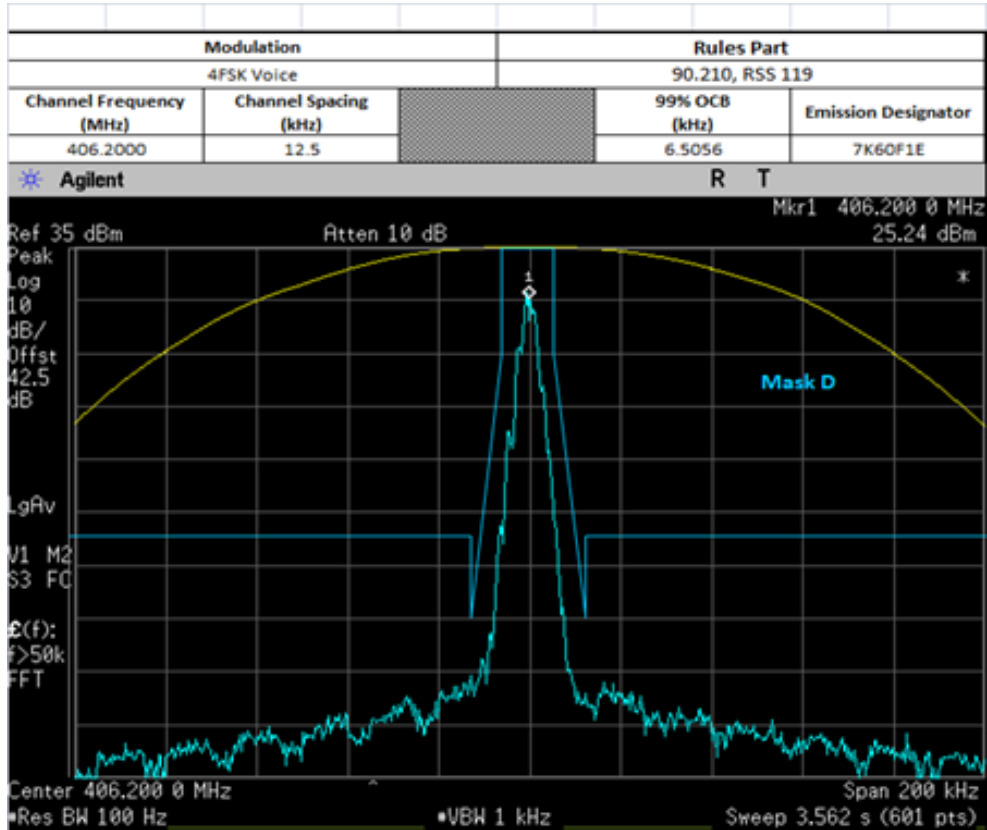

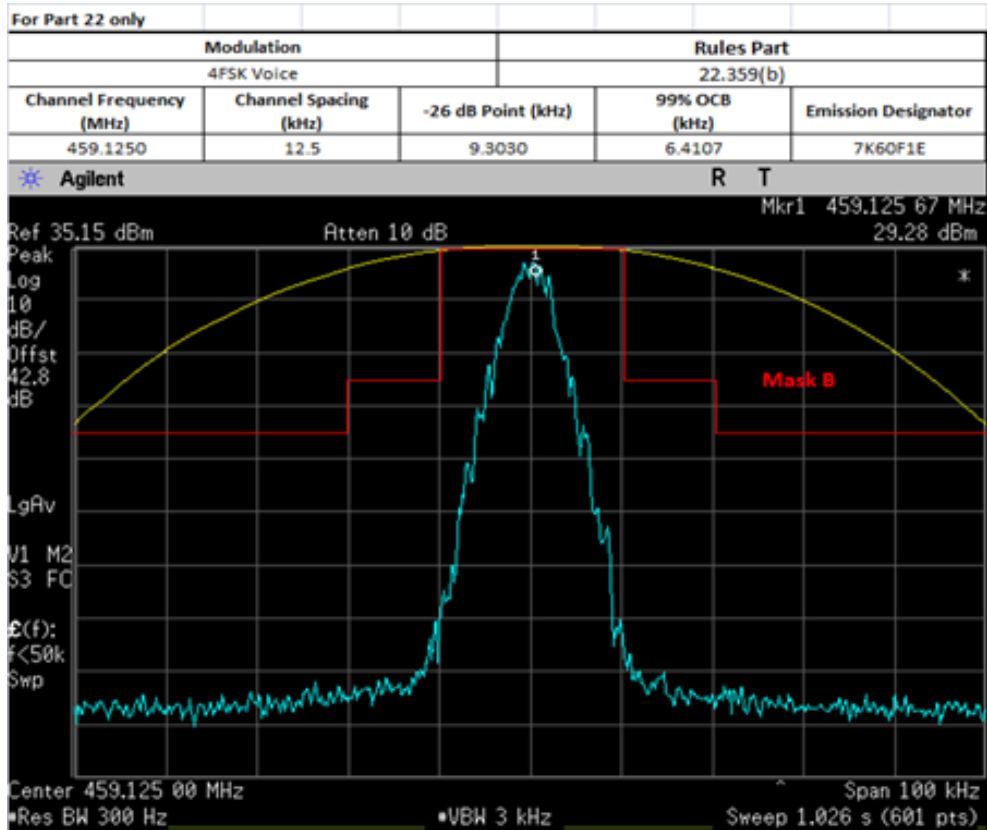

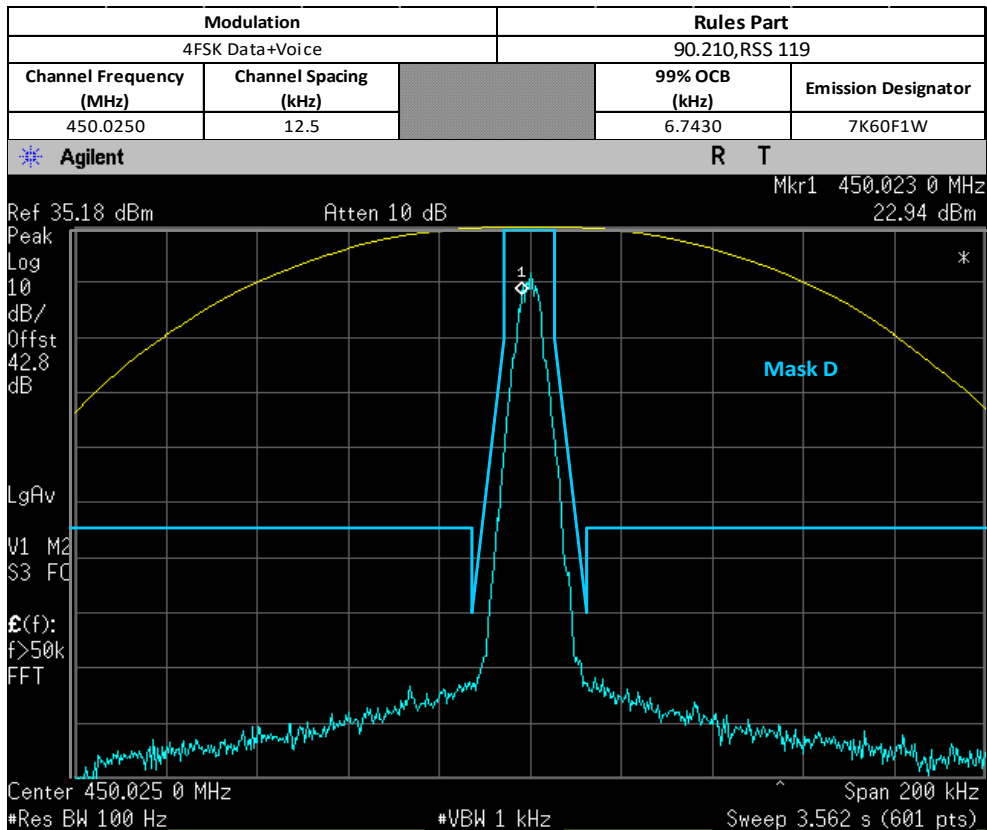
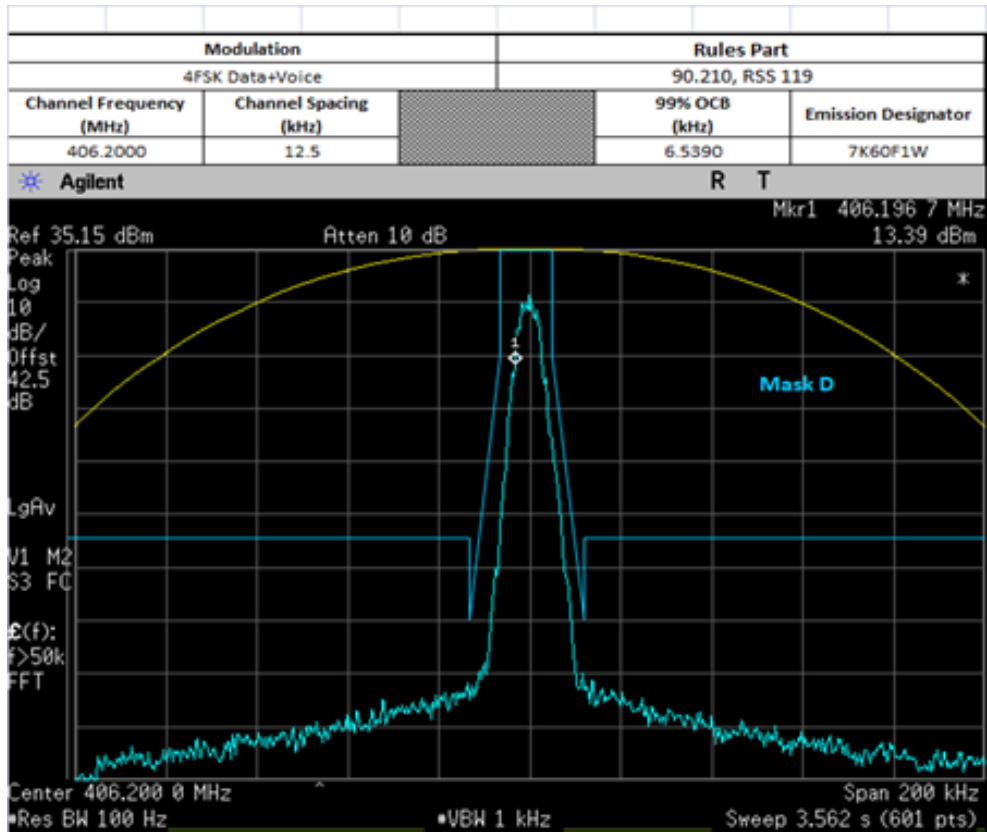

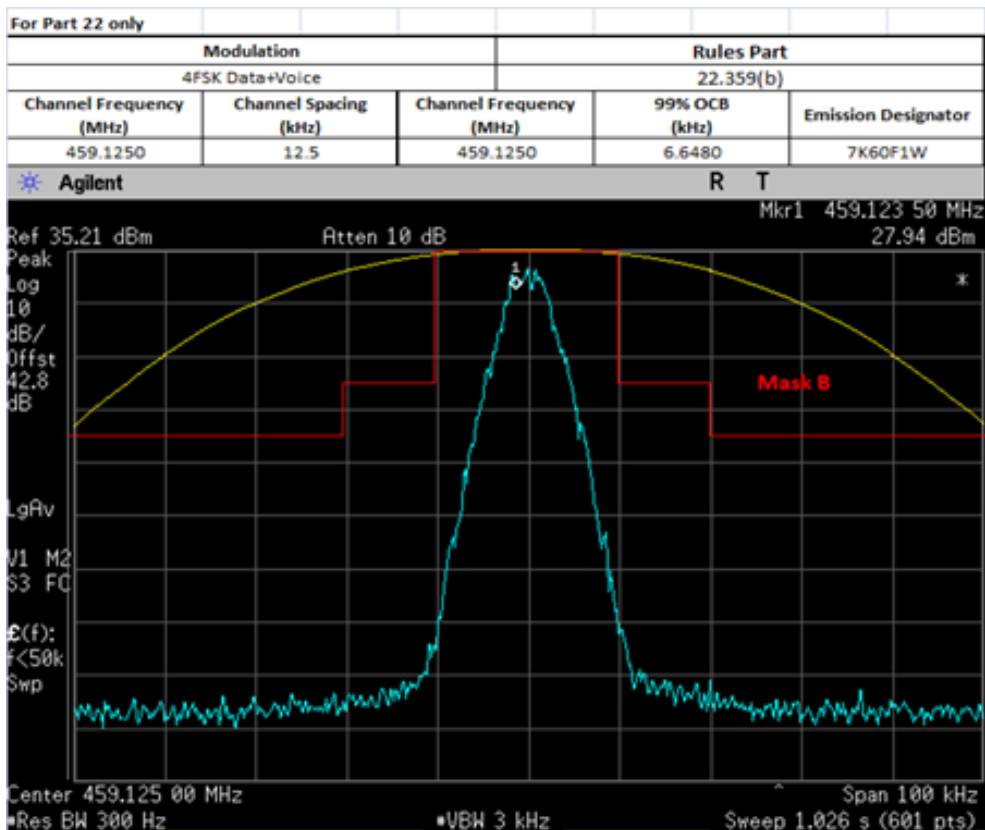

6.5.5. Test Limit

The 99% occupied bandwidth is the width of a frequency band such that, below the lower and above the upper frequency limits, the mean powers emitted are each equal to a specified percentage 0.5% of the total mean transmitted power.

6.6. Band Edge Conducted Spurious Emission (Part 22)

6.6.1. Test Setup (Analog)

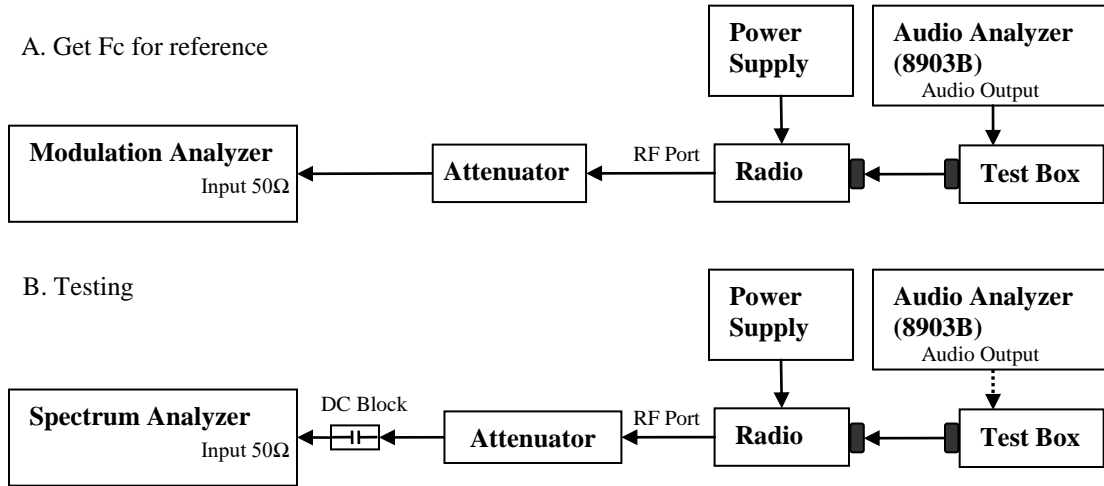

- 1) The DUT transmitter output port was connected to Modulation Analyzer.
- 2) Set the audio bandwidth filter to 15 kHz low pass filter and 50 kHz high pass filter.
- 3) Transmit the radio and set the audio analyzer to 2.5 kHz audio frequency and 50% of the rated deviation. Up the amplitude by 16 dB. Dekey the DUT.
- 4) Path loss for the measurement included.
- 5) Select the Occupied Bandwidth measurement for 99% and 26dB Emissions Bandwidth Measurement.
- 6) Key in the Fc and Resolution Bandwidth.
- 7) Transmit the DUT and record the occupied Bandwidth frequencies.
- 8) Preset the spectrum analyzer for band edge measurement.
- 9) The band edges of lowest and highest channels were measured.
- 10) Key in the Lowest and highest channel frequency, span is 60 kHz and Resolution Bandwidth is at least 1% of Emission Bandwidth.
- 11) Save the screen shot as modulated signal.
- 12) Remove the audio tone from audio analyzer to capture unmodulated signal.

*Note:

- For emission designator ending with F3E, 16K0F3E is the worst case and therefore only 16K0F3E will be shown.

6.6.2. Test Result (Analog)

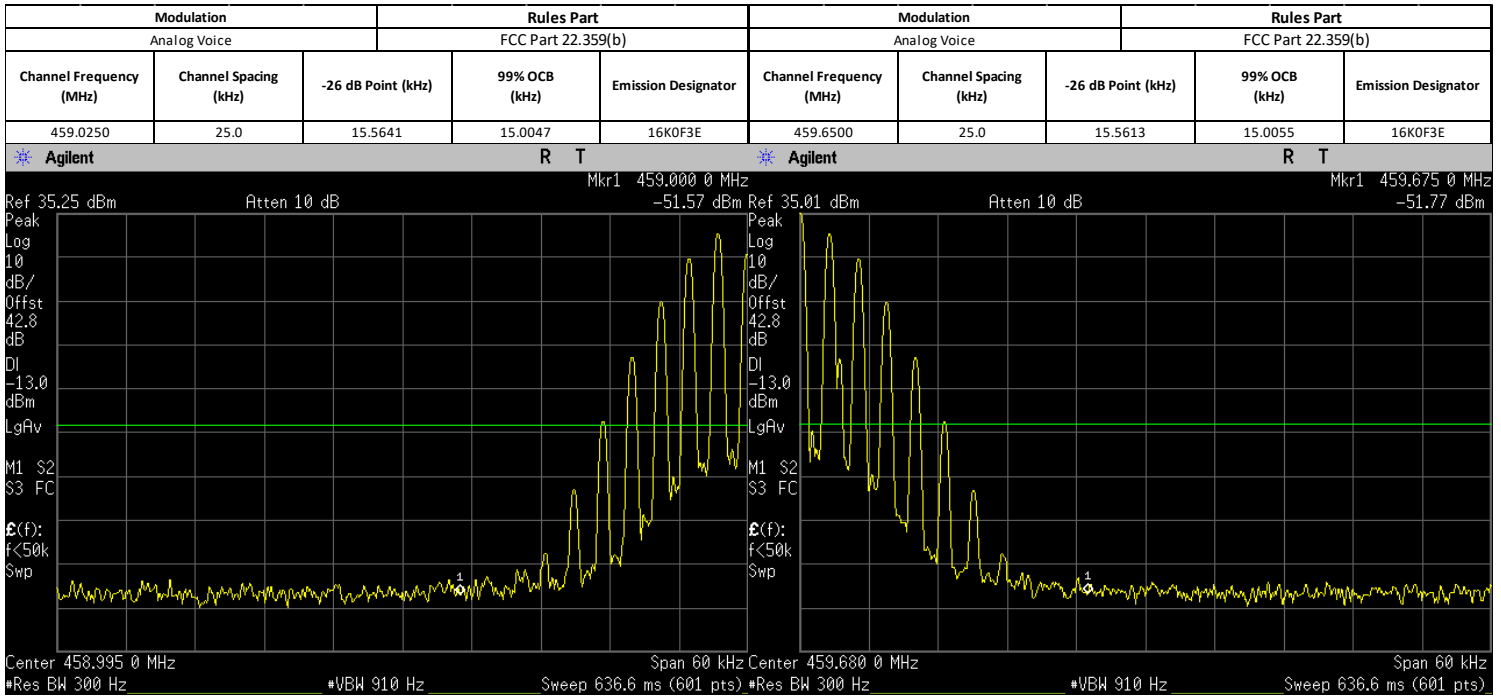

6.6.3. Test Setup (Digital)

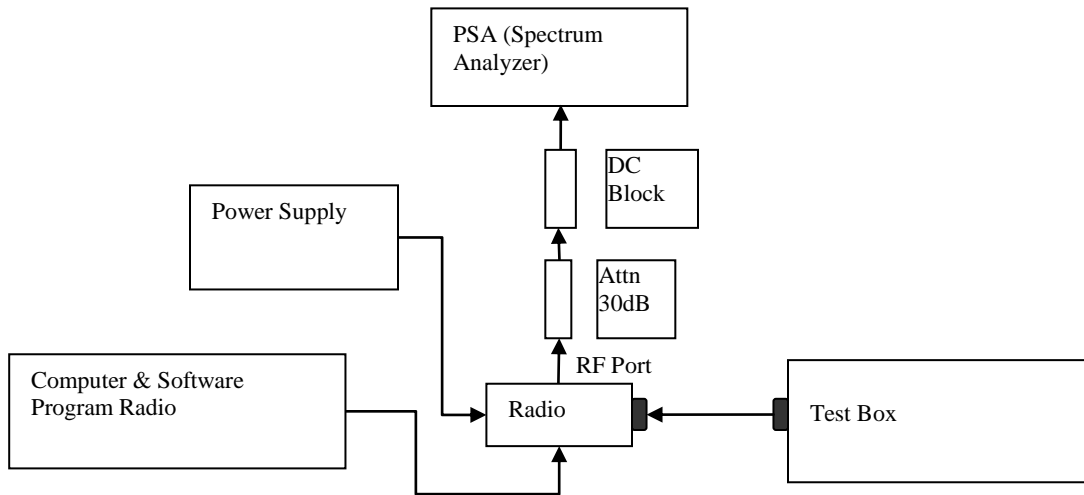

- 1) Program and set radio to operate in desire test frequency and digital mode with modulation. (*4FSK, C4FM or other digital modulation form).
- 2) Path loss for the measurement included.
- 3) Select the Occupied Bandwidth measurement for 99% and 26dB Emissions Bandwidth Measurement.
- 4) Key in the Fc and Resolution Bandwidth.
- 5) Transmit radio record the occupied Bandwidth frequencies.
- 6) Preset the spectrum analyzer for band edge measurement.
- 7) Key in the lowest and highest channels frequency, span is 60 kHz and Resolution Bandwidth is at least 1% of Emission Bandwidth.
- 8) Save the screen shot.

*Note:

- For Digital Modulation, 12.5 kHz Data F1D & FXD would be the same. Therefore only measurements with F1D modulation shown below.
- For Digital Modulation, 12.5 kHz Data F1E & FXE would be the same. Therefore only measurements with F1E modulation shown below.

6.6.4. Test Result (Digital)

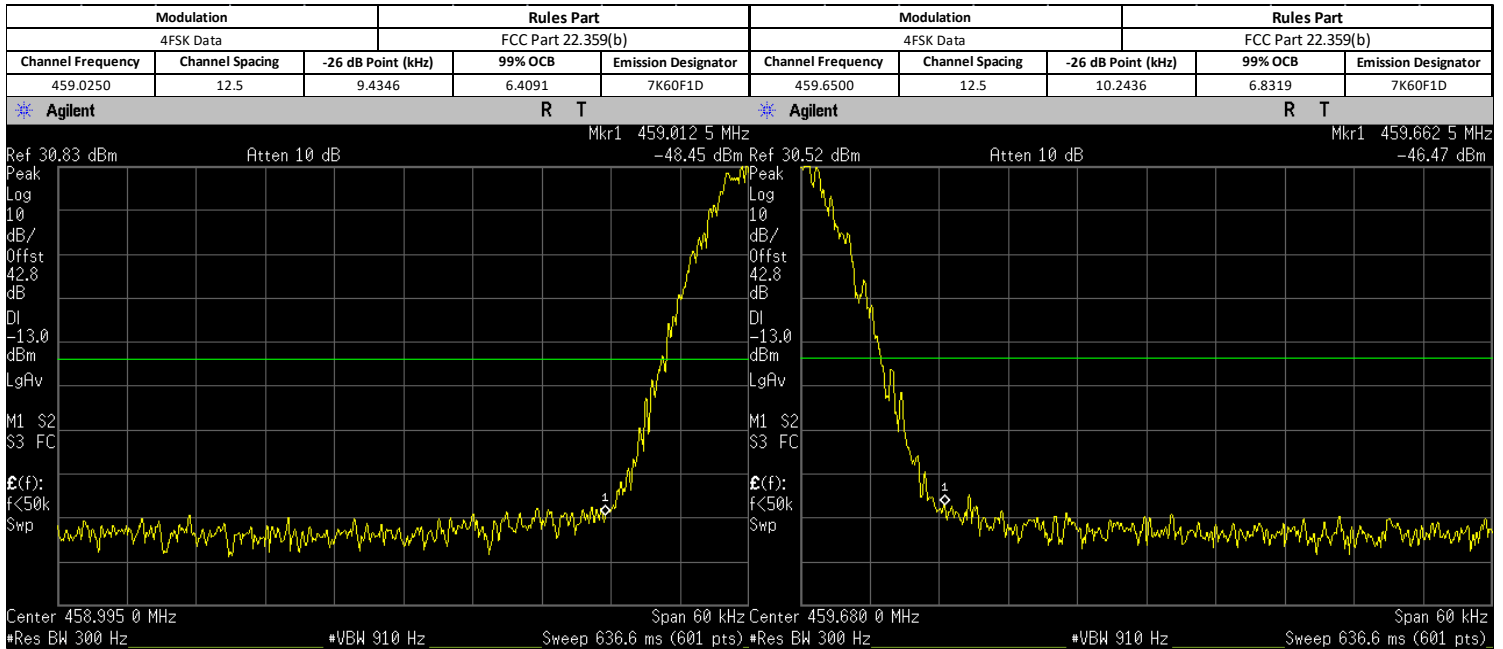

6.6.5. Test Limit

The power of any emission outside of the authorized operating frequency ranges must be attenuated below the transmitting power (P) by a factor of at least $43 + 10 \log(P)$ dB.

6.7. Transient Frequency Behavior

6.7.1. Test Setup

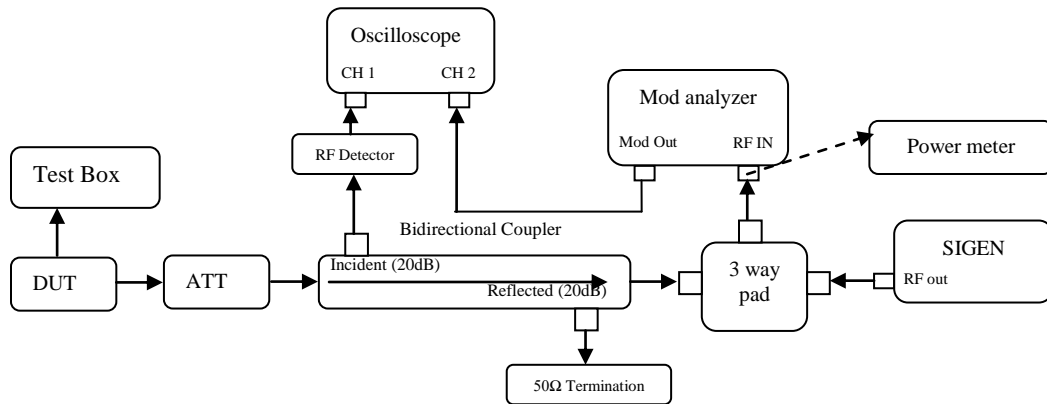

- 1) Connect the setup as figure above.
- 2) Path loss for the measurement included.
- 3) Set on Sigen with the assigned center frequency, internal 1 kHz FM tone.
FM Deviation: Analog 25kHz Channel Spacing = 25 kHz
Analog 12.5 kHz Channel Spacing = 12.5 kHz
C4FM = 12.5 kHz
- 4) Turn on 50 kHz high pass filter and 15 kHz low pass filter on modulation analyzer.
- 5) Supply sufficient attenuation ATT to provide the output power of $\leq -11\text{dBm}$ into power meter when DUT is keying up.
- 6) Note the power level on power meter and dekey the DUT.
- 7) Adjust the amplitude of the signal generator to the level power meter, maintained the amplitude throughout the rest of the measurement.
- 8) Connect the output to modulation analyzer.
- 9) Reduce 30dB attenuation and transmit the radio to get the trigger line.
- 10) Capture the screen shot for key-up (rising edge) and de-key (falling edge) mode.

6.7.2. Test Result

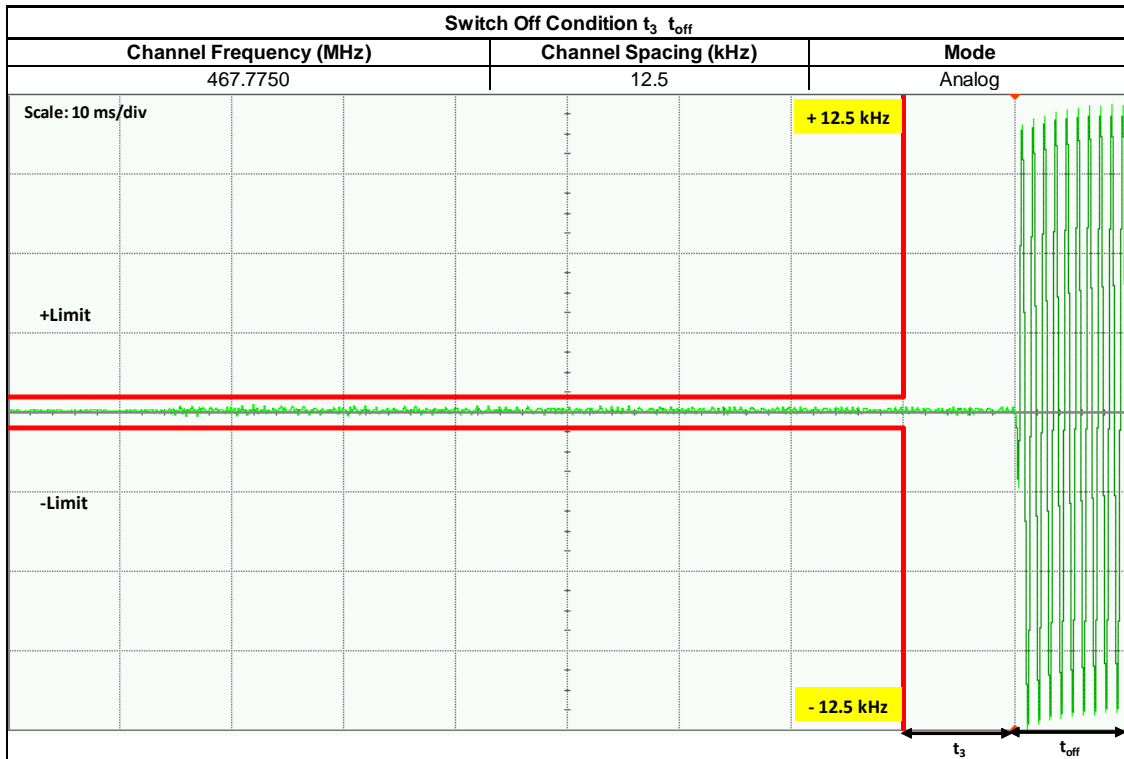
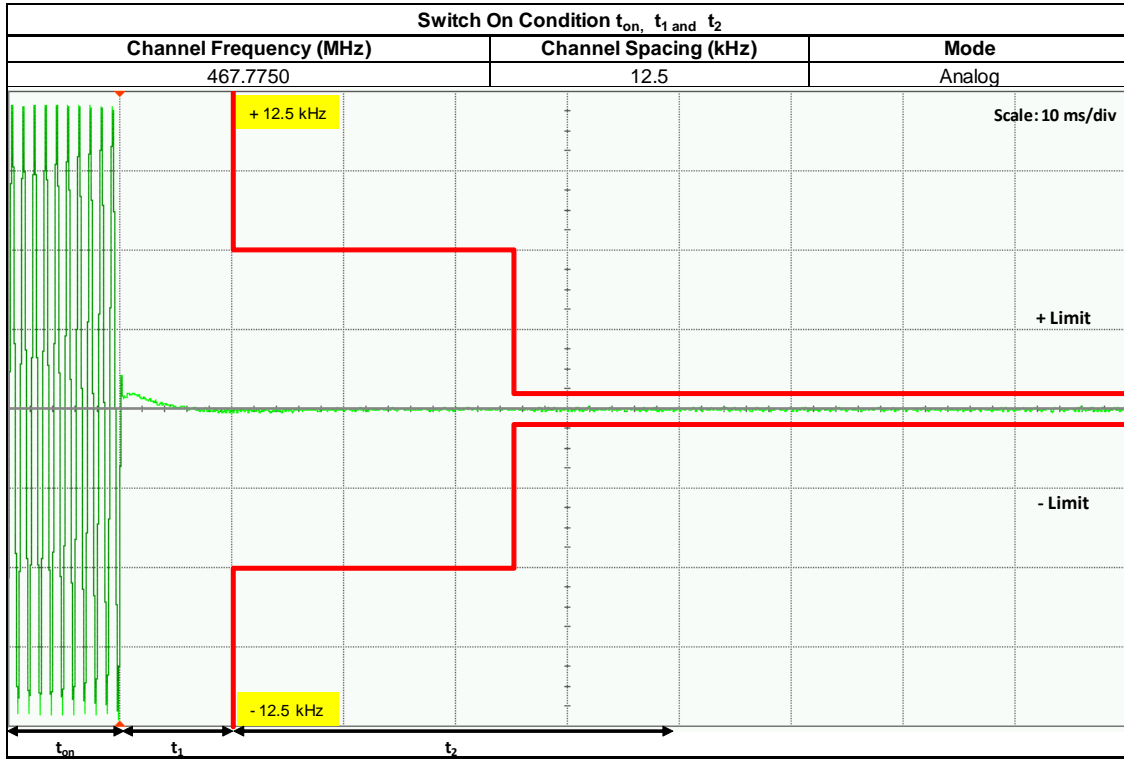

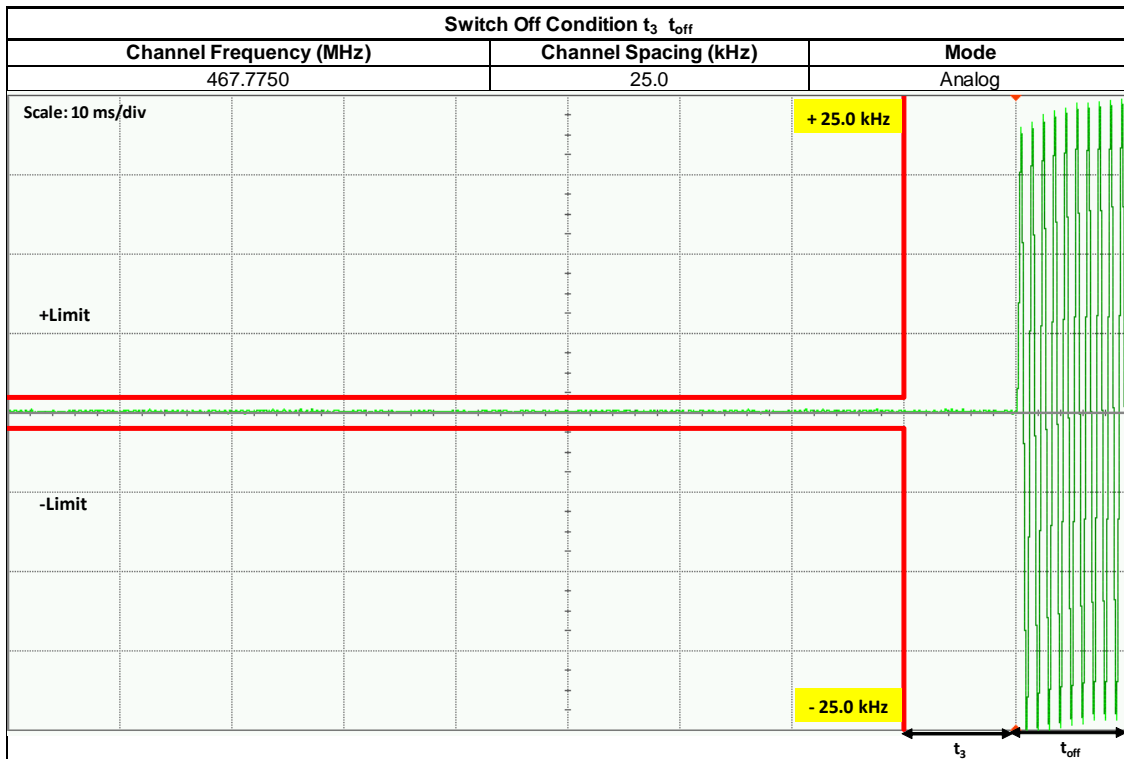
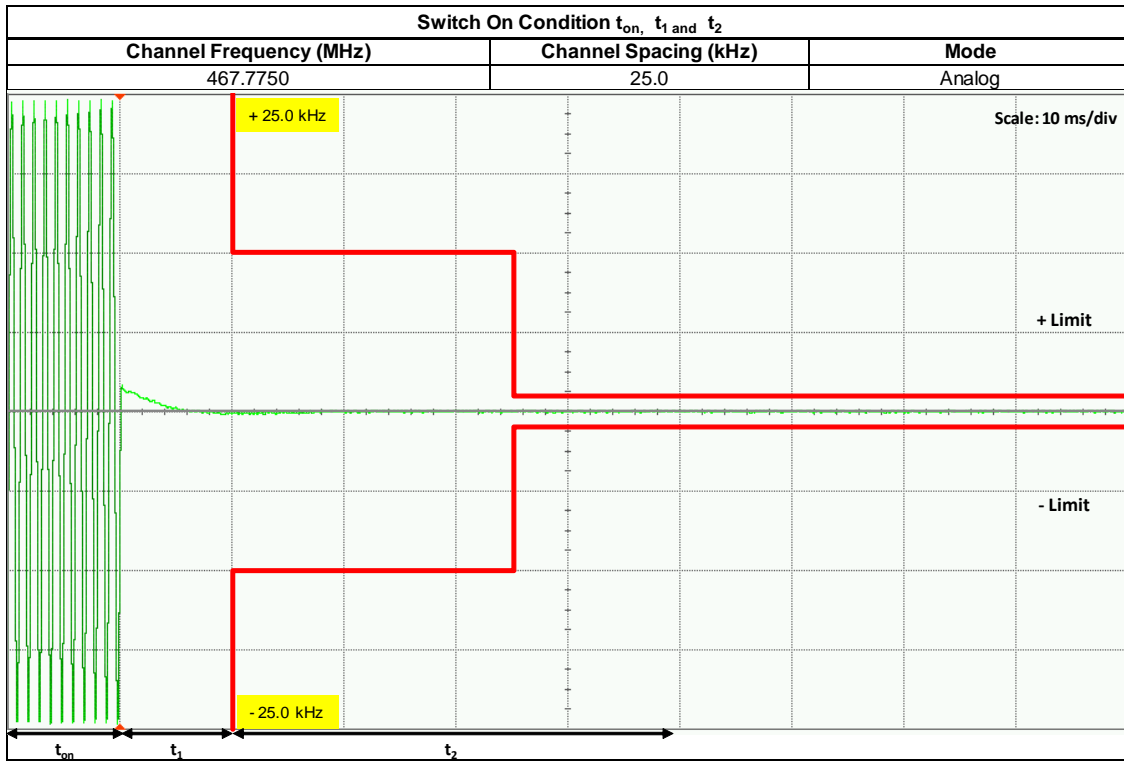

6.7.3. Test Limit

Transmitters designed to operate in the 150-174 MHz and 421-512 MHz frequency bands must maintain transient frequencies within the maximum frequency difference limits during the time intervals indicated:

Time intervals ^{1 2}	Maximum frequency difference ³	All equipment	
		150 to 174 MHz	421 to 512 MHz
Transient Frequency Behavior for Equipment Designed to Operate on 25 kHz Channels			
t_1^4	±25.0 kHz	5.0 ms	10.0 ms
t_2	±12.5 kHz	20.0 ms	25.0 ms
t_3^4	±25.0 kHz	5.0 ms	10.0 ms
Transient Frequency Behavior for Equipment Designed to Operate on 12.5 kHz Channels			
t_1^4	±12.5 kHz	5.0 ms	10.0 ms
t_2	±6.25 kHz	20.0 ms	25.0 ms
t_3^4	±12.5 kHz	5.0 ms	10.0 ms
Transient Frequency Behavior for Equipment Designed to Operate on 6.25 kHz Channels			
t_1^4	±6.25 kHz	5.0 ms	10.0 ms
t_2	±3.125 kHz	20.0 ms	25.0 ms
t_3^4	±6.25 kHz	5.0 ms	10.0 ms

¹ t_{on} is the instant when a 1 kHz test signal is completely suppressed, including any capture time due to phasing.

t_1 is the time period immediately following t_{on} .

t_2 is the time period immediately following t_1 .

t_3 is the time period from the instant when the transmitter is turned off until t_{off} .

t_{off} is the instant when the 1 kHz test signal starts to rise.

² During the time from the end of t_2 to the beginning of t_3 , the frequency difference must not exceed the limits specified in §90.213.

³ Difference between the actual transmitter frequency and the assigned transmitter frequency.

⁴ If the transmitter carrier output power rating is 6 watts or less, the frequency difference during this time period may exceed the maximum frequency difference for this time period.

6.8. Adjacent Channel Power

6.8.1. Test Setup (Analog)

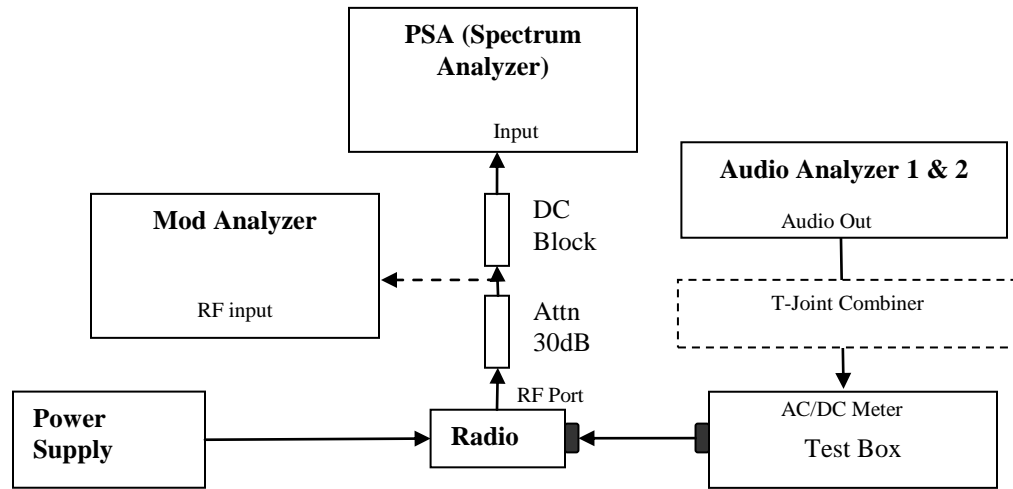

- 1) The DUT transmitter output port was connected to modulation analyzer.
- 2) Transmit the radio and turn on 1st audio analyzer with audio frequency 650Hz, 50% rated deviation, and record the amplitude value as AmpT1.
- 3) Turn off Audio analyzer 1 and turn on audio analyzer 2, set the audio frequency to 2.2 kHz and 50% deviation. Record the amplitude as AmpT2.
- 4) Turn both audio analyzers ON and up 10dB amplitude level.
- 5) Connect the output to PSA and set to assigned center frequency.
- 6) Set Span, Resolution Bandwidth and Video Bandwidth per rules part.
- 7) Transmit the radio and record the Adjacent Channel Power value in dBc.

6.8.2. Test Result Not Applicable

6.8.3. Test Setup (Digital)

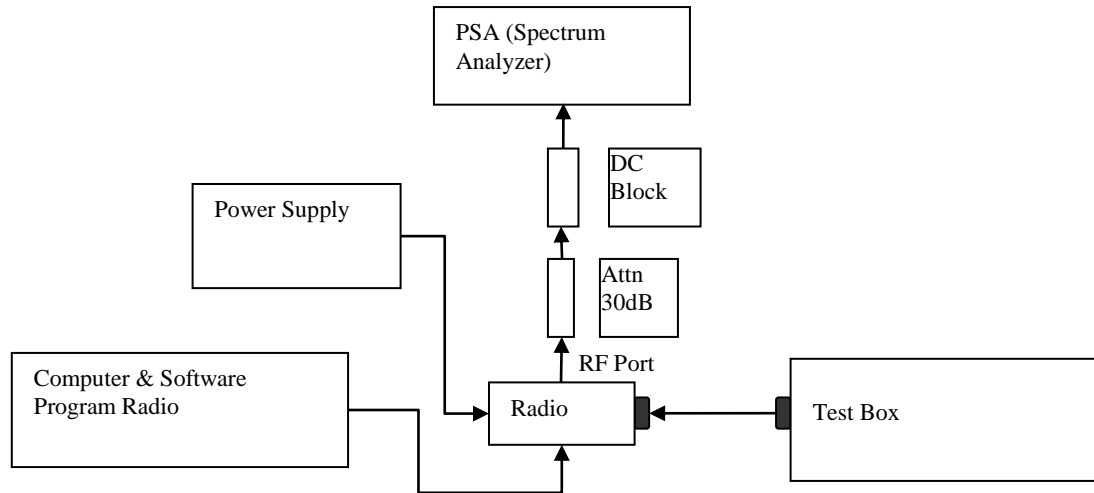

- 1) Program and set radio to operate in desire test frequency and digital mode with modulation. (4FSK, C4FM or other digital modulation form).
- 2) Prepare setup as per picture.
- 3) Turn on the ACP Measurement – Press Measure, ACP.
- 4) Set Span, Resolution Bandwidth and Video Bandwidth as per rules part.
- 5) Transmit the radio and record the Adjacent Channel Power value in dBc.

6.8.4. Test Result **Not Applicable**

6.8.5. Test Limit

12.5 kHz MOBILE TRANSMITTER ACP REQUIREMENTS

Offset from center frequency (kHz)	Measurement bandwidth (kHz)	Maximum ACP relative (dBc)
9.375	6.25	-40
15.625	6.25	-60
21.875	6.25	-60
37.50	25.00	-60
62.50	25.00	-65
87.50	25.00	-65
150.00	100	-65
250.00	100	-65
350.00	100	-65
>400 to 12 MHz	30 (s)	-75
12 MHz to paired receive band	30 (s)	-75
In the paired receive band	30 (s)	-100

25 kHz MOBILE TRANSMITTER ACP REQUIREMENTS

Offset from center frequency (kHz)	Measurement bandwidth (kHz)	Maximum ACP relative (dBc)
15.625	6.25	-40
21.875	6.25	-60
37.50	25	-60
62.50	25	-65
87.50	25	-65
150.00	100	-65
250.00	100	-65
350.00	100	-65
>400 kHz to 12 MHz	30 (s)	-75
12 MHz to paired receive band	30 (s)	-75
In the paired receive band	30 (s)	-100

12.5 kHz BASE TRANSMITTER ACP REQUIREMENTS

Offset from center frequency (kHz)	Measurement bandwidth (kHz)	Maximum ACP (dBc)
9.375	6.25	-40
15.625	6.25	-60
21.875	6.25	-60
37.5	25	-60
62.5	25	-65
87.5	25	-65
150	100	-65
250	100	-65
350.00	100	-65
>400 kHz to 12 MHz	30 (s)	-80
12 MHz to paired receive band	30 (s)	-80
In the paired receive band	30 (s)	¹ -85

25 kHz BASE TRANSMITTER ACP REQUIREMENTS

Offset from center frequency (kHz)	Measurement bandwidth (kHz)	Maximum ACP (dBc)
15.625	6.25	-40
21.875	6.25	-60
37.5	25	-60
62.5	25	-65
87.5	25	-65
150	100	-65
250	100	-65
350	100.00	-65
>400 kHz to 12 MHz	30 (s)	-80
12 MHz to paired receive band	30 (s)	-80
In the paired receive band	30 (s)	¹ -85

6.9. Conducted Spurious Emission

6.9.1. Test Setup

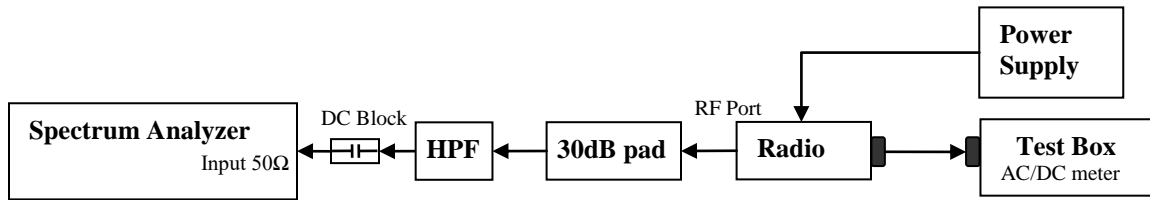

- 1) The DUT transmitter output port was connected to Spectrum Analyzer with above setup.
- 2) Program and set radio to operate in desire test frequency and mode. (Analog / digital modulation form).
- 3) Path loss for the measurement included.
- 4) Set the PSA Resolution Bandwidth as per rules part.
- 5) Set the Ref offset from the pathloss offset calibration file.
- 6) Adjust the center frequency of the spectrum analyzer for incremental coverage of the range from:
 - a. 9 KHz to $F_c - \text{Test Bandwidth}$
 - b. $F_c + \text{Test Bandwidth}$ to $2F_c - 5\text{MHz}$.
- 7) Key up the DUT, Peak Search the highest Spur and record the levels of spurious emissions
- 8) Dekey the DUT.
- 9) Turn On High Pass Filter path and Key up the DUT.
- 10) Adjust the PSA Freq for incremental coverage of range from $2F_c$ to $10F_c$
- 11) Key up the DUT and record the highest spur levels of spurious emissions.

6.9.2. Test Result (Analog)

Not for FCC Review

Analog: 403.0125 MHz, 25 kHz Channel Spacing, Max. Power

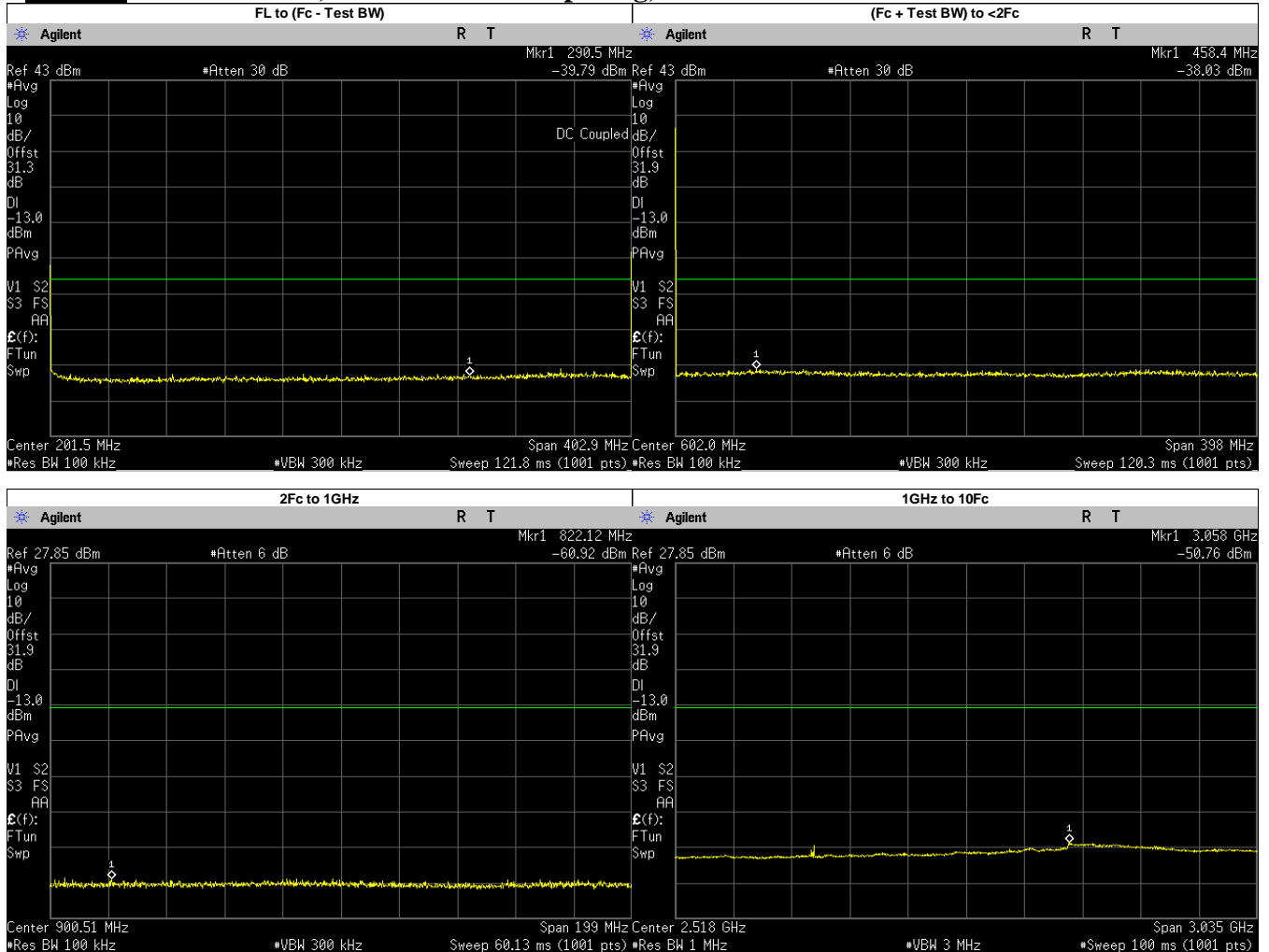

Frequency Range	Highest Spur Frequency (MHz)	Spurious Level (dBm)	Failing Limit (dBm)	Results
FL to (Fc - Test BW)	290.5000	-39.7940	-13.00	PASS
(Fc + Test BW) to <2Fc	458.4000	-38.0300	-13.00	PASS
2Fc to 1GHz 1GHz to 10Fc	822.1164	-60.9200	-13.00	PASS
	3057.8150	-50.7600	-13.00	PASS
	1209.0370	-54.7161	-13.00	PASS
	1612.0500	-54.6956	-13.00	PASS
	2015.0620	-54.4506	-13.00	PASS
	2418.0750	-54.0362	-13.00	PASS
	2821.0880	-52.7455	-13.00	PASS
	3224.1000	-51.8722	-13.00	PASS
	3627.1130	-52.9634	-13.00	PASS
4030.1250	-53.2021	-13.00	PASS	

Not for FCC Review

Analog: 406.2 MHz, 25 kHz Channel Spacing, Max. Power

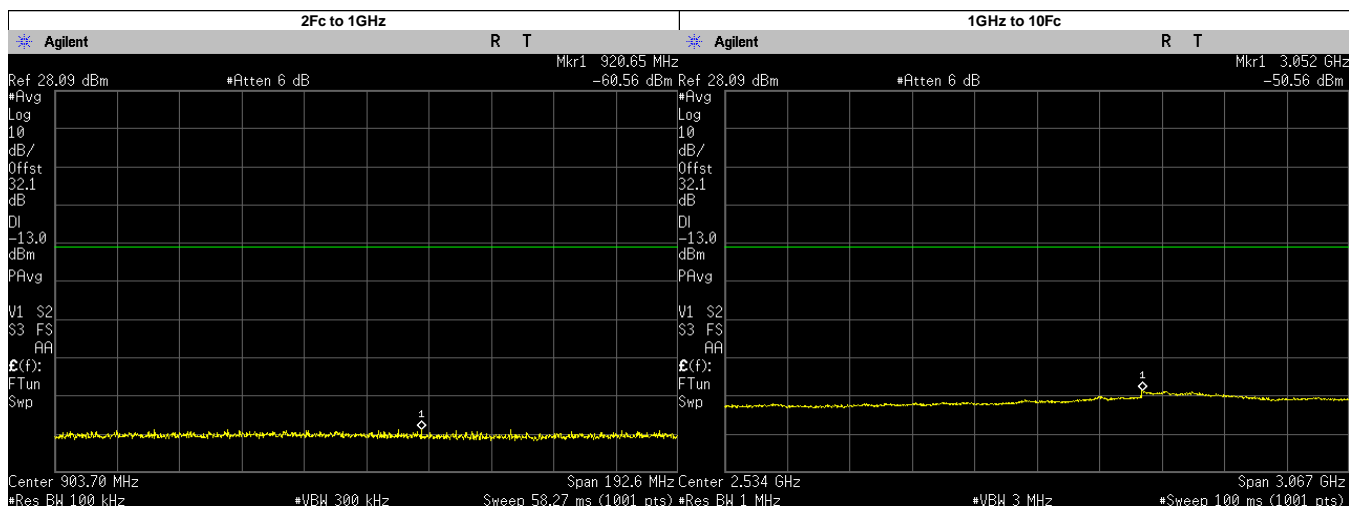
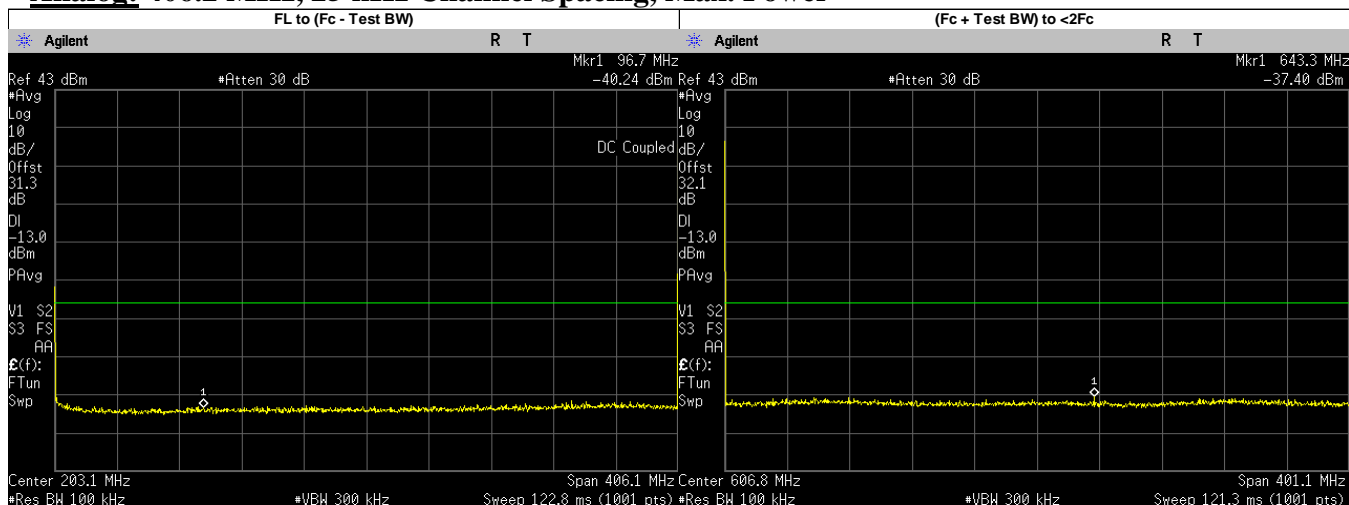

Frequency Range	Highest Spur Frequency (MHz)	Spurious Level (dBm)	Failing Limit (dBm)	Results
FL to (Fc - Test BW)	96.7000	-40.2420	-13.00	PASS
(Fc + Test BW) to <2Fc	643.3320	-37.4000	-13.00	PASS
2Fc to 1GHz 1GHz to 10Fc	920.6488	-60.5600	-13.00	PASS
	3051.8230	-50.5600	-13.00	PASS
	1218.6000	-54.3380	-13.00	PASS
	1624.8000	-54.5600	-13.00	PASS
	2031.0000	-54.1485	-13.00	PASS
	2437.2000	-53.6740	-13.00	PASS
	2843.4000	-52.4452	-13.00	PASS
	3249.6000	-51.4833	-13.00	PASS
3655.8000	-52.9206	-13.00	PASS	
4062.0000	-52.9188	-13.00	PASS	

Analog: 450.025 MHz, 25 kHz Channel Spacing, Max. Power

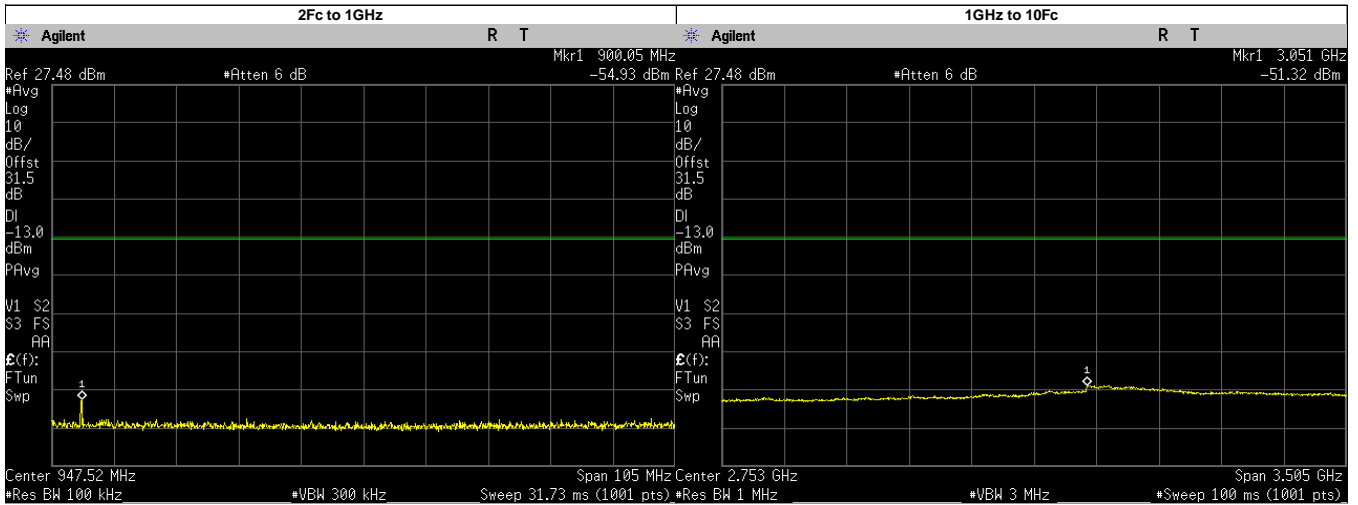
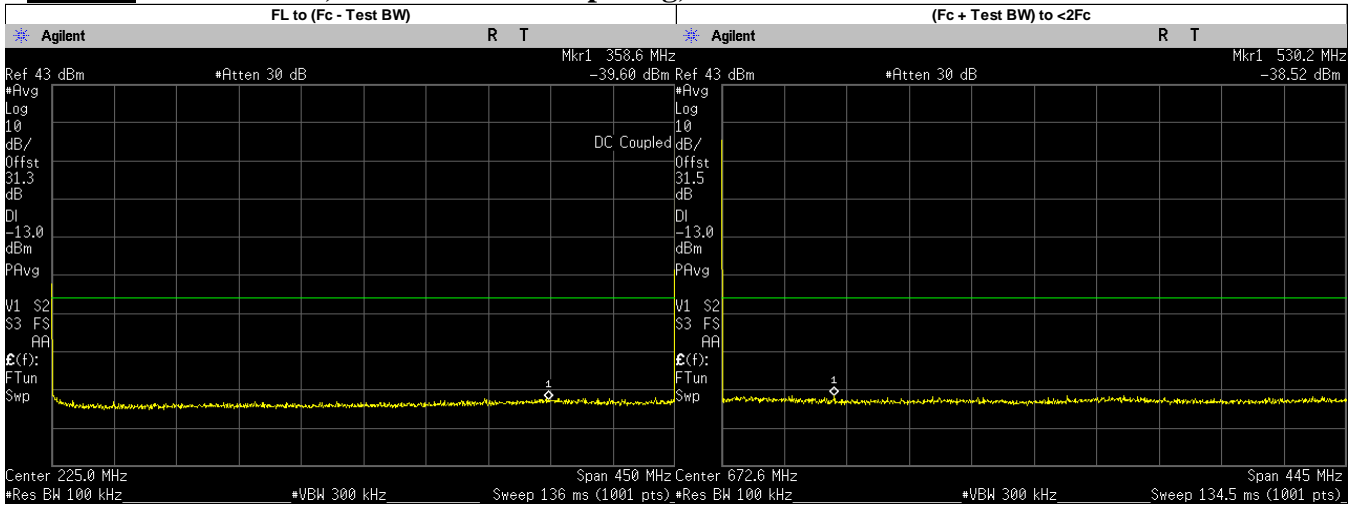

Frequency Range	Highest Spur Frequency (MHz)	Spurious Level (dBm)	Failing Limit (dBm)	Results
FL to (Fc - Test BW)	358.6000	-39.6000	-13.00	PASS
(Fc + Test BW) to <2Fc	530.1761	-38.5200	-13.00	PASS
2Fc to 1GHz 1GHz to 10Fc	900.0500	-54.9300	-13.00	PASS
	3050.5710	-51.3200	-13.00	PASS
	1350.0750	-55.0971	-13.00	PASS
	1800.1000	-54.8149	-13.00	PASS
	2250.1250	-54.6231	-13.00	PASS
	2700.1500	-54.0468	-13.00	PASS
	3150.1750	-51.6741	-13.00	PASS
	3600.2000	-53.0337	-13.00	PASS
4050.2250	-53.4843	-13.00	PASS	
4500.2500	-54.0854	-13.00	PASS	

Analog: 450.025 MHz, 25 kHz Channel Spacing, Low. Power

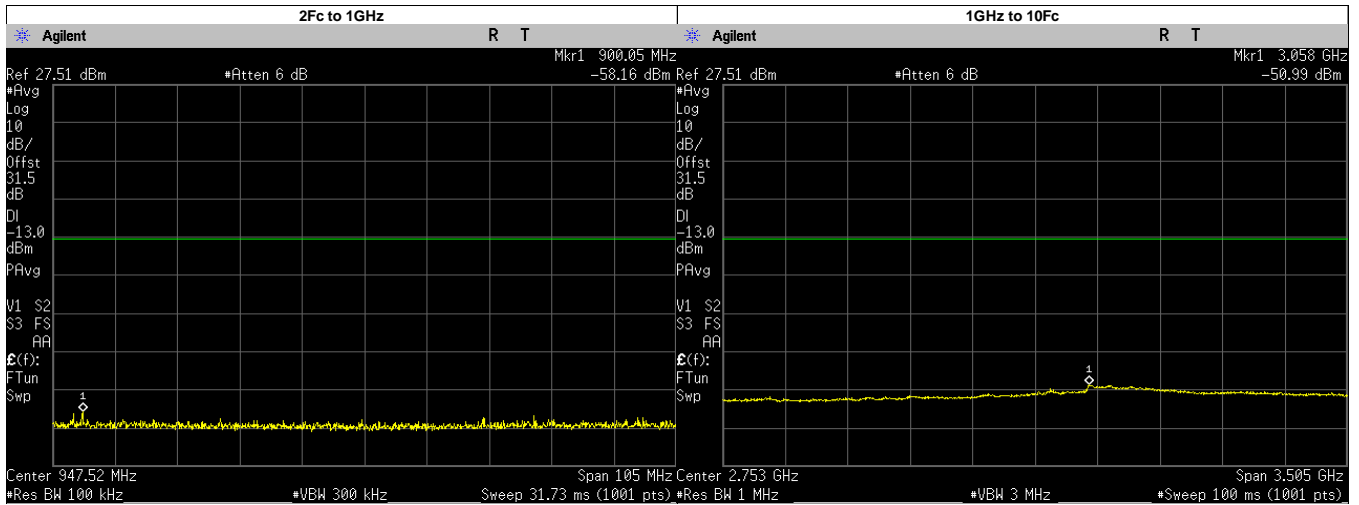
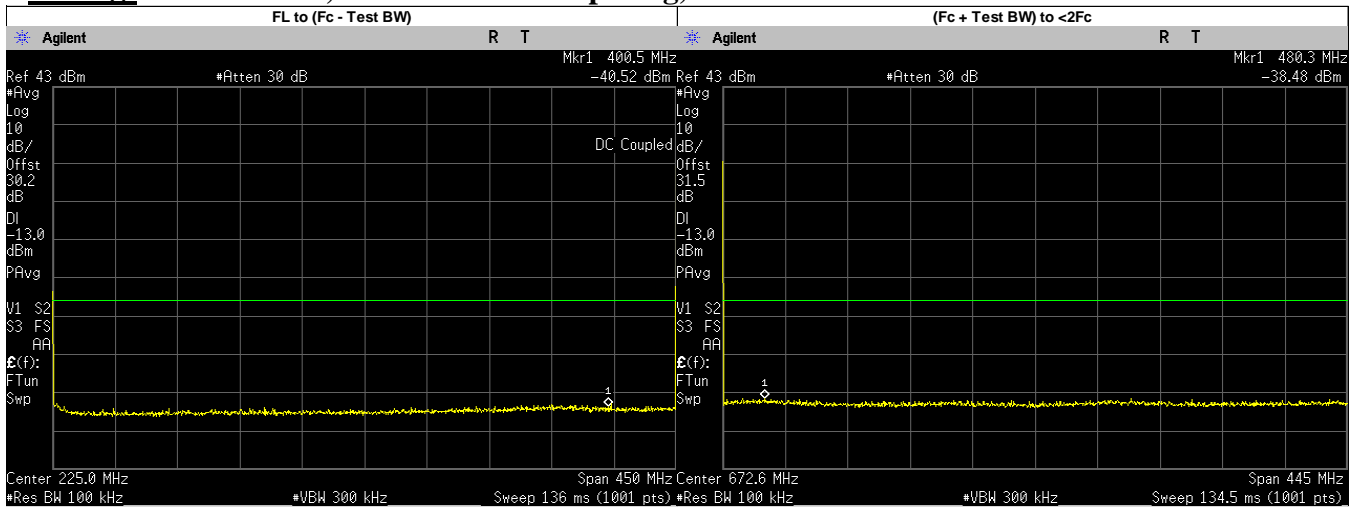

Frequency Range	Highest Spur Frequency (MHz)	Spurious Level (dBm)	Failing Limit (dBm)	Results
FL to (Fc - Test BW)	400.5000	-40.5200	-13.00	PASS
(Fc + Test BW) to <2Fc	480.3396	-38.4800	-13.00	PASS
2Fc to 1GHz 1GHz to 10Fc	900.0500	-58.1592	-13.00	PASS
	3057.5820	-50.9900	-13.00	PASS
	1350.0750	-54.9758	-13.00	PASS
	1800.1000	-54.6180	-13.00	PASS
	2250.1250	-54.5884	-13.00	PASS
	2700.1500	-53.7765	-13.00	PASS
	3150.1750	-51.6752	-13.00	PASS
	3600.2000	-53.0110	-13.00	PASS
	4050.2250	-53.3889	-13.00	PASS
4500.2500	-53.9521	-13.00	PASS	

For Part 22

Analog: 459.125 MHz, 25 kHz Channel Spacing, Max. Power

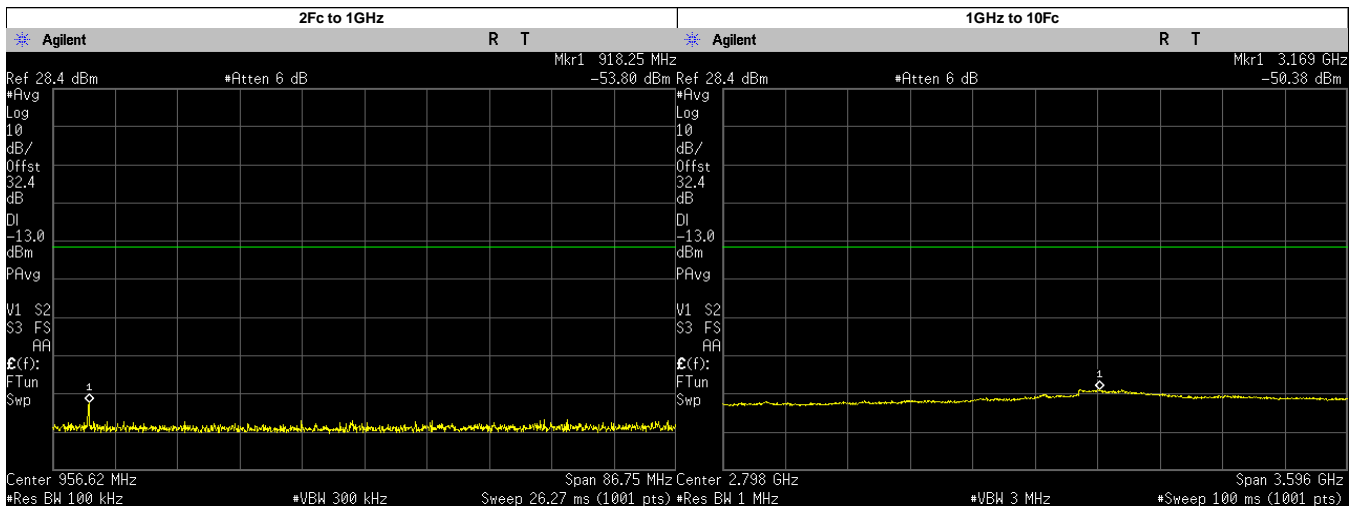
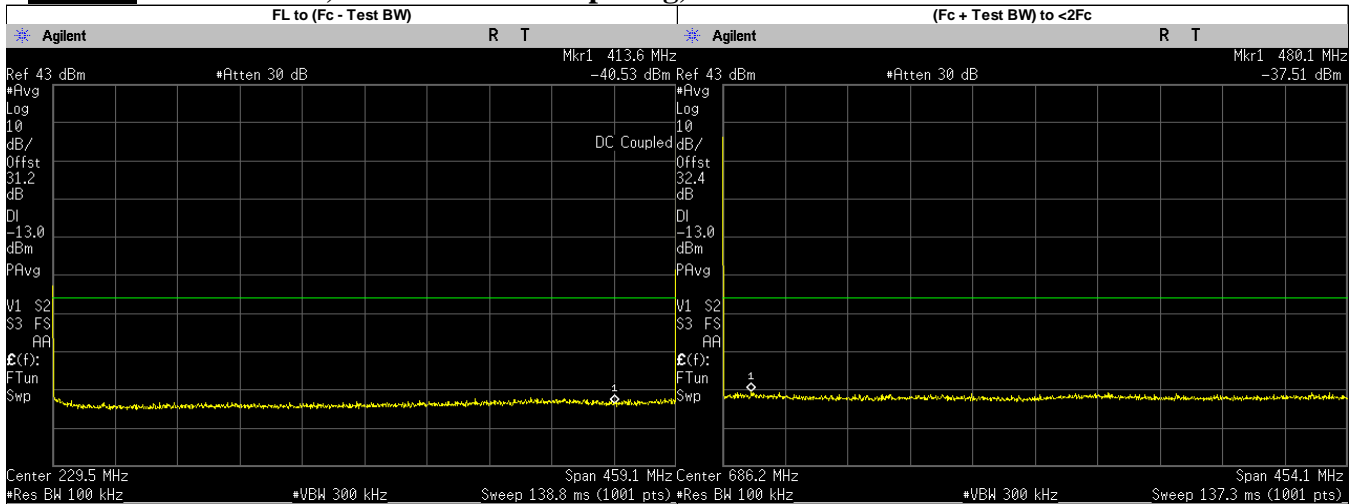

Frequency Range	Highest Spur Frequency (MHz)	Spurious Level (dBm)	Failing Limit (dBm)	Results
FL to (Fc - Test BW)	413.6000	-40.5270	-13.00	PASS
(Fc + Test BW) to <2Fc	480.0689	-37.5100	-13.00	PASS
2Fc to 1GHz 1GHz to 10Fc	918.2500	-53.8000	-13.00	PASS
	3168.5390	-50.3800	-13.00	PASS
	1377.3750	-54.0633	-13.00	PASS
	1836.5000	-53.6707	-13.00	PASS
	2295.6250	-53.6920	-13.00	PASS
	2754.7500	-52.8286	-13.00	PASS
	3213.8750	-51.1500	-13.00	PASS
	3673.0000	-52.5729	-13.00	PASS
	4132.1250	-52.7053	-13.00	PASS
4591.2500	-52.8967	-13.00	PASS	

Analog: 467.775 MHz, 25 kHz Channel Spacing, Max. Power

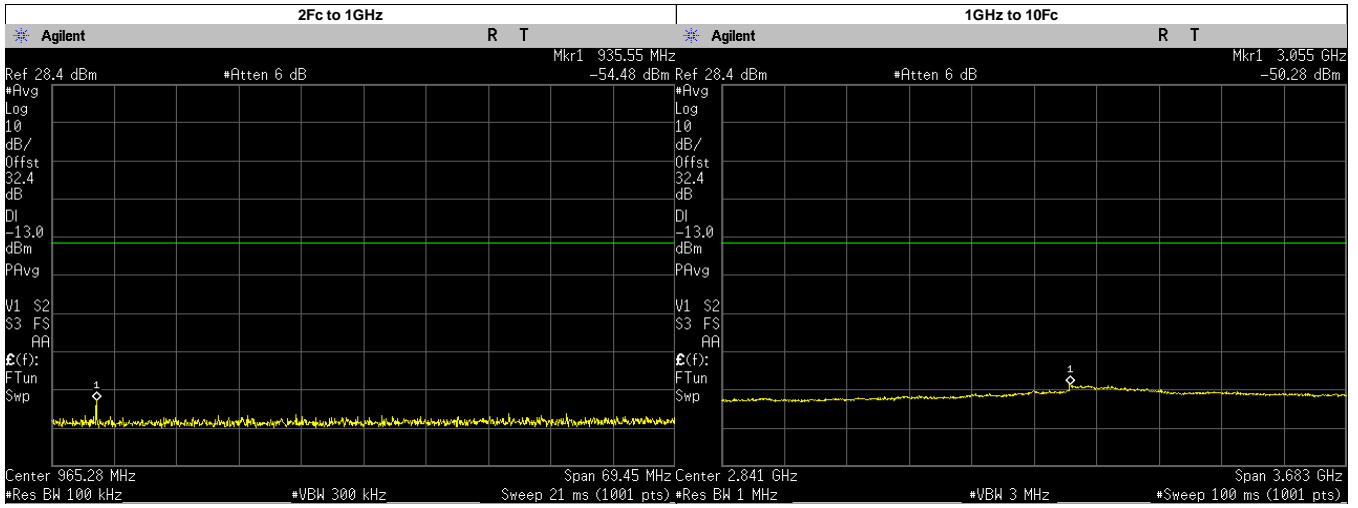
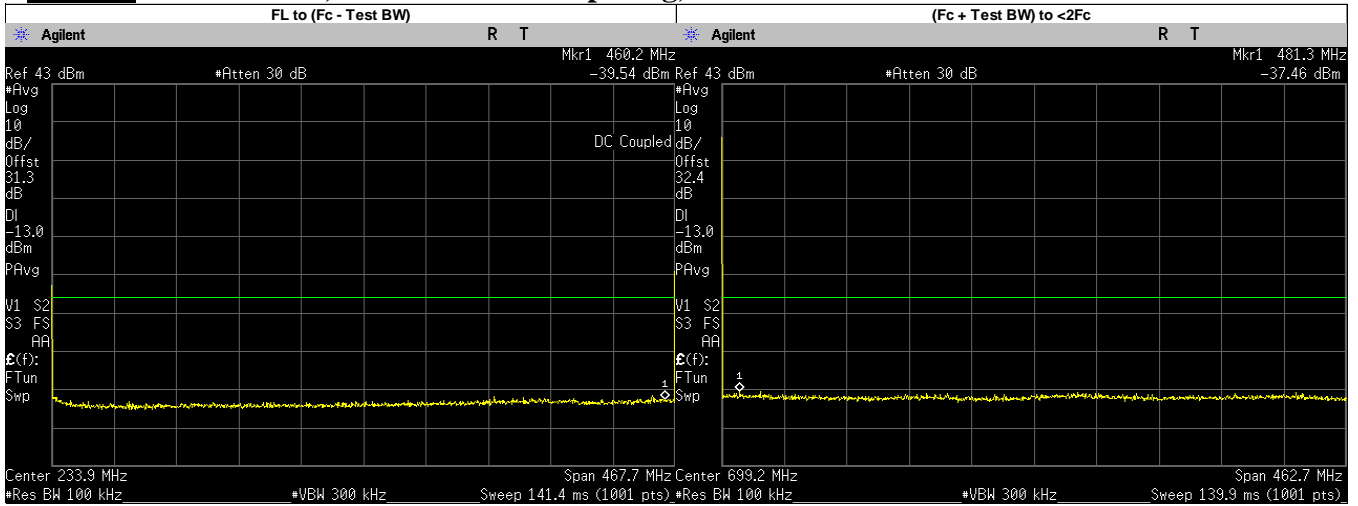

Frequency Range	Highest Spur Frequency (MHz)	Spurious Level (dBm)	Failing Limit (dBm)	Results
FL to (Fc - Test BW)	460.2000	-39.5390	-13.00	PASS
(Fc + Test BW) to <2Fc	481.2506	-37.4600	-13.00	PASS
2Fc to 1GHz 1GHz to 10Fc	935.5500	-54.4800	-13.00	PASS
	3054.9740	-50.2800	-13.00	PASS
	1403.3250	-54.0752	-13.00	PASS
	1871.1000	-53.9533	-13.00	PASS
	2338.8750	-53.7159	-13.00	PASS
	2806.6500	-52.5497	-13.00	PASS
	3274.4250	-50.7064	-13.00	PASS
	3742.2000	-52.5179	-13.00	PASS
	4209.9750	-52.8712	-13.00	PASS
4677.7500	-52.9994	-13.00	PASS	

Analog: 467.775 MHz, 25 kHz Channel Spacing, Low. Power

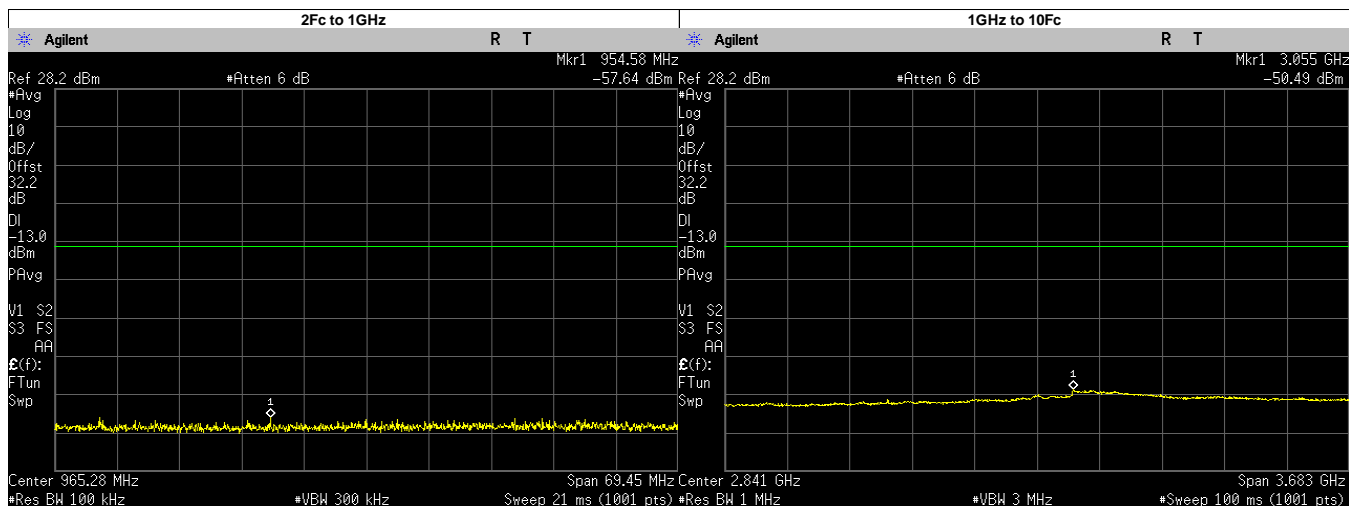
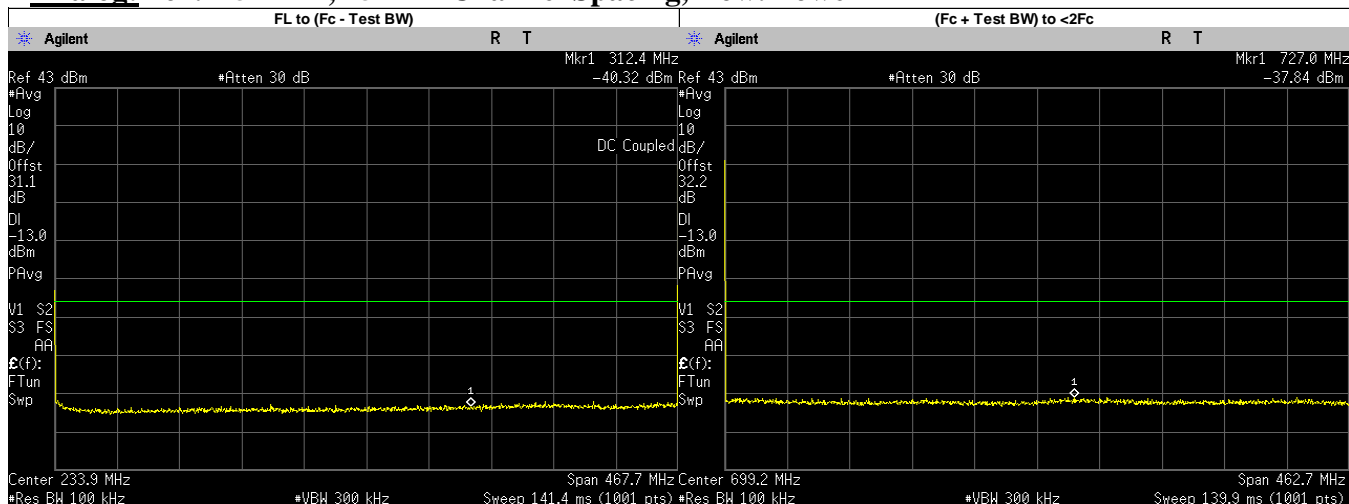

Frequency Range	Highest Spur Frequency (MHz)	Spurious Level (dBm)	Failing Limit (dBm)	Results
FL to (Fc - Test BW)	312.4000	-40.3170	-13.00	PASS
(Fc + Test BW) to <2Fc	726.9540	-37.8400	-13.00	PASS
2Fc to 1GHz 1GHz to 10Fc	954.5797	-57.6400	-13.00	PASS
	3054.9740	-50.4900	-13.00	PASS
	1403.3250	-54.6158	-13.00	PASS
	1871.1000	-54.0863	-13.00	PASS
	2338.8750	-53.6974	-13.00	PASS
	2806.6500	-52.7186	-13.00	PASS
	3274.4250	-51.3756	-13.00	PASS
	3742.2000	-52.6271	-13.00	PASS
4209.9750	-52.9855	-13.00	PASS	
4677.7500	-53.0329	-13.00	PASS	

Not for FCC Review

Analog: 469.9875 MHz, 25 kHz Channel Spacing, Max. Power

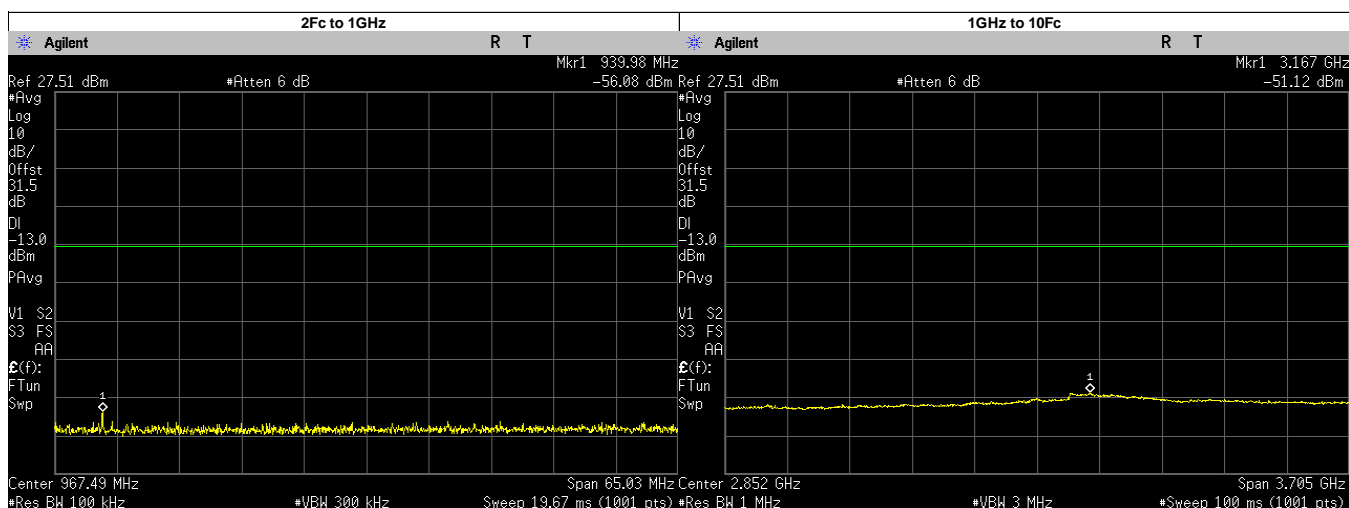
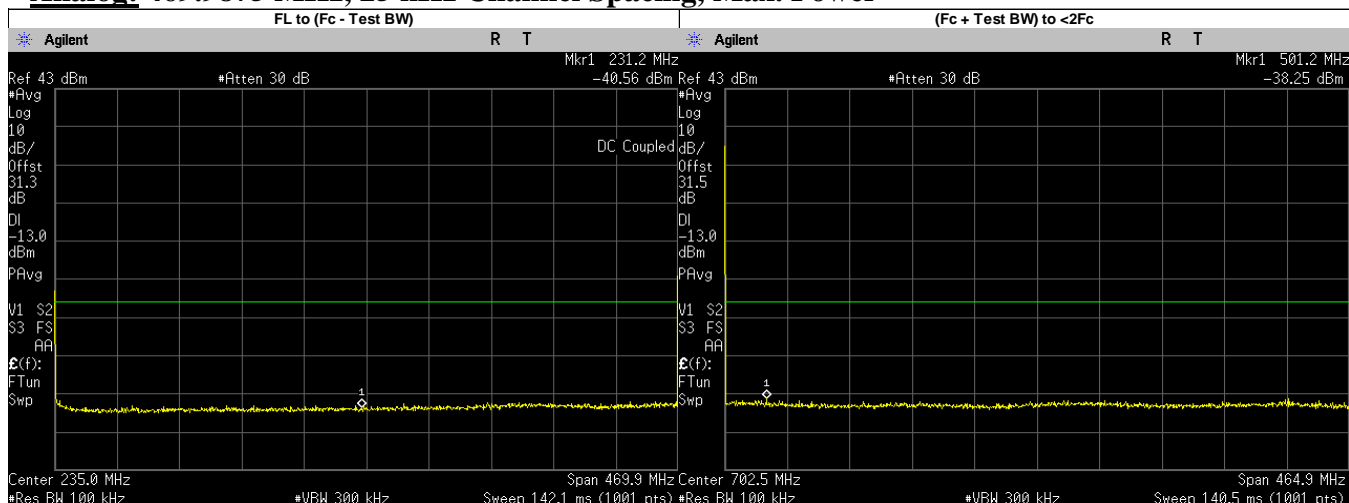

Frequency Range	Highest Spur Frequency (MHz)	Spurious Level (dBm)	Failing Limit (dBm)	Results
FL to (Fc - Test BW)	231.2000	-40.5570	-13.00	PASS
(Fc + Test BW) to <2Fc	501.1947	-38.2500	-13.00	PASS
2Fc to 1GHz 1GHz to 10Fc	939.9750	-56.0800	-13.00	PASS
	3167.3520	-51.1200	-13.00	PASS
	1409.9630	-55.3474	-13.00	PASS
	1879.9500	-54.9627	-13.00	PASS
	2349.9370	-54.4241	-13.00	PASS
	2819.9250	-53.0646	-13.00	PASS
	3289.9120	-51.5243	-13.00	PASS
	3759.9000	-53.2220	-13.00	PASS
	4229.8870	-53.6731	-13.00	PASS
4699.8750	-53.6925	-13.00	PASS	

6.9.3. Test Result (Digital)

Not for FCC Review

Digital: 403.0125 MHz, 12.5 kHz Channel Spacing, Max. Power

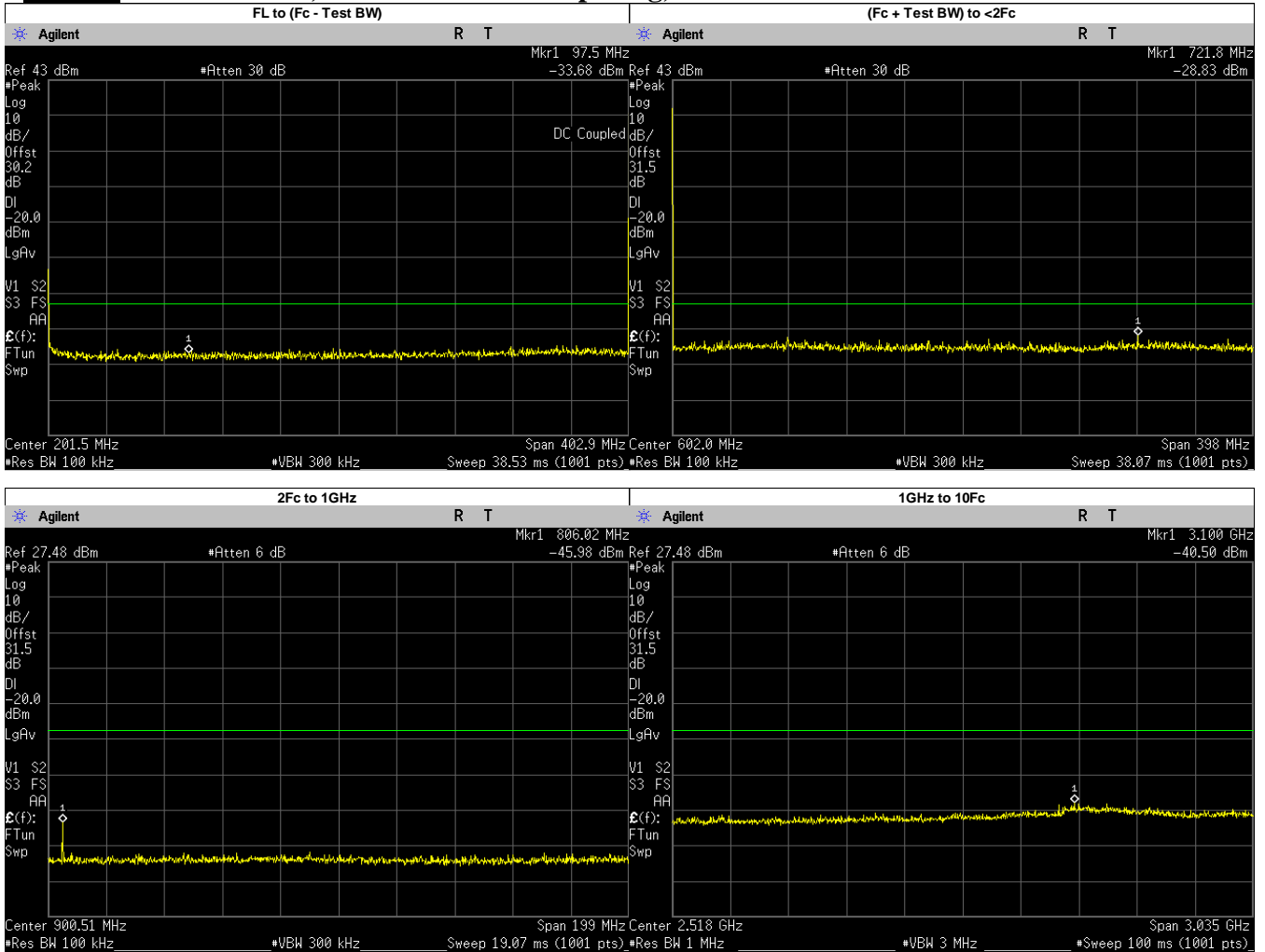

Frequency Range	Highest Spur Frequency (MHz)	Spurious Level (dBm)	Failing Limit (dBm)	Results
FL to (Fc - Test BW)	97.5000	-33.6810	-20.00	PASS
(Fc + Test BW) to <2Fc	721.8316	-28.8300	-20.00	PASS
2Fc to 1GHz 1GHz to 10Fc	806.0250	-45.9800	-20.00	PASS
	3100.3070	-40.5000	-20.00	PASS
	1209.0370	-46.1755	-20.00	PASS
	1612.0500	-45.8020	-20.00	PASS
	2015.0620	-44.5569	-20.00	PASS
	2418.0750	-45.0501	-20.00	PASS
	2821.0880	-43.5086	-20.00	PASS
	3224.1000	-42.4688	-20.00	PASS
	3627.1130	-44.0235	-20.00	PASS
4030.1250	-43.8614	-20.00	PASS	

Digital: 406.2 MHz, 12.5 kHz Channel Spacing, Max. Power

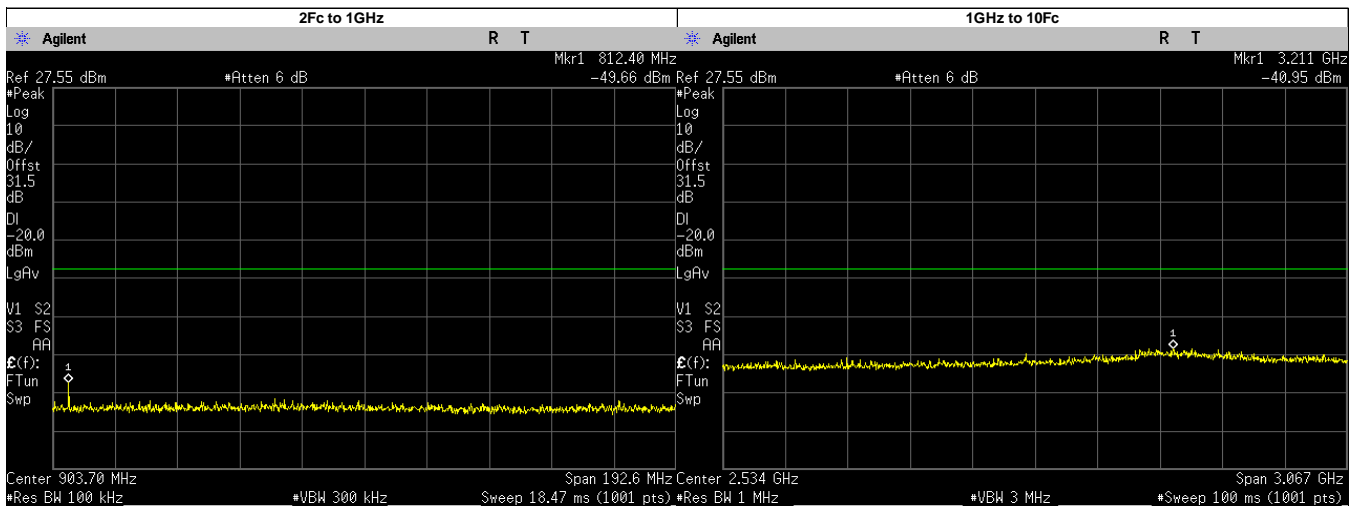
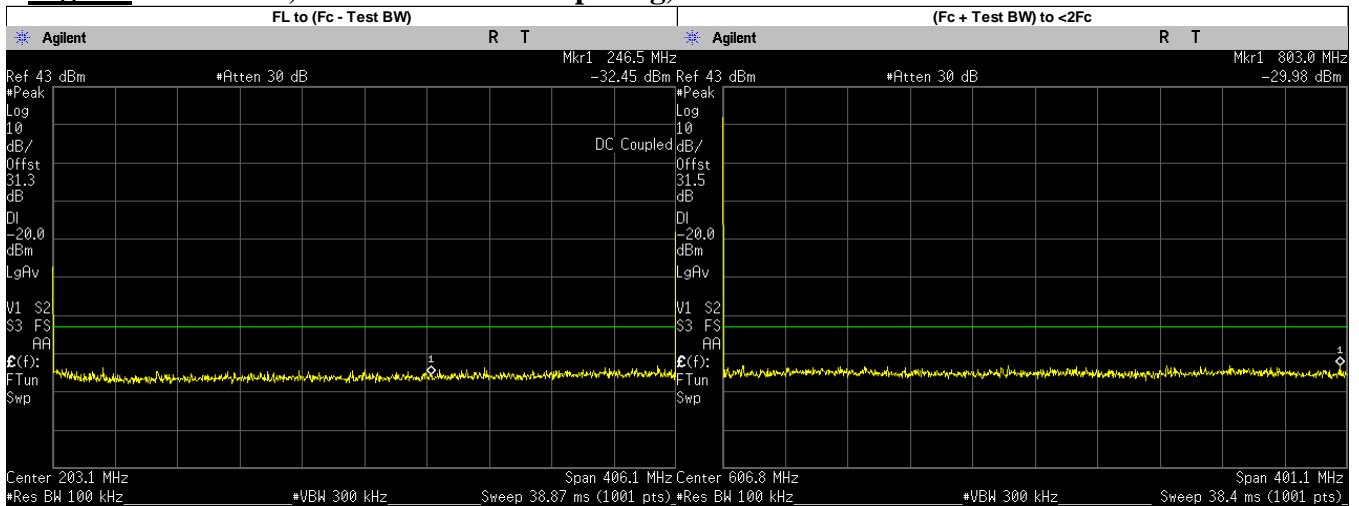

Frequency Range	Highest Spur Frequency (MHz)	Spurious Level (dBm)	Failing Limit (dBm)	Results
FL to (Fc - Test BW)	246.5000	-32.4470	-20.00	PASS
(Fc + Test BW) to <2Fc	802.9874	-29.9800	-20.00	PASS
2Fc to 1GHz 1GHz to 10Fc	812.4000	-49.6600	-20.00	PASS
	3211.3070	-40.9500	-20.00	PASS
	1218.6000	-45.0049	-20.00	PASS
	1624.8000	-45.4444	-20.00	PASS
	2031.0000	-45.6928	-20.00	PASS
	2437.2000	-44.9000	-20.00	PASS
	2843.4000	-44.0075	-20.00	PASS
	3249.6000	-42.4821	-20.00	PASS
	3655.8000	-43.7886	-20.00	PASS
4062.0000	-44.2973	-20.00	PASS	

Digital: 450.025 MHz, 12.5 kHz Channel Spacing, Max. Power

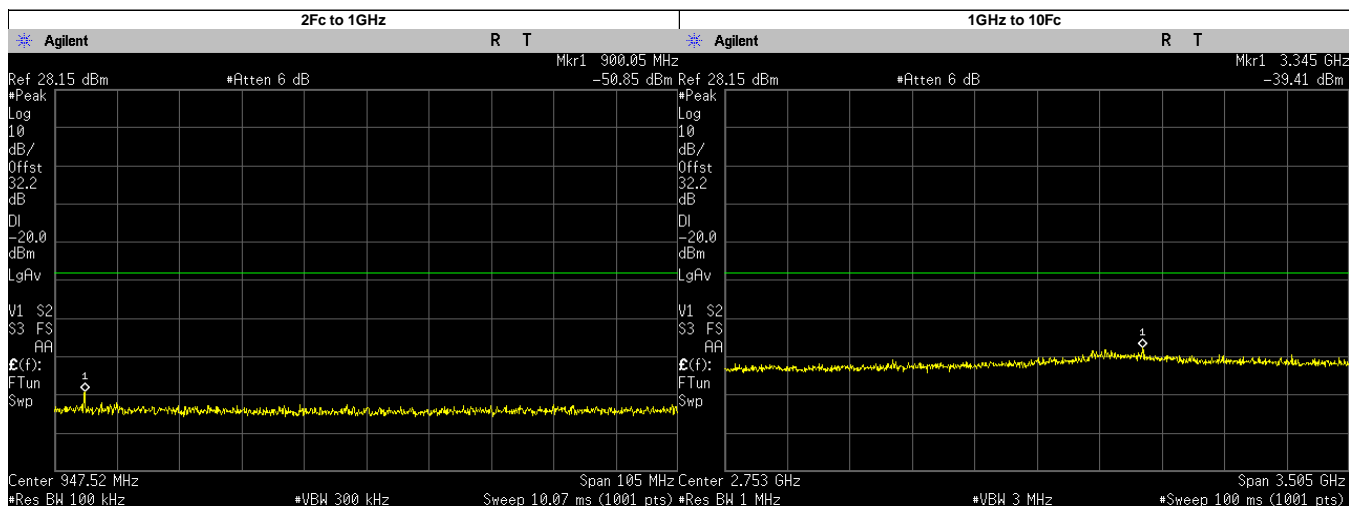
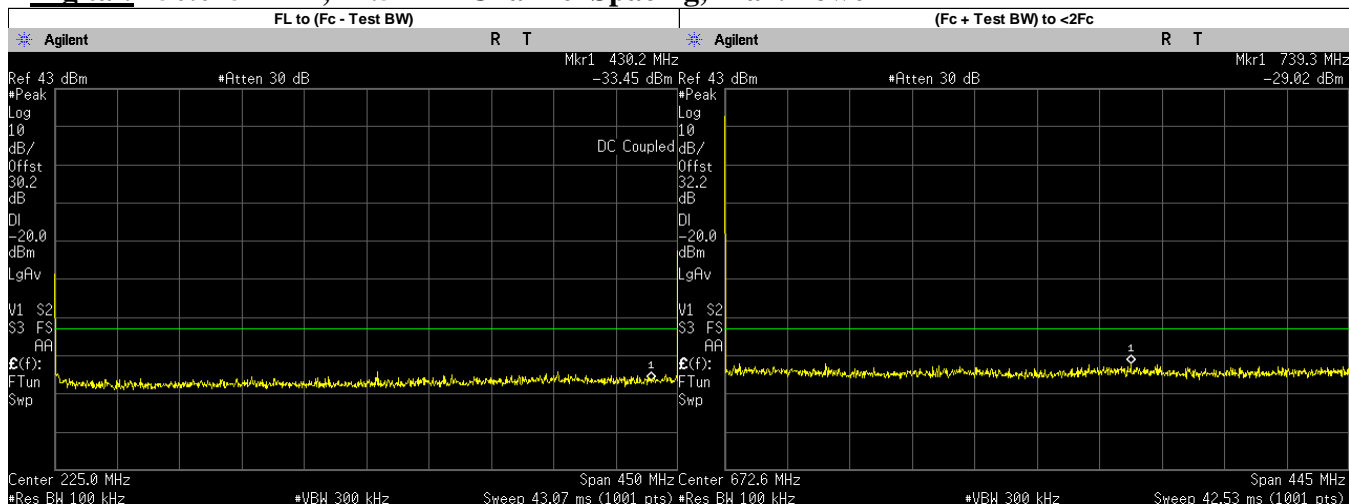

Frequency Range	Highest Spur Frequency (MHz)	Spurious Level (dBm)	Failing Limit (dBm)	Results
FL to (Fc - Test BW)	430.2000	-33.4510	-20.00	PASS
(Fc + Test BW) to <2Fc	739.3111	-29.0200	-20.00	PASS
2Fc to 1GHz 1GHz to 10Fc	900.0500	-50.8500	-20.00	PASS
	3345.0120	-39.4100	-20.00	PASS
	1350.0750	-45.3351	-20.00	PASS
	1800.1000	-44.5776	-20.00	PASS
	2250.1250	-44.5820	-20.00	PASS
	2700.1500	-44.1731	-20.00	PASS
	3150.1750	-40.9237	-20.00	PASS
	3600.2000	-43.4352	-20.00	PASS
4050.2250	-42.9365	-20.00	PASS	
4500.2500	-43.9733	-20.00	PASS	

Digital: 450.025 MHz, 12.5 kHz Channel Spacing, Low. Power

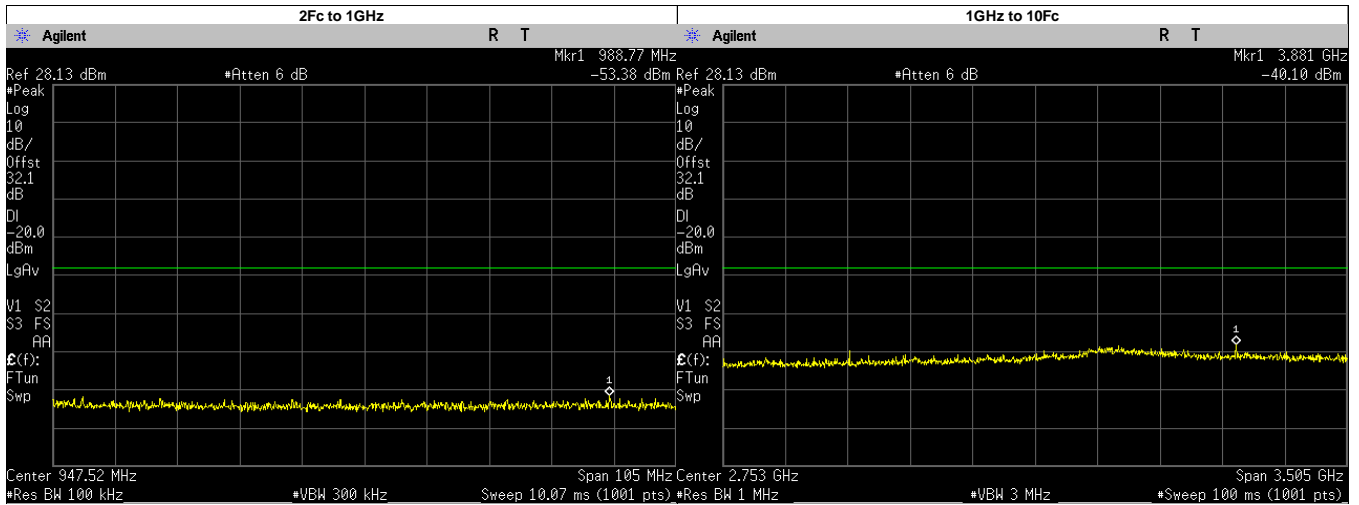
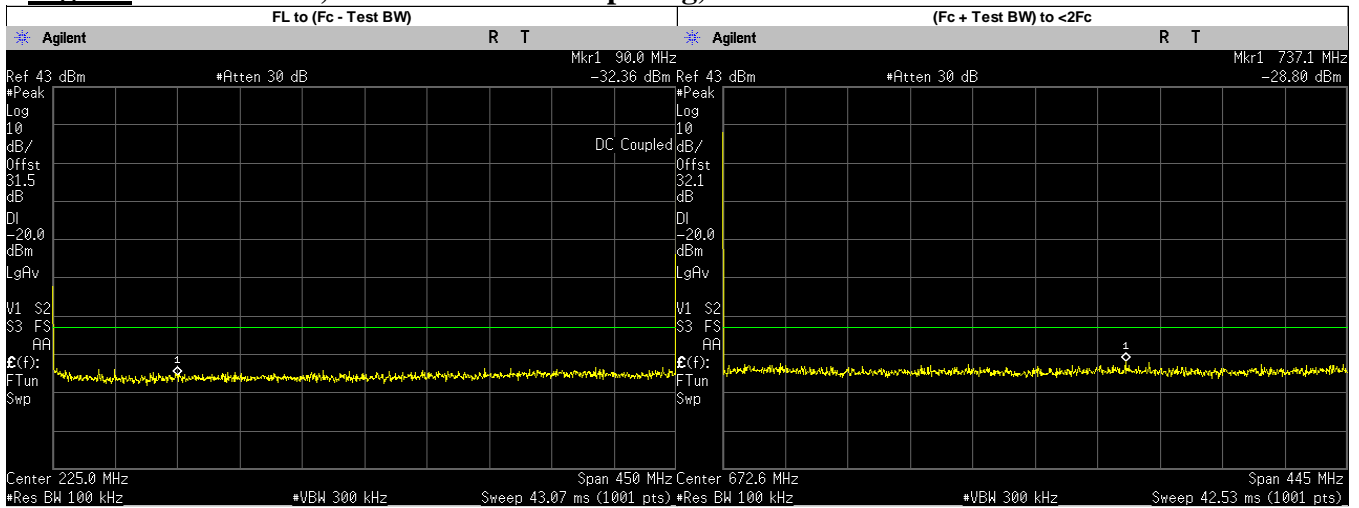

Frequency Range	Highest Spur Frequency (MHz)	Spurious Level (dBm)	Failing Limit (dBm)	Results
FL to (Fc - Test BW)	90.0000	-32.3560	-20.00	PASS
(Fc + Test BW) to <2Fc	737.0863	-28.8000	-20.00	PASS
2Fc to 1GHz	988.7704	-53.3800	-20.00	PASS
	900.0500	-53.9936	-20.00	PASS
1GHz to 10Fc	3881.3160	-40.1000	-20.00	PASS
	1350.0750	-45.2058	-20.00	PASS
	1800.1000	-44.6662	-20.00	PASS
	2250.1250	-44.5161	-20.00	PASS
	2700.1500	-43.5209	-20.00	PASS
	3150.1750	-41.8790	-20.00	PASS
	3600.2000	-43.1427	-20.00	PASS
	4050.2250	-43.3653	-20.00	PASS
	4500.2500	-43.6445	-20.00	PASS

Digital: 459.125 MHz, 12.5 kHz Channel Spacing, Max. Power

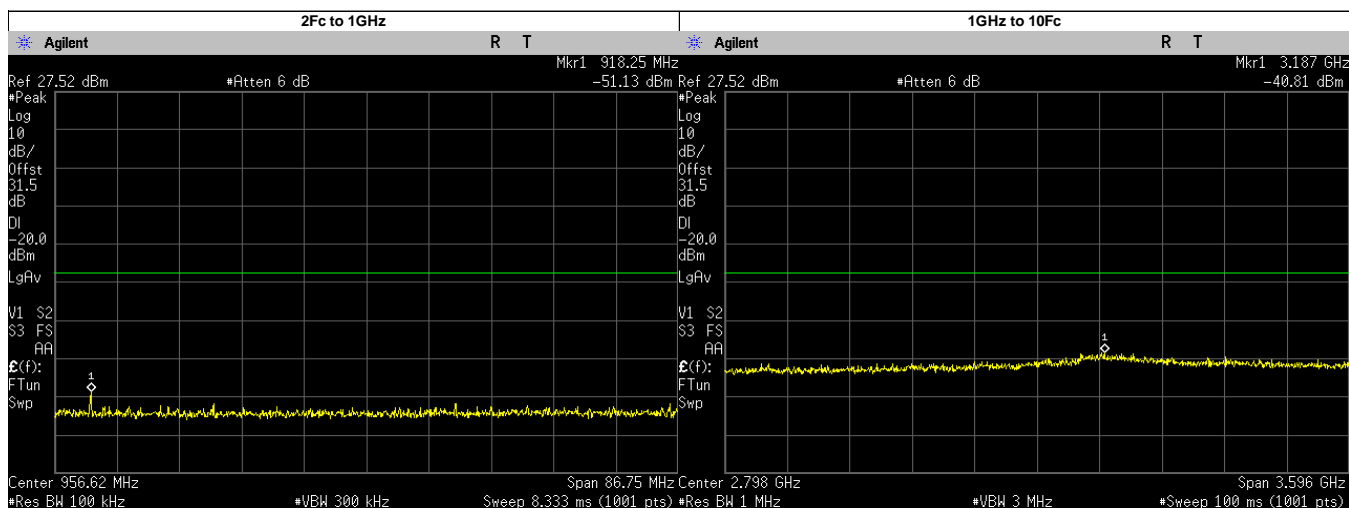
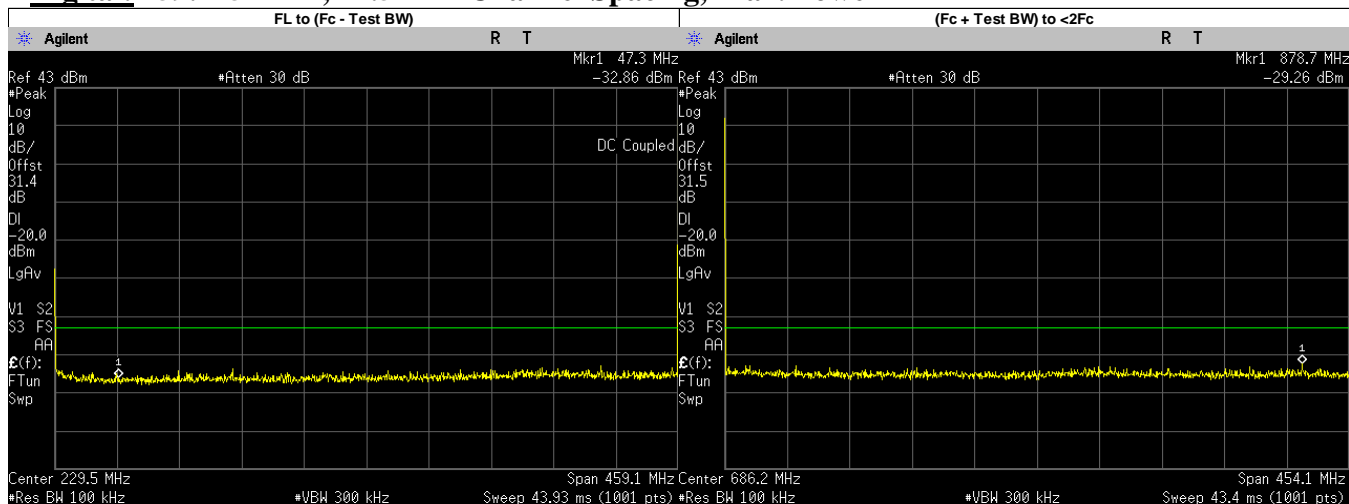

Frequency Range	Highest Spur Frequency (MHz)	Spurious Level (dBm)	Failing Limit (dBm)	Results
FL to (Fc - Test BW)	47.3000	-32.8640	-20.00	PASS
(Fc + Test BW) to <2Fc	878.7408	-29.2600	-20.00	PASS
2Fc to 1GHz 1GHz to 10Fc	918.1947	-52.7900	-20.00	PASS
	918.2500	-51.7348	-20.00	PASS
	3186.5200	-40.8100	-20.00	PASS
	1377.3750	-45.3264	-20.00	PASS
	1836.5000	-45.0540	-20.00	PASS
	2295.6250	-44.9319	-20.00	PASS
	2754.7500	-43.8306	-20.00	PASS
	3213.8750	-42.0832	-20.00	PASS
	3673.0000	-43.4253	-20.00	PASS
4132.1250	-43.7553	-20.00	PASS	
4591.2500	-43.7753	-20.00	PASS	

Digital: 467.775 MHz, 12.5 kHz Channel Spacing, Max. Power

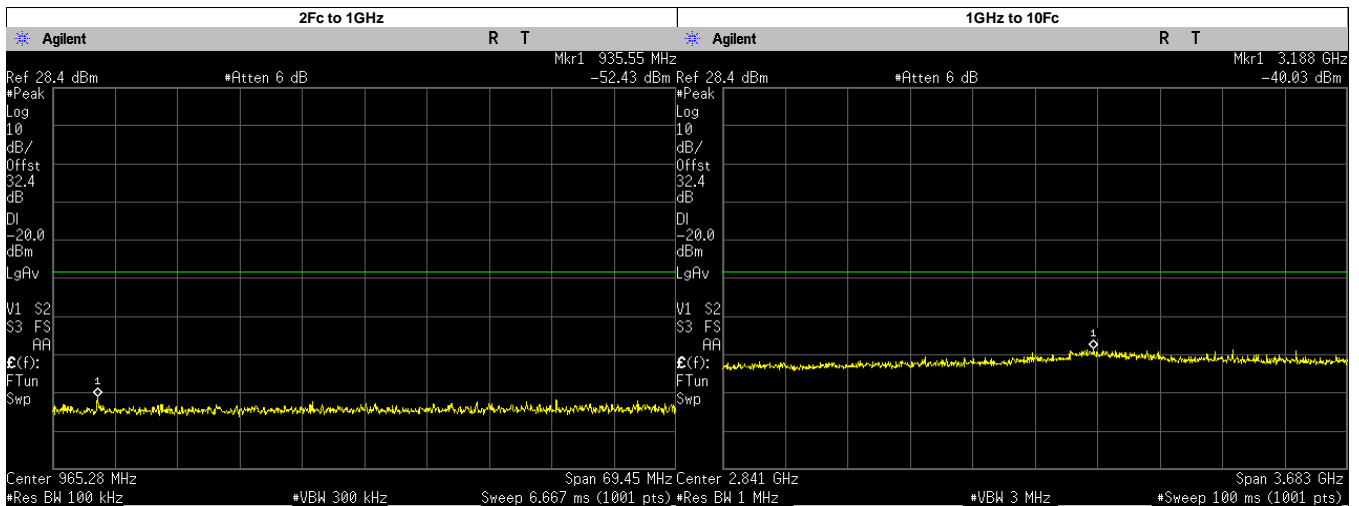
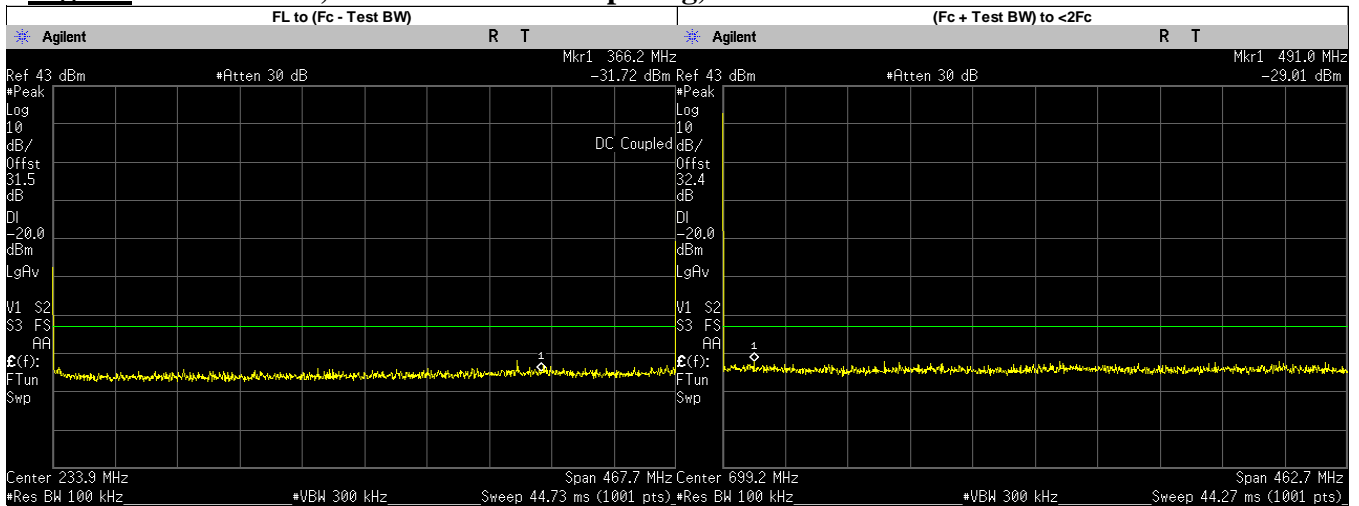

Frequency Range	Highest Spur Frequency (MHz)	Spurious Level (dBm)	Failing Limit (dBm)	Results
FL to (Fc - Test BW)	366.2000	-31.7170	-20.00	PASS
(Fc + Test BW) to <2Fc	490.9677	-29.0100	-20.00	PASS
2Fc to 1GHz 1GHz to 10Fc	935.5500	-52.4300	-20.00	PASS
	3187.5530	-40.0300	-20.00	PASS
	1403.3250	-44.3037	-20.00	PASS
	1871.1000	-44.2798	-20.00	PASS
	2338.8750	-43.8735	-20.00	PASS
	2806.6500	-42.9062	-20.00	PASS
	3274.4250	-41.6931	-20.00	PASS
	3742.2000	-43.0564	-20.00	PASS
	4209.9750	-42.6500	-20.00	PASS
	4677.7500	-43.8767	-20.00	PASS

Not for FCC Review
Digital: 469.9875 MHz, 12.5 kHz Channel Spacing, Max. Power

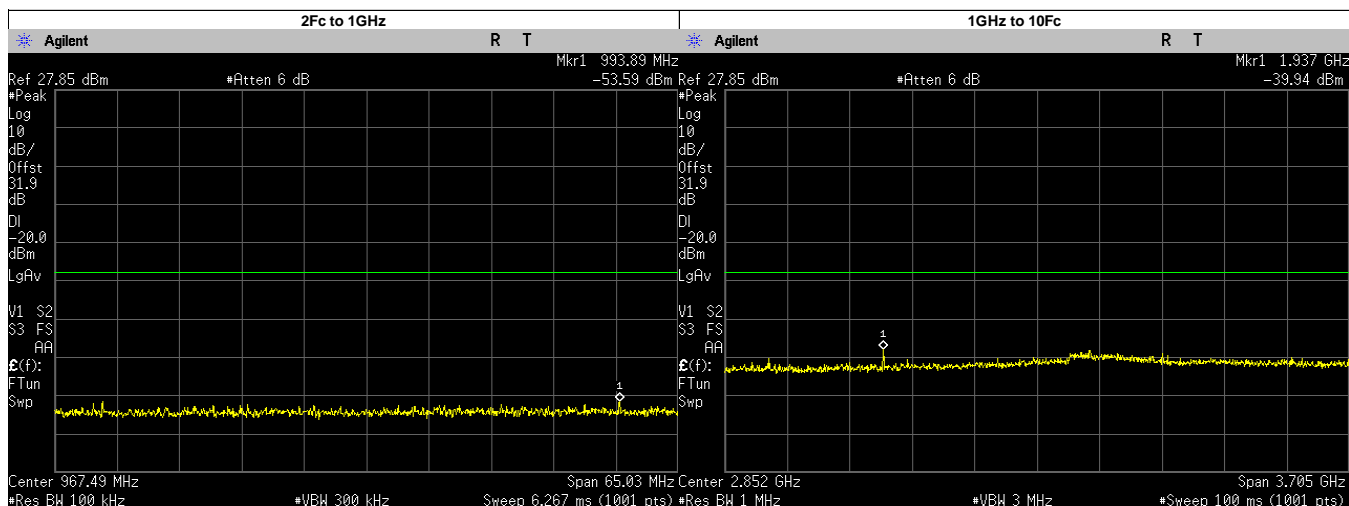
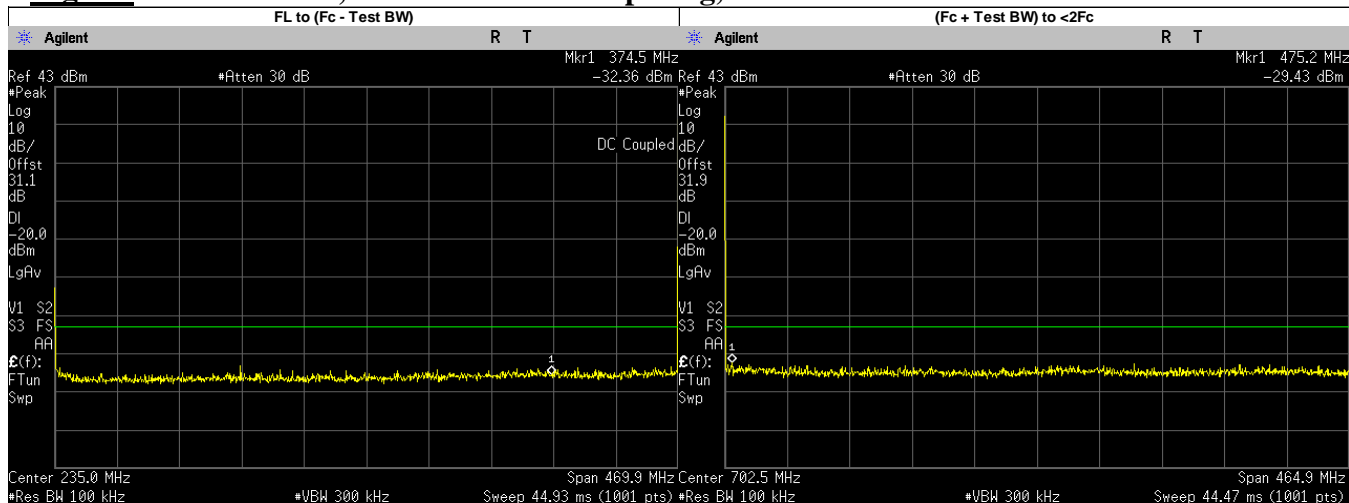

Frequency Range	Highest Spur Frequency (MHz)	Spurious Level (dBm)	Failing Limit (dBm)	Results
FL to (Fc - Test BW)	374.5000	-32.3580	-20.00	PASS
(Fc + Test BW) to <2Fc	475.1585	-29.4300	-20.00	PASS
2Fc to 1GHz	993.8877	-53.5900	-20.00	PASS
	939.9750	-53.6159	-20.00	PASS
1GHz to 10Fc	1937.3330	-39.9400	-20.00	PASS
	1409.9630	-45.7109	-20.00	PASS
	1879.9500	-44.5827	-20.00	PASS
	2349.9370	-44.8966	-20.00	PASS
	2819.9250	-43.1420	-20.00	PASS
	3289.9120	-41.3139	-20.00	PASS
	3759.9000	-44.0658	-20.00	PASS
	4229.8870	-42.9978	-20.00	PASS
	4699.8750	-43.6865	-20.00	PASS

6.9.4. Test Limit

Table below summarized the power of any emission outside a licensee's frequency block shall be attenuated below the transmitter power (P) by at least

Channel Spacing	Part 22	Part 24D	Part 74	Part 80	Part 90 (UHF, VHF, 800, 900)	Part 90 (700)
12.5kHz	43 + log ₁₀ (P) (-13 dBm)	43 + log ₁₀ (P) (-13 dBm)	43 + log ₁₀ (P) (-13 dBm)	Not Applicable	50 + log ₁₀ (P) (-20 dBm)	43 + log ₁₀ (P) (-13 dBm)
25kHz		Not Applicable		43 + log ₁₀ (P) (-13 dBm)	43 + log ₁₀ (P) (-13 dBm)	43 + log ₁₀ (P) (-13 dBm)

Channel Spacing	RSS 134	RSS 182	RSS 119 (UHF, VHF, 800, 900)	RSS 119 (700)
12.5kHz	43 + log ₁₀ (P) (-13 dBm)	Not Applicable	50 + log ₁₀ (P) (-20 dBm)	43 + log ₁₀ (P) (-13 dBm)
25kHz	Not Applicable	43 + log ₁₀ (P) (-13 dBm)	43 + log ₁₀ (P) (-13 dBm)	43 + log ₁₀ (P) (-13 dBm)

6.10. Radiated Spurious Emission

6.10.1. Test Setup

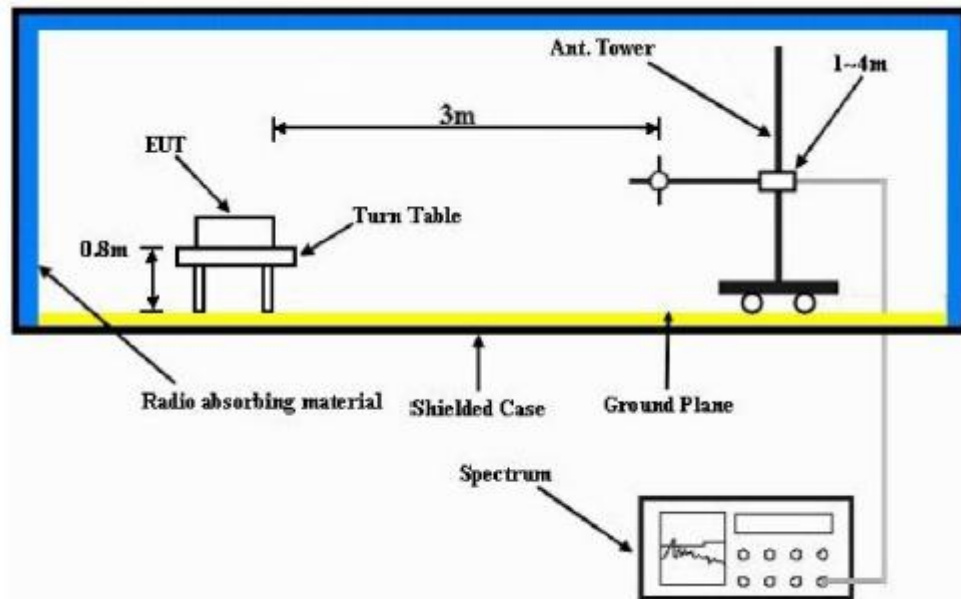

- 1) The Resolution Bandwidth for scanning Radiated Emission below 1 GHz is 100 kHz with Video Bandwidth = 300 kHz and Resolution Bandwidth for above 1 GHz is 1 MHz with Video Bandwidth = 3 MHz. Detector mode is positive peak.
- 2) In the semi- anechoic chamber, setup as illustrated above the DUT placed on the 0.8m height (for $F_c < 1\text{GHz}$) or 1.5m height (for $F_c > 1\text{GHz}$) of Turn Table, rotated the table around 360 degrees to search the maximum radiation power and receiver antenna shall be rotated vertical and horizontal polarization and moved height from 1m to 4m to find the maximum polar radiated power. The “Read Value” is the spectrum reading the maximum power value.
- 3) The substitution antenna is substituted for DUT at the same position and signals generator (S.G) export the CW signal to the substitution antenna via a TX cable. The receiver antenna shall be rotated vertical and horizontal polarization and moved height from 1m to 4m to find the maximum radiation power. Record the power level of maximum radiation power from spectrum. So, the measured substitution value = Ref level of S.G + TX cables loss – Substituted Antenna Gain.
- 4) Final Radiated Spurious Emission = “Read Value” + Measured substitution value.

6.10.2. Test Result (Analog)

SAC Transmitter Radiated Emission:

Model Number: AAH88QCP9JA2AN

S/N: 546TZP0405

SR:40789-EMC-00011

Battery Part No: PMNN4468B

Accy Part No: NA

Test Mode: TX Analog
 25 kHz

403.012500 MHz

2.400 Watt(s) /Max Power

Frequency (MHz)	Limit	Horizontal Measured Emission Equiv Pwr Into Ideal Dipole (dBm)	Vertical Measured Emission Equiv Pwr Into ideal Dipole (dBm)
806.0250	-13.0000	-77.4888 **	-77.4888 **
1209.0375	-13.0000	-60.7260 **	-60.2474 **
1612.0500	-13.0000	-57.7137 **	-58.4510 **
2015.0625	-13.0000	-55.6941 **	-55.5838 **
2418.0750	-13.0000	-54.3491 **	-54.9340 **
2821.0875	-13.0000	-54.2299 **	-53.3932 **
3224.1000	-13.0000	-50.4528 **	-51.3855 **
3627.1125	-13.0000	-51.7921 **	-52.1548 **
4030.1250	-13.0000	-49.7473 **	-49.9706 **

RADIATED SPURIOUS EMISSIONS

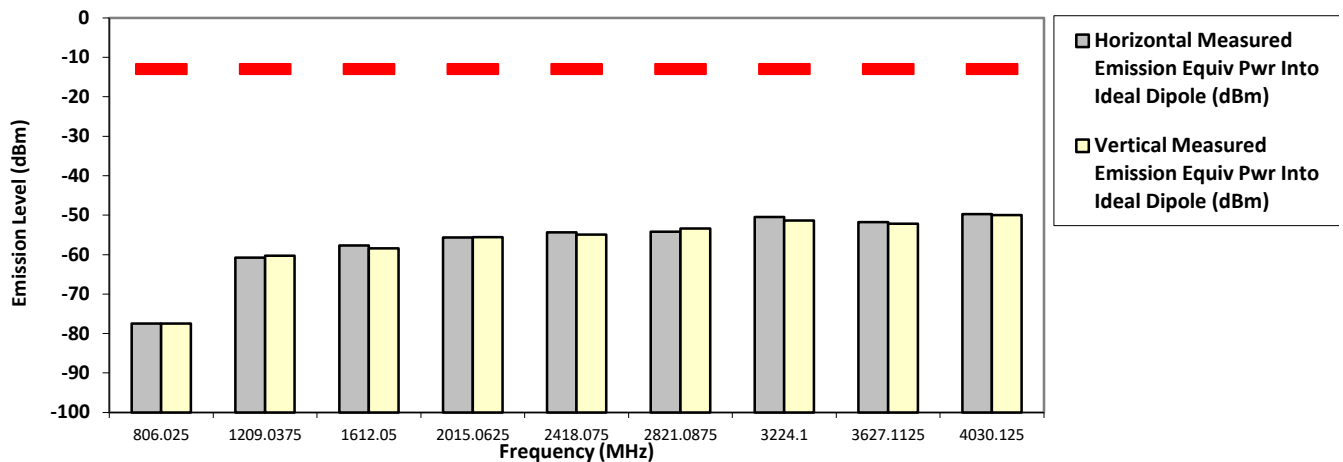

The data presented here was taken using the substitution method as found in the ANSI C63.26-2015 document.
 Motorola Penang EMC Lab - Test Performed by : Aiman Sun, 6 Aug, 2023

Remarks: ** Indicates the spurious emission could not be detected due to noise limitations or ambient.

*Pursuant to CFR 47 Part 2.1057 (c), emissions attenuated more than 20 dB below the permissible limit are not reported
 Temp(Deg): 21.3 Hum(%RH): 59.3

Remarks: Passed Results Marginal Results Failed Results

SAC Transmitter Radiated Emission:

Model Number: AAH88QCP9JA2AN **S/N: 546TZP0405** **SR:40789-EMC-00011**
Battery Part No: PMNN4468B **Accy Part No: NA**
406.20000 MHz **Test Mode: TX Analog** **2.400 Watt(s) /Max Power**
25 kHz

Frequency (MHz)	Limit	Horizontal Measured Emission Equip Pwr Into Ideal Dipole (dBm)	Vertical Measured Emission Equip Pwr Into ideal Dipole (dBm)
812.4000	-13.0000	-76.7704 **	-77.0345 **
1218.6000	-13.0000	-60.5627 **	-61.4820 **
1624.8000	-13.0000	-58.3693 **	-58.0431 **
2031.0000	-13.0000	-55.6001 **	-54.8305 **
2437.2000	-13.0000	-54.6820 **	-54.5967 **
2843.4000	-13.0000	-53.8827 **	-53.4390 **
3249.6000	-13.0000	-51.7341 **	-51.0759 **
3655.8000	-13.0000	-50.7514 **	-51.3825 **
4062.0000	-13.0000	-49.2956 **	-50.4558 **

RADIATED SPURIOUS EMISSIONS

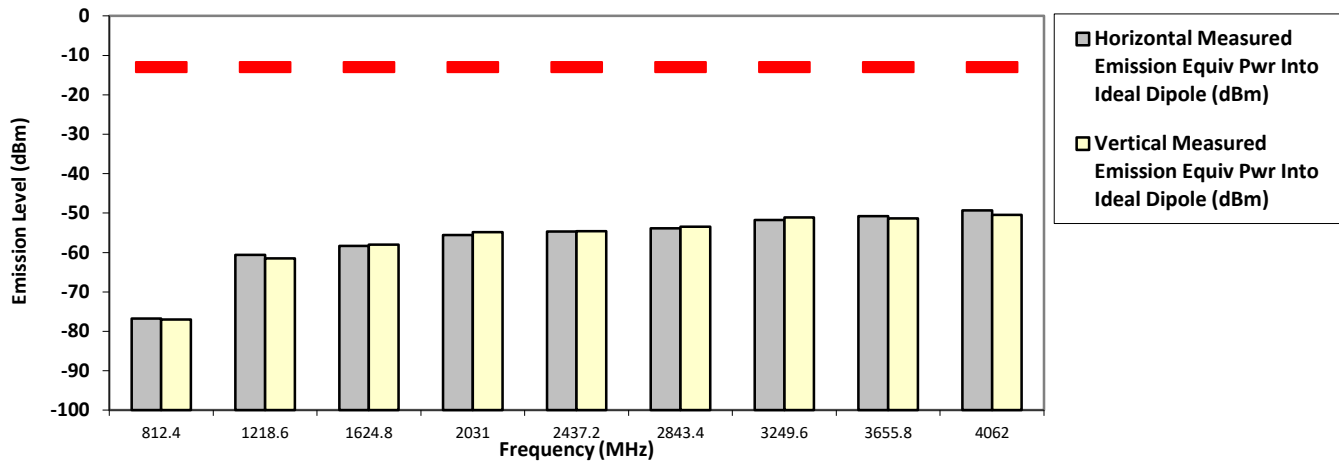

The data presented here was taken using the substitution method as found in the ANSI C63.26-2015 document.
 Motorola Penang EMC Lab - Test Performed by : Aiman Sun, 6 Aug, 2023

Remarks: ** Indicates the spurious emission could not be detected due to noise limitations or ambient.
 *Pursuant to CFR 47 Part 2.1057 (c), emissions attenuated more than 20 dB below the permissible limit are not reported
 Temp(Deg): 21.3 Hum(%RH): 59.3

Remarks: Passed Results Marginal Results Failed Results

SAC Transmitter Radiated Emission:

Model Number: AAH88QCP9JA2AN **S/N: 546TZP0405** **SR:40789-EMC-00011**
Battery Part No: PMNN4468B **Accy Part No: NA**
450.025000 MHz **Test Mode: TX Analog** **25 kHz** **1.000 Watt(s) /Low Power**

Frequency (MHz)	Limit	Horizontal Measured Emission Equip Pwr Into Ideal Dipole (dBm)	Vertical Measured Emission Equip Pwr Into ideal Dipole (dBm)
900.0500	-13.0000	-74.9857 **	-75.8775 **
1350.0750	-13.0000	-60.4794 **	-59.8243 **
1800.1000	-13.0000	-58.4067 **	-57.0170 **
2250.1250	-13.0000	-55.8415 **	-55.1840 **
2700.1500	-13.0000	-54.4649 **	-52.5843 **
3150.1750	-13.0000	-49.7990 **	-51.7928 **
3600.2000	-13.0000	-51.7030 **	-50.4216 **
4050.2250	-13.0000	-50.3093 **	-49.9056 **
4500.2500	-13.0000	-49.1014 **	-49.4604 **

RADIATED SPURIOUS EMISSIONS

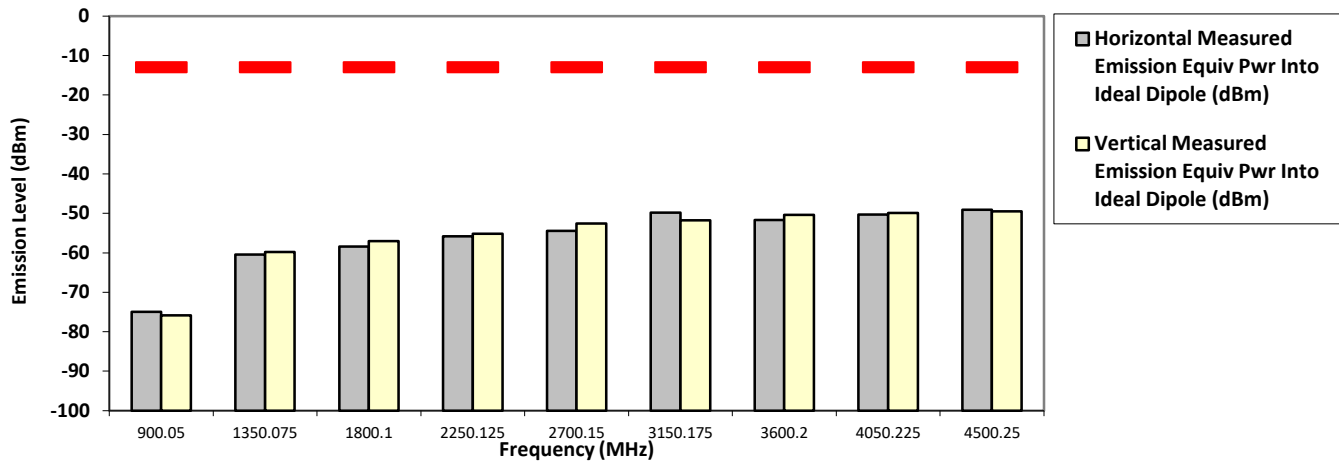

The data presented here was taken using the substitution method as found in the ANSI C63.26-2015 document.
 Motorola Penang EMC Lab - Test Performed by : Aiman Sun, 6 Aug, 2023

Remarks: ** Indicates the spurious emission could not be detected due to noise limitations or ambient.
 *Pursuant to CFR 47 Part 2.1057 (c), emissions attenuated more than 20 dB below the permissible limit are not reported
 Temp(Deg): 21.3 Hum(%RH): 59.3

Remarks: Passed Results Marginal Results Failed Results

SAC Transmitter Radiated Emission:

Model Number: AAH88QCP9JA2AN **S/N: 546TZP0405** **SR:40789-EMC-00011**
Battery Part No: PMNN4468B **Accy Part No: NA**
Test Mode: TX Analog
450.025000 MHz **25 kHz** **2.400 Watt(s) /Max Power**

Frequency (MHz)	Limit	Horizontal Measured Emission Equip Pwr Into Ideal Dipole (dBm)	Vertical Measured Emission Equip Pwr Into ideal Dipole (dBm)
900.0500	-13.0000	-75.3258 **	-76.5394 **
1350.0750	-13.0000	-60.2299 **	-59.8021 **
1800.1000	-13.0000	-57.8159 **	-57.5326 **
2250.1250	-13.0000	-55.7430 **	-55.9320 **
2700.1500	-13.0000	-53.5576 **	-54.0086 **
3150.1750	-13.0000	-51.1100 **	-51.7087 **
3600.2000	-13.0000	-51.5057 **	-51.7646 **
4050.2250	-13.0000	-50.5841 **	-48.3937 **
4500.2500	-13.0000	-48.6795 **	-48.4064 **

RADIATED SPURIOUS EMISSIONS

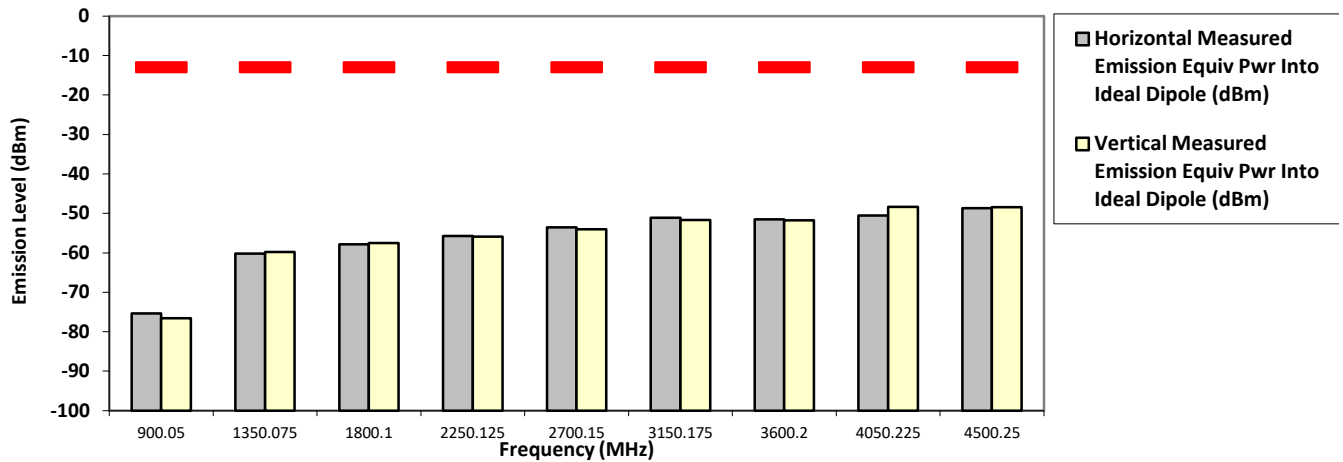

The data presented here was taken using the substitution method as found in the ANSI C63.26-2015 document.
 Motorola Penang EMC Lab - Test Performed by : Aiman Sun, 6 Aug, 2023

Remarks: ** Indicates the spurious emission could not be detected due to noise limitations or ambient.
 *Pursuant to CFR 47 Part 2.1057 (c), emissions attenuated more than 20 dB below the permissible limit are not reported
 Temp(Deg): 21.3 Hum(%RH): 59.3

Remarks: Passed Results Marginal Results Failed Results

SAC Transmitter Radiated Emission:

Model Number: AAH88QCP9JA2AN **S/N: 546TZP0405** **SR:40789-EMC-00011**
Battery Part No: PMNN4468B **Accy Part No: NA**
459.125000 MHz **Test Mode: TX Analog** **2.400 Watt(s) /Max Power**
25 kHz

Frequency (MHz)	Limit	Horizontal Measured Emission Equip Pwr Into Ideal Dipole (dBm)	Vertical Measured Emission Equip Pwr Into ideal Dipole (dBm)
918.2500	-13.0000	-77.0043 **	-75.9684 **
1377.3750	-13.0000	-61.3522 **	-60.7677 **
1836.5000	-13.0000	-56.9375 **	-57.9561 **
2295.6250	-13.0000	-54.2912 **	-54.4954 **
2754.7500	-13.0000	-53.9710 **	-53.7850 **
3213.8750	-13.0000	-51.1354 **	-51.2555 **
3673.0000	-13.0000	-51.8570 **	-50.9959 **
4132.1250	-13.0000	-48.5562 **	-49.7007 **
4591.2500	-13.0000	-48.7451 **	-48.0128 **

RADIATED SPURIOUS EMISSIONS

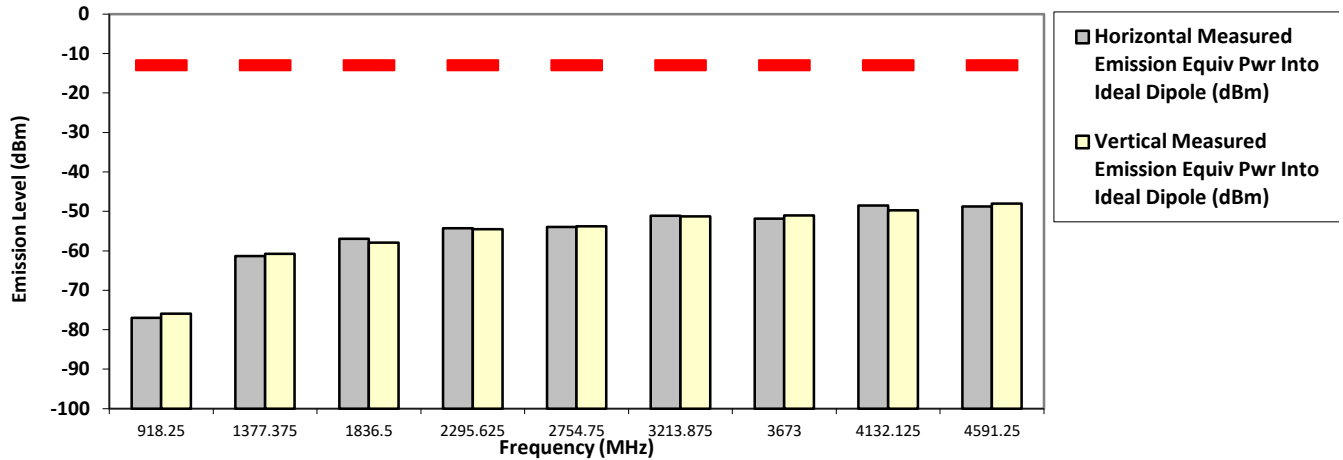

The data presented here was taken using the substitution method as found in the ANSI C63.26-2015 document.
 Motorola Penang EMC Lab - Test Performed by : Aiman Sun, 6 Aug, 2023

Remarks: ** Indicates the spurious emission could not be detected due to noise limitations or ambient.
 *Pursuant to CFR 47 Part 2.1057 (c), emissions attenuated more than 20 dB below the permissible limit are not reported
 Temp(Deg): 21.3 Hum(%RH): 59.3

Remarks: Passed Results Marginal Results Failed Results

SAC Transmitter Radiated Emission:

Model Number: AAH88QCP9JA2AN **S/N: 546TZP0405** **SR:40789-EMC-00011**
Battery Part No: PMNN4468B **Accy Part No: NA**
467.775000 MHz **Test Mode: TX Analog** **25 kHz** **1.000 Watt(s) /Low Power**

Frequency (MHz)	Limit	Horizontal Measured Emission Equip Pwr Into Ideal Dipole (dBm)	Vertical Measured Emission Equip Pwr Into ideal Dipole (dBm)
935.5500	-13.0000	-75.7239 **	-75.2309 **
1403.3250	-13.0000	-59.7977 **	-60.0031 **
1871.1000	-13.0000	-57.6328 **	-58.0816 **
2338.8750	-13.0000	-55.1782 **	-55.2130 **
2806.6500	-13.0000	-54.2916 **	-54.2018 **
3274.4250	-13.0000	-50.1558 **	-50.6553 **
3742.2000	-13.0000	-50.6207 **	-50.8359 **
4209.9750	-13.0000	-49.8831 **	-49.7265 **
4677.7500	-13.0000	-47.6322 **	-48.3516 **

RADIATED SPURIOUS EMISSIONS

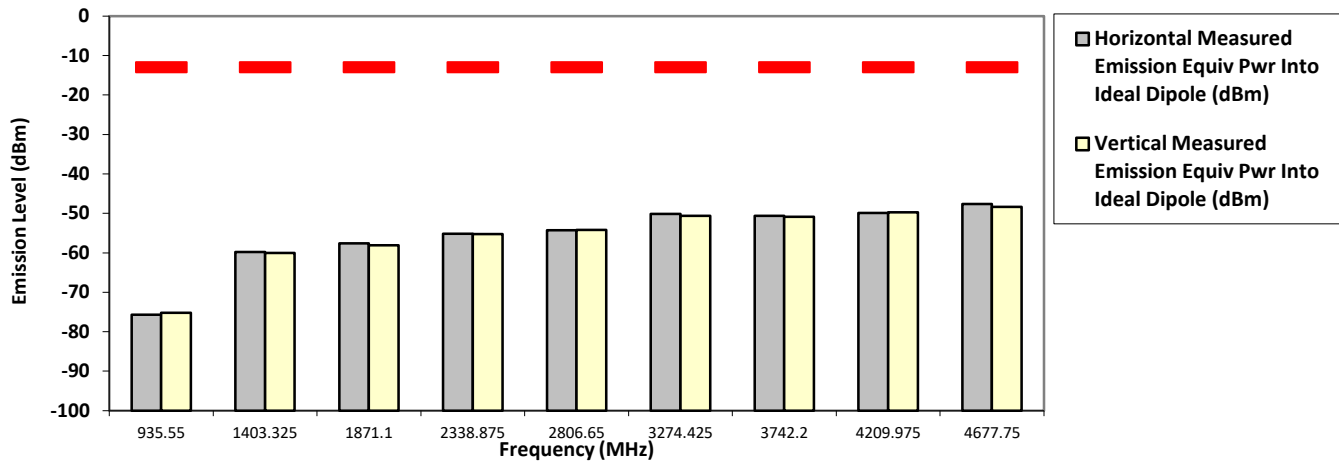

The data presented here was taken using the substitution method as found in the ANSI C63.26-2015 document.
 Motorola Penang EMC Lab - Test Performed by : Aiman Sun, 6 Aug, 2023

Remarks: ** Indicates the spurious emission could not be detected due to noise limitations or ambient.
 *Pursuant to CFR 47 Part 2.1057 (c), emissions attenuated more than 20 dB below the permissible limit are not reported
 Temp(Deg): 21.3 Hum(%RH): 59.3

Remarks: Passed Results Marginal Results Failed Results

SAC Transmitter Radiated Emission:

Model Number: AAH88QCP9JA2AN **S/N: 546TZP0405** **SR:40789-EMC-00011**
Battery Part No: PMNN4468B **Accy Part No: NA**
467.775000 MHz **Test Mode: TX Analog** **2.400 Watt(s) /Max Power**
25 kHz

Frequency (MHz)	Limit	Horizontal Measured Emission Equip Pwr Into Ideal Dipole (dBm)	Vertical Measured Emission Equip Pwr Into ideal Dipole (dBm)
935.5500	-13.0000	-74.5788 **	-75.3916 **
1403.3250	-13.0000	-58.7226 **	-59.9797 **
1871.1000	-13.0000	-57.0765 **	-57.6022 **
2338.8750	-13.0000	-55.4393 **	-53.2531 **
2806.6500	-13.0000	-54.2815 **	-53.3980 **
3274.4250	-13.0000	-51.1275 **	-50.1341 **
3742.2000	-13.0000	-51.0973 **	-51.2146 **
4209.9750	-13.0000	-49.0874 **	-49.7851 **
4677.7500	-13.0000	-47.5109 **	-48.5176 **

RADIATED SPURIOUS EMISSIONS

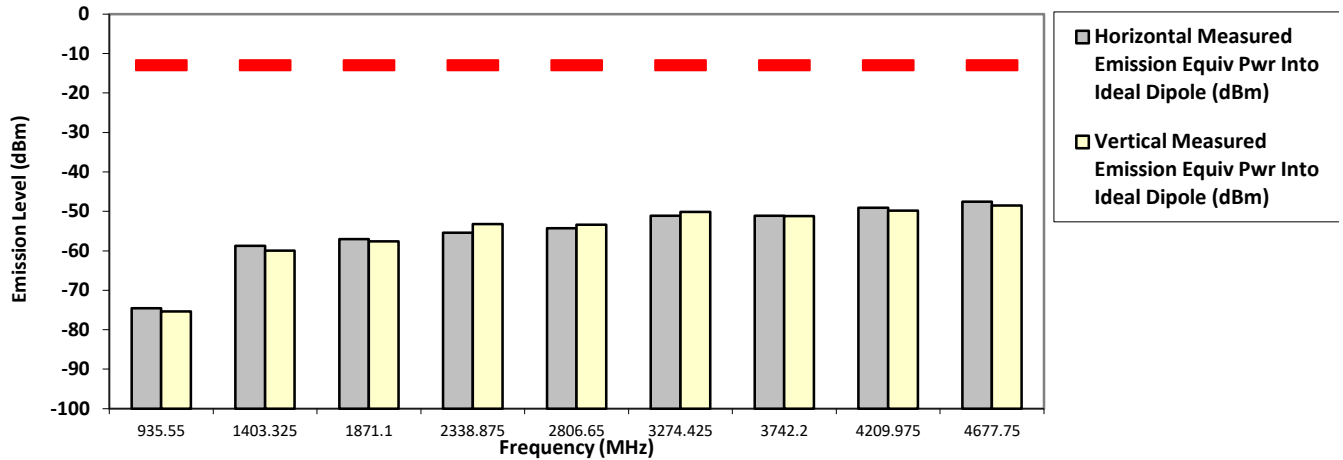

The data presented here was taken using the substitution method as found in the ANSI C63.26-2015 document.
 Motorola Penang EMC Lab - Test Performed by : Aiman Sun, 6 Aug, 2023

Remarks: ** Indicates the spurious emission could not be detected due to noise limitations or ambient.
 *Pursuant to CFR 47 Part 2.1057 (c), emissions attenuated more than 20 dB below the permissible limit are not reported
 Temp(Deg): 21.3 Hum(%RH): 59.3

Remarks: Passed Results Marginal Results Failed Results

SAC Transmitter Radiated Emission:

Model Number: AAH88QCP9JA2AN **S/N: 546TZP0405** **SR:40789-EMC-00011**
Battery Part No: PMNN4468B **Accy Part No: NA**
469.987500 MHz **Test Mode: TX Analog** **2.400 Watt(s) /Max Power**
25 kHz

Frequency (MHz)	Limit	Horizontal Measured Emission Equip Pwr Into Ideal Dipole (dBm)	Vertical Measured Emission Equip Pwr Into ideal Dipole (dBm)
939.9750	-13.0000	-75.0892 **	-75.5565 **
1409.9625	-13.0000	-59.2592 **	-58.8918 **
1879.9500	-13.0000	-57.2528 **	-57.0240 **
2349.9375	-13.0000	-55.0784 **	-54.3636 **
2819.9250	-13.0000	-53.8861 **	-52.6989 **
3289.9125	-13.0000	-52.1566 **	-50.4525 **
3759.9000	-13.0000	-50.9606 **	-51.7156 **
4229.8875	-13.0000	-48.8288 **	-48.6779 **
4699.8750	-13.0000	-47.0578 **	-48.0389 **

RADIATED SPURIOUS EMISSIONS

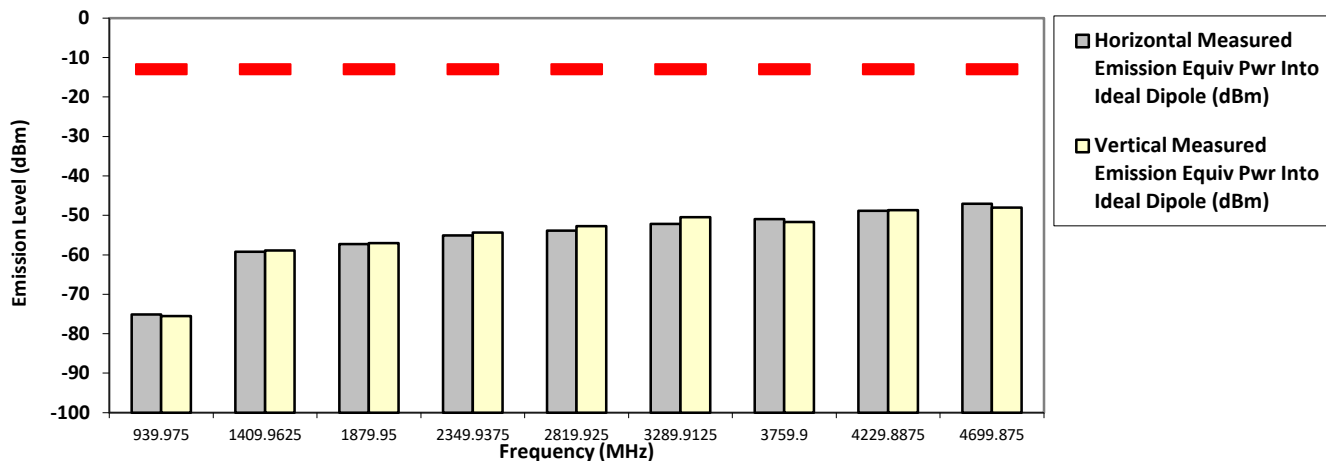

The data presented here was taken using the substitution method as found in the ANSI C63.26-2015 document.
 Motorola Penang EMC Lab - Test Performed by : Aiman Sun, 6 Aug, 2023

Remarks: ** Indicates the spurious emission could not be detected due to noise limitations or ambient.
 *Pursuant to CFR 47 Part 2.1057 (c), emissions attenuated more than 20 dB below the permissible limit are not reported
 Temp(Deg): 21.3 Hum(%RH): 59.3

Remarks: Passed Results Marginal Results Failed Results

6.10.3. Test Result (Digital)

SAC Transmitter Radiated Emission:

Model Number: AAH88QCP9JA2AN S/N: 546TZP0405 SR:40789-EMC-00011
 Battery Part No: PMNN4468B Accy Part No: NA
 Test Mode: TX Digital
 403.012500 MHz 12.5 kHz 3.300 Watt(s) /Max Power

Frequency (MHz)	Limit	Horizontal Measured Emission Equip Pwr Into Ideal Dipole (dBm)	Vertical Measured Emission Equip Pwr Into ideal Dipole (dBm)
806.0250	-20.0000	-77.1313 **	-77.5738 **
1209.0375	-20.0000	-60.7896 **	-60.5424 **
1612.0500	-20.0000	-59.1378 **	-58.1686 **
2015.0625	-20.0000	-54.1864 **	-55.6873 **
2418.0750	-20.0000	-54.2378 **	-53.5408 **
2821.0875	-20.0000	-53.9454 **	-53.5947 **
3224.1000	-20.0000	-50.9550 **	-50.4864 **
3627.1125	-20.0000	-51.4249 **	-51.2978 **
4030.1250	-20.0000	-49.4688 **	-49.5486 **

RADIATED SPURIOUS EMISSIONS

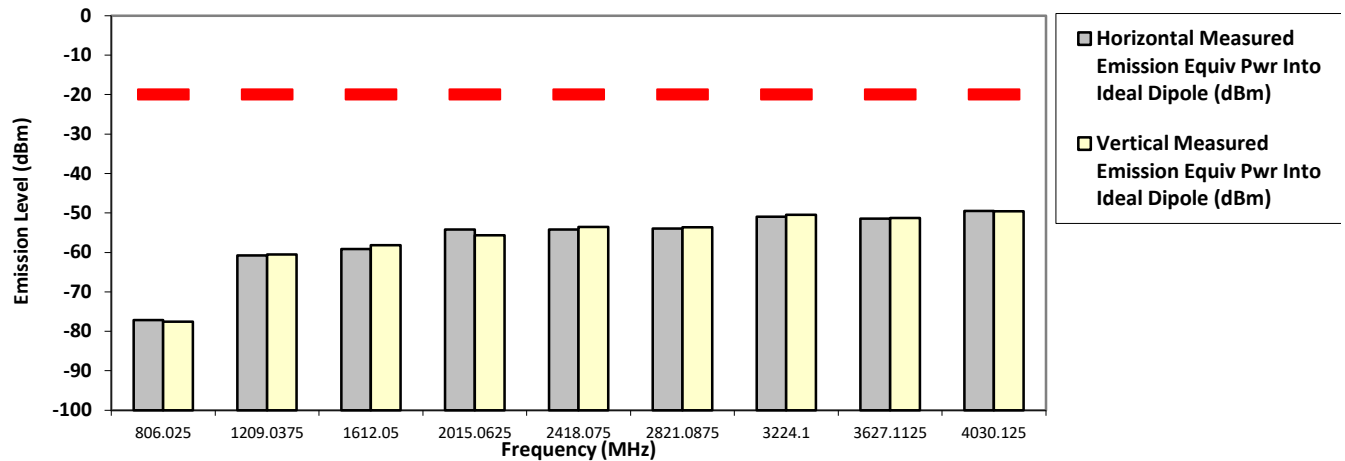

The data presented here was taken using the substitution method as found in the ANSI C63.26-2015 document.
 Motorola Penang EMC Lab - Test Performed by : Aiman Sun, 6 Aug, 2023

Remarks: ** Indicates the spurious emission could not be detected due to noise limitations or ambient.
 *Pursuant to CFR 47 Part 2.1057 (c), emissions attenuated more than 20 dB below the permissible limit are not reported
 Temp(Deg): 23.1 Hum(%RH): 54.3

Remarks: Passed Results Marginal Results Failed Results

SAC Transmitter Radiated Emission:

Model Number: AAH88QCP9JA2AN **S/N: 546TZP0405** **SR:40789-EMC-00011**
Battery Part No: PMNN4468B **Accy Part No: NA**
406.20000 MHz **Test Mode: TX Digital** **12.5 kHz** **3.300 Watt(s) /Max Power**

Frequency (MHz)	Limit	Horizontal Measured Emission Equip Pwr Into Ideal Dipole (dBm)	Vertical Measured Emission Equip Pwr Into ideal Dipole (dBm)
812.4000	-20.0000	-76.6957 **	-77.7083 **
1218.6000	-20.0000	-61.7980 **	-60.2707 **
1624.8000	-20.0000	-59.2678 **	-59.1595 **
2031.0000	-20.0000	-55.5351 **	-55.4484 **
2437.2000	-20.0000	-53.6005 **	-54.2225 **
2843.4000	-20.0000	-53.3708 **	-53.5434 **
3249.6000	-20.0000	-50.2183 **	-51.6186 **
3655.8000	-20.0000	-51.2185 **	-51.1948 **
4062.0000	-20.0000	-50.1919 **	-50.0419 **

RADIATED SPURIOUS EMISSIONS

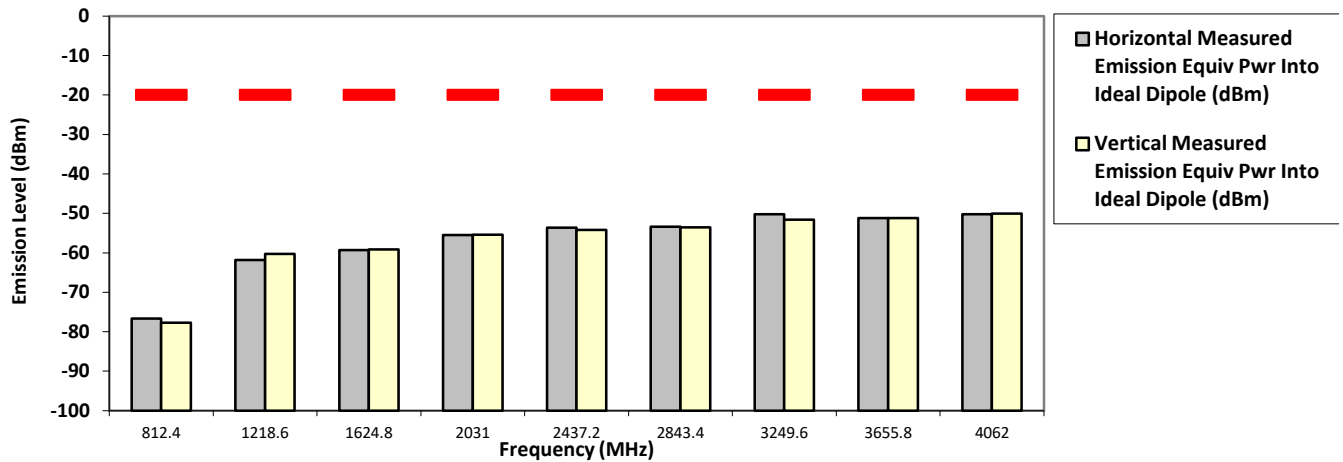

The data presented here was taken using the substitution method as found in the ANSI C63.26-2015 document.
 Motorola Penang EMC Lab - Test Performed by : Aiman Sun, 6 Aug, 2023

Remarks: ** Indicates the spurious emission could not be detected due to noise limitations or ambient.
 *Pursuant to CFR 47 Part 2.1057 (c), emissions attenuated more than 20 dB below the permissible limit are not reported
 Temp(Deg): 23.1 Hum(%RH): 54.3

Remarks: Passed Results Marginal Results Failed Results

SAC Transmitter Radiated Emission:

Model Number: AAH88QCP9JA2AN **S/N: 546TZP0405** **SR:40789-EMC-00011**
Battery Part No: PMNN4468B **Accy Part No: NA**
450.025000 MHz **Test Mode: TX Digital** **1.000 Watt(s) /Low Power**
12.5 kHz

Frequency (MHz)	Limit	Horizontal Measured Emission Equip Pwr Into Ideal Dipole (dBm)	Vertical Measured Emission Equip Pwr Into ideal Dipole (dBm)
900.0500	-20.0000	-75.1712 **	-76.0816 **
1350.0750	-20.0000	-61.2054 **	-60.0160 **
1800.1000	-20.0000	-57.7888 **	-58.4976 **
2250.1250	-20.0000	-54.8795 **	-56.5037 **
2700.1500	-20.0000	-53.8543 **	-52.7213 **
3150.1750	-20.0000	-52.2438 **	-52.3630 **
3600.2000	-20.0000	-52.9816 **	-51.9679 **
4050.2250	-20.0000	-49.4410 **	-50.3769 **
4500.2500	-20.0000	-49.9553 **	-50.2007 **

RADIATED SPURIOUS EMISSIONS

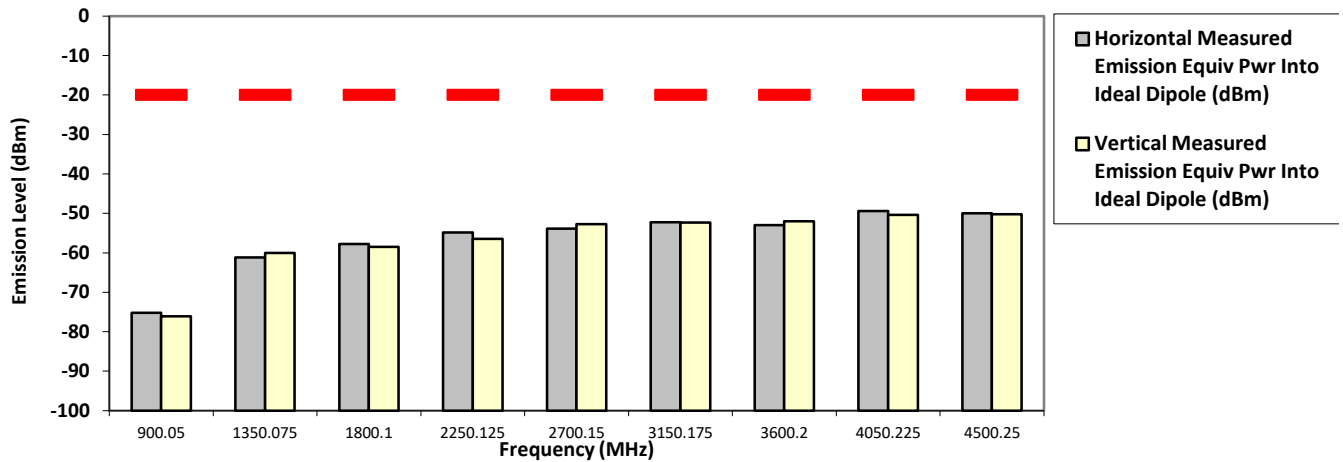

The data presented here was taken using the substitution method as found in the ANSI C63.26-2015 document.
 Motorola Penang EMC Lab - Test Performed by : Aiman Sun, 6 Aug, 2023

Remarks: ** Indicates the spurious emission could not be detected due to noise limitations or ambient.
 *Pursuant to CFR 47 Part 2.1057 (c), emissions attenuated more than 20 dB below the permissible limit are not reported
 Temp(Deg): 23.1 Hum(%RH): 54.3

Remarks: Passed Results Marginal Results Failed Results

SAC Transmitter Radiated Emission:

Model Number: AAH88QCP9JA2AN **S/N: 546TZP0405** **SR:40789-EMC-00011**
Battery Part No: PMNN4468B **Accy Part No: NA**
450.025000 MHz **Test Mode: TX Digital** **12.5 kHz** **3.300 Watt(s) /Max Power**

Frequency (MHz)	Limit	Horizontal Measured Emission Equip Pwr Into Ideal Dipole (dBm)	Vertical Measured Emission Equip Pwr Into ideal Dipole (dBm)
900.0500	-20.0000	-76.0387 **	-76.6322 **
1350.0750	-20.0000	-60.7263 **	-60.1110 **
1800.1000	-20.0000	-58.2051 **	-58.3949 **
2250.1250	-20.0000	-56.5261 **	-56.7189 **
2700.1500	-20.0000	-53.6459 **	-54.1252 **
3150.1750	-20.0000	-50.8993 **	-50.8179 **
3600.2000	-20.0000	-52.1567 **	-51.5223 **
4050.2250	-20.0000	-50.2694 **	-50.3133 **
4500.2500	-20.0000	-50.8273 **	-50.9620 **

RADIATED SPURIOUS EMISSIONS

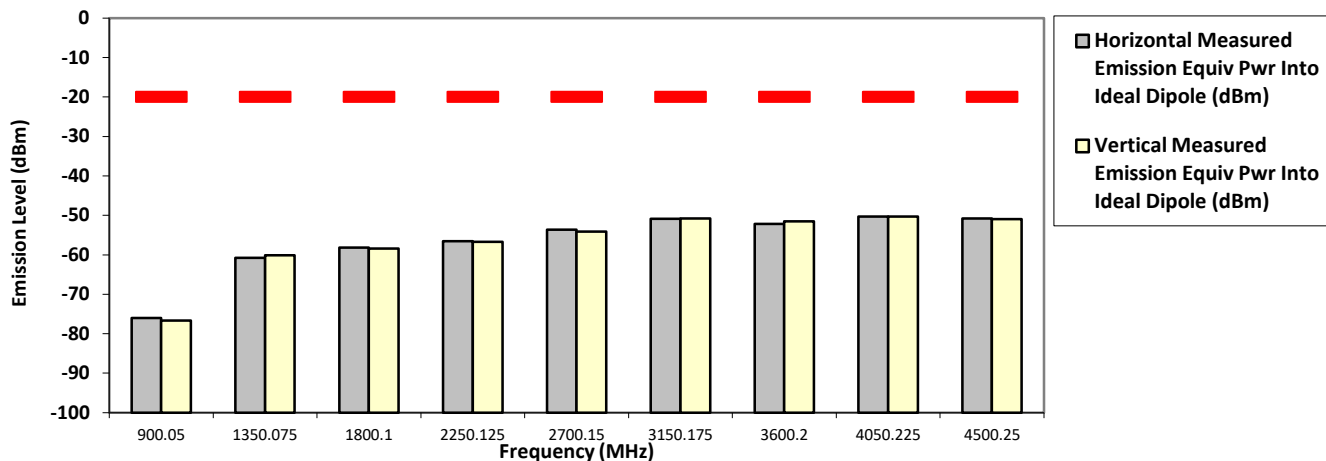

The data presented here was taken using the substitution method as found in the ANSI C63.26-2015 document.
 Motorola Penang EMC Lab - Test Performed by : Aiman Sun, 6 Aug, 2023

Remarks: ** Indicates the spurious emission could not be detected due to noise limitations or ambient.
 *Pursuant to CFR 47 Part 2.1057 (c), emissions attenuated more than 20 dB below the permissible limit are not reported
 Temp(Deg): 23.1 Hum(%RH): 54.3

Remarks: Passed Results Marginal Results Failed Results

SAC Transmitter Radiated Emission:

Model Number: AAH88QCP9JA2AN **S/N: 546TZP0405** **SR:40789-EMC-00011**
Battery Part No: PMNN4468B **Accy Part No: NA**
459.125000 MHz **Test Mode: TX Digital** **12.5 kHz** **3.300 Watt(s) /Max Power**

Frequency (MHz)	Limit	Horizontal Measured Emission Equip Pwr Into Ideal Dipole (dBm)	Vertical Measured Emission Equip Pwr Into ideal Dipole (dBm)
918.2500	-20.0000	-76.5030 **	-76.2754 **
1377.3750	-20.0000	-61.2857 **	-60.8070 **
1836.5000	-20.0000	-58.4728 **	-57.2556 **
2295.6250	-20.0000	-55.7278 **	-54.1735 **
2754.7500	-20.0000	-54.6453 **	-54.4658 **
3213.8750	-20.0000	-51.9123 **	-52.0393 **
3673.0000	-20.0000	-51.4833 **	-52.7888 **
4132.1250	-20.0000	-50.0961 **	-50.8214 **
4591.2500	-20.0000	-48.2406 **	-48.7612 **

RADIATED SPURIOUS EMISSIONS

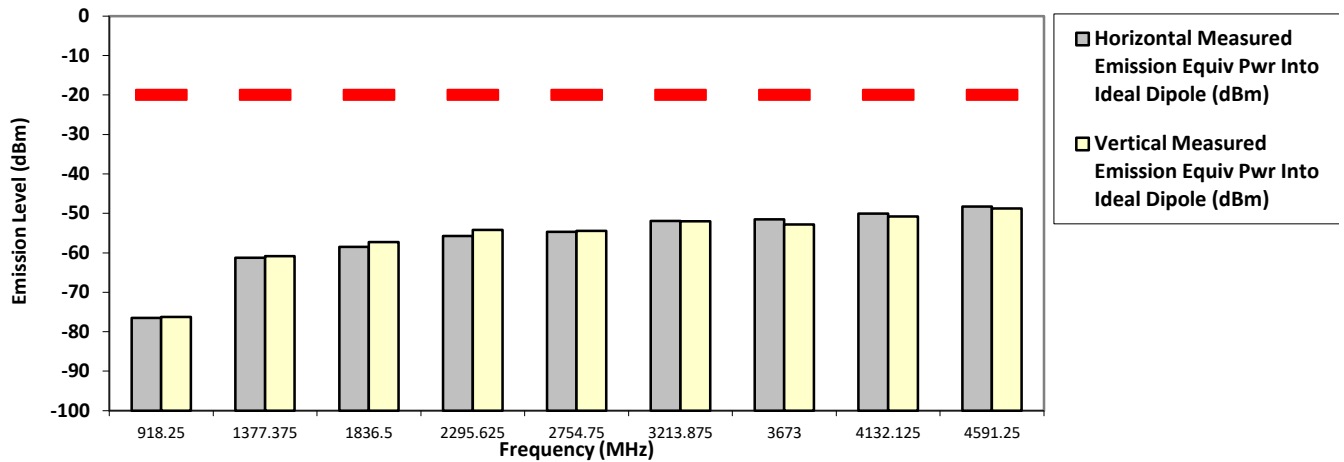

The data presented here was taken using the substitution method as found in the ANSI C63.26-2015 document.
 Motorola Penang EMC Lab - Test Performed by : Aiman Sun, 6 Aug, 2023

Remarks: ** Indicates the spurious emission could not be detected due to noise limitations or ambient.
 *Pursuant to CFR 47 Part 2.1057 (c), emissions attenuated more than 20 dB below the permissible limit are not reported
 Temp(Deg): 23.1 Hum(%RH): 54.3

Remarks: Passed Results Marginal Results Failed Results

SAC Transmitter Radiated Emission:

Model Number: AAH88QCP9JA2AN **S/N: 546TZP0405** **SR:40789-EMC-00011**
Battery Part No: PMNN4468B **Accy Part No: NA**
467.775000 MHz **Test Mode: TX Digital** **12.5 kHz** **3.300 Watt(s) /Max Power**

Frequency (MHz)	Limit	Horizontal Measured Emission Equip Pwr Into Ideal Dipole (dBm)	Vertical Measured Emission Equip Pwr Into ideal Dipole (dBm)
935.5500	-20.0000	-76.0524 **	-75.4628 **
1403.3250	-20.0000	-61.0042 **	-60.3157 **
1871.1000	-20.0000	-56.9901 **	-57.8602 **
2338.8750	-20.0000	-55.4486 **	-55.5403 **
2806.6500	-20.0000	-53.6483 **	-53.5917 **
3274.4250	-20.0000	-50.8214 **	-52.3704 **
3742.2000	-20.0000	-50.2587 **	-52.1301 **
4209.9750	-20.0000	-49.7021 **	-49.9645 **
4677.7500	-20.0000	-49.0726 **	-48.8977 **

RADIATED SPURIOUS EMISSIONS

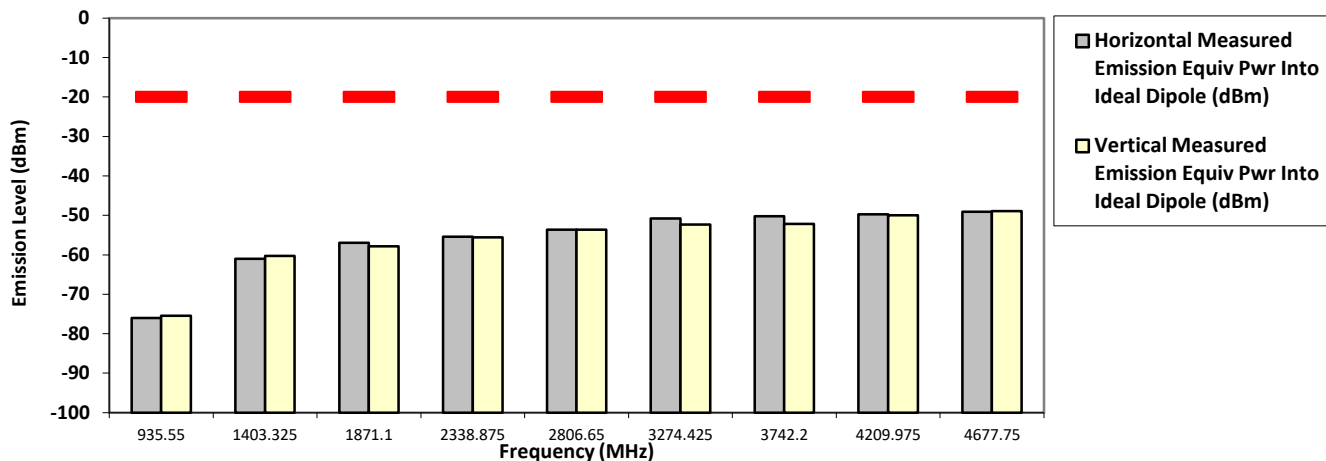

The data presented here was taken using the substitution method as found in the ANSI C63.26-2015 document.
 Motorola Penang EMC Lab - Test Performed by : Aiman Sun, 6 Aug, 2023

Remarks: ** Indicates the spurious emission could not be detected due to noise limitations or ambient.
 *Pursuant to CFR 47 Part 2.1057 (c), emissions attenuated more than 20 dB below the permissible limit are not reported
 Temp(Deg): 23.1 Hum(%RH): 54.3

Remarks: Passed Results Marginal Results Failed Results

SAC Transmitter Radiated Emission:

Model Number: AAH88QCP9JA2AN **S/N: 546TZP0405** **SR:40789-EMC-00011**
Battery Part No: PMNN4468B **Accy Part No: NA**
469.987500 MHz **Test Mode: TX Digital** **12.5 kHz** **3.300 Watt(s) /Max Power**

Frequency (MHz)	Limit	Horizontal Measured Emission Equip Pwr Into Ideal Dipole (dBm)	Vertical Measured Emission Equip Pwr Into ideal Dipole (dBm)
939.9750	-20.0000	-74.9424 **	-76.0006 **
1409.9625	-20.0000	-61.2812 **	-60.1884 **
1879.9500	-20.0000	-57.8768 **	-57.6751 **
2349.9375	-20.0000	-54.2505 **	-53.9347 **
2819.9250	-20.0000	-53.1869 **	-54.5956 **
3289.9125	-20.0000	-51.9160 **	-51.4923 **
3759.9000	-20.0000	-51.9895 **	-50.0571 **
4229.8875	-20.0000	-50.3900 **	-50.5775 **
4699.8750	-20.0000	-49.0146 **	-48.7527 **

RADIATED SPURIOUS EMISSIONS

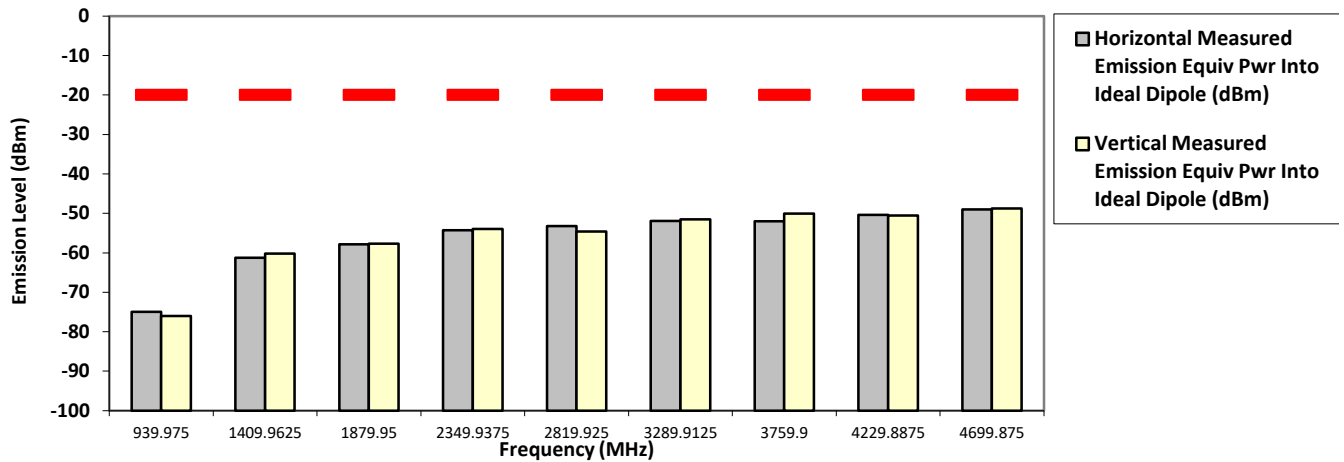

The data presented here was taken using the substitution method as found in the ANSI C63.26-2015 document.
 Motorola Penang EMC Lab - Test Performed by : Aiman Sun, 6 Aug, 2023

Remarks: ** Indicates the spurious emission could not be detected due to noise limitations or ambient.
 *Pursuant to CFR 47 Part 2.1057 (c), emissions attenuated more than 20 dB below the permissible limit are not reported
 Temp(Deg): 23.1 Hum(%RH): 54.3

Remarks: Passed Results Marginal Results Failed Results

6.10.4. Test Limit

Table below summarized the power of any emission outside a licensee’s frequency block shall be attenuated below the transmitter power (P) by at least

Channel Spacing	Part 22	Part 24D	Part 74	Part 80	Part 90 (UHF, VHF, 800, 900)	Part 90 (700)
12.5kHz	43 + log10(P) (-13 dBm)	43 + log10(P) (-13 dBm)	43 + log10(P) (-13 dBm)	Not Applicable	50 + log10(P) (-20 dBm)	43 + log10(P) (-13 dBm)
25kHz	43 + log10(P) (-13 dBm)	Not Applicable	43 + log10(P) (-13 dBm)	43 + log10(P) (-13 dBm)	43 + log10(P) (-13 dBm)	43 + log10(P) (-13 dBm)

Channel Spacing	RSS 134	RSS 182	RSS 119 (UHF, VHF, 800, 900)	RSS 119 (700)
12.5kHz	43 + log10(P) (-13 dBm)	Not Applicable	50 + log10(P) (-20 dBm)	43 + log10(P) (-13 dBm)
25kHz	Not Applicable	43 + log10(P) (-13 dBm)	43 + log10(P) (-13 dBm)	43 + log10(P) (-13 dBm)

6.11. Effective Radiated Power (ERP)

6.11.1. Test Setup

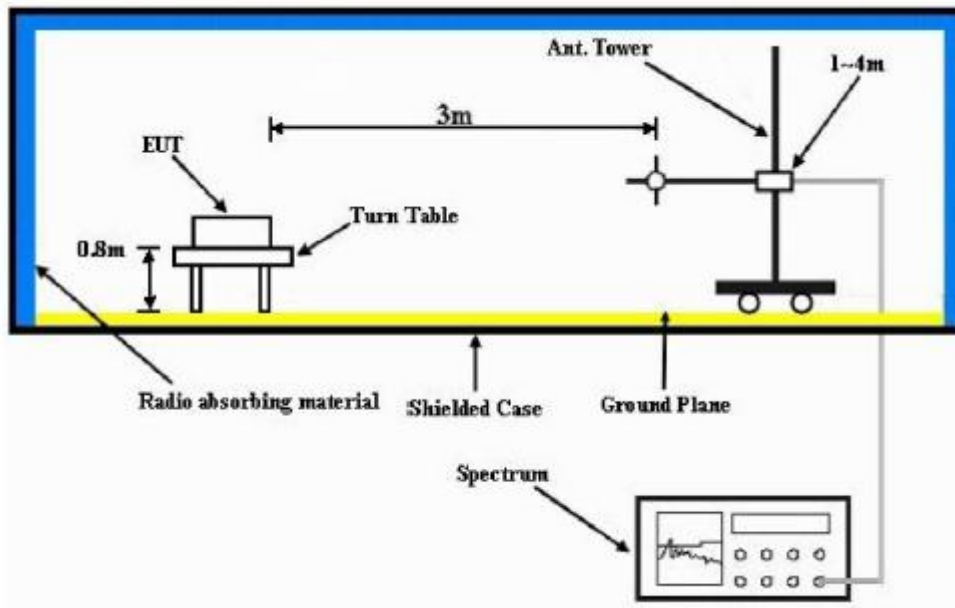

- 1) The Resolution Bandwidth for Equivalent Radiated Power (ERP) below 1 GHz is 100 kHz with Video Bandwidth = 300 kHz and Resolution Bandwidth for EIRP above 1 GHz is 1 MHz with Video Bandwidth = 3 MHz. Detector Mode is RMS.
- 2) In the semi-anechoic chamber, setup as illustrated above the DUT placed on the 0.8m height (for $f_c < 1\text{GHz}$) or 1.5m (for $f_c > 1\text{GHz}$) of Turn Table, rotated the table 45 degree each interval to search the maximum radiation power and receiver antenna shall be rotated vertical and horizontal polarization and moved height from 1m to 4m to find the maximum polar radiated power for each degree interval. The “Read Value” is the spectrum reading of maximum power value.
- 3) The substitution antenna is substituted for DUT at the same position and signals generator (S.G) export the CW signal to the substitution antenna via a TX cable. The receiver antenna shall be rotated vertical and horizontal polarization and moved height from 1m to 4m to find the maximum radiation power. Record the power level of maximum radiation power from spectrum. So, the Measured substitution value = Ref level of S.G + TX cables loss – Substituted Antenna Gain.

6.11.2. Test Result Not Applicable

6.11.3. Test Limit The maximum output power of the transmitter for mobile stations is 100 watts (20 dB). Power is given in terms of effective radiated power (ERP).

6.12. GNSS (EIRP for 1559 - 1610MHz)

6.12.1. Test Setup

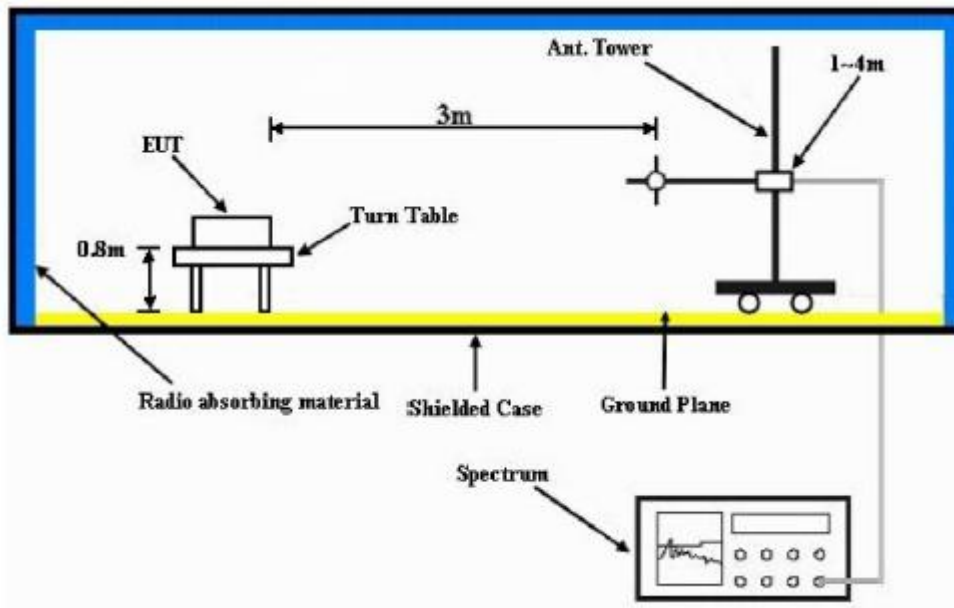

- 4) The Resolution Bandwidth for Equivalent Isotropically Radiated Power (EIRP) below 1 GHz is 100 kHz with Video Bandwidth = 300 kHz and Resolution Bandwidth for EIRP above 1 GHz is 1 MHz with Video Bandwidth = 3 MHz. Detector Mode is RMS.
- 5) In the semi-anechoic chamber, setup as illustrated above the DUT placed on the 0.8m height of Turn Table, rotated the table 45 degree each interval to search the maximum radiation power and receiver antenna shall be rotated vertical and horizontal polarization and moved height from 1m to 4m to find the maximum polar radiated power for each degree interval. The “Read Value” is the spectrum reading of maximum power value.
- 6) The substitution antenna is substituted for DUT at the same position and signals generator (S.G) export the CW signal to the substitution antenna via a TX cable. The receiver antenna shall be rotated vertical and horizontal polarization and moved height from 1m to 4m to find the maximum radiation power. Record the power level of maximum radiation power from spectrum. So, the Measured substitution value = Ref level of S.G + TX cables loss – Substituted Antenna Gain.
- 7) $EIRP = \text{“Read Value”} + \text{Measured substitution value} + 2.15$.

6.12.1. Test Result **Not Applicable**

6.12.2. Test Limit

For operations in the 758-775 MHz and 788-805 MHz bands, all emissions including harmonics in the band 1559-1610 MHz shall be limited to -70 dBW/MHz equivalent isotropically radiated power (EIRP) for wideband signals, and -80 dBW EIRP for discrete emissions of less than 700 Hz bandwidth.

~ End of Test Report ~