 <p>CERTIFICATE 2518.08</p> <p>SAMM 086</p>
<p><b>MOTOROLA PENANG ADV. COMM. LABORATORY</b>                  Motorola Solutions Malaysia SDN BHD                  Plot 2A, Medan Bayan Lepas,                  Mukim 12 S.W.D., 11900 Bayan Lepas,                  Penang, Malaysia.</p>	<p><b>FCC / IC TEST REPORT</b>  <b>Report Revision : Rev.B</b></p>
<p><b>Date/s Tested</b> : 09-December-2022 - 18-December-2022  <b>Report Issue Date</b> : 22-December-2022  <b>Manufacturer/Location</b> : Motorola Solutions Malaysia SDN BHD                  Plot 2A, Medan Bayan Lepas, Mukim 12 S.W.D.,                  11900 Bayan Lepas, Penang, Malaysia  <b>Requestor</b> : KK LIM  <b>Product Type</b> : Hand-held  <b>Model Number</b> : T6B22201GWRAAW  <b>Frequency Band</b> : 462-468 MHz  <b>Max. Output Power</b> : 0.5W ERP/2W ERP  <b>Firmware Version</b> : NA 002  <b>Applicant Name</b> : Motorola Solutions Inc  <b>Applicant Address</b> : 8000 West Sunrise Boulevard, Fort Lauderdale, Florida                  33322.  <b>FCC Registration</b> : 461337  <b>IC Registrations</b> : MY0001</p> <p><b>The equipment was tested accordance to the requirement listed below:</b></p> <p style="text-align: center;"><b>PASS</b></p> <p><b>FCC 47 CFR Part 95</b></p>	
<p>This report shall not be reproduced without written approval from an officially designated representative of the Motorola Penang Adv. Comm. Laboratory. The results and statements contained in this report pertain only to the device(s) evaluated.</p>	
<p>Prepared By:</p>  <hr/> <p><b>GAN BOON TEONG</b>  <b>Test Personnel</b></p>	<p>Approved Signatory :</p> <hr/> <p><b>VINCENT FOONG CHUEN KIT</b>  <b>Responsible Engineer</b></p>

## Table of Contents

1.0. General Information.....	4
2.0. Summary of Test Results.....	6
3.0. Measurement Uncertainty .....	6
4.0. Equipment List.....	7
5.0. Test Mode Applicability and Test Channel Detail .....	9
6.0. Transmitter Test Parameters .....	10
6.1. Maximum Output Power.....	10
6.1.1. Test Setup.....	10
6.1.2. Test Limits.....	11
6.1.3. Test Data .....	12
6.2. Modulation Limiting.....	13
6.2.1. Test Setup.....	13
6.2.2. Test Limits.....	14
6.2.3. Test Result.....	15
6.3. Audio Frequency Response .....	17
6.3.1. Test Setup.....	17
6.3.2. Test Limits: .....	17
6.3.3. Test Result.....	18
6.4. Audio Low Pass Filter .....	20
6.4.1. Test Setup.....	20
6.4.2. Test Limits: .....	21
6.4.3. Test Result.....	22
6.5. Frequency Stability.....	23
6.5.1. Test Setup.....	23
6.5.2. Test Limits: .....	23
6.5.3. Test Result.....	24
6.6. Emission Mask.....	28
6.6.1. Test Setup.....	28
6.6.2. Test Limits: .....	29
6.6.1. Test Data .....	31
6.7. Radiated Spurious Emission .....	34
6.7.1. Test Setup.....	34
6.7.2. Test Result.....	35
6.7.3. Test limit .....	38

<b>Revision History</b>	<b>Description</b>	<b>Date</b>	<b>Originator</b>
Rev. A	Initial Report	<b>22-December-2022</b>	<b>Gan Boon Teong</b>
Rev. B	1. Update Cover page Model Number and Firmware Version 2. Update Radiated Spurious Emission test result max power	<b>19-January-2023</b>	<b>Gan Boon Teong</b>

## 1.0. General Information

### EUT Description:

Tx Frequency range	
462.5500MHz to 467.7125MHz	
<b>Antenna type gain</b>	Fix antenna, -0.5dBi
<b>Technologies</b>	FM
<b>Device voltage</b>	4.5V dc

The EUT contains following accessory devices and data cable:

Item	Model or P/N
3XAA Alkaline individual batteries	AA ALKALINE
800MAH 3XAA NIMH RECHARGEABLE BATTERY PACK	PMNN4477A
USB-C CABLE CHARGING ONLY - (1 cable)	PMKN4296A
Laptop	AH422508

Channel number and frequency information:

Product channel table:

FRS Channels

Channel	Frequency(MHz)	Channel	Frequency(MHz)
1	462.5625	12	467.6625
2	462.5875	13	467.6875
3	462.6125	14	467.7125
4	462.6375	15	462.5500
5	462.6625	16	462.5750
6	462.6875	17	462.6000
7	462.7125	18	462.6250
8	467.5625	19	462.6500
9	467.5875	20	462.6750
10	467.6125	21	462.7000
11	467.6375	22	462.7250

### GMRS main channels

Channel	Frequency(MHz)	Channel	Frequency(MHz)
1	462.5500	9	467.5500
2	462.5750	10	467.5750
3	462.6000	11	467.6000
4	462.6250	12	467.6250
5	462.6500	13	467.6500
6	462.6750	14	467.6770
7	462.7000	15	467.7000
8	462.7250	16	467.7125

### GMRS interstitial channels

Channel	Frequency(MHz)	Channel	Frequency(MHz)
1	462.5625	8	467.5675
2	462.5875	9	467.5875
3	462.6125	10	467.6125
4	462.6375	11	467.6375
5	462.6625	12	467.6625
6	462.6875	13	467.6875
7	462.7125	14	467.7125

*In §15.31 (m), Frequency range over which device operates in 1MHz or less, middle frequency of channel is selected to perform test.*

### General Description of Applied Standards

The EUT is a RF Product. According to the specifications of the manufacturer, the EUT is to comply with the requirements of the following standards:

**ANSI C63.26**  
**FCC Part 2 & 95**

### Deviation from standard

Not applicable as no deviation from standard test method

### Modifications to EUT

For RF conducted measurements a pigtail was soldered out of the board while for radiated measurements there were no modifications to the device

### Antenna gain disclaimer

Antenna gain information is provided by customer. The validity of the results is dependent upon this information. The lab will not be held accountable in the event the supplied information affects compliance.

### Test configuration of EUT

All relevant configurations involving radio models and accessories (including chargers, batteries, and antennas) were assessed. Only worst case configurations will be included in this report.

## 2.0. Summary of Test Results

FCC Clause	Test Item	Result	Remark	Tested by	Serial number	Environmental conditions
95.567 95.1767	Maximum Output Power	Pass	Highest output power: 33.31dBm (2.14W)	Gan	17520YX0009	25°C 50%RH
95.575 95.1775	Modulation Limiting	Pass	NA	Gan	17520YX0009	25°C 50%RH
95.575 95.1775	Audio Frequency Response	Pass	NA	Gan	17520YX0009	25°C 50%RH
95.1775	Audio Low Pass Filter	Pass	NA	NA	NA	NA
95.565 95.1765	Frequency Stability	Pass	NA	Gan	17520YX0009	25°C 50%RH
95.573 95.1773	Emission Bandwidth	Pass	11K0F3E – 9.9857kHz	Gan	17520YX0009	25°C 50%RH
95.579 95.1779	Unwanted Radiation	Pass	Max spurious emission -17.55dBm (margin: 4.55dBm)	Qawiman & Nazrin	17520YX0006, 17520YX0007	23.5°C 69.7%RH

## 3.0. Measurement Uncertainty

Measurement	Frequency	Expanded Uncertainty (k=1.96) (±dB)
Maximum Output Power	462MHz ~ 468MHz	5.01
AC Power Line Conducted Spurious Emission	150KHz ~ 30MHz	3.48
Radiated Emissions up to 1 GHz	30MHz ~ 1000MHz	5.88
Radiated Emissions above 1 GHz	1GHz ~ 18GHz	5.84
	18GHz ~ 40GHz	6.02
Frequency Stability	9kHz ~ 12.75GHz	0.0085 ppm
Audio Frequency Response / Low Pass Filter Response	300Hz – 20kHz	4.09 %
Modulation Limiting	300Hz – 3kHz	1.15 %
Occupied Bandwidth	9kHz ~ 12.75GHz	2.82 dB

#### 4.0. Equipment List Analog ATE #9

Description	Model	Serial Number	Calibration Date	Calibration Due Date
RF TRANSCEIVER CONTROLLER	AX2007AI	AX2007AI002	NA	NA
POWER METER	E4416A	GB41293866	4-Mar-22	4-Mar-23
CHAMBER	SH-641	92006068	8-Apr-22	8-Apr-23
MODULATION ANALYZER	8901B	3005A02607	1-Jul-22	1-Jul-23
TRANSCEIVER INTERFACE	8954A	2612A00551	9-Aug-22	9-Aug-23
SIGNAL GENERATOR	SMA100A	111381	26-Jan-22	26-Jan-23
POWER SENSOR	E4412A	MY41498918	14-Aug-22	14-Aug-23
POWER SUPPLY	6031A	3018A01915	28-Sep-22	28-Sep-23
AUDIO ANALYZER	8903B	3413A14586	23-Sep-22	23-Sep-23
VECTOR SIGNAL GENERATOR	E4438C	MY47271303	8-Dec-22	8-Dec-23
SIGNAL GENERATOR	2042	203002/862	13-Oct-22	13-Oct-23
N to N RF cable # 1	SUCOFLEX 104	NA	NA	NA
N to N RF cable # 2	84188418 H+S MY 0812	NA	NA	NA
N to N RF cable # 3	84188418 H+S MY 0812	NA	NA	NA
N to N RF cable # 4	84188418 H+S MY 0812	NA	NA	NA
N to N RF cable # 5	84188418 H+S MY 0812	NA	NA	NA
N to N RF cable # 6	84188418 H+S MY 0812	NA	NA	NA
N to N RF cable # 7	84188418 H+S MY 0812	NA	NA	NA
N to N RF cable # 8	84188418 H+S MY 0812	NA	NA	NA
N to N RF cable # 9	84188418 H+S MY 0812	NA	NA	NA
N to N RF cable # 10	84188418 H+S MY 0812	NA	NA	NA
N to N RF cable # 11	84188418 H+S MY 0812	NA	NA	NA
N to N RF cable # 12	84188418 H+S MY 0812	NA	NA	NA
N to N RF cable # 13	84188418 H+S MY 0812	NA	NA	NA
N to N RF cable # 14	84188418 H+S MY 0812	NA	NA	NA
N to N RF cable # 15	84188418 H+S MY 0812	NA	NA	NA
BNC to BNC RF cable # 1	NA	NA	NA	NA
BNC to BNC RF cable # 2	NA	NA	NA	NA
BNC to BNC RF cable # 3	NA	NA	NA	NA
BNC to BNC RF cable # 4	NA	NA	NA	NA
BNC to BNC RF cable # 5	NA	NA	NA	NA
BNC to BNC RF cable # 6	NA	NA	NA	NA
BNC to BNC RF cable # 7	NA	NA	NA	NA
BNC to BNC RF cable # 8	NA	NA	NA	NA
Test Software	Analog ATE			
Version	2.4.6			
Test Software	FCC_FreqStability			
Version	Rev1.0.3			

**FCC Transient ATE #1: (SW version: FCC Transient ATE\_R1.2.1)**

Description	Model	Serial Number	Calibration Date	Calibration Due Date
SWITCH CONTROL UNIT	3488A	2719A36210	NA	NA
ATTENUATOR / SWITCH DRIVER	11713A	2508A10141	NA	NA
POWER SENSOR	E9301B	MY41495393	9-Jun-22	9-Jun-23
POWER METER	E4416A	GB41293240	14-Mar-22	14-Mar-23
POWER SUPPLY	6032A	3232A08203	3-Jun-22	3-Jun-23
ATTENUATOR/10DB	8494G	MY42143006	7-Jun-22	7-Jun-23
ATTENUATOR/110DB	8496G	MY52300088	9-Aug-22	9-Aug-23
SIGNAL GENERATOR	8657A	3250A05137	24-Jun-22	24-Jun-23
AUDIO ANALYZER	8903B	3011A12488	9-Sep-22	9-Sep-23
ANALYZER SPECTRUM	E4440A	MY46186938	19-Aug-22	19-Aug-23
OSCILLOSCOPE	MSO8064A	MY45003003	1-Nov-22	1-Nov-23
MODULATION ANALYZER	8901B	3403A04772	16-Aug-22	16-Aug-23
AUDIO ANALYZER	8903B	3413A14095	18-Oct-22	18-Oct-23
N to N RF Cable # 1	SF126/11N/11N	NA	NA	NA
N to N RF Cable # 2	M17/128-RG400	NA	NA	NA
N to N RF Cable # 3	M17/128-RG400	NA	NA	NA
N to N RF Cable # 4	M17/128-RG400	NA	NA	NA
N to N RF Cable # 5	M17/128-RG400	NA	NA	NA
N to N RF Cable # 6	M17/128-RG400	NA	NA	NA
N to N RF Cable # 7	M17/128-RG400	NA	NA	NA
N to N RF Cable # 8	M17/128-RG400	NA	NA	NA
BNC to BNC RF Cable # 1	RG 58	NA	NA	NA
BNC to BNC RF Cable # 2	RG 58	NA	NA	NA
BNC to BNC RF Cable # 3	RG 58	NA	NA	NA
BNC to BNC RF Cable # 4	RG 58	NA	NA	NA
BNC to BNC RF Cable # 5	RG 58	NA	NA	NA
BNC to BNC RF Cable # 6	RG 58	NA	NA	NA
BNC to N RF Cable # 1	RG 58	NA	NA	NA
Aeroflex Attenuator 10dB	49-10-43-LIM	NA	NA	NA
Aeroflex Attenuator 10dB	33-10-34-LIM	NA	NA	NA



**EMC Chamber 1**

DESCRIPTION	MODEL	SERIAL NUMBER	CALIBRATION DATE	CALIBRATION DUE DATE
DRG HORN FREQ.	SAS-571	720	06-Apr-21	06-Apr-23
DRG HORN FREQ.	SAS-571	1027	03-Jun-22	03-Jun-23
DC Power Supply	N7976A	MY53410110	30-Jun-22	30-Jun-23
SIGNAL GENERATOR	SMB 100A	182511	4-Jun-21	4-Jun-24
EMI TEST RECEIVER	ESW44	101751	24-Mar-22	24-Mar-23
5m SEMI-ANECHOIC CHAMBER	S800-HX	J2308	NA	NA
BILOG ANTENNA	CBL6112B	2863	22-Jun-22	22-Jun-23
BILOG ANTENNA	CBL6112D	55546	23-Jun-22	23-Jun-23
DATA LOGGER THERMOHYGROMETER	SDL500	A.016785	23-Jun-22	23-Jun-23
SYSTEM CONTROLLER	SC104V	050806-1	NA	NA
TURNTABLE FLUSH MOUNT 2M	FM2011	NA	NA	NA
ANTENNA POSITIONING TOWER	TLT2	NA	NA	NA
BROAD-BAND HORN ANTENNA	BBHA9170	BBHA9170255	18-Feb-22	18-Feb-23
PREAMPLIFIER 18-40GHz	BBV9721	9721-007	NA	NA
PREAMPLIFIER	PAM-0118P	361	11-Sep-20	11-Sep-23
LOOP ANTENNA	6502	00203479	10-Feb-22	10-Feb-23
Test Software	EMC_FCC_IC_Bluetooth_RE_Test			
Version	EMC_FCC_RE_v1.6.5			

**5.0. Test Mode Applicability and Test Channel Detail**

Test Frequency list:

FRS

Channel	Frequency
4	462.6375 MHz
11	467.6375 MHz

## 6.0. Transmitter Test Parameters

### 6.1. Maximum Output Power

#### 6.1.1. Test Setup

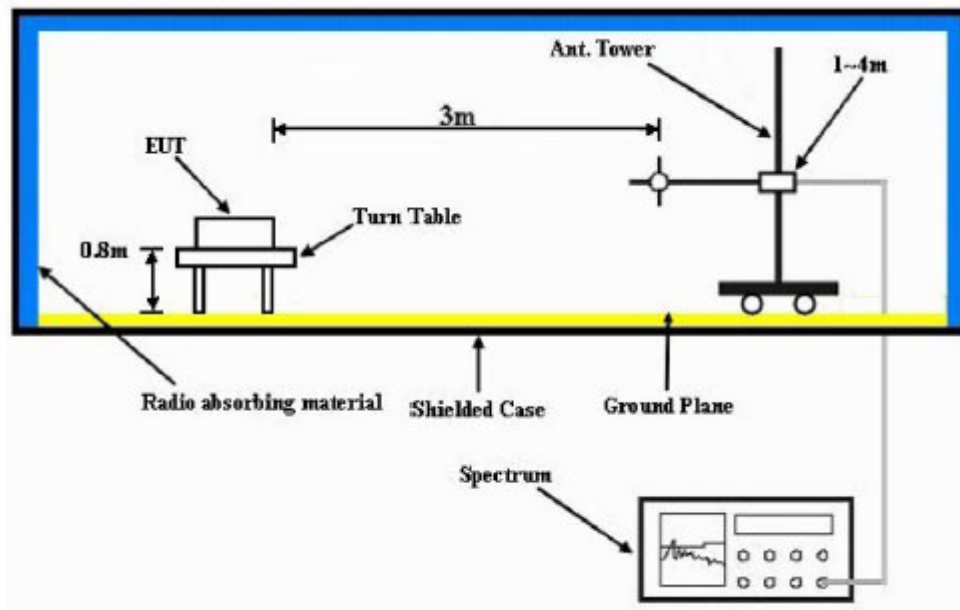

- 1) The spectrum setting for Equivalent Isotropically Radiated Power (EIRP) is RBW = 100 kHz, VBW = 300 kHz. Detector Mode is RMS.
- 2) In the semi-anechoic chamber, setup as illustrated above the EUT placed on the 0.8m height of Turn Table, rotated the table 45 degree each interval to search the maximum radiation power and receiver antenna shall be rotated vertical and horizontal polarization and moved height from 1m to 4m to find the maximum polar radiated power for each degree interval. The “Read Value” is the spectrum reading of maximum power value.
- 3) The substitution antenna is substituted for EUT at the same position and signals generator (S.G) export the CW signal to the substitution antenna via a TX cable. The receiver antenna shall be rotated vertical and horizontal polarization and moved height from 1m to 4m to find the maximum radiation power. Record the power level of maximum radiation power from spectrum. So, the Measured substitution value = Ref level of S.G + TX cables loss – Substituted Antenna Gain.
- 4) Alternatively, max ERP can be calculated using conducted power measurement + max antenna gain (dBd)

## 6.1.2. Test Limits

### §95.567 FRS Transmit Power

Each FRS transmitter type must be designed such that the effective radiated power (ERP) on channels 8 through 14 does not exceed 0.5 Watts and the ERP on channels 1 through 7 and 15 through 22 does not exceed 2.0 Watts.

### §95.567 GMRS Transmitting Power Limits

This section contains transmitting power limits for GMRS stations. The maximum transmitting power depends on which channels are being used and the type of station.

(a) 462/467 MHz main channels. The limits in this paragraph apply to stations transmitting on any of the 462 MHz main channels or any of the 467 MHz main channels. Each GMRS transmitter type must be capable of operating within the allowable power range. GMRS licensees are responsible for ensuring that their GMRS stations operate in compliance with these limits.

(1) The transmitter output power of mobile, repeater and base stations must not exceed 50 Watts.

(2) The transmitter output power of fixed stations must not exceed 15 Watts.

(b) 462 MHz interstitial channels. The effective radiated power (ERP) of mobile, hand-held portable and base stations transmitting on the 462 MHz interstitial channels must not exceed 5 Watts.

(c) 467 MHz interstitial channels. The effective radiated power (ERP) of hand-held portable units transmitting on the 467 MHz interstitial channels must not exceed 0.5 Watt. Each GMRS transmitter type capable of transmitting on these channels must be designed such that the ERP does not exceed 0.5 Watt.

### 6.1.3. Test Data

#### EIRP/ERP

Channel Spacing : 12.5 kHz

Tx Power: 2.2 Watts

Accessory: NA

Modulation: FM

Max antenna gain:-0.5dBi

Frequency (MHz)	Measured conducted power (dBm)	Max ERP (dBm)
462.6375	33.31	30.66

#### EIRP/ERP

Channel Spacing : 12.5 kHz

Tx Power: 0.5Watts

Accessory: NA

Modulation: FM

Max antenna gain:-0.5dBi

Frequency (MHz)	Measured conducted power (dBm)	Max ERP (dBm)
467.6375	26.98	24.33

## 6.2. Modulation Limiting

### 6.2.1. Test Setup

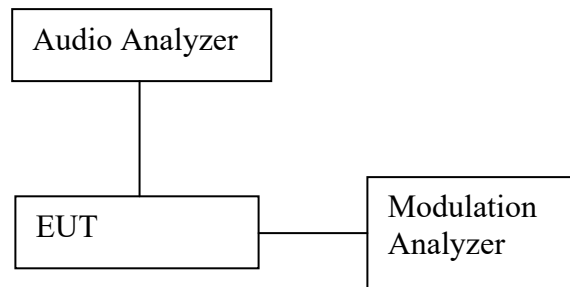

- 1) The DUT transmitter output port was connected to Modulation Analyzer.
- 2) Path loss for the measurement included.
- 3) Set the audio bandwidth filter to 15 kHz.
- 4) Transmit the radio and set the audio analyzer to 1 kHz audio frequency and 60% of the maximum deviation.
- 5) Record the frequency deviation as 0dB input level at 1kHz audio frequency.
- 6) Repeat the step and record the frequency deviation from -20dB to 20dB by 5dB increments and different audio freq 300Hz, 2.5 KHz and 3 KHz.

## 6.2.2. Test Limits

### §95.575 FRS Modulation limits

Each FRS transmitter type must be designed such that the peak frequency deviation does not exceed 2.5 kHz, and the highest audio frequency contributing substantially to modulation must not exceed 3.125 kHz.

### §95.1775 GMRS modulation requirements

Each GMRS transmitter type must be designed to satisfy the modulation requirements in this section. Operation of GMRS stations must also be in compliance with these requirements.

(a) Main channels. The peak frequency deviation for emissions to be transmitted on the main channels must not exceed  $\pm 5$  kHz.

(b) 462 MHz interstitial channels. The peak frequency deviation for emissions to be transmitted on the 462 MHz interstitial channels must not exceed  $\pm 5$  kHz.

(c) 467 MHz interstitial channels. The peak frequency deviation for emissions to be transmitted on the 467 MHz interstitial channels must not exceed  $\pm 2.5$  kHz, and the highest audio frequency contributing substantially to modulation must not exceed 3.125 kHz.

(d) Overmodulation. Each GMRS transmitter type, except for a mobile station transmitter type with a transmitter power output of 2.5 W or less, must automatically prevent a higher than normal audio level from causing overmodulation.

### 6.2.3. Test Result

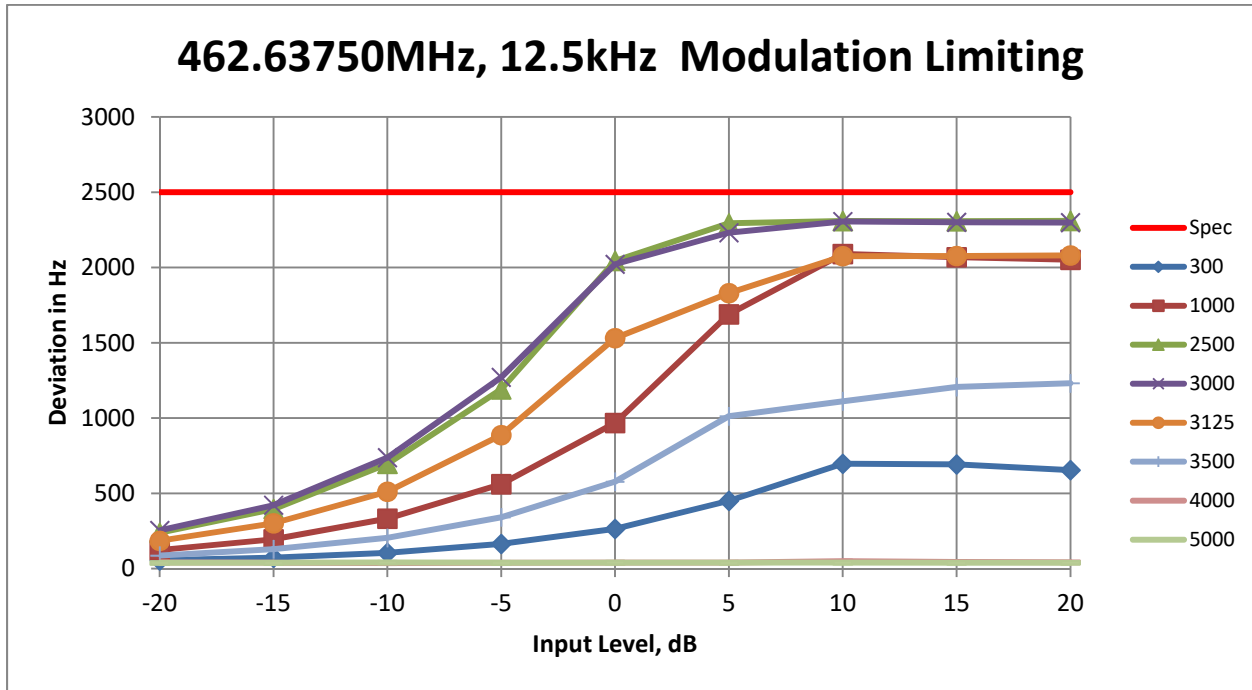

Frequency / Channel Spacing		462.63750MHz / 12.5kHz																		
Voltage		4.5V																		
Temperature, °C		25																		
Freq Deviation, Hz		300		1000		2500		3000		3125		3500		4000		5000		Spec		
Input Level, dB	Dev, Hz	%	Dev, Hz	%	Dev, Hz	%	Dev, Hz	%	Dev, Hz	%	Dev, Hz	%	Dev, Hz	%	Dev, Hz	%	Dev, Hz	%	Dev, Hz	%
-20	55	2.2	123	4.9	238	9.5	254	10.2	185	7.4	86	3.5	40	1.6	38	1.5	2500	100		
-15	73	2.9	195	7.8	395	15.8	421	16.9	301	12.1	129	5.1	39	1.6	38	1.5	2500	100		
-10	105	4.2	332	13.3	696	27.8	737	29.5	511	20.4	205	8.2	37	1.5	41	1.6	2500	100		
-5	164	6.6	561	22.4	1191	47.6	1271	50.8	887	35.5	341	13.6	39	1.6	38	1.5	2500	100		
0	264	10.5	967	38.7	2044	81.8	2022	80.9	1531	61.2	577	23.1	40	1.6	40	1.6	2500	100		
5	450	18.0	1689	67.6	2294	91.7	2231	89.3	1830	73.2	1012	40.5	40	1.6	39	1.6	2500	100		
10	697	27.9	2090	83.6	2309	92.3	2306	92.2	2076	83.0	1112	44.5	49	2.0	40	1.6	2500	100		
15	692	27.7	2068	82.7	2308	92.3	2301	92.0	2077	83.1	1206	48.3	44	1.8	39	1.6	2500	100		
20	654	26.2	2052	82.1	2310	92.4	2298	91.9	2080	83.2	1231	49.3	42	1.7	39	1.6	2500	100		

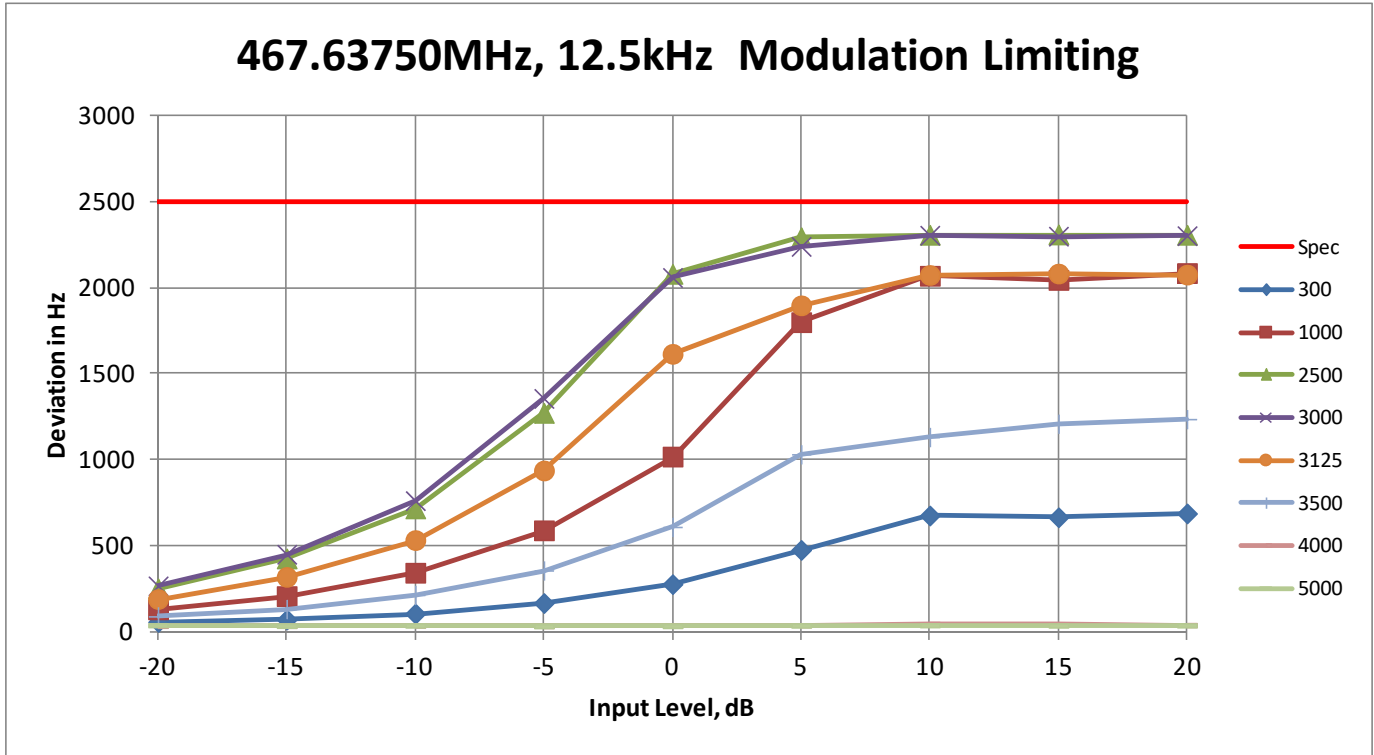

Frequency / Channel Spacing		467.63750MHz / 12.5kHz																	
Voltage		4.5V																	
Temperature, °C		25																	
Freq Deviation, Hz		300		1000		2500		3000		3125		3500		4000		5000		Spec	
Input Level, dB		Dev, Hz	%	Dev, Hz	%	Dev, Hz	%	Dev, Hz	%	Dev, Hz	%	Dev, Hz	%	Dev, Hz	%	Dev, Hz	%	Dev, Hz	%
-20		57	2.3	130	5.2	251	10.0	266	10.6	190	7.6	89	3.5	34	1.4	38	1.5	2500	100
-15		71	2.8	206	8.3	425	17.0	449	18.0	318	12.7	131	5.3	34	1.3	34	1.3	2500	100
-10		105	4.2	343	13.7	715	28.6	761	30.4	532	21.3	213	8.5	36	1.4	35	1.4	2500	100
-5		166	6.7	589	23.5	1270	50.8	1354	54.2	936	37.4	355	14.2	33	1.3	32	1.3	2500	100
0		276	11.1	1016	40.7	2077	83.1	2057	82.3	1613	64.5	608	24.3	36	1.5	33	1.3	2500	100
5		474	19.0	1797	71.9	2290	91.6	2237	89.5	1895	75.8	1030	41.2	37	1.5	35	1.4	2500	100
10		675	27.0	2066	82.7	2304	92.2	2302	92.1	2071	82.8	1130	45.2	45	1.8	37	1.5	2500	100
15		664	26.6	2042	81.7	2307	92.3	2296	91.9	2079	83.2	1208	48.3	42	1.7	36	1.4	2500	100
20		687	27.5	2082	83.3	2304	92.2	2300	92.0	2073	82.9	1234	49.4	39	1.6	36	1.5	2500	100



## 6.3. Audio Frequency Response

### 6.3.1. Test Setup

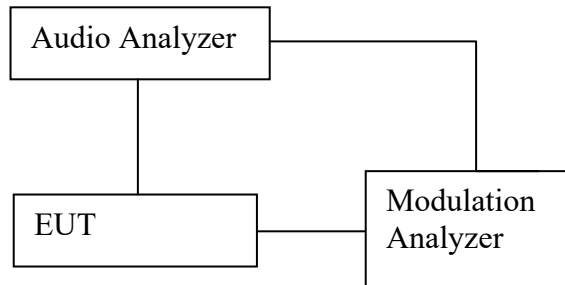

- 1) The DUT transmitter output port was connected to Modulation Analyzer.
- 2) Path loss for the measurement included.
- 3) Set the audio bandwidth filter to 15 kHz and 50kHz.
- 4) Transmit the radio and set the audio analyzer to 1 kHz audio frequency and 20% of the maximum deviation.
- 5) On audio analyzer, set the rated level as reference to zero.
- 6) Vary the audio frequency from 300Hz to 3 kHz. Record the change in dB on the audio analyzer.

### 6.3.2. Test Limits:

#### §95.575 FRS modulation limits

Each FRS transmitter type must be designed such that the peak frequency deviation does not exceed 2.5 kHz, and the highest audio frequency contributing substantially to modulation must not exceed 3.125 kHz.

#### §95.1775 GMRS modulation requirements

(c) 467 MHz interstitial channels. The peak frequency deviation for emissions to be transmitted on the 467 MHz interstitial channels must not exceed  $\pm 2.5$  kHz, and the highest audio frequency contributing substantially to modulation must not exceed 3.125 kHz.

### 6.3.3. Test Result

Frequency : 462.6375 MHz 2.2W

voltage	3.6 V		
Temp. (°C)	25		
Audio Frequency(Hz)	dB	HighSide Specs	LowSide Specs
100	-31.36		
200	-31.27		
300	-11.88	-9.4218	-17.8436
400	-8.63	-6.9316	-12.8631
500	-6.40	-5.0000	-9.0000
750	-2.96	-1.4902	-5.4902
1000	0.02	1.0000	-3.0000
1500	3.24	4.5098	0.5098
1750	3.96	5.8441	1.8441
2000	5.34	7.0000	3.0000
2500	6.88	8.9316	4.9316
2750	7.08	9.7566	4.9316
3000	7.44	10.5098	4.9316
3125	4.17		
3250	-4.62		
3500	-31.39		
4000	-30.85		
5000	-31.12		

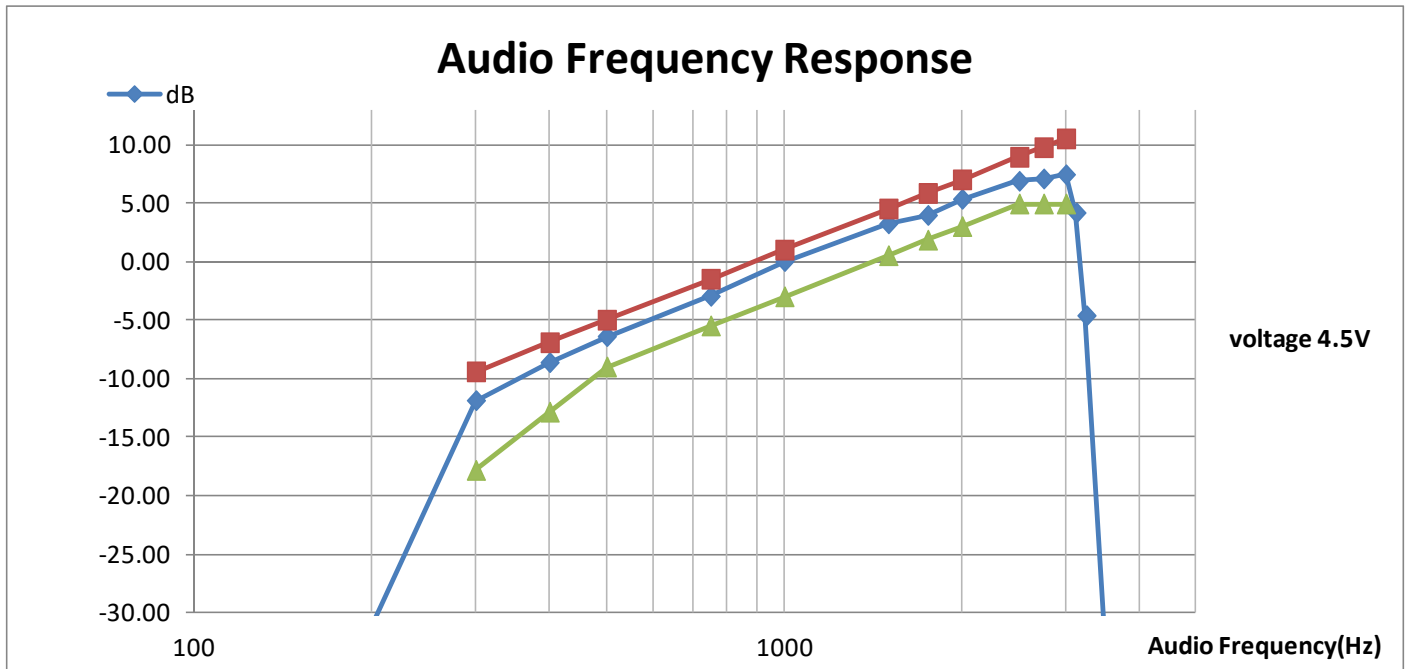

Frequency : 467.6375 MHz 0.5W

voltage		3.6 V	
Temp. (°C)		25	
Audio Frequency(Hz)	dB	HighSide Specs	LowSide Specs
100	-32.44		
200	-32.65		
300	-11.93	-9.4218	-17.8436
400	-8.67	-6.9316	-12.8631
500	-6.42	-5.0000	-9.0000
750	-2.96	-1.4902	-5.4902
1000	0.01	1.0000	-3.0000
1500	3.25	4.5098	0.5098
1750	3.94	5.8441	1.8441
2000	5.32	7.0000	3.0000
2500	6.88	8.9316	4.9316
2750	7.08	9.7566	4.9316
3000	7.44	10.5098	4.9316
3125	4.17		
3250	-4.63		
3500	-32.17		
4000	-32.96		
5000	-32.72		

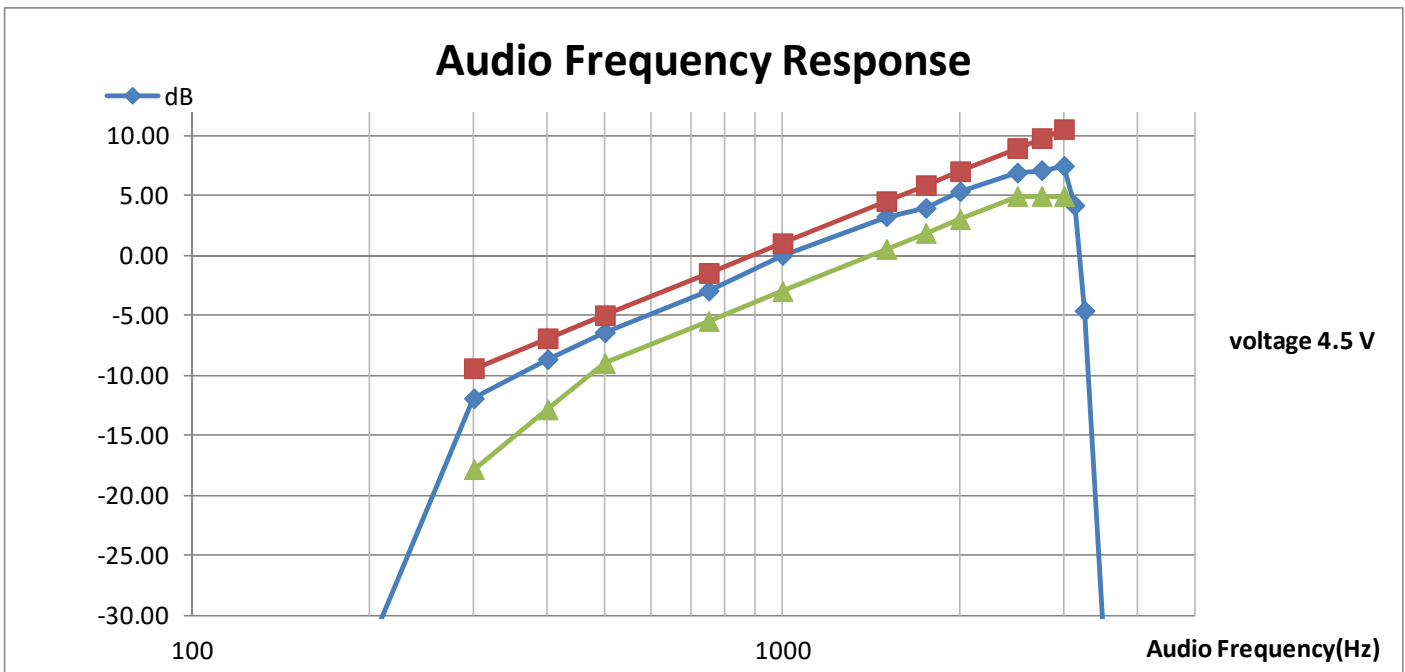

## 6.4. Audio Low Pass Filter

### 6.4.1. Test Setup

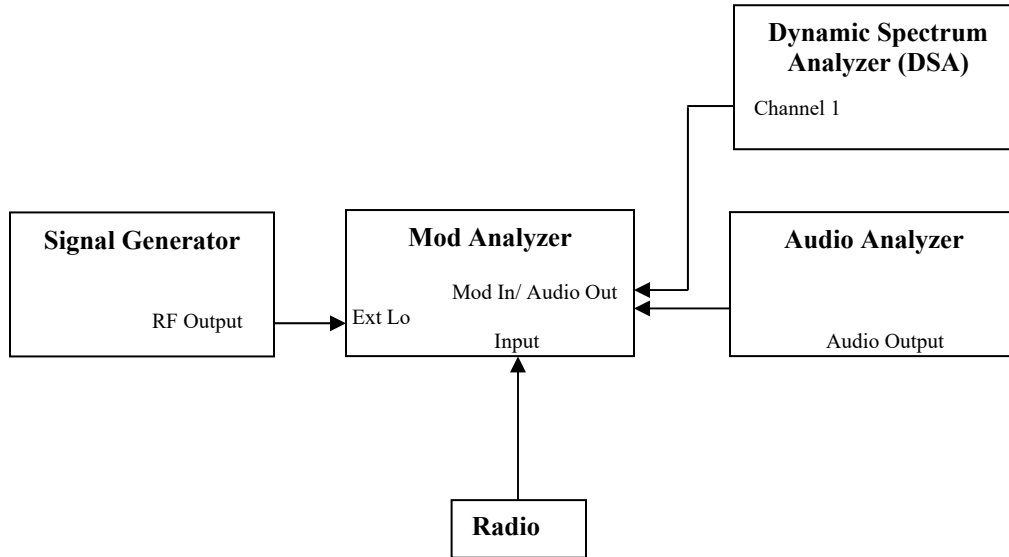

- 1) The DUT transmitter output port was connected to Modulation Analyzer.
- 2) Path loss for the measurement included.
- 3) Press 23.1SPCL on modulation analyzer to enable the external LO from Sigen.
- 4) Set the Sigen frequency to  $F_c + 1.5\text{MHz}$ , RF output level to 0dBm without modulation.
- 5) Transmit the radio and set the audio analyzer to 1 kHz audio frequency and 60% of the maximum deviation.
- 6) Up the amplitude by 20dB.
- 7) On DSA, get the reference point to 0dB.
- 8) Vary the frequency on audio analyzer from 3 kHz to 30 kHz, record the audio tone from DSA.

## 6.4.2. Test Limits:

### §95.1775 GMRS modulation requirements

(e) Audio filter. Each GMRS transmitter type must include audio frequency low pass filtering, unless it complies with the applicable paragraphs of §95.1779 (without filtering).

(1) The filter must be between the modulation limiter and the modulated stage of the transmitter.

(2) At any frequency ( $f$  in kHz) between 3 and 20 kHz, the filter must have an attenuation of at least  $60 \log(f/3)$  dB more than the attenuation at 1 kHz. Above 20 kHz, it must have an attenuation of at least 50 dB more than the attenuation at 1 kHz.

### RSS-210 E.3.3(GMRS) Modulation Requirements

Frequency, $f$ (kHz)	Attenuation Greater Than the Attenuation at 1 kHz (dB)
$3 \leq f \leq 20$	$60 \log_{10}(f/3)$
$f > 20$	50

### 6.4.3. Test Result

This circuit cannot be tested directly as requested by FCC regulation because it is built in the IC BK4815N and not electrically connected to any exterior pins of the IC.

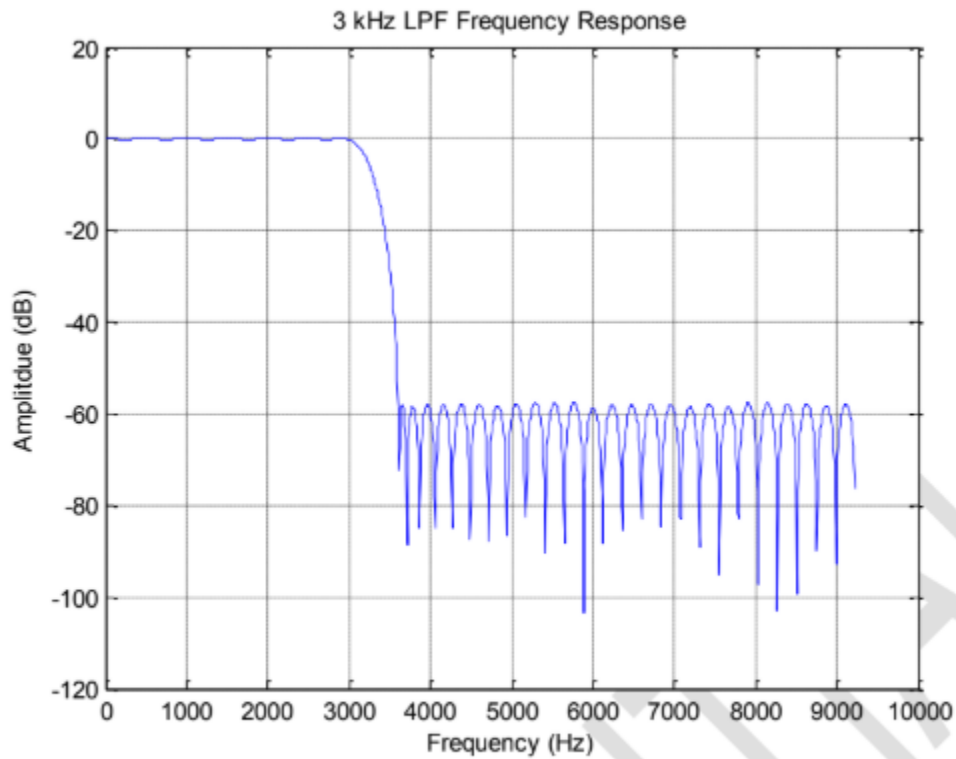
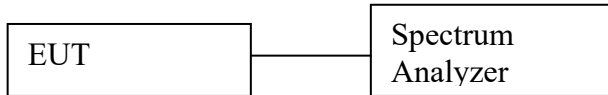

Figure 10. Frequency Response of Low Pass Filter

## 6.5. Frequency Stability

### 6.5.1. Test Setup



- 1) The DUT transmitter output port was connected to Modulation Analyzer.
- 2) Transmit the DUT and record the freq in  $MCF_{MHz}$ .
- 3) Test in 2 conditions: Different Temperature & Supply Voltage input.
  - Temperature: Vary from  $-30^{\circ}C$  to  $+50^{\circ}C$  with Nominal supply voltage.
  - Supply Voltage: Vary  $\pm 15\%$  in room temperature
- 4) Calculate the ppm frequency error by the following:

$$ppm\ error = \left( \frac{MCF_{MHz}}{ACF_{MHz}} - 1 \right) * 10^6$$

Where:  $MCF_{MHz}$  is the Measured Carrier Frequency in MHz  
 $ACF_{MHz}$  is the Assigned Carrier Frequency in MHz

### 6.5.2. Test Limits:

#### §95.565 FRS frequency accuracy

Each FRS transmitter type must be designed such that the carrier frequencies remain within  $\pm 2.5$  parts-per-million of the channel center frequencies specified in §95.563 during normal operating conditions.

#### §95.1765 GMRS frequency accuracy

Each GMRS transmitter type must be designed to comply with the frequency accuracy requirements in this section under normal operating conditions. Operators of GMRS stations must also ensure compliance with these requirements.

- (a) The carrier frequency of each GMRS transmitter transmitting an emission with an occupied bandwidth greater than 12.5 kHz must remain within 5 parts-per-million (ppm) of the channel center frequencies listed in §95.1763 under normal operating conditions.
- (b) The carrier frequency of each GMRS transmitter transmitting an emission with an occupied bandwidth of 12.5 kHz or less must remain within 2.5 ppm of the channel center frequencies listed in §95.1763 under normal operating conditions.

### 6.5.3. Test Result

(i) Frequency Stability VS Voltage

Frequency / Channel Spacing	462.63750 MHz / 12.5 kHz				
Temperature, °C	25				
Voltage %	Voltage, V	Frequency, MHz	Frequency Stability, PPM	Spec (low) PPM	Spec (high) PPM
-20	3.600	462.637540	0.086	-0.700	0.700
-15	3.825	462.637540	0.086	-0.700	0.700
-10	4.050	462.637540	0.086	-0.700	0.700
-5	4.275	462.637540	0.086	-0.700	0.700
0	4.500	462.637540	0.086	-0.700	0.700
5	4.725	462.637550	0.108	-0.700	0.700
10	4.950	462.637550	0.108	-0.700	0.700
15	5.175	462.637550	0.108	-0.700	0.700
20	5.400	462.637540	0.086	-0.700	0.700

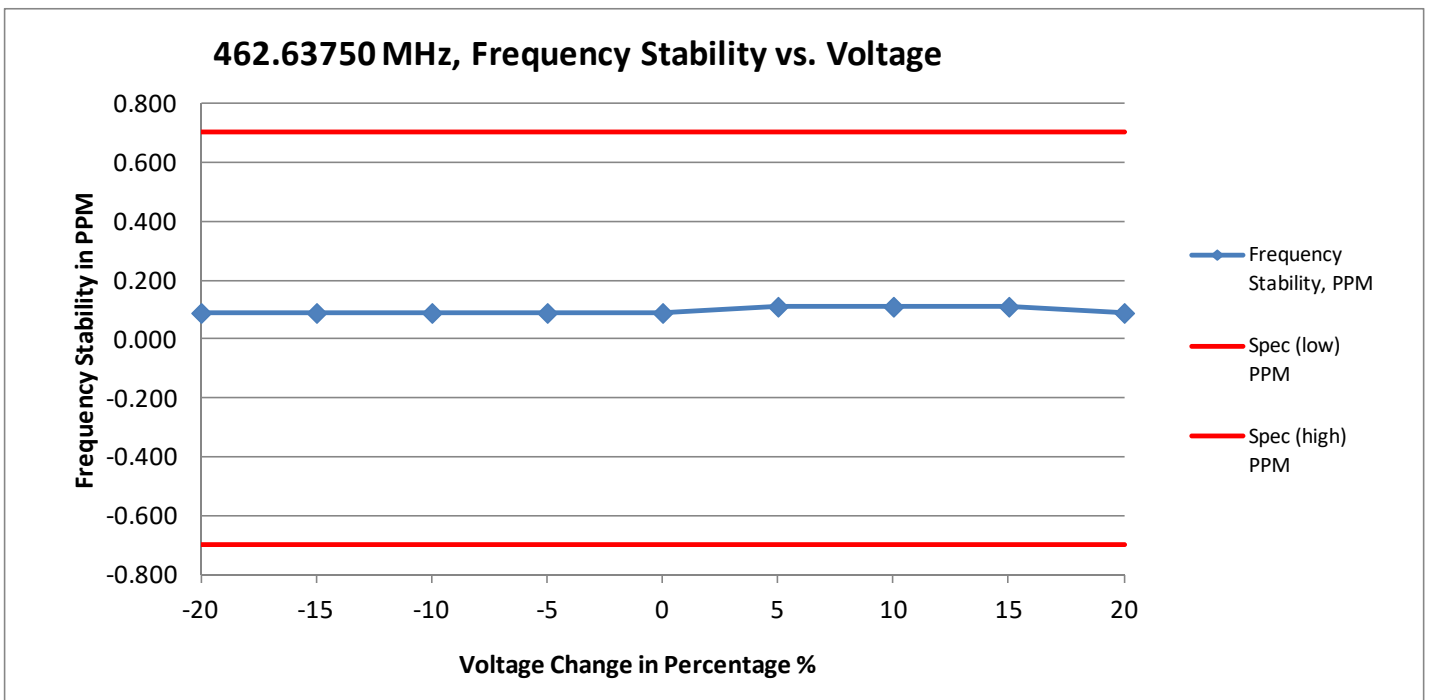



(ii) Frequency Stability VS temperature

Frequency / Channel Spacing	462.63750 MHz / 12.5 kHz			
Voltage, V	7.5			
Temperature, °C	Frequency, MHz	Frequency Stability, PPM	Spec (low) PPM	Spec (high) PPM
-30	462.637530	0.065	-0.700	0.700
-20	462.637530	0.065	-0.700	0.700
-10	462.637530	0.065	-0.700	0.700
0	462.637560	0.130	-0.700	0.700
10	462.637540	0.086	-0.700	0.700
20	462.637540	0.086	-0.700	0.700
30	462.637550	0.108	-0.700	0.700
40	462.637490	-0.022	-0.700	0.700
50	462.637490	-0.022	-0.700	0.700
60	462.637540	0.086	-0.700	0.700

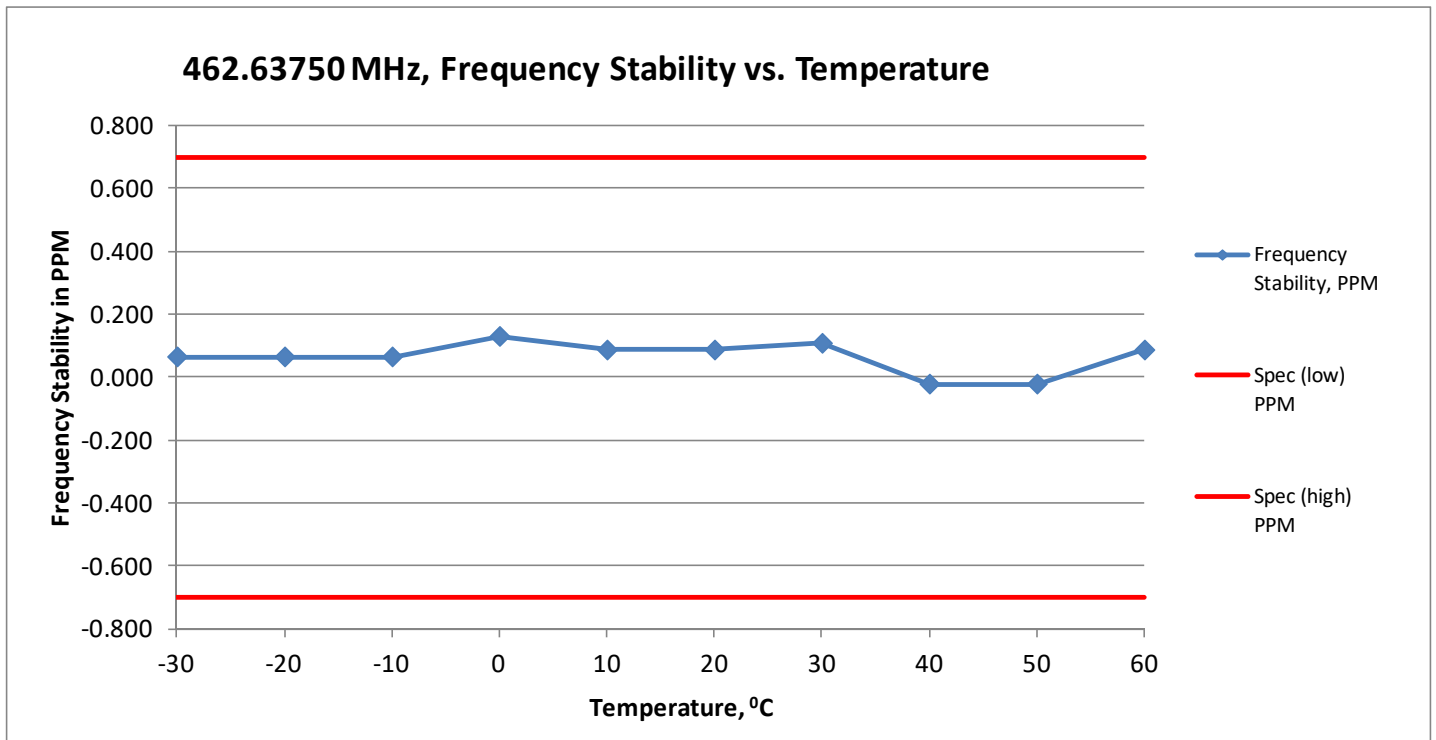

(i) Frequency Stability VS Voltage

Frequency / Channel Spacing	467.63750 MHz / 12.5 kHz				
Temperature, °C	25				
Voltage %	Voltage, V	Frequency, MHz	Frequency Stability, PPM	Spec (low) PPM	Spec (high) PPM
-20	3.600	467.637490	-0.021	-0.700	0.700
-15	3.825	467.637500	0.000	-0.700	0.700
-10	4.050	467.637500	0.000	-0.700	0.700
-5	4.275	467.637500	0.000	-0.700	0.700
0	4.500	467.637520	0.043	-0.700	0.700
5	4.725	467.637510	0.021	-0.700	0.700
10	4.950	467.637520	0.043	-0.700	0.700
15	5.175	467.637510	0.021	-0.700	0.700
20	5.400	467.637500	0.000	-0.700	0.700

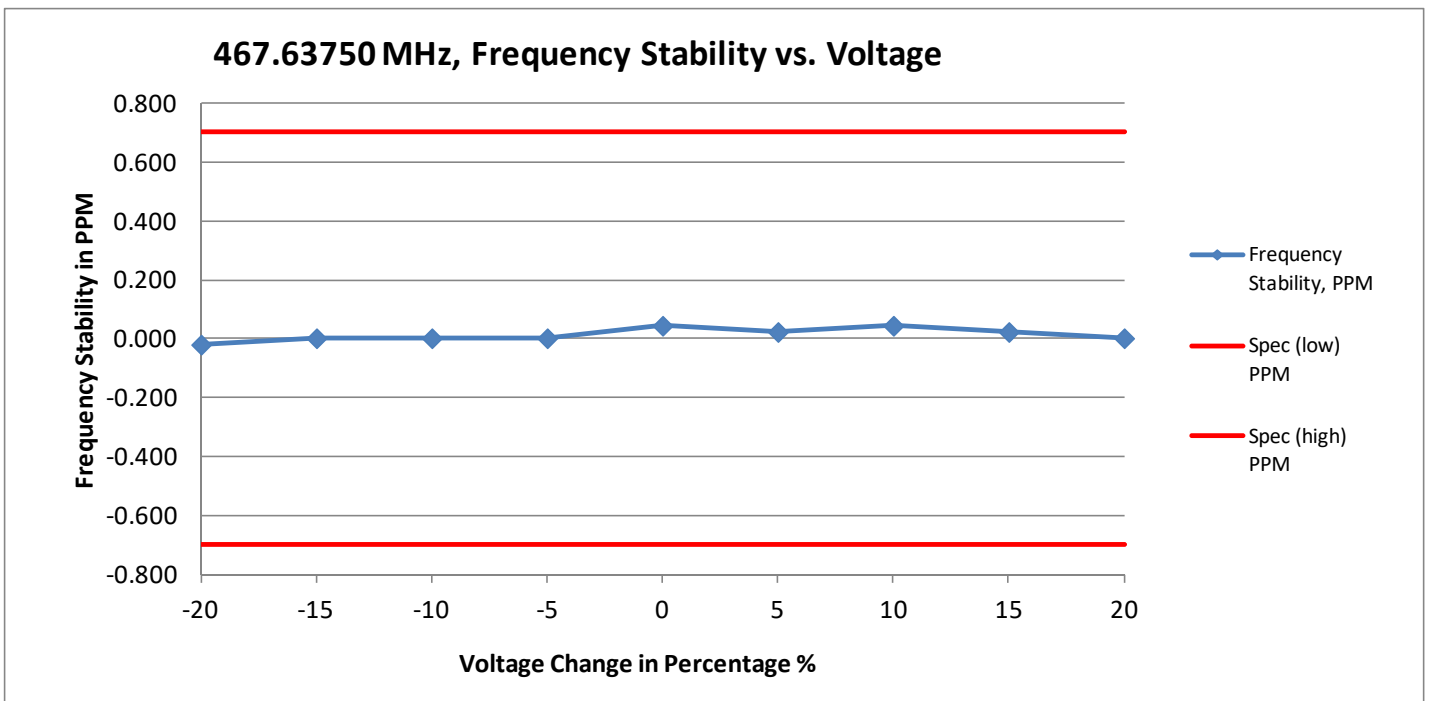

(ii) Frequency Stability VS temperature

Frequency / Channel Spacing	467.63750 MHz / 12.5 kHz			
Voltage, V	7.5			
Temperature, °C	Frequency, MHz	Frequency Stability, PPM	Spec (low) PPM	Spec (high) PPM
-30	467.637560	0.128	-0.700	0.700
-20	467.637570	0.150	-0.700	0.700
-10	467.637550	0.107	-0.700	0.700
0	467.637540	0.086	-0.700	0.700
10	467.637540	0.086	-0.700	0.700
20	467.637530	0.064	-0.700	0.700
30	467.637530	0.064	-0.700	0.700
40	467.637540	0.086	-0.700	0.700
50	467.637480	-0.043	-0.700	0.700
60	467.637480	-0.043	-0.700	0.700

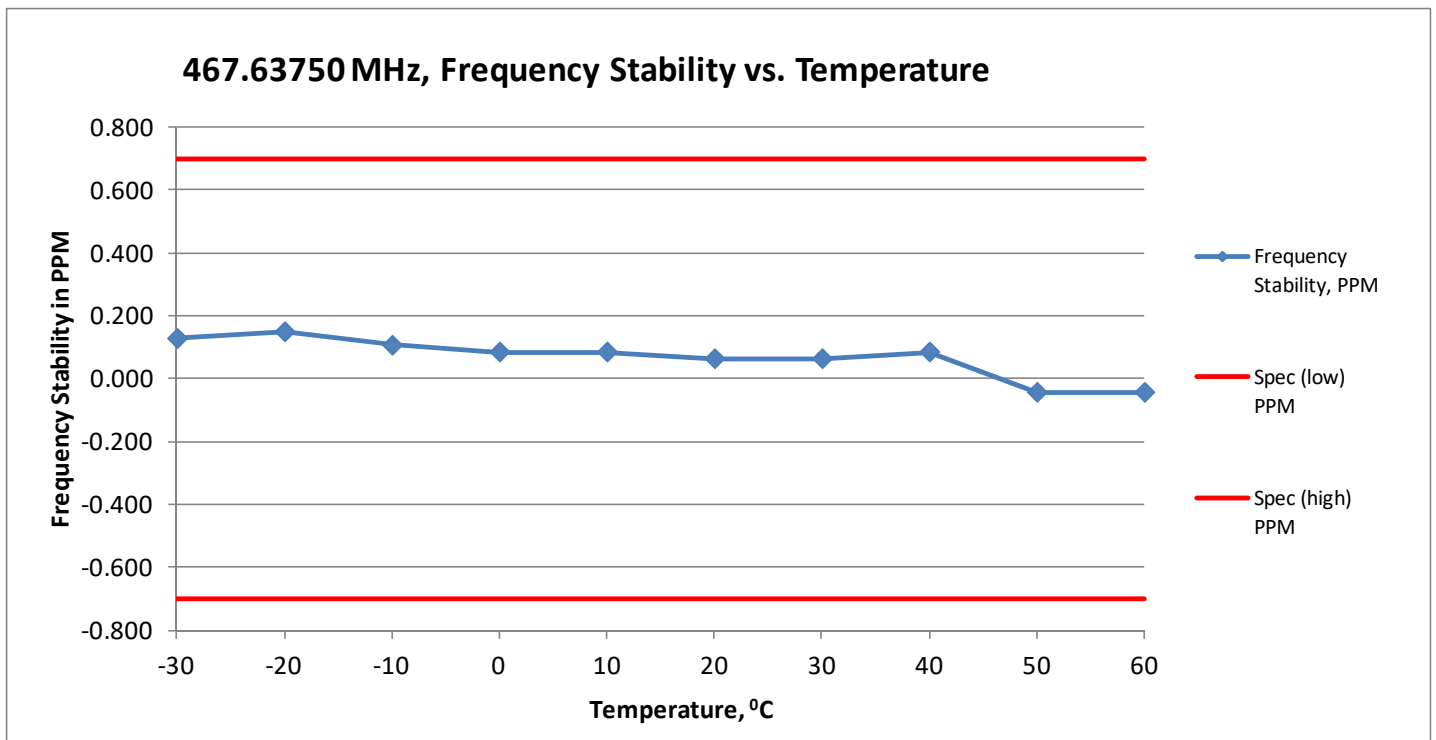

## 6.6. Emission Mask

### 6.6.1. Test Setup

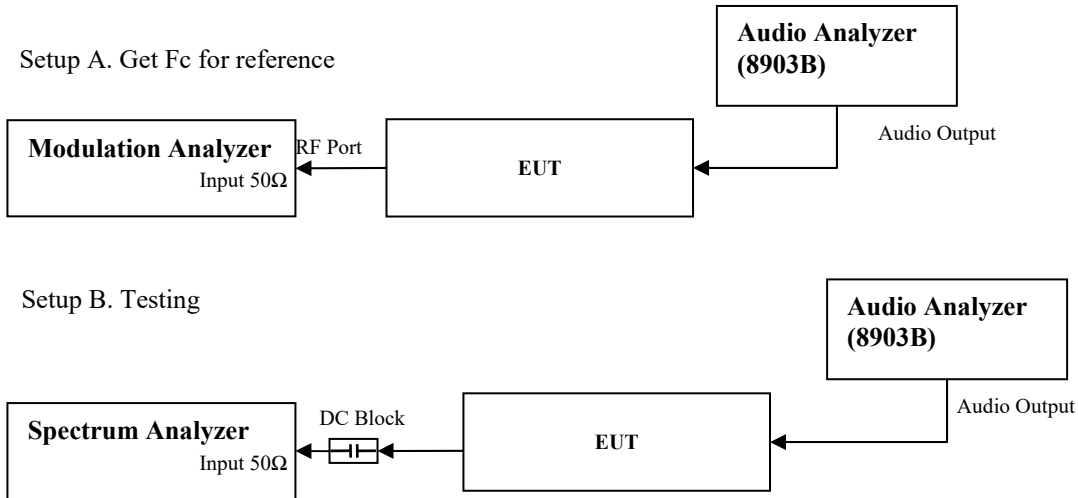

- 1) The DUT transmitter output port was connected to Modulation Analyzer.
- 2) Path loss for the measurement included.
- 3) Key in the Fc to assigned center frequency with the span 100 kHz.
- 4) Set the spectrum analyzer with RBW= 300Hz and VBW= 900Hz.
- 5) Transmit the UUT and record the result.
- 6) Set modulation analyzer audio bandwidth filter to 15 kHz low pass filter and 50 kHz high pass filter.
- 7) Transmit the radio and set the audio analyzer to 2.5 kHz audio frequency and 60% of the maximum deviation.
- 8) Up the amplitude by 16dB and remove the audio tone from audio analyzer.
- 9) Capture the screen shot with and without modulation.

## 6.6.2. Test Limits:

### §95.579 FRS unwanted emissions limits

Each FRS transmitter type must be designed to satisfy the applicable unwanted emissions limits in this paragraph.

(a) Attenuation requirements. The power of unwanted emissions must be attenuated below the carrier power output in Watts (P) by at least:

(1) 25 dB (decibels) in the frequency band 6.25 kHz to 12.5 kHz removed from the channel center frequency.

(2) 35 dB in the frequency band 12.5 kHz to 31.25 kHz removed from the channel center frequency.

(3)  $43 + 10 \log (P)$  dB in any frequency band removed from the channel center frequency by more than 31.25 kHz.

(b) Measurement bandwidths. The power of unwanted emissions in the frequency bands specified in paragraphs (a)(1) and (2) of this section is measured with a reference bandwidth of 300 Hz. The power of unwanted emissions in the frequency range specified in paragraph (a)(3) is measured with a reference bandwidth of at least 30 kHz.

(c) Measurement conditions. The requirements in this section apply to each FRS transmitter type both with and without the connection of permitted attachments, such as an external speaker, microphone and/or power cord.

### §95.1779 GMRS unwanted emissions limits (1), (2), (7)

Each GMRS transmitter type must be designed to comply with the applicable unwanted emissions limits in this section.

(a) Emission masks. Emission masks applicable to transmitting equipment in the GMRS are defined by the requirements in the following table. The numbers in the attenuation requirements column refer to rule paragraph numbers under paragraph (b) of this section.

Emission types filter	Attenuation requirements
A1D, A3E, F1D, G1D, F2D, F3E, G3E with audio filter	(1), (2), (7)
A1D, A3E, F1D, G1D, F3E, G3E without audio filter	(3), (4), (7)
H1D, J1D, R1D, H3E, J3E, R2E	(5), (6), (7)

(1) Filtering noted for GMRS transmitters refers to the requirement in §95.1775(e).

(2) Unwanted emission power may be measured as either mean power or peak envelope power, provided that the transmitter output power is measured the same way.

(b) Attenuation requirements. The power of unwanted emissions must be attenuated below the transmitter output power in Watts (P) by at least:

(1) 25 dB (decibels) on any frequency removed from the center of the authorized bandwidth by more than 50% up to and including 100% of the authorized bandwidth.

(2) 35 dB on any frequency removed from the center of the authorized bandwidth by more than 100% up to and including 250% of the authorized bandwidth.

(3)  $83 \log (fd \div 5)$  dB on any frequency removed from the center of the authorized bandwidth by a displacement frequency (fd in kHz) of more than 5 kHz up to and including 10 kHz.

- (4)  $116 \log (f_d \div 6.1)$  dB or  $50 + 10 \log (P)$  dB, whichever is the lesser attenuation, on any frequency removed from the center of the authorized bandwidth by a displacement frequency ( $f_d$  in kHz), of more than 10 kHz up to and including 250% of the authorized bandwidth.
- (5) 25 dB on any frequency removed from the center of the authorized bandwidth by more than 50% up to and including 150% of the authorized bandwidth.
- (6) 35 dB on any frequency removed from the center of the authorized bandwidth by more than 150% up to and including 250% of the authorized bandwidth.
- (7)  $43 + 10 \log (P)$  dB on any frequency removed from the center of the authorized bandwidth by more than 250%.
- (c) Measurement bandwidths. The power of unwanted emissions in the frequency bands specified in paragraphs (b)(1) through (4) of this section is measured with a reference bandwidth of 300 Hz. The power of unwanted emissions in the frequency range specified in paragraph (b)(5) of this section is measured with a reference bandwidth of at least 30 kHz.
- (d) Measurement conditions. The requirements in this section apply to each GMRS transmitter type both with and without the connection of permitted attachments, such as an external speaker, microphone, power cord and/or antenna.

### 6.6.3. Test Data

#### **BANDWIDTH CALCULATIONS:**

Carson's Rule for FM modulation is utilized to compute the bandwidth shown in the FCC emission designator. Carson's Rule is:

$$BW = 2 * (M + D)$$

where: BW = Bandwidth  
M = Maximum modulating frequency  
D = Deviation

#### **Standard Audio Modulation (12.5 kHz Channelization, Analog Voice):**

Emission Designator 11K0F3E

In this case, the maximum modulating frequency is 3.0 kHz with a 2.5 kHz deviation.

$$BW = 2(M+D) = 2*(3.0 \text{ kHz} + 2.5 \text{ kHz}) = 11 \text{ kHz} \rightarrow 11K0$$

F3E portion of the designator indicates voice.

Therefore, the entire designator for 12.5 kHz channelization analog voice is 11K0F3E.

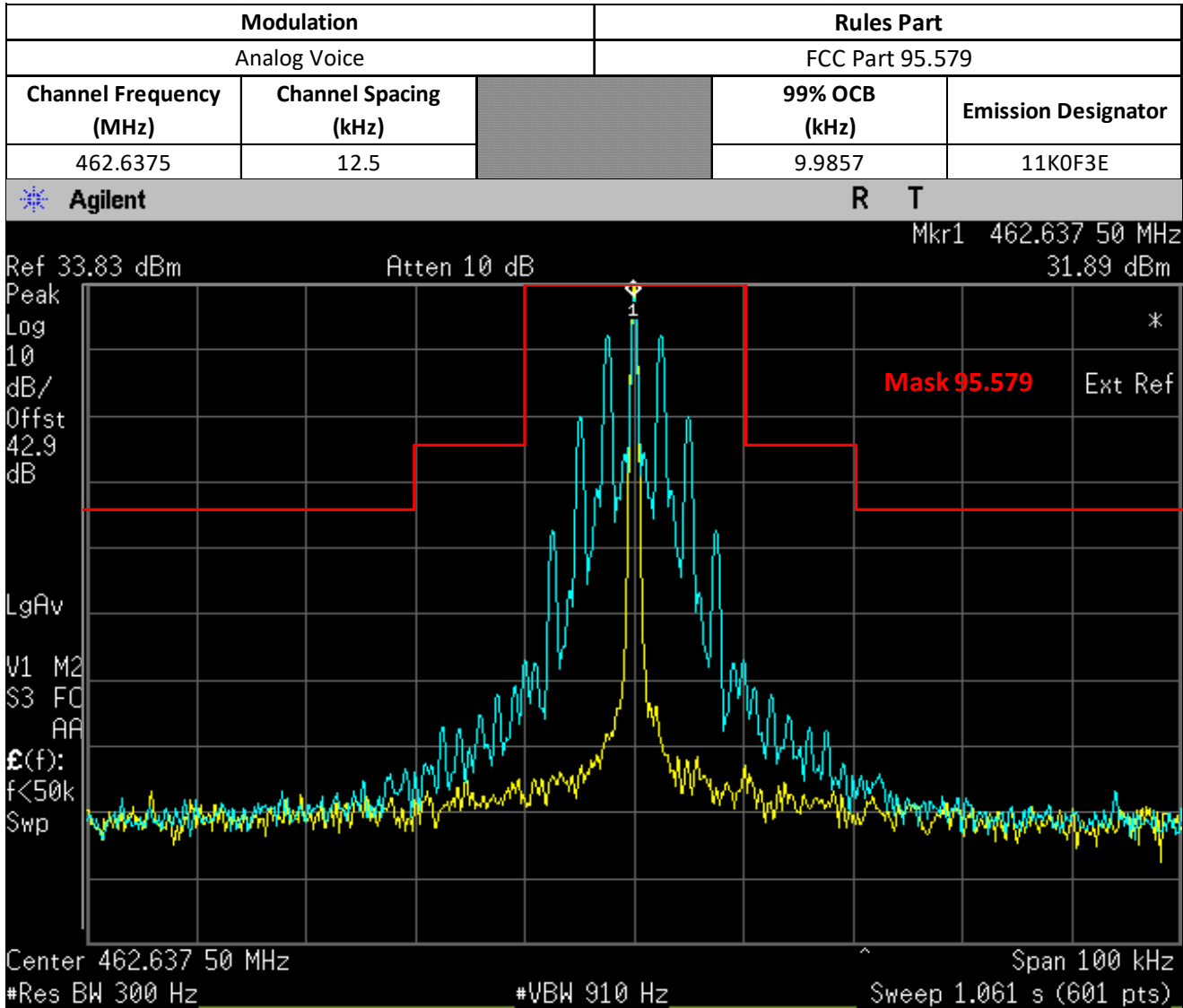



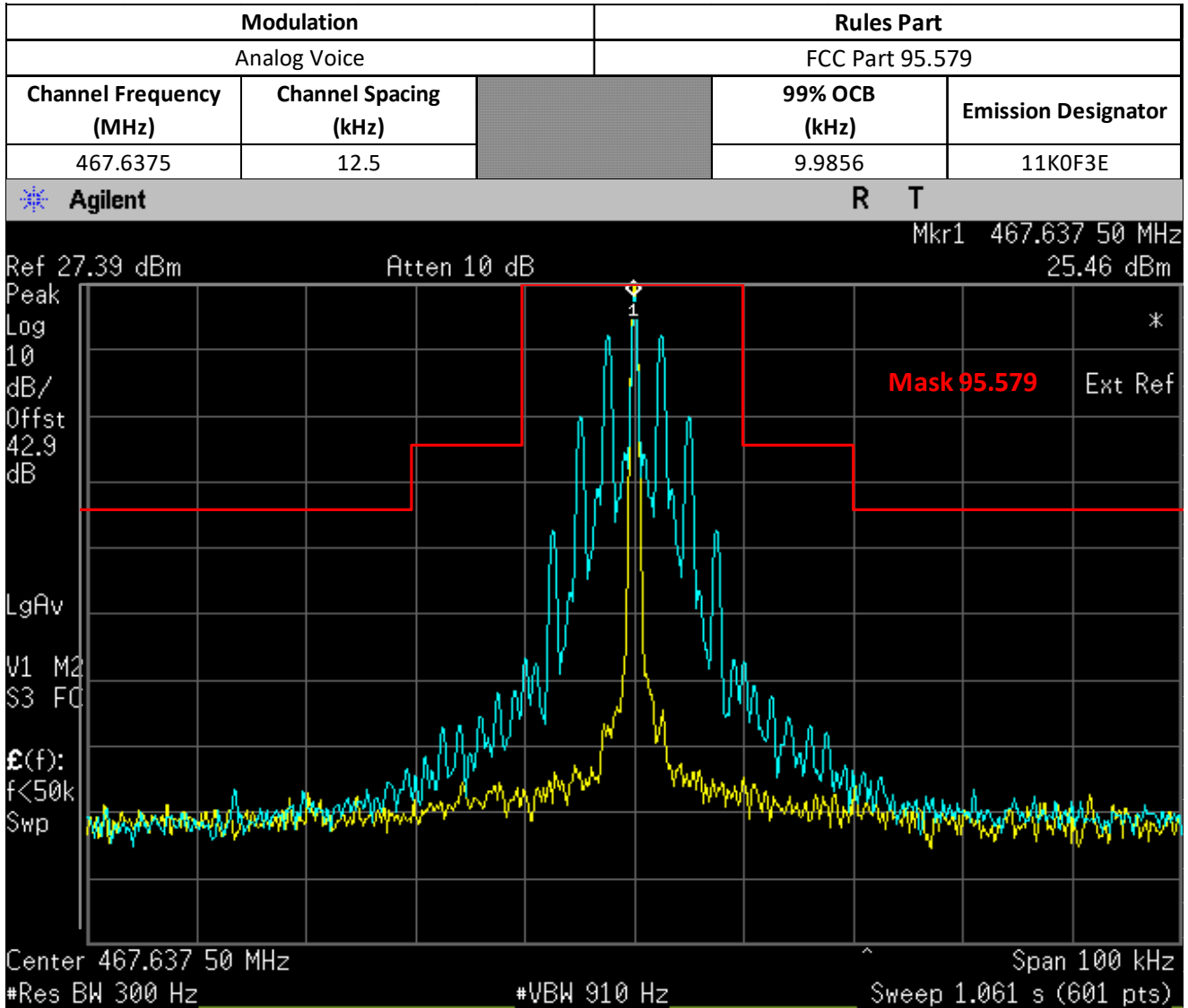

## 6.7. Radiated Spurious Emission

### 6.7.1. Test Setup

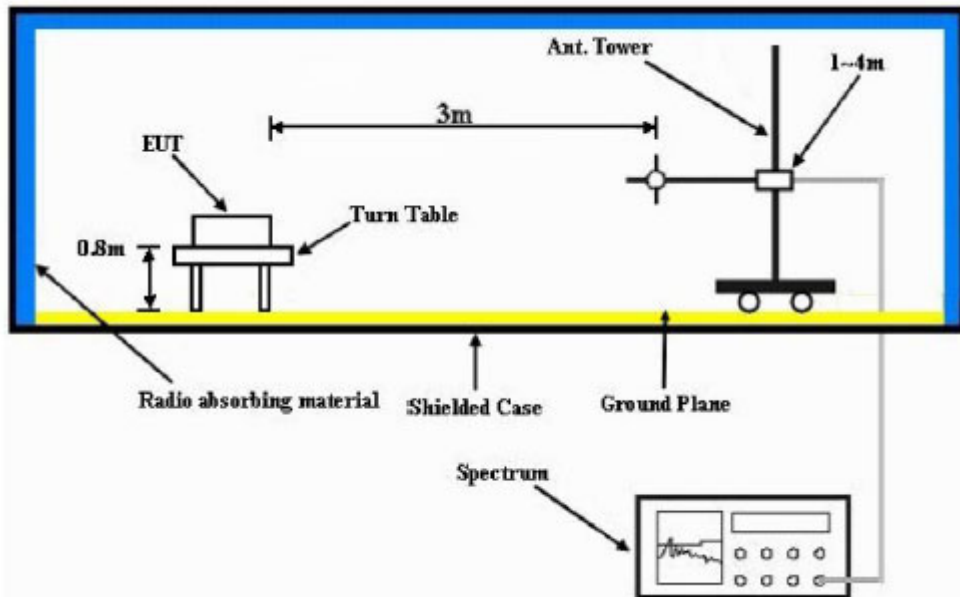

- 1) The spectrum setting for scanning Radiated Emission below 1 GHz is RBW = 100 kHz, VBW = 300 kHz and above 1 GHz is RBW = 1 MHz, VBW = 3 MHz. Detector mode is positive peak.
- 2) In the semi-anechoic chamber, setup as illustrated above the EUT placed on the 0.8m height (for frequencies < 1GHz) or 1.5m (for frequencies > 1GHz) of Turn Table, rotated the table around 360 degrees to search the maximum radiation power and receiver antenna shall be rotated vertical and horizontal polarization and moved height from 1m to 4m to find the maximum polar radiated power. The “Read Value” is the spectrum reading the maximum power value.
- 3) The substitution antenna is substituted for EUT at the same position and signals generator (S.G) export the CW signal to the substitution antenna via a TX cable. The receiver antenna shall be rotated vertical and horizontal polarization and moved height from 1m to 4m to find the maximum radiation power. Record the power level of maximum radiation power from spectrum. So, the measured substitution value = Ref level of S.G + TX cables loss – Substituted Antenna Gain.
- 4) Final Radiated Spurious Emission = “Read Value” + Measured substitution value.

### 6.7.2. Test Result

**SAC Transmitter Radiated Emission:**

Model Number: T6B22201GWRAAW      S/N: 17520YX0006      SR:35850-EMC-00004  
 Battery Part No: PMNN4477A      Accy Part No: NA  
 Test Mode: TX Analog  
 462.637500 MHz      12.5 kHz      2.000 Watt(s) /Max Power

Frequency (MHz)	Limit	Horizontal Measured Emission Equiv Pwr Into Ideal Dipole (dBm)	Vertical Measured Emission Equiv Pwr Into ideal Dipole (dBm)
462.3428	-13.0000	-37.9400 *	-20.8800
462.9375	-13.0000	-37.8300 *	-20.8700
925.2750	-13.0000	-74.8428 **	-74.5983 **
1387.9125	-13.0000	-53.4900 *	-56.1200 *
1850.5500	-13.0000	-45.5400 *	-53.4600 *
2313.1875	-13.0000	-47.7400 *	-50.0600 *
2775.8250	-13.0000	-46.5700 *	-49.0800 *
3238.4625	-13.0000	-47.2400 *	-46.6800 *
3701.1000	-13.0000	-46.3900 *	-47.0000 *
4163.7375	-13.0000	-47.9027 **	-48.9685 **
4626.3751	-13.0000	-44.3400 *	-44.2900 *

#### RADIATED SPURIOUS EMISSIONS

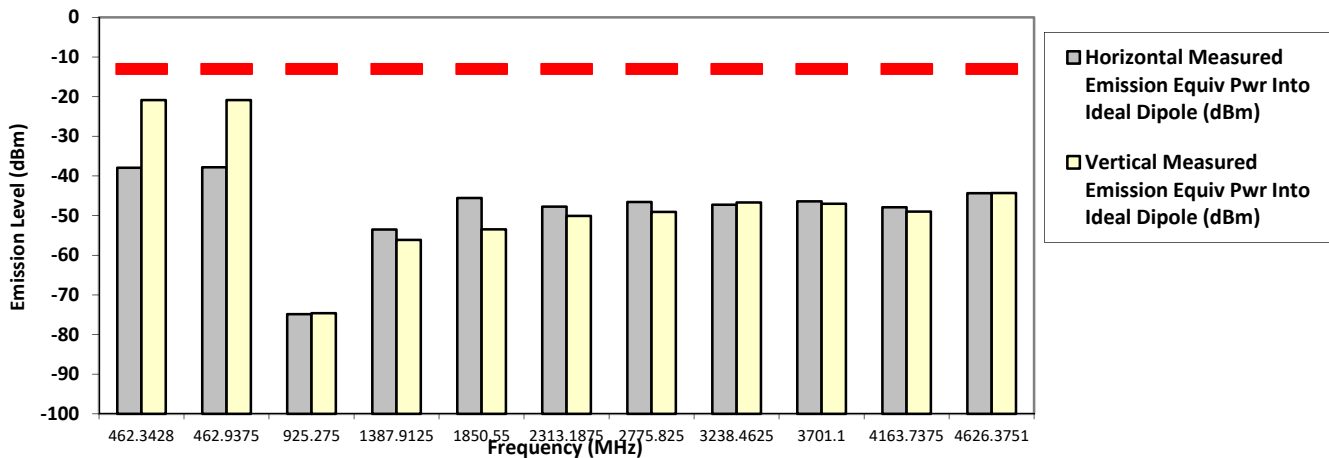

The data presented here was taken using the substitution method as found in the ANSI C63.26-2015 document.  
 Motorola Penang EMC Lab - Test Performed by: Qawiman&Nazrin      Fri, 9 Dec, 2022

Remarks: \*\* Indicates the spurious emission could not be detected due to noise limitations or ambient.

\*Pursuant to CFR 47 Part 2.1057 ( c ), emissions attenuated more than 20 dB below the permissible limit are not reported  
 Temp(Deg): 23.5 Hum(%RH): 69.7

System MU: 4.03 dB

Remarks: Passed Results Marginal Results Failed Results

**SAC Transmitter Radiated Emission:**

Model Number: T6B22201GWRAAW      S/N: 17520YX0006      SR:35850-EMC-00004  
 Battery Part No: PMNN4477A      Accy Part No: NA  
 Test Mode: TX Analog  
 467.637500 MHz      12.5 kHz      0.500 Watt(s) /Max Power

Frequency (MHz)	Limit	Horizontal Measured Emission Equiv Pwr Into Ideal Dipole (dBm)	Vertical Measured Emission Equiv Pwr Into ideal Dipole (dBm)
467.2928	-13.0000	-40.5300 *	-23.9100
468.0021	-13.0000	-40.9000 *	-23.4700
935.2750	-13.0000	-74.7219 **	-75.2973 **
1402.9125	-13.0000	-56.1100 *	-54.9200 *
1870.5500	-13.0000	-46.9400 *	-53.3300 *
2338.1875	-13.0000	-47.2600 *	-50.2700 *
2805.8250	-13.0000	-47.7800 *	-48.6600 *
3273.4625	-13.0000	-40.8100 *	-46.8200 *
3741.1000	-13.0000	-48.1165 **	-49.2787 **
4208.7375	-13.0000	-48.8124 **	-48.7753 **
4676.3750	-13.0000	-47.8554 **	-48.3003 **

**RADIATED SPURIOUS EMISSIONS**

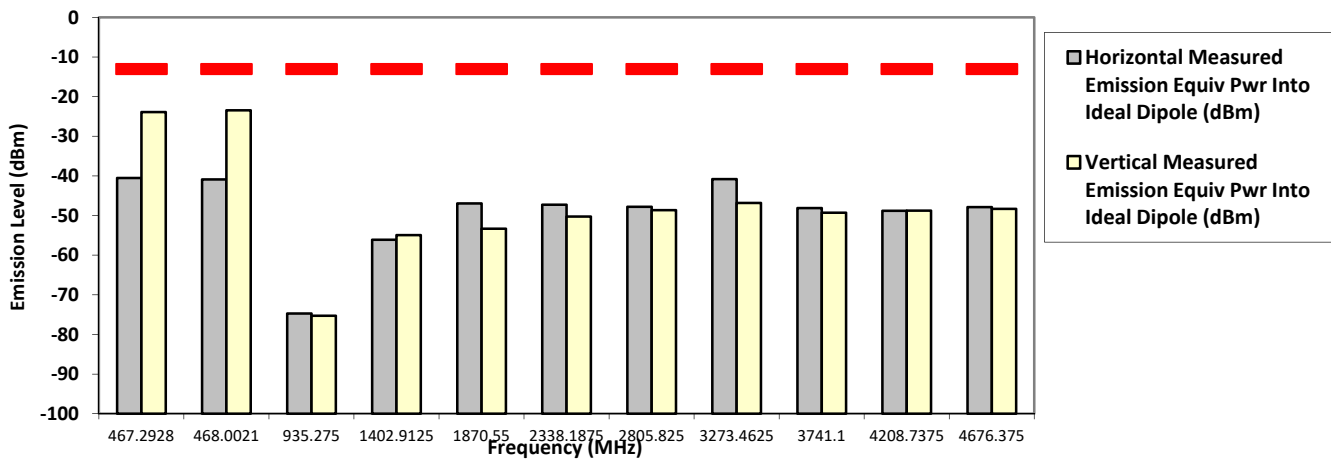

The data presented here was taken using the substitution method as found in the ANSI C63.26-2015 document.  
 Motorola Penang EMC Lab - Test Performed by: Qawiman&Nazrin      Fri, 9 Dec, 2022

Remarks: \*\* Indicates the spurious emission could not be detected due to noise limitations or ambient.  
 \*Pursuant to CFR 47 Part 2.1057 ( c ), emissions attenuated more than 20 dB below the permissible limit are not reported  
 Temp(Deg): 23.5 Hum(%RH): 69.7

System MU: 4.03 dB

Remarks:

Passed Results	Marginal Results	Failed Results
----------------	------------------	----------------

**SAC Transmitter Radiated Emission:**  
**Model Number: T6B22201GWRAAW**      **S/N: 17520YX0007**      **SR:35850-EMC-00010**  
**Battery Part No: AA Alkaline**      **Accy Part No: PMKN4296A-CF1, Laptop AH422508**  
**Test Mode: TX Analog**  
**462.637500 MHz**      **12.5 kHz**      **2.000 Watt(s) /Max Power**

Frequency (MHz)	Limit	Horizontal Measured Emission Equiv Pwr Into Ideal Dipole (dBm)	Vertical Measured Emission Equiv Pwr Into ideal Dipole (dBm)
462.3128	-13.0000	-24.1300	-17.5500
462.9522	-13.0000	-24.3200	-17.8000
925.2750	-13.0000	-75.4546 **	-75.2476 **
1387.9125	-13.0000	-56.7726 **	-56.1854 **
1850.5500	-13.0000	-38.1800 *	-39.7200 *
2313.1875	-13.0000	-53.0369 **	-51.4860 **
2775.8250	-13.0000	-49.4779 **	-50.1170 **
3238.4625	-13.0000	-43.4500 *	-42.4700 *
3701.1000	-13.0000	-42.8900 *	-44.3600 *
4163.7375	-13.0000	-48.5510 **	-49.1314 **
4626.3750	-13.0000	-49.0579 **	-49.3334 **

**RADIATED SPURIOUS EMISSIONS**

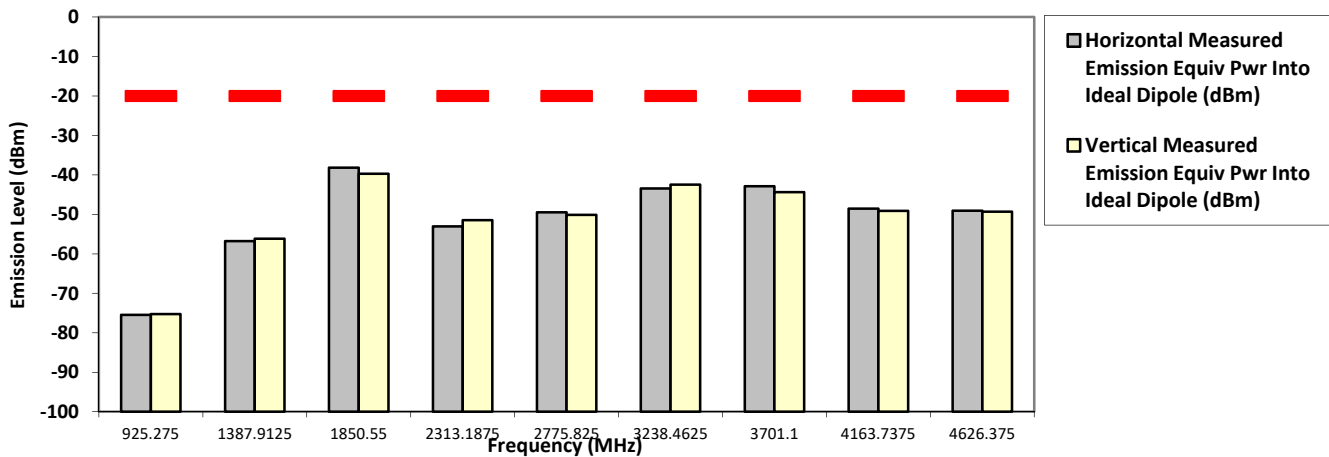

The data presented here was taken using the substitution method as found in the ANSI C63.26-2015 document.  
 Motorola Penang EMC Lab - Test Performed by: Qawiman&Aiman      Tue, 13 Dec, 2022

Remarks: \*\* Indicates the spurious emission could not be detected due to noise limitations or ambient.  
 \*Pursuant to CFR 47 Part 2.1057 ( c ), emissions attenuated more than 20 dB below the permissible limit are not reported  
 Temp(Deg): 23.4 Hum(%RH): 70.2

System MU: 4.03 dB

Remarks:

Passed Results	Marginal Results	Failed Results
----------------	------------------	----------------

### 6.7.3. Test limit

At least  $43 + 10 \log_{10}(T)$  dB on any frequency removed from the center of the authorized bandwidth by more than 250%.

#### §95.579 FRS unwanted emissions limits

Each FRS transmitter type must be designed to satisfy the applicable unwanted emissions limits in this paragraph.

- (a) Attenuation requirements. The power of unwanted emissions must be attenuated below the carrier power output in Watts (P) by at least:
- (1) 25 dB (decibels) in the frequency band 6.25 kHz to 12.5 kHz removed from the channel center frequency.
  - (2) 35 dB in the frequency band 12.5 kHz to 31.25 kHz removed from the channel center frequency.
  - (3)  $43 + 10 \log(P)$  dB in any frequency band removed from the channel center frequency by more than 31.25 kHz.
- (b) Measurement bandwidths. The power of unwanted emissions in the frequency bands specified in paragraphs (a)(1) and (2) of this section is measured with a reference bandwidth of 300 Hz. The power of unwanted emissions in the frequency range specified in paragraph (a)(3) is measured with a reference bandwidth of at least 30 kHz.
- (c) Measurement conditions. The requirements in this section apply to each FRS transmitter type both with and without the connection of permitted attachments, such as an external speaker, microphone and/or power cord.

#### §95.1779 GMRS unwanted emissions limits (1), (2), (7)

Each GMRS transmitter type must be designed to comply with the applicable unwanted emissions limits in this section.

- (a) Emission masks. Emission masks applicable to transmitting equipment in the GMRS are defined by the requirements in the following table. The numbers in the attenuation requirements column refer to rule paragraph numbers under paragraph (b) of this section.

Emission types filter	Attenuation requirements
A1D, A3E, F1D, G1D, F2D, F3E, G3E with audio filter	(1), (2), (7)
A1D, A3E, F1D, G1D, F3E, G3E without audio filter	(3), (4), (7)
H1D, J1D, R1D, H3E, J3E, R2E	(5), (6), (7)

- (1) Filtering noted for GMRS transmitters refers to the requirement in §95.1775(e).
- (2) Unwanted emission power may be measured as either mean power or peak envelope power, provided that the transmitter output power is measured the same way.
- (b) Attenuation requirements. The power of unwanted emissions must be attenuated below the transmitter output power in Watts (P) by at least:
- (1) 25 dB (decibels) on any frequency removed from the center of the authorized bandwidth by more than 50% up to and including 100% of the authorized bandwidth.

(2) 35 dB on any frequency removed from the center of the authorized bandwidth by more than 100% up to and including 250% of the authorized bandwidth.

(3)  $83 \log (fd \div 5)$  dB on any frequency removed from the center of the authorized bandwidth by a displacement frequency ( $fd$  in kHz) of more than 5 kHz up to and including 10 kHz.

(4)  $116 \log (fd \div 6.1)$  dB or  $50 + 10 \log (P)$  dB, whichever is the lesser attenuation, on any frequency removed from the center of the authorized bandwidth by a displacement frequency ( $fd$  in kHz), of more than 10 kHz up to and including 250% of the authorized bandwidth.

(5) 25 dB on any frequency removed from the center of the authorized bandwidth by more than 50% up to and including 150% of the authorized bandwidth.

(6) 35 dB on any frequency removed from the center of the authorized bandwidth by more than 150% up to and including 250% of the authorized bandwidth.

(7)  $43 + 10 \log (P)$  dB on any frequency removed from the center of the authorized bandwidth by more than 250%.

(c) Measurement bandwidths. The power of unwanted emissions in the frequency bands specified in paragraphs (b)(1) through (4) of this section is measured with a reference bandwidth of 300 Hz. The power of unwanted emissions in the frequency range specified in paragraph (b)(5) of this section is measured with a reference bandwidth of at least 30 kHz.

(d) Measurement conditions. The requirements in this section apply to each GMRS transmitter type both with and without the connection of permitted attachments, such as an external speaker, microphone, power cord and/or antenna.

End of Test Report -