 <p>CERTIFICATE 2518.08</p> <p>MS ISO/IEC 17025 TESTING SAMM NO. 0825</p>
<p><b>MOTOROLA PENANG ADV. COMM. LABORATORY</b>                  Motorola Solutions Malaysia SDN BHD                  Plot 2A, Medan Bayan Lepas,                  Mukim 12 S.W.D., 11900 Bayan Lepas,                  Penang, Malaysia.</p>	<p><b>FCC TEST REPORT</b>  <b>Report Revision : Rev.A</b></p>
<p><b>Date/s Tested</b> : 25-JUL-2020 - 02-AUG-2020  <b>Report Issue Date</b> : 14-AUG-2020  <b>Manufacturer/Location</b> : Motorola Solutions Malaysia SDN BHD                  Plot 2A, Medan Bayan Lepas, Mukim 12 S.W.D.,                  11900 Bayan Lepas, Penang, Malaysia  <b>Requestor</b> : WONG SONG KUI  <b>Product Type</b> : Portable  <b>Model Number</b> : T21X  <b>Frequency Band</b> : 462-468 MHz  <b>Max. Output Power</b> : 0.5W ERP  <b>Firmware Version</b> : 002  <b>Applicant Name</b> : Motorola Solutions Inc  <b>Applicant Address</b> : 8000 West Sunrise Boulevard, Fort Lauderdale, Florida                  33322.  <b>FCC Registration</b> : 461337  <b>IC Registrations</b> : MY0001</p> <p><b>The equipment was tested accordance to the requirement listed below:</b></p> <p><b>FCC 47 CFR Part 95</b> <span style="float: right;"><b>PASS</b></span></p>	
<p>This report shall not be reproduced without written approval from an officially designated representative of the Motorola Penang Adv. Comm. Laboratory. The results and statements contained in this report pertain only to the device(s) evaluated.</p>	
<p>Prepared By:</p>  <hr/> <p><b>Gan Boon Teong</b>  <b>Test Personnel</b></p>	<p>Approved Signatory :</p> <hr/> <p><b>VINCENT FOONG CHUEN KIT</b>  <b>Deputy Technical Manager</b></p>

## Table of Contents

1.0. General Information .....	3
2.0. Summary of Test Results.....	4
3.0. Measurement Uncertainty .....	4
4.0. Equipment List .....	5
5.0. Test Mode Applicability and Test Channel Detail .....	8
6.0. Transmitter Test Parameters.....	9
6.1. Maximum Output Power .....	9
6.1.1. Test Setup .....	9
6.1.2. Test Limits .....	10
6.1.3. Test Data .....	11
6.2. Modulation Limiting .....	12
6.2.1. Test Setup .....	12
6.2.2. Test Limits .....	13
6.2.3. Test Result .....	14
6.3. Audio Frequency Response.....	15
6.3.1. Test Setup .....	15
6.3.2. Test Limits: .....	15
6.3.3. Test Result .....	16
6.4. Audio Low Pass Filter .....	18
6.4.1. Test Setup .....	18
6.4.2. Test Limits: .....	19
6.4.3. Test Result .....	20
6.5. Frequency Stability.....	22
6.5.1. Test Setup .....	22
6.5.2. Test Limits: .....	22
6.5.3. Test Result .....	23
6.6. Emission Mask .....	25
6.6.1. Test Setup .....	25
6.6.2. Test Limits: .....	26
6.6.1. Test Data .....	28
6.7. Radiated Spurious Emission.....	30
6.7.1. Test Setup .....	30
6.7.2. Test Result .....	31
6.7.3. Test limit.....	33

Revision History	Description	Date	Originator
Rev. A	Initial Report	14-AUG-2020	Gan Boon Teong

### 1.0. General Information

#### EUT Description:

Tx Frequency range	
462.5500MHz to 467.7250MHz	
<b>Antenna type gain</b>	Fix antenna or integral antenna, 1.45dBi
<b>Technologies</b>	FM
<b>Device voltage</b>	4.5V dc

The EUT contains following accessory devices and data cable:

Item	Brand	Model or P/N
AA Alkaline Battery		
Programming, Test & Alignment Cable	MOTOROLA	PMKN4013C

Channel number and frequency information:

Product channel table:

FRS Channels

Channel	Frequency(MHz)	Channel	Frequency(MHz)
1	462.5625	12	467.6625
2	462.5875	13	467.6875
3	462.6125	14	467.7125
4	462.6375	15	462.5500
5	462.6625	16	462.5750
6	462.6875	17	462.6000
7	462.7125	18	462.6250
8	467.5625	19	462.6500
9	467.5875	20	462.6750
10	467.6125	21	462.7000
11	467.6375	22	462.7250

*In §15.31 (m), Frequency range over which device operates in 1MHz or less, middle frequency of channel is selected to perform test.*

### General Description of Applied Standards

The EUT is a RF Product. According to the specifications of the manufacturer, the EUT is to comply with the requirements of the following standards:

#### ANSI C63.26 FCC Part 2 & 95

#### Deviation from standard

Not applicable as no deviation from standard test method

#### Modifications to EUT

For RF conducted measurements a pigtail was soldered out of the board while for radiated measurements there were no modifications to the device

## 2.0. Summary of Test Results

FCC Clause	Test Item	Result	Remark	Tested by	Serial Number	Environmental Conditions
95.567 95.1767	Maximum Output Power	Pass	NA	Gan Boon Teong	16510WK0629	25.9c, 46.3%RH
95.575 95.1775	Modulation Limiting	Pass	NA	Gan Boon Teong	16510WK0629	25.9c, 46.3%RH
95.575 95.1775	Audio Frequency Response	Pass	NA	Gan Boon Teong	16510WK0629	25.9c, 46.3%RH
95.1775	Audio Low Pass Filter	Pass	NA	Gan Boon Teong	16510WK0629	25.9c, 46.3%RH
95.565 95.1765	Frequency Stability	Pass	NA	Gan Boon Teong	16510WK0629	25.9c, 46.3%RH
95.573 95.1773	Emission Bandwidth	Pass	11K0F3E – 10.1209kHz	Gan Boon Teong	16510WK0629	25.9c, 46.3%RH
95.579 95.1779	Unwanted Radiation	Pass	Max spurious emission -43.04dBm	Nazrin & Qawiman	16510WP0002	22.5c, 64%RH

## 3.0. Measurement Uncertainty

Measurement	Frequency	Expended Uncertainty (k=1.96) (±dB)
Maximum Output Power	462MHz ~ 468MHz	5.01
AC Power Line Conducted Spurious Emission	150KHz ~ 30MHz	3.43
Radiated Emissions up to 1 GHz	30MHz ~ 200MHz	5.01
	200MHz ~ 1000MHz	5.01
Radiated Emissions above 1 GHz	1GHz ~ 18GHz	5.01
	18GHz ~ 25GHz	5.01
Conducted Spurious Emissions	9kHz ~ 12.75GHz	2.82

#### 4.0. Equipment List

##### FCC Analog ATE#1: (SW version: 2.4.5 & FCC\_Frequency Stability 1.0.3 rev.)

Description	Model	Serial Number	Calibration Date	Calibration Due Date
CHAMBER	SH-641	92009188	06-Mar-20	06-Mar-21
ANALYZER AUDIO	8903B	3729A17612	15-Nov-19	15-Nov-20
POWER METER	E4416A	GB41293747	19-Nov-18	19-Nov-20
POWER SENSOR	E4412A	MY41495629	16-Jun-20	16-Jun-21
POWER SUPPLY	6031A	3325A02771	13-Mar-20	13-Mar-21
SIGNAL GENERATOR	2042	119718/063	24-Jun-20	24-Jun-21
DSA Dynamic Signal Analyzer	35670A	MY42507095	19-Jun-20	19-Jun-21
ANALYZER MODULATION	8901B	3122A03662	08-Jul-20	08-Jul-21
N to N RF Cable # 1	M17/128-RG400	NA	NA	NA
BNC to N RF Cable # 1	RG 58	NA	NA	NA
BNC to BNC RF Cable # 1	RG 58	NA	NA	NA
BNC to BNC RF Cable # 2	RG 58	NA	NA	NA
BNC to BNC RF Cable # 3	RG 58	NA	NA	NA
BNC to BNC RF Cable # 4	RG 58	NA	NA	NA
BNC to BNC RF Cable # 5	RG 58	NA	NA	NA
BNC to BNC RF Cable # 6	RG 58	NA	NA	NA
BNC to BNC RF Cable # 7	RG 58	NA	NA	NA
N to SMA RF Cable # 1	RG 58	NA	NA	NA
N to SMA RF Cable # 2	RG 58	NA	NA	NA
N to SMA RF Cable # 3	RG 58	NA	NA	NA
Aeroflex Attenuator 30dB	49-30-34-LIM	NA	NA	NA

**FCC Transient ATE #1: (SW version: FCC Transient ATE\_R1.1.2)**

Description	Model	Serial Number	Calibration Date	Calibration Due Date
POWER SENSOR	E4412A	MY41495629	16-Jun-20	16-Jun-21
SWITCH CONTROL UNIT	3488A	2719A36210	CNR	CNR
ATTENUATOR / SWITCH DRIVER	11713A	2508A10141	CNR	CNR
POWER METER	E4416A	GB41293866	26-Feb-19	26-Feb-21
ANALYZER SPECTRUM	E4440A	MY48250517	01-Nov-19	01-Nov-20
POWER SUPPLY	6032A	MY41002067	22-Feb-20	22-Feb-21
SIGNAL GENERATOR	8657A	3250A05137	19-Jun-20	19-Jun-21
STEP ATTENUATOR	8494G	MY42143006	12-Jun-20	12-Jun-21
STEP ATTENUATOR	8496G	MY42143012	13-Jun-20	13-Jun-21
OSCILLOSCOPE	MSO8104A	MY45002372	26-Jun-20	26-Jun-21
ANALYZER MODULATION	8901B	3438A05093	23-Jun-20	23-Jun-21
ANALYZER AUDIO	8903B	3011A12671	11-Mar-20	11-Mar-21
ANALYZER AUDIO	8903B	3011A08952	29-Jul-20	29-Jul-21
N to N RF Cable # 1	SF126/11N/11N	NA	NA	NA
N to N RF Cable # 2	M17/128-RG400	NA	NA	NA
N to N RF Cable # 3	M17/128-RG400	NA	NA	NA
N to N RF Cable # 4	M17/128-RG400	NA	NA	NA
N to N RF Cable # 5	M17/128-RG400	NA	NA	NA
N to N RF Cable # 6	M17/128-RG400	NA	NA	NA
N to N RF Cable # 7	M17/128-RG400	NA	NA	NA
N to N RF Cable # 8	M17/128-RG400	NA	NA	NA
N to N RF Cable # 9	M17/128-RG400	NA	NA	NA
BNC to BNC RF Cable # 1	RG 58	NA	NA	NA
BNC to BNC RF Cable # 2	RG 58	NA	NA	NA
BNC to BNC RF Cable # 3	RG 58	NA	NA	NA
BNC to BNC RF Cable # 4	RG 58	NA	NA	NA
BNC to BNC RF Cable # 5	RG 58	NA	NA	NA
BNC to BNC RF Cable # 6	RG 58	NA	NA	NA
BNC to N RF Cable # 1	RG 58	NA	NA	NA
Aeroflex Attenuator 10dB	49-10-43-LIM	NA	NA	NA
Aeroflex Attenuator 10dB	33-10-34-LIM	NA	NA	NA
SWITCH CONTROL UNIT	3488A	2719A36210	CNR	CNR

**CNR→Calibration Not Required**

### EMC Chamber 1

DESCRIPTION	MODEL	SERIAL NUMBER	CALIBRATION DATE	CALIBRATION DUE DATE
DRG HORN FREQ.	SAS-571	720	21-Mar-19	21-Mar-21
DRG HORN FREQ.	SAS-571	1143	14-Feb-19	14-Feb-21
POWER SUPPLY	6032A	2615A01178	21-MAY-20	21-MAY-21
SIGNAL GENERATOR	SMB 100A	181117	8-Nov-18	8-Nov-21
EMI TEST RECEIVER	ESW44	101750	24-Jul-19	24-Sep-20
EMI TEST RECEIVER	ESIB26	100017	19-Jul-19	19-Sep-20
5m Semi-anechoic Chamber	S800-HX	J2308	CNR	CNR
BILOG ANTENNA	CBL6112B	2964	23-Apr-19	23-Apr-21
BILOG ANTENNA	CBL6112B	2950	8-Jul-19	8-Jul-21
DATA LOGGER	SDL500	A.016776	4-Jun-20	4-Jun-21
SYSTEM CONTROLLER	SC104V	050806-1	CNR	CNR
TURNTABLE FLUSH MOUNT 2M	FM2011	NA	CNR	CNR
ANTENNA POSITIONING TOWER	TLT2	NA	CNR	CNR
BROAD-BAND HORN ANTENNA	BBHA9170	BBHA9170255	27-Jan-20	27-Jan-21
18 - 40GHz PREAMPLIFIER	Miteq Hi Gain Sucoflex	001	CNR	CNR
PREAMPLIFIER	PAM-0118	269	24-May-19	24-May-22
LOOP ANTENNA	6502	00208416	5-Sep-19	5-Sep-20
Test Software	EMC FCC IC Bluetooth RE Test			
Version	EMC FCC RE v1.6.2			

### 5.0. Test Mode Applicability and Test Channel Detail

Test Frequency list:

FRS

Channel	Frequency
4	462.6375 MHz
11	467.6375 MHz



## 6.0. Transmitter Test Parameters

### 6.1. Maximum Output Power

#### 6.1.1. Test Setup

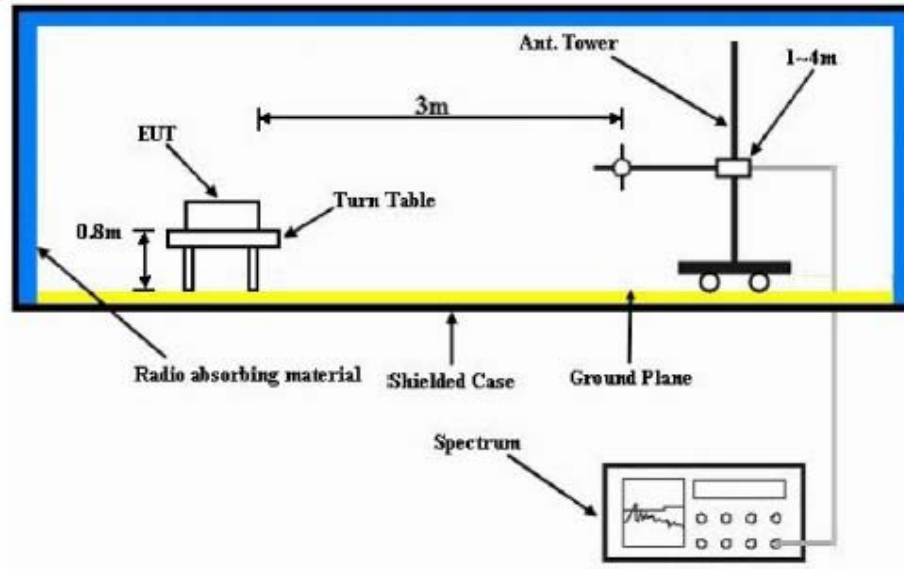

- 1) The spectrum setting for Equivalent Isotropically Radiated Power (EIRP) is RBW = 100 kHz, VBW = 300 kHz. Detector Mode is RMS.
- 2) In the semi-anechoic chamber, setup as illustrated above the EUT placed on the 0.8m height of Turn Table, rotated the table 45 degree each interval to search the maximum radiation power and receiver antenna shall be rotated vertical and horizontal polarization and moved height from 1m to 4m to find the maximum polar radiated power for each degree interval. The "Read Value" is the spectrum reading of maximum power value.
- 3) The substitution antenna is substituted for EUT at the same position and signals generator (S.G) export the CW signal to the substitution antenna via a TX cable. The receiver antenna shall be rotated vertical and horizontal polarization and moved height from 1m to 4m to find the maximum radiation power. Record the power level of maximum radiation power from spectrum. So, the Measured substitution value = Ref level of S.G + TX cables loss – Substituted Antenna Gain.
- 4) Alternatively, max ERP can be calculated using conducted power measurement + max antenna gain (dBd)

## 6.1.2. Test Limits

### §95.567 FRS Transmit Power

Each FRS transmitter type must be designed such that the effective radiated power (ERP) on channels 8 through 14 does not exceed 0.5 Watts and the ERP on channels 1 through 7 and 15 through 22 does not exceed 2.0 Watts.

### §95.567 GMRS Transmitting Power Limits

This section contains transmitting power limits for GMRS stations. The maximum transmitting power depends on which channels are being used and the type of station.

(a) 462/467 MHz main channels. The limits in this paragraph apply to stations transmitting on any of the 462 MHz main channels or any of the 467 MHz main channels. Each GMRS transmitter type must be capable of operating within the allowable power range. GMRS licensees are responsible for ensuring that their GMRS stations operate in compliance with these limits.

(1) The transmitter output power of mobile, repeater and base stations must not exceed 50 Watts.

(2) The transmitter output power of fixed stations must not exceed 15 Watts.

(b) 462 MHz interstitial channels. The effective radiated power (ERP) of mobile, hand-held portable and base stations transmitting on the 462 MHz interstitial channels must not exceed 5 Watts.

(c) 467 MHz interstitial channels. The effective radiated power (ERP) of hand-held portable units transmitting on the 467 MHz interstitial channels must not exceed 0.5 Watt. Each GMRS transmitter type capable of transmitting on these channels must be designed such that the ERP does not exceed 0.5 Watt.

### 6.1.3. Test Data

#### EIRP/ERP

S/N: 16510WK0629  
Channel Spacing : 12.5 kHz  
Accessory: NA  
Max antenna gain: -0.7dBd

Tx Power: 0.5 Watts  
Modulation: FM

Frequency (MHz)	Measured conducted power (dBm)	Max ERP (dBm)
462.6375	26.96	26.26

#### EIRP/ERP

S/N: 16510WK0629  
Channel Spacing : 12.5 kHz  
Accessory: NA  
Max antenna gain: -0.7dBd

Tx Power: 0.5 Watts  
Modulation: FM

Frequency (MHz)	Measured conducted power (dBm)	Max ERP (dBm)
467.6375	27.0	26.3

## 6.2. Modulation Limiting

### 6.2.1. Test Setup

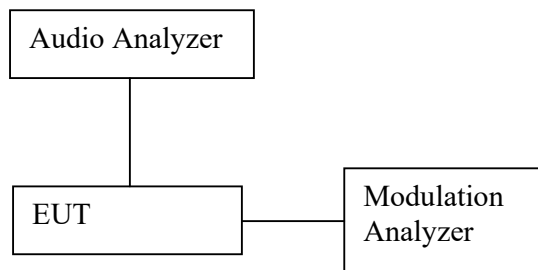

- 1) The DUT transmitter output port was connected to Modulation Analyzer.
- 2) Path loss for the measurement included.
- 3) Set the audio bandwidth filter to 15 kHz.
- 4) Transmit the radio and set the audio analyzer to 1 kHz audio frequency and 60% of the maximum deviation.
- 5) Record the frequency deviation as 0dB input level at 1kHz audio frequency.
- 6) Repeat the step and record the frequency deviation from -20dB to 20dB by 5dB increments and different audio freq 300Hz, 2.5 KHz and 3 KHz.

## 6.2.2. Test Limits

### §95.575 FRS Modulation limits

Each FRS transmitter type must be designed such that the peak frequency deviation does not exceed 2.5 kHz, and the highest audio frequency contributing substantially to modulation must not exceed 3.125 kHz.

### §95.1775 GMRS modulation requirements

Each GMRS transmitter type must be designed to satisfy the modulation requirements in this section. Operation of GMRS stations must also be in compliance with these requirements.

- (a) Main channels. The peak frequency deviation for emissions to be transmitted on the main channels must not exceed  $\pm 5$  kHz.
- (b) 462 MHz interstitial channels. The peak frequency deviation for emissions to be transmitted on the 462 MHz interstitial channels must not exceed  $\pm 5$  kHz.
- (c) 467 MHz interstitial channels. The peak frequency deviation for emissions to be transmitted on the 467 MHz interstitial channels must not exceed  $\pm 2.5$  kHz, and the highest audio frequency contributing substantially to modulation must not exceed 3.125 kHz.
- (d) Overmodulation. Each GMRS transmitter type, except for a mobile station transmitter type with a transmitter power output of 2.5 W or less, must automatically prevent a higher than normal audio level from causing overmodulation.

### 6.2.3. Test Result

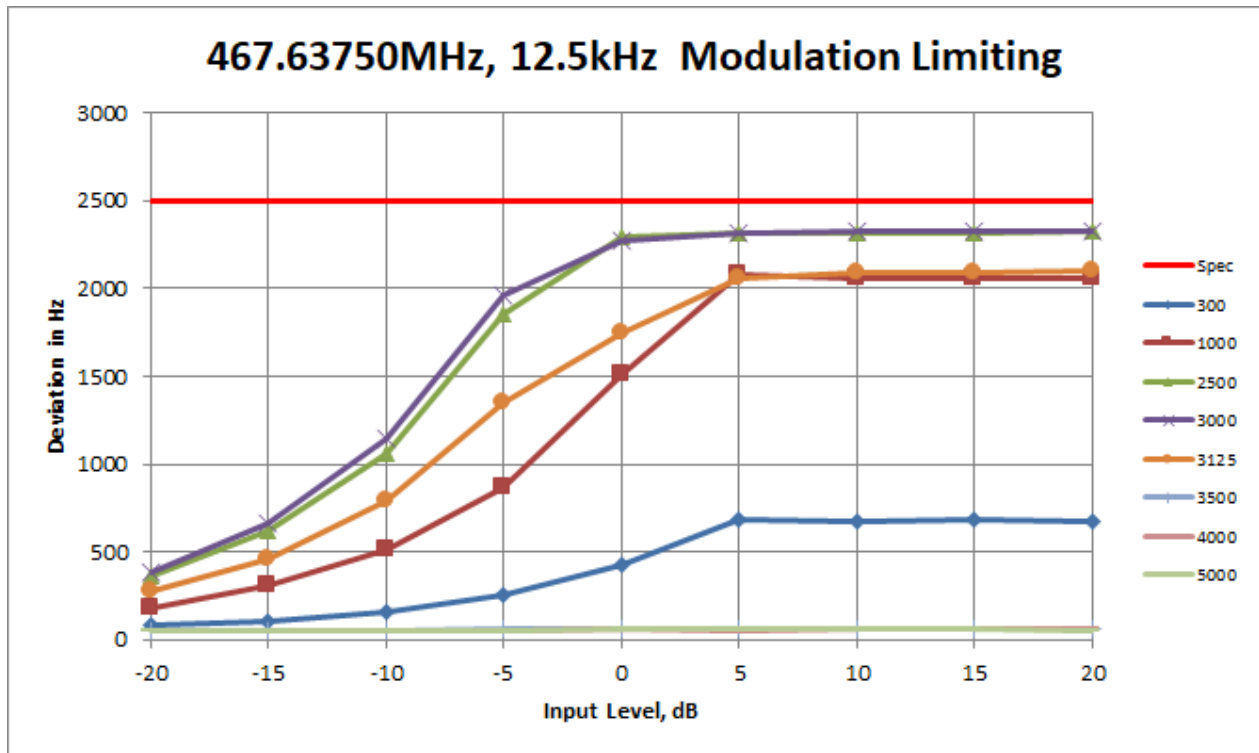
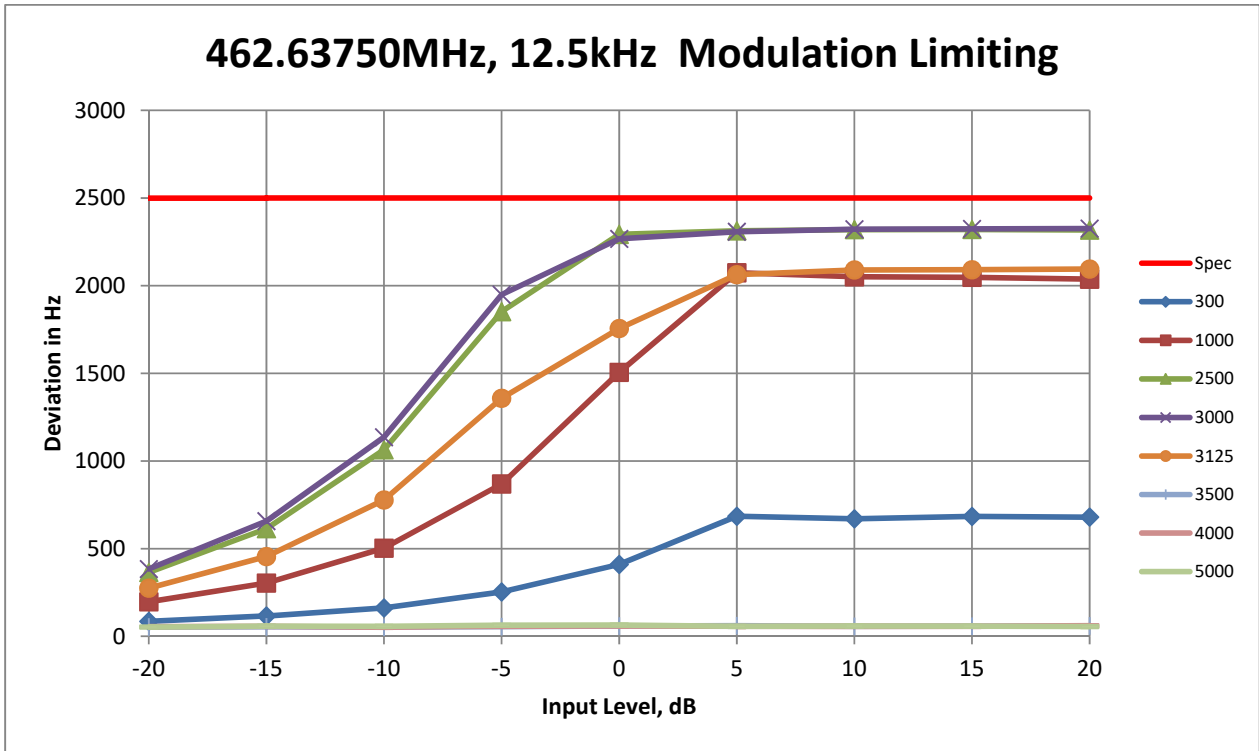

## 6.3. Audio Frequency Response

### 6.3.1. Test Setup

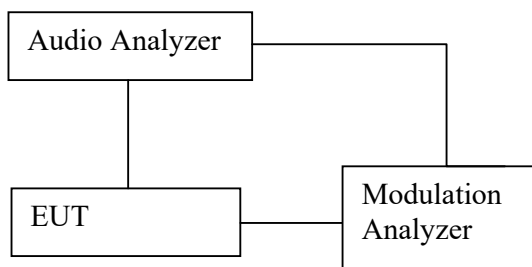

- 1) The DUT transmitter output port was connected to Modulation Analyzer.
- 2) Path loss for the measurement included.
- 3) Set the audio bandwidth filter to 15 kHz and 50kHz.
- 4) Transmit the radio and set the audio analyzer to 1 kHz audio frequency and 20% of the maximum deviation.
- 5) On audio analyzer, set the rated level as reference to zero.
- 6) Vary the audio frequency from 300Hz to 3 kHz. Record the change in dB on the audio analyzer.

### 6.3.2. Test Limits:

#### §95.575 FRS modulation limits

Each FRS transmitter type must be designed such that the peak frequency deviation does not exceed 2.5 kHz, and the highest audio frequency contributing substantially to modulation must not exceed 3.125 kHz.

#### §95.1775 GMRS modulation requirements

(c) 467 MHz interstitial channels. The peak frequency deviation for emissions to be transmitted on the 467 MHz interstitial channels must not exceed  $\pm 2.5$  kHz, and the highest audio frequency contributing substantially to modulation must not exceed 3.125 kHz.

### 6.3.3. Test Result

Frequency : 462.6375 MHz 0.5W

voltage		4.5 V	
Temp. (°C)		25	
Audio Frequency(Hz)	dB	HighSide Specs	LowSide Specs
100	-27.54		
200	-27.66		
300	-10.14	-9.4218	-17.8436
400	-7.42	-6.9316	-12.8631
500	-5.64	-5.0000	-9.0000
750	-2.54	-1.4902	-5.4902
1000	-0.02	1.0000	-3.0000
1500	2.53	4.5098	0.5098
1750	3.80	5.8441	1.8441
2000	5.24	7.0000	3.0000
2500	6.79	8.9316	4.9316
2750	6.68	9.7566	4.9316
3000	7.34	10.5098	4.9316
3125	0.40		
3250	-8.50		
3500	-27.35		
4000	-27.53		
5000	-27.73		

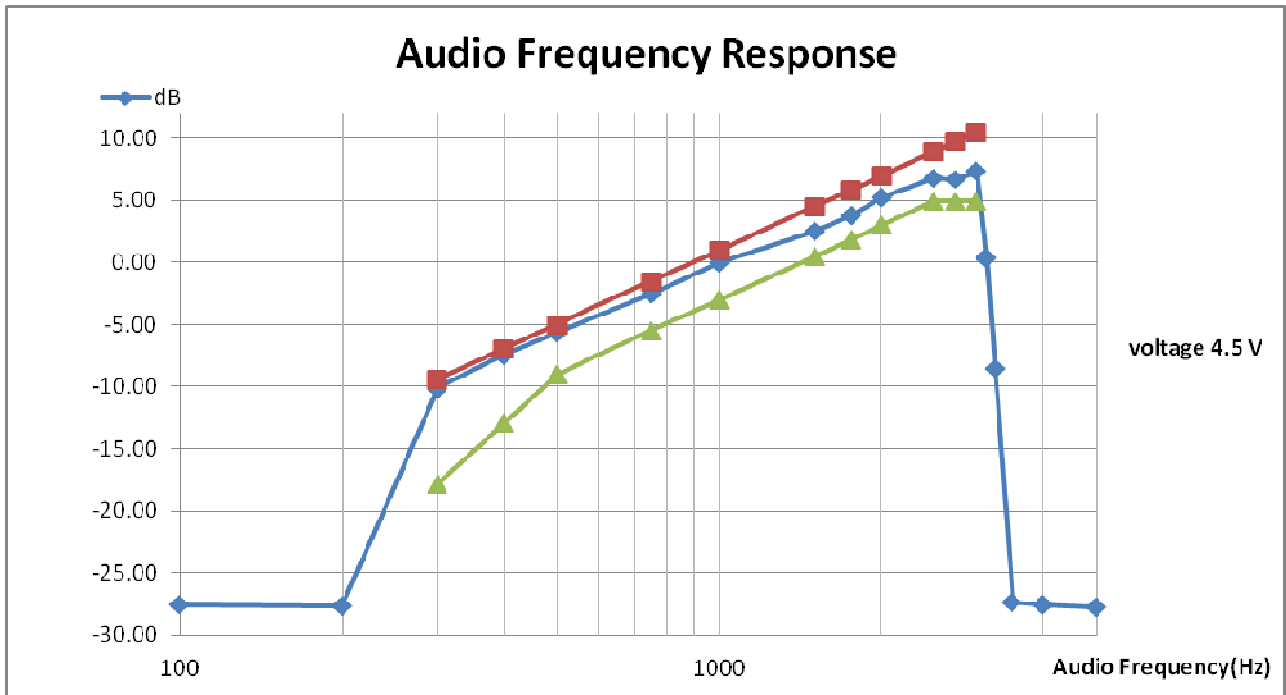



Frequency : 467.6375 MHz 0.5W

voltage		4.5 V	
Temp. (°C)		25	
Audio Frequency(Hz)	dB	HighSide Specs	LowSide Specs
100	-27.44		
200	-27.86		
300	-10.26	-9.4218	-17.8436
400	-7.62	-6.9316	-12.8631
500	-5.59	-5.0000	-9.0000
750	-2.85	-1.4902	-5.4902
1000	0.01	1.0000	-3.0000
1500	2.48	4.5098	0.5098
1750	3.84	5.8441	1.8441
2000	5.20	7.0000	3.0000
2500	6.68	8.9316	4.9316
2750	6.95	9.7566	4.9316
3000	7.29	10.5098	4.9316
3125	0.36		
3250	-8.54		
3500	-27.66		
4000	-27.75		
5000	-27.64		

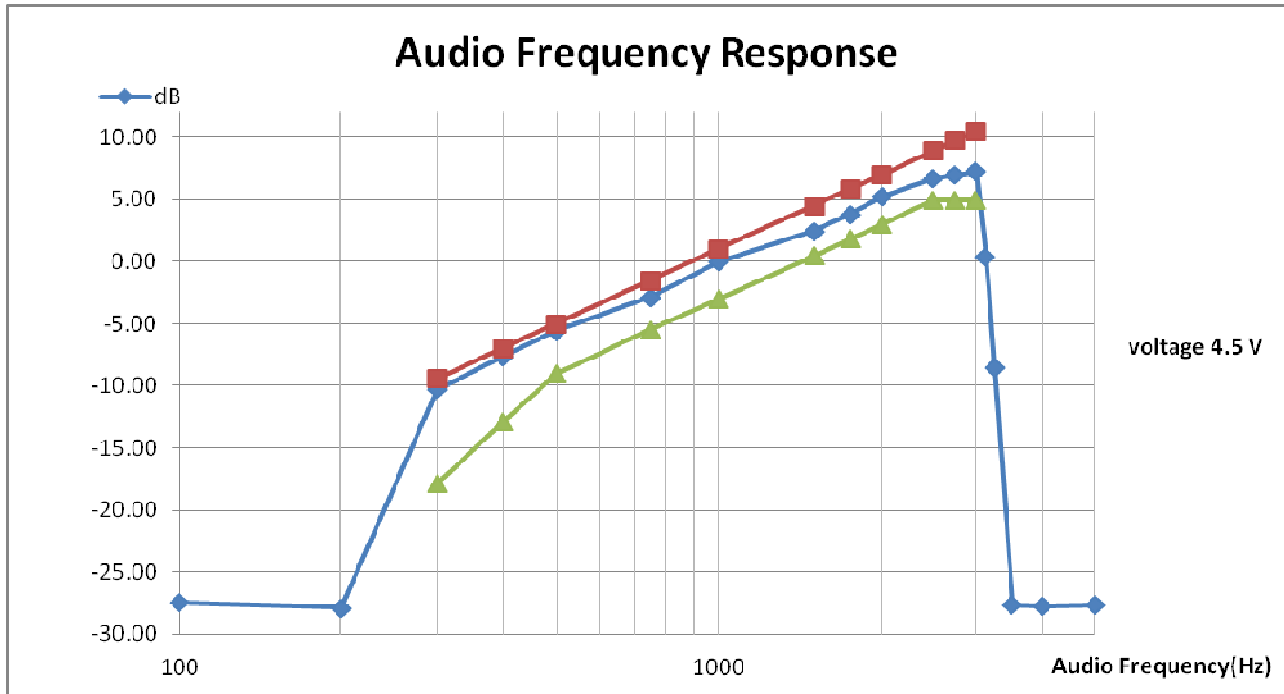

## 6.4. Audio Low Pass Filter

### 6.4.1. Test Setup

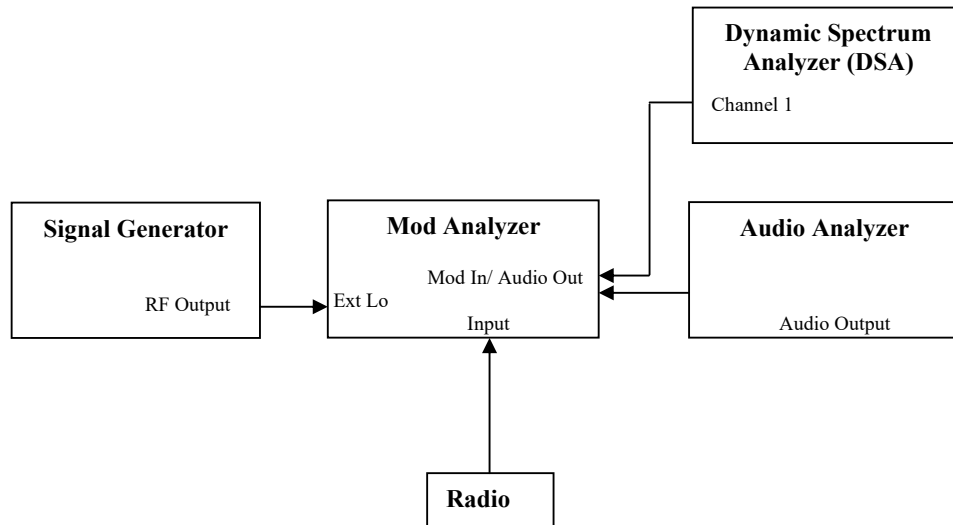

- 1) The DUT transmitter output port was connected to Modulation Analyzer.
- 2) Path loss for the measurement included.
- 3) Press 23.1SPCL on modulation analyzer to enable the external LO from Sigen.
- 4) Set the Sigen frequency to  $F_c + 1.5\text{MHz}$ , RF output level to 0dBm without modulation.
- 5) Transmit the radio and set the audio analyzer to 1 kHz audio frequency and 60% of the maximum deviation.
- 6) Up the amplitude by 20dB.
- 7) On DSA, get the reference point to 0dB.
- 8) Vary the frequency on audio analyzer from 3 kHz to 30 kHz, record the audio tone from DSA.

## 6.4.2. Test Limits:

### §95.1775 GMRS modulation requirements

(e) Audio filter. Each GMRS transmitter type must include audio frequency low pass filtering, unless it complies with the applicable paragraphs of §95.1779 (without filtering).

(1) The filter must be between the modulation limiter and the modulated stage of the transmitter.

(2) At any frequency ( $f$  in kHz) between 3 and 20 kHz, the filter must have an attenuation of at least  $60 \log(f/3)$  dB more than the attenuation at 1 kHz. Above 20 kHz, it must have an attenuation of at least 50 dB more than the attenuation at 1 kHz.

### RSS-210 E.3.3(GMRS) Modulation Requirements

Table E3 — Audio Frequency Filter Attenuation for GMRS Devices	
Frequency, $f$ (kHz)	Attenuation Greater Than the Attenuation at 1 kHz (dB)
$3 \leq f \leq 20$	$60 \log_{10}(f/3)$
$f > 20$	50

### 6.4.3. Test Result

Frequency : 462.6375 MHz 0.5W

voltage	4.5V	
Temp. (°C)	25	
Audio Frequency(kHz)	dB	Limit
1	0.00	0.00
3	0.36	0.00
4	-83.77	-7.50
5	-85.39	-13.31
6	-86.28	-18.06
8	-83.22	-25.56
10	-84.01	-31.37
12	-82.45	-36.12
15	-81.75	-41.94
18	-81.75	-46.69
20	-81.65	-50.00
22	-78.36	-50.00
25	-78.36	-50.00
30	-78.36	-50.00

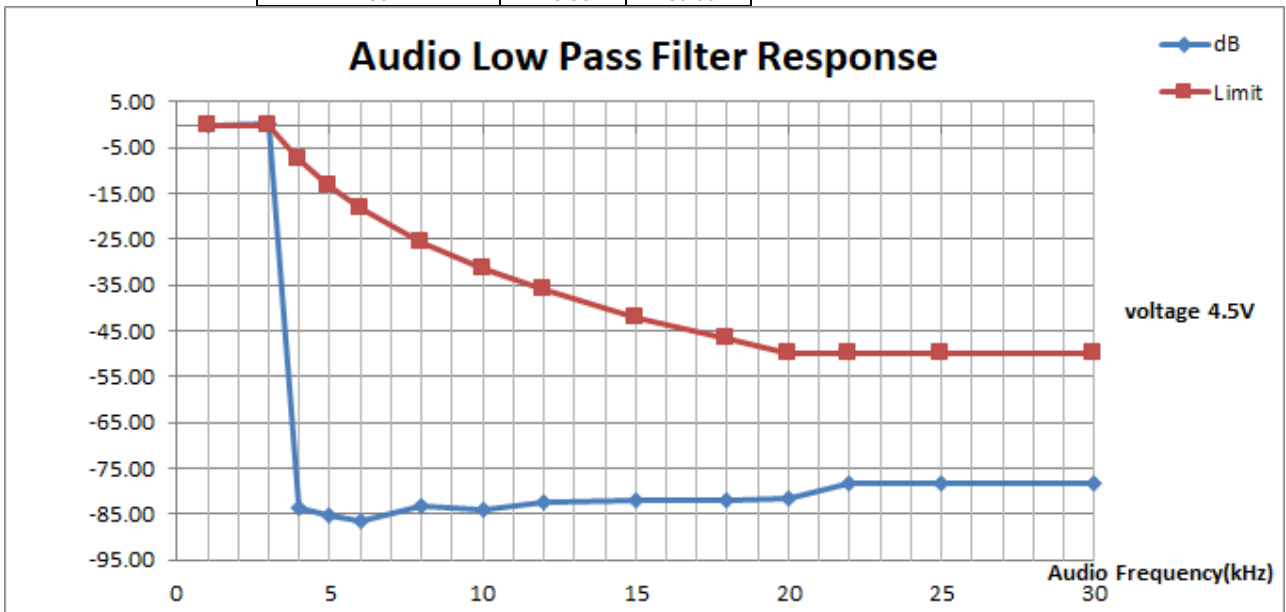

Frequency : 467.6375 MHz 0.5

voltage	4.5V	
Temp. (°C)	25	
Audio Frequency(kHz)	dB	Limit
1	0.00	0.00
3	0.20	0.00
4	-87.00	-7.50
5	-85.14	-13.31
6	-83.96	-18.06
8	-83.51	-25.56
10	-83.58	-31.37
12	-81.54	-36.12
15	-81.84	-41.94
18	-81.09	-46.69
20	-81.14	-50.00
22	-80.17	-50.00
25	-80.00	-50.00
30	-78.00	-50.00

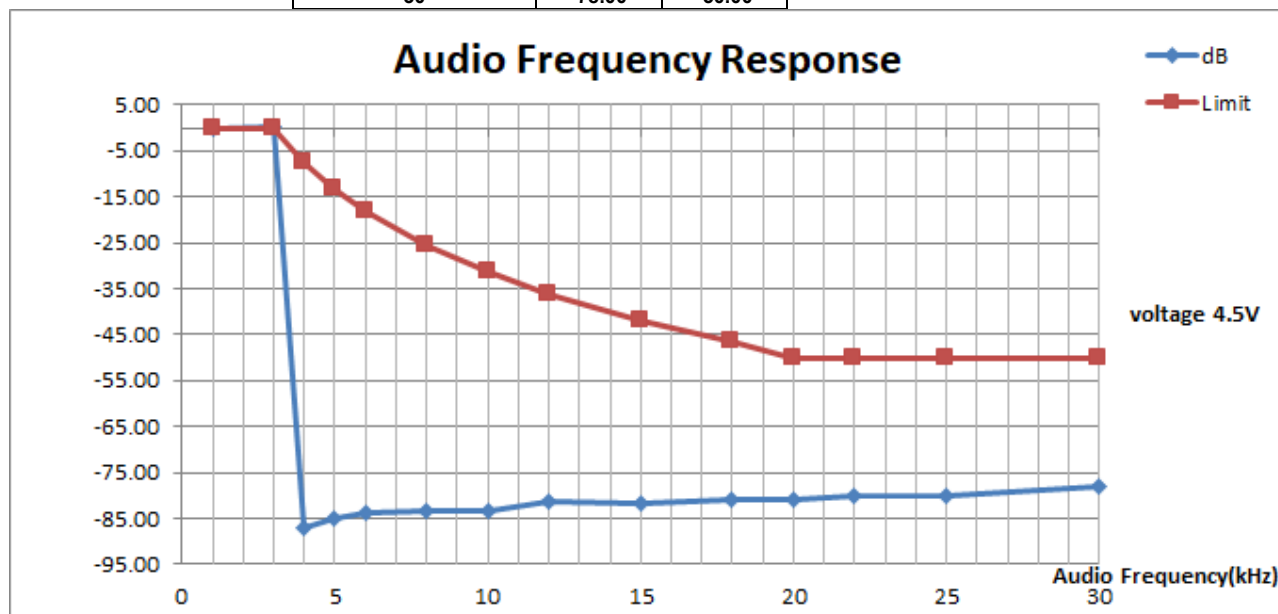

## 6.5. Frequency Stability

### 6.5.1. Test Setup

EUT	Spectrum Analyzer
-----	-------------------

- 1) The DUT transmitter output port was connected to Modulation Analyzer.
- 2) Transmit the DUT and record the freq in  $MCF_{MHz}$ .
- 3) Test in 2 conditions: Different Temperature & Supply Voltage input.
  - Temperature: Vary from  $-30^{\circ}C$  to  $+50^{\circ}C$  with Nominal supply voltage.
  - Supply Voltage: Vary  $\pm 15\%$  in room temperature
- 4) Calculate the ppm frequency error by the following:

$$ppm\ error = \left( \frac{MCF_{MHz}}{ACF_{MHz}} - 1 \right) * 10^6$$

Where:  $MCF_{MHz}$  is the Measured Carrier Frequency in MHz  
 $ACF_{MHz}$  is the Assigned Carrier Frequency in MHz

### 6.5.2. Test Limits:

#### **§95.565 FRS frequency accuracy**

Each FRS transmitter type must be designed such that the carrier frequencies remain within  $\pm 2.5$  parts-per-million of the channel center frequencies specified in §95.563 during normal operating conditions.

#### **§95.1765 GMRS frequency accuracy**

Each GMRS transmitter type must be designed to comply with the frequency accuracy requirements in this section under normal operating conditions. Operators of GMRS stations must also ensure compliance with these requirements.

- (a) The carrier frequency of each GMRS transmitter transmitting an emission with an occupied bandwidth greater than 12.5 kHz must remain within 5 parts-per-million (ppm) of the channel center frequencies listed in §95.1763 under normal operating conditions.
- (b) The carrier frequency of each GMRS transmitter transmitting an emission with an occupied bandwidth of 12.5 kHz or less must remain within 2.5 ppm of the channel center frequencies listed in §95.1763 under normal operating conditions.

### 6.5.3. Test Result

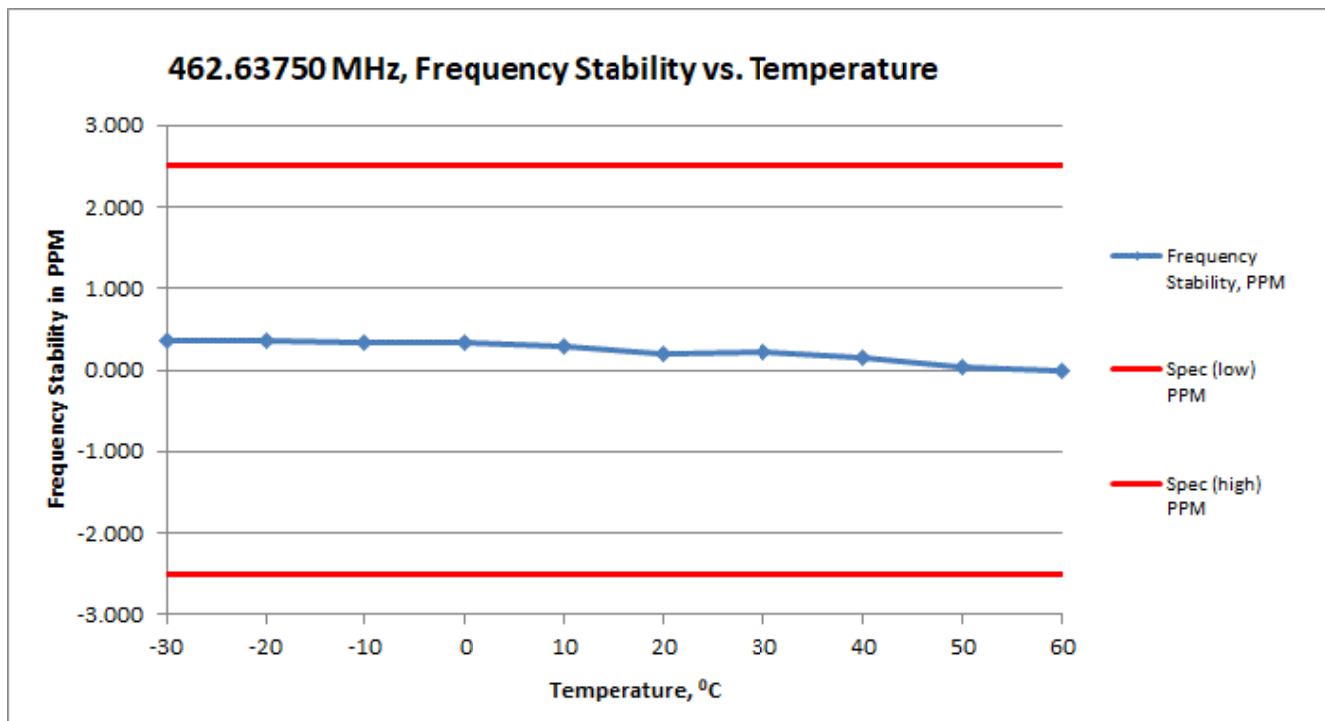
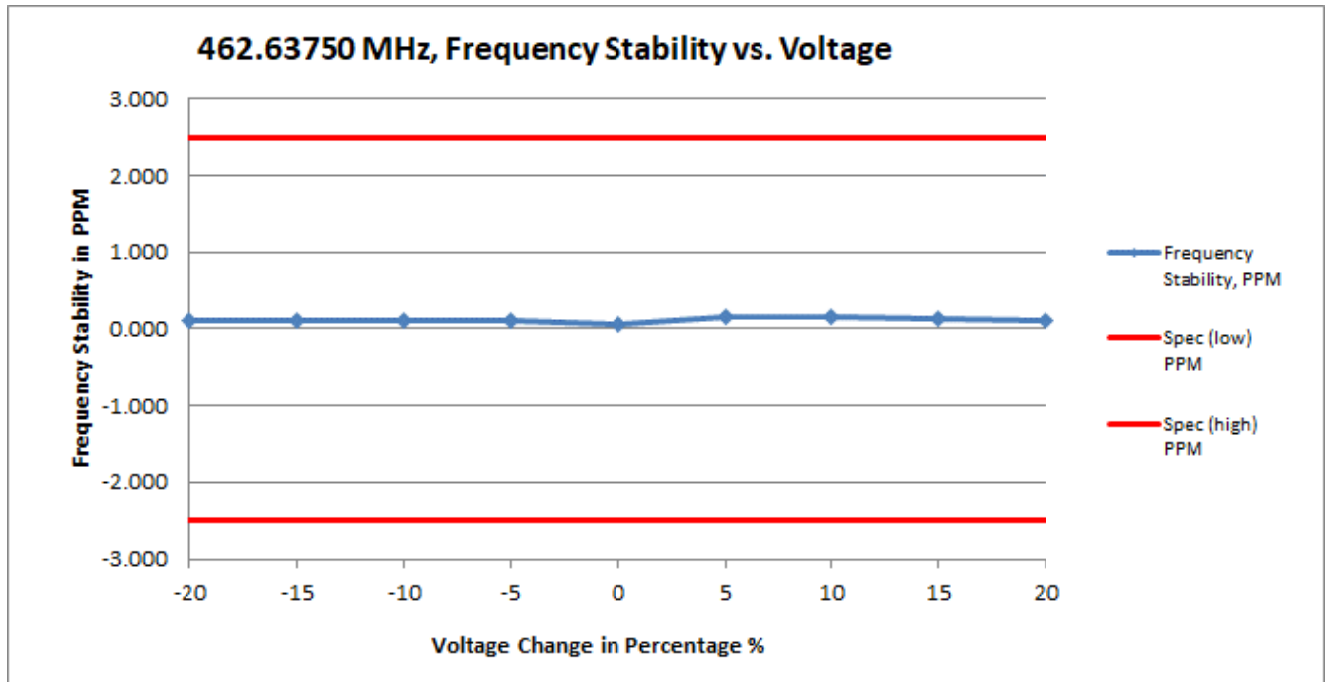

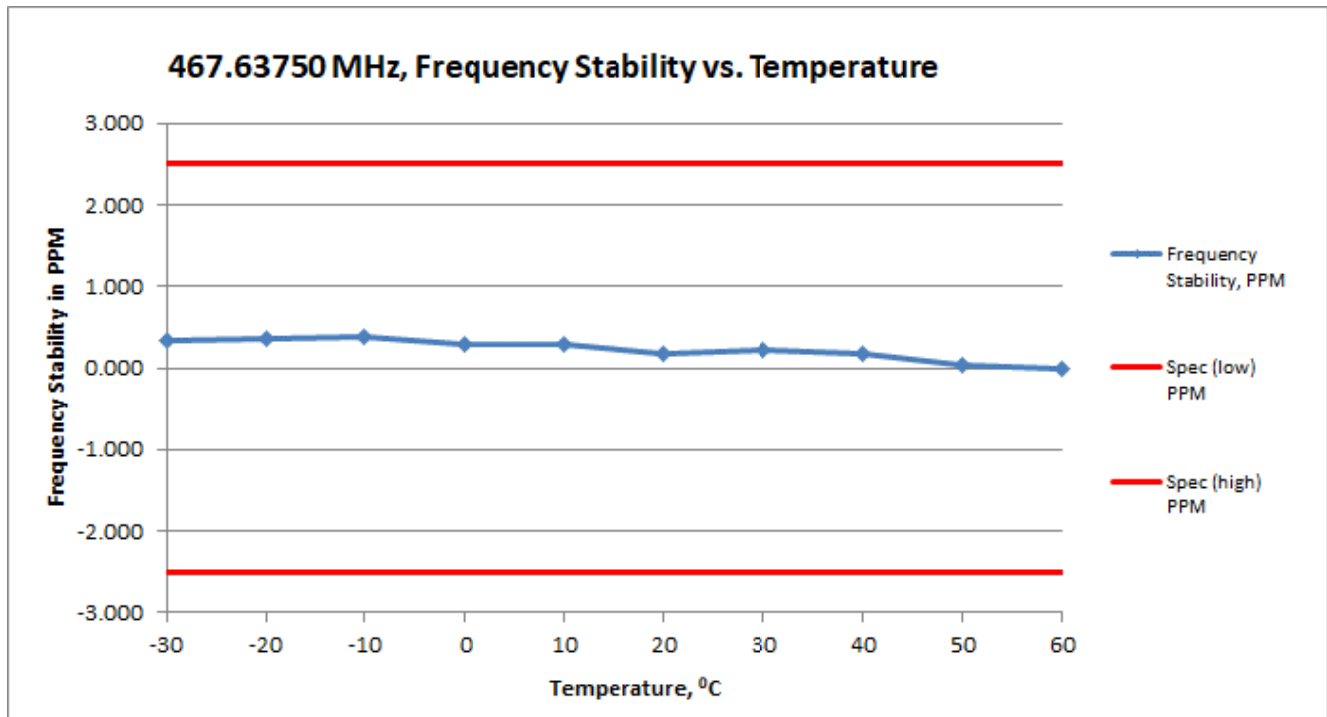
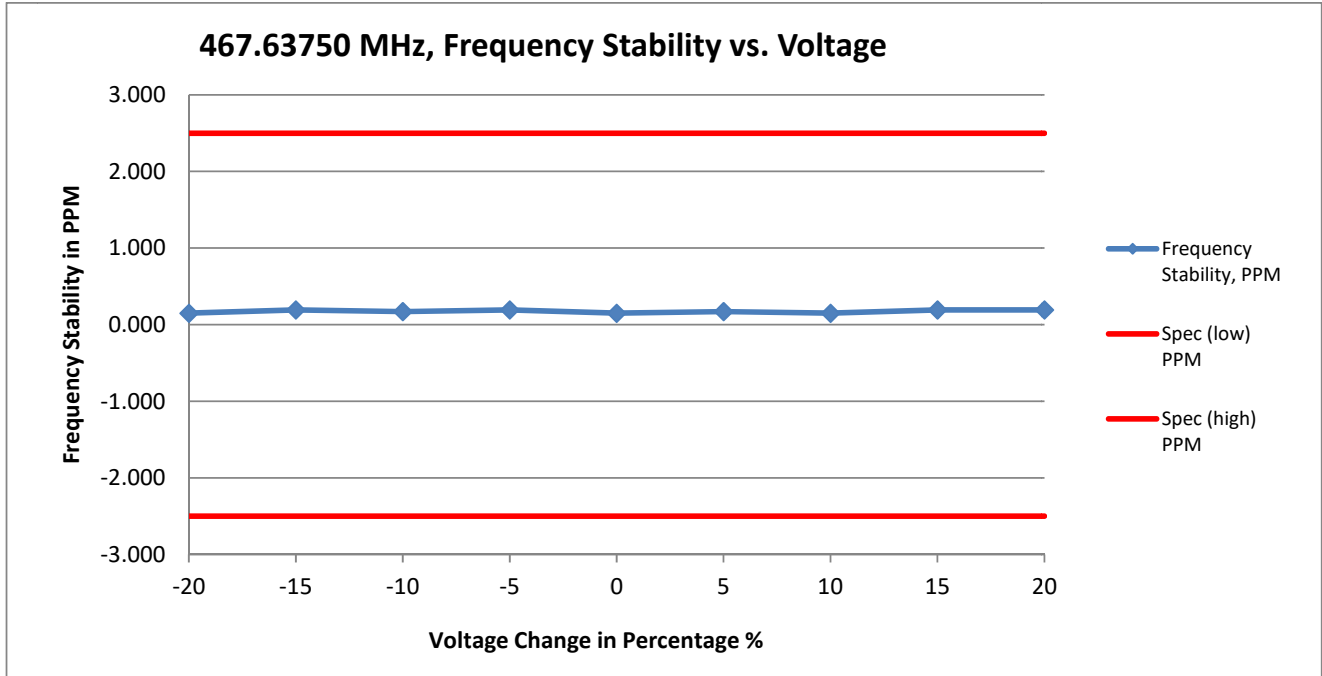



## 6.6. Emission Mask

### 6.6.1. Test Setup

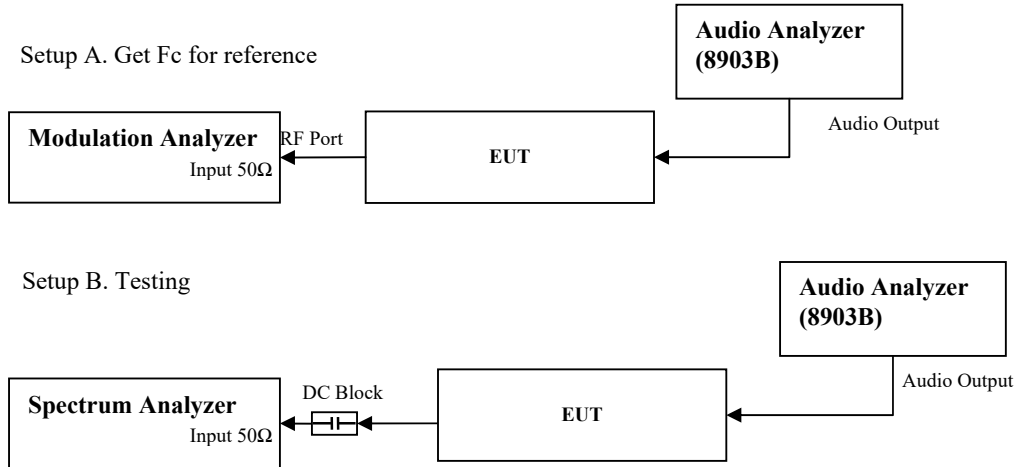

- 1) The DUT transmitter output port was connected to Modulation Analyzer.
- 2) Path loss for the measurement included.
- 3) Key in the Fc to assigned center frequency with the span 100 kHz.
- 4) Set the spectrum analyzer with RBW= 300Hz and VBW= 900Hz.
- 5) Transmit the UUT and record the result.
- 6) Set modulation analyzer audio bandwidth filter to 15 kHz low pass filter and 50 kHz high pass filter.
- 7) Transmit the radio and set the audio analyzer to 2.5 kHz audio frequency and 60% of the maximum deviation.
- 8) Up the amplitude by 16dB and remove the audio tone from audio analyzer.
- 9) Capture the screen shot with and without modulation.

**6.6.2. Test Limits:**

**§95.579 FRS unwanted emissions limits**

Each FRS transmitter type must be designed to satisfy the applicable unwanted emissions limits in this paragraph.

(a) Attenuation requirements. The power of unwanted emissions must be attenuated below the carrier power output in Watts (P) by at least:

- (1) 25 dB (decibels) in the frequency band 6.25 kHz to 12.5 kHz removed from the channel center frequency.
- (2) 35 dB in the frequency band 12.5 kHz to 31.25 kHz removed from the channel center frequency.
- (3)  $43 + 10 \log (P)$  dB in any frequency band removed from the channel center frequency by more than 31.25 kHz.

(b) Measurement bandwidths. The power of unwanted emissions in the frequency bands specified in paragraphs (a)(1) and (2) of this section is measured with a reference bandwidth of 300 Hz. The power of unwanted emissions in the frequency range specified in paragraph (a)(3) is measured with a reference bandwidth of at least 30 kHz.

(c) Measurement conditions. The requirements in this section apply to each FRS transmitter type both with and without the connection of permitted attachments, such as an external speaker, microphone and/or power cord.

**§95.1779 GMRS unwanted emissions limits (1), (2), (7)**

Each GMRS transmitter type must be designed to comply with the applicable unwanted emissions limits in this section.

(a) Emission masks. Emission masks applicable to transmitting equipment in the GMRS are defined by the requirements in the following table. The numbers in the attenuation requirements column refer to rule paragraph numbers under paragraph (b) of this section.

Emission types filter	Attenuation requirements
A1D, A3E, F1D, G1D, F2D, F3E, G3E with audio filter	(1), (2), (7)
A1D, A3E, F1D, G1D, F3E, G3E without audio filter	(3), (4), (7)
H1D, J1D, R1D, H3E, J3E, R2E	(5), (6), (7)

(1) Filtering noted for GMRS transmitters refers to the requirement in §95.1775(e).

(2) Unwanted emission power may be measured as either mean power or peak envelope power, provided that the transmitter output power is measured the same way.

(b) Attenuation requirements. The power of unwanted emissions must be attenuated below the transmitter output power in Watts (P) by at least:

(1) 25 dB (decibels) on any frequency removed from the center of the authorized bandwidth by more than 50% up to and including 100% of the authorized bandwidth.

(2) 35 dB on any frequency removed from the center of the authorized bandwidth by more than 100% up to and including 250% of the authorized bandwidth.

(3)  $83 \log (fd \div 5)$  dB on any frequency removed from the center of the authorized bandwidth by a displacement frequency (fd in kHz) of more than 5 kHz up to and including 10 kHz.

(4)  $116 \log (fd \div 6.1)$  dB or  $50 + 10 \log (P)$  dB, whichever is the lesser attenuation, on any frequency removed from the center of the authorized bandwidth by a displacement frequency (fd in kHz), of more than 10 kHz up to and including 250% of the authorized bandwidth.

(5) 25 dB on any frequency removed from the center of the authorized bandwidth by more than 50% up to and including 150% of the authorized bandwidth.

(6) 35 dB on any frequency removed from the center of the authorized bandwidth by more than 150% up to and including 250% of the authorized bandwidth.

(7)  $43 + 10 \log (P)$  dB on any frequency removed from the center of the authorized bandwidth by more than 250%.

(c) Measurement bandwidths. The power of unwanted emissions in the frequency bands specified in paragraphs (b)(1) through (4) of this section is measured with a reference bandwidth of 300 Hz. The power of unwanted emissions in the frequency range specified in paragraph (b)(5) of this section is measured with a reference bandwidth of at least 30 kHz.

(d) Measurement conditions. The requirements in this section apply to each GMRS transmitter type both with and without the connection of permitted attachments, such as an external speaker, microphone, power cord and/or antenna.

**6.6.1. Test Data**

**BANDWIDTH CALCULATIONS:**

Carson's Rule for FM modulation is utilized to compute the bandwidth shown in the FCC emission designator. Carson's Rule is:

$$BW = 2 * (M + D)$$

where: BW = Bandwidth  
 M = Maximum modulating frequency  
 D = Deviation

**Standard Audio Modulation (12.5 kHz Channelization, Analog Voice):**

Emission Designator 11K0F3E

In this case, the maximum modulating frequency is 3.0 kHz with a 2.5 kHz deviation.

$$BW = 2(M+D) = 2*(3.0 \text{ kHz} + 2.5 \text{ kHz}) = 11 \text{ kHz} \rightarrow 11K0$$

F3E portion of the designator indicates voice.

Therefore, the entire designator for 12.5 kHz channelization analog voice is 11K0F3E.

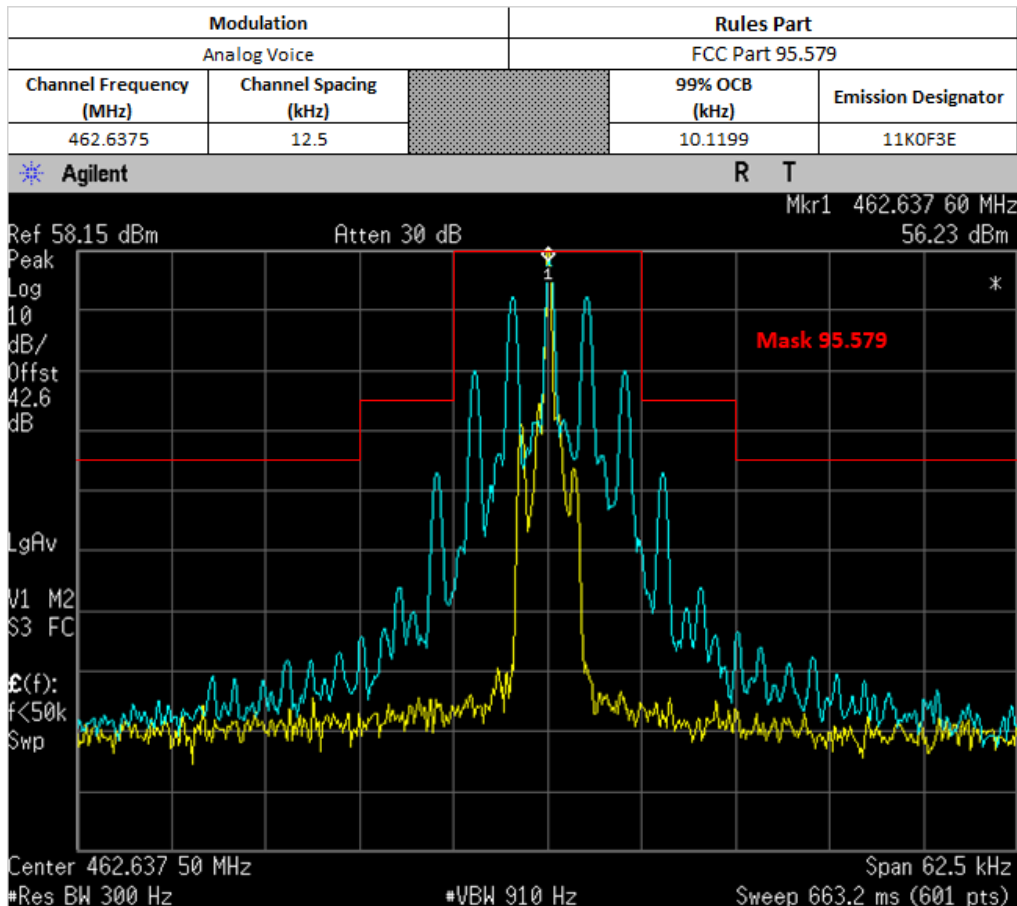

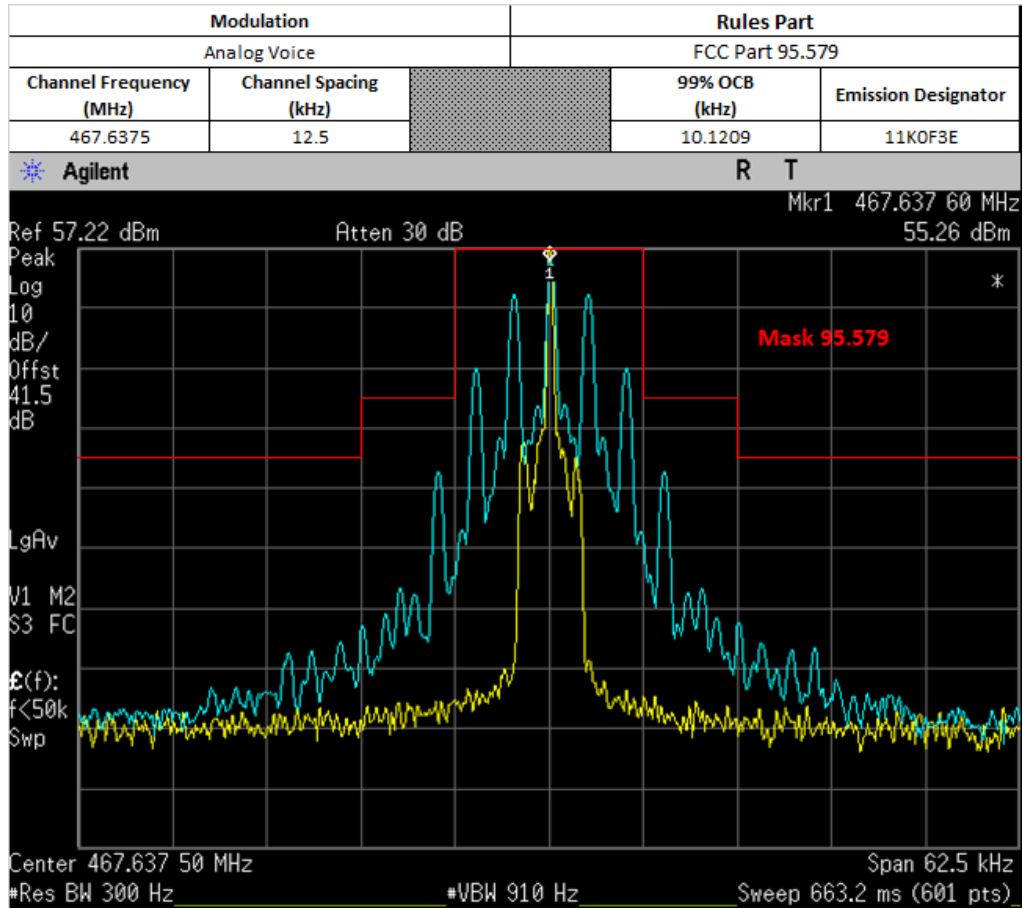

## 6.7. Radiated Spurious Emission

### 6.7.1. Test Setup

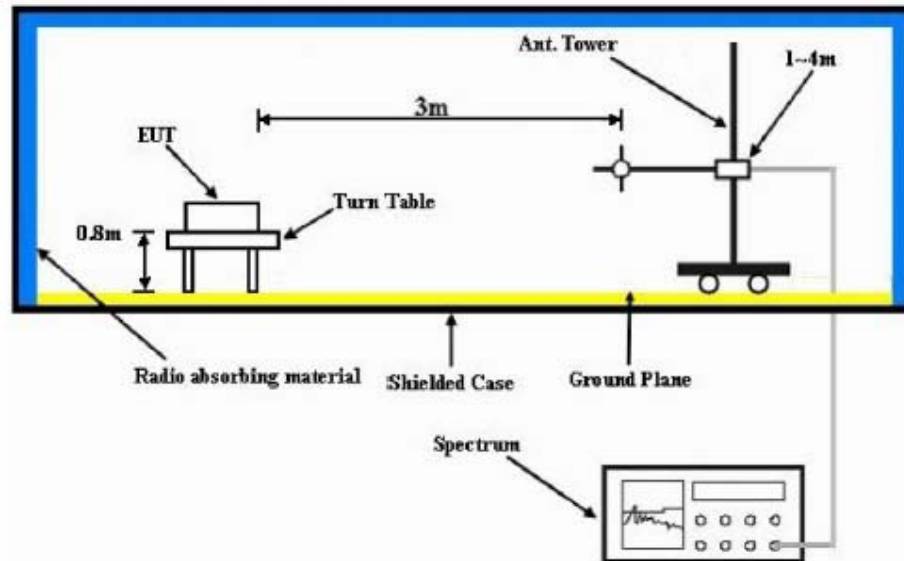

- 1) The spectrum setting for scanning Radiated Emission below 1 GHz is RBW = 100 kHz, VBW = 300 kHz and above 1 GHz is RBW = 1 MHz, VBW = 3 MHz. Detector mode is positive peak.
- 2) In the semi-anechoic chamber, setup as illustrated above the EUT placed on the 0.8m height (for frequencies < 1GHz) or 1.5m (for frequencies > 1GHz) of Turn Table, rotated the table around 360 degrees to search the maximum radiation power and receiver antenna shall be rotated vertical and horizontal polarization and moved height from 1m to 4m to find the maximum polar radiated power. The “Read Value” is the spectrum reading the maximum power value.
- 3) The substitution antenna is substituted for EUT at the same position and signals generator (S.G) export the CW signal to the substitution antenna via a TX cable. The receiver antenna shall be rotated vertical and horizontal polarization and moved height from 1m to 4m to find the maximum radiation power. Record the power level of maximum radiation power from spectrum. So, the measured substitution value = Ref level of S.G + TX cables loss – Substituted Antenna Gain.
- 4) Final Radiated Spurious Emission = “Read Value” + Measured substitution value.



**SAC Transmitter Radiated Emission:**

Model Number: T21X                      S/N: 16510WP0002                      SR:21301-EMC-00004  
 Battery Part No: AA ALKALINE                      Accy Part No: NA  
 Test Mode: TX Analog  
 467.637500 MHz                      12.5 kHz                      0.500 Watt(s) /Max Power

Frequency (MHz)	Limit	Horizontal Measured Emission Equiv Pwr Into Ideal Dipole (dBm)	Vertical Measured Emission Equiv Pwr Into ideal Dipole (dBm)
935.2750	-13.0000	-86.7207 **	-84.8373 **
1402.9125	-13.0000	-51.5000 *	-44.8000 *
1870.5500	-13.0000	-46.6000 *	-43.0400 *
2338.1875	-13.0000	-48.6100 *	-48.5400 *
2805.8250	-13.0000	-49.0400 *	-49.3300 *
3273.4625	-13.0000	-46.9400 *	-49.8100 *
3741.1000	-13.0000	-46.0800 *	-44.7500 *
4208.7375	-13.0000	-47.7989 **	-48.2530 **
4676.3750	-13.0000	-47.6499 **	-46.6357 **

**RADIATED SPURIOUS EMISSIONS**

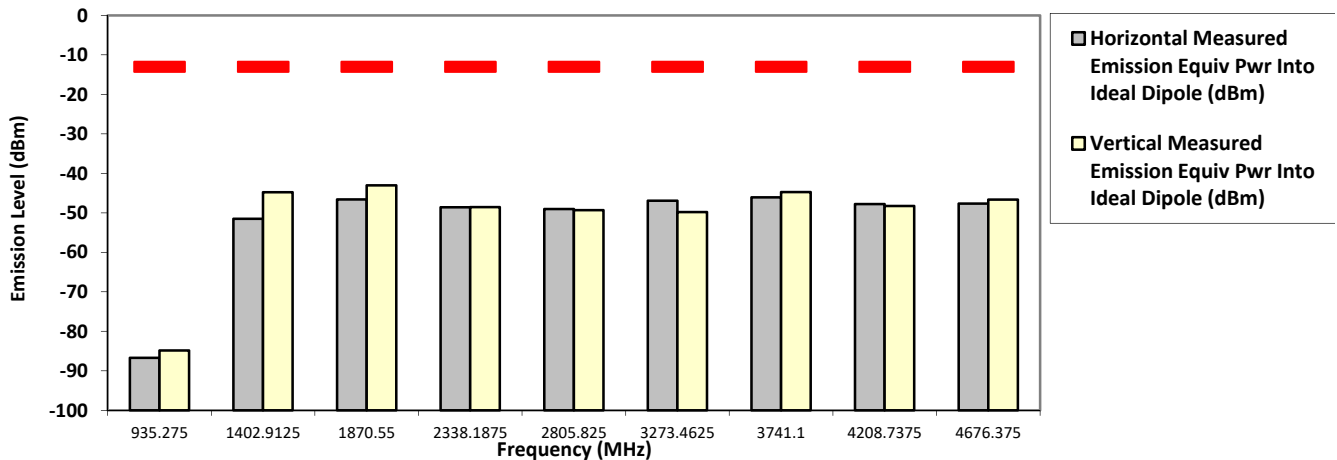

The data presented here was taken using the substitution method as found in the ANSI C63.26-2015 document.  
 Motorola Penang EMC Lab - Test Performed by: Nazrin&Qawiman                      Tue, Jul 28, 2020

Remarks: \*\* Indicates the spurious emission could not be detected due to noise limitations or ambient.

\*Pursuant to CFR 47 Part 2.1057 ( c ), emissions attenuated more than 20 dB below the permissible limit are not reported  
 Temp(Deg): 23.3 Hum(%RH): 69.4

System MU: 4.03 dB

Remarks: Passed Results Marginal Results Failed Results



### 6.7.3. Test limit

At least  $43 + 10 \log_{10}(T)$  dB on any frequency removed from the center of the authorized bandwidth by more than 250%.

#### §95.579 FRS unwanted emissions limits

Each FRS transmitter type must be designed to satisfy the applicable unwanted emissions limits in this paragraph.

- (a) Attenuation requirements. The power of unwanted emissions must be attenuated below the carrier power output in Watts (P) by at least:
- (1) 25 dB (decibels) in the frequency band 6.25 kHz to 12.5 kHz removed from the channel center frequency.
  - (2) 35 dB in the frequency band 12.5 kHz to 31.25 kHz removed from the channel center frequency.
  - (3)  $43 + 10 \log(P)$  dB in any frequency band removed from the channel center frequency by more than 31.25 kHz.
- (b) Measurement bandwidths. The power of unwanted emissions in the frequency bands specified in paragraphs (a)(1) and (2) of this section is measured with a reference bandwidth of 300 Hz. The power of unwanted emissions in the frequency range specified in paragraph (a)(3) is measured with a reference bandwidth of at least 30 kHz.
- (c) Measurement conditions. The requirements in this section apply to each FRS transmitter type both with and without the connection of permitted attachments, such as an external speaker, microphone and/or power cord.

#### §95.1779 GMRS unwanted emissions limits (1), (2), (7)

Each GMRS transmitter type must be designed to comply with the applicable unwanted emissions limits in this section.

- (a) Emission masks. Emission masks applicable to transmitting equipment in the GMRS are defined by the requirements in the following table. The numbers in the attenuation requirements column refer to rule paragraph numbers under paragraph (b) of this section.

Emission types filter	Attenuation requirements
A1D, A3E, F1D, G1D, F2D, F3E, G3E with audio filter	(1), (2), (7)
A1D, A3E, F1D, G1D, F3E, G3E without audio filter	(3), (4), (7)
H1D, J1D, R1D, H3E, J3E, R2E	(5), (6), (7)

- (1) Filtering noted for GMRS transmitters refers to the requirement in §95.1775(e).
- (2) Unwanted emission power may be measured as either mean power or peak envelope power, provided that the transmitter output power is measured the same way.
- (b) Attenuation requirements. The power of unwanted emissions must be attenuated below the transmitter output power in Watts (P) by at least:
- (1) 25 dB (decibels) on any frequency removed from the center of the authorized bandwidth by more than 50% up to and including 100% of the authorized bandwidth.

(2) 35 dB on any frequency removed from the center of the authorized bandwidth by more than 100% up to and including 250% of the authorized bandwidth.

(3)  $83 \log (fd \div 5)$  dB on any frequency removed from the center of the authorized bandwidth by a displacement frequency ( $fd$  in kHz) of more than 5 kHz up to and including 10 kHz.

(4)  $116 \log (fd \div 6.1)$  dB or  $50 + 10 \log (P)$  dB, whichever is the lesser attenuation, on any frequency removed from the center of the authorized bandwidth by a displacement frequency ( $fd$  in kHz), of more than 10 kHz up to and including 250% of the authorized bandwidth.

(5) 25 dB on any frequency removed from the center of the authorized bandwidth by more than 50% up to and including 150% of the authorized bandwidth.

(6) 35 dB on any frequency removed from the center of the authorized bandwidth by more than 150% up to and including 250% of the authorized bandwidth.

(7)  $43 + 10 \log (P)$  dB on any frequency removed from the center of the authorized bandwidth by more than 250%.

(c) Measurement bandwidths. The power of unwanted emissions in the frequency bands specified in paragraphs (b)(1) through (4) of this section is measured with a reference bandwidth of 300 Hz. The power of unwanted emissions in the frequency range specified in paragraph (b)(5) of this section is measured with a reference bandwidth of at least 30 kHz.

(d) Measurement conditions. The requirements in this section apply to each GMRS transmitter type both with and without the connection of permitted attachments, such as an external speaker, microphone, power cord and/or antenna.

- End of Test Report -