

 CERTIFICATE 2518.08   MS ISO/IEC 17025 TESTING SAMMNO. 0825
<p>MOTOROLA PENANG ADV. COMM. LABORATORY Motorola Solutions Malaysia SDN BHD Plot 2A, Medan Bayan Lepas, Mukim 12 S.W.D., 11900 Bayan Lepas, Penang, Malaysia.</p>	<p>FCC / ISED TEST REPORT Report Revision : Rev.C</p>
<p>Date/s Tested : 20-October-2019 - 29-October-2019 Report Issue Date : 6-November-2019 Manufacturer/Location : Motorola Solutions Malaysia SDN BHD PLOT 2A, MEDAN BAYAN LEPAS, MUKIM 12 S.W.D. 11900 BAYAN LEPAS, PENANG, MALAYSIA Requestor : LEONG JUN THYE Product Type : Portable Model Number : T482 Frequency Band : 462-468 MHz Max. Output Power : 2 W Firmware Version : V0_13 Applicant Name : Motorola Solutions Inc FCC Registrations : 461337 ISED Registrations : MY0001</p>  <p>The equipment was tested accordance to the requirement listed below:</p> <p>FCC 47 CFR Part 95 PASS</p>	
<p>This report shall not be reproduced without written approval from an officially designated representative of the Motorola Penang Adv. Comm. Laboratory. The results and statements contained in this report pertain only to the device(s) evaluated.</p>	
<p>Prepared By:</p> <hr/> <p>GAN BOON TEONG Test Personnel</p>	<p>Approved By:</p> <hr/> <p>VINCENT FOONG CHUEN KIT Deputy Technical Manager</p>

Table of Contents

- 1.0. General Information 3
- 2.0. Summary of Test Results..... 4
- 3.0. Measurement Uncertainty 4
- 4.0. Equipment List..... 5
- 5.0. Test Mode Applicability and Test Channel Detail..... 8
- 6.0. Transmitter Test Parameters 9
 - 6.1. Maximum Output Power 9
 - 6.1.1. Test Setup 9
 - 6.1.2. Test Limits 10
 - 6.1.3. Test Data..... 11
 - 6.2. Modulation Limiting 12
 - 6.2.1. Test Setup 12
 - 6.2.2. Test Limits 13
 - 6.2.3. Test Result 14
 - 6.3. Audio Frequency Response 16
 - 6.3.1. Test Setup 16
 - 6.3.2. Test Limits:..... 16
 - 6.3.3. Test Result 17
 - 6.4. Audio Low Pass Filter 19
 - 6.4.1. Test Setup 19
 - 6.4.2. Test Limits:..... 19
 - 6.4.3. Test Result 20
 - 6.5. Frequency Stability..... 22
 - 6.5.1. Test Setup 22
 - 6.5.2. Test Limits:..... 22
 - 6.5.3. Test Result 23
 - 6.6. Emission Mask 27
 - 6.6.1. Test Setup 27
 - 6.6.2. Test Limits:..... 28
 - 6.6.1. Test Data..... 30
 - 6.7. Radiated Spurious Emission 32
 - 6.7.1. Test Setup 32
 - 6.7.2. Test Result 33
 - 6.7.3. Test limit..... 35

Revision History	Description	Date	Originator
Rev. A	Initial Report	30-October-2019	Gan Boon Teong
Rev. B	Standardized address, added Carson’s Rule calculation	27-November-2019	Vincent Foong
Rev. C	Update freq range	3-December-2019	Vincent Foong

1.0. General Information

EUT Description:

Tx Frequency range	
462.5500MHz to 467.7125MHz	
Antenna type gain	Fix antenna or integral antenna, 1.65dBi
Technologies	FM
Device voltage	4.5V dc

Channel number and frequency information:

Product channel table:

FRS Channels

Channel	Frequency(MHz)	Channel	Frequency(MHz)
1	462.5625	12	467.6625
2	462.5875	13	467.6875
3	462.6125	14	467.7125
4	462.6375	15	462.5500
5	462.6625	16	462.5750
6	462.6875	17	462.6000
7	462.7125	18	462.6250
8	467.5625	19	462.6500
9	467.5875	20	462.6750
10	467.6125	21	462.7000
11	467.6375	22	462.7250

In §15.31 (m), Frequency range over which device operates in 1MHz or less, middle frequency of channel is selected to perform test.

General Description of Applied Standards

The EUT is a RF Product. According to the specifications of the manufacturer, the EUT is to comply with the requirements of the following standards:

ANSI C63.26
FCC Part 2 & 95

2.0. Summary of Test Results

FCC Clause	Test Item	Result	Remark
95.567 95.1767	Maximum Output Power	Pass	NA
95.575 95.1775	Modulation Limiting	Pass	NA
95.575 95.1775	Audio Frequency Response	Pass	NA
95.1775	Audio Low Pass Filter	Pass	NA
95.565 95.1765	Frequency Stability	Pass	NA
95.573 95.1773	Emission Bandwidth	Pass	11K0F3E – 9.86kHz
95.579 95.1779	Unwanted Radiation	Pass	Max spurious emission -20.77dBm

3.0. Measurement Uncertainty

Measurement	Expanded Uncertainty (k=1.96) (±)
Maximum Output Power	5.01dB

4.0. Equipment List Analog ATE #10

Description	Model	Serial Number	Calibration Date	Calibration Due Date
RF TRANSCEIVER CONTROLLER	AX2007AI	AX2007AI004	Not Required	Not Required
TRANSCEIVER INTERFACE	8954A	2924A00823	14-Feb-19	14-Feb-20
POWER METER	E4416A	MY45101705	23-Nov-18	23-Nov-20
POWER SENSOR	E4412A	MY49000115	12-Jun-19	12-Jun-20
SIGNAL GENERATOR	2042	203002/742	18-Jun-19	18-Jun-20
POWER SUPPLY	6031A	3018A01914	22-Apr-19	22-Apr-20
SIGNAL GENERATOR	E4425B	GB39340028	19-Aug-19	19-Aug-20
CHAMBER	SH-641	92003839	26-Feb-19	26-Feb-20
MODULATION ANALYZER	8901B	2806A01913	6-May-19	6-May-20
SPECTRUM ANALYZER	8594E	3506A01703	12-Sep-19	12-Sep-20
SIGNAL GENERATOR	SMA100A	111383	24-Jan-17	24-Jan-20
AUDIO ANALYZER	8903B	3011A11041	14-Apr-19	14-Apr-20
N to N RF cable # 1	SUCOFLEX 104	NA	NA	NA
N to N RF cable # 2	84188418 H+S MY 0812	NA	NA	NA
N to N RF cable # 3	84188418 H+S MY 0812	NA	NA	NA
N to N RF cable # 4	84188418 H+S MY 0812	NA	NA	NA
N to N RF cable # 5	84188418 H+S MY 0812	NA	NA	NA
N to N RF cable # 6	84188418 H+S MY 0812	NA	NA	NA
N to N RF cable # 7	84188418 H+S MY 0812	NA	NA	NA
N to N RF cable # 8	84188418 H+S MY 0812	NA	NA	NA
N to N RF cable # 9	84188418 H+S MY 0812	NA	NA	NA
N to N RF cable # 10	84188418 H+S MY 0812	NA	NA	NA
N to N RF cable # 11	84188418 H+S MY 0812	NA	NA	NA
N to N RF cable # 12	84188418 H+S MY 0812	NA	NA	NA
N to N RF cable # 13	84188418 H+S MY 0812	NA	NA	NA
N to N RF cable # 14	84188418 H+S MY 0812	NA	NA	NA
N to N RF cable # 15	84188418 H+S MY 0812	NA	NA	NA
N to N RF cable # 16	84188418 H+S MY 0812	NA	NA	NA
BNC to BNC RF cable # 1	NA	NA	NA	NA
BNC to BNC RF cable # 2	NA	NA	NA	NA
BNC to BNC RF cable # 3	NA	NA	NA	NA
BNC to BNC RF cable # 4	NA	NA	NA	NA
BNC to BNC RF cable # 5	NA	NA	NA	NA
BNC to BNC RF cable # 6	NA	NA	NA	NA
BNC to BNC RF cable # 7	NA	NA	NA	NA
BNC to BNC RF cable # 8	NA	NA	NA	NA
Test Software	Analog ATE			
Version	2.4.5			

Test Software	FCC_FreqStability
Version	Rev1.0.03

FCC Analog ATE#1: (SW version: 2.4.5 & FCC_Frequency Stability 1.0.3 rev.)

Description	Model	Serial Number	Calibration Date	Calibration Due Date
Audio Analyzer	8903B	3729A17612	15-Nov-17	15-Nov-20
SIGNAL GENERATOR	2042	203002/747	22-Jan-19	22-Jan-20
MODULATION ANALYZER	8901B	3538A5696	4-Apr-19	4-Apr-20
DSA	36570A	MY42506790	4-Apr-19	4-Apr-20
POWER SENSOR	E9031A	MY41502652	19-Nov-18	19-Nov-19
POWER METER	E4412A	MY41293855	27-Jul-19	27-Jul-20
POWER SUPPLY	E4416A	GB41293747	11-Apr-19	11-Apr-20
CHAMBER	SH-641	92009188	29-Mar-19	29-Mar-20
N to N RF Cable # 1	M17/128-RG400	NA	NA	NA
BNC to N RF Cable # 1	RG 58	NA	NA	NA
BNC to BNC RF Cable # 1	RG 58	NA	NA	NA
BNC to BNC RF Cable # 2	RG 58	NA	NA	NA
BNC to BNC RF Cable # 3	RG 58	NA	NA	NA
BNC to BNC RF Cable # 4	RG 58	NA	NA	NA
BNC to BNC RF Cable # 5	RG 58	NA	NA	NA
BNC to BNC RF Cable # 6	RG 58	NA	NA	NA
BNC to BNC RF Cable # 7	RG 58	NA	NA	NA
N to SMA RF Cable # 1	RG 58	NA	NA	NA
N to SMA RF Cable # 2	RG 58	NA	NA	NA
N to SMA RF Cable # 3	RG 58	NA	NA	NA
Aeroflex Attenuator 30dB	49-30-34-LIM	NA	NA	NA

FCC Transient ATE #1: (SW version: FCC Transient ATE_R1.1.2)

Description	Model	Serial Number	Calibration Date	Calibration Due Date
POWER SUPPLY	6031A	2430A00146	5-Apr-19	5-Apr-20
POWER SENSOR	E4412A	MY41498918	29-Jul-19	29-Jul-20
POWER METER	E4416A	GB41293866	26-Feb-19	26-Feb-21
ATTENUATORS/SWITCH DRIVER	11713A	2508A10141	CNR	CNR
STEP ATTENUATOR/11dB	8494G	MY52300223	26-Jul-19	26-Jul-20
STEP ATTENUATOR/110dB	8496G	MY52300176	26-Jul-19	26-Jul-20
OSCILLOSCOPE	MSO8104A	MY45002372	17-Jun-19	17-Jun-20
AUDIO ANALYZER	8903B	3011A08952	5-Jul-19	5-Jul-20
AUDIO ANALYZER	8903B	3729A17409	4-Jul-19	4-Jul-20
MODULATION ANALYZER	8901B	3226A04052	3-Apr-19	3-Apr-20
SIGNAL GENERATOR	8657B	3427U06025	5-Apr-19	5-Apr-20
SPECTRUM ANALYZER	E4440A	MY46185415	1-Aug-19	1-Aug-20
N to N RF Cable # 1	SF126/11N/11N	NA	NA	NA
N to N RF Cable # 2	M17/128-RG400	NA	NA	NA
N to N RF Cable # 3	M17/128-RG400	NA	NA	NA
N to N RF Cable # 4	M17/128-RG400	NA	NA	NA
N to N RF Cable # 5	M17/128-RG400	NA	NA	NA
N to N RF Cable # 6	M17/128-RG400	NA	NA	NA
N to N RF Cable # 7	M17/128-RG400	NA	NA	NA
N to N RF Cable # 8	M17/128-RG400	NA	NA	NA
N to N RF Cable # 9	M17/128-RG400	NA	NA	NA
BNC to BNC RF Cable # 1	RG 58	NA	NA	NA
BNC to BNC RF Cable # 2	RG 58	NA	NA	NA
BNC to BNC RF Cable # 3	RG 58	NA	NA	NA
BNC to BNC RF Cable # 4	RG 58	NA	NA	NA
BNC to BNC RF Cable # 5	RG 58	NA	NA	NA
BNC to BNC RF Cable # 6	RG 58	NA	NA	NA
BNC to N RF Cable # 1	RG 58	NA	NA	NA
Aeroflex Attenuator 10dB	49-10-43-LIM	NA	NA	NA
Aeroflex Attenuator 10dB	33-10-34-LIM	NA	NA	NA
SWITCH CONTROL UNIT	3488A	2719A36210	CNR	CNR

EMC Chamber 1

DESCRIPTION	MODEL	SERIAL NUMBER	CALIBRATION DATE	CALIBRATION DUE DATE
DRG HORN FREQ.	SAS-571	720	21-Mar-19	21-Mar-21
DRG HORN FREQ.	SAS-571	1143	14-Feb-19	14-Feb-21
POWER SUPPLY (0-60V / 0-50A, 1000W)	6032A	MY41001736	25-May-19	25-May-20
SIGNAL GENERATOR	SMB 100A	181117	8-Nov-18	8-Nov-21
EMI TEST RECEIVER	ESW44	101750	24-Jul-19	24-Jul-20
EMI TEST RECEIVER	ESIB26	100017	19-Jul-19	19-Jul-20
5m Semi-anechoic Chamber	S800-HX	J2308	No Cal. Req'd	No Cal. Req'd
BILOG ANTENNA	CBL6112D	25224	1-Aug-18	1-Nov-19
BILOG ANTENNA	CBL6112B	2964	16-Feb-18	16-Feb-20
DATA LOGGER	SDL500	A.016800	19-Mar-19	18-Mar-20
SYSTEM CONTROLLER	SC104V	050806-1	No Cal. Req'd	No Cal. Req'd
TURNTABLE FLUSH MOUNT 2M	FM2011	NA	No Cal. Req'd	No Cal. Req'd
ANTENNA POSITIONING TOWER	TLT2	NA	No Cal. Req'd	No Cal. Req'd
BROAD-BAND HORN ANTENNA	BBHA9170	BBHA9170255	21-Dec-18	21-Dec-19
18 - 40GHz PREAMPLIFIER	Miteq Hi Gain Sucoflex	001	No Cal. Req'd	No Cal. Req'd
PREAMPLIFIER	PAM-0118	269	24-May-19	24-May-20
LOOP ANTENNA	6502	00203479	10-Dec-18	10-Dec-19
Test Software	EMC_FCC_IC_Bluetooth_RE_Test			
Version	EMC_FCC_RE_v1.6.0			

5.0. Test Mode Applicability and Test Channel Detail

Test Frequency list:

FRS

Channel	Frequency
4	462.6375 MHz
11	467.6375 MHz

6.0. Transmitter Test Parameters

6.1. Maximum Output Power

6.1.1. Test Setup

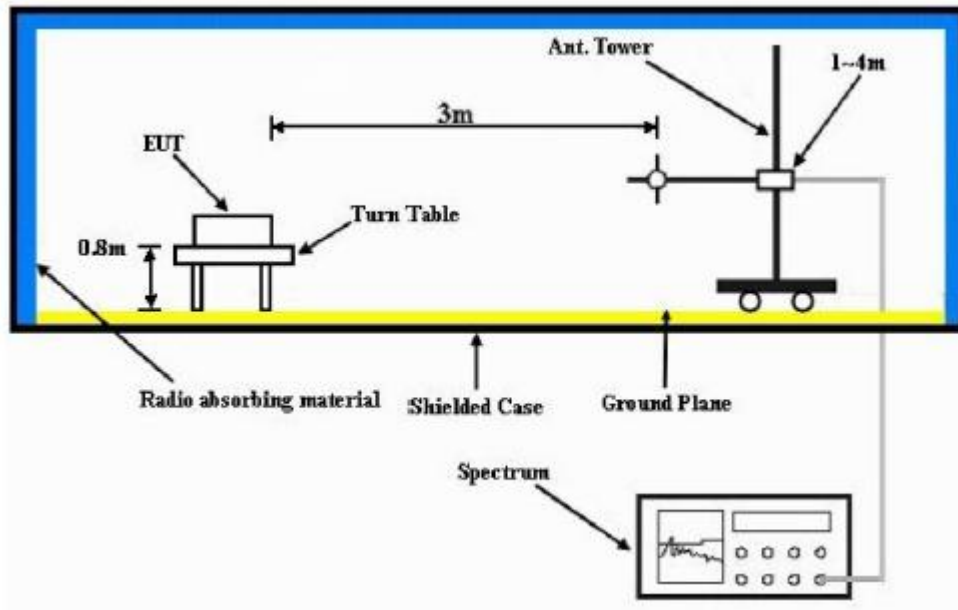

- 1) The spectrum setting for Equivalent Isotropically Radiated Power (EIRP) is RBW = 100 kHz, VBW = 300 kHz. Detector Mode is RMS.
- 2) In the semi-anechoic chamber, setup as illustrated above the EUT placed on the 0.8m height of Turn Table, rotated the table 45 degree each interval to search the maximum radiation power and receiver antenna shall be rotated vertical and horizontal polarization and moved height from 1m to 4m to find the maximum polar radiated power for each degree interval. The “Read Value” is the spectrum reading of maximum power value.
- 3) The substitution antenna is substituted for EUT at the same position and signals generator (S.G) export the CW signal to the substitution antenna via a TX cable. The receiver antenna shall be rotated vertical and horizontal polarization and moved height from 1m to 4m to find the maximum radiation power. Record the power level of maximum radiation power from spectrum. So, the Measured substitution value = Ref level of S.G + TX cables loss – Substituted Antenna Gain.
- 4) Alternatively, max ERP can be calculated using conducted power measurement + max antenna gain (dBd)

6.1.2. Test Limits

§95.567 FRS Transmit Power

Each FRS transmitter type must be designed such that the effective radiated power (ERP) on channels 8 through 14 does not exceed 0.5 Watts and the ERP on channels 1 through 7 and 15 through 22 does not exceed 2.0 Watts.

§95.567 GMRS Transmitting Power Limits

This section contains transmitting power limits for GMRS stations. The maximum transmitting power depends on which channels are being used and the type of station.

(a) 462/467 MHz main channels. The limits in this paragraph apply to stations transmitting on any of the 462 MHz main channels or any of the 467 MHz main channels. Each GMRS transmitter type must be capable of operating within the allowable power range. GMRS licensees are responsible for ensuring that their GMRS stations operate in compliance with these limits.

(1) The transmitter output power of mobile, repeater and base stations must not exceed 50 Watts.

(2) The transmitter output power of fixed stations must not exceed 15 Watts.

(b) 462 MHz interstitial channels. The effective radiated power (ERP) of mobile, hand-held portable and base stations transmitting on the 462 MHz interstitial channels must not exceed 5 Watts.

(c) 467 MHz interstitial channels. The effective radiated power (ERP) of hand-held portable units transmitting on the 467 MHz interstitial channels must not exceed 0.5 Watt. Each GMRS transmitter type capable of transmitting on these channels must be designed such that the ERP does not exceed 0.5 Watt.

6.1.3. Test Data

EIRP/ERP

S/N: 1654VU0015
Channel Spacing : 12.5 kHz
Accessory: NA
Max antenna gain: -0.5dBd

Tx Power: 2 Watts
Modulation: FM

Frequency (MHz)	Measured conducted power (dBm)	Max ERP (dBm)	Max ERP (W)
462.6375	32.77	32.27	1.69

EIRP/ERP

S/N: 1654VU0015
Channel Spacing : 12.5 kHz
Accessory: NA
Max antenna gain: -0.5dBd

Tx Power: 0.6 Watts
Modulation: FM

Frequency (MHz)	Measured conducted power (dBm)	Max ERP (dBm)	Max ERP (W)
467.6375	26.18	25.68	0.37

6.2. Modulation Limiting

6.2.1. Test Setup

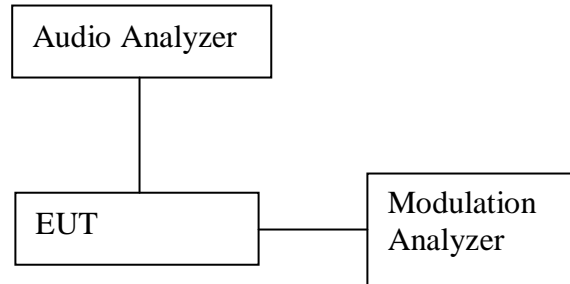

- 1) The DUT transmitter output port was connected to Modulation Analyzer.
- 2) Path loss for the measurement included.
- 3) Set the audio bandwidth filter to 15 kHz.
- 4) Transmit the radio and set the audio analyzer to 1 kHz audio frequency and 60% of the maximum deviation.
- 5) Record the frequency deviation as 0dB input level at 1kHz audio frequency.
- 6) Repeat the step and record the frequency deviation from -20dB to 20dB by 5dB increments and different audio freq 300Hz, 2.5 KHz and 3 KHz.

6.2.2. Test Limits

§95.575 FRS Modulation limits

Each FRS transmitter type must be designed such that the peak frequency deviation does not exceed 2.5 kHz, and the highest audio frequency contributing substantially to modulation must not exceed 3.125 kHz.

§95.1775 GMRS modulation requirements

Each GMRS transmitter type must be designed to satisfy the modulation requirements in this section. Operation of GMRS stations must also be in compliance with these requirements.

- (a) Main channels. The peak frequency deviation for emissions to be transmitted on the main channels must not exceed ± 5 kHz.
- (b) 462 MHz interstitial channels. The peak frequency deviation for emissions to be transmitted on the 462 MHz interstitial channels must not exceed ± 5 kHz.
- (c) 467 MHz interstitial channels. The peak frequency deviation for emissions to be transmitted on the 467 MHz interstitial channels must not exceed ± 2.5 kHz, and the highest audio frequency contributing substantially to modulation must not exceed 3.125 kHz.
- (d) Overmodulation. Each GMRS transmitter type, except for a mobile station transmitter type with a transmitter power output of 2.5 W or less, must automatically prevent a higher than normal audio level from causing overmodulation.

6.2.3. Test Result

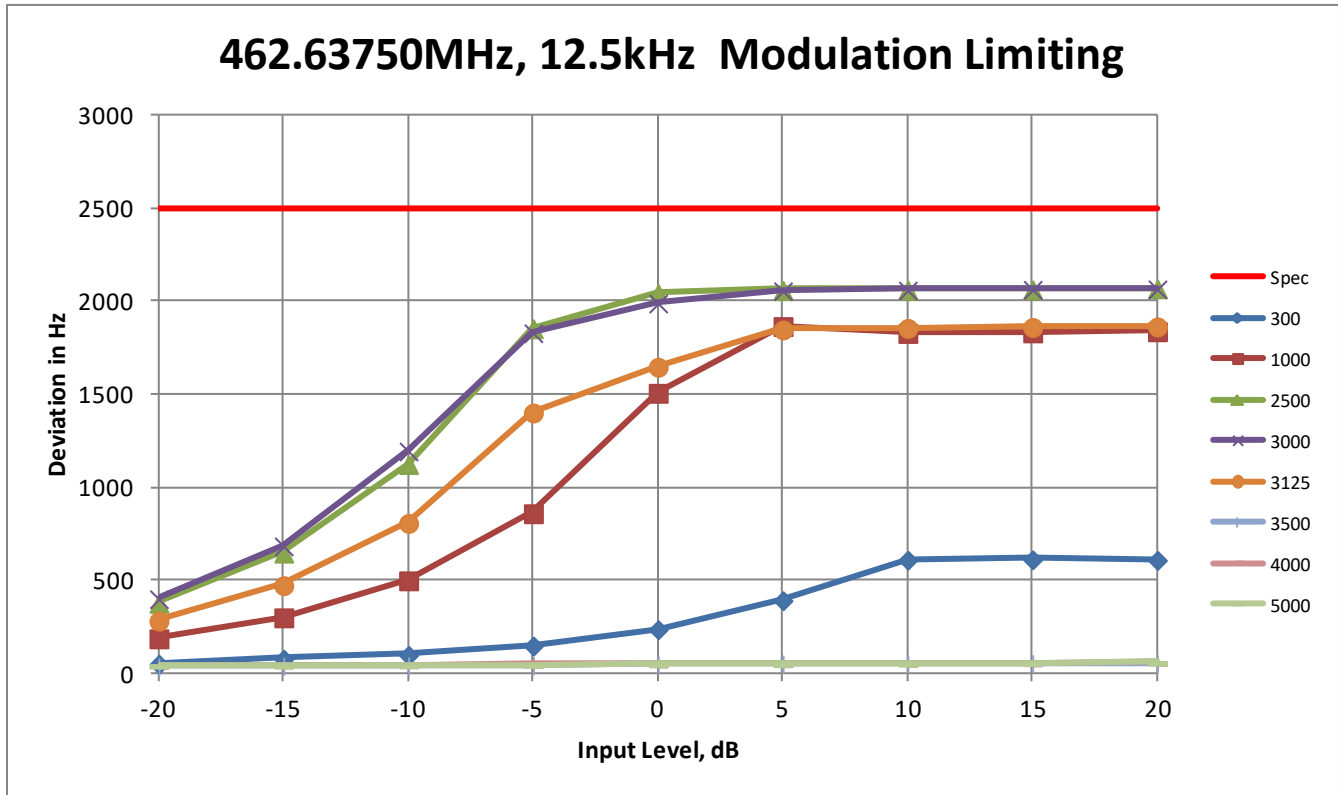

Frequency / Channel Spacing		462.63750MHz / 12.5kHz																
Voltage		4.5V																
Temperature, °C		25																
Freq Deviation, Hz	300		1000		2500		3000		3125		3500		4000		5000		Spec	
Input Level, dB	Dev, Hz	%	Dev, Hz	%	Dev, Hz	%	Dev, Hz	%	Dev, Hz	%	Dev, Hz	%	Dev, Hz	%	Dev, Hz	%	Dev, Hz	%
-20	52	2.1	189	7.6	380	15.2	402	16.1	284	11.4	39	1.6	41	1.6	41	1.6	2500	100
-15	79	3.2	302	12.1	650	26.0	686	27.4	475	19.0	41	1.6	43	1.7	41	1.6	2500	100
-10	100	4.0	501	20.0	1127	45.1	1197	47.9	810	32.4	43	1.7	45	1.8	42	1.7	2500	100
-5	150	6.0	862	34.5	1857	74.3	1833	73.3	1404	56.2	45	1.8	46	1.8	45	1.8	2500	100
0	238	9.5	1510	60.4	2047	81.9	1993	79.7	1650	66.0	48	1.9	47	1.9	48	1.9	2500	100
5	394	15.8	1869	74.8	2063	82.5	2059	82.4	1851	74.0	53	2.1	49	2.0	49	2.0	2500	100
10	612	24.5	1832	73.3	2065	82.6	2063	82.5	1859	74.4	52	2.1	51	2.0	52	2.1	2500	100
15	614	24.6	1835	73.4	2067	82.7	2067	82.7	1864	74.6	55	2.2	53	2.1	55	2.2	2500	100
20	611	24.4	1841	73.6	2072	82.9	2069	82.8	1867	74.7	54	2.2	56	2.2	57	2.3	2500	100

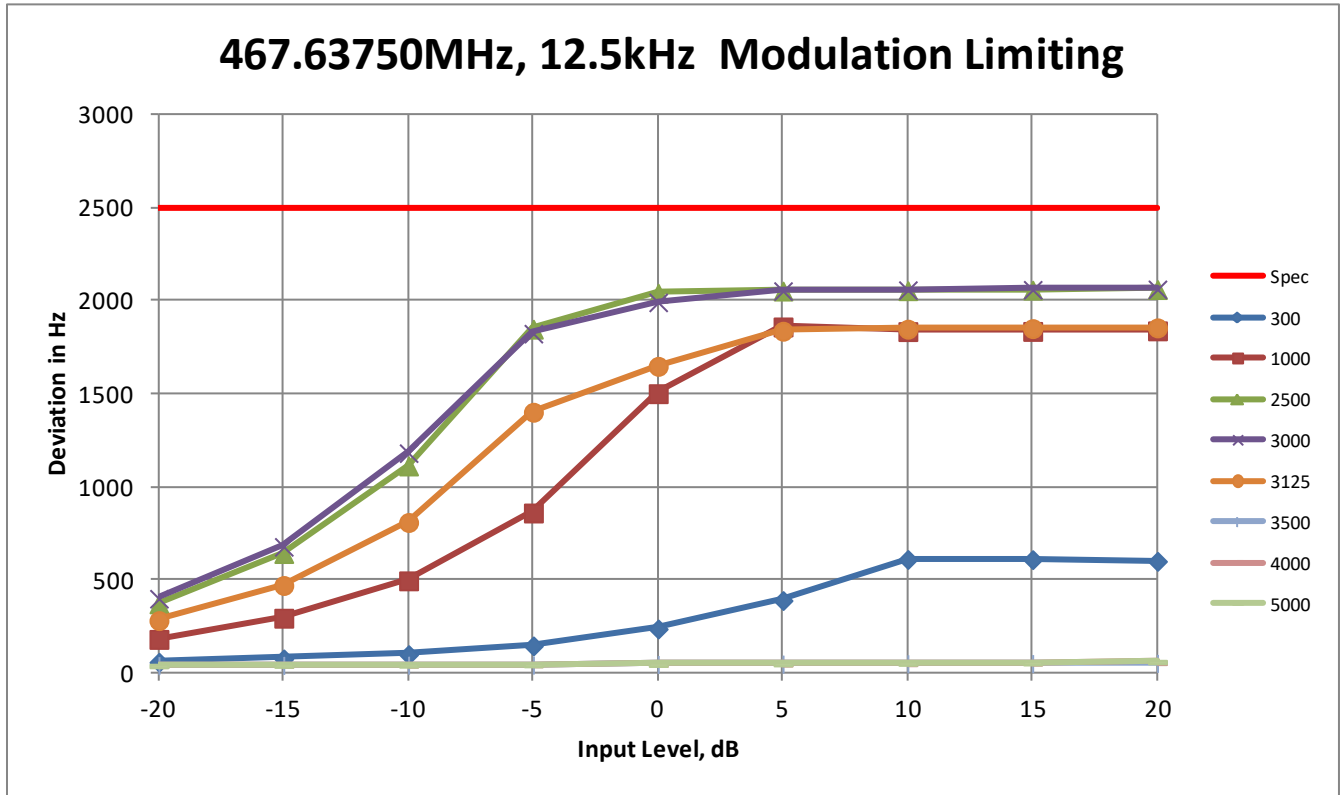

Frequency / Channel Spacing		467.6375MHz / 12.5kHz																
Voltage		4.5V																
Temperature, °C		25																
Freq Deviation, Hz	300		1000		2500		3000		3125		3500		4000		5000		Spec	
Input Level, dB	Dev, Hz	%	Dev, Hz	%	Dev, Hz	%	Dev, Hz	%	Dev, Hz	%	Dev, Hz	%	Dev, Hz	%	Dev, Hz	%	Dev, Hz	%
-20	60	2.4	183	7.3	374	15.0	402	16.1	284	11.4	42	1.7	41	1.6	40	1.6	2500	100
-15	78	3.1	297	11.9	645	25.8	681	27.2	473	18.9	43	1.7	42	1.7	42	1.7	2500	100
-10	101	4.0	498	19.9	1116	44.6	1185	47.4	812	32.5	44	1.8	43	1.7	43	1.7	2500	100
-5	148	5.9	863	34.5	1852	74.1	1828	73.1	1405	56.2	45	1.8	45	1.8	45	1.8	2500	100
0	239	9.6	1505	60.2	2045	81.8	1996	79.8	1652	66.1	48	1.9	47	1.9	47	1.9	2500	100
5	392	15.7	1864	74.6	2057	82.3	2057	82.3	1841	73.6	50	2.0	49	2.0	50	2.0	2500	100
10	613	24.5	1839	73.6	2059	82.4	2062	82.5	1852	74.1	52	2.1	51	2.0	53	2.1	2500	100
15	612	24.5	1840	73.6	2062	82.5	2064	82.6	1855	74.2	53	2.1	54	2.2	55	2.2	2500	100
20	603	24.1	1843	73.7	2065	82.6	2066	82.6	1859	74.4	54	2.2	57	2.3	61	2.4	2500	100

6.3. Audio Frequency Response

6.3.1. Test Setup

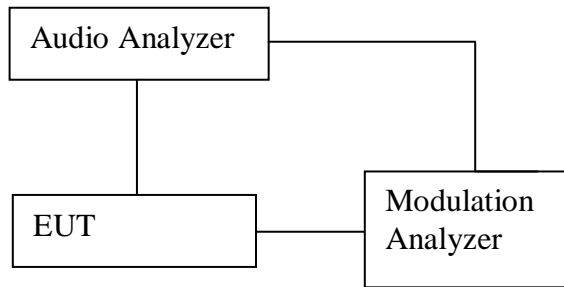

- 1) The DUT transmitter output port was connected to Modulation Analyzer.
- 2) Path loss for the measurement included.
- 3) Set the audio bandwidth filter to 15 kHz and 50kHz.
- 4) Transmit the radio and set the audio analyzer to 1 kHz audio frequency and 20% of the maximum deviation.
- 5) On audio analyzer, set the rated level as reference to zero.
- 6) Vary the audio frequency from 300Hz to 3 kHz. Record the change in dB on the audio analyzer.

6.3.2. Test Limits:

§95.575 FRS modulation limits

Each FRS transmitter type must be designed such that the peak frequency deviation does not exceed 2.5 kHz, and the highest audio frequency contributing substantially to modulation must not exceed 3.125 kHz.

§95.1775 GMRS modulation requirements

(c) 467 MHz interstitial channels. The peak frequency deviation for emissions to be transmitted on the 467 MHz interstitial channels must not exceed ± 2.5 kHz, and the highest audio frequency contributing substantially to modulation must not exceed 3.125 kHz.

6.3.3. Test Result

Frequency : 462.6375 MHz 2W

Voltage	4.5V		
Temp. (°C)	25		
Audio Frequency(Hz)	dB	HighSide Specs	LowSide Specs
100			
200			
300	-16.87	-9.4218	-17.8436
400	-11.68	-6.9316	-12.8631
500	-8.29	-5.0000	-9.0000
750	-3.47	-1.4902	-5.4902
1000	0.00	1.0000	-3.0000
1500	3.64	4.5098	0.5098
1750	4.42	5.8441	1.8441
2000	5.82	7.0000	3.0000
2500	7.36	8.9316	4.9316
2750	7.55	9.7566	4.9316
3000	7.89	10.5098	4.9316
3125			
3250			
3500			
4000			
5000			

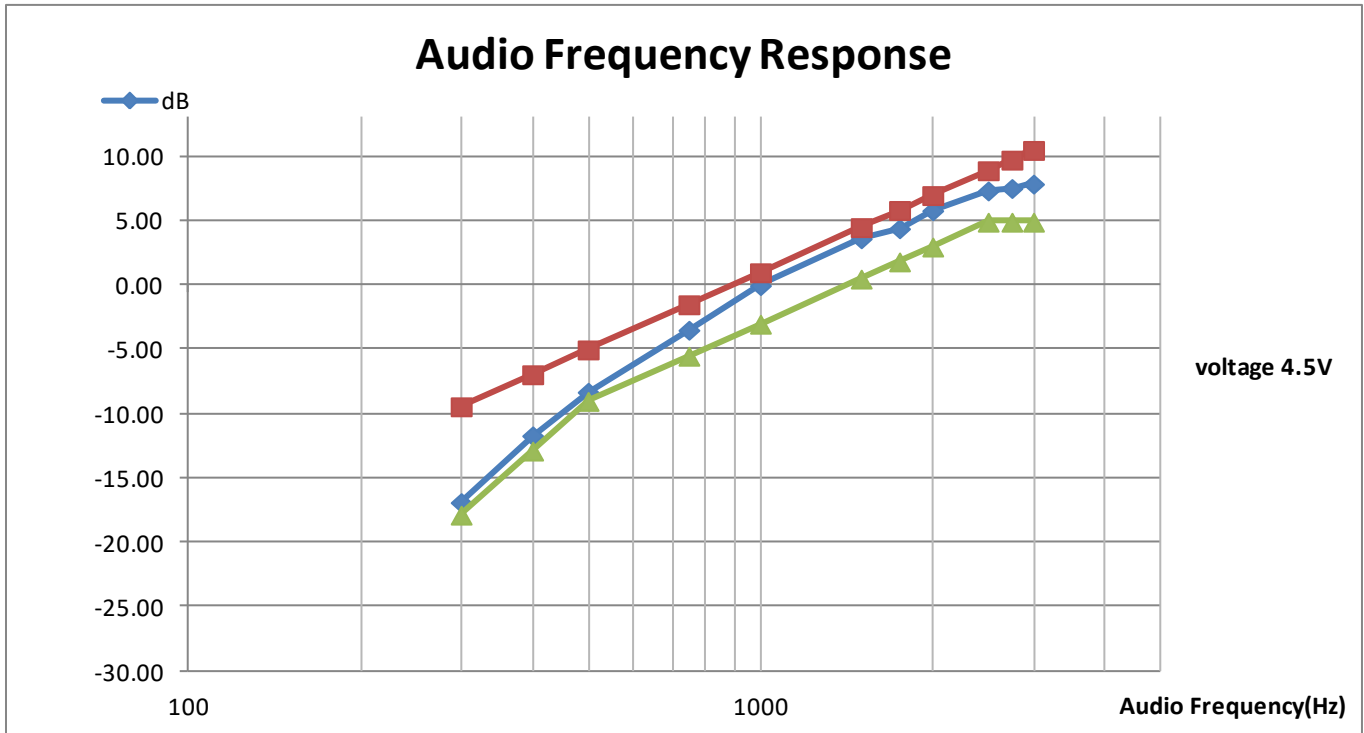

Frequency : 467.6375 MHz 0.5W

voltage	4.5 V		
Temp. (°C)	25		
Audio Frequency(Hz)	dB	HighSide Specs	LowSide Specs
100			
200			
300	-16.91	-9.4218	-17.8436
400	-11.71	-6.9316	-12.8631
500	-8.31	-5.0000	-9.0000
750	-3.48	-1.4902	-5.4902
1000	0.00	1.0000	-3.0000
1500	3.66	4.5098	0.5098
1750	4.45	5.8441	1.8441
2000	5.84	7.0000	3.0000
2500	7.39	8.9316	4.9316
2750	7.57	9.7566	4.9316
3000	7.95	10.5098	4.9316
3125			
3250			
3500			
4000			
5000			

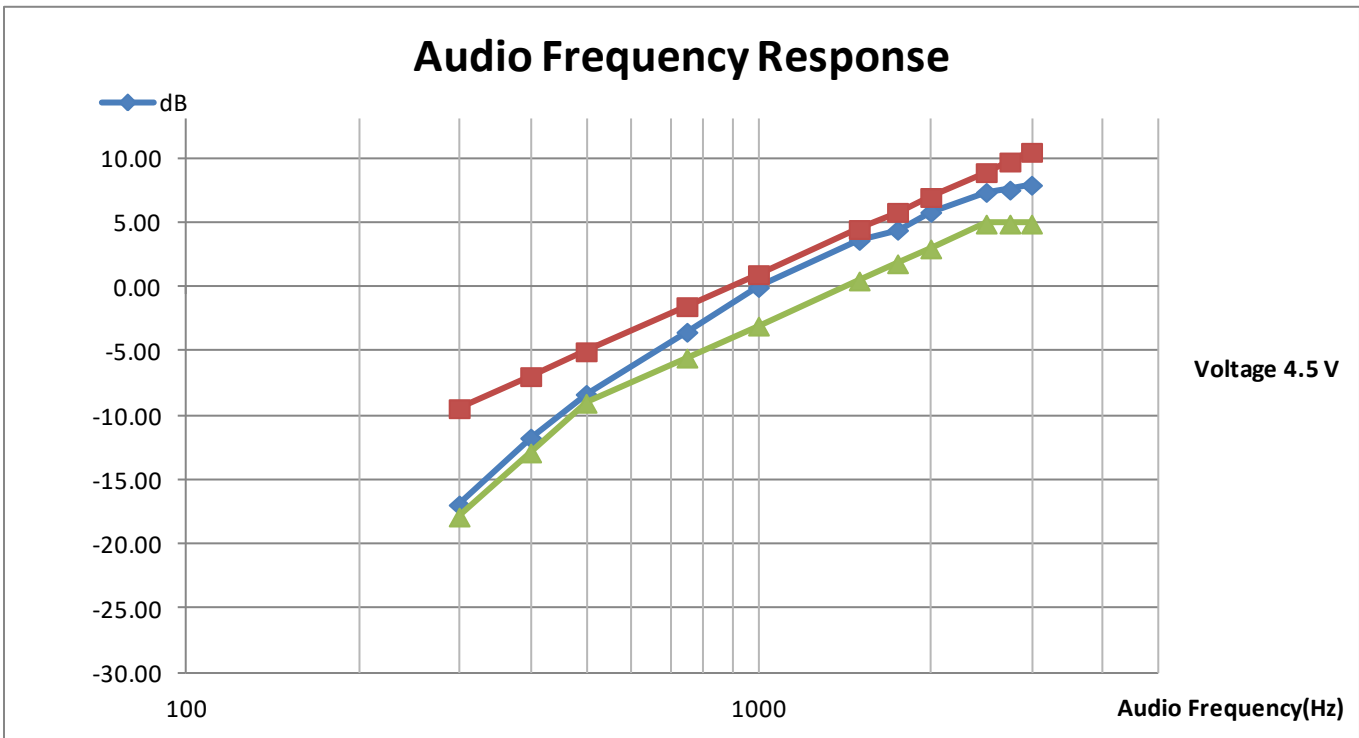

6.4. Audio Low Pass Filter

6.4.1. Test Setup

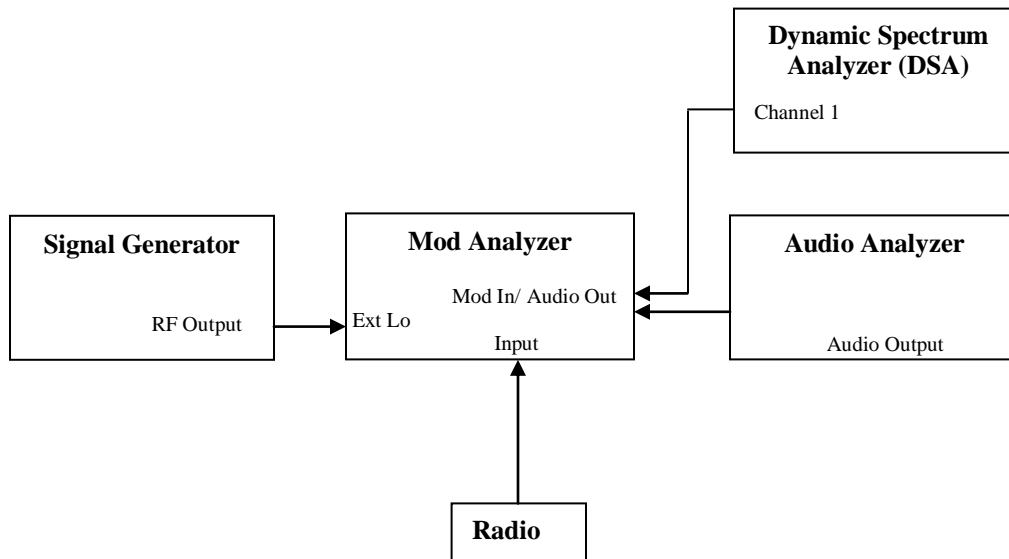

- 1) The DUT transmitter output port was connected to Modulation Analyzer.
- 2) Path loss for the measurement included.
- 3) Press 23.1SPCL on modulation analyzer to enable the external LO from Sigen.
- 4) Set the Sigen frequency to $f_c + 1.5\text{MHz}$, RF output level to 0dBm without modulation.
- 5) Transmit the radio and set the audio analyzer to 1 kHz audio frequency and 60% of the maximum deviation.
- 6) Up the amplitude by 20dB.
- 7) On DSA, get the reference point to 0dB.
- 8) Vary the frequency on audio analyzer from 3 kHz to 30 kHz, record the audio tone from DSA.

6.4.2. Test Limits:

§95.1775 GMRS modulation requirements

(e) Audio filter. Each GMRS transmitter type must include audio frequency low pass filtering, unless it complies with the applicable paragraphs of §95.1779 (without filtering).

(1) The filter must be between the modulation limiter and the modulated stage of the transmitter.

(2) At any frequency (f in kHz) between 3 and 20 kHz, the filter must have an attenuation of at least $60 \log(f/3)$ dB more than the attenuation at 1 kHz. Above 20 kHz, it must have an attenuation of at least 50 dB more than the attenuation at 1 kHz.

6.4.3. Test Result

Frequency : 462.6375 MHz 2W

voltage	4.5V	
Temp. (°C)	25	
Audio Frequency(kHz)	dB	Limit
1	0.00	0.00
3	-94.00	0.00
4	-95.87	-7.50
5	-91.85	-13.31
6	-89.57	-18.06
8	-89.64	-25.56
10	-91.67	-31.37
12	-95.34	-36.12
15	-92.63	-41.94
18	-96.31	-46.69
20	-95.30	-50.00
22	-99.28	-50.00
25	-99.89	-50.00
30	-104.25	-50.00

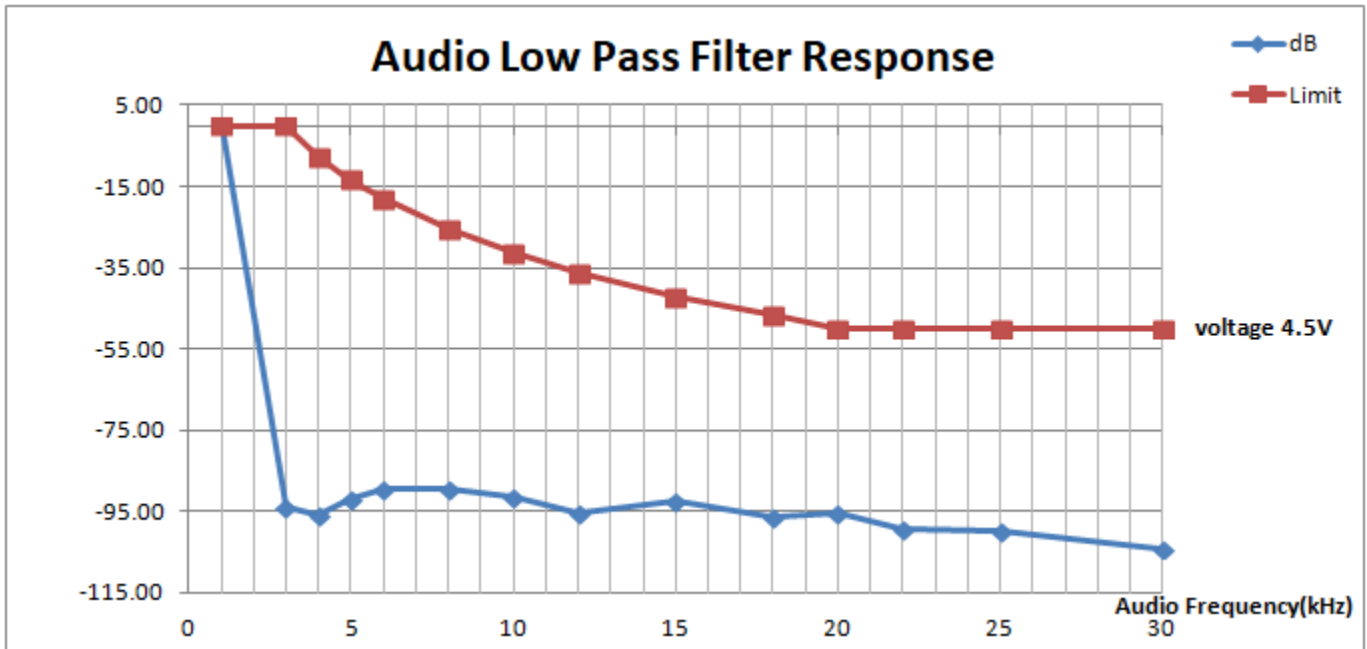

Frequency : 467.6375 MHz 0.5W

voltage	4.5 V	
Temp. (°C)	25	
Audio Frequency(kHz)	dB	Limit
1	0.00	0.00
3	-87.66	0.00
4	-98.49	-7.50
5	-98.36	-13.31
6	-91.81	-18.06
8	-94.48	-25.56
10	-90.62	-31.37
12	-93.74	-36.12
15	-85.45	-41.94
18	-98.32	-46.69
20	-95.29	-50.00
22	-99.95	-50.00
25	-102.67	-50.00
30	-103.11	-50.00

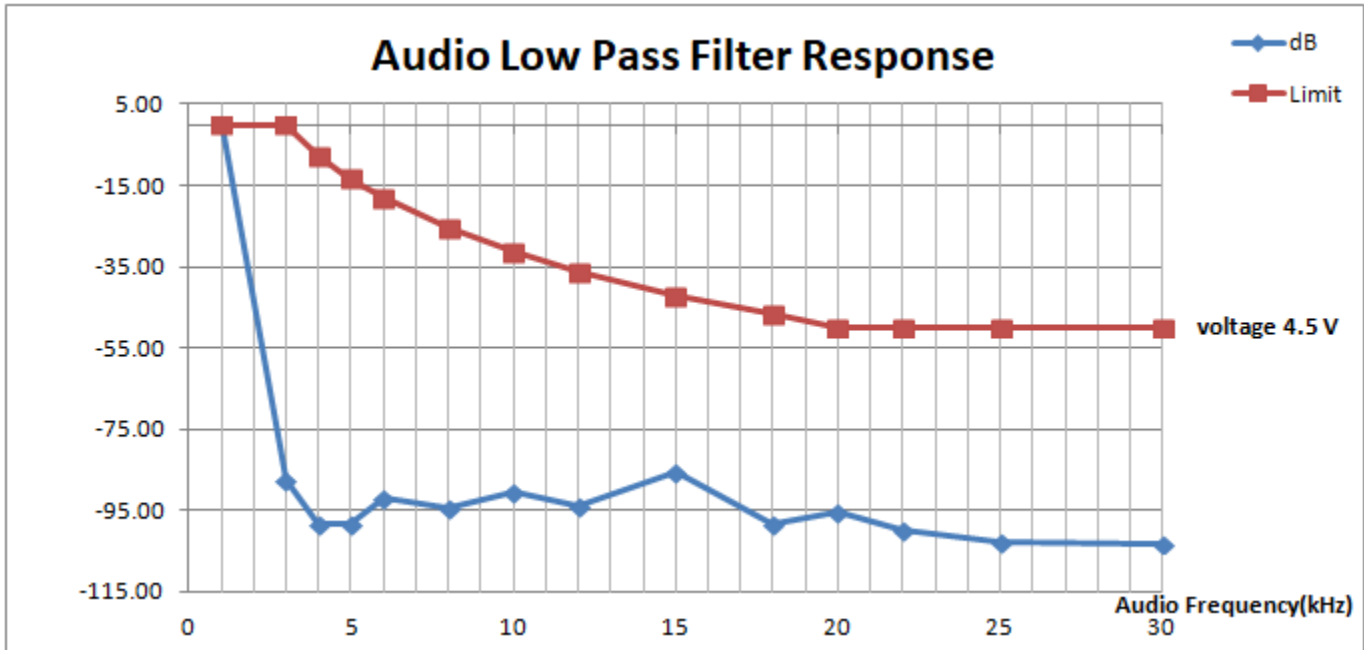

6.5. Frequency Stability

6.5.1. Test Setup

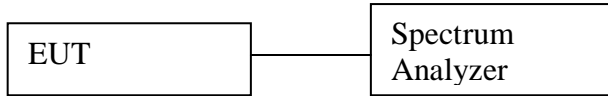

- 1) The DUT transmitter output port was connected to Modulation Analyzer.
- 2) Transmit the DUT and record the freq in MCF_{MHz} .
- 3) Test in 2 conditions: Different Temperature & Supply Voltage input.
 - Temperature: Vary from $-30^{\circ}C$ to $+50^{\circ}C$ with Nominal supply voltage.
 - Supply Voltage: Vary $\pm 15\%$ in room temperature
- 4) Calculate the ppm frequency error by the following:

$$ppm\ error = \left(\frac{MCF_{MHz}}{ACF_{MHz}} - 1 \right) * 10^6$$

Where: MCF_{MHz} is the Measured Carrier Frequency in MHz
 ACF_{MHz} is the Assigned Carrier Frequency in MHz

6.5.2. Test Limits:

§95.565 FRS frequency accuracy

Each FRS transmitter type must be designed such that the carrier frequencies remain within ± 2.5 parts-per-million of the channel center frequencies specified in §95.563 during normal operating conditions.

§95.1765 GMRS frequency accuracy

Each GMRS transmitter type must be designed to comply with the frequency accuracy requirements in this section under normal operating conditions. Operators of GMRS stations must also ensure compliance with these requirements.

- (a) The carrier frequency of each GMRS transmitter transmitting an emission with an occupied bandwidth greater than 12.5 kHz must remain within 5 parts-per-million (ppm) of the channel center frequencies listed in §95.1763 under normal operating conditions.
- (b) The carrier frequency of each GMRS transmitter transmitting an emission with an occupied bandwidth of 12.5 kHz or less must remain within 2.5 ppm of the channel center frequencies listed in §95.1763 under normal operating conditions.

6.5.3. Test Result

(i) Frequency Stability VS Voltage

Frequency / Channel Spacing	462.6375 MHz / 12.5kHz				
Temperature, °C	25				
Voltage %	Voltage, V	Frequency, MHz	Frequency Stability, PPM	Spec (low) PPM	Spec (high) PPM
-20	3.600	462.637610	0.238	-2.500	2.500
-15	3.825	462.637610	0.238	-2.500	2.500
-10	4.050	462.637620	0.259	-2.500	2.500
-5	4.275	462.637610	0.238	-2.500	2.500
0	4.500	462.637620	0.259	-2.500	2.500
5	4.725	462.637600	0.216	-2.500	2.500
10	4.950	462.637600	0.216	-2.500	2.500
15	5.175	462.637590	0.195	-2.500	2.500
20	5.400	462.637590	0.195	-2.500	2.500

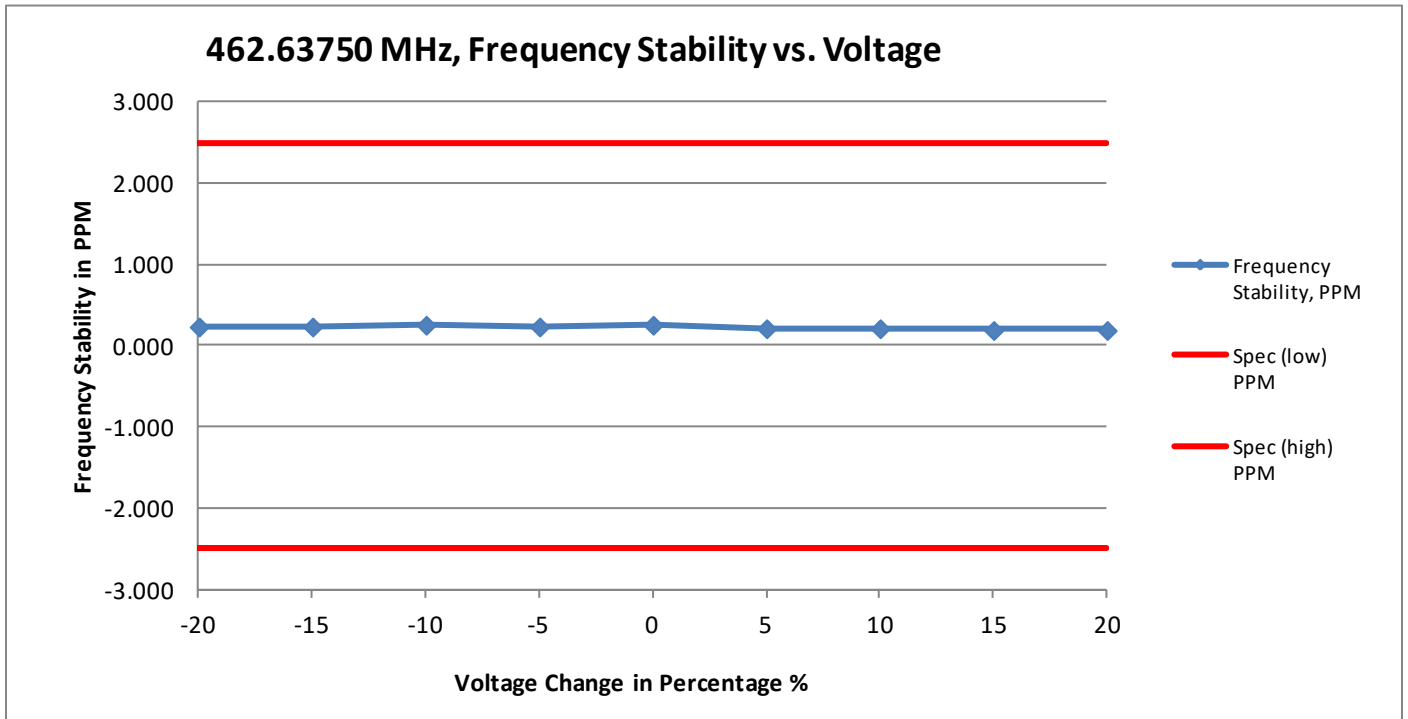

(ii) Frequency Stability VS temperature

Frequency / Channel Spacing	462.6375 MHz / 12.5kHz			
Voltage, V	4.5			
Temperature, °C	Frequency, MHz	Frequency Stability, PPM	Spec (low) PPM	Spec (high) PPM
-30	462.637470	-0.065	-2.500	2.500
-20	462.637490	-0.022	-2.500	2.500
-10	462.637540	0.086	-2.500	2.500
0	462.637590	0.195	-2.500	2.500
10	462.637600	0.216	-2.500	2.500
20	462.637620	0.259	-2.500	2.500
30	462.637650	0.324	-2.500	2.500
40	462.637630	0.281	-2.500	2.500
50	462.637600	0.216	-2.500	2.500
60	462.637640	0.303	-2.500	2.500

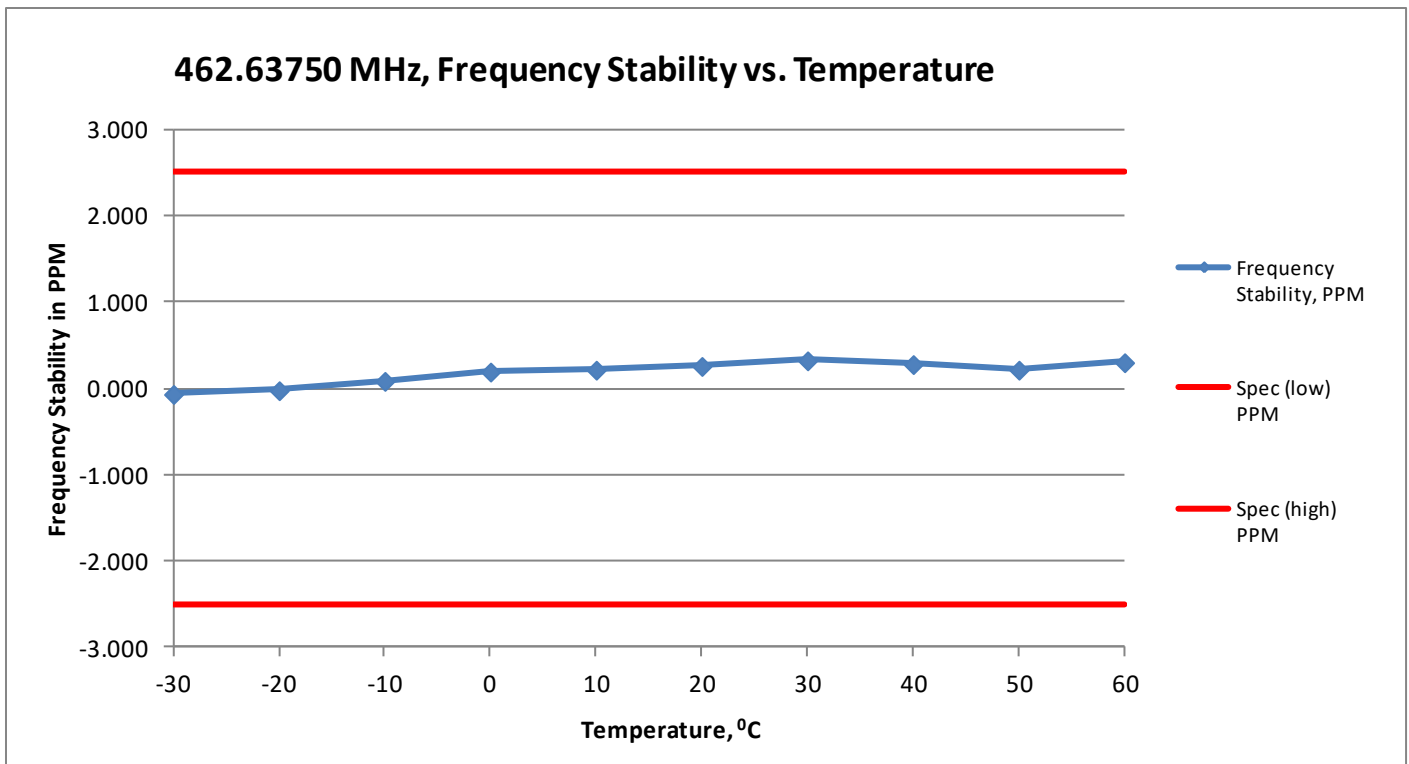

(i) Frequency Stability VS Voltage

Frequency / Channel Spacing	467.6375 MHz / 12.5kHz				
Temperature, °C	25				
Voltage %	Voltage, V	Frequency, MHz	Frequency Stability, PPM	Spec (low) PPM	Spec (high) PPM
-20	3.600	467.637610	0.235	-2.500	2.500
-15	3.825	467.637620	0.257	-2.500	2.500
-10	4.050	467.637620	0.257	-2.500	2.500
-5	4.275	467.637620	0.257	-2.500	2.500
0	4.500	467.637630	0.278	-2.500	2.500
5	4.725	467.637630	0.278	-2.500	2.500
10	4.950	467.637610	0.235	-2.500	2.500
15	5.175	467.637630	0.278	-2.500	2.500
20	5.400	467.637610	0.235	-2.500	2.500

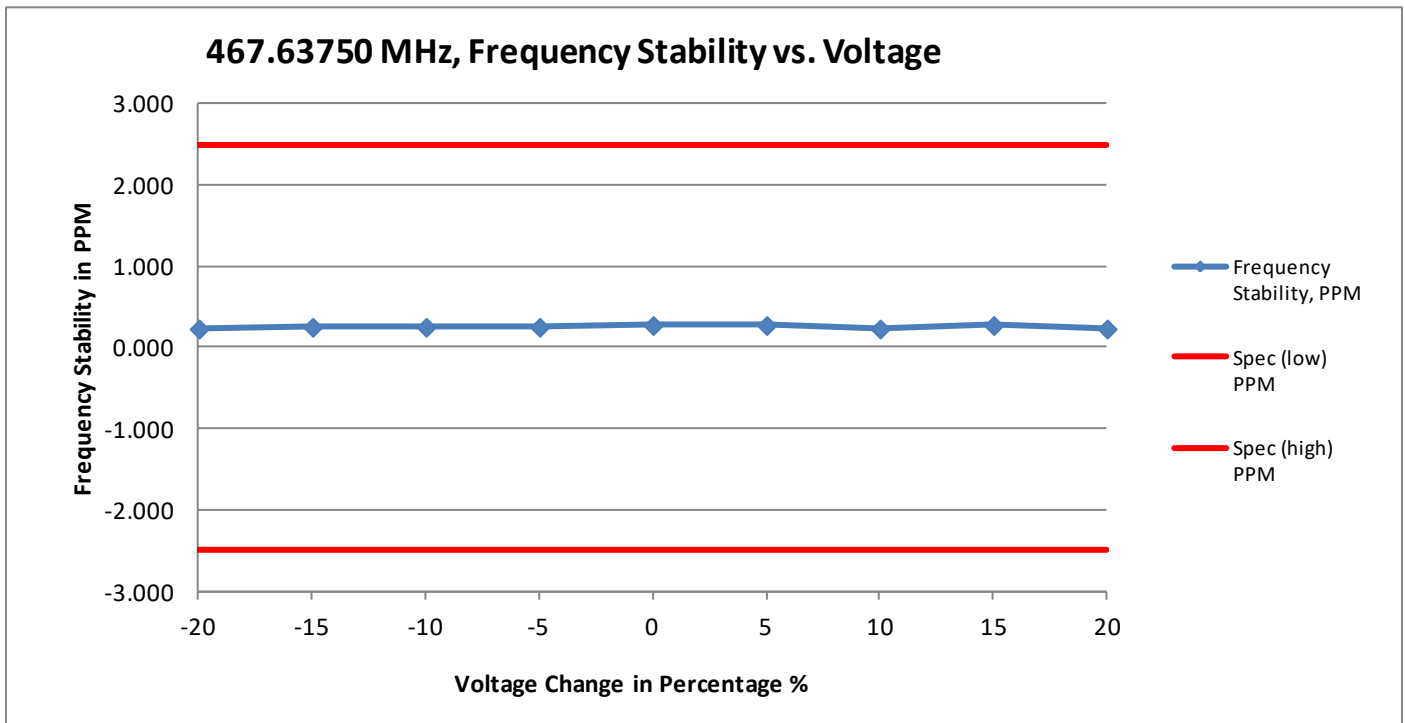

(ii) Frequency Stability VS temperature

Frequency / Channel Spacing	467.6375 MHz / 12.5kHz			
Voltage, V	4.5			
Temperature, °C	Frequency, MHz	Frequency Stability, PPM	Spec (low) PPM	Spec (high) PPM
-30	467.637620	0.257	-2.500	2.500
-20	467.637480	-0.043	-2.500	2.500
-10	467.637500	0.000	-2.500	2.500
0	467.637540	0.086	-2.500	2.500
10	467.637590	0.192	-2.500	2.500
20	467.637600	0.214	-2.500	2.500
30	467.637640	0.299	-2.500	2.500
40	467.637650	0.321	-2.500	2.500
50	467.637630	0.278	-2.500	2.500
60	467.637610	0.235	-2.500	2.500

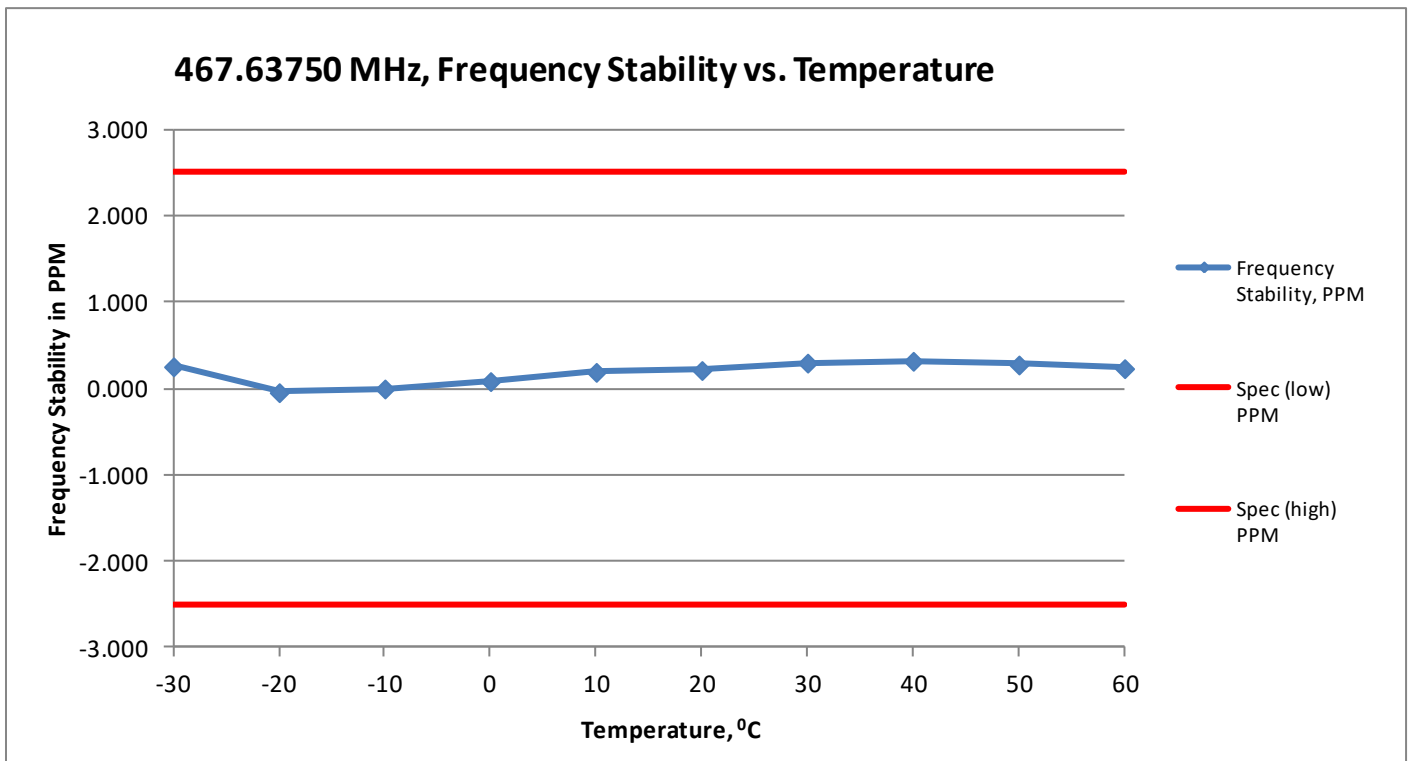

6.6. Emission Mask

6.6.1. Test Setup

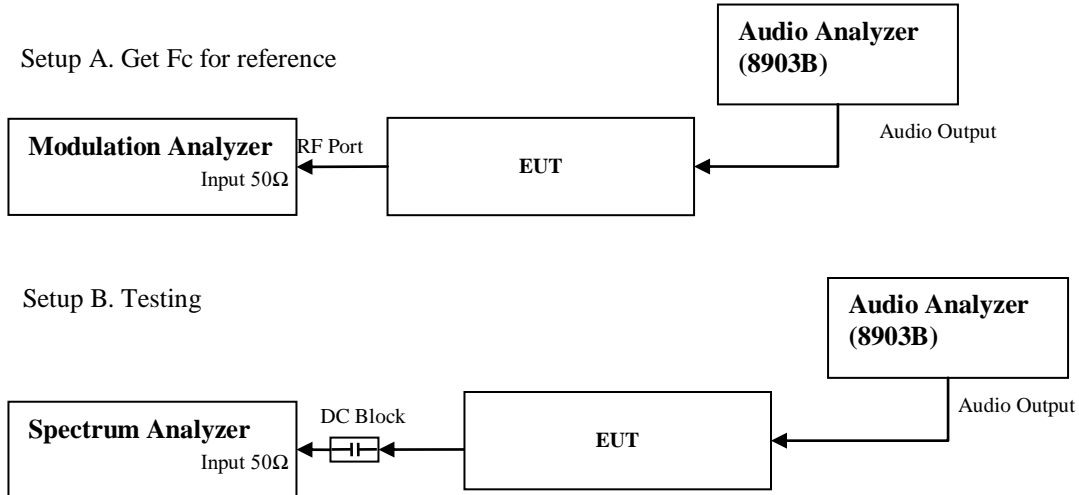

- 1) The DUT transmitter output port was connected to Modulation Analyzer.
- 2) Path loss for the measurement included.
- 3) Key in the Fc to assigned center frequency with the span 100 kHz.
- 4) Set the spectrum analyzer with RBW= 300Hz and VBW= 900Hz.
- 5) Transmit the UUT and record the result.
- 6) Set modulation analyzer audio bandwidth filter to 15 kHz low pass filter and 50 kHz high pass filter.
- 7) Transmit the radio and set the audio analyzer to 2.5 kHz audio frequency and 60% of the maximum deviation.
- 8) Up the amplitude by 16dB and remove the audio tone from audio analyzer.
- 9) Capture the screen shot with and without modulation.

6.6.2. Test Limits:

§95.579 FRS unwanted emissions limits

Each FRS transmitter type must be designed to satisfy the applicable unwanted emissions limits in this paragraph.

(a) Attenuation requirements. The power of unwanted emissions must be attenuated below the carrier power output in Watts (P) by at least:

(1) 25 dB (decibels) in the frequency band 6.25 kHz to 12.5 kHz removed from the channel center frequency.

(2) 35 dB in the frequency band 12.5 kHz to 31.25 kHz removed from the channel center frequency.

(3) $43 + 10 \log (P)$ dB in any frequency band removed from the channel center frequency by more than 31.25 kHz.

(b) Measurement bandwidths. The power of unwanted emissions in the frequency bands specified in paragraphs (a)(1) and (2) of this section is measured with a reference bandwidth of 300 Hz. The power of unwanted emissions in the frequency range specified in paragraph (a)(3) is measured with a reference bandwidth of at least 30 kHz.

(c) Measurement conditions. The requirements in this section apply to each FRS transmitter type both with and without the connection of permitted attachments, such as an external speaker, microphone and/or power cord.

§95.1779 GMRS unwanted emissions limits (1), (2), (7)

Each GMRS transmitter type must be designed to comply with the applicable unwanted emissions limits in this section.

(a) Emission masks. Emission masks applicable to transmitting equipment in the GMRS are defined by the requirements in the following table. The numbers in the attenuation requirements column refer to rule paragraph numbers under paragraph (b) of this section.

Emission types filter	Attenuation requirements
A1D, A3E, F1D, G1D, F2D, F3E, G3E with audio filter	(1), (2), (7)
A1D, A3E, F1D, G1D, F3E, G3E without audio filter	(3), (4), (7)
H1D, J1D, R1D, H3E, J3E, R2E	(5), (6), (7)

(1) Filtering noted for GMRS transmitters refers to the requirement in §95.1775(e).

(2) Unwanted emission power may be measured as either mean power or peak envelope power, provided that the transmitter output power is measured the same way.

(b) Attenuation requirements. The power of unwanted emissions must be attenuated below the transmitter output power in Watts (P) by at least:

(1) 25 dB (decibels) on any frequency removed from the center of the authorized bandwidth by more than 50% up to and including 100% of the authorized bandwidth.

(2) 35 dB on any frequency removed from the center of the authorized bandwidth by more than 100% up to and including 250% of the authorized bandwidth.

(3) $83 \log (fd \div 5)$ dB on any frequency removed from the center of the authorized bandwidth by a displacement frequency (fd in kHz) of more than 5 kHz up to and including 10 kHz.

- (4) $116 \log (f_d \div 6.1)$ dB or $50 + 10 \log (P)$ dB, whichever is the lesser attenuation, on any frequency removed from the center of the authorized bandwidth by a displacement frequency (f_d in kHz), of more than 10 kHz up to and including 250% of the authorized bandwidth.
- (5) 25 dB on any frequency removed from the center of the authorized bandwidth by more than 50% up to and including 150% of the authorized bandwidth.
- (6) 35 dB on any frequency removed from the center of the authorized bandwidth by more than 150% up to and including 250% of the authorized bandwidth.
- (7) $43 + 10 \log (P)$ dB on any frequency removed from the center of the authorized bandwidth by more than 250%.
- (c) Measurement bandwidths. The power of unwanted emissions in the frequency bands specified in paragraphs (b)(1) through (4) of this section is measured with a reference bandwidth of 300 Hz. The power of unwanted emissions in the frequency range specified in paragraph (b)(5) of this section is measured with a reference bandwidth of at least 30 kHz.
- (d) Measurement conditions. The requirements in this section apply to each GMRS transmitter type both with and without the connection of permitted attachments, such as an external speaker, microphone, power cord and/or antenna.

Bandwidth Calculations

Carson's Rule for FM Modulation is utilized to compute the bandwidth shown in the FCC emission designator.
Carson's Rule is $BW = 2 * (M + D)$ where BW is bandwidth
M = Maximum Modulating Frequency
D = Maximum Deviation

Standard Audio Modulation (12.5 kHz channelization, analog voice)

Emission Designator: 11K0F3E

$BW = 2*(M+D) = 2*(3.0\text{kHz} + 2.5\text{kHz}) = 11\text{kHz} = 11\text{K0}$
F3E indicates voice

6.6.1. Test Data

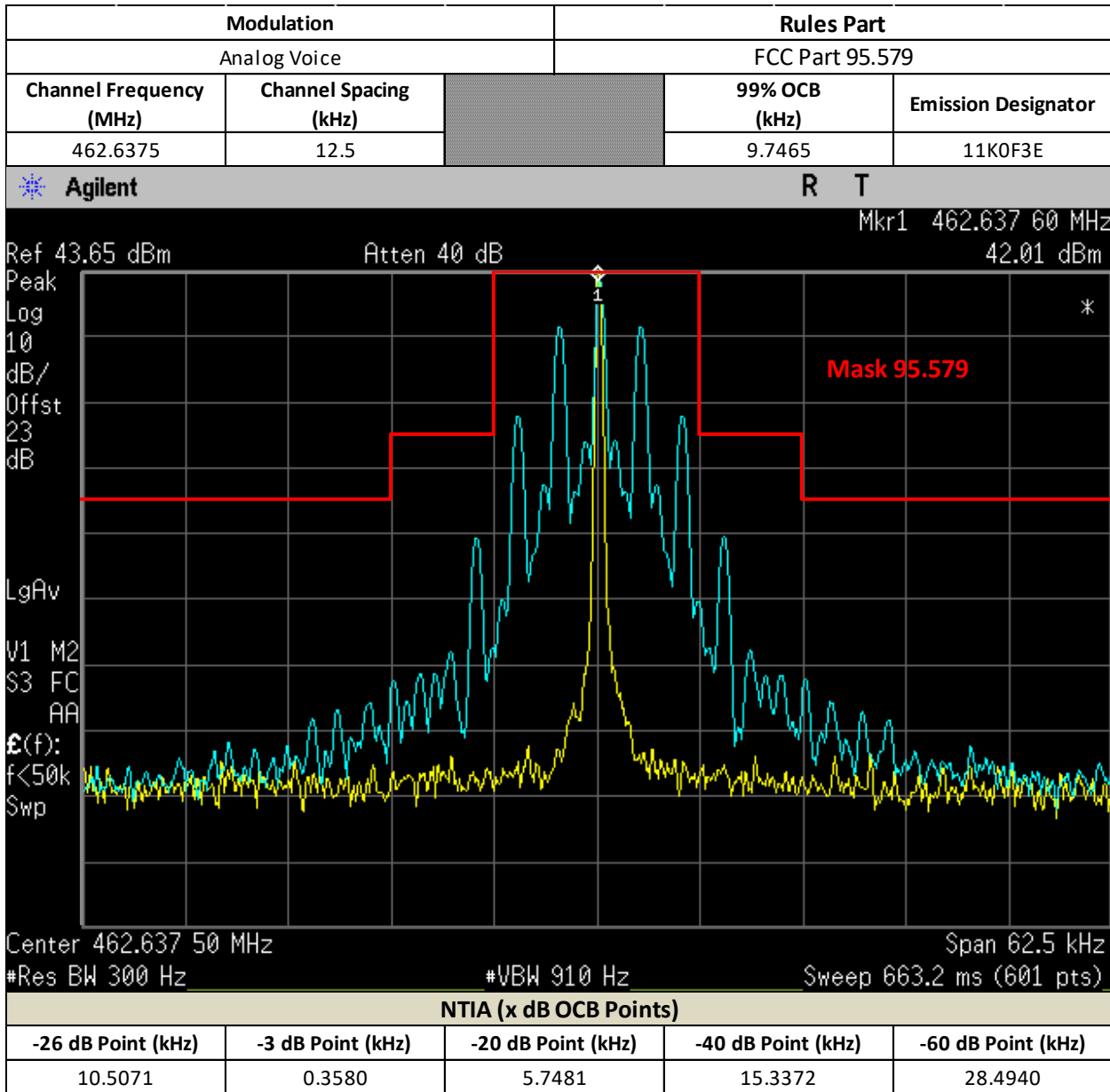

Note: For FRS FCC.

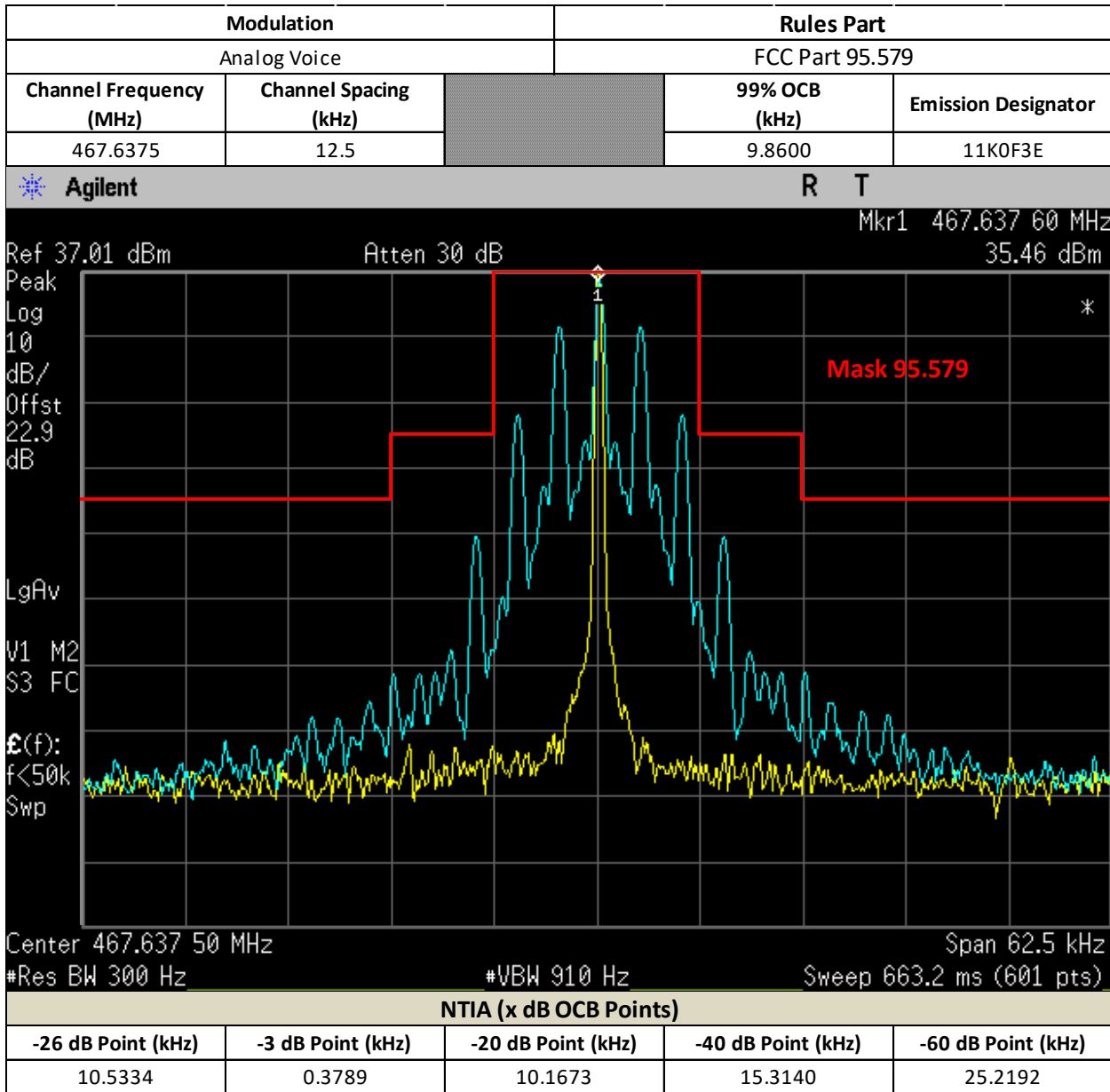

Note: For FRS FCC.

6.7. Radiated Spurious Emission

6.7.1. Test Setup

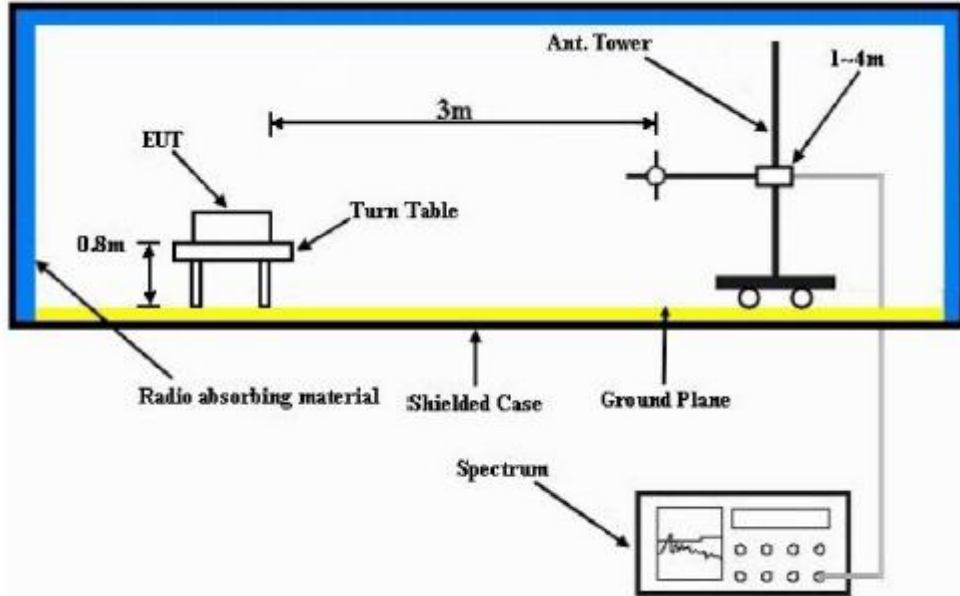

- 1) The spectrum setting for scanning Radiated Emission below 1 GHz is RBW = 100 kHz, VBW = 300 kHz and above 1 GHz is RBW = 1 MHz, VBW = 3 MHz. Detector mode is positive peak.
- 2) In the semi-anechoic chamber, setup as illustrated above the EUT placed on the 0.8m height (for frequencies < 1GHz) or 1.5m (for frequencies > 1GHz) of Turn Table, rotated the table around 360 degrees to search the maximum radiation power and receiver antenna shall be rotated vertical and horizontal polarization and moved height from 1m to 4m to find the maximum polar radiated power. The “Read Value” is the spectrum reading the maximum power value.
- 3) The substitution antenna is substituted for EUT at the same position and signals generator (S.G) export the CW signal to the substitution antenna via a TX cable. The receiver antenna shall be rotated vertical and horizontal polarization and moved height from 1m to 4m to find the maximum radiation power. Record the power level of maximum radiation power from spectrum. So, the measured substitution value = Ref level of S.G + TX cables loss – Substituted Antenna Gain.
- 4) Final Radiated Spurious Emission = “Read Value” + Measured substitution value.

6.7.2. Test Result

SAC Transmitter Radiated Emission:

Model Number: T482 S/N: 1654VU0017 SR:18949-EMC-00006
 Battery Part No: 1532 Accy Part No: NA
 Test Mode: TX Analog
 462.637500 MHz 12.5 kHz 2.000 Watt(s) /Max Power

Frequency (MHz)	Limit	Horizontal Measured Emission Equiv Pwr Into Ideal Dipole (dBm)	Vertical Measured Emission Equiv Pwr Into ideal Dipole (dBm)
925.2750	-13.0000	-34.2300 *	-20.7700*
1387.9125	-13.0000	-51.1200 *	-47.9700 *
1850.5500	-13.0000	-48.9700 *	-45.4400 *
2313.1870	-13.0000	-44.7600 *	-39.2100 *
2775.8250	-13.0000	-38.3500 *	-39.4400 *
3238.4625	-13.0000	-48.4255 **	-49.1603 **
3701.1000	-13.0000	-40.3600 *	-43.3500 *
4163.7375	-13.0000	-40.8600 *	-41.5500 *
4626.3750	-13.0000	-47.5996 **	-47.9120 **

RADIATED SPURIOUS EMISSIONS

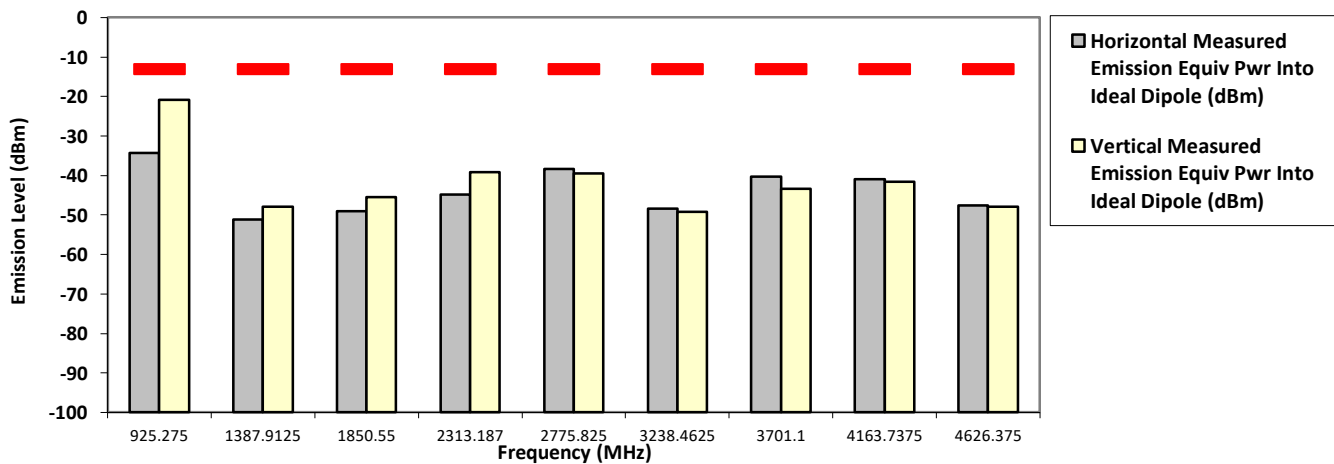

The data presented here was taken using the substitution method as found in the ANSI C63.26-2015 document.
 Motorola Penang EMC Lab - Test Performed by: Nazrin&Qawiman Mon, Oct 21, 2019

Remarks: ** Indicates the spurious emission could not be detected due to noise limitations or ambient.
 *Pursuant to CFR 47 Part 2.1057 (c), emissions attenuated more than 20 dB below the permissible limit are not reported
 Temp(Deg): 23.1 Hum(%RH): 69.9

System MU: 5.01 dB

Remarks: Passed Results Marginal Results Failed Results

SAC Transmitter Radiated Emission:

Model Number: T482 **S/N: 1654VU0017** **SR:18949-EMC-00006**
Battery Part No: 1532 **Accy Part No: NA**
467.637500 MHz **Test Mode: TX Analog** **0.500 Watt(s) /Max Power**
12.5 kHz

Frequency (MHz)	Limit	Horizontal Measured Emission Equiv Pwr Into Ideal Dipole (dBm)	Vertical Measured Emission Equiv Pwr Into ideal Dipole (dBm)
935.2750	-13.0000	-33.2300 *	-21.9100*
1402.9125	-13.0000	-50.5800 *	-43.1200 *
1870.5500	-13.0000	-51.5500 *	-46.3600 *
2338.1875	-13.0000	-49.3100 *	-43.0900 *
2805.8250	-13.0000	-48.1000 *	-47.1000 *
3273.4625	-13.0000	-51.8554 **	-49.9080 **
3741.1000	-13.0000	-43.9400 *	-43.9000 *
4208.7375	-13.0000	-49.5386 **	-47.9836 **
4676.3750	-13.0000	-49.1493 **	-48.7161 **

RADIATED SPURIOUS EMISSIONS

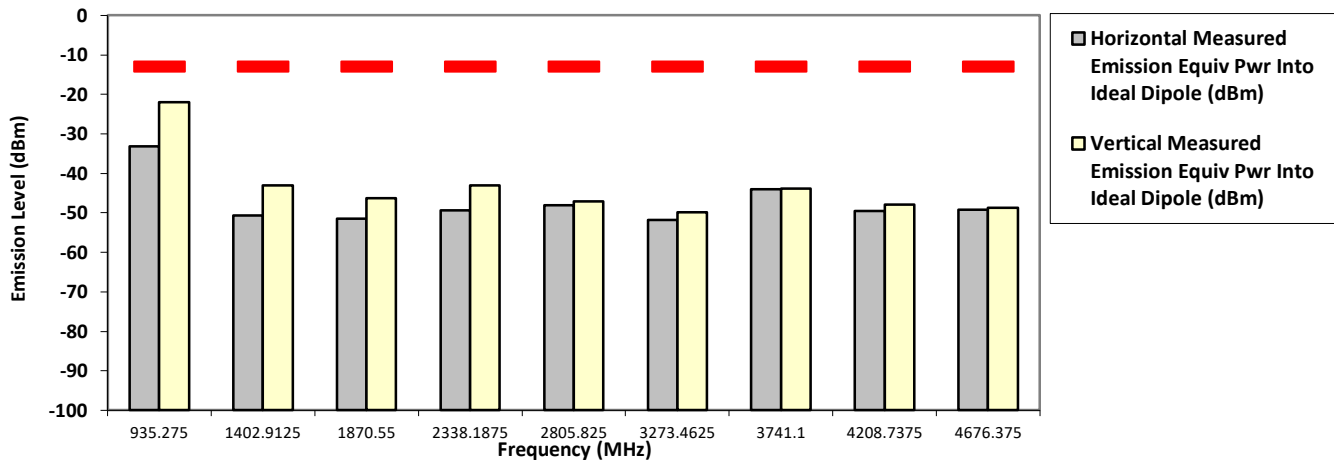

The data presented here was taken using the substitution method as found in the ANSI C63.26-2015 document.
 Motorola Penang EMC Lab - Test Performed by: Nazrin&Qawiman Mon, Oct 21, 2019

Remarks: ** Indicates the spurious emission could not be detected due to noise limitations or ambient.

*Pursuant to CFR 47 Part 2.1057 (c), emissions attenuated more than 20 dB below the permissible limit are not reported
 Temp(Deg): 23.1 Hum(%RH): 69.9

System MU: 5.01 dB

Remarks: Passed Results Marginal Results Failed Results

6.7.3. Test limit

At least $43 + 10 \log_{10}(T)$ dB on any frequency removed from the center of the authorized bandwidth by more than 250%.

§95.579 FRS unwanted emissions limits

Each FRS transmitter type must be designed to satisfy the applicable unwanted emissions limits in this paragraph.

(a) Attenuation requirements. The power of unwanted emissions must be attenuated below the carrier power output in Watts (P) by at least:

- (1) 25 dB (decibels) in the frequency band 6.25 kHz to 12.5 kHz removed from the channel center frequency.
- (2) 35 dB in the frequency band 12.5 kHz to 31.25 kHz removed from the channel center frequency.
- (3) $43 + 10 \log(P)$ dB in any frequency band removed from the channel center frequency by more than 31.25 kHz.

(b) Measurement bandwidths. The power of unwanted emissions in the frequency bands specified in paragraphs (a)(1) and (2) of this section is measured with a reference bandwidth of 300 Hz. The power of unwanted emissions in the frequency range specified in paragraph (a)(3) is measured with a reference bandwidth of at least 30 kHz.

(c) Measurement conditions. The requirements in this section apply to each FRS transmitter type both with and without the connection of permitted attachments, such as an external speaker, microphone and/or power cord.

§95.1779 GMRS unwanted emissions limits (1), (2), (7)

Each GMRS transmitter type must be designed to comply with the applicable unwanted emissions limits in this section.

(a) Emission masks. Emission masks applicable to transmitting equipment in the GMRS are defined by the requirements in the following table. The numbers in the attenuation requirements column refer to rule paragraph numbers under paragraph (b) of this section.

Emission types filter	Attenuation requirements
A1D, A3E, F1D, G1D, F2D, F3E, G3E with audio filter	(1), (2), (7)
A1D, A3E, F1D, G1D, F3E, G3E without audio filter	(3), (4), (7)
H1D, J1D, R1D, H3E, J3E, R2E	(5), (6), (7)

(1) Filtering noted for GMRS transmitters refers to the requirement in §95.1775(e).

(2) Unwanted emission power may be measured as either mean power or peak envelope power, provided that the transmitter output power is measured the same way.

(b) Attenuation requirements. The power of unwanted emissions must be attenuated below the transmitter output power in Watts (P) by at least:

- (1) 25 dB (decibels) on any frequency removed from the center of the authorized bandwidth by more than 50% up to and including 100% of the authorized bandwidth.

(2) 35 dB on any frequency removed from the center of the authorized bandwidth by more than 100% up to and including 250% of the authorized bandwidth.

(3) $83 \log (fd \div 5)$ dB on any frequency removed from the center of the authorized bandwidth by a displacement frequency (fd in kHz) of more than 5 kHz up to and including 10 kHz.

(4) $116 \log (fd \div 6.1)$ dB or $50 + 10 \log (P)$ dB, whichever is the lesser attenuation, on any frequency removed from the center of the authorized bandwidth by a displacement frequency (fd in kHz), of more than 10 kHz up to and including 250% of the authorized bandwidth.

(5) 25 dB on any frequency removed from the center of the authorized bandwidth by more than 50% up to and including 150% of the authorized bandwidth.

(6) 35 dB on any frequency removed from the center of the authorized bandwidth by more than 150% up to and including 250% of the authorized bandwidth.

(7) $43 + 10 \log (P)$ dB on any frequency removed from the center of the authorized bandwidth by more than 250%.

(c) Measurement bandwidths. The power of unwanted emissions in the frequency bands specified in paragraphs (b)(1) through (4) of this section is measured with a reference bandwidth of 300 Hz. The power of unwanted emissions in the frequency range specified in paragraph (b)(5) of this section is measured with a reference bandwidth of at least 30 kHz.

(d) Measurement conditions. The requirements in this section apply to each GMRS transmitter type both with and without the connection of permitted attachments, such as an external speaker, microphone, power cord and/or antenna.

- End of Test Report -