 MS ISO/IEC 17025 TESTING SAMM No. 0825
---	---

<p><b>MOTOROLA PENANG ADV. COMM. LABORATORY</b>                  Motorola Solutions Malaysia Sdn Bhd                  Innoplex Plot 2A, Medan Bayan Lepas,                  Mukim 12 S.W.D, 11900 Bayan Lepas,                  Penang, Malaysia.</p>	<p><b>FCC / ISED TEST REPORT</b>  <b>Report Revision : Rev.C</b></p>
---	--

<p><b>Date/s Tested</b> : 13-MAY-2019 - 17-MAY-2019  <b>Report Issue Date</b> : 05-AUG-2019  <b>Manufacturer/Location</b> : Motorola Solutions Malaysia Sdn Bhd  <b>Requestor</b> : SUBRAMANIAM VASU  <b>Product Type</b> : Portable  <b>Model Number</b> : LAH87YDC9JA2AN  <b>Frequency Band</b> : 403-480MHz  <b>Low / Max RF Output Power</b> : 1Watts /4.8Watts  <b>Application Name</b> : Motorola Solutions Inc  <b>Manufacturer Address</b> : Plot 2, Bayan Lepas Technoplex, 11900 Bayan Lepas,                  Penang, Malaysia  <b>ISED Registrations</b> : 109AK  <b>FCC Registrations</b> : 461337  <b>Firmware Version</b> : R01.01.40.0000</p> <p><b>The equipment was tested accordance to the requirement listed below:</b></p> <p><b>(LMR )</b>  <b>FCC 47 CFR Part 22/90</b></p>	
<p style="text-align: right;"><b>PASS</b></p>	

This report shall not be reproduced without written approval from an officially designated representative of the Motorola Penang Adv. Comm. Laboratory. The results and statements contained in this report pertain only to the device(s) evaluated.

<p>Prepared By:</p> <p>_____</p> <p><b>Tan Sze Khai</b>  <b>Test Personnel</b></p>	<p>Approved By:</p> <p>_____</p> <p><b>Vincent Foong Chuen Kit</b>  <b>Deputy Technical Manager</b></p>
--	---

## Table of Contents

Report Revision History .....	3
1.0 General Information .....	4
2.0 Summary of Test Results .....	5
3.0 Measurement Uncertainty .....	6
4.0 Equipment List.....	7
5.0 Test Condition .....	10
5.1. Transmitter Test Conditions .....	10
6.0 Transmitter Test Parameters .....	11
6.1. RF Output Power .....	11
6.1.1. Test Setup.....	11
6.1.2. Test Result.....	11
6.2. Frequency Stability .....	12
6.2.1. Test Setup.....	12
6.2.2. Test Result.....	13
6.2.3. Test Limit.....	15
6.3. Audio Frequency Response .....	16
6.3.1. Test Setup.....	16
6.3.2. Test Result.....	17
6.3.3. Test Limit.....	19
6.4. Audio Low Pass Filter Response .....	20
6.4.1. Test Setup.....	20
6.4.2. Test Result.....	21
6.4.3. Test Limit.....	23
6.5. Modulation Limiting .....	24
6.5.1. Test Setup.....	24
6.5.2. Test Result.....	25
6.5.3. Test Limit.....	26
6.6. Occupied Bandwidth.....	27
6.6.1. Test Setup (Analog).....	27
6.6.2. Test Result (Analog).....	28
6.6.3. Test Setup (Digital) .....	33
6.6.4. Test Result (Digital ) .....	34
6.6.5. Test Limit.....	38
6.7. Band Edge Conducted Spurious Emission (Part 22).....	39
6.7.1. Test Setup (Analog).....	39
6.7.2. Test Result (Analog).....	40
6.7.3. Test Setup (Digital) .....	41
6.7.4. Test Result (Digital) .....	42
6.7.5. Test Limit.....	42
6.8. Transient Frequency Behavior.....	43
6.8.1. Test Setup.....	43
6.8.2. Test Result.....	44
6.8.3. Test Limit.....	46

6.9. Adjacent Channel Power ..... 47

6.9.1. Test Setup (Analog)..... 47

6.9.2. Test Result..... 47

6.9.3. Test Setup (Digital) ..... 48

6.9.4. Test result..... 48

6.9.5. Test limit ..... 48

6.10. Conducted Spurious Emission ..... 50

6.10.1. Test Setup..... 50

6.10.2. Test Result (Analog)..... 51

6.10.3. Test Result (Digital) ..... 61

6.10.4. Test Limit..... 71

6.11. Radiated Spurious Emission ..... 72

6.11.1. Test Setup..... 72

6.11.1. Test Result (Analog)..... 73

6.11.2. Test Result (Digital) ..... 89

6.11.3. Test Limit..... 101

6.12. Effective Radiated Power (ERP)..... 102

6.12.1. Test Setup..... 102

6.12.2. Test Result..... 102

6.12.3. Test Limit..... 102

6.13. GNSS (EIRP for 1559 - 1610MHz)..... 103

6.13.1. Test Setup..... 103

6.13.1. Test Result..... 103

6.13.2. Test Limit..... 104

**Report Revision History**

<b>Revision History</b>	<b>Description</b>	<b>Date</b>	<b>Originator</b>
Rev. A	Initial Report	20-MAY-2019	Tan Sze Khai
Rev. B	Removed RSS information, added digital information	16-AUG-2019	Vincent Foong
Rev. C	Added part 2, 22 and 90 references in table 2.	29_AUG-2019	Vincent Foong

## 1.0 General Information

### EUT Description:

<b>Technologies</b>	Land Mobile Radio (LMR)
<b>Modulation Type</b>	Analog , Digital

### General Description of Applied Standards

The EUT is a RF Product. According to the specifications of the manufacturer, the EUT is to comply with the requirements of the following standards:

**ANSI C63.4-2014**

**ANSI C63.26-2015**

**2.0 Summary of Test Results**

FCC General Rules Part (47CFR)	Test Item	Result	Remark
2.1046, 22.565, 90.205	RF Power Output	Pass	-
2.1055, 90.213, 22.355	Frequency Stability	Pass	-
2.1047	Audio Frequency Response	Pass	-
2.1047	Audio Low Pass Filter Response	Pass	-
2.1047	Modulation limiting	Pass	-
2.1049,90.210, 22.359(b), 90.691, 90.210(T-band)	Occupied Bandwidth	Pass	16K0F3E-15.0167kHz 11K0F3E-9.8769kHz 7K60F1D-7.4599 kHz 7K60F1E-7.5501kHz 7K60F1W-7.3949 kHz
22.359(a),(b)	Band Edge Conducted Spurious Emission	Pass	16K0F3E-15.0105kHz 7K60F1D-7.4685kHz
90.214	Transient Frequency Behavior	NA	-
-	Adjacent Channel Power	NA	-
2.1051, 22.359, 90.210	Conducted Spurious Emissions	Pass	Highest Spur Level -29.2445dBm
2.1051, 22.359, 90.210	Radiated Spurious Emission	Pass	Highest Radiated Emission Level -35.07 dBm
-	GNSS (EIRP for 1559 – 1610MHz)	NA	-
-	Effective Radiated Power (ERP)	NA	-

NA → Not Applicable

### 3.0 Measurement Uncertainty

Measurement	Frequency	Expanded Uncertainty (k=1.96) (±)
AC Power Line Conducted Spurious Emission	150KHz ~ 30MHz	3.43
Radiated Emissions up to 1 GHz	30MHz ~ 200MHz	5.01
	200MHz ~ 1000MHz	5.01
Radiated Emissions above 1 GHz	1GHz ~ 18GHz	5.01
	18GHz ~ 25GHz	5.01

#### 4.0 Equipment List

##### FCC Analog ATE#1: (SW version: 2.4.5 & FCC\_Frequency Stability 1.0.3 rev.)

Description	Model	Serial Number	Calibration Date	Calibration Due Date
Audio Analyzer	8903B	3011A10475	9-Jul-18	9-Jul-19
SIGNAL GENERATOR	2042	203002/747	22-Jan-19	22-Jan-20
MODULATION ANALYZER	8901B	3216A03889	9-Jul-18	9-Jul-19
DSA	36570A	MY42506781	6-Jul-18	6-Jul-19
POWER SENSOR	E9031A	MY41502652	19-Nov-18	19-Nov-19
POWER METER	E4412A	MY41293855	27-Jul-18	27-Jul-19
POWER SUPPLY	E4416A	GB41293747	11-Apr-19	11-Apr-20
CHAMBER	SH-641	92009188	29-Mar-2019	29-Mar-2020
N to N RF Cable # 1	M17/128-RG400	NA	NA	NA
BNC to N RF Cable # 1	RG 58	NA	NA	NA
BNC to BNC RF Cable # 1	RG 58	NA	NA	NA
BNC to BNC RF Cable # 2	RG 58	NA	NA	NA
BNC to BNC RF Cable # 3	RG 58	NA	NA	NA
BNC to BNC RF Cable # 4	RG 58	NA	NA	NA
BNC to BNC RF Cable # 5	RG 58	NA	NA	NA
BNC to BNC RF Cable # 6	RG 58	NA	NA	NA
BNC to BNC RF Cable # 7	RG 58	NA	NA	NA
N to SMA RF Cable # 1	RG 58	NA	NA	NA
N to SMA RF Cable # 2	RG 58	NA	NA	NA
N to SMA RF Cable # 3	RG 58	NA	NA	NA
Aeroflex Attenuator 30dB	49-30-34-LIM	NA	NA	NA

##### FCC Transient ATE #1: (SW version: FCC Transient ATE\_R1.1.2)

Description	Model	Serial Number	Calibration Date	Calibration Due Date
POWER SUPPLY	6032A	2818A03549	11-Jul-18	11-Jul-19
POWER SENSOR	E4412A	MY41498918	29-Jul-18	29-Jul-19
POWER METER	E4416A	GB41293866	26-Feb-19	26-Feb-21
ATTENUATORS/SWITCH DRIVER	11713A	2508A10141	CNR	CNR
STEP ATTENUATOR/11dB	8494G	MY52300223	26-Jul-18	26-Jul-19
STEP ATTENUATOR/110dB	8496G	MY52300176	26-Jul-18	26-Jul-19
OSCILLOSCOPE	MSO8104A	MY45002372	26-Jun-18	26-Jun-19
AUDIO ANALYZER	8903B	3729A17409	18-Jul-18	18-Jul-19
AUDIO ANALYZER	8903B	3413A14586	7-Jul-18	7-Jul-19
MODULATION ANALYZER	8901B	3616A03889	9-Jul-18	9-Jul-19
SIGNAL GENERATOR	8657A	3039A3205	5-Jul-18	5-Jul-19
SPECTRUM ANALYZER	E4440A	MY46185415	16-Aug-17	16-Aug-19
N to N RF Cable # 1	SF126/11N/11N	NA	NA	NA

N to N RF Cable # 2	M17/128- RG400	NA	NA	NA
N to N RF Cable # 3	M17/128- RG400	NA	NA	NA
N to N RF Cable # 4	M17/128- RG400	NA	NA	NA
N to N RF Cable # 5	M17/128- RG400	NA	NA	NA
N to N RF Cable # 6	M17/128- RG400	NA	NA	NA
N to N RF Cable # 7	M17/128- RG400	NA	NA	NA
N to N RF Cable # 8	M17/128- RG400	NA	NA	NA
N to N RF Cable # 9	M17/128- RG400	NA	NA	NA
BNC to BNC RF Cable # 1	RG 58	NA	NA	NA
BNC to BNC RF Cable # 2	RG 58	NA	NA	NA
BNC to BNC RF Cable # 3	RG 58	NA	NA	NA
BNC to BNC RF Cable # 4	RG 58	NA	NA	NA
BNC to BNC RF Cable # 5	RG 58	NA	NA	NA
BNC to BNC RF Cable # 6	RG 58	NA	NA	NA
BNC to N RF Cable # 1	RG 58	NA	NA	NA
Aeroflex Attenuator 10dB	49-10-43-LIM	NA	NA	NA
Aeroflex Attenuator 10dB	33-10-34-LIM	NA	NA	NA
SWITCH CONTROL UNIT	3488A	2719A36210	CNR	CNR



**CONDUCTED SPUR EMISSION ATE # 1 (SW version: Conducted Spur ATE\_rev 1.23.02)**

Description	Model	Serial Number	Calibration Date	Calibration Due Date
SWITCH CONTROL UNIT	3488A	2719A32735	CNR	CNR
PSA Series Spectrum Analyzer	E4445A	MY46181732	12-Mar-19	12-Mar-21
POWER SUPPLY	6032A	MY41002067	11-Jul-18	11-Jul-19
HIGH PASS FILTER SWITCH BOX	-	CS001	5-Jul-18	5-Jul-19
N to N RF Cable # 1	SF126/11N/11N	NA	NA	NA
N to N RF Cable # 2	SF126/11N/11N	NA	NA	NA
BNC to BNC RF Cable # 1	RG 58	NA	NA	NA
Aeroflex Attenuator 30dB	49-30-43-LIM	NA	NA	NA
Aeroflex Attenuator 10dB	33-10-34-LIM	NA	NA	NA
Vector Signal Generator	SMU200A	103537	22-Jul-17	22-Jul-20

**Chamber 2**

Description	Model #	Serial Number	Calibration Date	Calibration Due Date
EMI TEST RECEIVER	ESIB40	100264	04-Jul-2018	04-Jul-2019
3m Semi-anechoic Chamber	NA	888032	No Cal. Req'd	No Cal. Req'd
TURNTABLE FLUSH MOUNT 2M	T-200-S	N/A	No Cal. Req'd	No Cal. Req'd
Bore sight Antenna mast	MBS-500	N/A	No Cal. Req'd	No Cal. Req'd
PROGRAMMING CONTROLLER	3000	MF78020827 2	No Cal. Req'd	No Cal. Req'd
POWER SUPPLY	6674A	3126A-00133	07-Nov-17	07-Nov-19
SIGNAL ANALYZER	FSV40	101103	04-Jul-18	03-Jul-19
DATA LOGGER	SDL500	A.016800	19-Mar-19	19-Mar-20
BILOG ANTENNA	CBL6112D	30991	23-Apr-18	23-Apr-19
DRG HORN FREQ.	SAS-571	566	27-Sep-17	27-Sep-19
PREAMPLIFIER	PAM-0118	427	No Cal. Req'd	No Cal. Req'd
MICROWAVE GENERATOR	SMP04	100146	12-Jul-18	11-Jul-19
DRG HORN FREQ.	SAS-571	1027	3-Apr-18	3-Apr-19
BILOG ANTENNA	CBL6112B	2964	16-Feb-18	16-Feb-20
Test Software	EMC FCC IC Bluetooth RE Test			
Version	EMC FCC RE v1.5.2			

**CNR → Calibration Not Require**

## 5.0 Test Condition

### 5.1. Transmitter Test Conditions

Test Item, (Channel Spacing)	Power (W)	Modulation	Test Frequency (MHz)	Tested By
RF Output Power	Low & Max	Analog	403.0125,406.2, 450.025,459.125, 467.775,469.9875, 479.9875	TAN SZE KHAI
Frequency Stability	Max	Analog	467.775	TAN SZE KHAI
Audio Frequency Response (12.5kHz / 25kHz)	Max	Analog	467.775,459.125	TAN SZE KHAI
Audio Low Pass Filter Response (12.5kHz / 25kHz)	Max	Analog	467.775,459.125	TAN SZE KHAI
Modulation limiting (12.5kHz / 25kHz)	Max	Analog	467.775,459.125	TAN SZE KHAI
Occupied Bandwidth (12.5kHz / 25kHz)	Max	Analog, Digital	406.2,450.025,467.775, 473.0125,459.125	TAN SZE KHAI
Band Edge Conducted Spurious Emissions (Part 22) (12.5kHz / 20kHz / 25kHz)	Max	Analog, Digital	459.025,459.65, 473.0125,479.2875	TAN SZE KHAI
Transient Frequency Behavior (UHF & VHF Band) (12.5kHz / 25kHz)	Max	Analog	467.775	TAN SZE KHAI
Adjacent Channel Power (700MHz Band) (12.5kHz)	Max	Analog, Digital	NA	NA
Conducted Spurious Emissions- (12.5kHz / 25kHz)	Low / Max	Analog, Digital	403.0125,406.2, 450.025,459.125, 467.775,479.9875	TAN SZE KHAI
Radiated Spurious Emission (12.5kHz / 25kHz)	Low / Max	Analog, Digital	403.0125,406.2, 450.025,459.125, 467.775,479.9875	Azil,Faris & Aiman
GNSS (EIRP for 1559 - 1610MHz) (12.5kHz / 25kHz)	Max	Analog	NA	NA
Effective Radiated Power (ERP) (12.5kHz / 25kHz)	Max	Analog	NA	NA

NA → Not Applicable

## 6.0 Transmitter Test Parameters

### 6.1. RF Output Power

#### 6.1.1. Test Setup

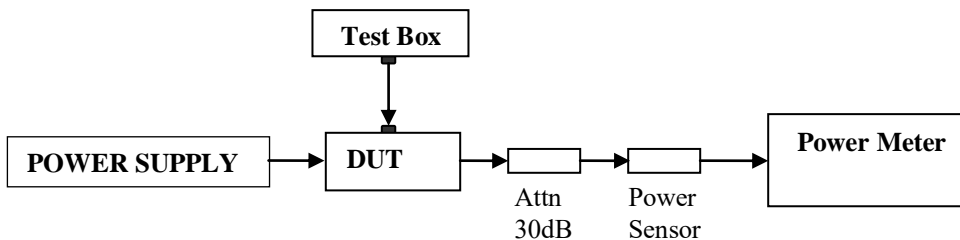

- 1) The DUT transmitter connected to Power Meter using the 30 dB attenuator and power sensor with above setup.
- 2) Path loss for the measurement included.
- 3) All the measurement was done at low, mid, high frequency for each band.
- 4) Record the power into the test report.

#### 6.1.2. Test Result

Temperature	25°C				Remarks
Voltage (V)	7.2V				
Frequency (MHz)	Low Power (W)	Current (A)	Max Power (W)	Current (A)	
403.0125	0.98	0.84	4.77	1.76	
406.2	1.01	0.83	4.6	1.70	
450.025	1.03	0.83	4.77	1.89	
459.125	0.96	0.83	4.73	1.93	
467.775	1.03	0.83	4.66	1.53	
469.9875	1.04	0.82	4.68	1.53	
479.9875	1.06	0.71	4.76	1.79	

## 6.2. Frequency Stability

### 6.2.1. Test Setup

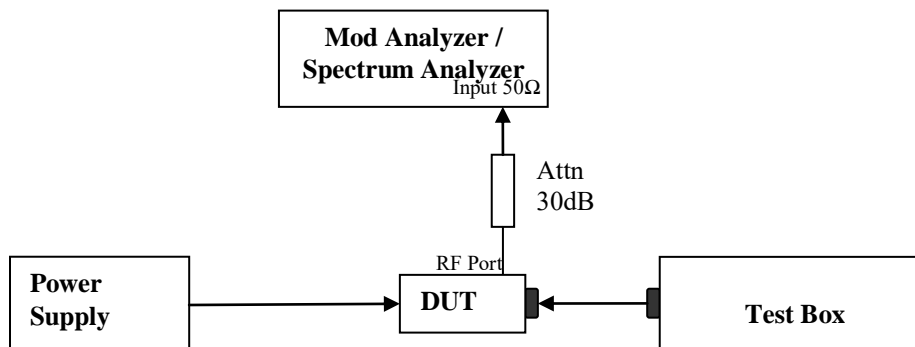

- 1) The DUT transmitter output port was connected to Modulation / Spectrum Analyzer.
- 2) Path loss for the measurement included.
- 3) Transmit the DUT and record the freq in  $MCF_{MHz}$ .
- 4) Test in 2 conditions:
  - Temperature: The frequency of the transmitter was measured from  $-30^{\circ}C$  to  $50^{\circ}C$ .
  - Supply Voltage:
    - Mobile: The frequency of the transmitter was measured from 85% to 115% of the nominal operating input voltage.
    - Portable: The frequency of the transmitter was measured from nominal  $\pm x$  % as specified by the manufacturer
- 5) Calculate the ppm frequency error by the following:

$$ppm\ error = \left( \frac{MCF_{MHz}}{ACF_{MHz}} - 1 \right) * 10^6$$

Where:  $MCF_{MHz}$  is the Measured Carrier Frequency in MHz  
 $ACF_{MHz}$  is the Assigned Carrier Frequency in MHz

### 6.2.2. Test Result

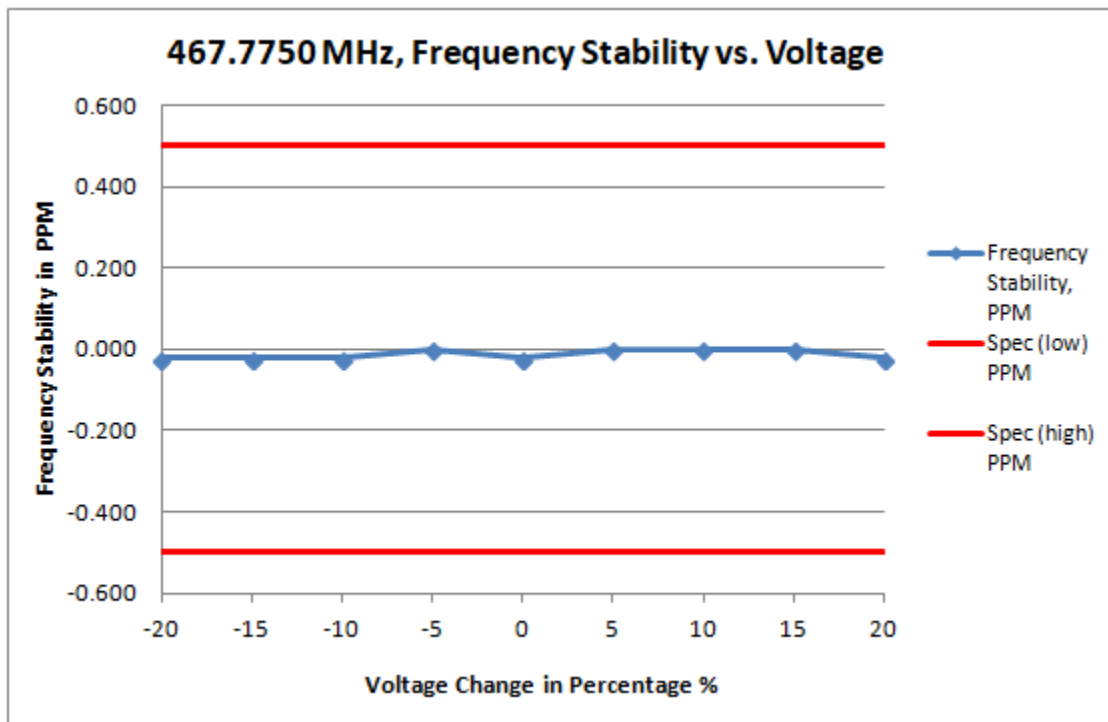

Frequency / Channel Spacing	467.7750 MHz / 12.5 kHz				
Temperature, °C	25				
Voltage %	Voltage, V	Frequency, MHz	Frequency Stability, PPM	Spec (low) PPM	Spec (high) PPM
-20	6.000	467.774990	-0.021	-0.500	0.500
-15	6.375	467.774990	-0.021	-0.500	0.500
-10	6.750	467.774990	-0.021	-0.500	0.500
-5	7.125	467.775000	0.000	-0.500	0.500
0	7.500	467.774990	-0.021	-0.500	0.500
5	7.875	467.775000	0.000	-0.500	0.500
10	8.250	467.775000	0.000	-0.500	0.500
15	8.625	467.775000	0.000	-0.500	0.500
20	9.000	467.774990	-0.021	-0.500	0.500

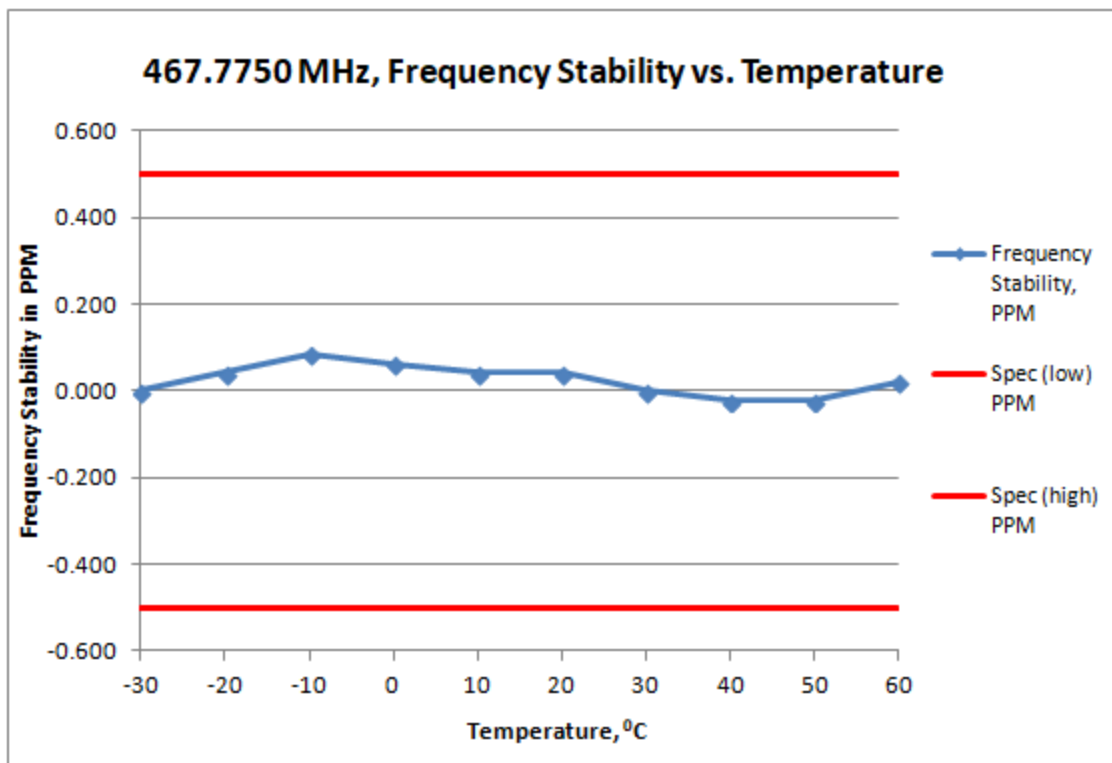

Frequency / Channel Spacing	467.7750 MHz / 12.5 kHz			
Voltage, V	7.5			
Temperature, °C	Frequency, MHz	Frequency Stability, PPM	Spec (low) PPM	Spec (high) PPM
-30	467.775000	0.000	-0.500	0.500
-20	467.775020	0.043	-0.500	0.500
-10	467.775040	0.086	-0.500	0.500
0	467.775030	0.064	-0.500	0.500
10	467.775020	0.043	-0.500	0.500
20	467.775020	0.043	-0.500	0.500
30	467.775000	0.000	-0.500	0.500
40	467.774990	-0.021	-0.500	0.500
50	467.774990	-0.021	-0.500	0.500
60	467.775010	0.021	-0.500	0.500

**6.2.3. Test Limit**

As per manufacturer declared spec +/- 0.5ppm

### 6.3. Audio Frequency Response

#### 6.3.1. Test Setup

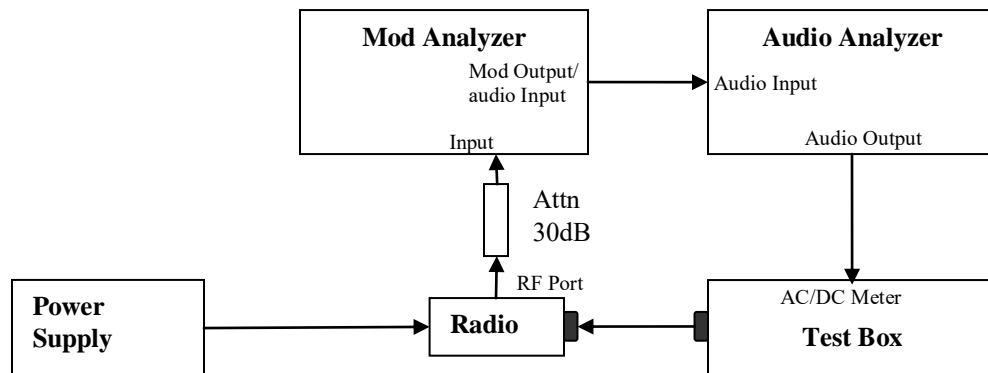

- 1) The DUT transmitter output port was connected to Modulation Analyzer.
- 2) Path loss for the measurement included.
- 3) Set the audio bandwidth filter to 15 kHz and 50 kHz.
- 4) Transmit the radio and set the audio analyzer to 1 kHz audio frequency and 20% of the Full rated system deviation.
- 5) On audio analyzer, set the rated level as reference to zero.
- 6) Vary the audio frequency from 300 Hz to 3 kHz. Record the change in dB on the audio analyzer.



### 6.3.2. Test Result

NOT FOR FCC REVIEW

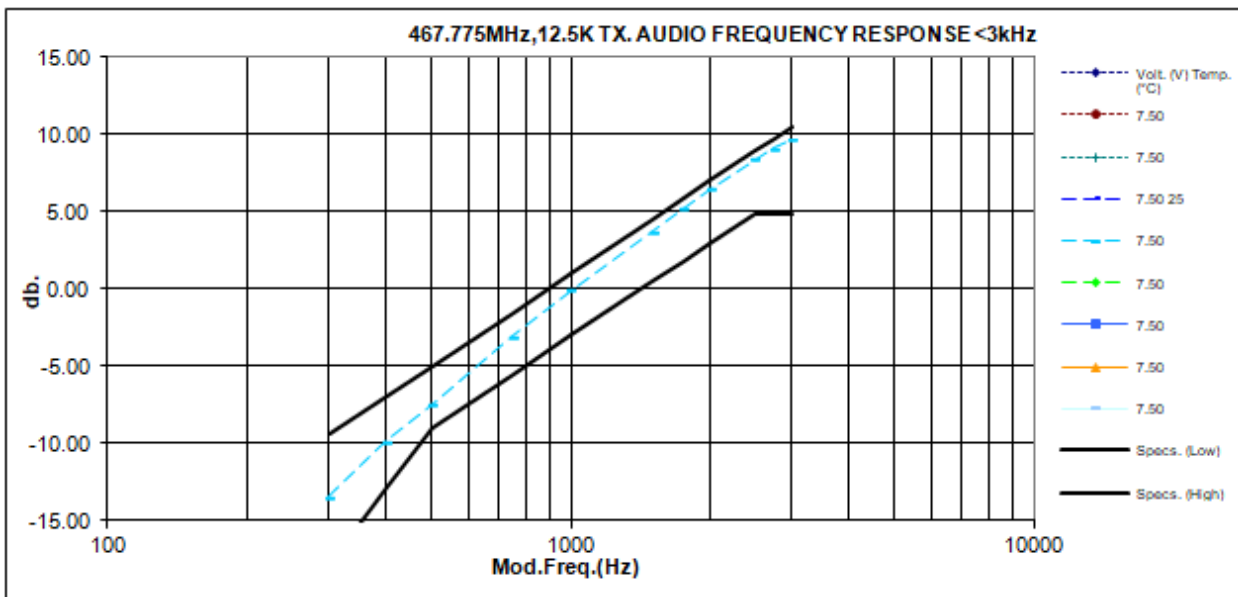
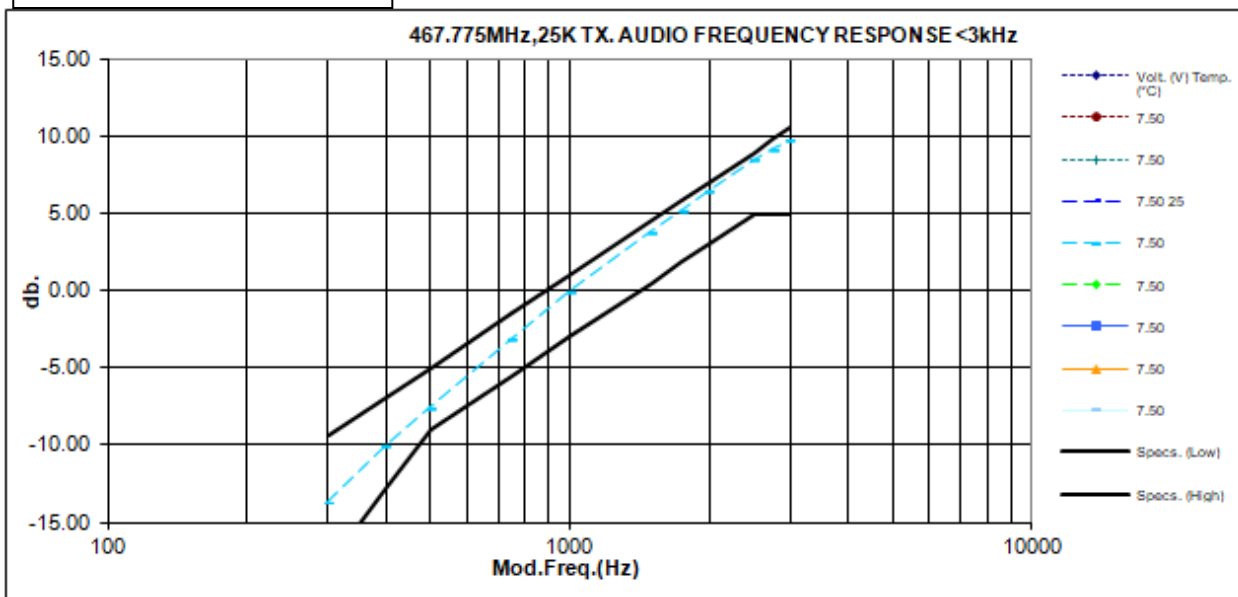

NOT FOR FCC REVIEW

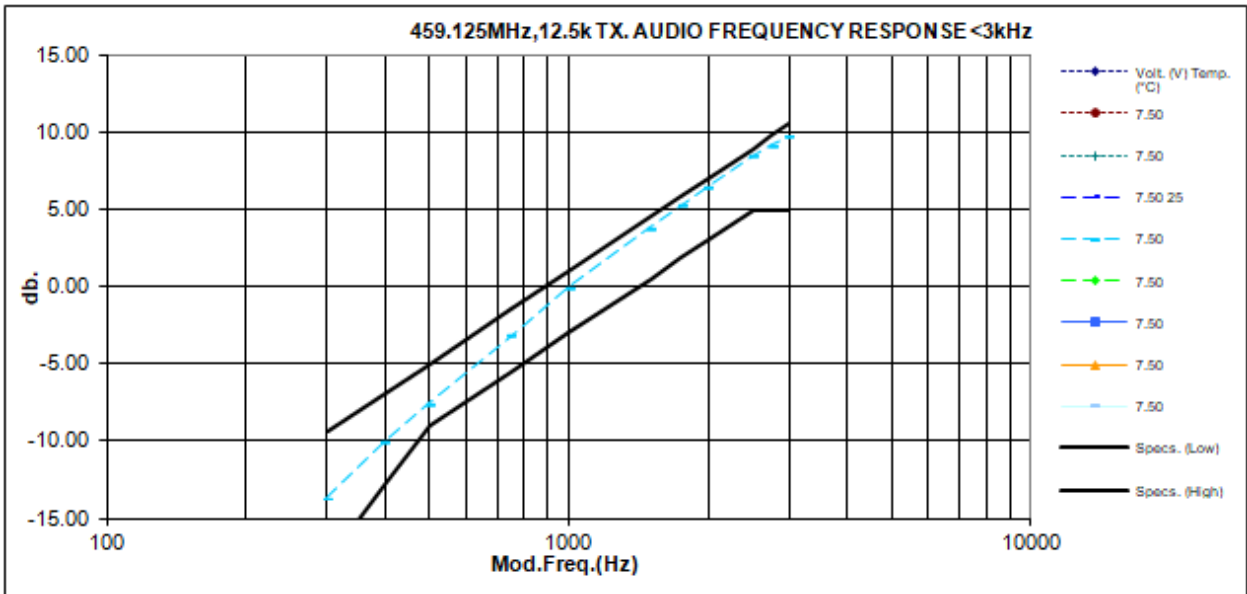
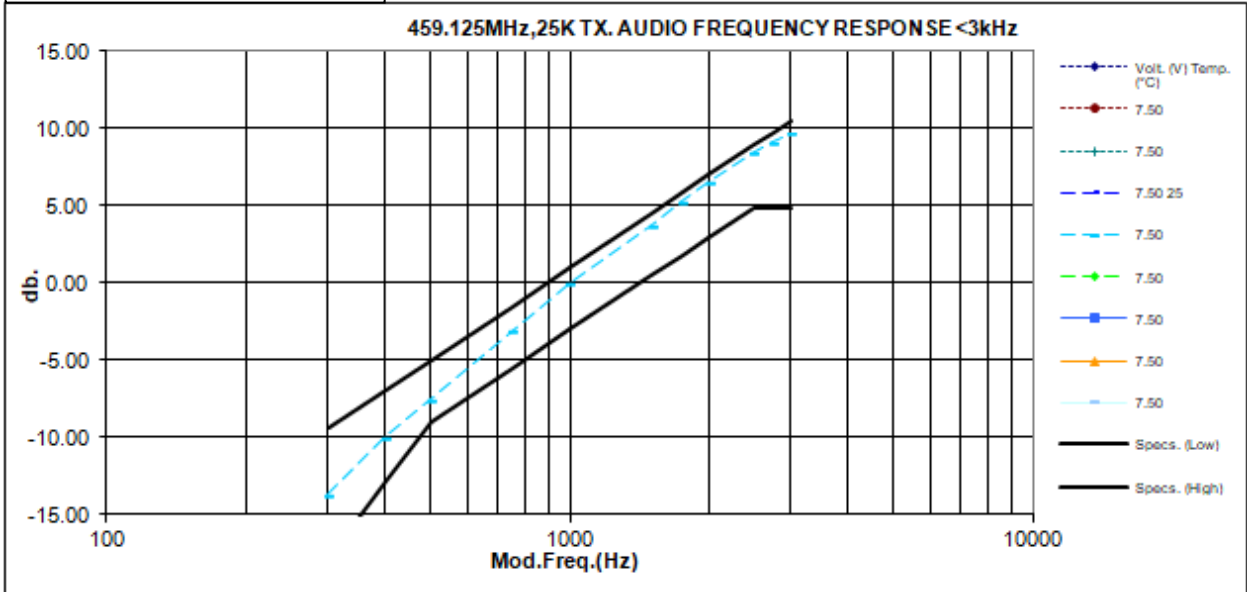

### 6.3.3. Test Limit

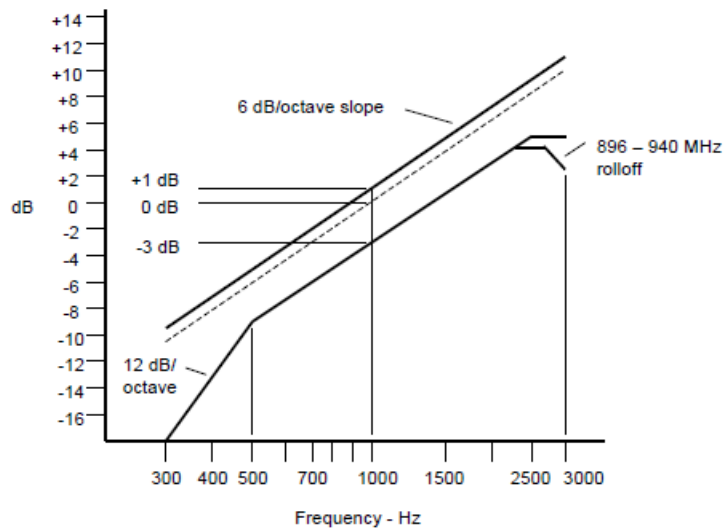

Note:

- o There are additional 6 dB per octave attenuation is allowed from 2.5KHz to 3KHz in equipment 25MHz to 869MHz radio.
- o Additional 6 dB per octave attenuation is allowed from 2.3KHz to 2.7KHz & additional 12 dB per octave attenuation is allowed from 2.7KHz to 3KHz in equipment 896MHz to 940MHz radio.

## 6.4. Audio Low Pass Filter Response

### 6.4.1. Test Setup

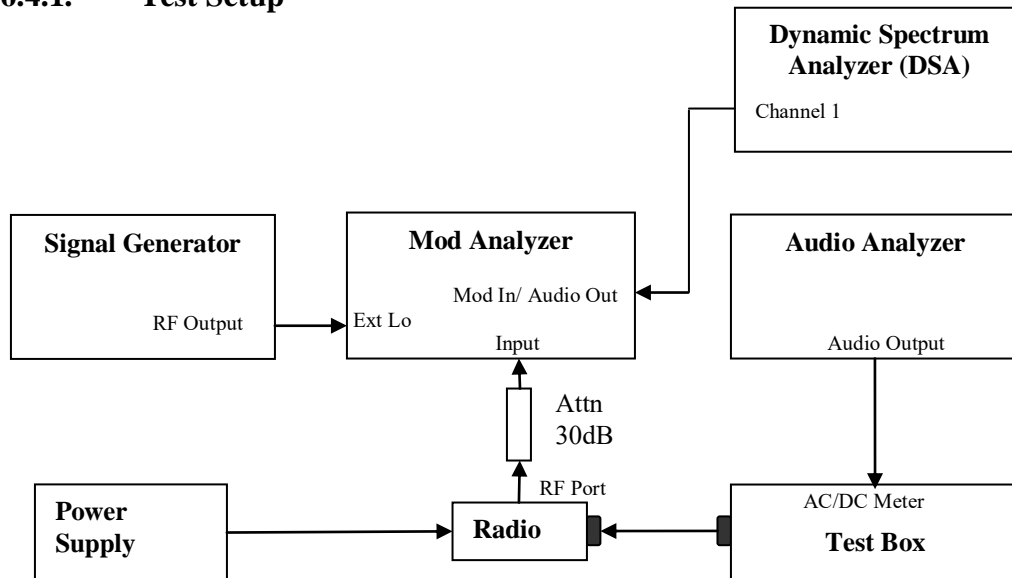

- 1) The DUT transmitter output port was connected to Modulation Analyzer.
- 2) Path loss for the measurement included.
- 3) Press 23.1SPCL on modulation analyzer to enable the external LO from Sigen.
- 4) Set the Sigen frequency to  $F_c + 1.5$  MHz, RF output level to 0dBm without modulation.
- 5) Transmit the radio and set the audio analyzer to 1 kHz audio frequency and 60% of the Full rated system deviation.
- 6) Up the amplitude by 20dB.
- 7) On DSA, get the reference point to 0dB.
- 8) Vary the frequency on audio analyzer from 3 kHz to 20 kHz, record the audio tone from DSA.

### 6.4.2. Test Result

NOT FOR FCC REVIEW

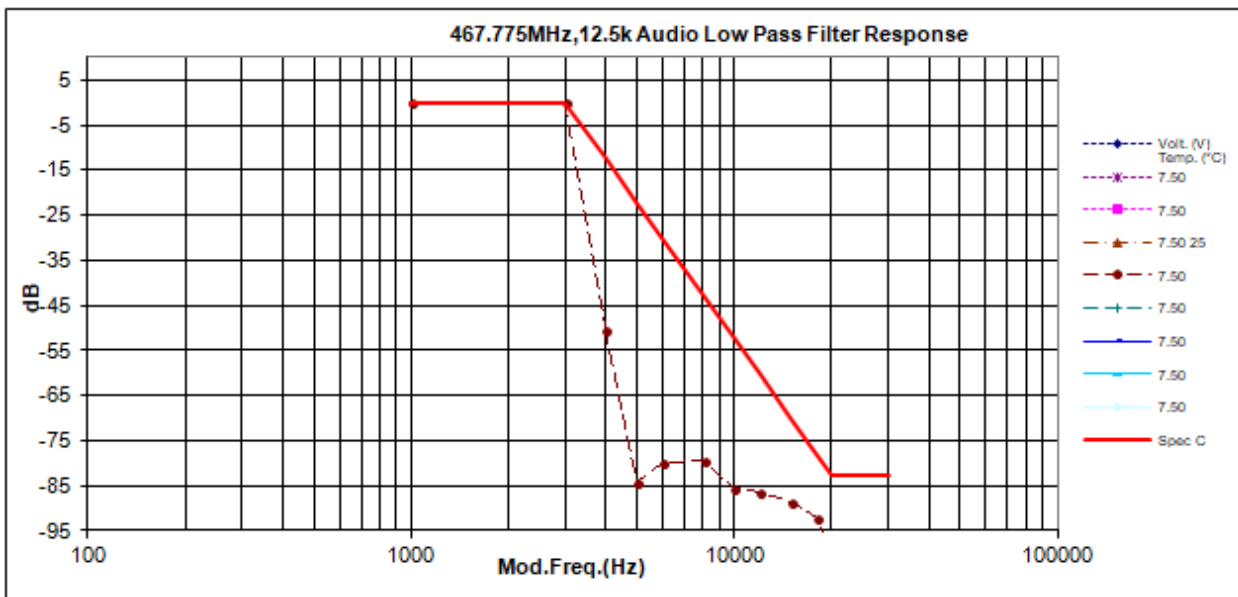
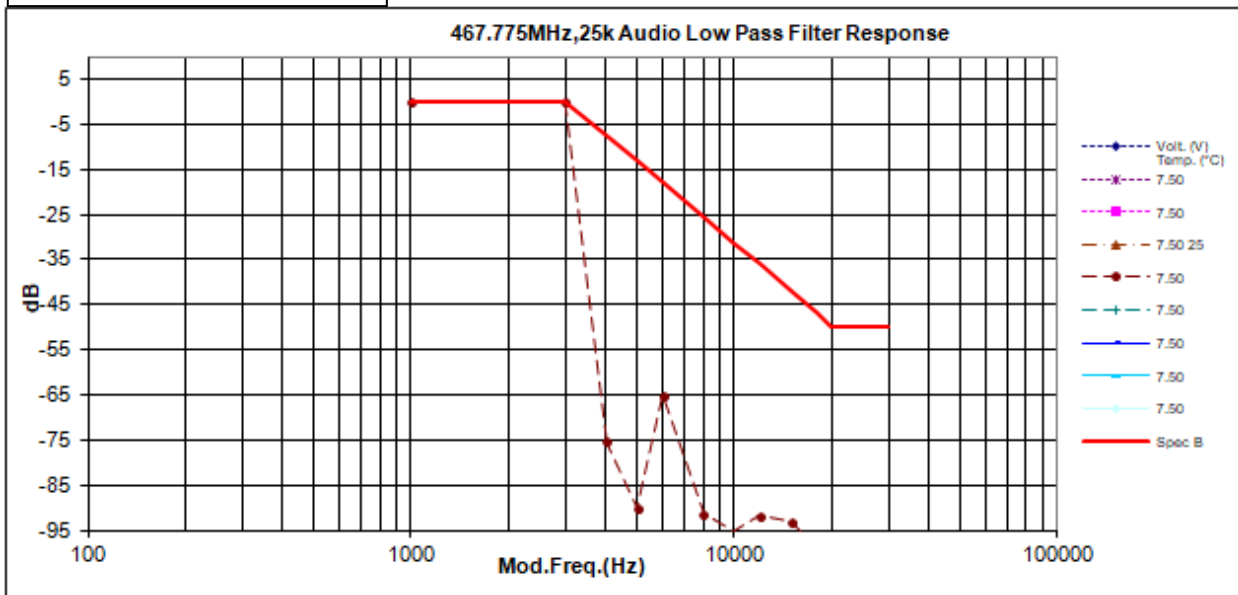

NOT FOR FCC REVIEW

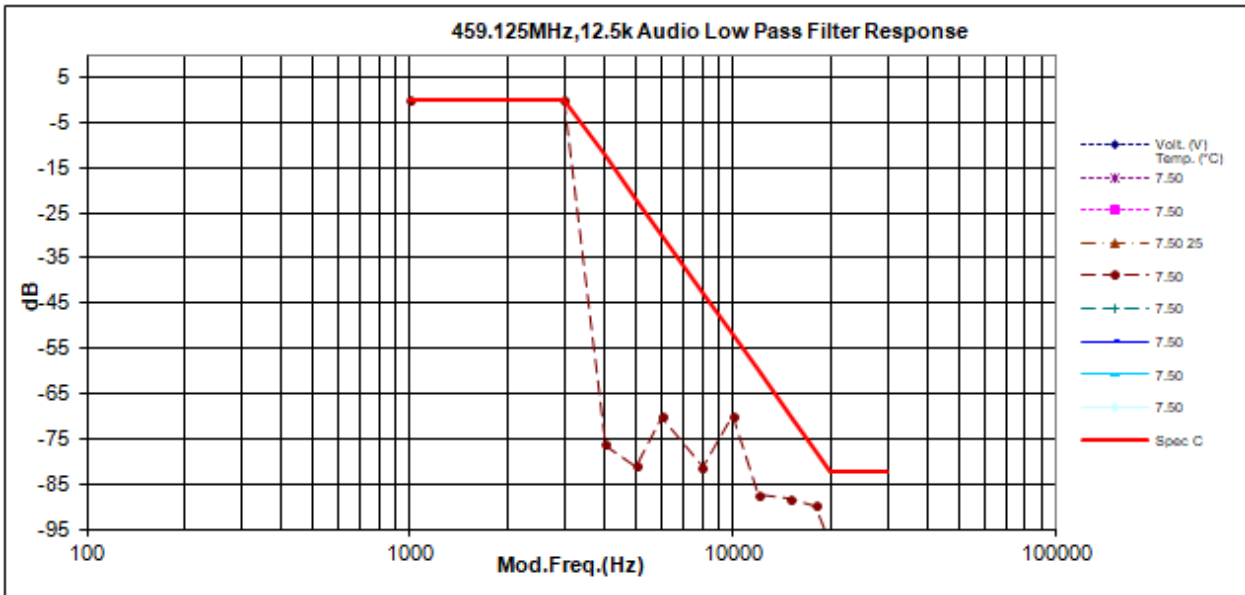
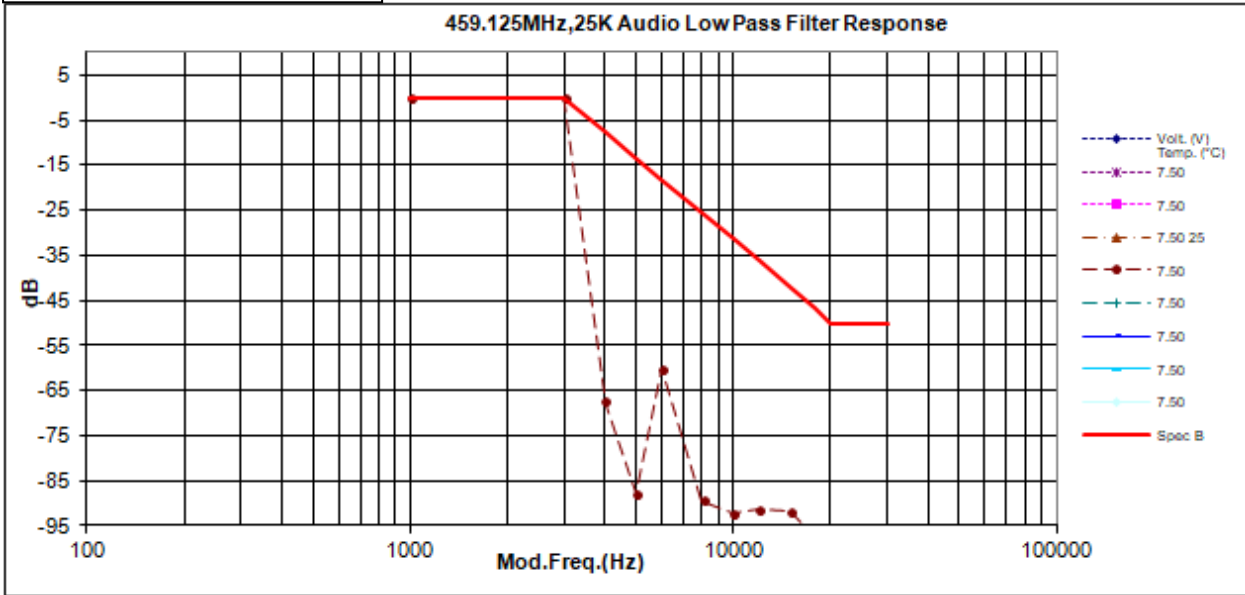

**6.4.3. Test Limit**

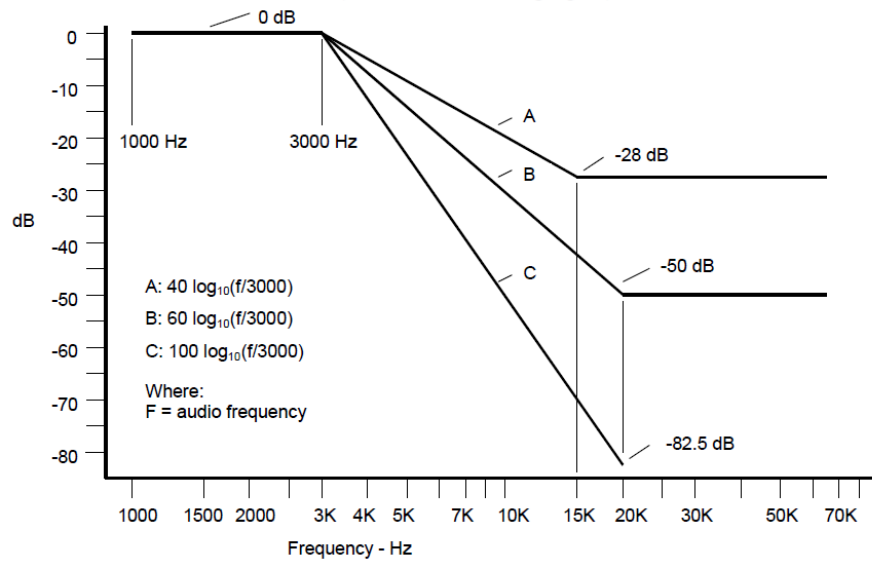

For audio frequencies above 3000 Hz, the audio response of the post limiter low-pass filter shall meet or exceed the following requirements:

- a) For equipment operating on 20, 25 or 30 kHz channel bandwidth in the 25 MHz to 174 MHz range:

At frequencies from 3000 Hz through 15,000 Hz the attenuation shall be greater than the attenuation at 1000 Hz by at least:  $40 \log_{10}(f/3000)$  dB

where:  $f$  is the audio frequency in Hz.

At frequencies above 15,000 Hz, the attenuation shall be greater than the attenuation at 1000 Hz, by at least: 28 dB.

- b) For equipment operating with 25 kHz bandwidth channels between 406 and 512 MHz through 896 MHz, and between 929 MHz through 930 MHz:

At frequencies from 3000 Hz through 20,000 Hz, the attenuation shall be greater than the attenuation at 1000 Hz by at least:  $60 \log_{10}(f/3000)$  dB

where:  $f$  is the audio frequency in Hz.

At frequencies above 20,000 Hz the attenuation shall be greater than the attenuation at 1000 Hz by at least: 50 dB.

- c) For equipment operating on channels between 896 MHz through 901 MHz, between 935 MHz through 940 MHz, and 12.5 or 15 kHz spaced channels in the frequency range 138-174 MHz and 406-512 MHz.

At frequencies from 3000 Hz through 20,000 Hz the attenuation shall be greater than the attenuation at 1000 Hz by at least:  $100 \log_{10}(f/3000)$  dB

where:  $f$  is the audio frequency in Hz.

## 6.5. Modulation Limiting

### 6.5.1. Test Setup

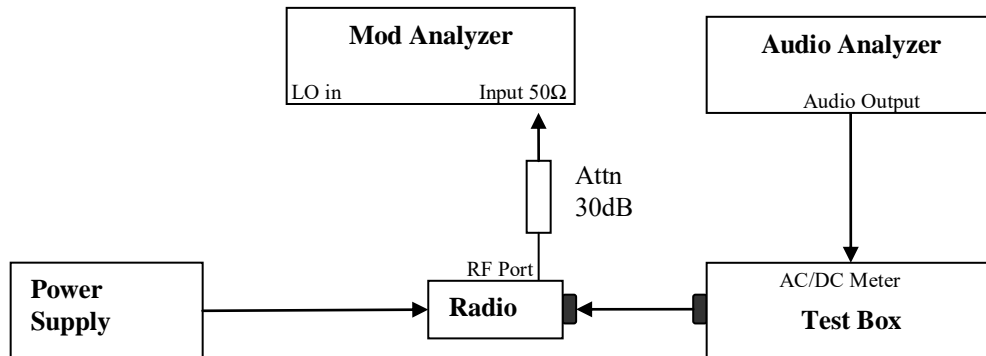

- 1) The DUT transmitter output port was connected to Modulation Analyzer.
- 2) Path loss for the measurement included.
- 3) Set the audio bandwidth filter to 15 kHz.
- 4) Transmit the radio and set the audio analyzer to 1 kHz audio frequency and 60% of the Full rated system deviation.
- 5) Record the frequency deviation as 0dB input level at 1kHz audio frequency.
- 6) Repeat the step and record the frequency deviation from -20 dB to 20dB by 5 dB increments and different audio freq 300 Hz, 2.5 kHz and 3 kHz.



### 6.5.2. Test Result

NOT FOR FCC REVIEW

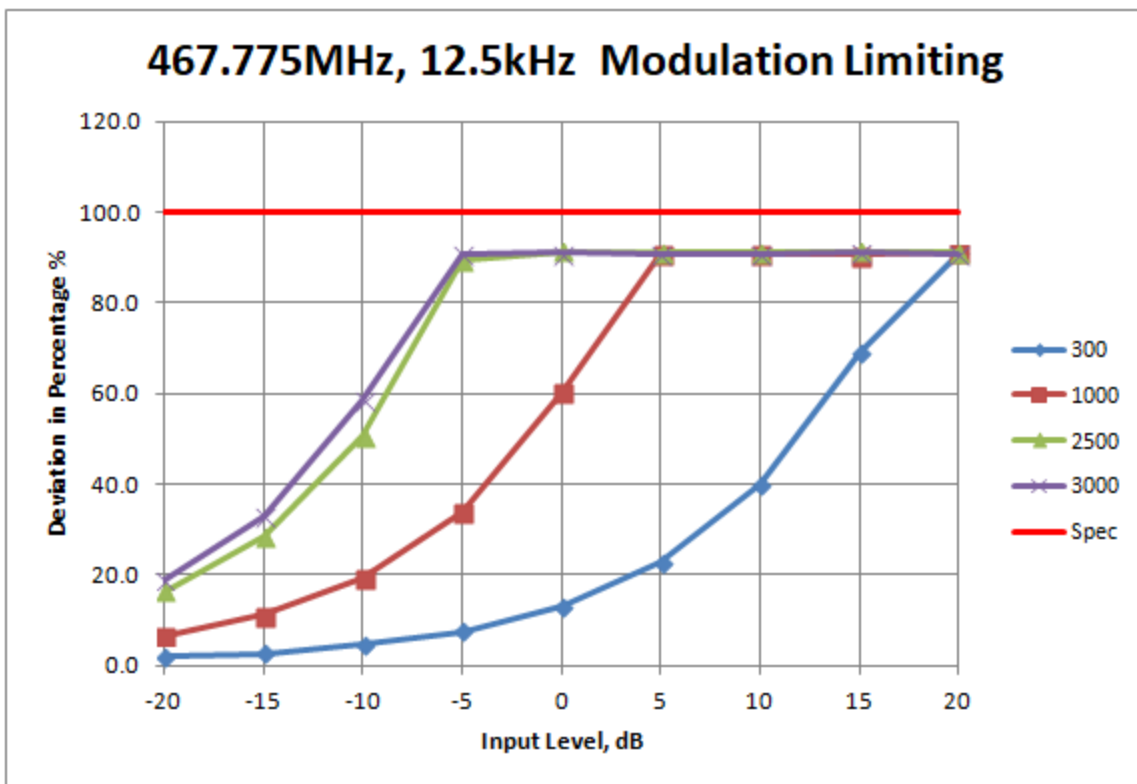
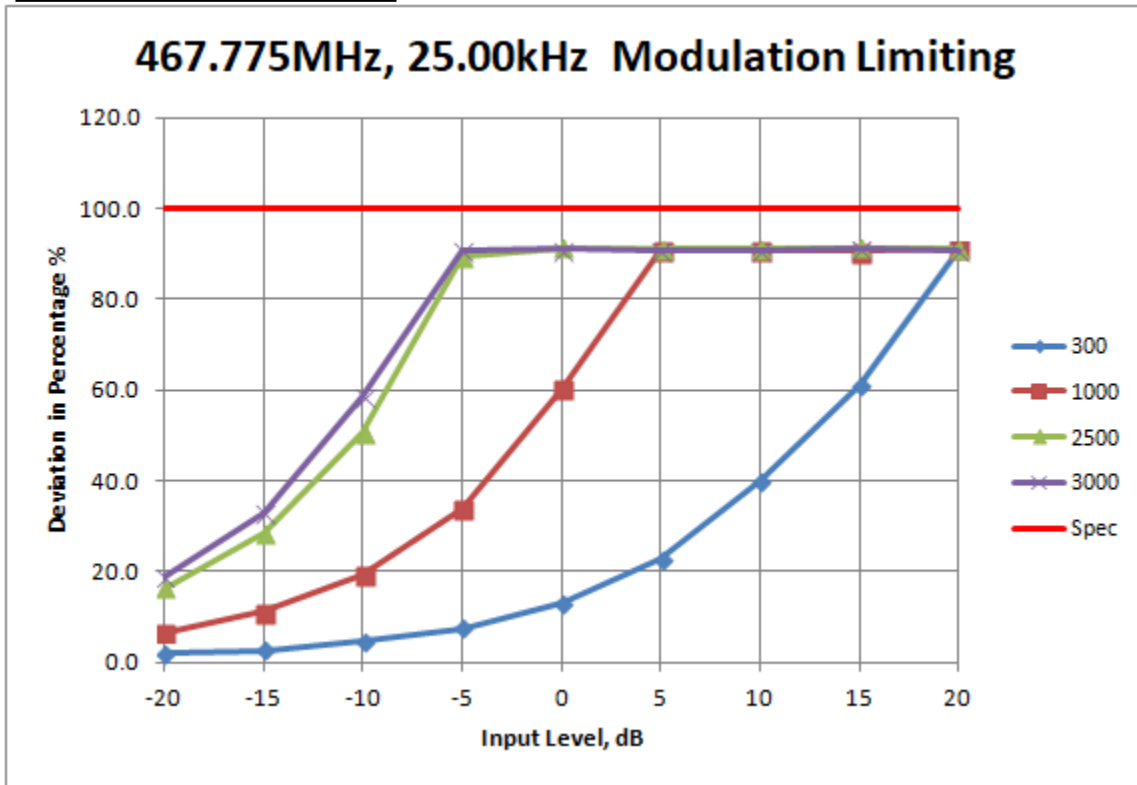

NOT FOR FCC REVIEW

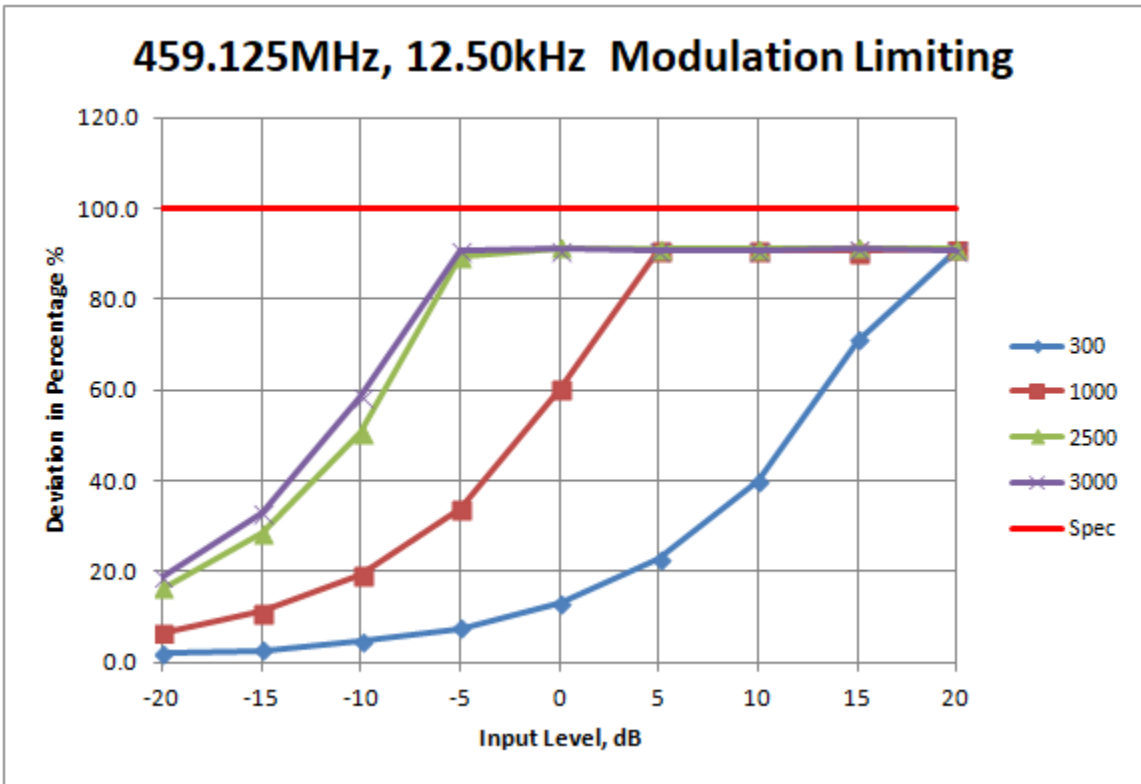
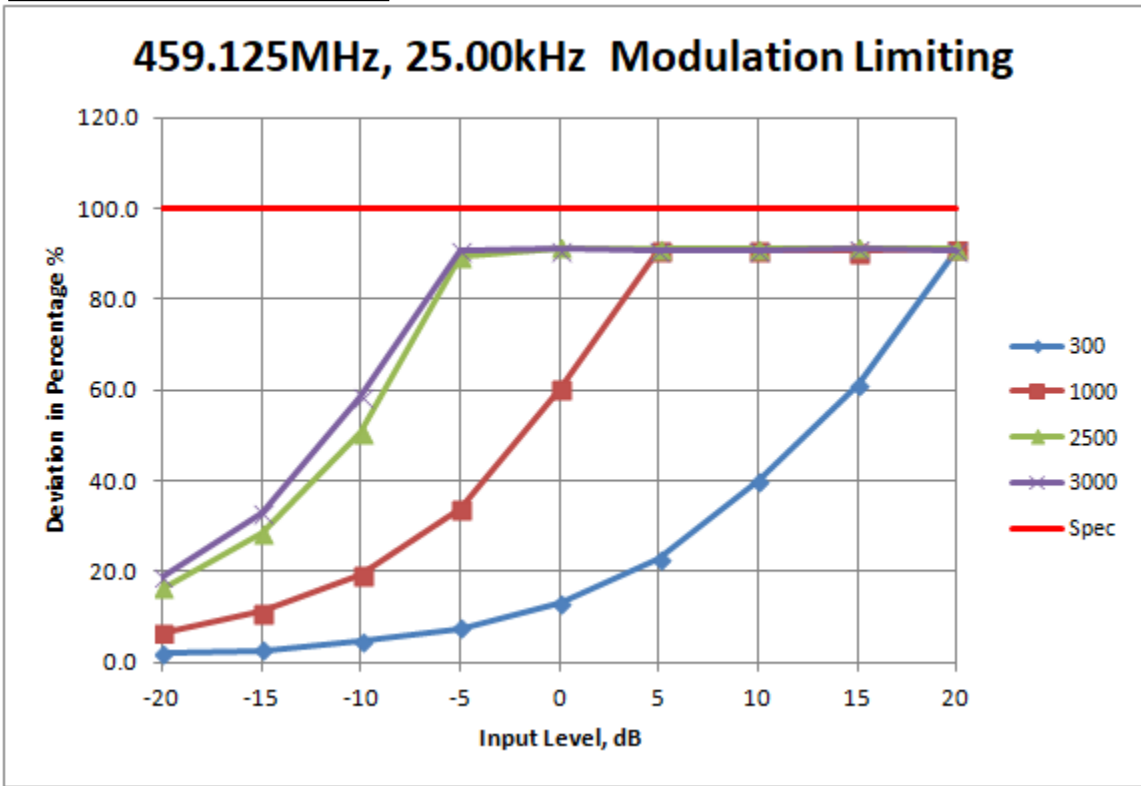

**6.5.3. Test Limit**  
Modulation Limiting shall not exceed 100 percent.

## 6.6. Occupied Bandwidth

### 6.6.1. Test Setup (Analog)

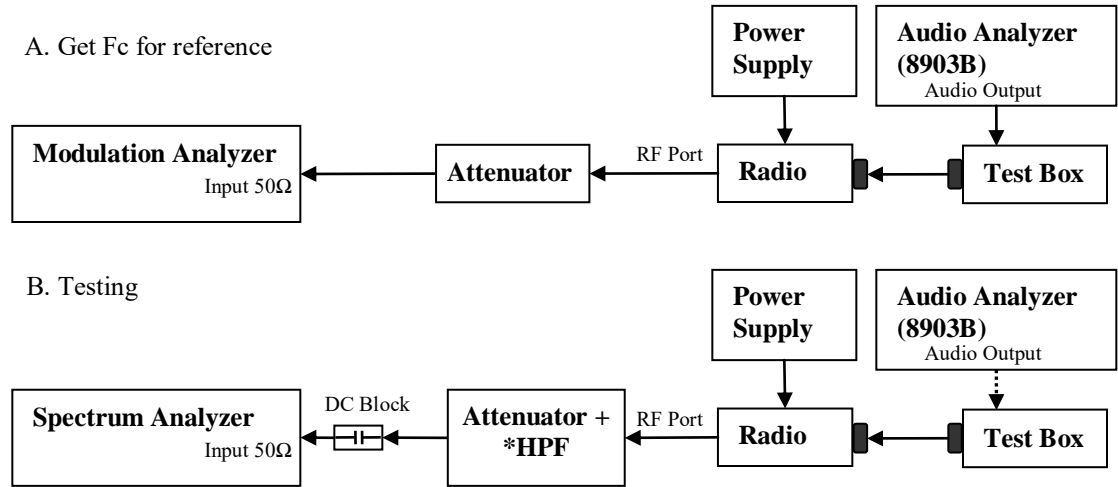

- 1) The DUT transmitter output port was connected to Modulation Analyzer.
- 2) Set the audio bandwidth filter to 15 kHz low pass filter and 50 kHz high pass filter.
- 3) Transmit the radio and set the audio analyzer to 2.5 kHz audio frequency and 50% of the rated deviation. Up the amplitude by 16 dB. Dekey the DUT.
- 4) Path loss for the measurement included.
- 5) Select the Occupied Bandwidth measurement for 99% Emissions Bandwidth Measurement.
- 6) Key in the Fc and Resolution Bandwidth (1 ~ 5 % of emission designator).
- 7) Transmit the DUT and record the occupied Bandwidth frequency.
- 8) Preset the spectrum analyzer for sideband spectrum measurement.
- 9) Set the span and Resolution Bandwidth (according to FCC/ ISED standard).
- 10) Save the screen shot as modulated signal
- 11) Remove the audio tone from audio analyzer to capture unmodulated signal.

\* Only HPF added for Mask 80.211 measurement with attenuator.

**6.6.2. Test Result (Analog)**

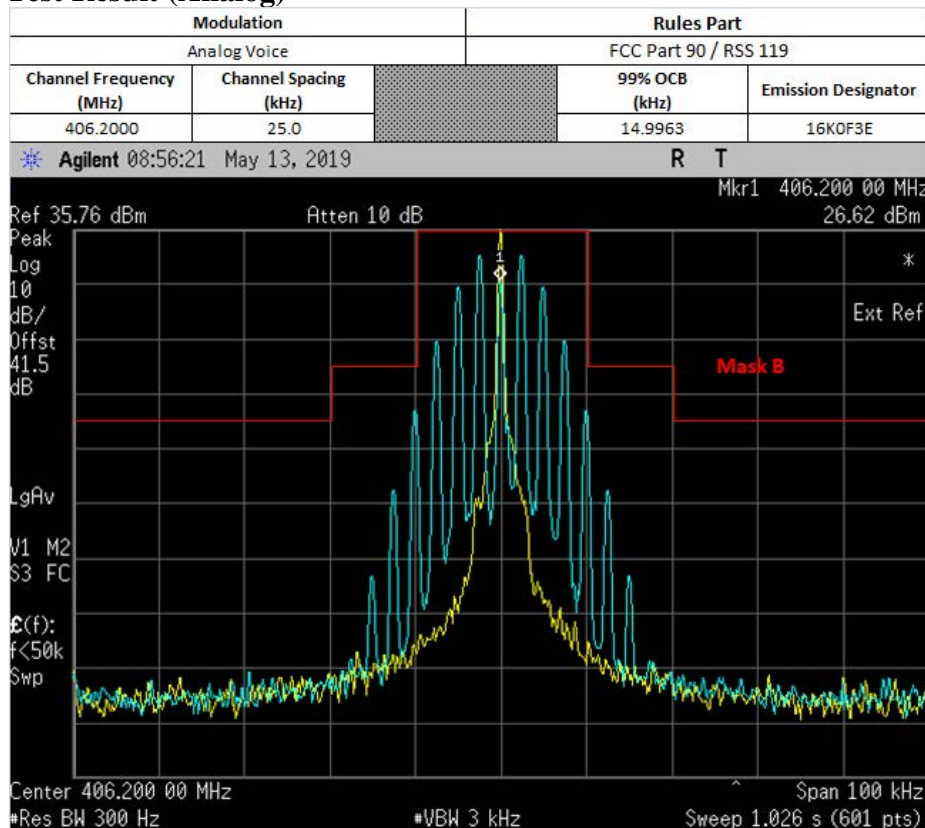

**NOT FOR FCC REVIEW**

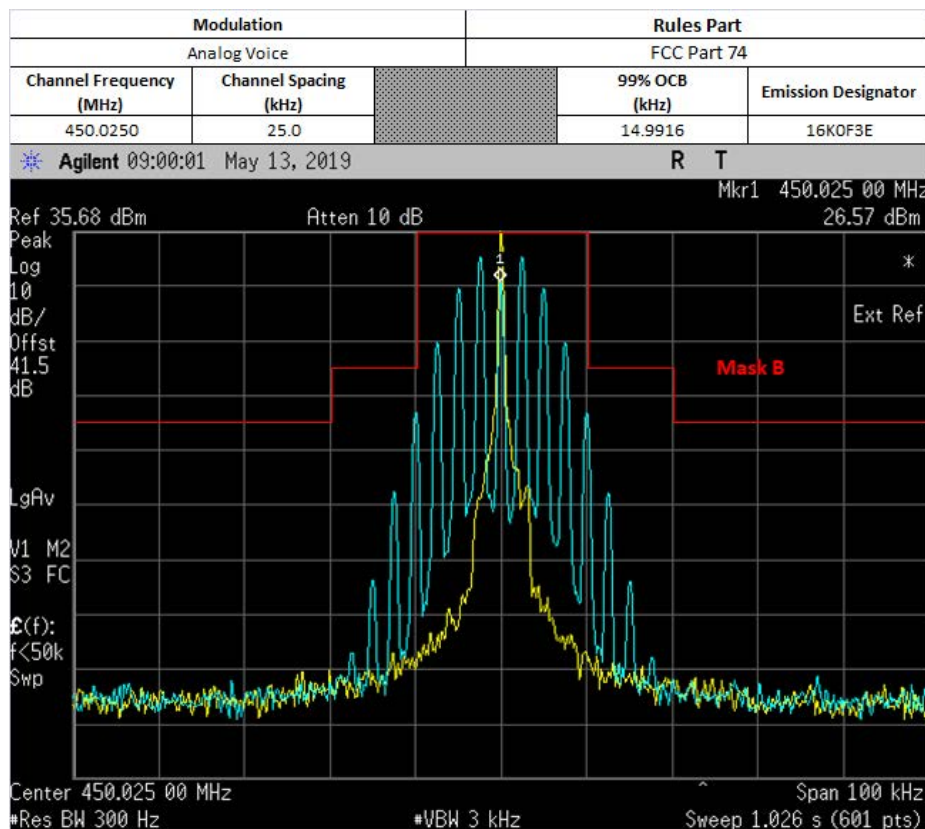

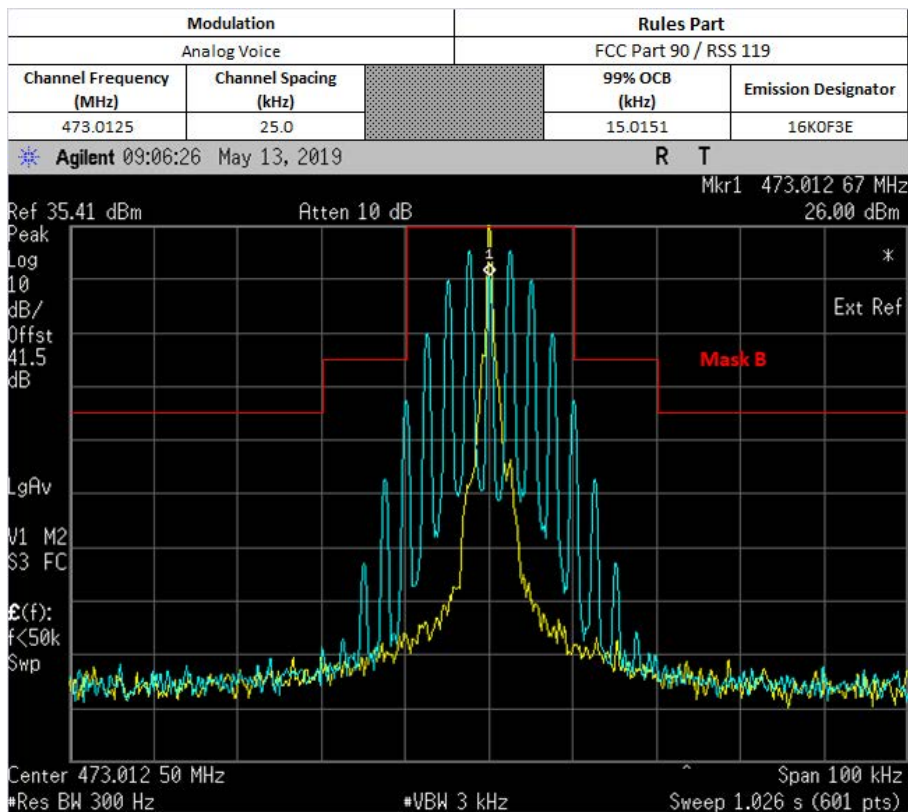
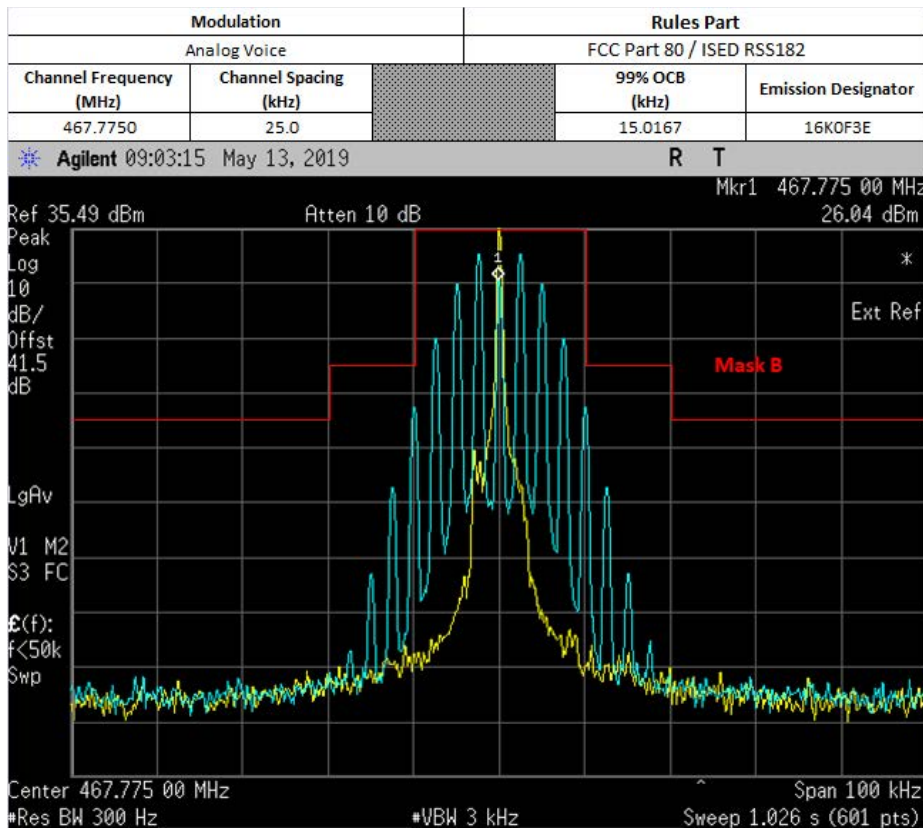

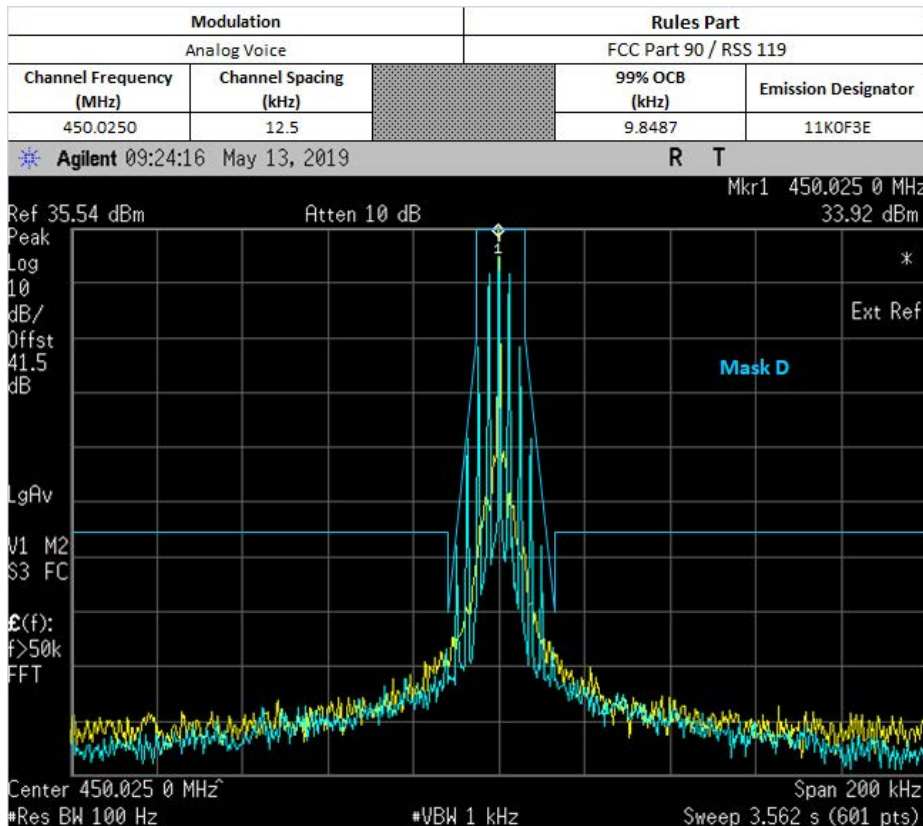
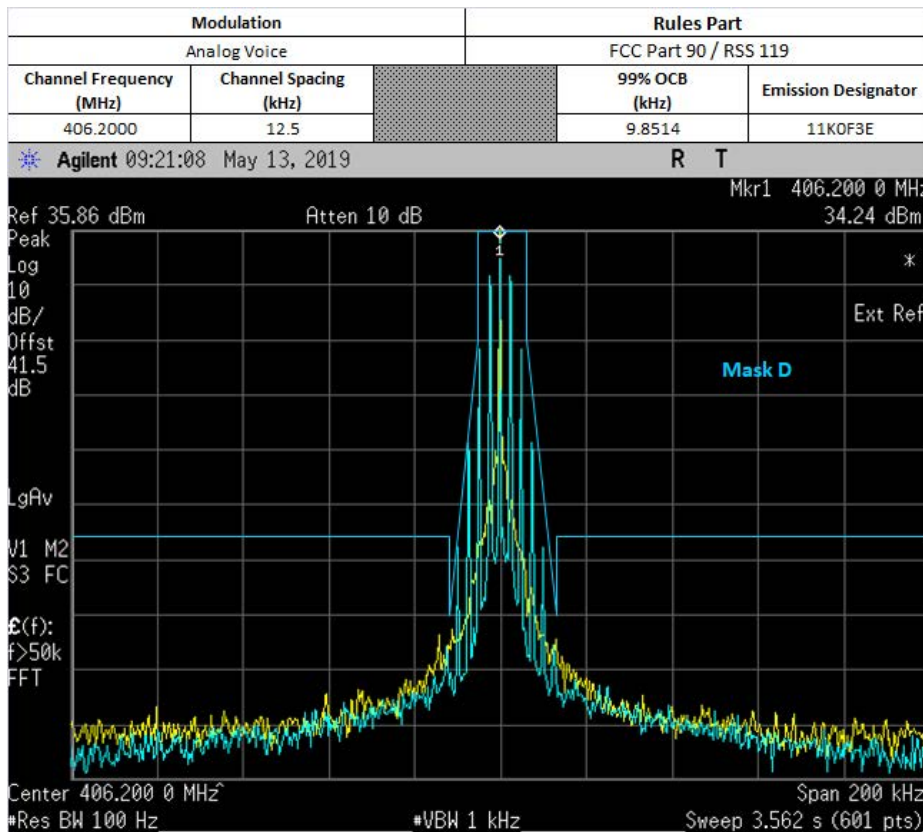

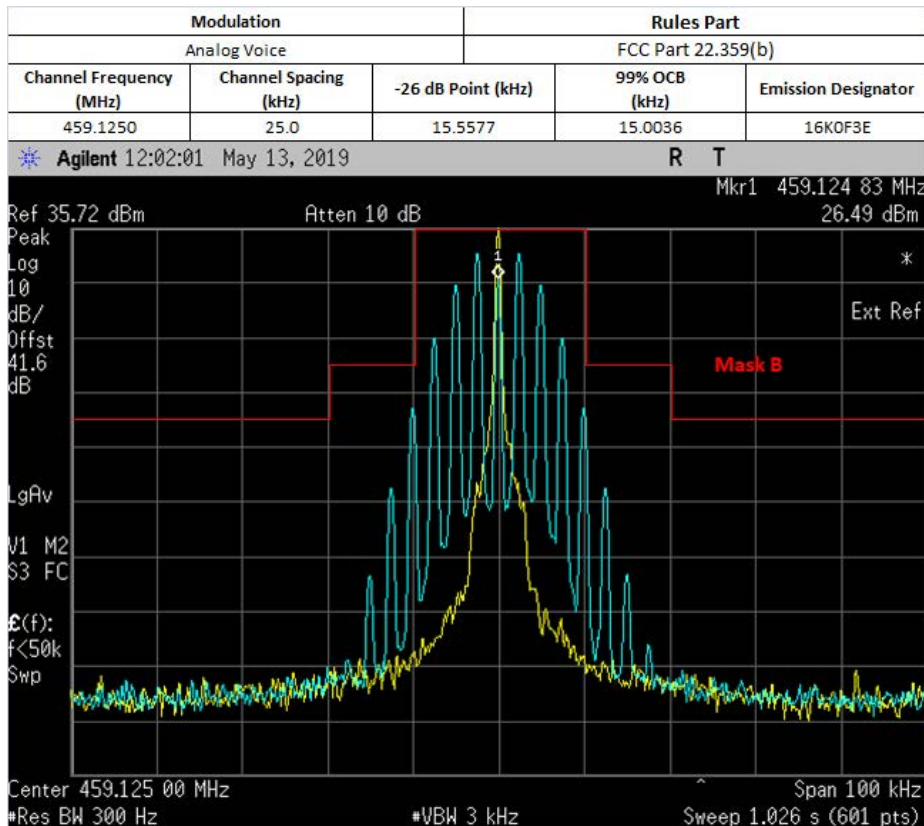
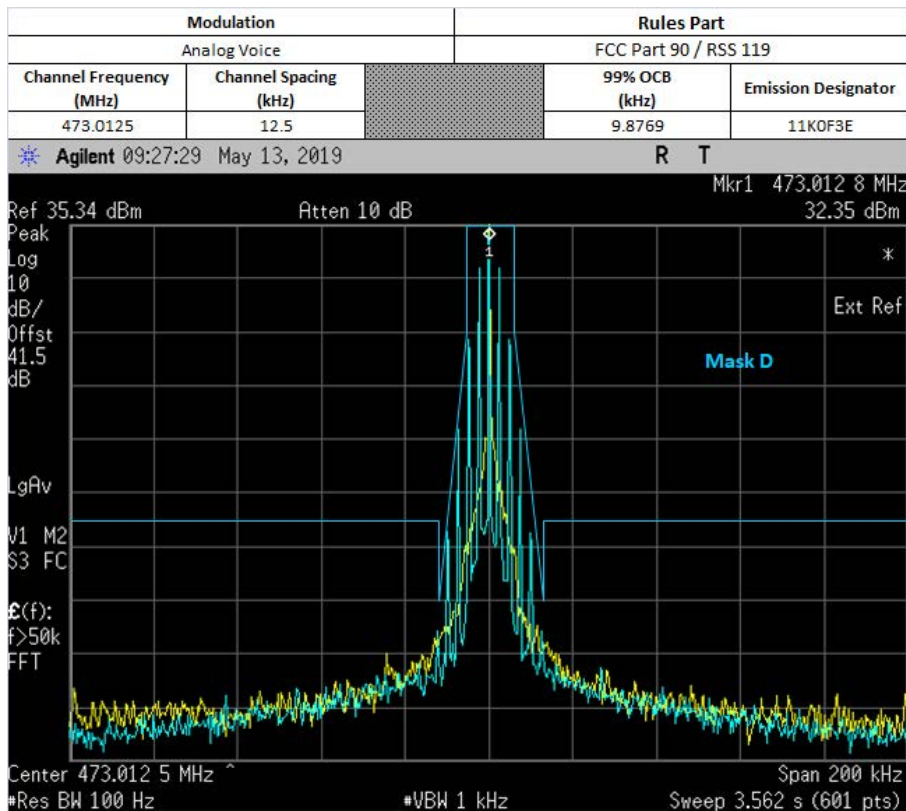

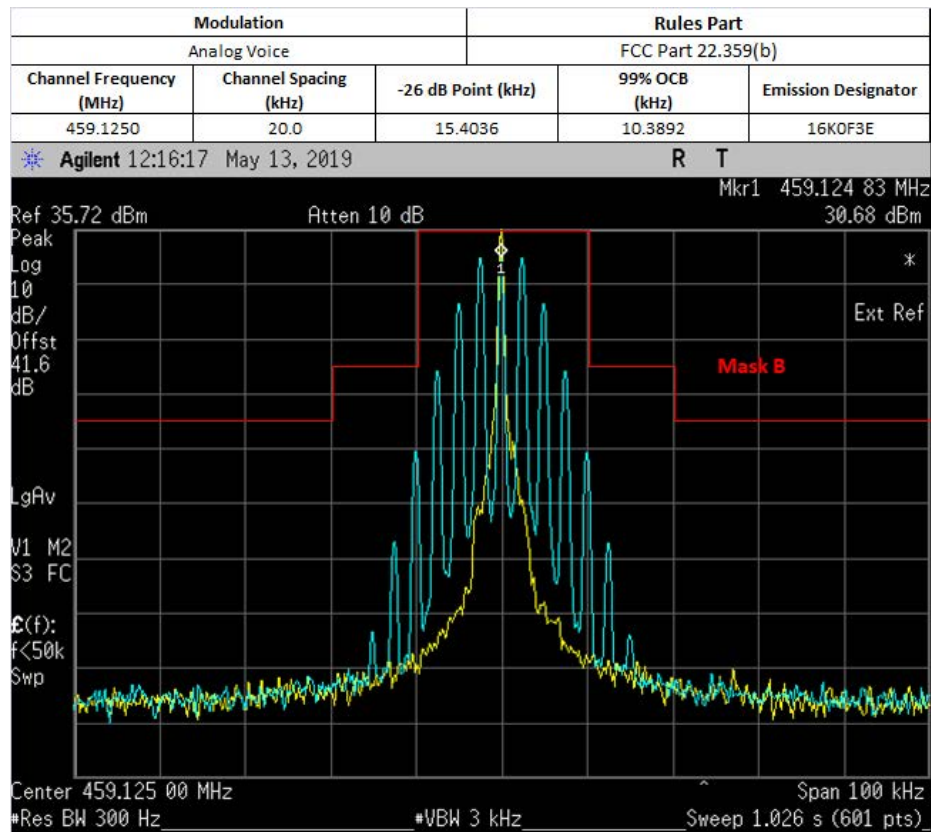



### 6.6.3. Test Setup (Digital)

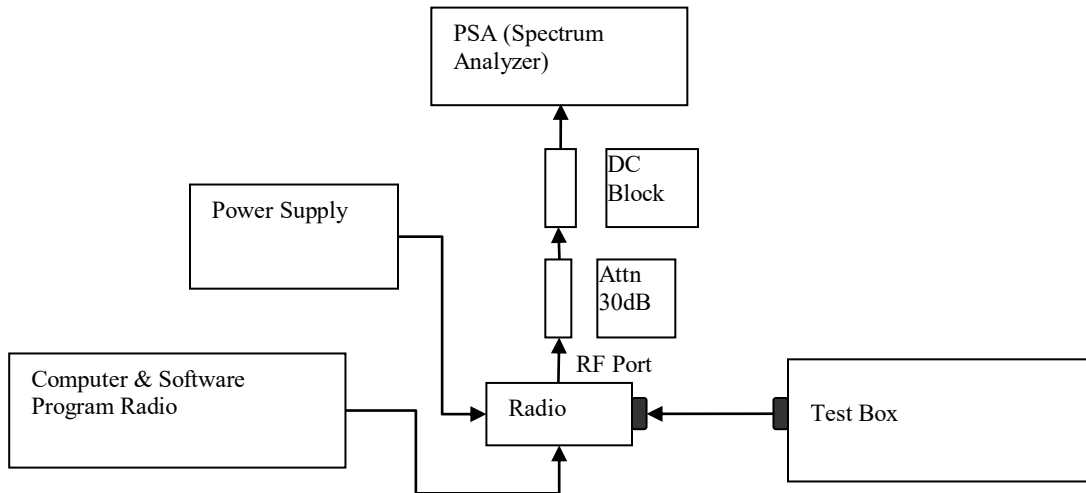

- 1) Program and set radio to operate in desire test frequency and digital mode with modulation. (\*4FSK, C4FM or other digital modulation form).
- 2) Path loss for the measurement included.
- 3) Select the Occupied Bandwidth measurement for 99% Emissions Bandwidth Measurement.
- 4) Key in the Fc and Resolution Bandwidth (1 ~ 5 % of emission designator).
- 5) Transmit the DUT and record the occupied Bandwidth frequency.
- 6) Preset the spectrum analyzer for modulation emission spectrum measurement.
- 7) Set the span and Resolution Bandwidth (according to FCC/ ISED standard).
- 8) Capture the screen shot as modulated signal.

\*Note:

- For Digital Modulation, 12.5 kHz Data F1D & FXD would be the same. Therefore only measurements with F1D modulation shown below.
- For Digital Modulation, 12.5 kHz Data F1E & FXE would be the same. Therefore only measurements with F1E modulation shown below.

### 6.6.4. Test Result (Digital)

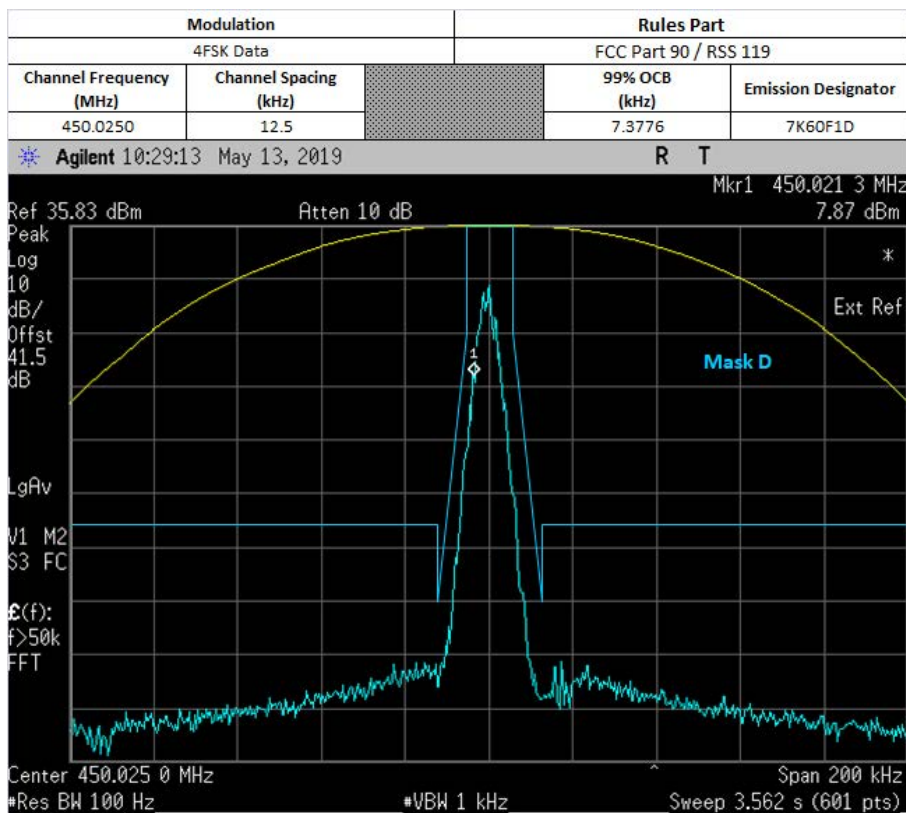
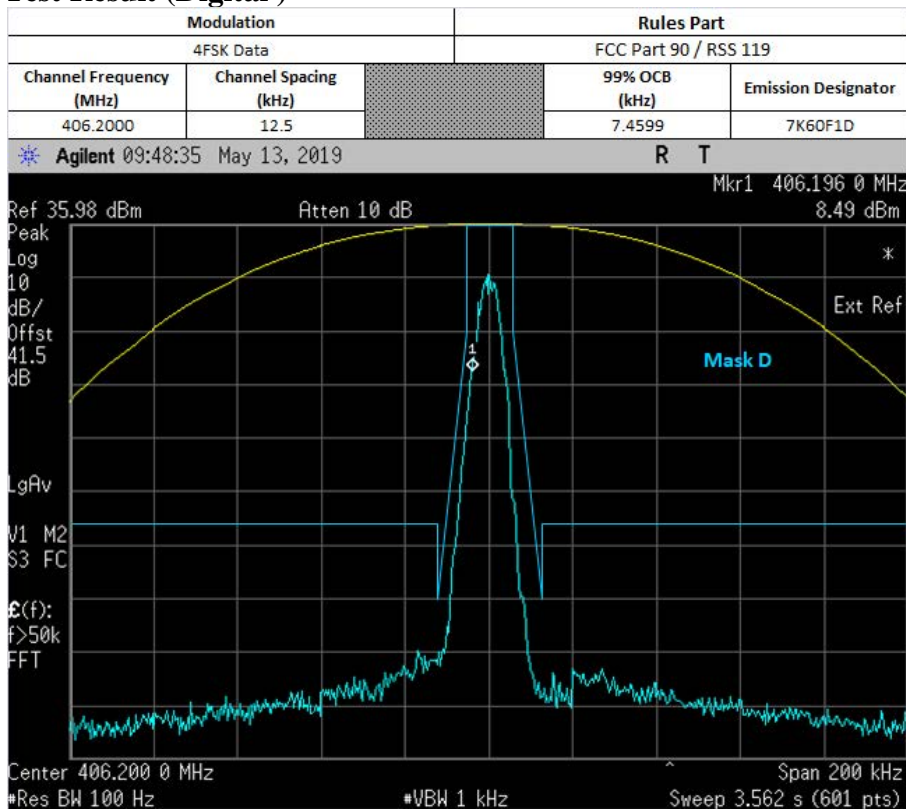

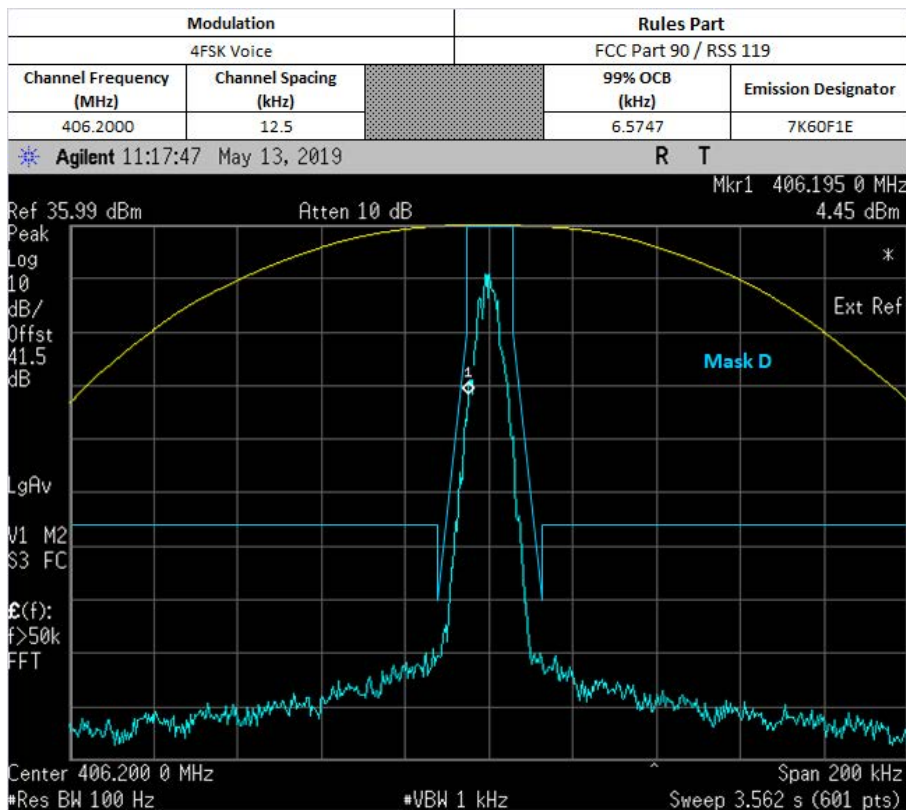
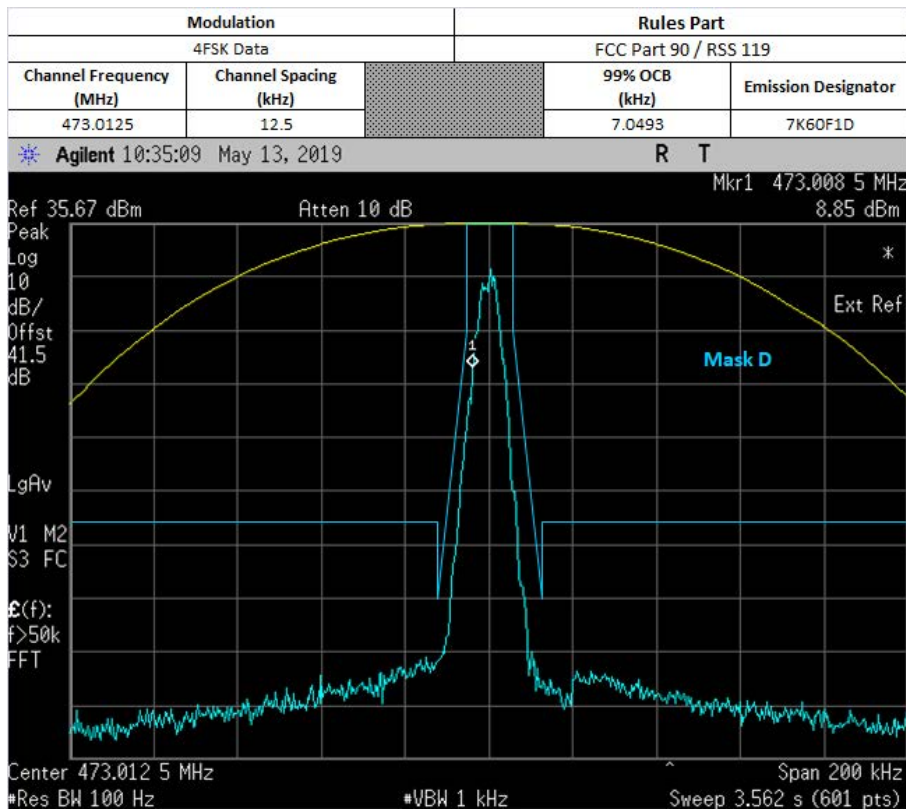

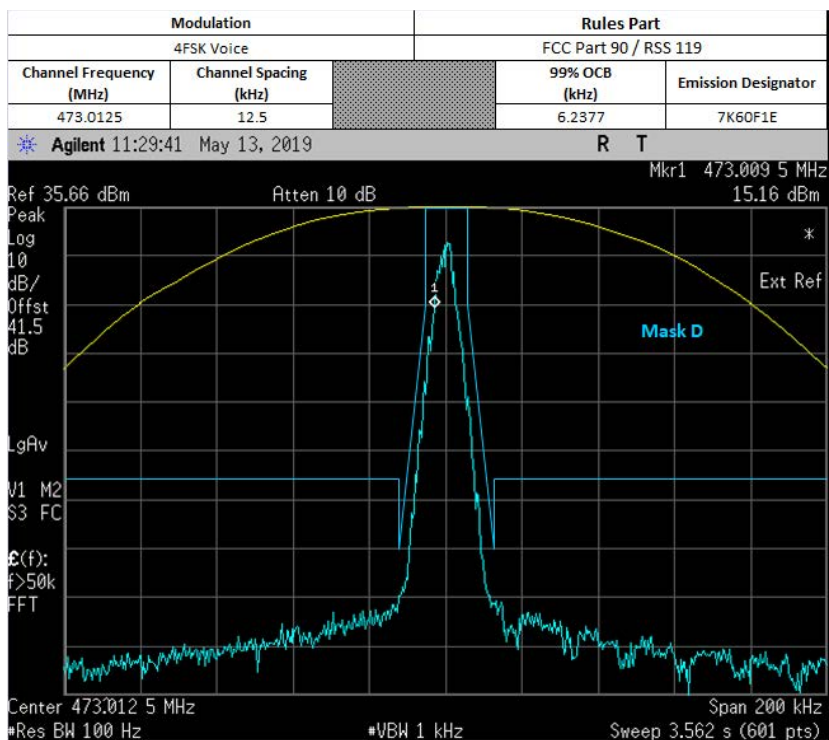
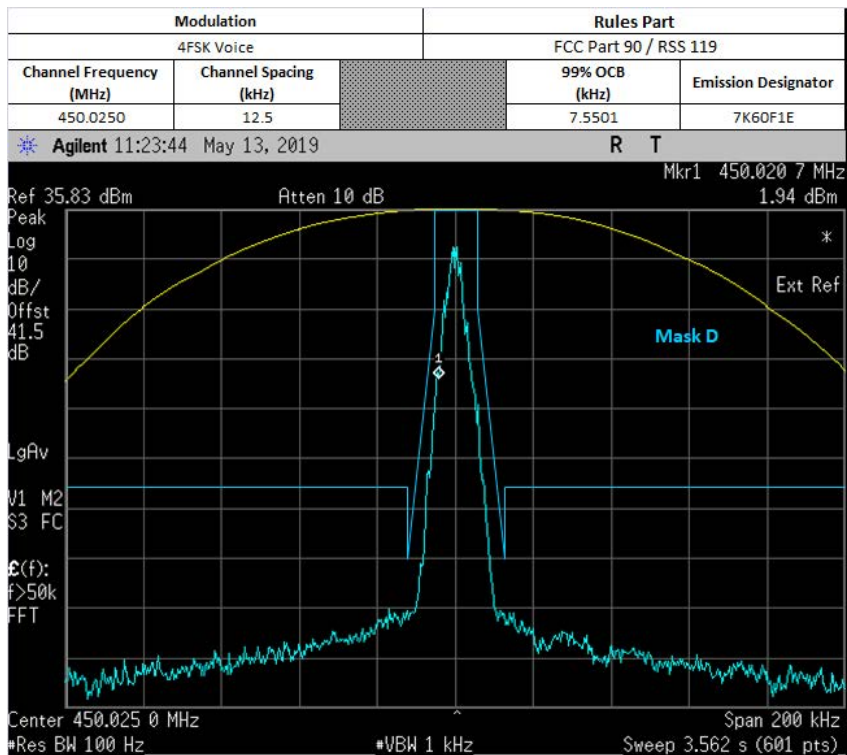

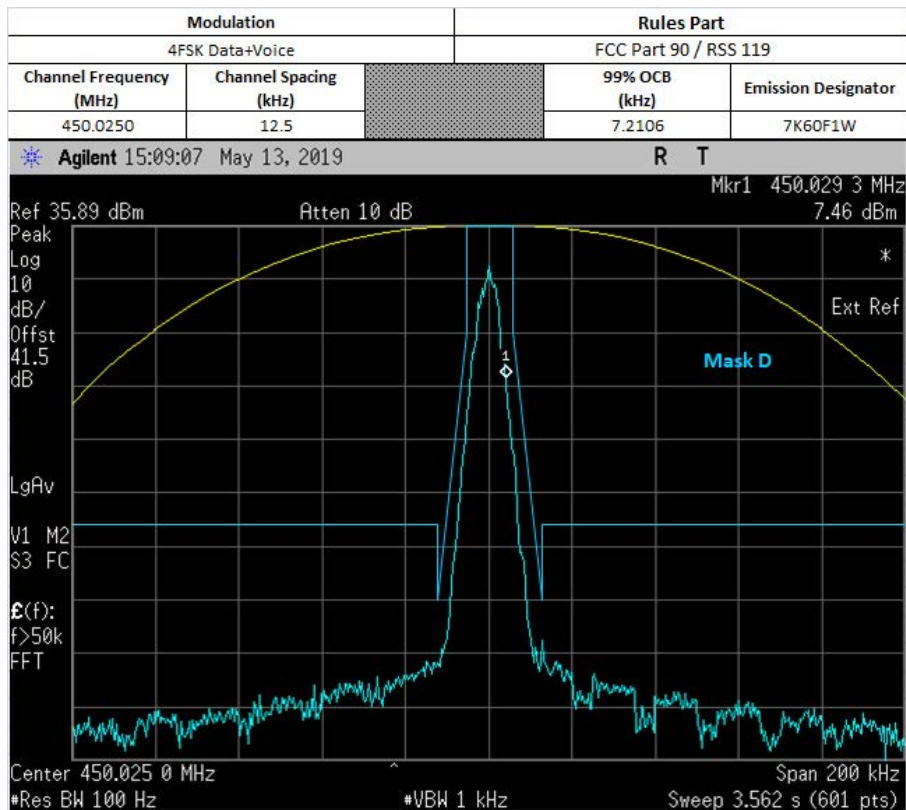
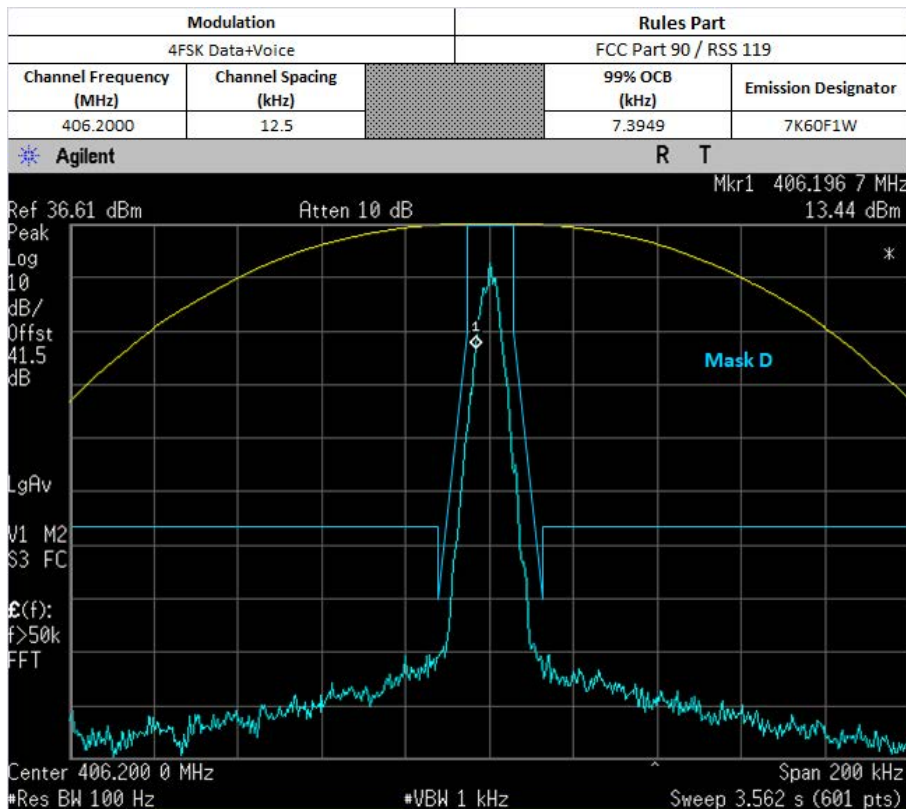

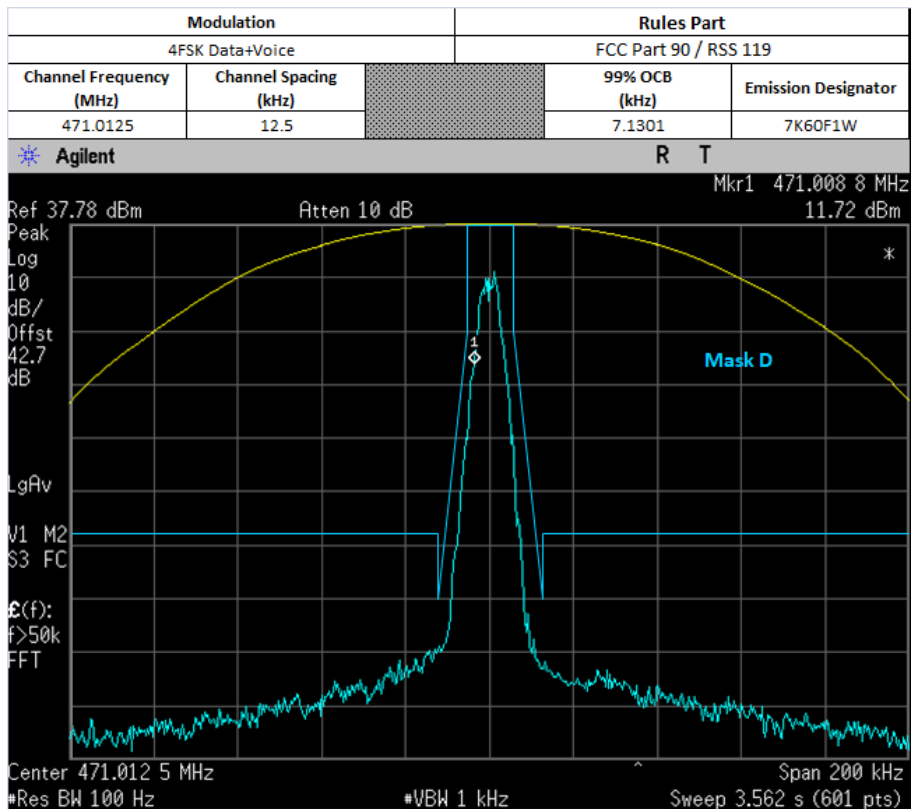

**6.6.5. Test Limit**

The 99% occupied bandwidth is the width of a frequency band such that, below the lower and above the upper frequency limits, the mean powers emitted are each equal to a specified percentage 0.5% of the total mean transmitted power.

## 6.7. Band Edge Conducted Spurious Emission (Part 22)

### 6.7.1. Test Setup (Analog)

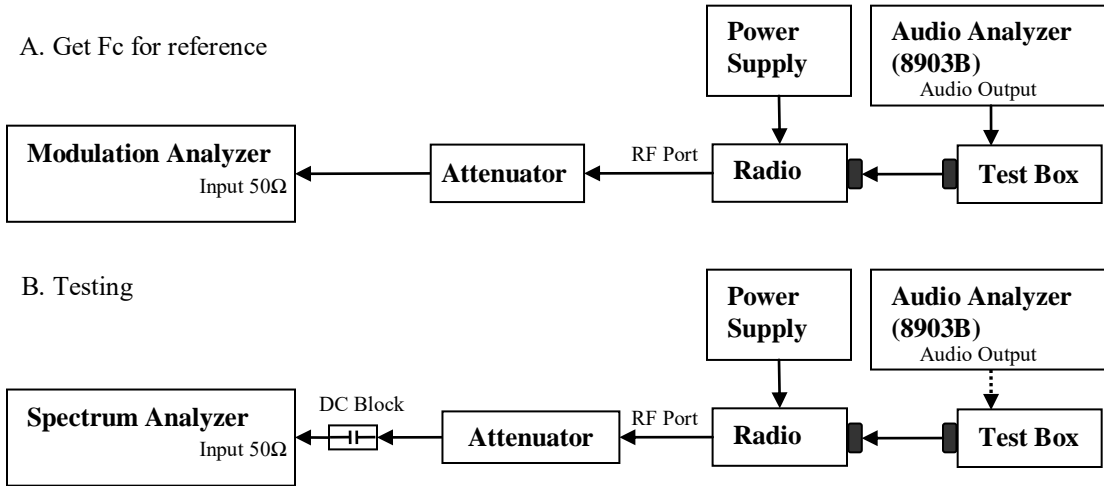

- 1) The DUT transmitter output port was connected to Modulation Analyzer.
- 2) Set the audio bandwidth filter to 15 kHz low pass filter and 50 kHz high pass filter.
- 3) Transmit the radio and set the audio analyzer to 2.5 kHz audio frequency and 50% of the rated deviation. Up the amplitude by 16 dB. Dekey the DUT.
- 4) Path loss for the measurement included.
- 5) Select the Occupied Bandwidth measurement for 99% and 26dB Emissions Bandwidth Measurement.
- 6) Key in the Fc and Resolution Bandwidth.
- 7) Transmit the DUT and record the occupied Bandwidth frequencies.
- 8) Preset the spectrum analyzer for band edge measurement.
- 9) The band edges of lowest and highest channels were measured.
- 10) Key in the Lowest and highest channel frequency, span is 60 kHz and Resolution Bandwidth is at least 1% of Emission Bandwidth.
- 11) Save the screen shot as modulated signal.
- 12) Remove the audio tone from audio analyzer to capture unmodulated signal.

\*Note:

- For emission designator ending with F3E, 16K0F3E is the worst case and therefore only 16K0F3E will be shown.

### 6.7.2. Test Result (Analog)

#### MAX POWER

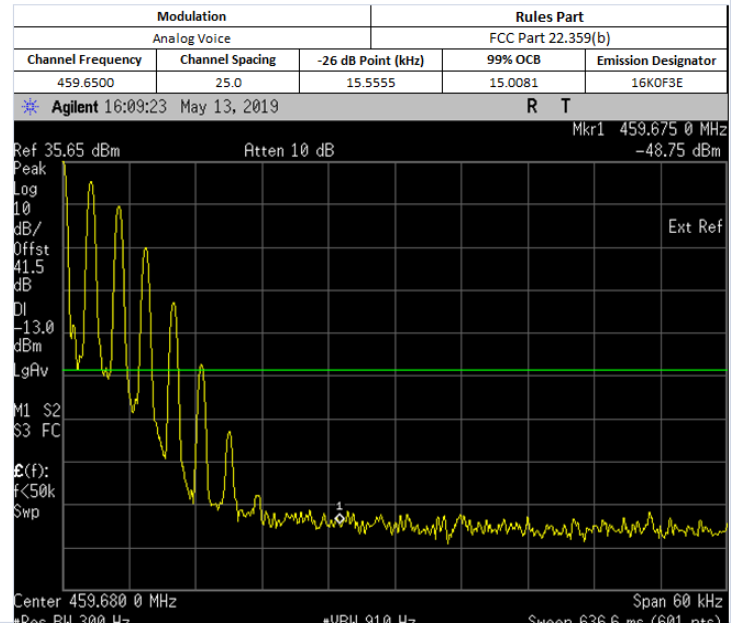
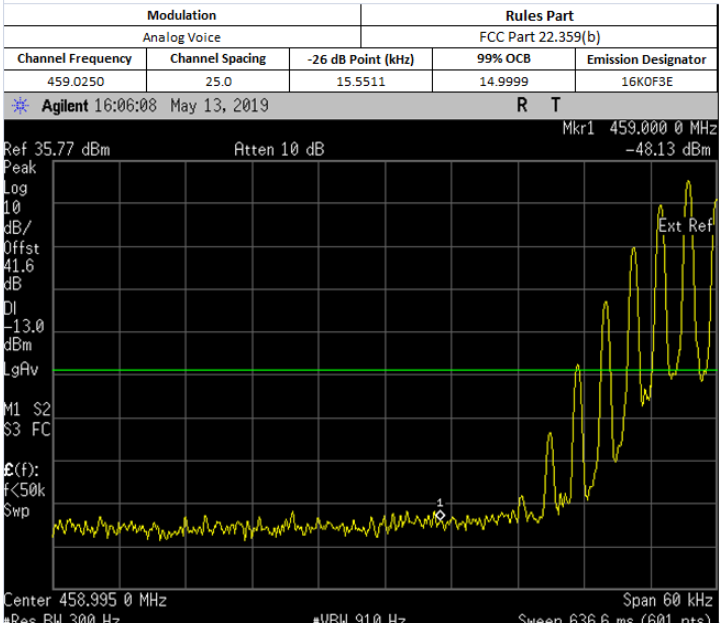

#### MAX POWER

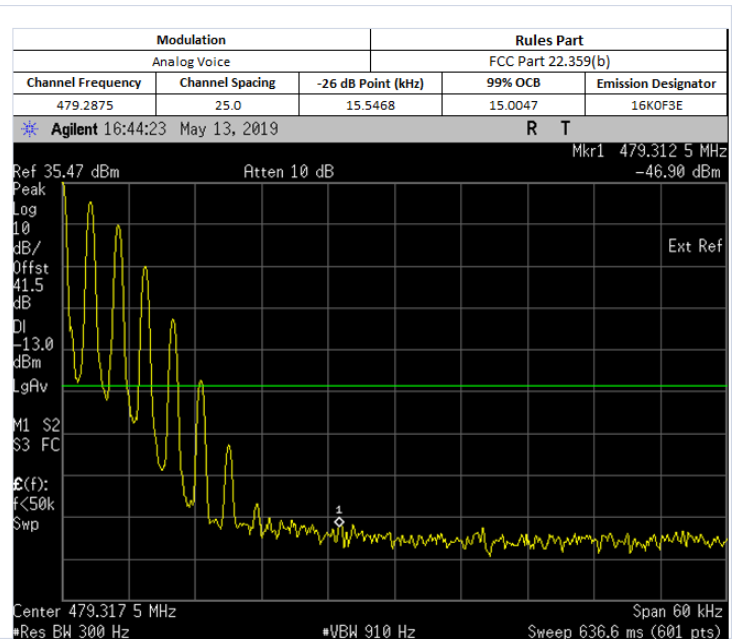
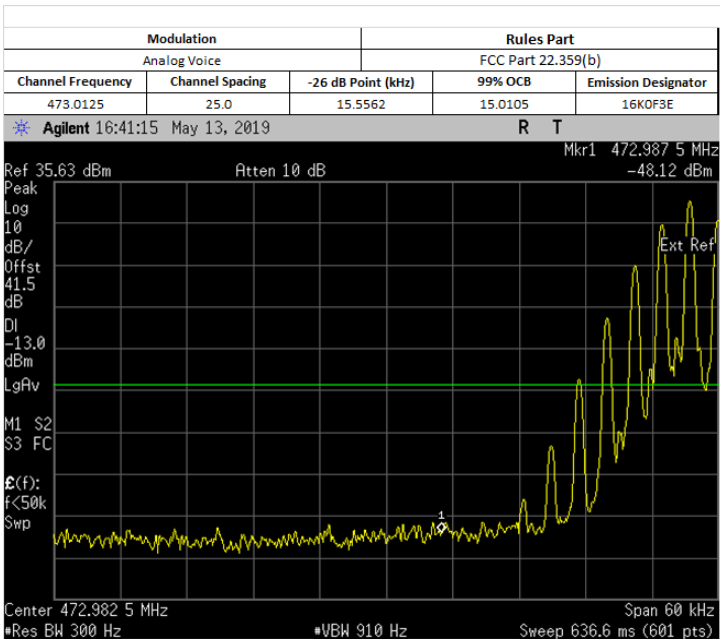



### 6.7.3. Test Setup (Digital)

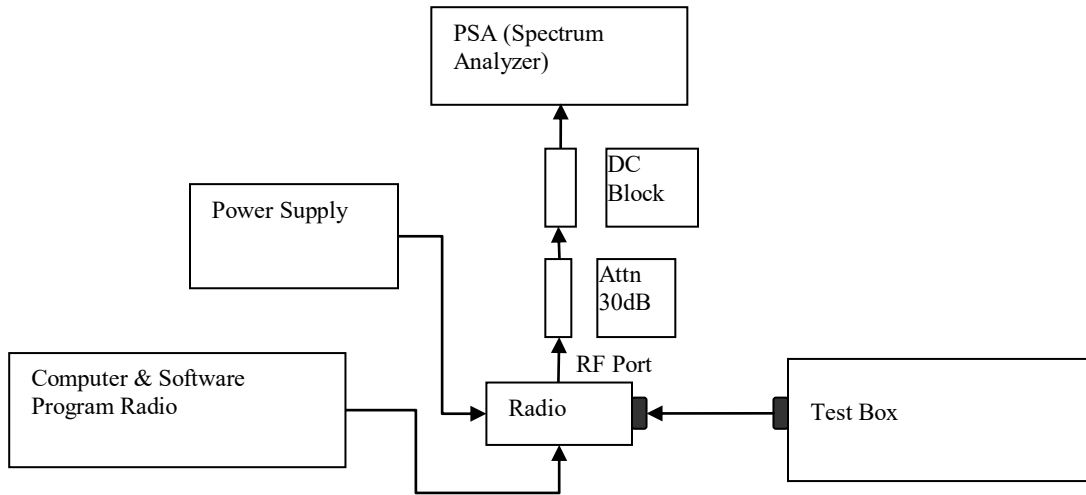

- 1) Program and set radio to operate in desire test frequency and digital mode with modulation. (\*4FSK, C4FM or other digital modulation form).
- 2) Path loss for the measurement included.
- 3) Select the Occupied Bandwidth measurement for 99% and 26dB Emissions Bandwidth Measurement.
- 4) Key in the Fc and Resolution Bandwidth.
- 5) Transmit radio record the occupied Bandwidth frequencies.
- 6) Preset the spectrum analyzer for band edge measurement.
- 7) Key in the lowest and highest channels frequency, span is 60 kHz and Resolution Bandwidth is at least 1% of Emission Bandwidth.
- 8) Save the screen shot.

\*Note:

- All digital modulation modes utilize the same high deviation test pattern, and they are therefore identical. Hence, only F1D plots will be shown.

### 6.7.4. Test Result (Digital)

#### MAX POWER

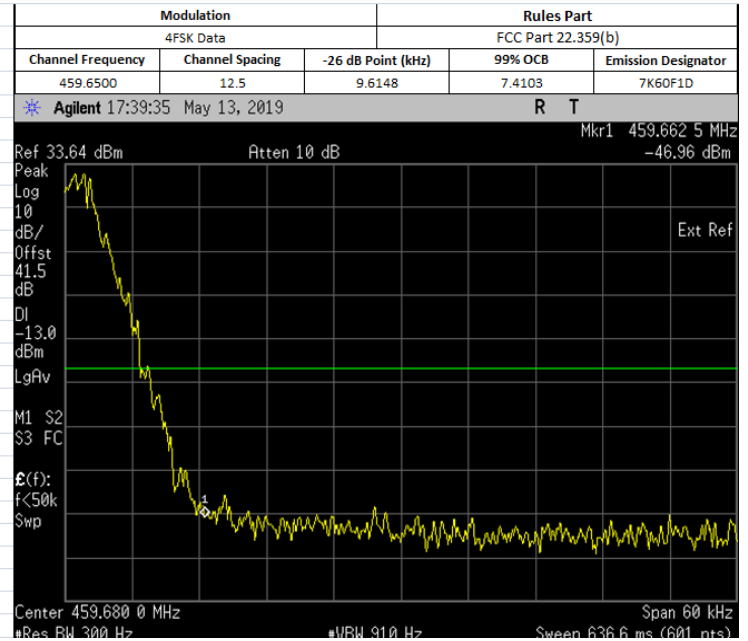
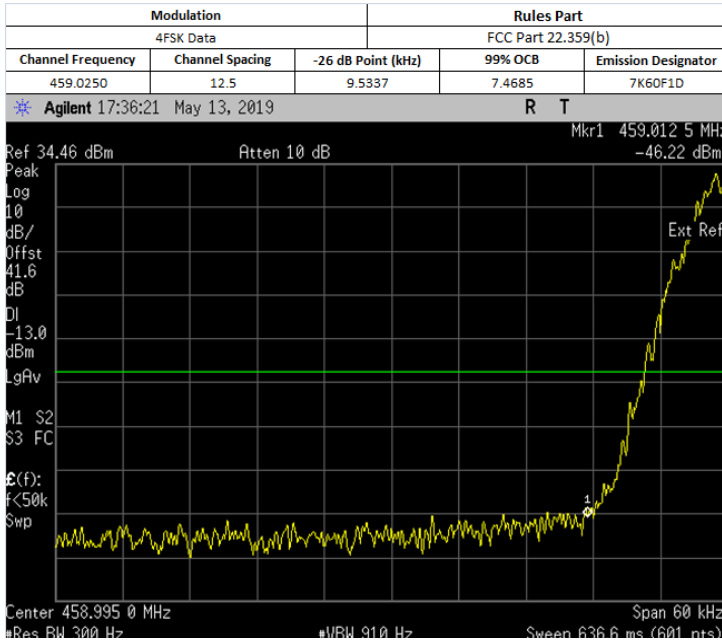

#### MAX POWER

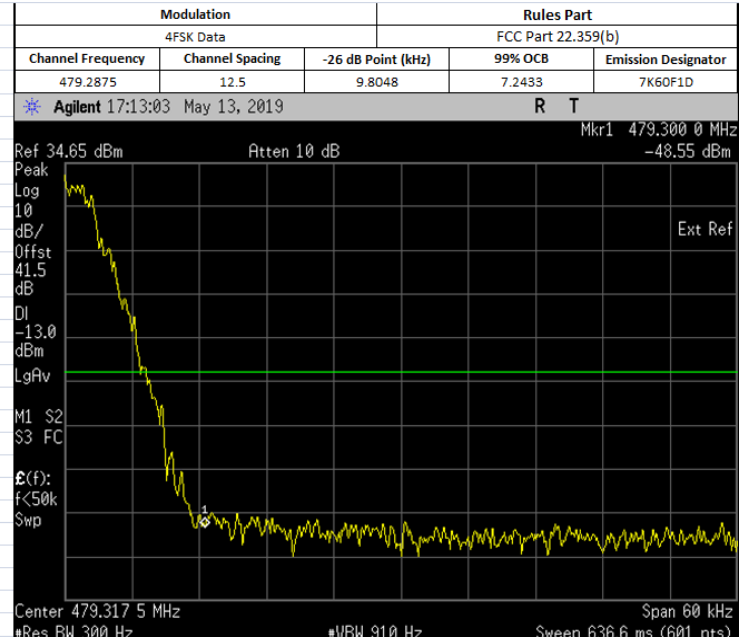
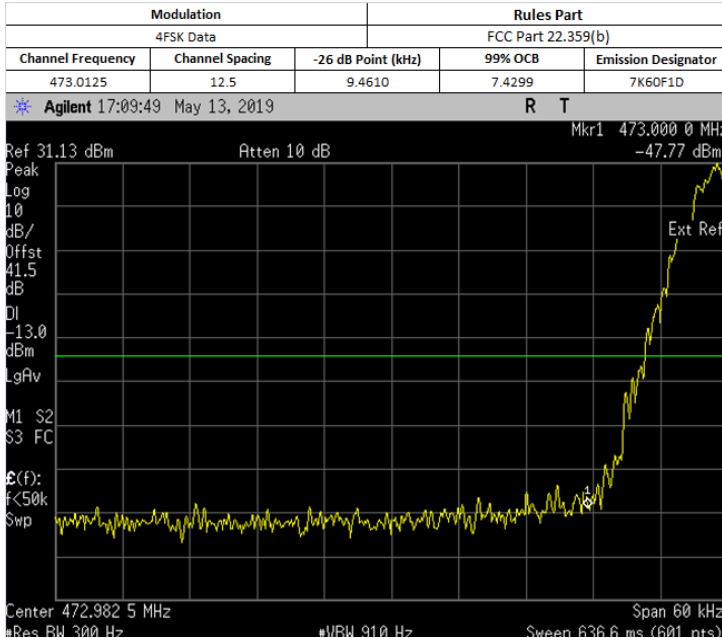

#### Test Limit

The power of any emission outside of the authorized operating frequency ranges must be attenuated below the transmitting power (P) by a factor of at least  $43 + 10 \log(P)$  dB.

## 6.8. Transient Frequency Behavior

### 6.8.1. Test Setup

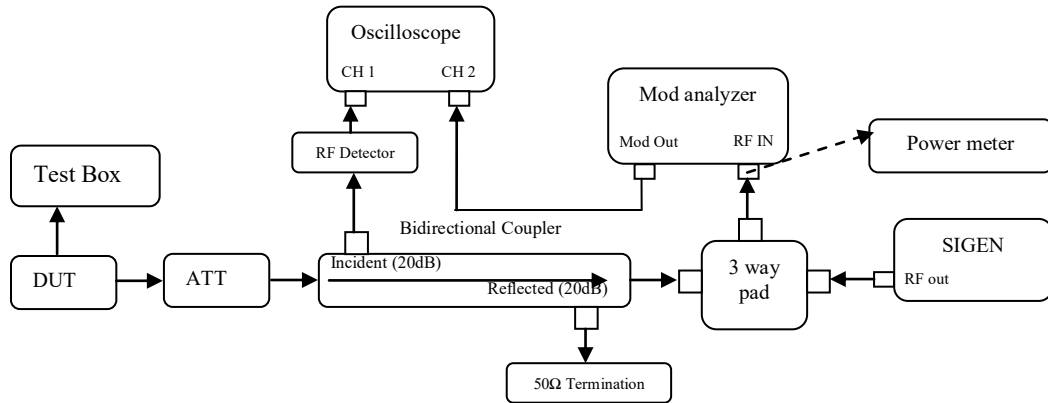

- 1) Connect the setup as figure above.
- 2) Path loss for the measurement included.
- 3) Set on Siggen with the assigned center frequency, internal 1 kHz FM tone.  
FM Deviation: Analog 25kHz Channel Spacing = 25 kHz  
Analog 12.5 kHz Channel Spacing = 12.5 kHz  
C4FM = 12.5 kHz
- 4) Turn on 50 kHz high pass filter and 15 kHz low pass filter on modulation analyzer.
- 5) Supply sufficient attenuation ATT to provide the output power of  $\leq -11\text{dBm}$  into power meter when DUT is keying up.
- 6) Note the power level on power meter and dekey the DUT.
- 7) Adjust the amplitude of the signal generator to the level power meter, maintained the amplitude throughout the rest of the measurement.
- 8) Connect the output to modulation analyzer.
- 9) Reduce 30dB attenuation and transmit the radio to get the trigger line.
- 10) Capture the screen shot for key-up (rising edge) and de-key (falling edge) mode.

### 6.8.2. Test Result

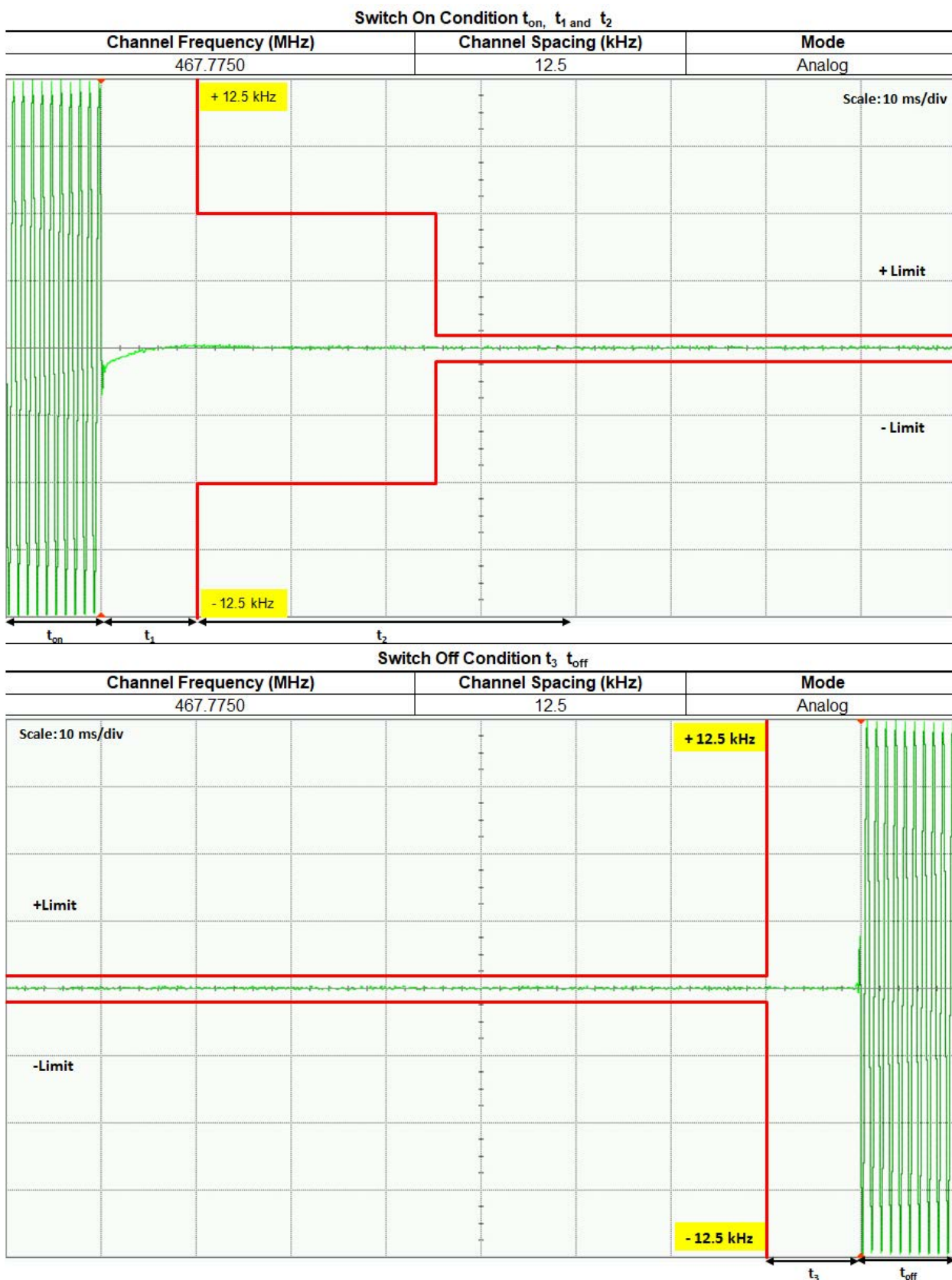

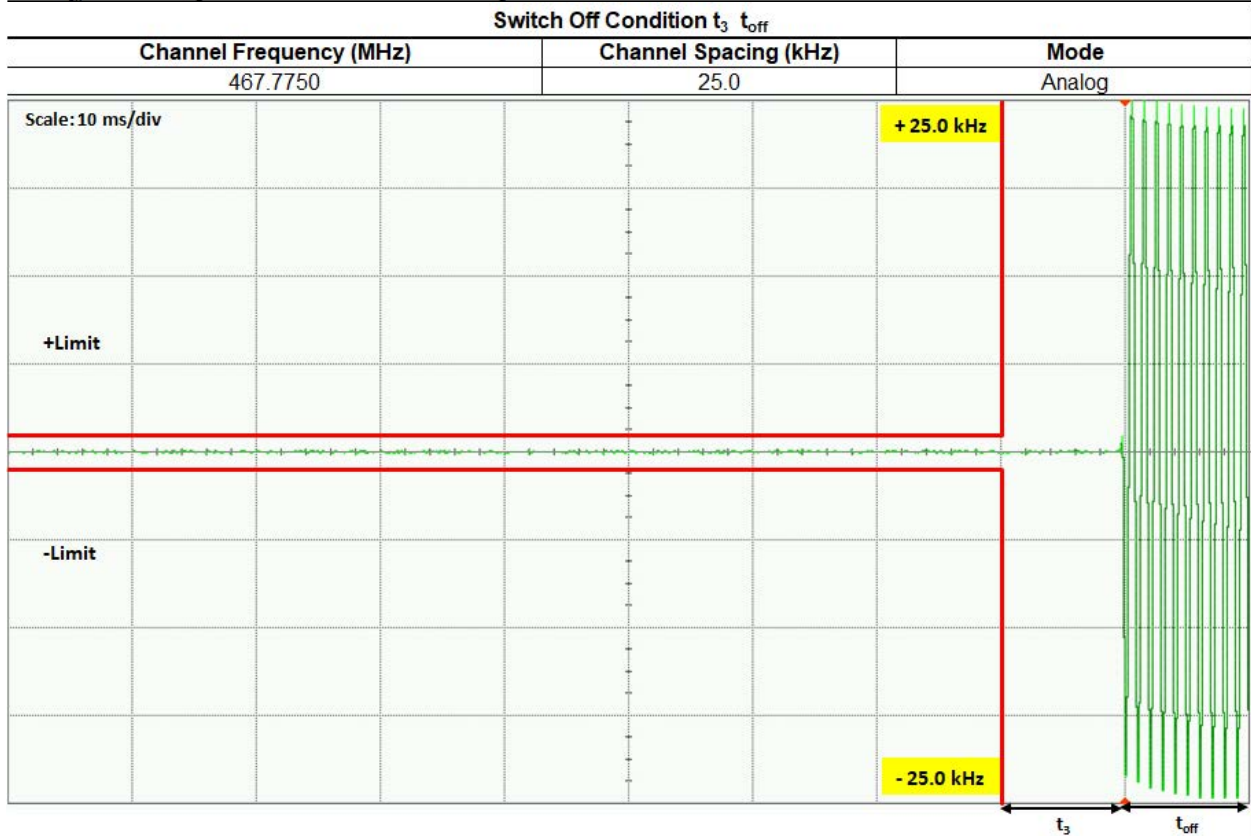
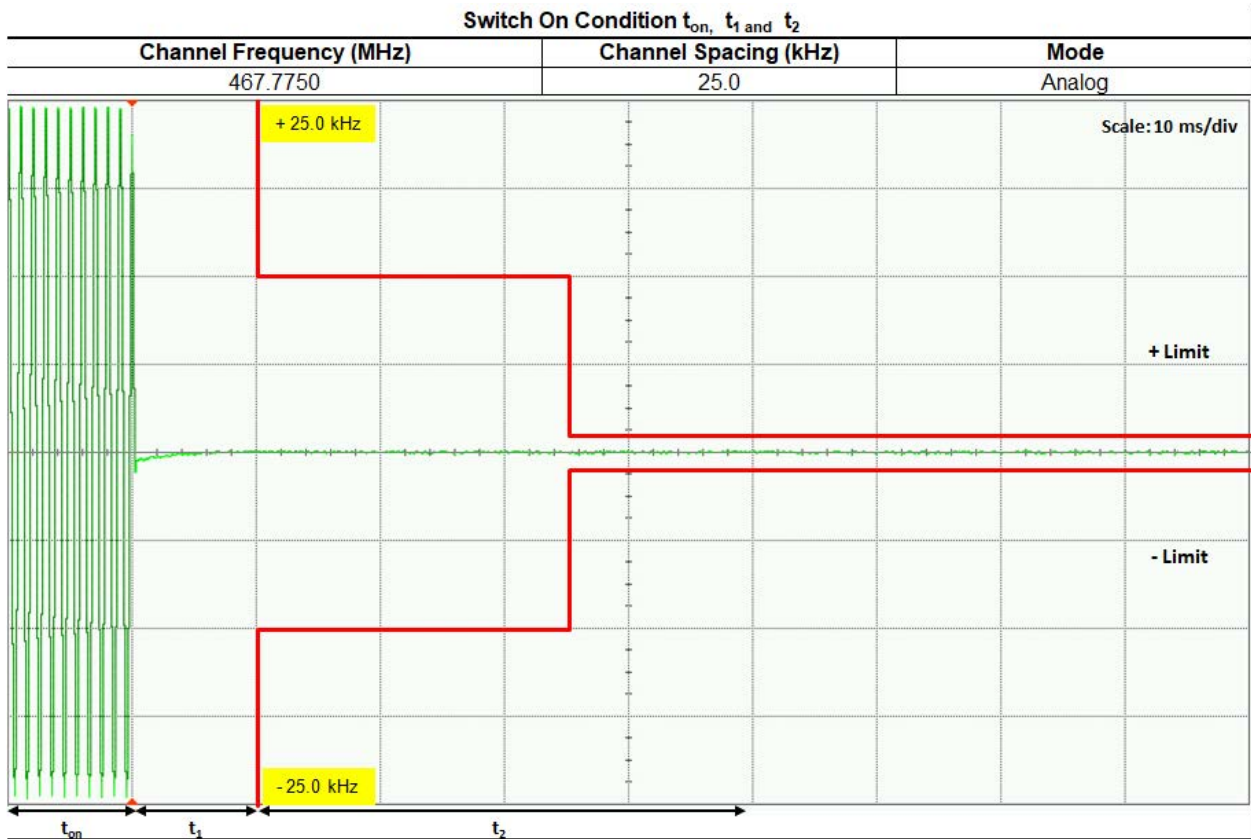

**6.8.3. Test Limit**

Transmitters designed to operate in the 150-174 MHz and 421-512 MHz frequency bands must maintain transient frequencies within the maximum frequency difference limits during the time intervals indicated:

Time intervals <sup>1 2</sup>	Maximum frequency difference <sup>3</sup>	All equipment	
		150 to 174 MHz	421 to 512 MHz
Transient Frequency Behavior for Equipment Designed to Operate on 25 kHz Channels			
t <sub>1</sub> <sup>4</sup>	±25.0 kHz	5.0 ms	10.0 ms
t <sub>2</sub>	±12.5 kHz	20.0 ms	25.0 ms
t <sub>3</sub> <sup>4</sup>	±25.0 kHz	5.0 ms	10.0 ms
Transient Frequency Behavior for Equipment Designed to Operate on 12.5 kHz Channels			
t <sub>1</sub> <sup>4</sup>	±12.5 kHz	5.0 ms	10.0 ms
t <sub>2</sub>	±6.25 kHz	20.0 ms	25.0 ms
t <sub>3</sub> <sup>4</sup>	±12.5 kHz	5.0 ms	10.0 ms
Transient Frequency Behavior for Equipment Designed to Operate on 6.25 kHz Channels			
t <sub>1</sub> <sup>4</sup>	±6.25 kHz	5.0 ms	10.0 ms
t <sub>2</sub>	±3.125 kHz	20.0 ms	25.0 ms
t <sub>3</sub> <sup>4</sup>	±6.25 kHz	5.0 ms	10.0 ms

<sup>1</sup> <sub>on</sub> is the instant when a 1 kHz test signal is completely suppressed, including any capture time due to phasing.

t<sub>1</sub> is the time period immediately following t<sub>on</sub>.

t<sub>2</sub> is the time period immediately following t<sub>1</sub>.

t<sub>3</sub> is the time period from the instant when the transmitter is turned off until t<sub>off</sub>.

t<sub>off</sub> is the instant when the 1 kHz test signal starts to rise.

<sup>2</sup> During the time from the end of t<sub>2</sub> to the beginning of t<sub>3</sub>, the frequency difference must not exceed the limits specified in §90.213.

<sup>3</sup> Difference between the actual transmitter frequency and the assigned transmitter frequency.

<sup>4</sup> If the transmitter carrier output power rating is 6 watts or less, the frequency difference during this time period may exceed the maximum frequency difference for this time period.

## 6.9. Adjacent Channel Power

### 6.9.1. Test Setup (Analog)

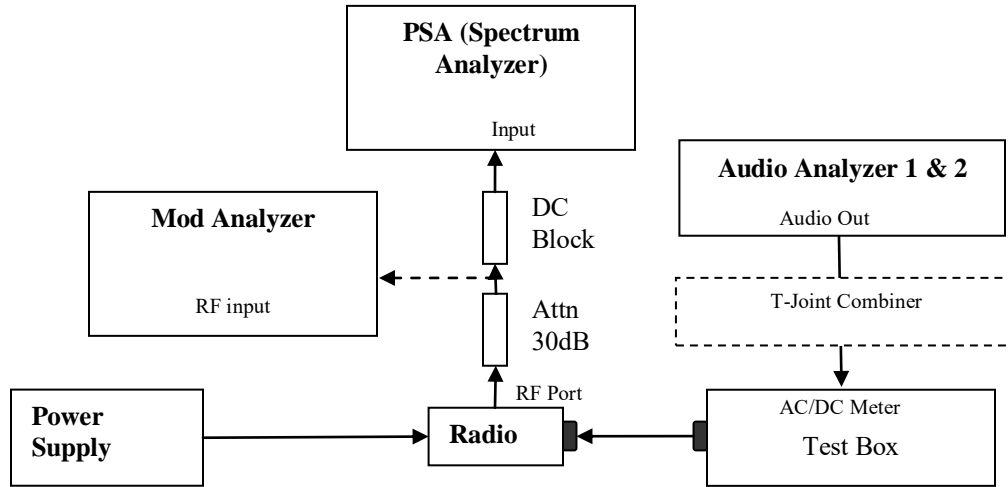

- 1) The DUT transmitter output port was connected to modulation analyzer.
- 2) Transmit the radio and turn on 1<sup>st</sup> audio analyzer with audio frequency 650Hz, 50% rated deviation, and record the amplitude value as AmpT1.
- 3) Turn off Audio analyzer 1 and turn on audio analyzer 2, set the audio frequency to 2.2 kHz and 50% deviation. Record the amplitude as AmpT2.
- 4) Turn both audio analyzers ON and up 10dB amplitude level.
- 5) Connect the output to PSA and set to assigned center frequency.
- 6) Set Span, Resolution Bandwidth and Video Bandwidth per rules part.
- 7) Transmit the radio and record the Adjacent Channel Power value in dBc.

### 6.9.2. Test Result NA → Not Applicable

### 6.9.3. Test Setup (Digital)

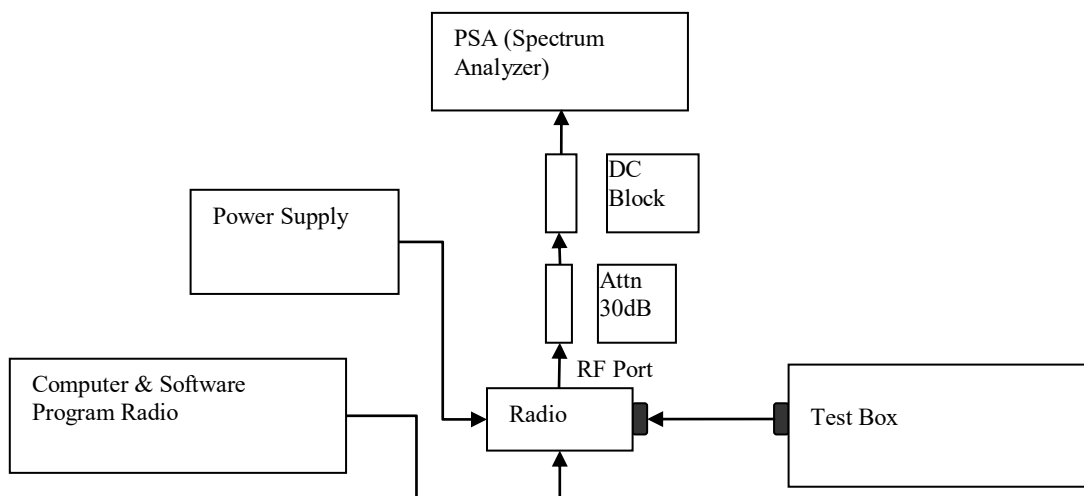

- 1) Program and set radio to operate in desire test frequency and digital mode with modulation. (4FSK, C4FM or other digital modulation form).
- 2) Prepare setup as per picture.
- 3) Turn on the ACP Measurement – Press Measure, ACP.
- 4) Set Span, Resolution Bandwidth and Video Bandwidth as per rules part.
- 5) Transmit the radio and record the Adjacent Channel Power value in dBc.

### 6.9.4. Test result NA → Not Applicable

### 6.9.5. Test limit

#### 12.5 kHz MOBILE TRANSMITTER ACP REQUIREMENTS

Offset from center frequency (kHz)	Measurement bandwidth (kHz)	Maximum ACP relative (dBc)
9.375	6.25	-40
15.625	6.25	-60
21.875	6.25	-60
37.50	25.00	-60
62.50	25.00	-65
87.50	25.00	-65
150.00	100	-65
250.00	100	-65
350.00	100	-65
>400 to 12 MHz	30 (s)	-75
12 MHz to paired receive band	30 (s)	-75
In the paired receive band	30 (s)	-100



**25 kHz MOBILE TRANSMITTER ACP REQUIREMENTS**

Offset from center frequency (kHz)	Measurement bandwidth (kHz)	Maximum ACP relative (dBc)
15.625	6.25	-40
21.875	6.25	-60
37.50	25	-60
62.50	25	-65
87.50	25	-65
150.00	100	-65
250.00	100	-65
350.00	100	-65
>400 kHz to 12 MHz	30 (s)	-75
12 MHz to paired receive band	30 (s)	-75
In the paired receive band	30 (s)	-100

**12.5 kHz BASE TRANSMITTER ACP REQUIREMENTS**

Offset from center frequency (kHz)	Measurement bandwidth (kHz)	Maximum ACP (dBc)
9.375	6.25	-40
15.625	6.25	-60
21.875	6.25	-60
37.5	25	-60
62.5	25	-65
87.5	25	-65
150	100	-65
250	100	-65
350.00	100	-65
>400 kHz to 12 MHz	30 (s)	-80
12 MHz to paired receive band	30 (s)	-80
In the paired receive band	30 (s)	1-85

**25 kHz BASE TRANSMITTER ACP REQUIREMENTS**

Offset from center frequency (kHz)	Measurement bandwidth (kHz)	Maximum ACP (dBc)
15.625	6.25	-40
21.875	6.25	-60
37.5	25	-60
62.5	25	-65
87.5	25	-65
150	100	-65
250	100	-65
350	100.00	-65
>400 kHz to 12 MHz	30 (s)	-80
12 MHz to paired receive band	30 (s)	-80
In the paired receive band	30 (s)	1-85

## 6.10. Conducted Spurious Emission

### 6.10.1. Test Setup

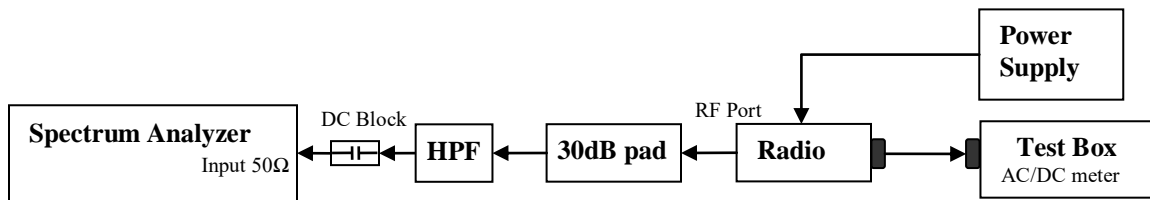

- 1) The DUT transmitter output port was connected to Spectrum Analyzer with above setup.
- 2) Program and set radio to operate in desire test frequency and mode. (Analog / digital modulation form).
- 3) Path loss for the measurement included.
- 4) Set the PSA Resolution Bandwidth as per rules part.
- 5) Set the Ref offset from the pathloss offset calibration file.
- 6) Adjust the center frequency of the spectrum analyzer for incremental coverage of the range from:
  - a. 9 KHz to  $F_c - \text{Test Bandwidth}$
  - b.  $F_c + \text{Test Bandwidth}$  to  $2F_c - 5\text{MHz}$ .
- 7) Key up the DUT, Peak Search the highest Spur and record the levels of spurious emissions
- 8) Dekey the DUT.
- 9) Turn On High Pass Filter path and Key up the DUT.
- 10) Adjust the PSA Freq for incremental coverage of range from  $2F_c$  to  $10F_c$
- 11) Key up the DUT and record the highest spur levels of spurious emissions.

**6.10.2. Test Result (Analog)**

**Analog: 403.0125 MHz, 25.0kHz Channel Spacing, Max Power  
 RSS 119**

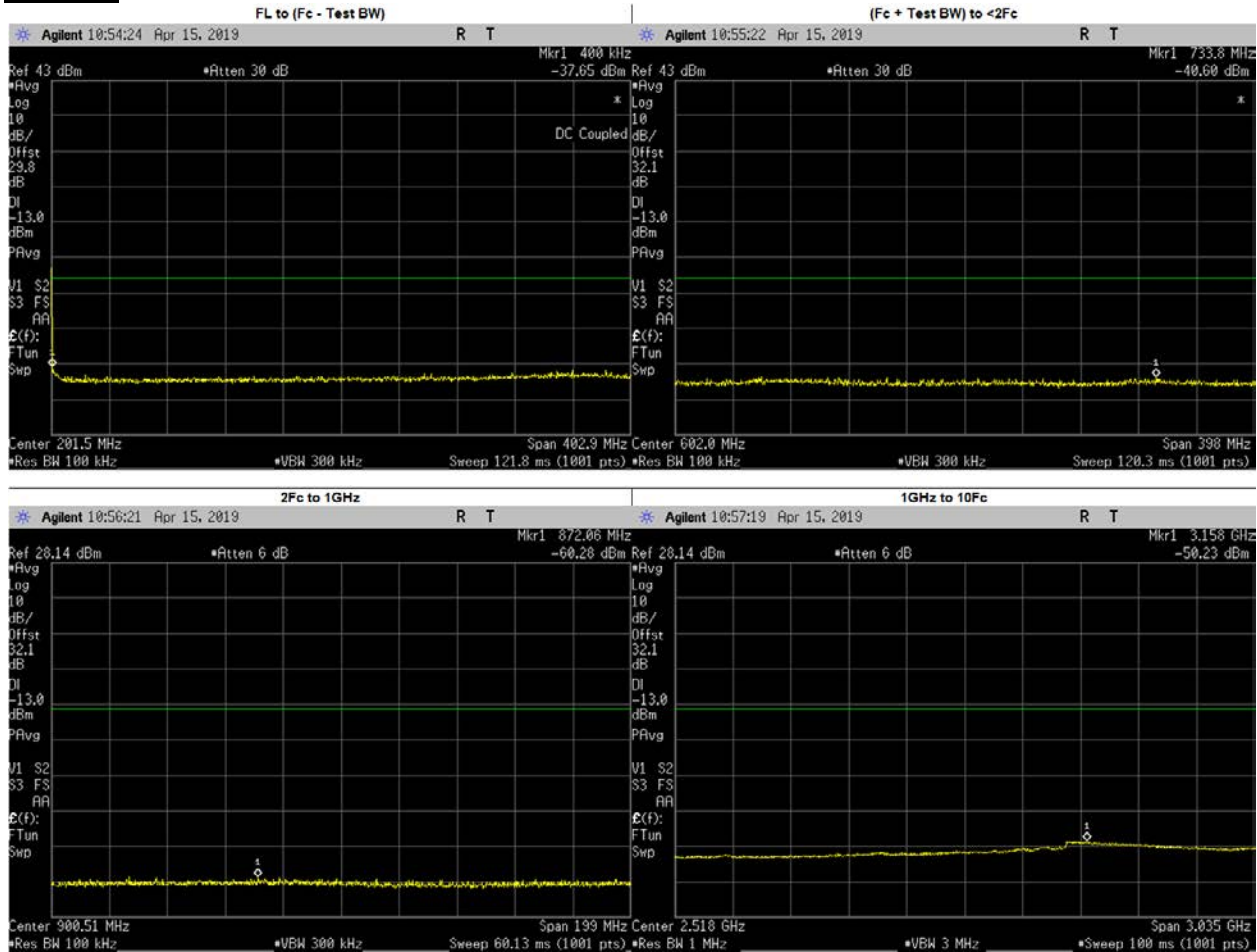

Frequency Range	Highest Spur Frequency (MHz)	Spurious Level (dBm)	Failing Limit (dBm)	Results
FL to (Fc - Test BW)	362.2591	-38.7400	-13	PASS
(Fc + Test BW) to <2Fc	733.7703	-40.6000	-13	PASS
2Fc to 1GHz	872.0591	-60.2800	-13	PASS
1GHz to 10Fc	3157.9740	-50.2300	-13	PASS
	1209.0370	-54.7939	-13	PASS
	1612.0500	-54.6572	-13	PASS
	2015.0620	-54.0907	-13	PASS
	2418.0750	-53.7904	-13	PASS
	2821.0880	-52.6401	-13	PASS
	3224.1000	-51.0706	-13	PASS
	3627.1130	-52.1214	-13	PASS
	4030.1250	-52.3921	-13	PASS

**Analog: 403.0125 MHz, 25.0kHz Channel Spacing, Low Power  
 RSS 119**

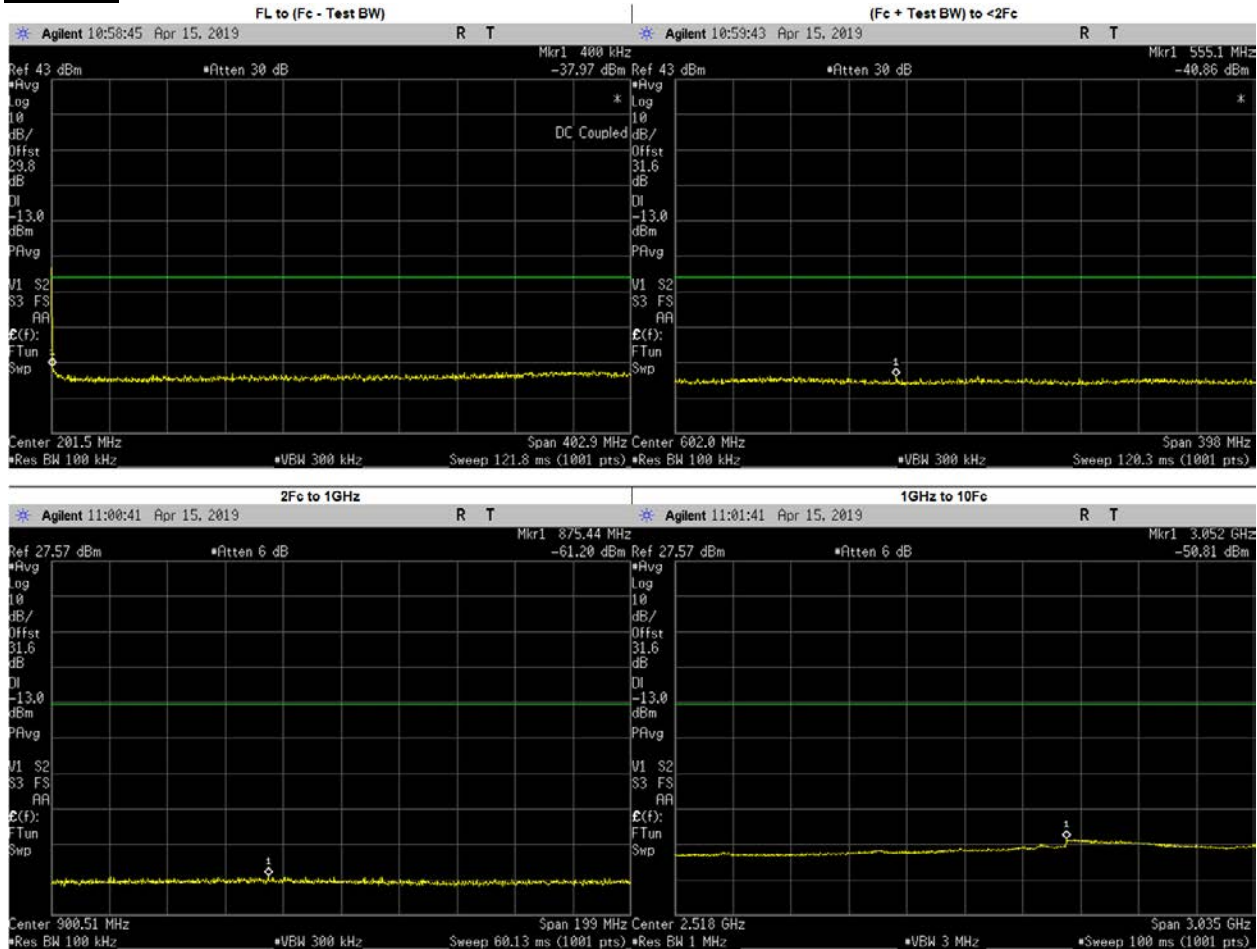

Frequency Range	Highest Spur Frequency (MHz)	Spurious Level (dBm)	Failing Limit (dBm)	Results
FL to (Fc - Test BW)	376.3623	-39.3400	-13	PASS
(Fc + Test BW) to <2Fc	555.0877	-40.8600	-13	PASS
2Fc to 1GHz	875.4416	-61.2000	-13	PASS
1GHz to 10Fc	3051.7440	-50.8100	-13	PASS
	1209.0370	-55.3482	-13	PASS
	1612.0500	-55.3348	-13	PASS
	2015.0620	-54.7134	-13	PASS
	2418.0750	-54.2369	-13	PASS
	2821.0880	-53.1926	-13	PASS
	3224.1000	-51.7220	-13	PASS
	3627.1130	-52.7978	-13	PASS
	4030.1250	-52.7066	-13	PASS

**Analog: 406.2 MHz, 25.0kHz Channel Spacing, Max Power  
 RSS 119**

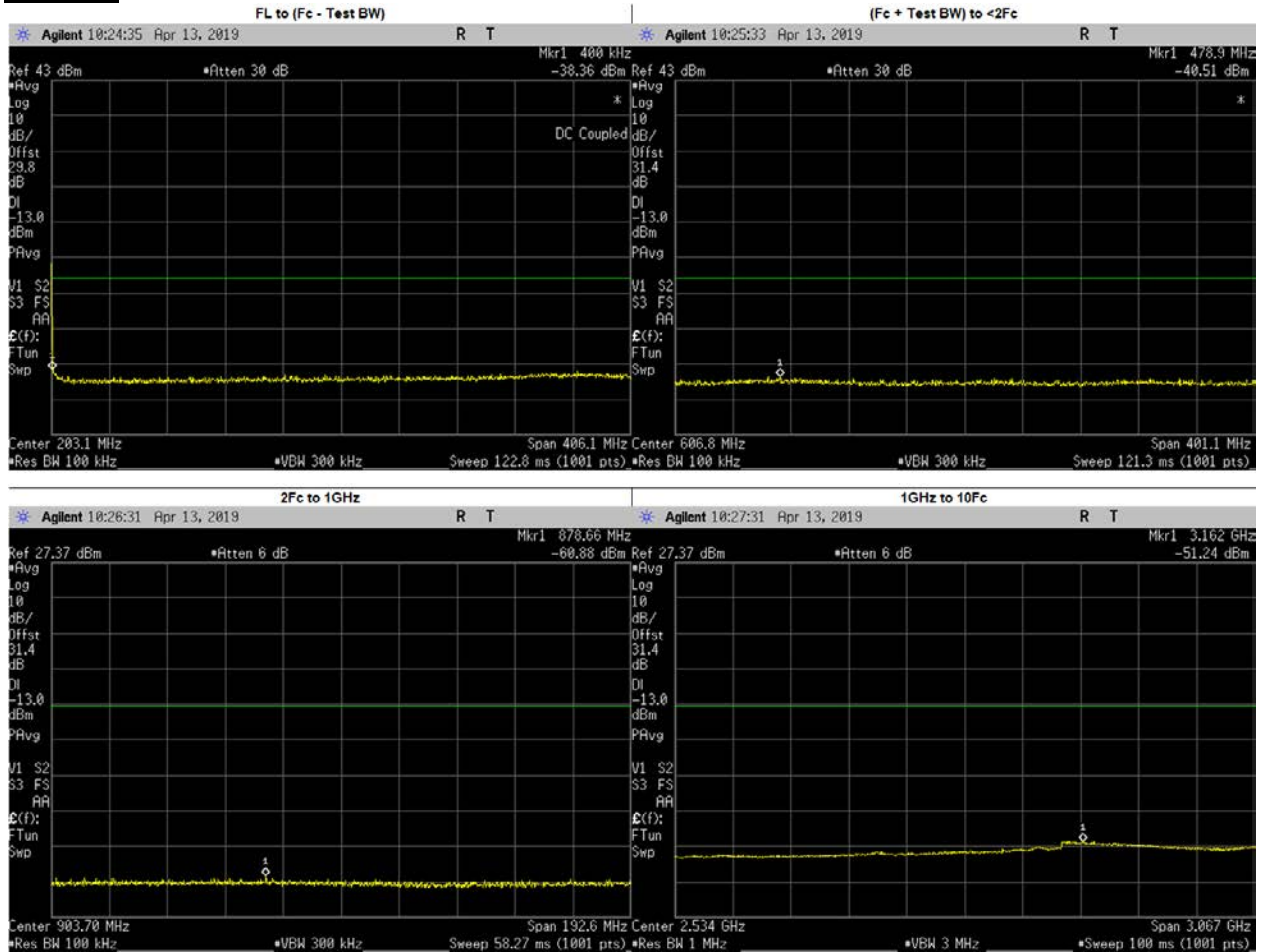

Frequency Range	Highest Spur Frequency (MHz)	Spurious Level (dBm)	Failing Limit (dBm)	Results
FL to (Fc - Test BW)	368.7799	-39.0800	-13	PASS
(Fc + Test BW) to <2Fc	478.8628	-40.5100	-13	PASS
2Fc to 1GHz	878.6620	-60.8800	-13	PASS
1GHz to 10Fc	3162.2350	-51.2400	-13	PASS
	1218.6000	-55.4157	-13	PASS
	1624.8000	-55.2949	-13	PASS
	2031.0000	-54.8157	-13	PASS
	2437.2000	-54.3905	-13	PASS
	2843.4000	-53.7393	-13	PASS
	3249.6000	-51.9789	-13	PASS
	3655.8000	-53.1231	-13	PASS
4062.0000	-52.8171	-13	PASS	

**Analog: 450.025 MHz, 25.0kHz Channel Spacing, Max Power  
 RSS 119**

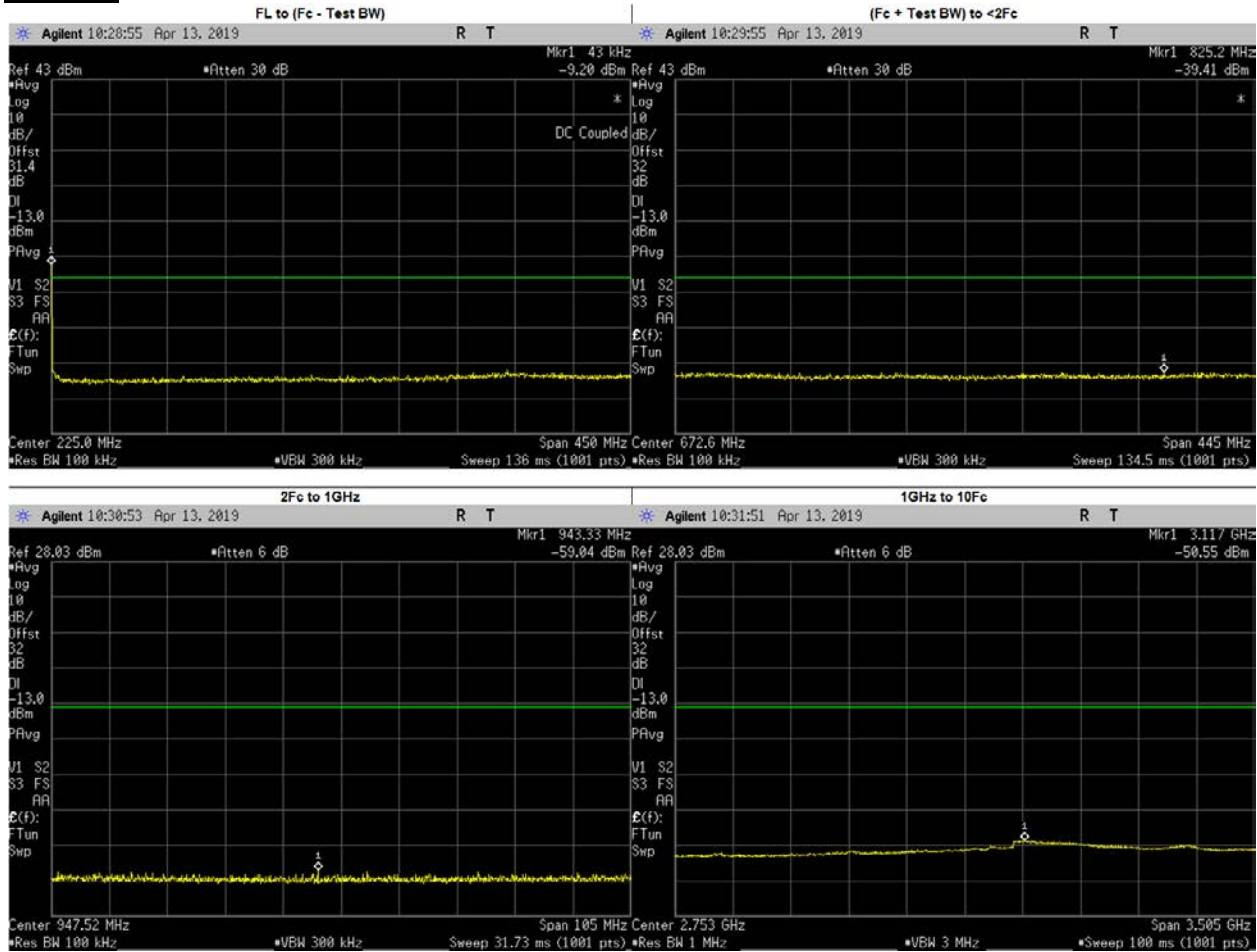

Frequency Range	Highest Spur Frequency (MHz)	Spurious Level (dBm)	Failing Limit (dBm)	Results
FL to (Fc - Test BW)	354.1269	-39.0000	-13	PASS
(Fc + Test BW) to <2Fc	825.1900	-39.4100	-13	PASS
2Fc to 1GHz	943.3270	-59.0400	-13	PASS
1GHz to 10Fc	3117.1710	-50.5500	-13	PASS
	1350.0750	-54.8736	-13	PASS
	1800.1000	-54.5108	-13	PASS
	2250.1250	-54.0776	-13	PASS
	2700.1500	-53.4751	-13	PASS
	3150.1750	-51.1916	-13	PASS
	3600.2000	-52.2151	-13	PASS
	4050.2250	-52.2221	-13	PASS
	4500.2500	-53.2482	-13	PASS

**Analog: 450.025 MHz, 25.0kHz Channel Spacing, Low Power  
 RSS 119**

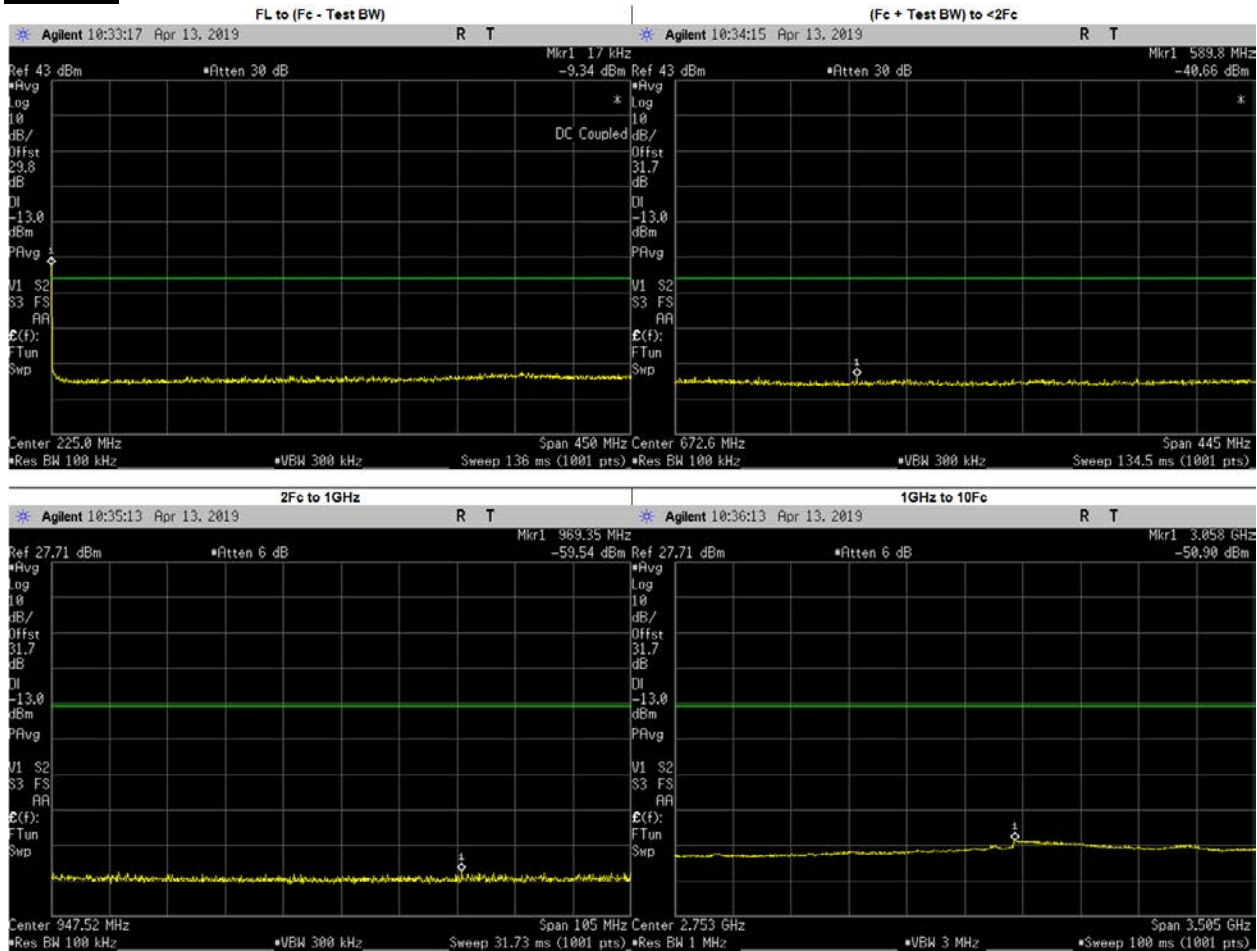

Frequency Range	Highest Spur Frequency (MHz)	Spurious Level (dBm)	Failing Limit (dBm)	Results
FL to (Fc - Test BW)	364.9259	-39.2800	-13	PASS
(Fc + Test BW) to <2Fc	589.8018	-40.6600	-13	PASS
2Fc to 1GHz	969.3546	-59.5400	-13	PASS
1GHz to 10Fc	3057.5820	-50.9000	-13	PASS
	1350.0750	-55.1778	-13	PASS
	1800.1000	-54.7824	-13	PASS
	2250.1250	-54.4360	-13	PASS
	2700.1500	-53.6122	-13	PASS
	3150.1750	-51.3250	-13	PASS
	3600.2000	-52.5030	-13	PASS
	4050.2250	-52.3576	-13	PASS
4500.2500	-53.2745	-13	PASS	

**Analog: 459.125 MHz, 25.0kHz Channel Spacing, Max Power  
 Part 22, RSS 119**

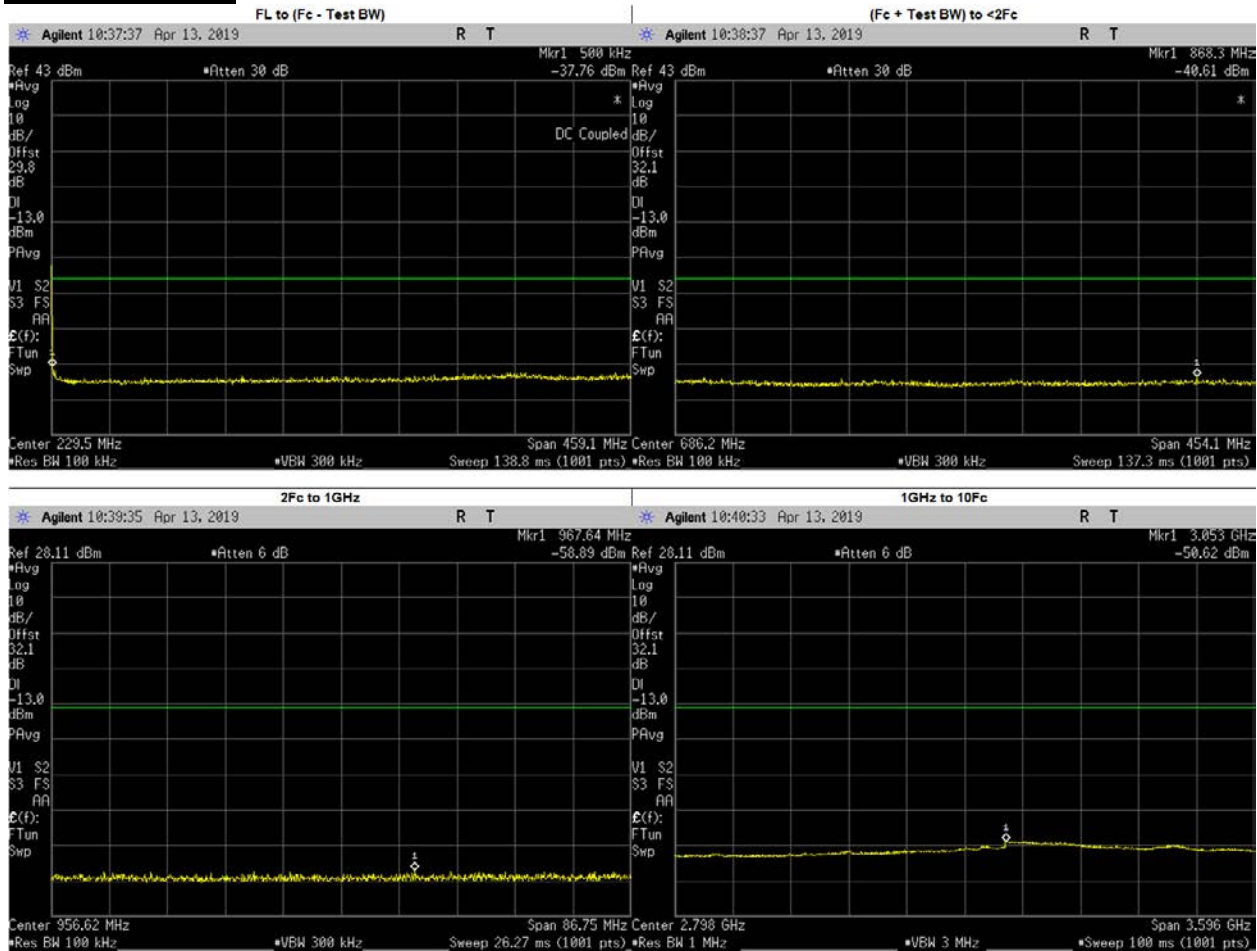

Frequency Range	Highest Spur Frequency (MHz)	Spurious Level (dBm)	Failing Limit (dBm)	Results
FL to (Fc - Test BW)	361.2886	-39.3800	-13	PASS
(Fc + Test BW) to <2Fc	868.2972	-40.6100	-13	PASS
2Fc to 1GHz	967.6422	-58.8900	-13	PASS
1GHz to 10Fc	3053.4590	-50.6200	-13	PASS
	1377.3750	-54.6131	-13	PASS
	1836.5000	-54.3743	-13	PASS
	2295.6250	-53.9695	-13	PASS
	2754.7500	-53.2934	-13	PASS
	3213.8750	-50.9723	-13	PASS
	3673.0000	-52.2669	-13	PASS
	4132.1250	-52.1671	-13	PASS
	4591.2500	-53.5165	-13	PASS



**Analog: 467.775 MHz, 25.0kHz Channel Spacing, Max Power  
 RSS 119**

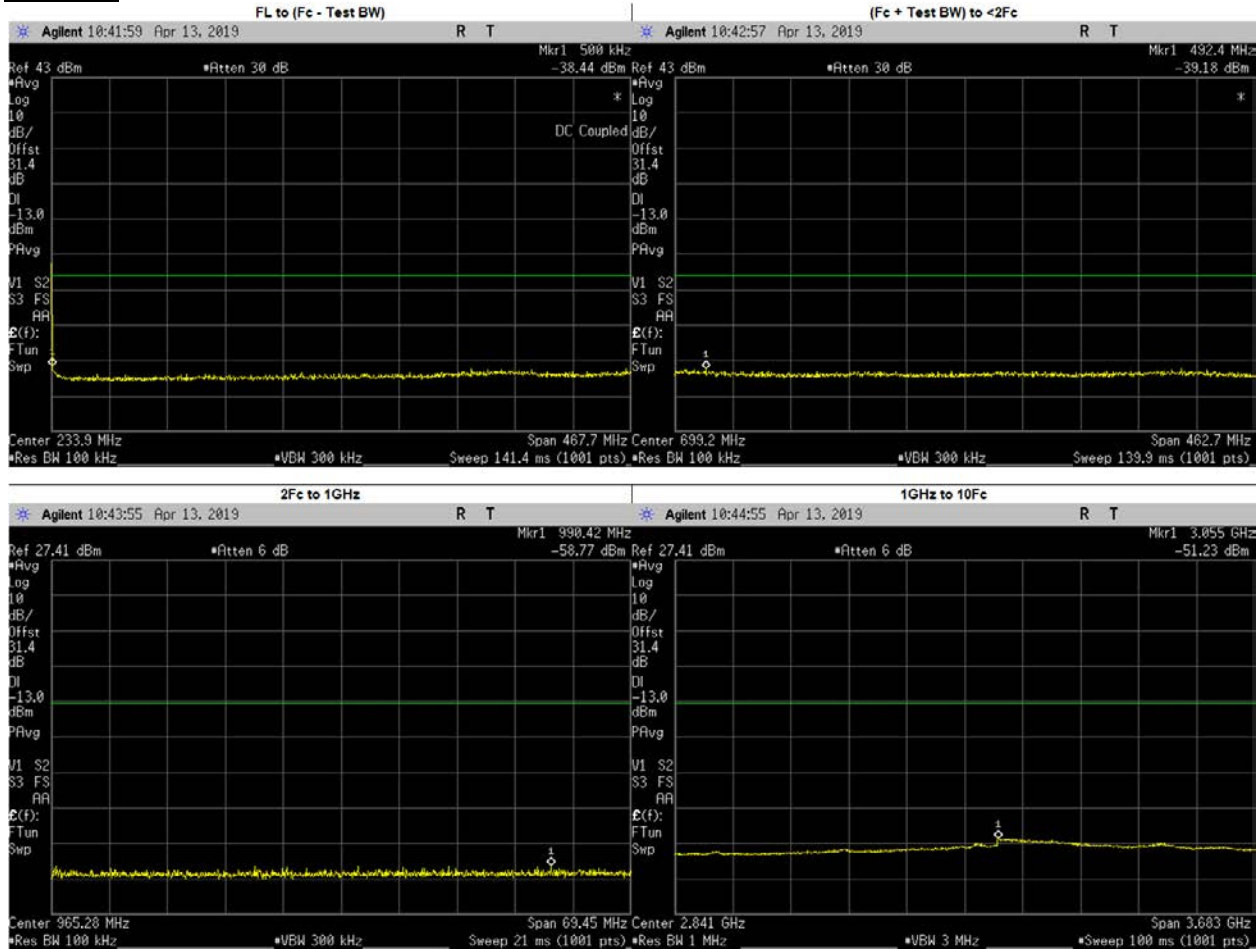

Frequency Range	Highest Spur Frequency (MHz)	Spurious Level (dBm)	Failing Limit (dBm)	Results
FL to (Fc - Test BW)	463.5088	-39.1600	-13	PASS
(Fc + Test BW) to <2Fc	492.3559	-39.1800	-13	PASS
2Fc to 1GHz	990.4159	-58.7700	-13	PASS
1GHz to 10Fc	3054.9740	-51.2300	-13	PASS
	1403.3250	-55.5824	-13	PASS
	1871.1000	-54.9953	-13	PASS
	2338.8750	-54.4443	-13	PASS
	2806.6500	-53.4938	-13	PASS
	3274.4250	-52.1846	-13	PASS
	3742.2000	-53.0642	-13	PASS
	4209.9750	-53.4915	-13	PASS
	4677.7500	-54.2319	-13	PASS

**Analog: 467.775 MHz, 25.0kHz Channel Spacing, Low Power  
 RSS 119**

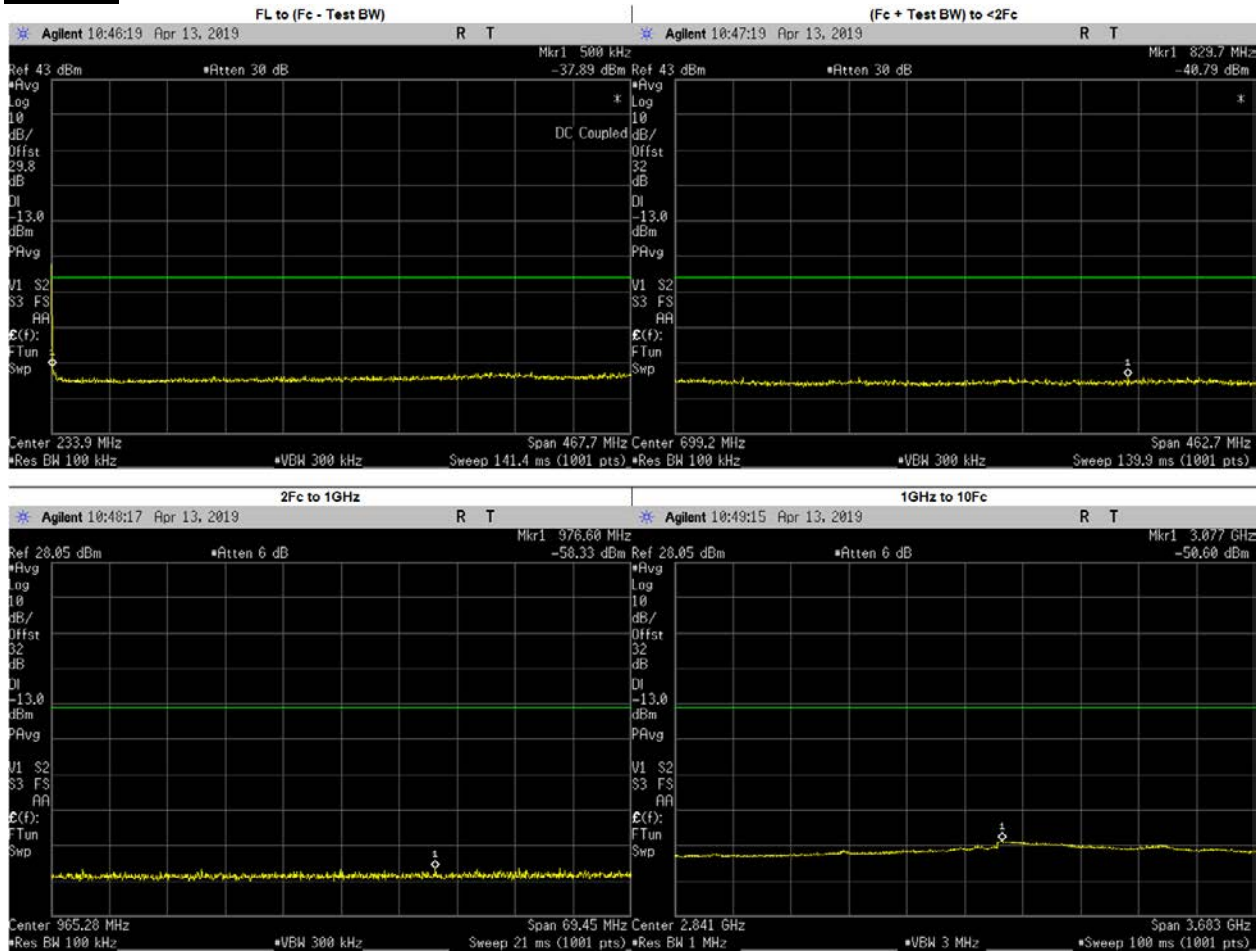

Frequency Range	Highest Spur Frequency (MHz)	Spurious Level (dBm)	Failing Limit (dBm)	Results
FL to (Fc - Test BW)	387.2722	-39.6200	-13	PASS
(Fc + Test BW) to <2Fc	829.6774	-40.7900	-13	PASS
2Fc to 1GHz	976.5954	-58.3300	-13	PASS
1GHz to 10Fc	3077.0710	-50.6000	-13	PASS
	1403.3250	-54.6834	-13	PASS
	1871.1000	-54.5159	-13	PASS
	2338.8750	-54.0477	-13	PASS
	2806.6500	-52.8516	-13	PASS
	3274.4250	-51.4883	-13	PASS
	3742.2000	-52.5301	-13	PASS
	4209.9750	-53.0280	-13	PASS
	4677.7500	-53.7487	-13	PASS

**Analog: 479.9875 MHz, 25.0kHz Channel Spacing, Max Power  
 RSS 119**

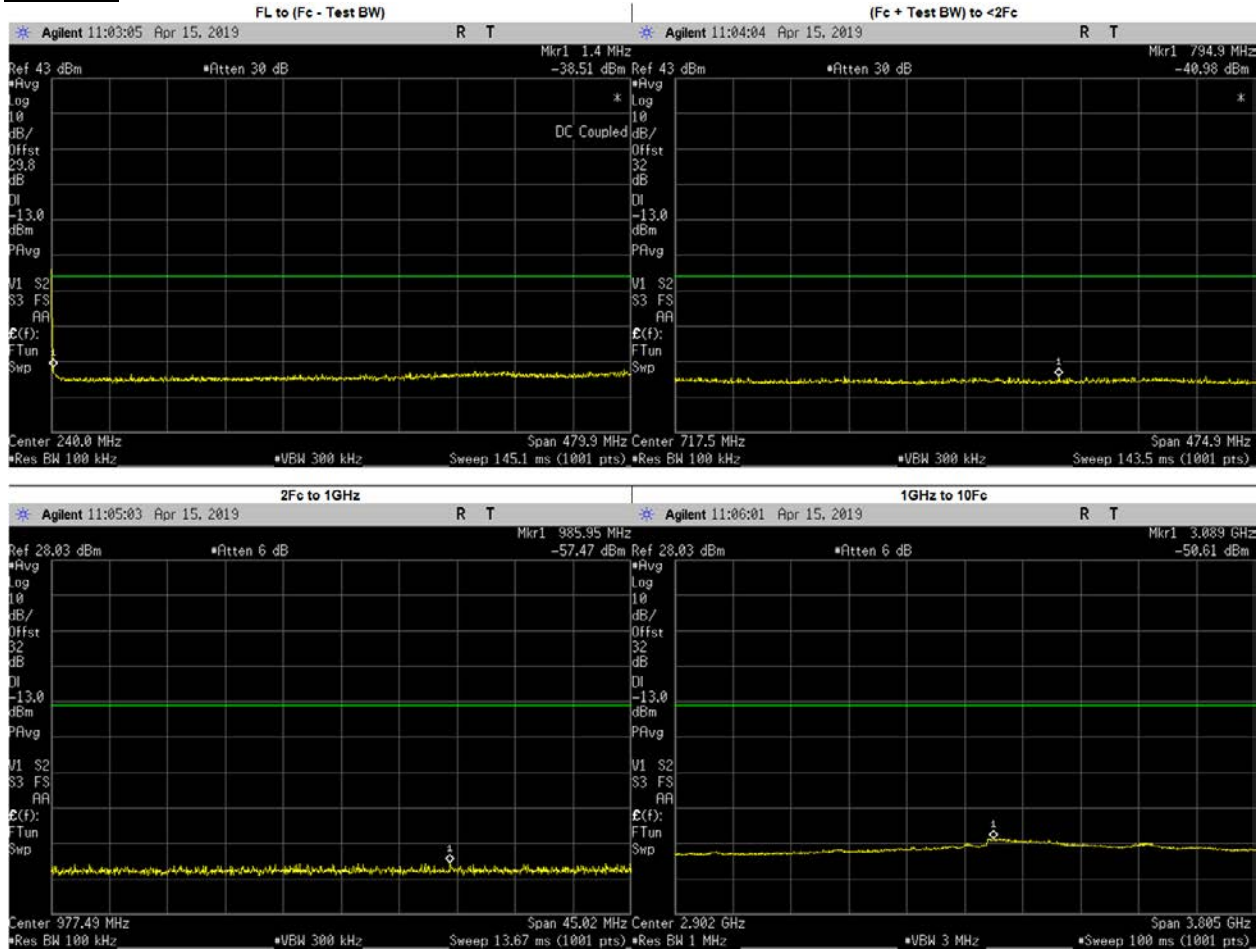

Frequency Range	Highest Spur Frequency (MHz)	Spurious Level (dBm)	Failing Limit (dBm)	Results
FL to (Fc - Test BW)	474.6516	-39.1700	-13	PASS
(Fc + Test BW) to <2Fc	794.9234	-40.9800	-13	PASS
2Fc to 1GHz	985.9522	-57.4700	-13	PASS
1GHz to 10Fc	3088.8760	-50.6100	-13	PASS
	1439.9630	-54.8211	-13	PASS
	1919.9500	-54.5126	-13	PASS
	2399.9370	-53.6547	-13	PASS
	2879.9250	-52.9289	-13	PASS
	3359.9120	-51.6170	-13	PASS
	3839.9000	-52.9516	-13	PASS
	4319.8870	-53.3678	-13	PASS
	4799.8750	-53.8428	-13	PASS

**Analog: 479.9875 MHz, 25.0kHz Channel Spacing, Low Power  
 RSS 119**

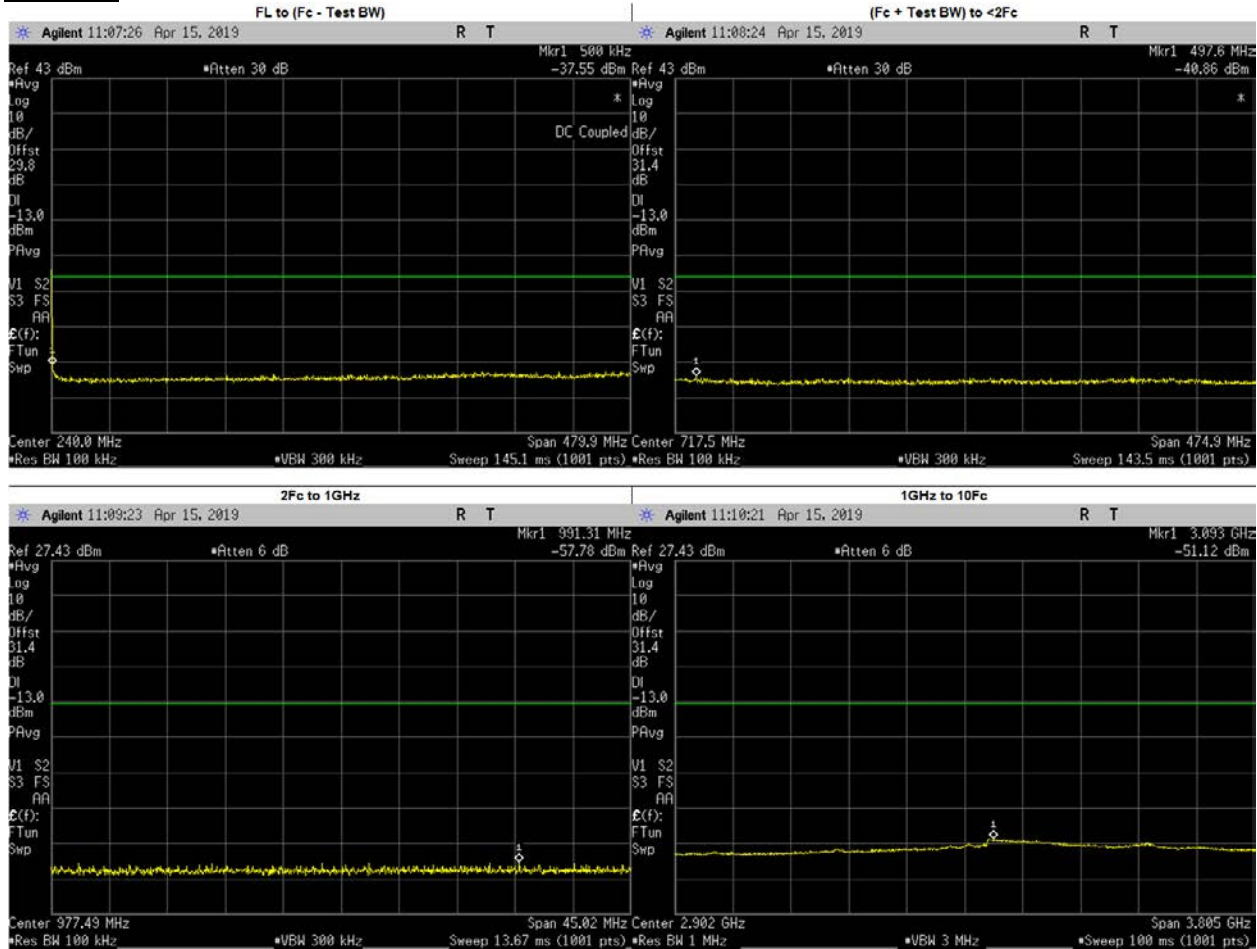

Frequency Range	Highest Spur Frequency (MHz)	Spurious Level (dBm)	Failing Limit (dBm)	Results
FL to (Fc - Test BW)	472.2520	-39.7100	-13	PASS
(Fc + Test BW) to <2Fc	497.6167	-40.8600	-13	PASS
2Fc to 1GHz	991.3102	-57.7800	-13	PASS
1GHz to 10Fc	3092.6810	-51.1200	-13	PASS
	1439.9630	-55.6724	-13	PASS
	1919.9500	-55.1069	-13	PASS
	2399.9370	-54.3771	-13	PASS
	2879.9250	-53.6669	-13	PASS
	3359.9120	-51.9144	-13	PASS
	3839.9000	-53.4943	-13	PASS
	4319.8870	-53.9671	-13	PASS
	4799.8750	-54.2333	-13	PASS

**6.10.3. Test Result (Digital)**

**Digital: 403.0125 MHz, 12.5kHz Channel Spacing, Max Power  
 FCC Part 90, RSS 119**

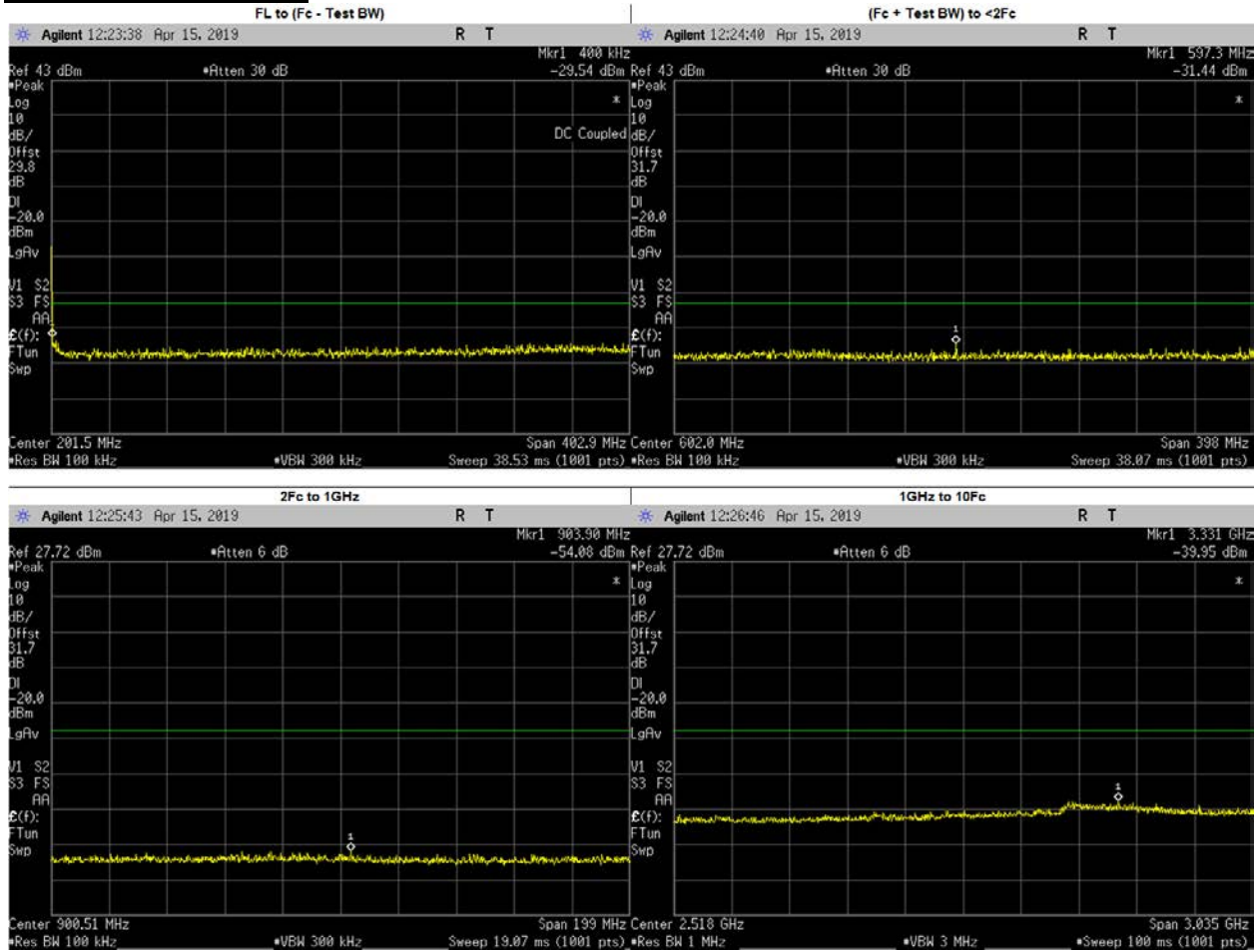

Frequency Range	Highest Spur Frequency (MHz)	Spurious Level (dBm)	Failing Limit (dBm)	Results
FL to (Fc - Test BW)	398.1215	-29.8470	-20	PASS
(Fc + Test BW) to <2Fc	597.2711	-31.4400	-20	PASS
2Fc to 1GHz	903.8951	-54.0800	-20	PASS
1GHz to 10Fc	1209.0370	-45.8119	-20	PASS
	1612.0500	-45.3779	-20	PASS
	2015.0620	-45.4004	-20	PASS
	2418.0750	-44.4833	-20	PASS
	2821.0880	-43.3610	-20	PASS
	3224.1000	-41.9757	-20	PASS
	3627.1130	-42.6710	-20	PASS
	4030.1250	-42.7747	-20	PASS
	3330.9760	-39.9500	-20	PASS

**Digital: 403.0125 MHz, 12.5kHz Channel Spacing, Low Power  
 FCC Part 90, RSS 119**

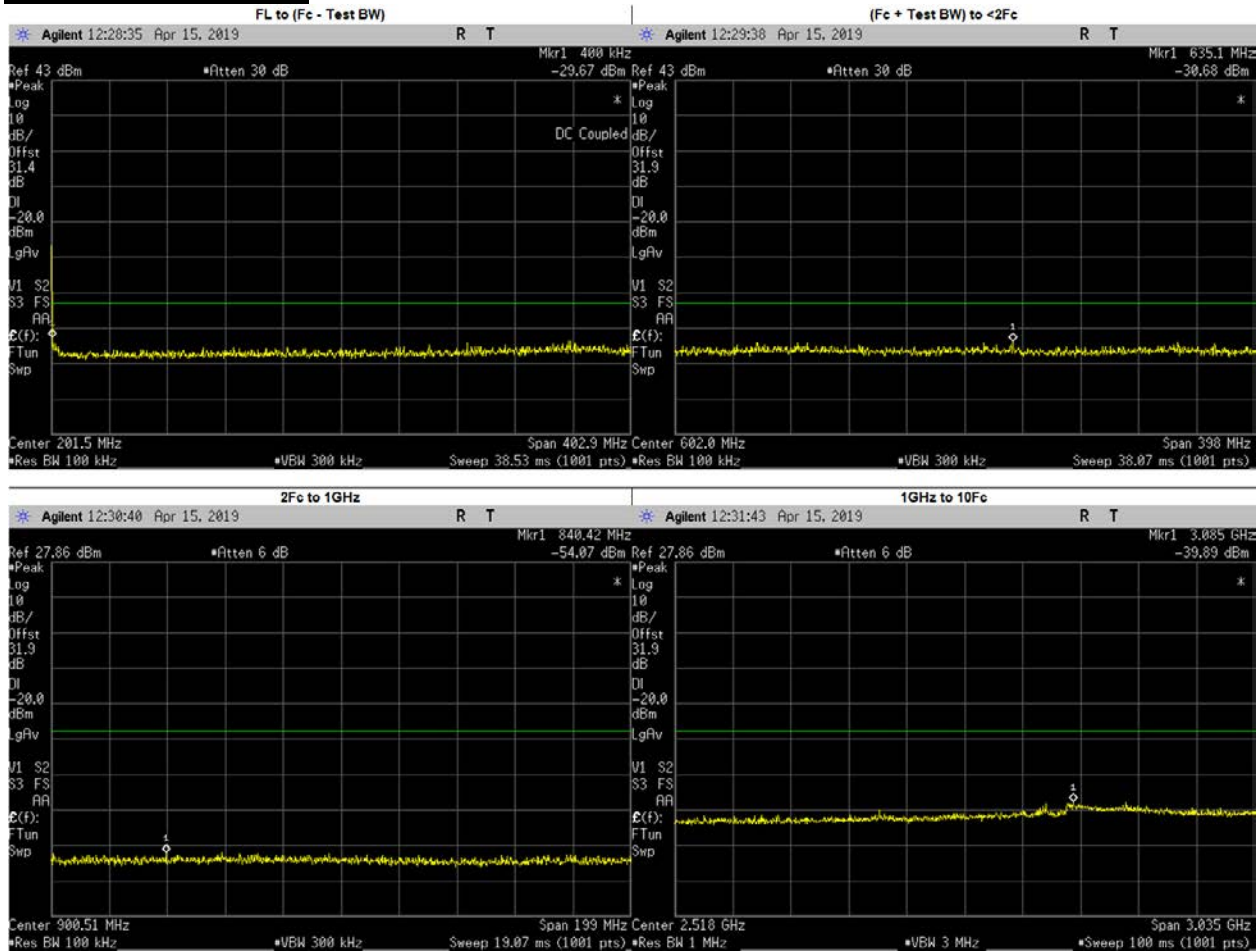

Frequency Range	Highest Spur Frequency (MHz)	Spurious Level (dBm)	Failing Limit (dBm)	Results
FL to (Fc - Test BW)	359.8415	-30.7998	-20	PASS
(Fc + Test BW) to <2Fc	635.0770	-30.6800	-20	PASS
2Fc to 1GHz	840.4221	-54.0700	-20	PASS
1GHz to 10Fc	1209.0370	-44.9684	-20	PASS
	1612.0500	-45.3414	-20	PASS
	2015.0620	-45.0035	-20	PASS
	2418.0750	-43.8671	-20	PASS
	2821.0880	-42.3219	-20	PASS
	3224.1000	-42.0378	-20	PASS
	3627.1130	-42.9868	-20	PASS
	4030.1250	-42.9617	-20	PASS
	3085.1310	-39.8900	-20	PASS

**Digital: 406.2 MHz, 12.5kHz Channel Spacing, High Power  
 FCC Part 90, RSS 119**

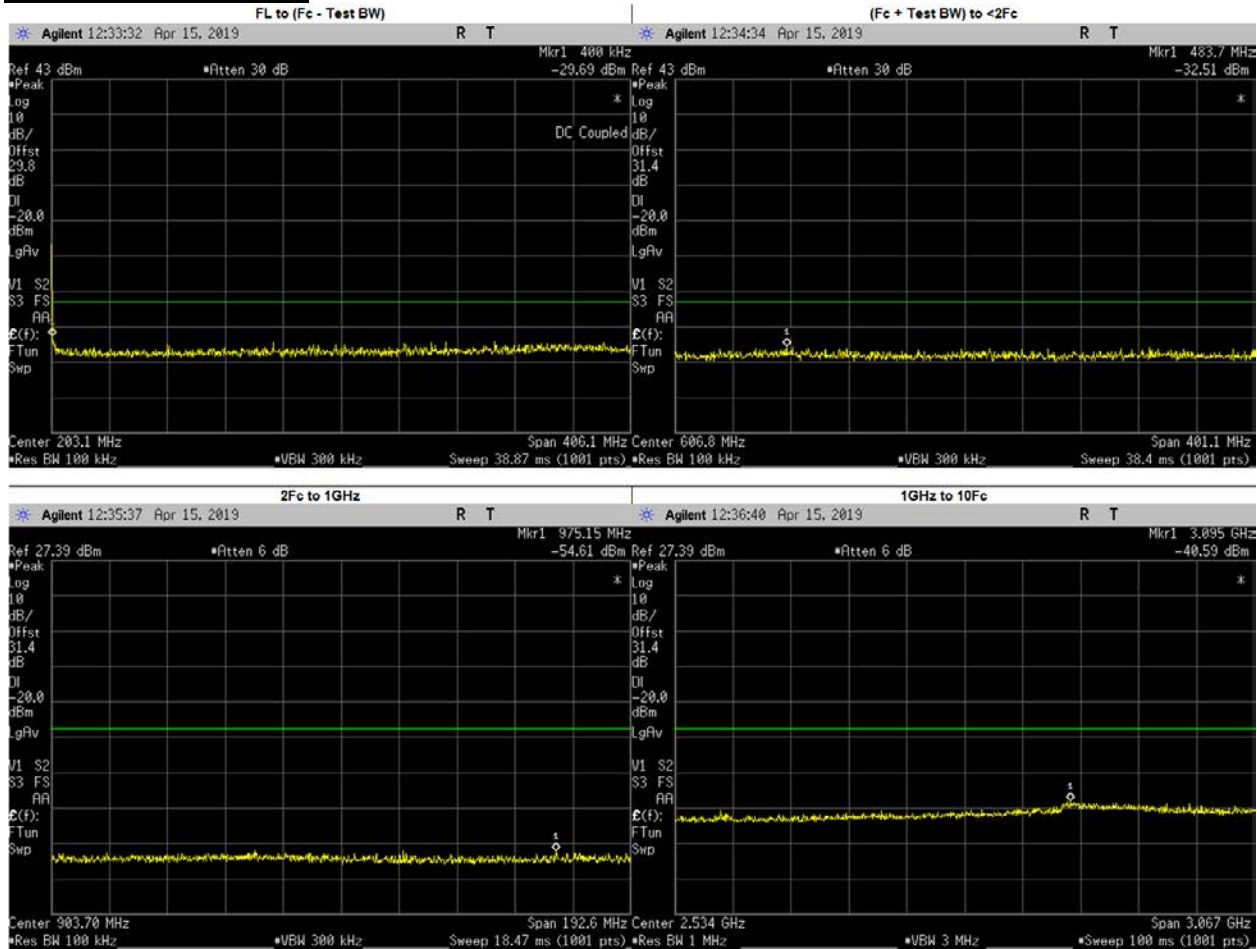

Frequency Range	Highest Spur Frequency (MHz)	Spurious Level (dBm)	Failing Limit (dBm)	Results
FL to (Fc - Test BW)	387.0560	-29.7451	-20	PASS
(Fc + Test BW) to <2Fc	483.6765	-32.5100	-20	PASS
2Fc to 1GHz	975.1546	-54.6100	-20	PASS
1GHz to 10Fc	3094.7610	-40.5900	-20	PASS
	3079.4260	-40.8400	-20	PASS
	1218.6000	-46.0226	-20	PASS
	1624.8000	-46.2352	-20	PASS
	2031.0000	-45.1734	-20	PASS
	2437.2000	-44.3252	-20	PASS
	2843.4000	-43.5720	-20	PASS
	3249.6000	-42.4186	-20	PASS
	3655.8000	-42.6309	-20	PASS

**Digital: 450.025 MHz, 12.5kHz Channel Spacing, High Power  
 FCC Part 90, RSS 119**

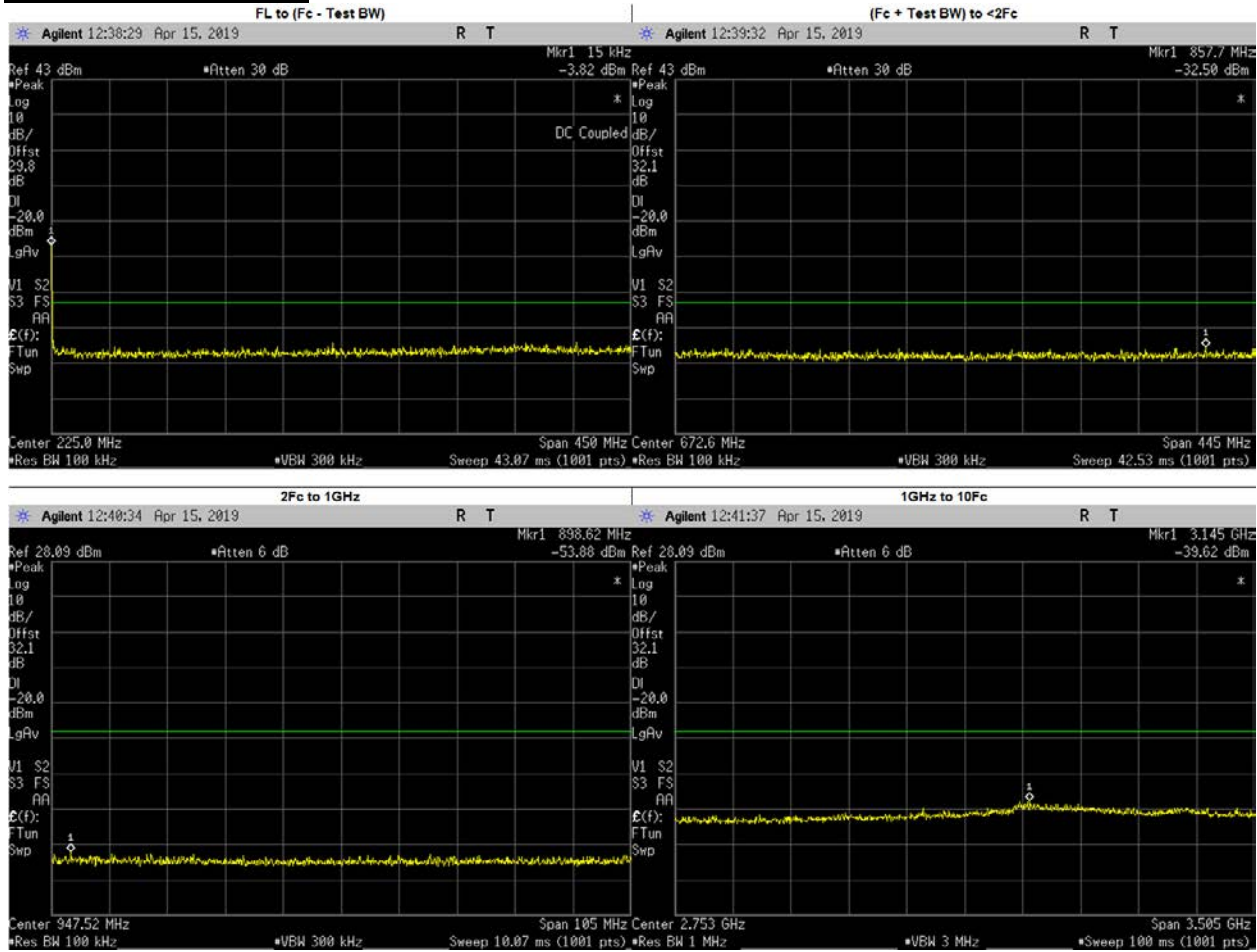

Frequency Range	Highest Spur Frequency (MHz)	Spurious Level (dBm)	Failing Limit (dBm)	Results
FL to (Fc - Test BW)	407.6720	-29.5503	-20	PASS
(Fc + Test BW) to <2Fc	857.6727	-32.5000	-20	PASS
2Fc to 1GHz	898.6183	-53.8800	-20	PASS
1GHz to 10Fc	1350.0750	-45.5664	-20	PASS
	1800.1000	-45.2187	-20	PASS
	2250.1250	-44.0852	-20	PASS
	2700.1500	-43.6383	-20	PASS
	3150.1750	-40.6330	-20	PASS
	3600.2000	-43.1556	-20	PASS
	4050.2250	-42.7457	-20	PASS
	4500.2500	-43.9835	-20	PASS
	3145.2130	-39.6200	-20	PASS



**Digital: 450.025 MHz, 12.5kHz Channel Spacing, Low Power  
 FCC Part 90, RSS 119**

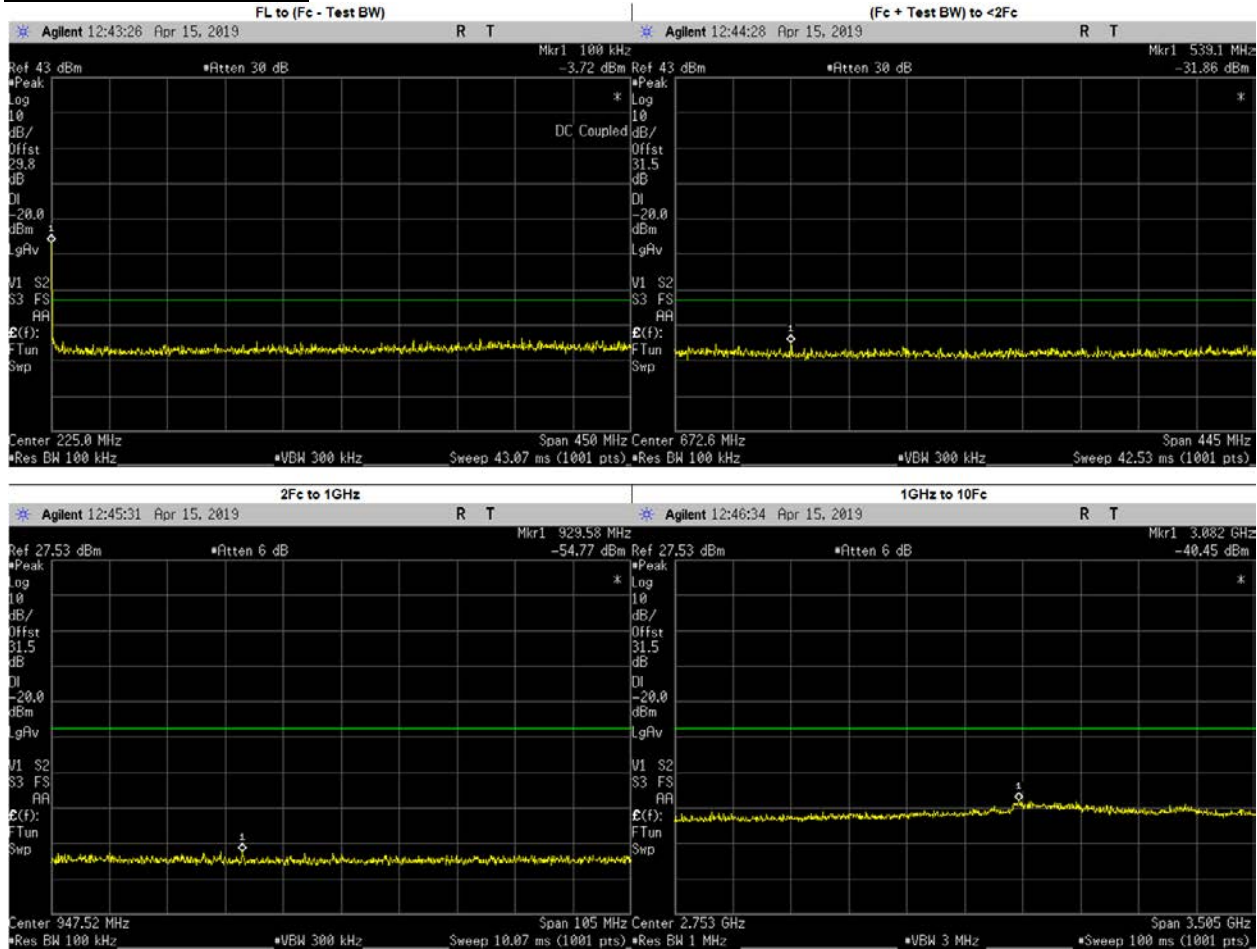

Frequency Range	Highest Spur Frequency (MHz)	Spurious Level (dBm)	Failing Limit (dBm)	Results
FL to (Fc - Test BW)	365.3759	-29.2445	-20	PASS
(Fc + Test BW) to <2Fc	539.0754	-31.8600	-20	PASS
2Fc to 1GHz	929.5785	-54.7700	-20	PASS
1GHz to 10Fc	3082.1190	-40.4500	-20	PASS
	1350.0750	-45.1060	-20	PASS
	1800.1000	-45.3066	-20	PASS
	2250.1250	-45.1014	-20	PASS
	2700.1500	-44.4519	-20	PASS
	3150.1750	-41.9067	-20	PASS
	3600.2000	-43.4819	-20	PASS
	4050.2250	-42.2141	-20	PASS
4500.2500	-44.1423	-20	PASS	

**Digital: 459.125 MHz, 12.5kHz Channel Spacing, Max Power  
 FCC Part 90, RSS 119**

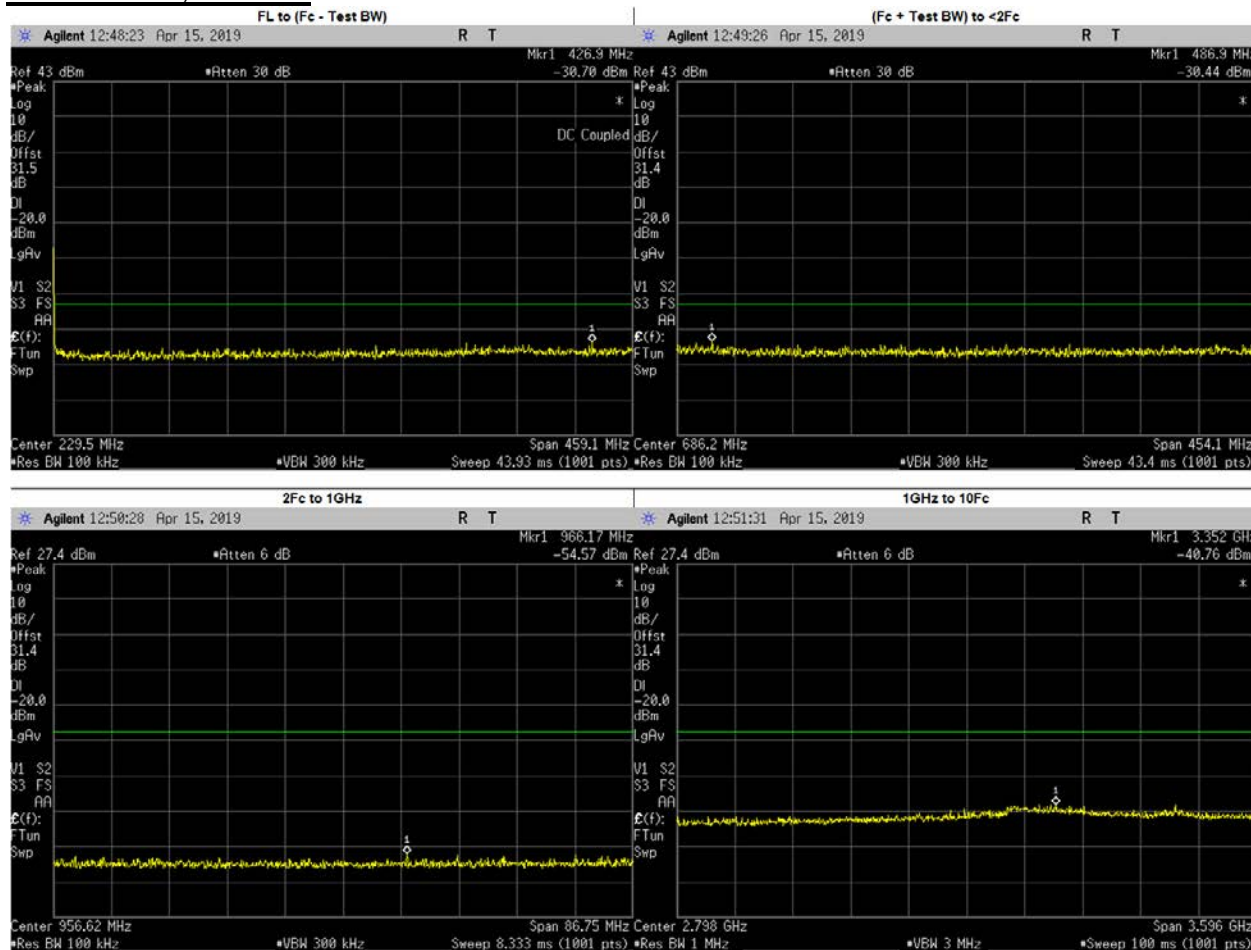

Frequency Range	Highest Spur Frequency (MHz)	Spurious Level (dBm)	Failing Limit (dBm)	Results
FL to (Fc - Test BW)	426.9341	-30.8966	-20	PASS
(Fc + Test BW) to <2Fc	486.8800	-30.4400	-20	PASS
2Fc to 1GHz	966.1675	-54.5700	-20	PASS
1GHz to 10Fc	3351.9480	-40.7600	-20	PASS
	1377.3750	-46.0445	-20	PASS
	1836.5000	-45.3627	-20	PASS
	2295.6250	-44.6449	-20	PASS
	2754.7500	-44.3552	-20	PASS
	3213.8750	-42.1729	-20	PASS
	3673.0000	-42.8473	-20	PASS
	4132.1250	-42.0889	-20	PASS
4591.2500	-44.6076	-20	PASS	

**Digital: 467.775 MHz, 12.5kHz Channel Spacing, Max Power  
 FCC Part 90, RSS 119**

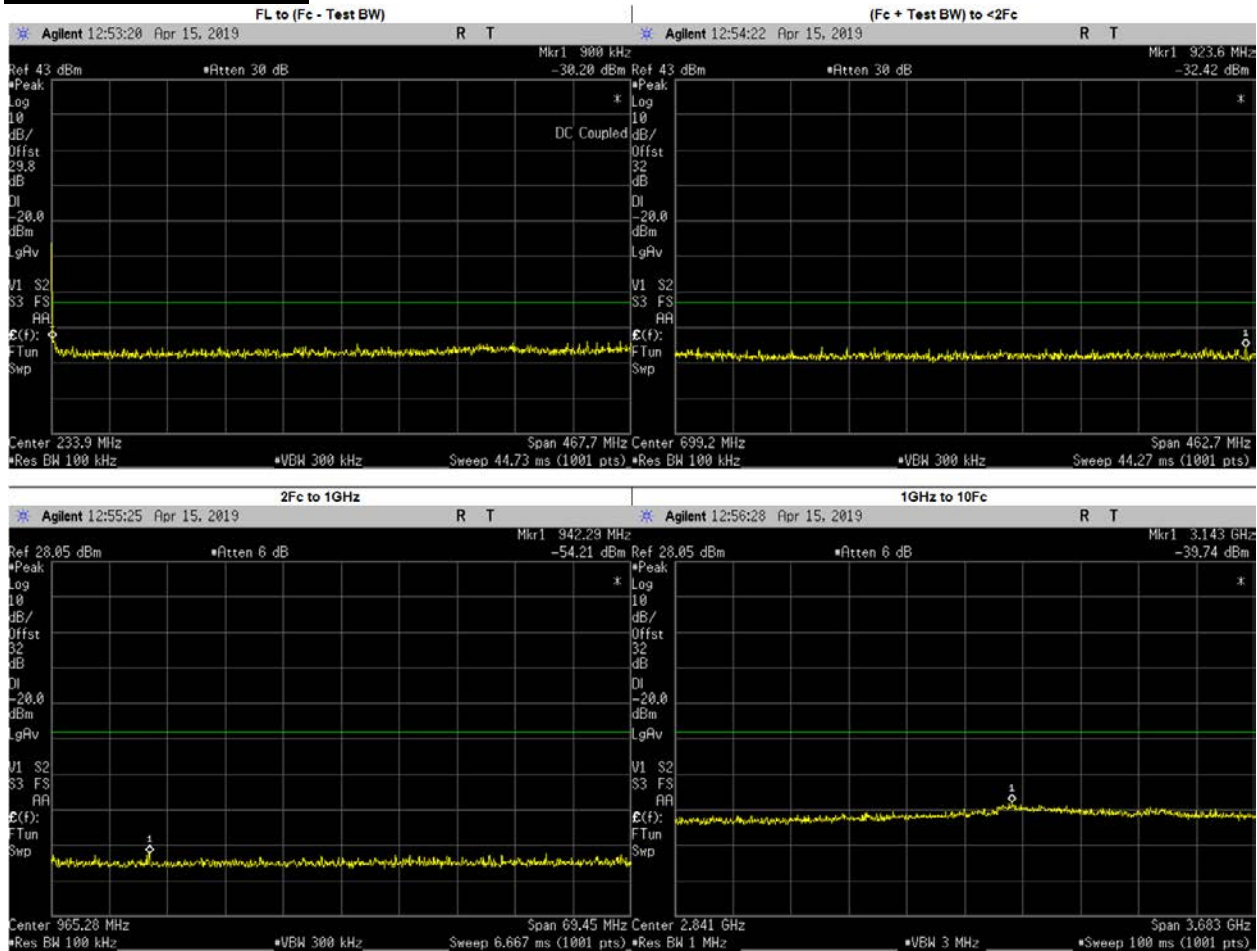

Frequency Range	Highest Spur Frequency (MHz)	Spurious Level (dBm)	Failing Limit (dBm)	Results
FL to (Fc - Test BW)	432.6400	-29.2840	-20	PASS
(Fc + Test BW) to <2Fc	923.6092	-32.4200	-20	PASS
2Fc to 1GHz	942.2871	-54.2100	-20	PASS
1GHz to 10Fc	1403.3250	-44.0870	-20	PASS
	1871.1000	-44.9179	-20	PASS
	2338.8750	-44.2138	-20	PASS
	2806.6500	-42.9254	-20	PASS
	3274.4250	-41.4028	-20	PASS
	3742.2000	-42.3515	-20	PASS
	4209.9750	-43.1009	-20	PASS
	4677.7500	-43.9088	-20	PASS
	3143.3600	-39.7400	-20	PASS

**Digital: 467.775 MHz, 12.5kHz Channel Spacing, Low Power  
 FCC Part 90, RSS 119**

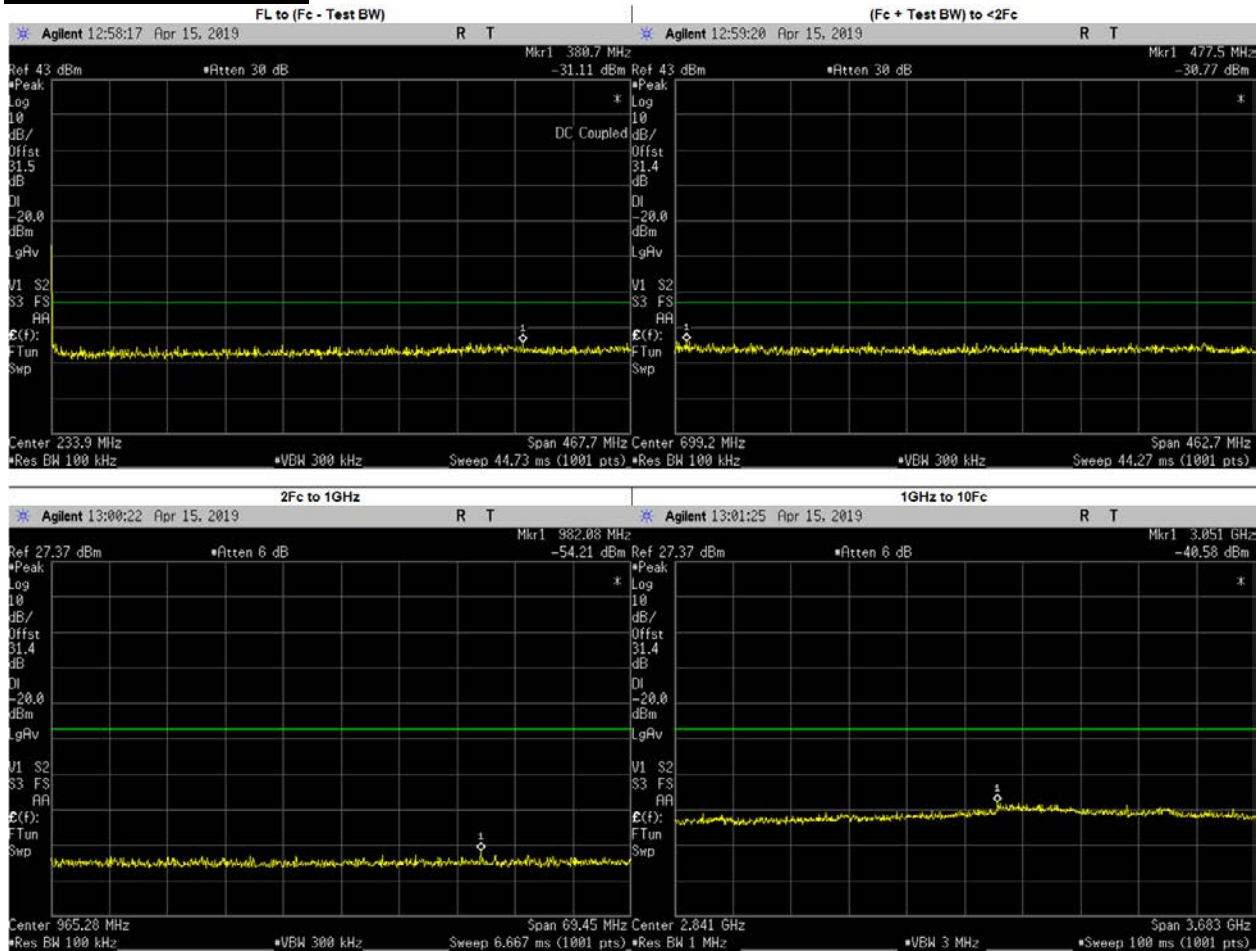

Frequency Range	Highest Spur Frequency (MHz)	Spurious Level (dBm)	Failing Limit (dBm)	Results
FL to (Fc - Test BW)	380.7243	-31.2709	-20	PASS
(Fc + Test BW) to <2Fc	477.5489	-30.7700	-20	PASS
2Fc to 1GHz	982.0819	-54.2100	-20	PASS
1GHz to 10Fc	3051.2920	-40.5800	-20	PASS
	1403.3250	-45.1074	-20	PASS
	1871.1000	-45.5435	-20	PASS
	2338.8750	-45.1768	-20	PASS
	2806.6500	-44.1977	-20	PASS
	3274.4250	-42.5098	-20	PASS
	3742.2000	-43.0780	-20	PASS
	4209.9750	-43.8778	-20	PASS
	4677.7500	-44.8724	-20	PASS

**Digital: 479.9875 MHz, 12.5kHz Channel Spacing, Max Power  
 FCC Part 90, RSS 119**

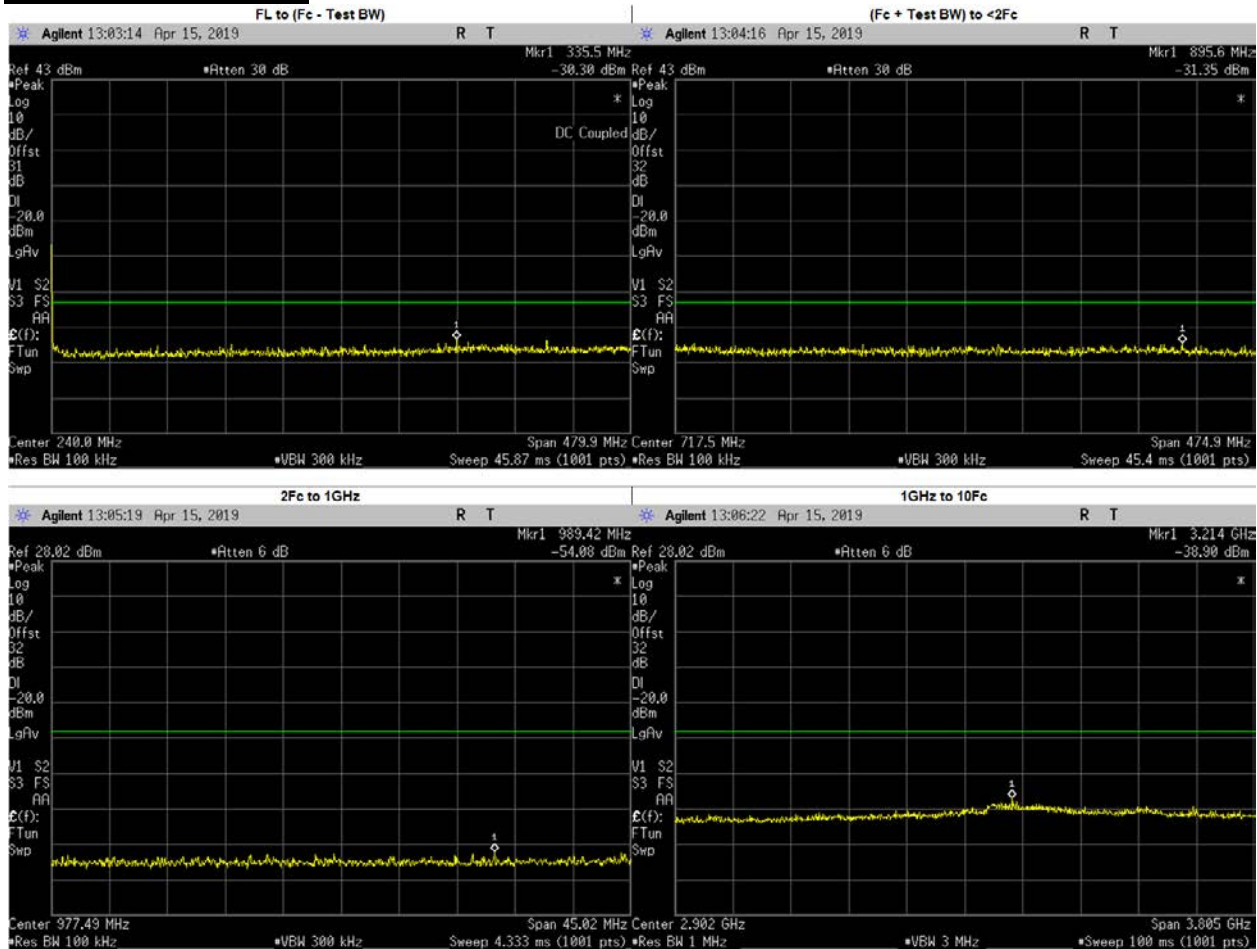

Frequency Range	Highest Spur Frequency (MHz)	Spurious Level (dBm)	Failing Limit (dBm)	Results
FL to (Fc - Test BW)	335.4743	-30.4903	-20	PASS
(Fc + Test BW) to <2Fc	895.6087	-31.3500	-20	PASS
2Fc to 1GHz	989.4191	-54.0800	-20	PASS
1GHz to 10Fc	1439.9630	-45.3547	-20	PASS
	1919.9500	-44.1013	-20	PASS
	2399.9370	-43.4630	-20	PASS
	2879.9250	-43.2389	-20	PASS
	3359.9120	-41.6813	-20	PASS
	3839.9000	-43.1764	-20	PASS
	4319.8870	-43.2516	-20	PASS
	4799.8750	-44.0936	-20	PASS
	3214.4370	-38.9000	-20	PASS

**Digital: 479.9875 MHz, 12.5kHz Channel Spacing, Low Power  
 FCC Part 90, RSS 119**

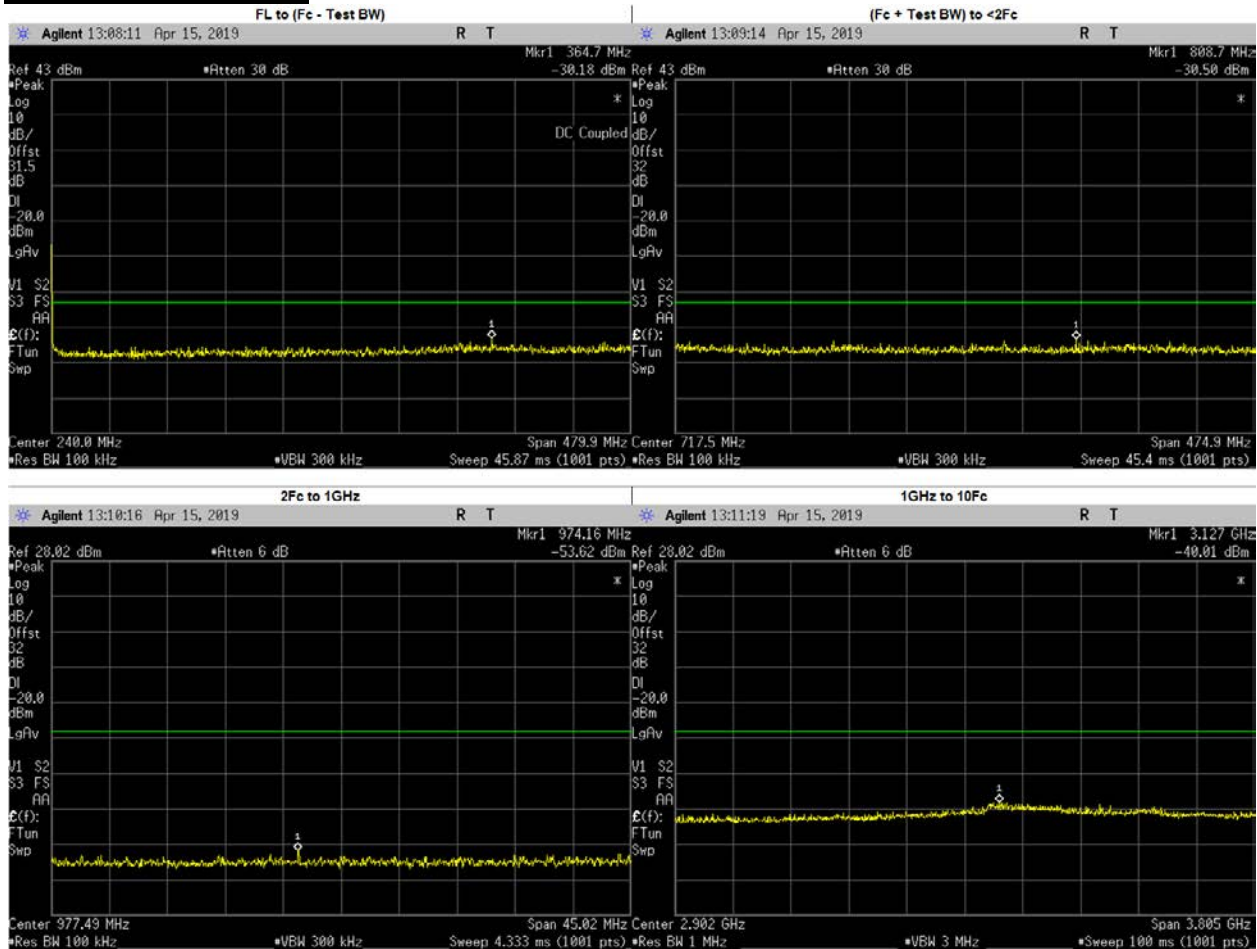

Frequency Range	Highest Spur Frequency (MHz)	Spurious Level (dBm)	Failing Limit (dBm)	Results
FL to (Fc - Test BW)	364.7495	-30.3778	-20	PASS
(Fc + Test BW) to <2Fc	808.6963	-30.5000	-20	PASS
2Fc to 1GHz	974.1557	-53.6200	-20	PASS
1GHz to 10Fc	3126.9250	-40.0100	-20	PASS
	1439.9630	-45.1231	-20	PASS
	1919.9500	-44.6288	-20	PASS
	2399.9370	-44.0174	-20	PASS
	2879.9250	-42.7114	-20	PASS
	3359.9120	-42.1187	-20	PASS
	3839.9000	-43.1289	-20	PASS
	4319.8870	-43.1242	-20	PASS
	4799.8750	-43.8365	-20	PASS

### 6.10.4. Test Limit

Table below summarized the power of any emission outside a licensee's frequency block shall be attenuated below the transmitter power (P) by at least

Channel Spacing	Part 22	Part 24D	Part 74	Part 80	Part 90 (UHF, VHF, 800, 900)	Part 90 (700)
12.5kHz	43 + log <sub>10</sub> (P) (-13 dBm)	43 + log <sub>10</sub> (P) (-13 dBm)	43 + log <sub>10</sub> (P) (-13 dBm)	Not Applicable	50 + log <sub>10</sub> (P) (-20 dBm)	43 + log <sub>10</sub> (P) (-13 dBm)
25kHz		Not Applicable		43 + log <sub>10</sub> (P) (-13 dBm)	43 + log <sub>10</sub> (P) (-13 dBm)	43 + log <sub>10</sub> (P) (-13 dBm)

Channel Spacing	RSS 134	RSS 182	RSS 119 (UHF, VHF, 800, 900)	RSS 119 (700)
12.5kHz	43 + log <sub>10</sub> (P) (-13 dBm)	Not Applicable	50 + log <sub>10</sub> (P) (-20 dBm)	43 + log <sub>10</sub> (P) (-13 dBm)
25kHz	Not Applicable	43 + log <sub>10</sub> (P) (-13 dBm)	43 + log <sub>10</sub> (P) (-13 dBm)	43 + log <sub>10</sub> (P) (-13 dBm)

## 6.11. Radiated Spurious Emission

### 6.11.1. Test Setup

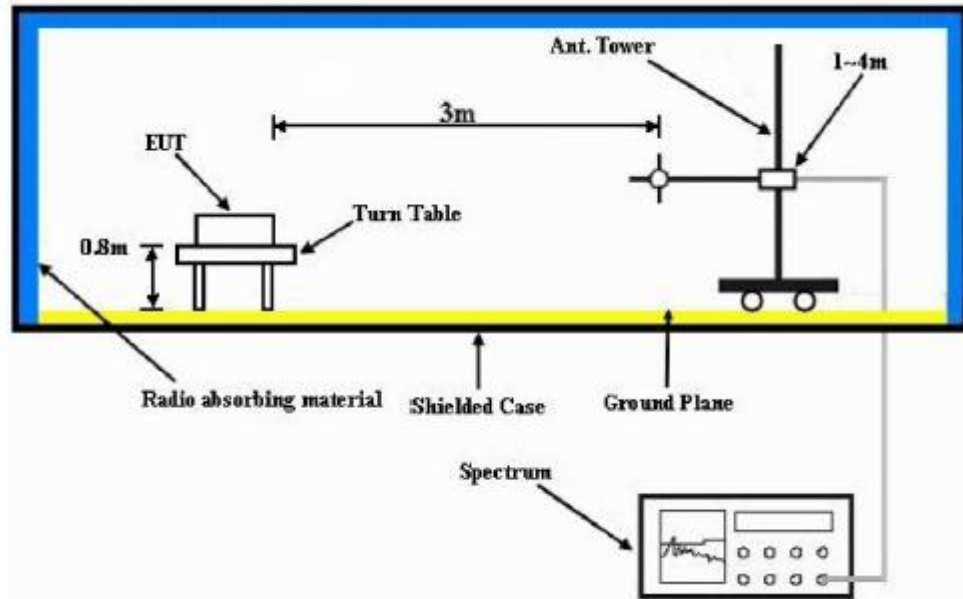

- 1) The Resolution Bandwidth for scanning Radiated Emission below 1 GHz is 100 kHz with Video Bandwidth = 300 kHz and Resolution Bandwidth for above 1 GHz is 1 MHz with Video Bandwidth = 3 MHz. Detector mode is positive peak.
- 2) In the semi- anechoic chamber, setup as illustrated above the DUT placed on the 0.8m height (for frequencies < 1GHz) or 1.5m (for frequencies > 1GHz) of Turn Table, rotated the table around 360 degrees to search the maximum radiation power and receiver antenna shall be rotated vertical and horizontal polarization and moved height from 1m to 4m to find the maximum polar radiated power. The “Read Value” is the spectrum reading the maximum power value.
- 3) The substitution antenna is substituted for DUT at the same position and signals generator (S.G) export the CW signal to the substitution antenna via a TX cable. The receiver antenna shall be rotated vertical and horizontal polarization and moved height from 1m to 4m to find the maximum radiation power. Record the power level of maximum radiation power from spectrum. So, the measured substitution value = Ref level of S.G + TX cables loss – Substituted Antenna Gain.
- 4) Final Radiated Spurious Emission = “Read Value” + Measured substitution value.



**6.11.1. Test Result (Analog)**

SAC Transmitter Radiated Emission:

Model Number: LAH87YDC9JA2AN

S/N: 278TVH0062

SR:09189-EMC-00019

Battery Part No: PMNN4476A

Accy Part No: NA

403.012500 MHz

Test Mode: TX Analog  
 25 kHz

1.000 Watt(s) /Low Power

Frequency (MHz)	Limit	Horizontal Measured Emission Equiv Pwr Into Ideal Dipole (dBm)	Vertical Measured Emission Equiv Pwr Into ideal Dipole (dBm)
806.0250	-13.0000	-81.1953 **	-82.8770 **
1209.0375	-13.0000	-61.6227 **	-60.7924 **
1612.0500	-13.0000	-60.0586 **	-58.5539 **
2015.0625	-13.0000	-56.5662 **	-56.5393 **
2418.0750	-13.0000	-55.6799 **	-57.0120 **
2821.0875	-13.0000	-54.4037 **	-55.2979 **
3224.1000	-13.0000	-51.9311 **	-52.6535 **
3627.1125	-13.0000	-54.6843 **	-53.6139 **
4030.1250	-13.0000	-51.3952 **	-50.5789 **

**RADIATED SPURIOUS EMISSIONS**

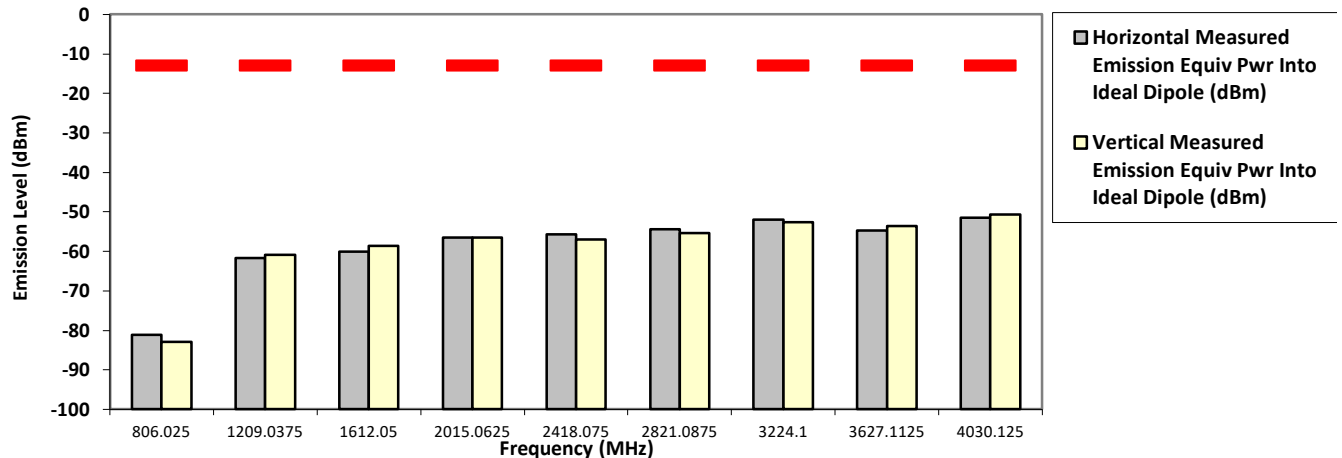

The data presented here was taken using the substitution method as found in the ANSI C63.26-2015 document.  
 Motorola Penang EMC Lab - Test Performed by: Azil & Qawiman Fri, Jul 05, 2019

Remarks: \*\* Indicates the spurious emission could not be detected due to noise limitations or ambient.

\*Pursuant to CFR 47 Part 2.1057 ( c ), emissions attenuated more than 20 dB below the permissible limit are not reported  
 Temp(Deg): 23.6 Hum(%RH): 70.2

System MU: 5.01 dB

Remarks:

Passed Results	Marginal Results	Failed Results
----------------	------------------	----------------

**SAC Transmitter Radiated Emission:**

**Model Number:** LAH87YDC9JA2AN

**S/N:** 278TVH0062

**SR:**09189-EMC-00019

**Battery Part No:** PMNN4476A

**Accy Part No:** NA

**403.012500 MHz**

**Test Mode:** TX Analog  
**25 kHz**

**4.800 Watt(s) /Max Power**

Frequency (MHz)	Limit	Horizontal Measured Emission Equiv Pwr Into Ideal Dipole (dBm)	Vertical Measured Emission Equiv Pwr Into ideal Dipole (dBm)
806.0250	-13.0000	-82.8265 **	-80.6171 **
1209.0375	-13.0000	-59.6770 **	-61.6918 **
1612.0500	-13.0000	-59.6371 **	-60.0356 **
2015.0625	-13.0000	-56.8876 **	-57.3833 **
2418.0750	-13.0000	-55.4134 **	-55.6597 **
2821.0875	-13.0000	-54.9257 **	-54.5076 **
3224.1000	-13.0000	-51.9472 **	-53.6038 **
3627.1125	-13.0000	-53.8132 **	-53.2197 **
4030.1250	-13.0000	-51.7015 **	-51.8291 **

**RADIATED SPURIOUS EMISSIONS**

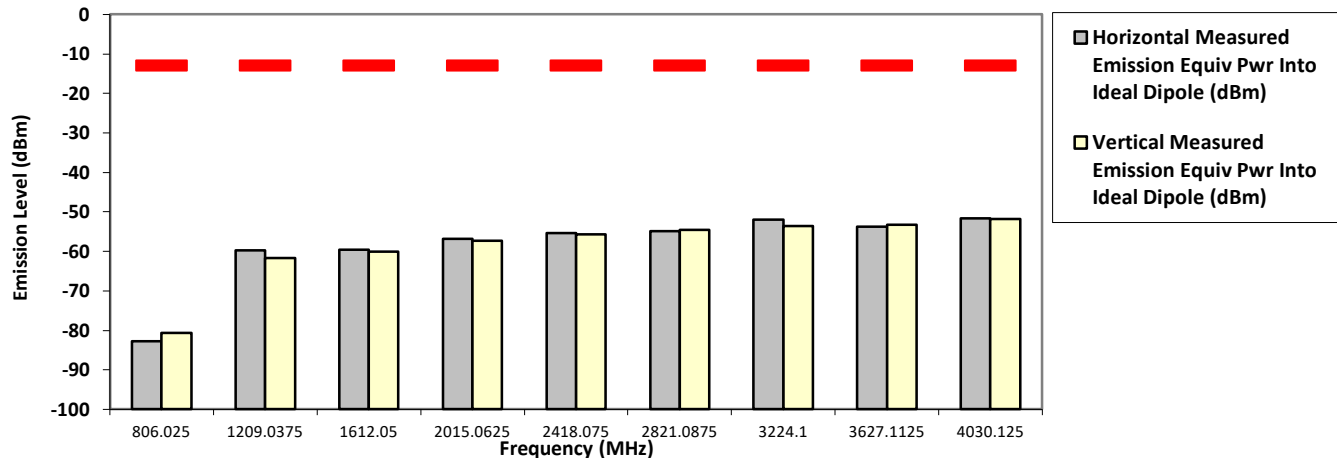

The data presented here was taken using the substitution method as found in the ANSI C63.26-2015 document.  
 Motorola Penang EMC Lab - Test Performed by: Azil & Qawiman  
 Fri, Jul 05, 2019

Remarks: \*\* Indicates the spurious emission could not be detected due to noise limitations or ambient.

\*Pursuant to CFR 47 Part 2.1057 ( c ), emissions attenuated more than 20 dB below the permissible limit are not reported  
 Temp(Deg): 23.6 Hum(%RH): 70.2

System MU: 5.01 dB

Remarks:	Passed Results	Marginal Results	Failed Results
----------	----------------	------------------	----------------

SAC Transmitter Radiated Emission:

Model Number: LAH87YDC9JA2AN      S/N: 278TVH0062      SR:09189-EMC-00019  
 Battery Part No: PMNN4476A  
 Test Mode: TX Analog      Accy Part No: NA  
 406.20000 MHz      25 kHz      1.000 Watt(s) /Low Power

Frequency (MHz)	Limit	Horizontal Measured Emission Equiv Pwr Into Ideal Dipole (dBm)	Vertical Measured Emission Equiv Pwr Into ideal Dipole (dBm)
812.4000	-13.0000	-82.7230 **	-82.8256 **
1218.6000	-13.0000	-61.3724 **	-62.1521 **
1624.8000	-13.0000	-59.0290 **	-58.8235 **
2031.0000	-13.0000	-56.4359 **	-57.8669 **
2437.2000	-13.0000	-56.0141 **	-56.5285 **
2843.4000	-13.0000	-55.8866 **	-54.6760 **
3249.6000	-13.0000	-50.6774 **	-53.2849 **
3655.8000	-13.0000	-52.5907 **	-52.9135 **
4062.0000	-13.0000	-51.1394 **	-51.1442 **

RADIATED SPURIOUS EMISSIONS

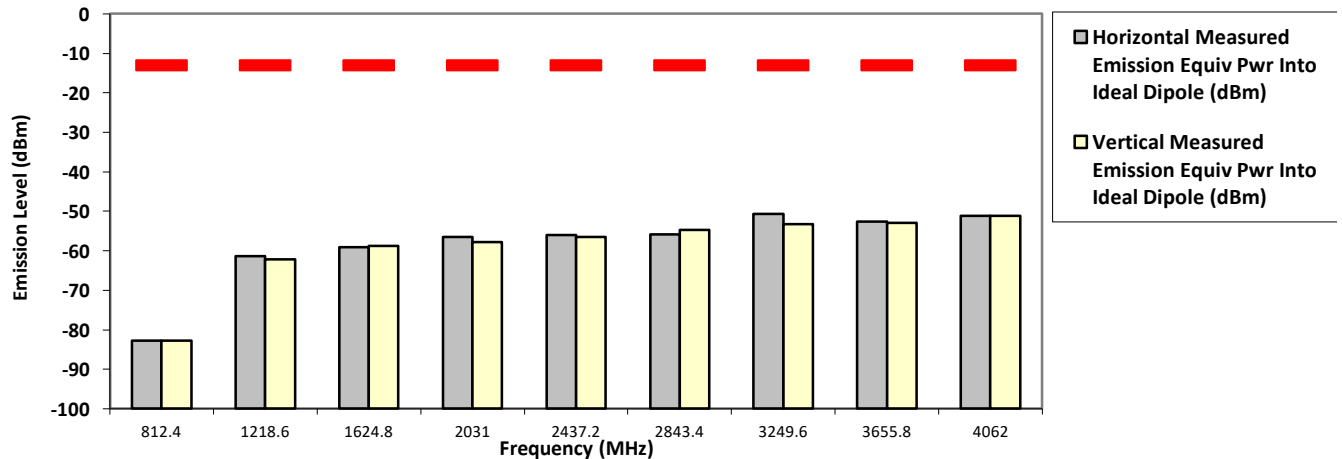

The data presented here was taken using the substitution method as found in the ANSI C63.26-2015 document.  
 Motorola Penang EMC Lab - Test Performed by: Azil & Qawiman      Fri, Jul 05, 2019

Remarks: \*\* Indicates the spurious emission could not be detected due to noise limitations or ambient.  
 \*Pursuant to CFR 47 Part 2.1057 ( c ), emissions attenuated more than 20 dB below the permissible limit are not reported  
 Temp(Deg): 23.6 Hum(%RH): 70.2

System MU: 5.01 dB

Remarks:	Passed Results	Marginal Results	Failed Results
----------	----------------	------------------	----------------

SAC Transmitter Radiated Emission:

Model Number: LAH87YDC9JA2AN

S/N: 278TVH0062

SR:09189-EMC-00019

Battery Part No: PMNN4476A

Accy Part No: NA

Test Mode: TX Analog  
 25 kHz

406.200000 MHz

4.800 Watt(s) /Max Power

Frequency (MHz)	Limit	Horizontal Measured Emission Equiv Pwr Into Ideal Dipole (dBm)	Vertical Measured Emission Equiv Pwr Into ideal Dipole (dBm)
812.4000	-13.0000	-80.4309 **	-83.2609 **
1218.6000	-13.0000	-61.2869 **	-60.3853 **
1624.8000	-13.0000	-58.8636 **	-59.2597 **
2031.0000	-13.0000	-56.5390 **	-56.7832 **
2437.2000	-13.0000	-56.1419 **	-55.9819 **
2843.4000	-13.0000	-54.2217 **	-54.4449 **
3249.6000	-13.0000	-52.8284 **	-51.7586 **
3655.8000	-13.0000	-53.6387 **	-51.8876 **
4062.0000	-13.0000	-52.0554 **	-52.1246 **

RADIATED SPURIOUS EMISSIONS

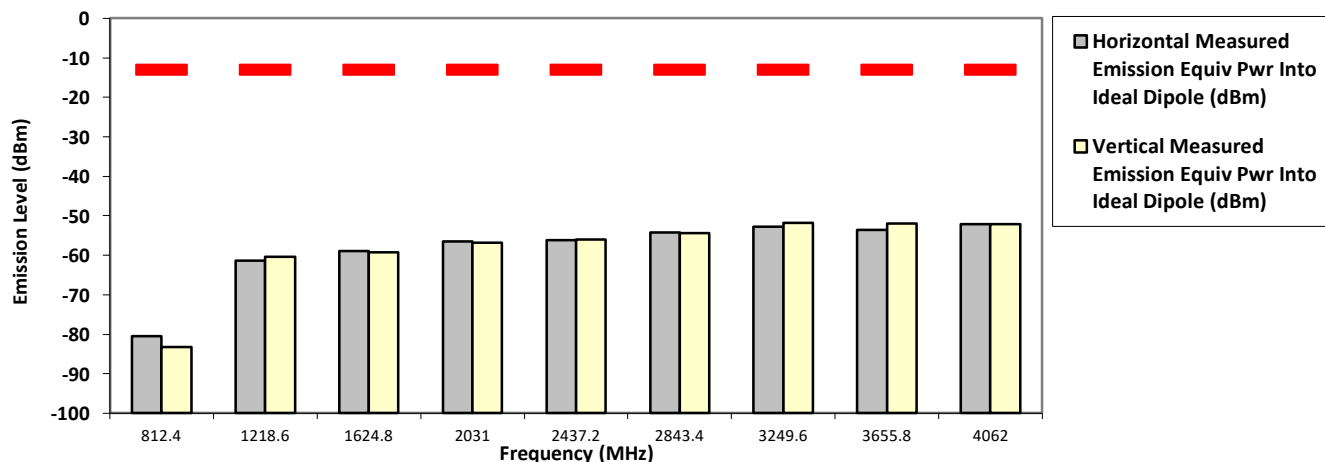

The data presented here was taken using the substitution method as found in the ANSI C63.26-2015 document.  
 Motorola Penang EMC Lab - Test Performed by: Azil & Qawiman Fri, Jul 05, 2019

Remarks: \*\* Indicates the spurious emission could not be detected due to noise limitations or ambient.  
 \*Pursuant to CFR 47 Part 2.1057 ( c ), emissions attenuated more than 20 dB below the permissible limit are not reported  
 Temp(Deg): 23.6 Hum(%RH): 70.2

System MU: 5.01 dB

Remarks:	Passed Results	Marginal Results	Failed Results
----------	----------------	------------------	----------------

SAC Transmitter Radiated Emission:

Model Number: LAH87YDC9JA2AN

S/N: 278TVH0062

SR:09189-EMC-00019

Battery Part No: PMNN4476A

Accy Part No: NA

Test Mode: TX Analog  
 25 kHz

450.025000 MHz

1.000 Watt(s) /Low Power

Frequency (MHz)	Limit	Horizontal Measured Emission Equiv Pwr Into Ideal Dipole (dBm)	Vertical Measured Emission Equiv Pwr Into ideal Dipole (dBm)
900.0500	-13.0000	-82.5984 **	-83.2898 **
1350.0750	-13.0000	-61.5151 **	-62.1142 **
1800.1000	-13.0000	-59.3448 **	-60.1182 **
2250.1250	-13.0000	-56.1417 **	-57.3375 **
2700.1500	-13.0000	-55.3822 **	-55.6604 **
3150.1750	-13.0000	-53.8837 **	-52.6269 **
3600.2000	-13.0000	-54.1237 **	-53.9193 **
4050.2250	-13.0000	-50.3220 **	-52.3839 **
4500.2500	-13.0000	-48.9735 **	-50.1908 **

RADIATED SPURIOUS EMISSIONS

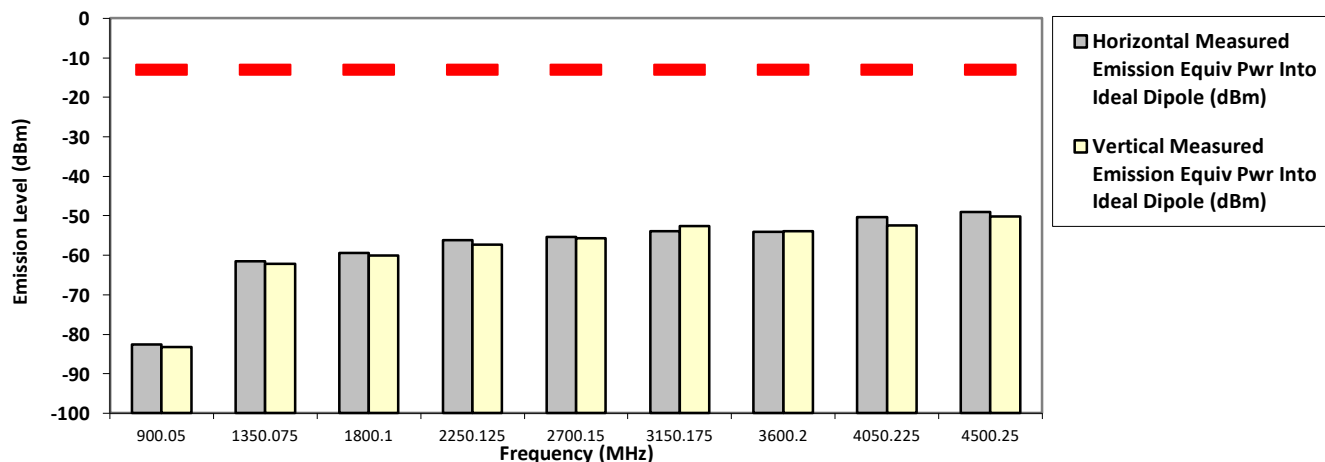

The data presented here was taken using the substitution method as found in the ANSI C63.26-2015 document.  
 Motorola Penang EMC Lab - Test Performed by: Azil & Qawiman  
 Fri, Jul 05, 2019

Remarks: \*\* Indicates the spurious emission could not be detected due to noise limitations or ambient.  
 \*Pursuant to CFR 47 Part 2.1057 ( c ), emissions attenuated more than 20 dB below the permissible limit are not reported  
 Temp(Deg): 23.6 Hum(%RH): 70.2

System MU: 5.01 dB

Remarks:	Passed Results	Marginal Results	Failed Results
----------	----------------	------------------	----------------

**SAC Transmitter Radiated Emission:**  
Model Number: LAH87YDC9JA2AN      S/N: 278TVH0062      SR:09189-EMC-00019  
Battery Part No: PMNN4476A  
Test Mode: TX Analog      Accy Part No: NA  
450.025000 MHz      25 kHz      4.800 Watt(s) /Max Power

Frequency (MHz)	Limit	Horizontal Measured Emission Equiv Pwr Into Ideal Dipole (dBm)	Vertical Measured Emission Equiv Pwr Into ideal Dipole (dBm)
900.0500	-13.0000	-81.6717 **	-82.9372 **
1350.0750	-13.0000	-60.8863 **	-61.2090 **
1800.1000	-13.0000	-59.1106 **	-59.1263 **
2250.1250	-13.0000	-57.3743 **	-57.8387 **
2700.1500	-13.0000	-55.3433 **	-54.9298 **
3150.1750	-13.0000	-53.0373 **	-52.4896 **
3600.2000	-13.0000	-53.0802 **	-53.4737 **
4050.2250	-13.0000	-50.9539 **	-52.5177 **
4500.2500	-13.0000	-50.3415 **	-51.8254 **

**RADIATED SPURIOUS EMISSIONS**

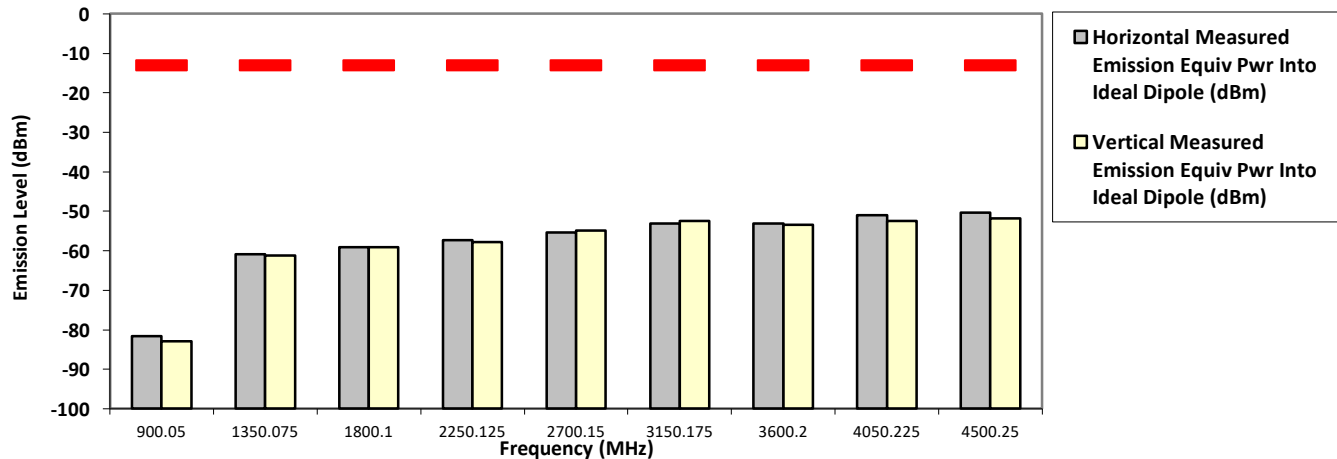

The data presented here was taken using the substitution method as found in the ANSI C63.26-2015 document.  
Motorola Penang EMC Lab - Test Performed by: Azil & Qawiman      Fri, Jul 05, 2019

Remarks: \*\* Indicates the spurious emission could not be detected due to noise limitations or ambient.  
\*Pursuant to CFR 47 Part 2.1057 ( c ), emissions attenuated more than 20 dB below the permissible limit are not reported  
Temp(Deg): 23.6 Hum(%RH): 70.2

System MU: 5.01 dB

Remarks: 

Passed Results	Marginal Results	Failed Results
----------------	------------------	----------------

SAC Transmitter Radiated Emission:  
 Model Number: LAH87YDC9JA2AN S/N: 278TVH0062 SR:09189-EMC-00019  
 Battery Part No: PMNN4476A Test Mode: TX Analog Accy Part No: NA  
 459.125000 MHz 25 kHz 1.000 Watt(s) /Low Power

Frequency (MHz)	Limit	Horizontal Measured Emission Equiv Pwr Into Ideal Dipole (dBm)	Vertical Measured Emission Equiv Pwr Into ideal Dipole (dBm)
918.2500	-13.0000	-81.6237 **	-83.0274 **
1377.3750	-13.0000	-61.3495 **	-60.7164 **
1836.5000	-13.0000	-58.0478 **	-59.4571 **
2295.6250	-13.0000	-57.1025 **	-56.5269 **
2754.7500	-13.0000	-55.4757 **	-54.3483 **
3213.8750	-13.0000	-51.9980 **	-53.0108 **
3673.0000	-13.0000	-53.6524 **	-52.4655 **
4132.1250	-13.0000	-51.7627 **	-51.6739 **
4591.2500	-13.0000	-51.3021 **	-50.1160 **

RADIATED SPURIOUS EMISSIONS

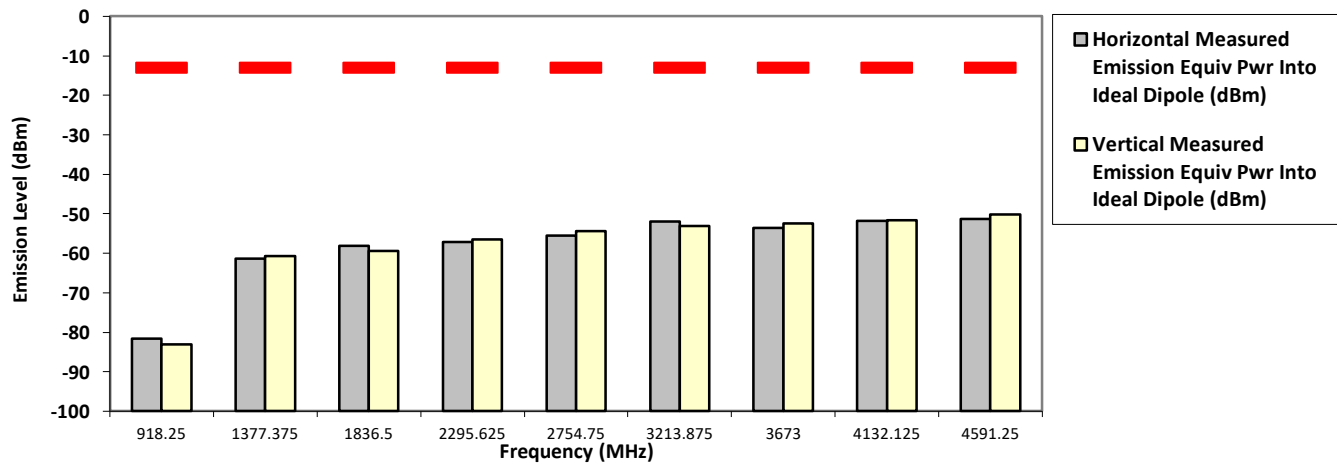

The data presented here was taken using the substitution method as found in the ANSI C63.26-2015 document.  
 Motorola Penang EMC Lab - Test Performed by: Azil & Qawiman Sat, Jul 06, 2019

Remarks: \*\* Indicates the spurious emission could not be detected due to noise limitations or ambient.  
 \*Pursuant to CFR 47 Part 2.1057 ( c ), emissions attenuated more than 20 dB below the permissible limit are not reported  
 Temp(Deg): 23.6 Hum(%RH): 70.2

System MU: 5.01 dB

Remarks:	Passed Results	Marginal Results	Failed Results
----------	----------------	------------------	----------------

**SAC Transmitter Radiated Emission:**  
**Model Number:** LAH87YDC9JA2AN **S/N:** 278TVH0062 **SR:**09189-EMC-00019  
**Battery Part No:** PMNN4476A **Test Mode:** TX Analog **Accy Part No:** NA  
**459.125000 MHz** **25 kHz** **4.800 Watt(s) /Max Power**

Frequency (MHz)	Limit	Horizontal Measured Emission Equip Pwr Into Ideal Dipole (dBm)	Vertical Measured Emission Equip Pwr Into ideal Dipole (dBm)
918.2500	-13.0000	-82.6864 **	-83.6752 **
1377.3750	-13.0000	-60.9422 **	-60.4339 **
1836.5000	-13.0000	-59.7310 **	-59.6112 **
2295.6250	-13.0000	-57.2093 **	-55.6714 **
2754.7500	-13.0000	-55.2268 **	-55.0364 **
3213.8750	-13.0000	-52.7703 **	-53.1672 **
3673.0000	-13.0000	-54.0603 **	-51.6868 **
4132.1250	-13.0000	-52.3471 **	-52.1212 **
4591.2500	-13.0000	-51.2755 **	-49.5591 **

**RADIATED SPURIOUS EMISSIONS**

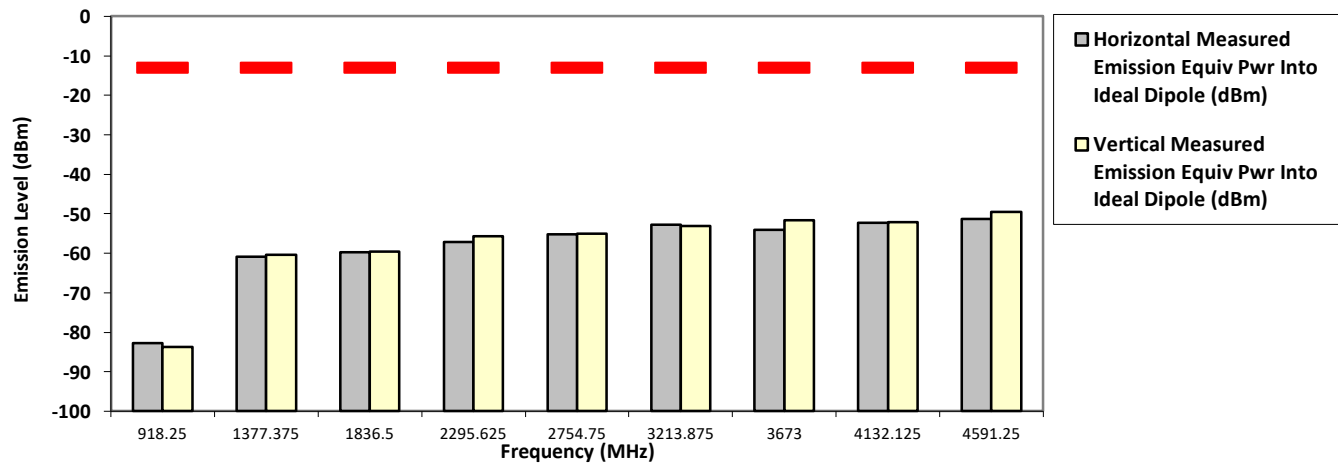

The data presented here was taken using the substitution method as found in the ANSI C63.26-2015 document.  
 Motorola Penang EMC Lab - Test Performed by: Azil & Qawiman Sat, Jul 06, 2019

Remarks: \*\* Indicates the spurious emission could not be detected due to noise limitations or ambient.  
 \*Pursuant to CFR 47 Part 2.1057 ( c ), emissions attenuated more than 20 dB below the permissible limit are not reported  
 Temp(Deg): 23.6 Hum(%RH): 70.2

System MU: 5.01 dB

Remarks:

Passed Results	Marginal Results	Failed Results
----------------	------------------	----------------



SAC Transmitter Radiated Emission:

Model Number: LAH87YDC9JA2AN

S/N: 278TVH0062

SR:09189-EMC-00019

Battery Part No: PMNN4476A

Accy Part No: NA

Test Mode: TX Analog  
 25 kHz

467.775000 MHz

1.000 Watt(s) /Low Power

Frequency (MHz)	Limit	Horizontal Measured Emission Equiv Pwr Into Ideal Dipole (dBm)	Vertical Measured Emission Equiv Pwr Into ideal Dipole (dBm)
935.5500	-13.0000	-82.5993 **	-82.1694 **
1403.3250	-13.0000	-60.9700 **	-60.8204 **
1871.1000	-13.0000	-58.9195 **	-58.5669 **
2338.8750	-13.0000	-56.1165 **	-55.4008 **
2806.6500	-13.0000	-54.7359 **	-55.5525 **
3274.4250	-13.0000	-53.0211 **	-52.9336 **
3742.2000	-13.0000	-53.6803 **	-52.7088 **
4209.9750	-13.0000	-51.8207 **	-52.3735 **
4677.7500	-13.0000	-49.0973 **	-50.2170 **

RADIATED SPURIOUS EMISSIONS

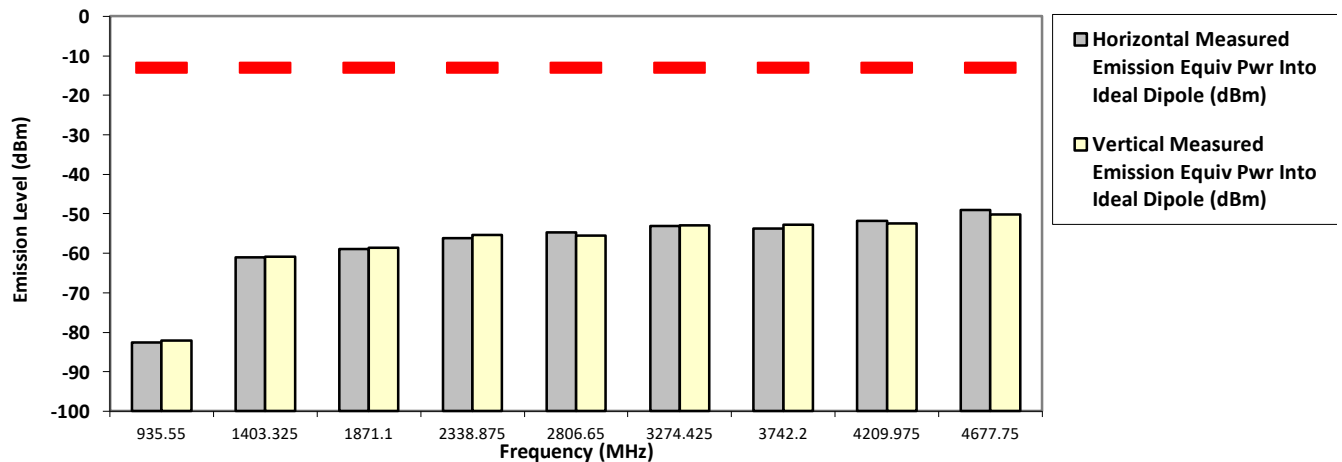

The data presented here was taken using the substitution method as found in the ANSI C63.26-2015 document.  
 Motorola Penang EMC Lab - Test Performed by: Azil & Qawiman  
 Fri, Jul 05, 2019

Remarks: \*\* Indicates the spurious emission could not be detected due to noise limitations or ambient.  
 \*Pursuant to CFR 47 Part 2.1057 ( c ), emissions attenuated more than 20 dB below the permissible limit are not reported  
 Temp(Deg): 23.6 Hum(%RH): 70.2

System MU: 5.01 dB

Remarks:	Passed Results	Marginal Results	Failed Results
----------	----------------	------------------	----------------

**SAC Transmitter Radiated Emission:**

Model Number: LAH87YDC9JA2AN      S/N: 278TVH0062      SR:09189-EMC-00019  
 Battery Part No: PMNN4476A  
 Test Mode: TX Analog      Accy Part No: NA  
 467.775000 MHz      25 kHz      4.800 Watt(s) /Max Power

Frequency (MHz)	Limit	Horizontal Measured Emission Equiv Pwr Into Ideal Dipole (dBm)	Vertical Measured Emission Equiv Pwr Into ideal Dipole (dBm)
935.5500	-13.0000	-81.6448 **	-82.4052 **
1403.3250	-13.0000	-61.3067 **	-59.9348 **
1871.1000	-13.0000	-58.3898 **	-57.5099 **
2338.8750	-13.0000	-55.6389 **	-56.3363 **
2806.6500	-13.0000	-55.5662 **	-54.8088 **
3274.4250	-13.0000	-51.0834 **	-53.9435 **
3742.2000	-13.0000	-54.2937 **	-53.4390 **
4209.9750	-13.0000	-52.2567 **	-51.4239 **
4677.7500	-13.0000	-50.8284 **	-49.9725 **

**RADIATED SPURIOUS EMISSIONS**

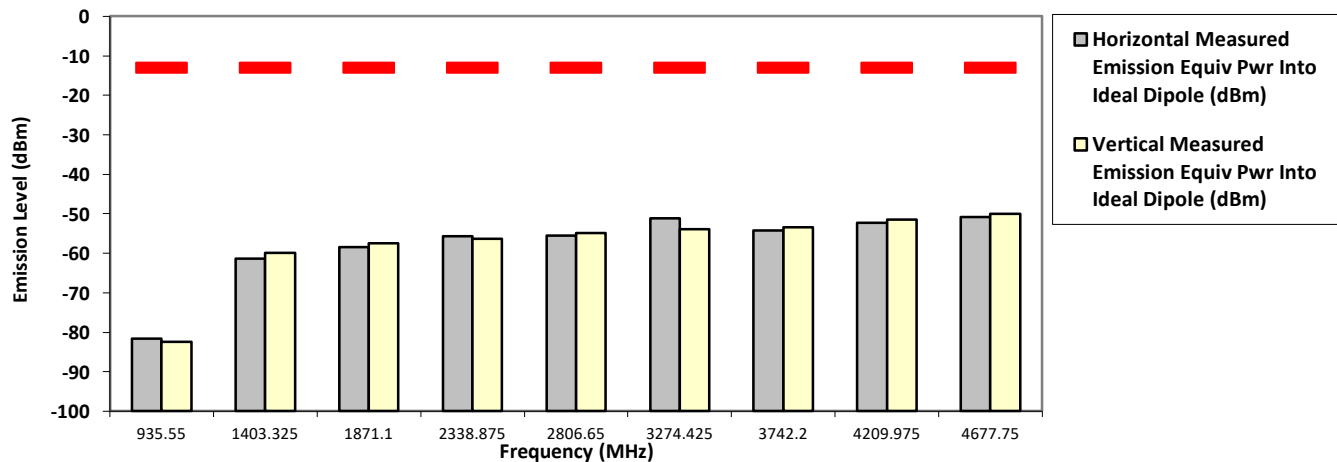

The data presented here was taken using the substitution method as found in the ANSI C63.26-2015 document.  
 Motorola Penang EMC Lab - Test Performed by: Azil & Qawiman      Fri, Jul 05, 2019

Remarks: \*\* Indicates the spurious emission could not be detected due to noise limitations or ambient.  
 \*Pursuant to CFR 47 Part 2.1057 ( c ), emissions attenuated more than 20 dB below the permissible limit are not reported  
 Temp(Deg): 23.6 Hum(%RH): 70.2

System MU: 5.01 dB

Remarks:	Passed Results	Marginal Results	Failed Results
----------	----------------	------------------	----------------

**SAC Transmitter Radiated Emission:**

**Model Number: LAH87YDC9JA2AN**      **S/N: 278TVH0062**      **SR:09189-EMC-00019**  
**Battery Part No: PMNN4476A**      **Test Mode: TX Analog**      **Accy Part No: NA**  
**479.987500 MHz**      **25 kHz**      **1.000 Watt(s) /Low Power**

Frequency (MHz)	Limit	Horizontal Measured Emission Equiv Pwr Into Ideal Dipole (dBm)	Vertical Measured Emission Equiv Pwr Into ideal Dipole (dBm)
959.9750	-13.0000	-81.4083 **	-81.1935 **
1439.9625	-13.0000	-61.0466 **	-60.7581 **
1919.9500	-13.0000	-58.1319 **	-57.7601 **
2399.9375	-13.0000	-56.4030 **	-56.7505 **
2879.9250	-13.0000	-54.2455 **	-55.2128 **
3359.9125	-13.0000	-54.1379 **	-53.3682 **
3839.9000	-13.0000	-51.9067 **	-52.6715 **
4319.8875	-13.0000	-51.8532 **	-51.1302 **
4799.8750	-13.0000	-49.3621 **	-49.0319 **

**RADIATED SPURIOUS EMISSIONS**

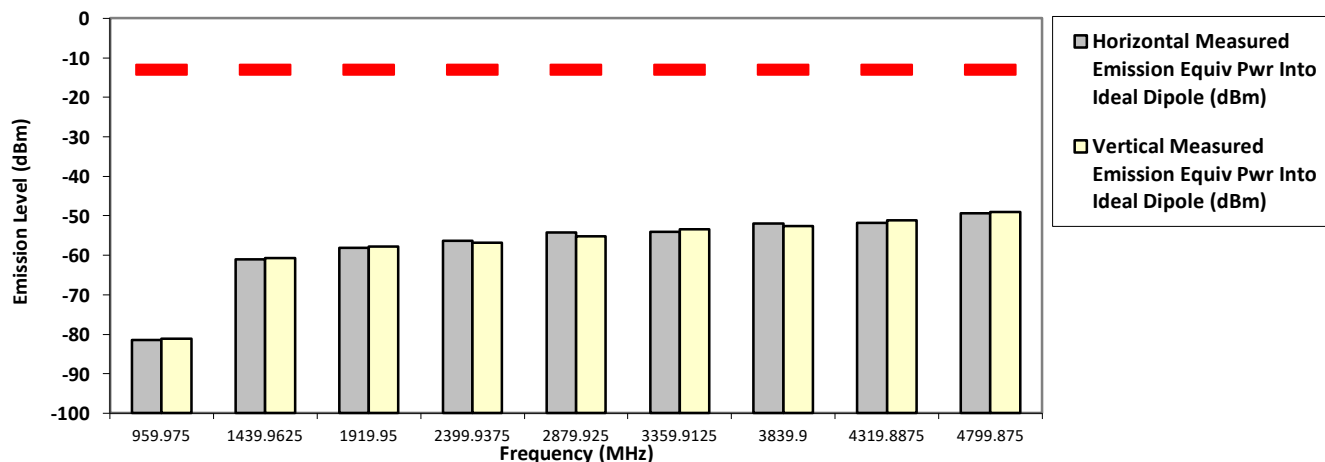

The data presented here was taken using the substitution method as found in the ANSI C63.26-2015 document.  
 Motorola Penang EMC Lab - Test Performed by: Azil & Qawiman      Sat, Jul 06, 2019

Remarks: \*\* Indicates the spurious emission could not be detected due to noise limitations or ambient.  
 \*Pursuant to CFR 47 Part 2.1057 ( c ), emissions attenuated more than 20 dB below the permissible limit are not reported  
 Temp(Deg): 23.6 Hum(%RH): 70.2

System MU: 5.01 dB

<b>Remarks:</b>	Passed Results	Marginal Results	Failed Results
-----------------	----------------	------------------	----------------

**SAC Transmitter Radiated Emission:**  
**Model Number:** LAH87YDC9JA2AN      **S/N:** 278TVH0062      **SR:**09189-EMC-00019  
**Battery Part No:** PMNN4476A  
**Test Mode:** TX Analog      **Accy Part No:** NA  
**479.987500 MHz**      **25 kHz**      **4.800 Watt(s) /Max Power**

Frequency (MHz)	Limit	Horizontal Measured Emission Equip Pwr Into Ideal Dipole (dBm)	Vertical Measured Emission Equip Pwr Into ideal Dipole (dBm)
959.9750	-13.0000	-82.2394 **	-81.4907 **
1439.9625	-13.0000	-60.1562 **	-61.4889 **
1919.9500	-13.0000	-57.6178 **	-57.4608 **
2399.9375	-13.0000	-55.3798 **	-55.3439 **
2879.9250	-13.0000	-54.0989 **	-53.8112 **
3359.9125	-13.0000	-53.9100 **	-53.3920 **
3839.9000	-13.0000	-52.3180 **	-52.7944 **
4319.8875	-13.0000	-52.2287 **	-51.9539 **
4799.8750	-13.0000	-50.0072 **	-50.2317 **

**RADIATED SPURIOUS EMISSIONS**

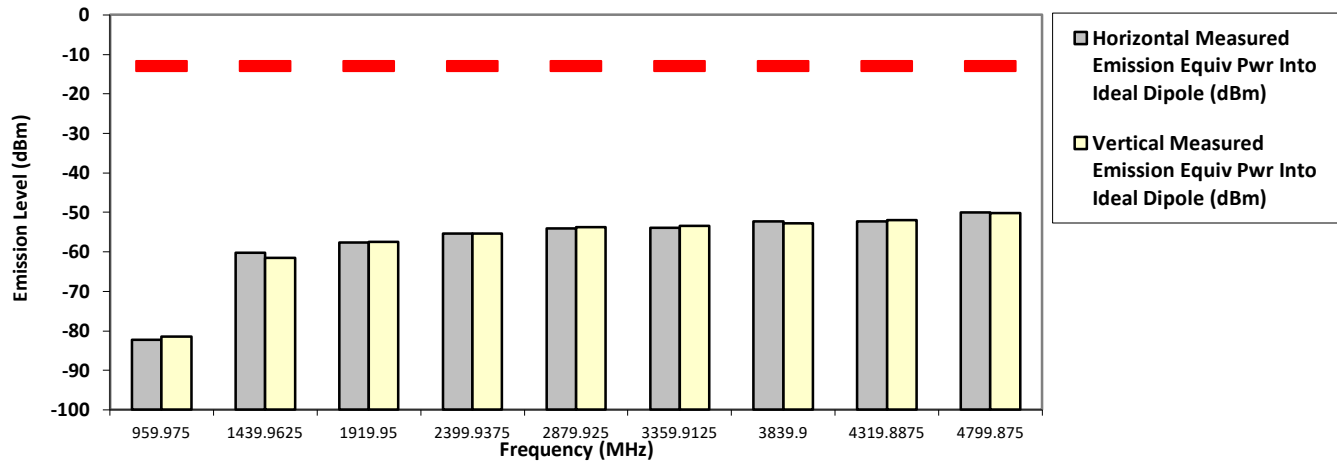

The data presented here was taken using the substitution method as found in the ANSI C63.26-2015 document.  
 Motorola Penang EMC Lab - Test Performed by: Azil & Qawiman      Sat, Jul 06, 2019

Remarks: \*\* Indicates the spurious emission could not be detected due to noise limitations or ambient.  
 \*Pursuant to CFR 47 Part 2.1057 ( c ), emissions attenuated more than 20 dB below the permissible limit are not reported  
 Temp(Deg): 23.6 Hum(%RH): 70.2

System MU: 5.01 dB

Remarks: Passed Results Marginal Results Failed Results

**SAC Transmitter Radiated Emission:**  
**Model Number: LAH87YDC9JA2AN**      **S/N: 278TVH0062**      **SR:09189-EMC-00017**  
**Battery Part No: PMNN4080A**      **Accy Part No: NA**  
**Test Mode: TX Analog**  
**450.025000 MHz**      **25 kHz**      **1.000 Watt(s) /Low Power**

Frequency (MHz)	Limit	Horizontal Measured Emission Equiv Pwr Into Ideal Dipole (dBm)	Vertical Measured Emission Equiv Pwr Into ideal Dipole (dBm)
900.0500	-13.0000	-82.1003 **	-82.2888 **
1350.0750	-13.0000	-60.9899 **	-60.5445 **
1800.1000	-13.0000	-57.1631 **	-58.8330 **
2250.1250	-13.0000	-57.2317 **	-57.6941 **
2700.1500	-13.0000	-54.5984 **	-54.5310 **
3150.1750	-13.0000	-53.4159 **	-52.4115 **
3600.2000	-13.0000	-53.0493 **	-53.7434 **
4050.2250	-13.0000	-49.5961 **	-51.2316 **
4500.2500	-13.0000	-50.5537 **	-51.0886 **

**RADIATED SPURIOUS EMISSIONS**

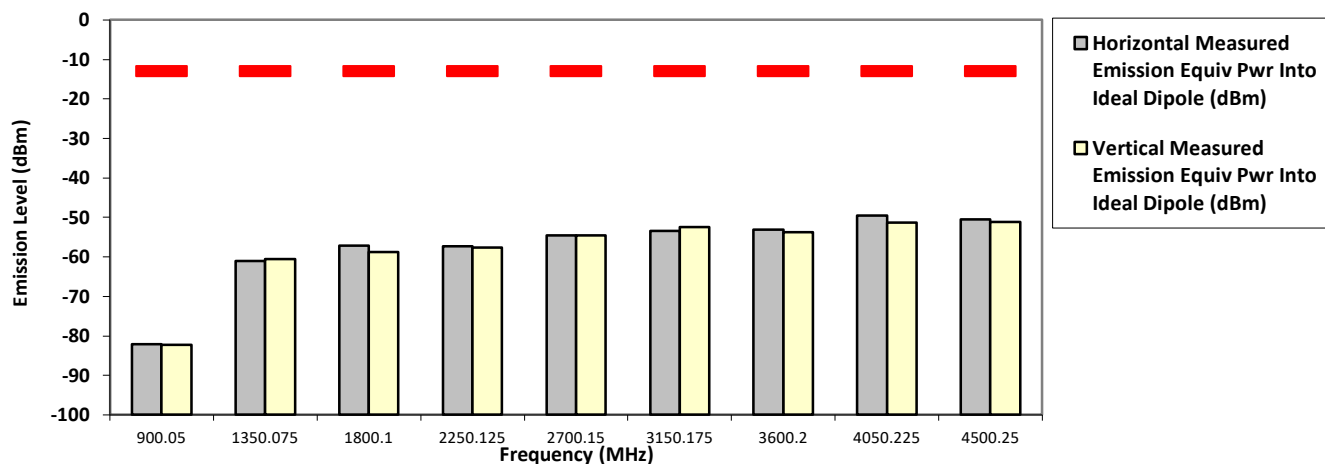

The data presented here was taken using the substitution method as found in the ANSI C63.26-2015 document.  
 Motorola Penang EMC Lab - Test Performed by: Nazrin&Qawiman      Wed, Jul 03, 2019

Remarks: \*\* Indicates the spurious emission could not be detected due to noise limitations or ambient.  
 \*Pursuant to CFR 47 Part 2.1057 ( c ), emissions attenuated more than 20 dB below the permissible limit are not reported  
 Temp(Deg): 23.5 Hum(%RH): 69.8

System MU: 5.01 dB

Remarks:      Passed Results      **Marginal Results**      Failed Results

**SAC Transmitter Radiated Emission:**

Model Number: LAH87YDC9JA2AN      S/N: 278TVH0062      SR:09189-EMC-00017  
 Battery Part No: PMNN4080A  
 Test Mode: TX Analog      Accy Part No: NA  
 450.025000 MHz      25 kHz      4.800 Watt(s) /Max Power

Frequency (MHz)	Limit	Horizontal Measured Emission Equiv Pwr Into Ideal Dipole (dBm)	Vertical Measured Emission Equiv Pwr Into ideal Dipole (dBm)
900.0500	-13.0000	-82.3103 **	-82.4814 **
1350.0750	-13.0000	-61.4510 **	-60.3015 **
1800.1000	-13.0000	-59.0779 **	-59.2737 **
2250.1250	-13.0000	-56.6828 **	-56.9415 **
2700.1500	-13.0000	-53.8972 **	-54.6503 **
3150.1750	-13.0000	-52.8694 **	-52.9513 **
3600.2000	-13.0000	-53.6730 **	-53.5804 **
4050.2250	-13.0000	-50.3396 **	-51.5209 **
4500.2500	-13.0000	-50.7114 **	-51.2965 **

**RADIATED SPURIOUS EMISSIONS**

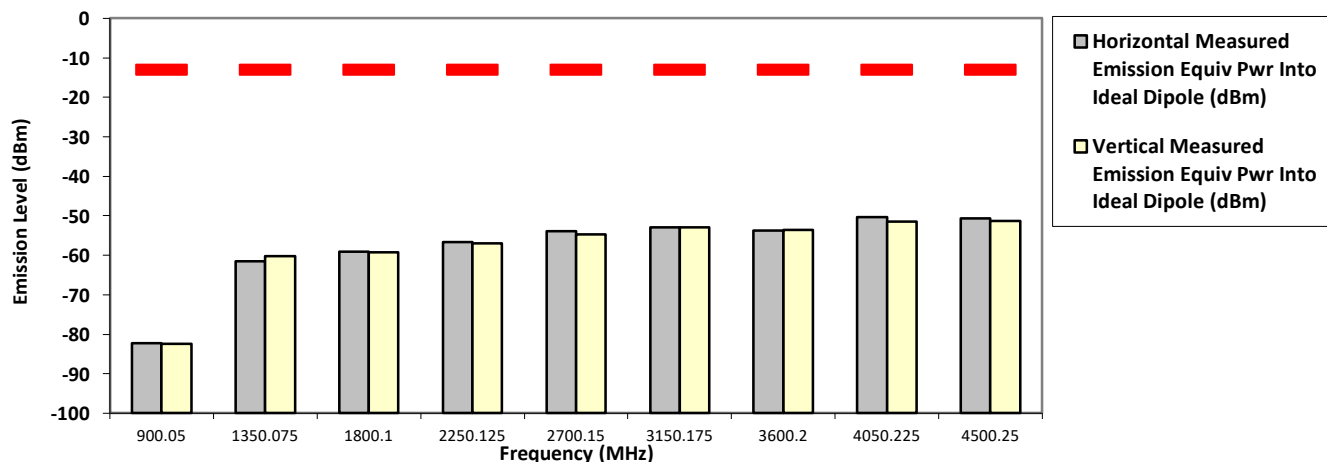

The data presented here was taken using the substitution method as found in the ANSI C63.26-2015 document.  
 Motorola Penang EMC Lab - Test Performed by: Nazrin&Qawiman      Wed, Jul 03, 2019

Remarks: \*\* Indicates the spurious emission could not be detected due to noise limitations or ambient.  
 \*Pursuant to CFR 47 Part 2.1057 ( c ), emissions attenuated more than 20 dB below the permissible limit are not reported  
 Temp(Deg): 23.5 Hum(%RH): 69.8

System MU: 5.01 dB

Remarks:

Passed Results	Marginal Results	Failed Results
----------------	------------------	----------------

SAC Transmitter Radiated Emission:  
 Model Number: LAH87YDC9JA2AN      S/N: 278TVH0062      SR:09189-EMC-00018  
 Battery Part No: PMNN4476A  
 Test Mode: TX Analog      Accy Part No: NA  
 450.025000 MHz      25 kHz      1.000 Watt(s) /Low Power

Frequency (MHz)	Limit	Horizontal Measured Emission Equiv Pwr Into Ideal Dipole (dBm)	Vertical Measured Emission Equiv Pwr Into ideal Dipole (dBm)
900.0500	-13.0000	-81.3472 **	-81.1703 **
1350.0750	-13.0000	-60.6587 **	-60.5208 **
1800.1000	-13.0000	-59.0186 **	-59.1732 **
2250.1250	-13.0000	-57.0434 **	-57.3397 **
2700.1500	-13.0000	-54.6933 **	-55.4593 **
3150.1750	-13.0000	-52.3941 **	-52.2787 **
3600.2000	-13.0000	-51.9724 **	-51.5858 **
4050.2250	-13.0000	-51.2190 **	-50.7116 **
4500.2500	-13.0000	-50.2675 **	-51.0052 **

RADIATED SPURIOUS EMISSIONS

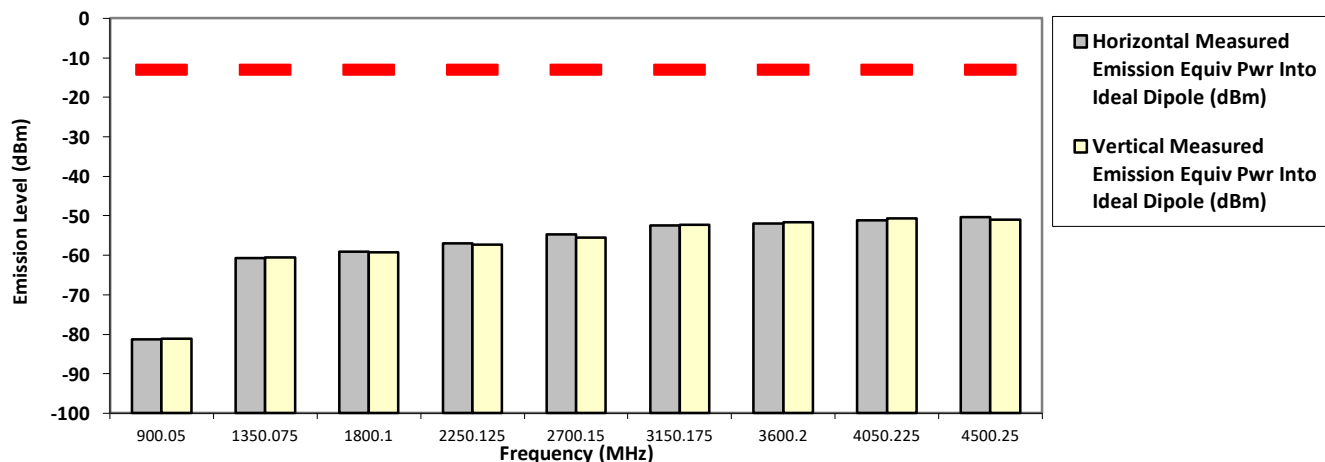

The data presented here was taken using the substitution method as found in the ANSI C63.26-2015 document.  
 Motorola Penang EMC Lab - Test Performed by: Azil & Qawiman      Wed, Jul 03, 2019

Remarks: \*\* Indicates the spurious emission could not be detected due to noise limitations or ambient.  
 \*Pursuant to CFR 47 Part 2.1057 ( c ), emissions attenuated more than 20 dB below the permissible limit are not reported  
 Temp(Deg): 23.5 Hum(%RH): 69.8

System MU: 5.01 dB

Remarks:	Passed Results	Marginal Results	Failed Results
----------	----------------	------------------	----------------

**SAC Transmitter Radiated Emission:**

Model Number: LAH87YDC9JA2AN      S/N: 278TVH0062      SR:09189-EMC-00018  
 Battery Part No: PMNN4476A  
 Test Mode: TX Analog      Accy Part No: NA  
 450.025000 MHz      25 kHz      4.800 Watt(s) /Max Power

Frequency (MHz)	Limit	Horizontal Measured Emission Equiv Pwr Into Ideal Dipole (dBm)	Vertical Measured Emission Equiv Pwr Into ideal Dipole (dBm)
900.0500	-13.0000	-41.3600 *	-35.0700 *
1350.0750	-13.0000	-60.7118 **	-61.0251 **
1800.1000	-13.0000	-60.3080 **	-58.9297 **
2250.1250	-13.0000	-56.8071 **	-56.1190 **
2700.1500	-13.0000	-54.7599 **	-54.7330 **
3150.1750	-13.0000	-51.4126 **	-52.8477 **
3600.2000	-13.0000	-54.3164 **	-53.7792 **
4050.2250	-13.0000	-52.0489 **	-50.8885 **
4500.2500	-13.0000	-50.3673 **	-50.7123 **

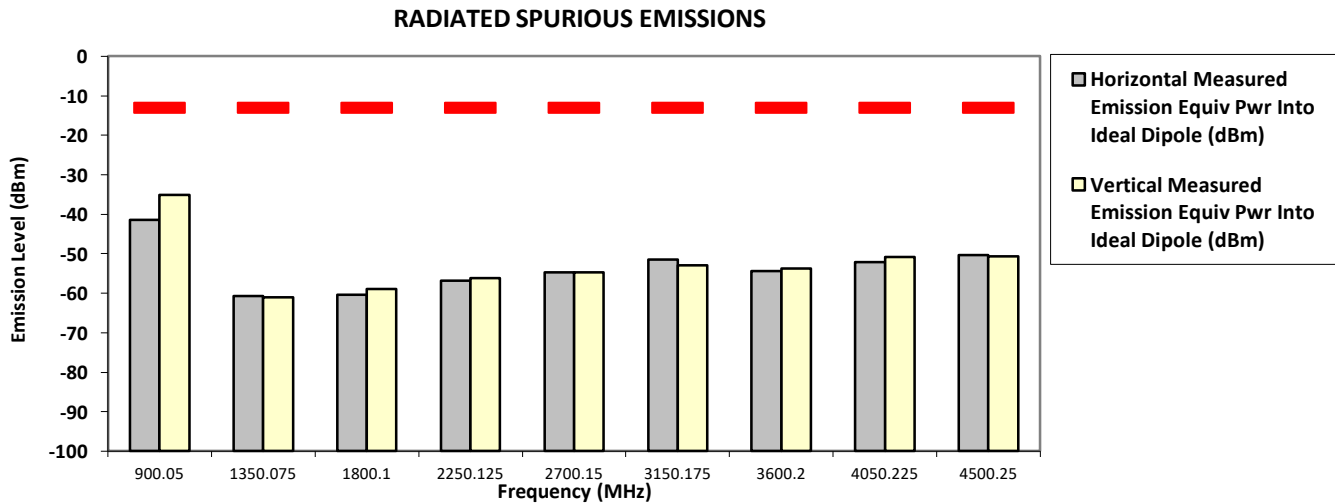

The data presented here was taken using the substitution method as found in the ANSI C63.26-2015 document.  
 Motorola Penang EMC Lab - Test Performed by: Azil & Qawiman      Wed, Jul 03, 2019

Remarks: \*\* Indicates the spurious emission could not be detected due to noise limitations or ambient.  
 \*Pursuant to CFR 47 Part 2.1057 ( c ), emissions attenuated more than 20 dB below the permissible limit are not reported  
 Temp(Deg): 23.5 Hum(%RH): 69.8

System MU: 5.01 dB

Remarks: Passed Results Marginal Results Failed Results



**6.11.2. Test Result (Digital)**

**SAC Transmitter Radiated Emission:**  
**Model Number:** LAH87YDC9JA2AN      **S/N:** 278TVH0062      **SR:**09189-EMC-00019  
**Battery Part No:** PMNN4476A      **Accy Part No:** NA  
**Test Mode:** TX PCR Digital 4FSK  
**403.012500 MHz**      **12.5 kHz**      **1.000 Watt(s) /Low Power**

Frequency (MHz)	Limit	Horizontal Measured Emission Equiv Pwr Into Ideal Dipole (dBm)	Vertical Measured Emission Equiv Pwr Into ideal Dipole (dBm)
806.0250	-20.0000	-82.1325 **	-82.3165 **
1209.0375	-20.0000	-60.9717 **	-61.4812 **
1612.0500	-20.0000	-60.2778 **	-59.5586 **
2015.0625	-20.0000	-56.0267 **	-56.0527 **
2418.0750	-20.0000	-56.1987 **	-55.9879 **
2821.0875	-20.0000	-54.3866 **	-54.4248 **
3224.1000	-20.0000	-51.9209 **	-51.9726 **
3627.1125	-20.0000	-53.2224 **	-54.3441 **
4030.1250	-20.0000	-51.7239 **	-51.4879 **

**RADIATED SPURIOUS EMISSIONS**

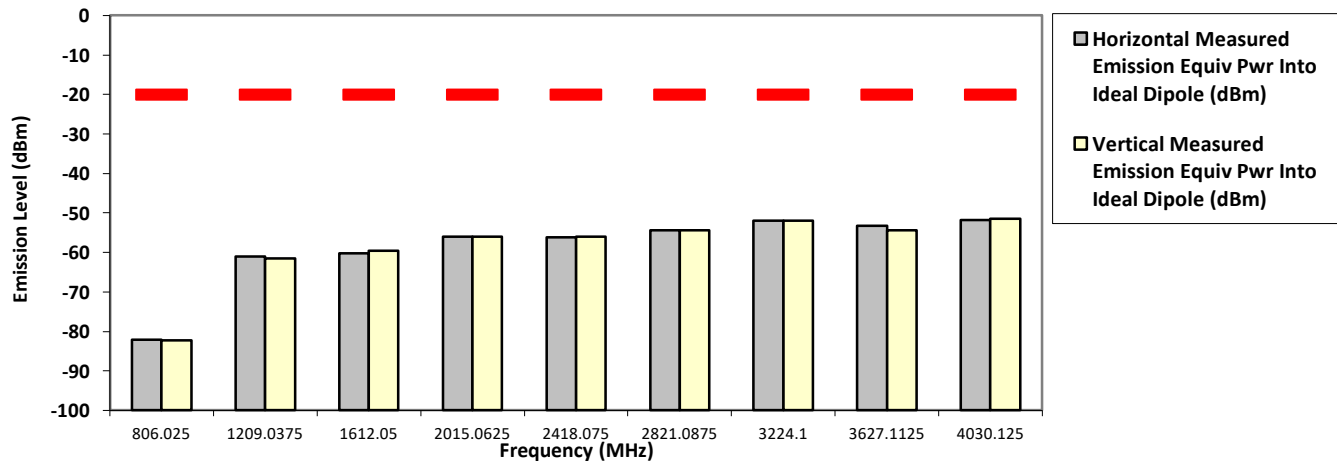

The data presented here was taken using the substitution method as found in the ANSI C63.26-2015 document.  
 Motorola Penang EMC Lab - Test Performed by: Azil & Qawiman      Fri, Jul 05, 2019

Remarks: \*\* Indicates the spurious emission could not be detected due to noise limitations or ambient.  
 \*Pursuant to CFR 47 Part 2.1057 ( c ), emissions attenuated more than 20 dB below the permissible limit are not reported  
 Temp(Deg): 23.6 Hum(%RH): 70.2

System MU: 5.01 dB

Remarks: Passed Results Marginal Results Failed Results

**SAC Transmitter Radiated Emission:**

**Model Number:** LAH87YDC9JA2AN      **S/N:** 278TVH0062      **SR:**09189-EMC-00019  
**Battery Part No:** PMNN4476A      **Accy Part No:** NA  
**Test Mode:** TX PCR Digital 4FSK  
**403.012500 MHz**      **12.5 kHz**      **4.800 Watt(s) /Max Power**

Frequency (MHz)	Limit	Horizontal Measured Emission Equip Pwr Into Ideal Dipole (dBm)	Vertical Measured Emission Equip Pwr Into ideal Dipole (dBm)
806.0250	-20.0000	-81.3386 **	-82.0821 **
1209.0375	-20.0000	-61.5280 **	-61.6268 **
1612.0500	-20.0000	-60.7387 **	-60.0596 **
2015.0625	-20.0000	-57.3630 **	-55.9986 **
2418.0750	-20.0000	-56.3562 **	-55.9002 **
2821.0875	-20.0000	-54.6230 **	-54.7589 **
3224.1000	-20.0000	-51.6554 **	-52.3439 **
3627.1125	-20.0000	-53.1020 **	-54.3877 **
4030.1250	-20.0000	-52.0427 **	-52.4784 **

**RADIATED SPURIOUS EMISSIONS**

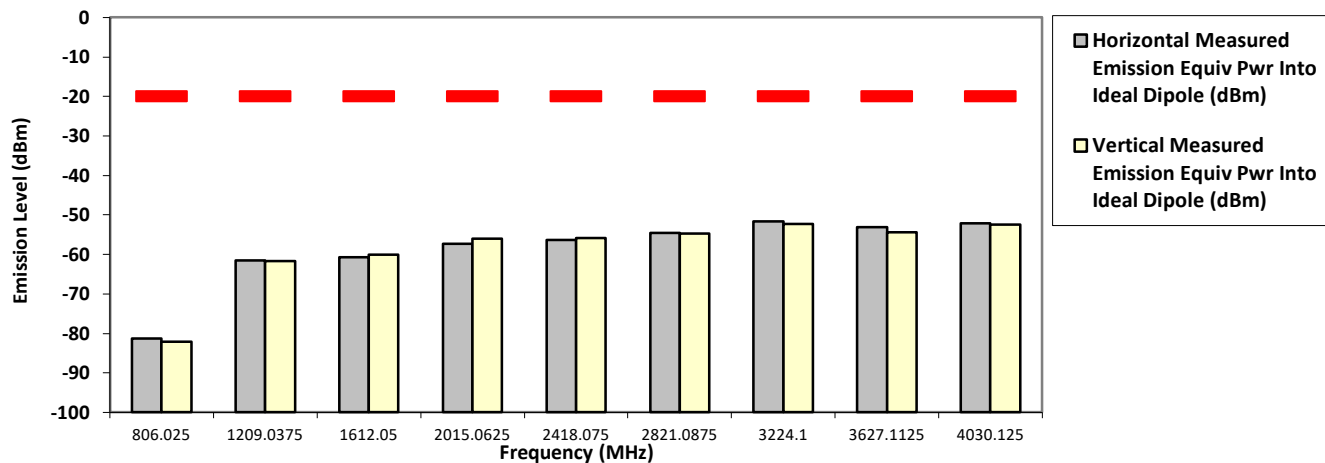

The data presented here was taken using the substitution method as found in the ANSI C63.26-2015 document.  
 Motorola Penang EMC Lab - Test Performed by: Azil & Qawiman      Fri, Jul 05, 2019

Remarks: \*\* Indicates the spurious emission could not be detected due to noise limitations or ambient.  
 \*Pursuant to CFR 47 Part 2.1057 ( c ), emissions attenuated more than 20 dB below the permissible limit are not reported  
 Temp(Deg): 23.6 Hum(%RH): 70.2

System MU: 5.01 dB

Remarks: Passed Results Marginal Results Failed Results

**SAC Transmitter Radiated Emission:**  
**Model Number:** LAH87YDC9JA2AN **S/N:** 278TVH0062 **SR:**09189-EMC-00019  
**Battery Part No:** PMNN4476A **Accy Part No:** NA  
**Test Mode:** TX PCR Digital 4FSK  
**406.200000 MHz** **12.5 kHz** **1.000 Watt(s) /Low Power**

Frequency (MHz)	Limit	Horizontal Measured Emission Equiv Pwr Into Ideal Dipole (dBm)	Vertical Measured Emission Equiv Pwr Into ideal Dipole (dBm)
812.4000	-20.0000	-82.3204 **	-82.0848 **
1218.6000	-20.0000	-62.2051 **	-61.4515 **
1624.8000	-20.0000	-59.9750 **	-57.7101 **
2031.0000	-20.0000	-57.0734 **	-56.9202 **
2437.2000	-20.0000	-55.2969 **	-55.0635 **
2843.4000	-20.0000	-55.4284 **	-55.3609 **
3249.6000	-20.0000	-52.5419 **	-51.9392 **
3655.8000	-20.0000	-53.5578 **	-53.9734 **
4062.0000	-20.0000	-50.5472 **	-51.8501 **

**RADIATED SPURIOUS EMISSIONS**

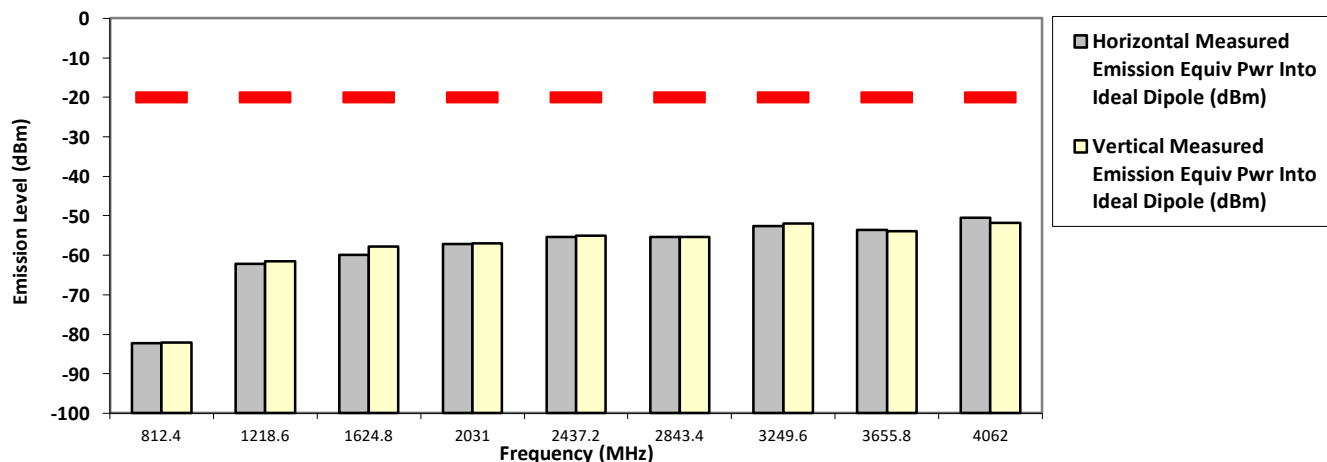

The data presented here was taken using the substitution method as found in the ANSI C63.26-2015 document.  
 Motorola Penang EMC Lab - Test Performed by: Azil & Qawiman Fri, Jul 05, 2019

Remarks: \*\* Indicates the spurious emission could not be detected due to noise limitations or ambient.  
 \*Pursuant to CFR 47 Part 2.1057 ( c ), emissions attenuated more than 20 dB below the permissible limit are not reported  
 Temp(Deg): 23.6 Hum(%RH): 70.2

System MU: 5.01 dB

Remarks:	Passed Results	Marginal Results	Failed Results
----------	----------------	------------------	----------------

**SAC Transmitter Radiated Emission:**

**Model Number: LAH87YDC9JA2AN**      **S/N: 278TVH0062**      **SR:09189-EMC-00019**  
**Battery Part No: PMNN4476A**      **Accy Part No: NA**  
**Test Mode: TX PCR Digital 4FSK**  
**406.200000 MHz**      **12.5 kHz**      **4.800 Watt(s) /Max Power**

Frequency (MHz)	Limit	Horizontal Measured Emission Equiv Pwr Into Ideal Dipole (dBm)	Vertical Measured Emission Equiv Pwr Into ideal Dipole (dBm)
812.4000	-20.0000	-83.2804 **	-81.5661 **
1218.6000	-20.0000	-60.8857 **	-61.2108 **
1624.8000	-20.0000	-60.7177 **	-60.1740 **
2031.0000	-20.0000	-55.9705 **	-57.0876 **
2437.2000	-20.0000	-56.0037 **	-56.7411 **
2843.4000	-20.0000	-54.2232 **	-55.1083 **
3249.6000	-20.0000	-52.6718 **	-53.3442 **
3655.8000	-20.0000	-53.1559 **	-52.9528 **
4062.0000	-20.0000	-51.0393 **	-49.6545 **

**RADIATED SPURIOUS EMISSIONS**

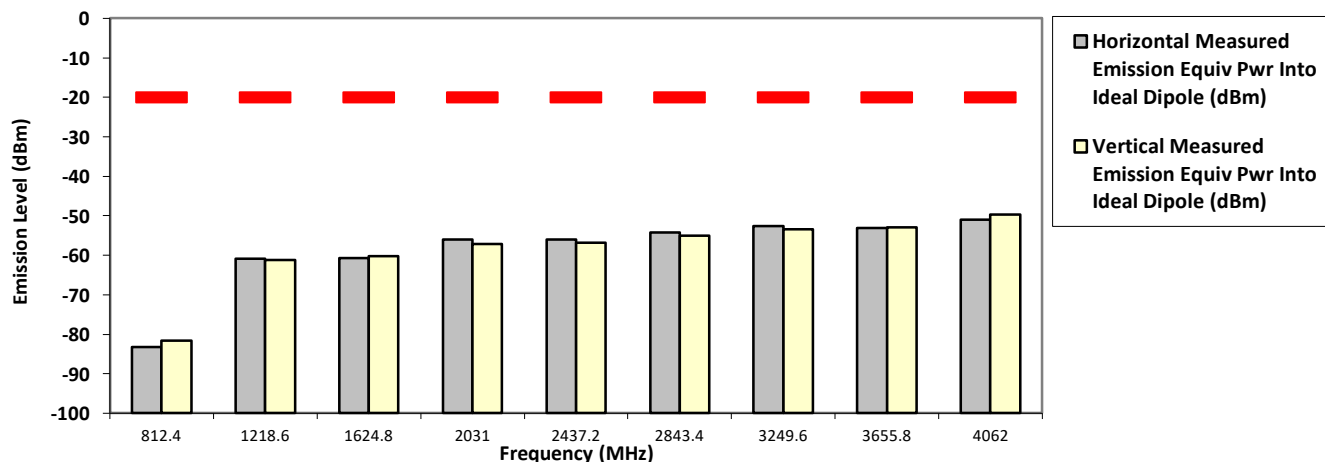

The data presented here was taken using the substitution method as found in the ANSI C63.26-2015 document.  
 Motorola Penang EMC Lab - Test Performed by: Azil & Qawiman      Fri, Jul 05, 2019

Remarks: \*\* Indicates the spurious emission could not be detected due to noise limitations or ambient.  
 \*Pursuant to CFR 47 Part 2.1057 ( c ), emissions attenuated more than 20 dB below the permissible limit are not reported  
 Temp(Deg): 23.6 Hum(%RH): 70.2

System MU: 5.01 dB

<b>Remarks:</b>	Passed Results	Marginal Results	Failed Results
-----------------	----------------	------------------	----------------

**SAC Transmitter Radiated Emission:**

Model Number: LAH87YDC9JA2AN      S/N: 278TVH0062      SR:09189-EMC-00019  
 Battery Part No: PMNN4476A      Accy Part No: NA  
 Test Mode: TX PCR Digital 4FSK  
 450.025000 MHz      12.5 kHz      1.000 Watt(s) /Low Power

Frequency (MHz)	Limit	Horizontal Measured Emission Equiv Pwr Into Ideal Dipole (dBm)	Vertical Measured Emission Equiv Pwr Into ideal Dipole (dBm)
900.0500	-20.0000	-82.5717 **	-82.5130 **
1350.0750	-20.0000	-59.5308 **	-61.5938 **
1800.1000	-20.0000	-59.3387 **	-58.1535 **
2250.1250	-20.0000	-56.7391 **	-56.1968 **
2700.1500	-20.0000	-55.0305 **	-54.6602 **
3150.1750	-20.0000	-53.2219 **	-53.5122 **
3600.2000	-20.0000	-54.2622 **	-53.3768 **
4050.2250	-20.0000	-51.2564 **	-50.2409 **
4500.2500	-20.0000	-50.3738 **	-51.3265 **

**RADIATED SPURIOUS EMISSIONS**

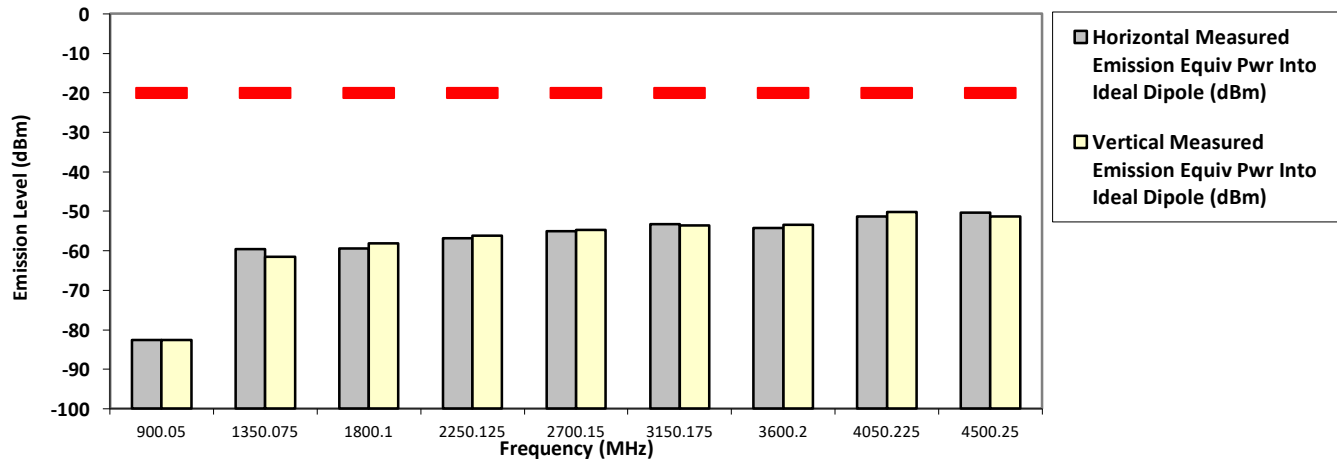

The data presented here was taken using the substitution method as found in the ANSI C63.26-2015 document.  
 Motorola Penang EMC Lab - Test Performed by: Azil & Qawiman      Fri, Jul 05, 2019

Remarks: \*\* Indicates the spurious emission could not be detected due to noise limitations or ambient.  
 \*Pursuant to CFR 47 Part 2.1057 ( c ), emissions attenuated more than 20 dB below the permissible limit are not reported  
 Temp(Deg): 23.6 Hum(%RH): 70.2

System MU: 5.01 dB

Remarks:	Passed Results	Marginal Results	Failed Results
----------	----------------	------------------	----------------

**SAC Transmitter Radiated Emission:**

Model Number: LAH87YDC9JA2AN      S/N: 278TVH0062      SR:09189-EMC-00019  
 Battery Part No: PMNN4476A      Accy Part No: NA  
 Test Mode: TX PCR Digital 4FSK  
 450.025000 MHz      12.5 kHz      4.800 Watt(s) /Max Power

Frequency (MHz)	Limit	Horizontal Measured Emission Equiv Pwr Into Ideal Dipole (dBm)	Vertical Measured Emission Equiv Pwr Into ideal Dipole (dBm)
900.0500	-20.0000	-82.6510 **	-81.7290 **
1350.0750	-20.0000	-61.0712 **	-60.7052 **
1800.1000	-20.0000	-58.8401 **	-59.4558 **
2250.1250	-20.0000	-56.9576 **	-57.3204 **
2700.1500	-20.0000	-53.4256 **	-55.2260 **
3150.1750	-20.0000	-52.7194 **	-53.4721 **
3600.2000	-20.0000	-53.8737 **	-54.6470 **
4050.2250	-20.0000	-51.5084 **	-51.1577 **
4500.2500	-20.0000	-50.6367 **	-50.0547 **

**RADIATED SPURIOUS EMISSIONS**

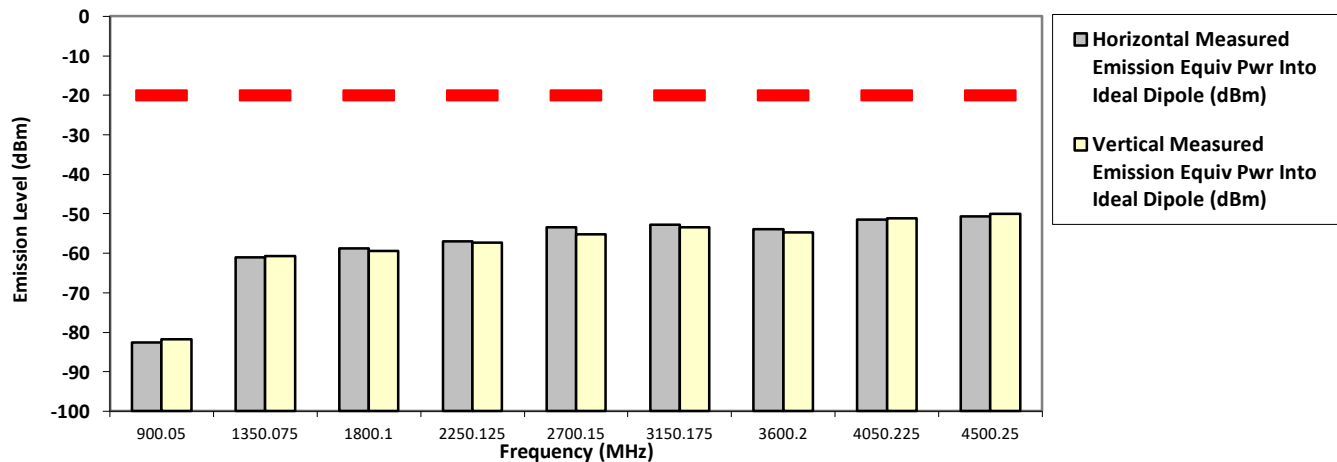

The data presented here was taken using the substitution method as found in the ANSI C63.26-2015 document.  
 Motorola Penang EMC Lab - Test Performed by: Azil & Qawiman      Fri, Jul 05, 2019

Remarks: \*\* Indicates the spurious emission could not be detected due to noise limitations or ambient.  
 \*Pursuant to CFR 47 Part 2.1057 ( c ), emissions attenuated more than 20 dB below the permissible limit are not reported  
 Temp(Deg): 23.6 Hum(%RH): 70.2

System MU: 5.01 dB

<b>Remarks:</b>	Passed Results	Marginal Results	Failed Results
-----------------	----------------	------------------	----------------

**SAC Transmitter Radiated Emission:**

Model Number: LAH87YDC9JA2AN      S/N: 278TVH0062      SR:09189-EMC-00019  
 Battery Part No: PMNN4476A      Accy Part No: NA  
 Test Mode: TX PCR Digital 4FSK  
 459.125000 MHz      12.5 kHz      1.000 Watt(s) /Low Power

Frequency (MHz)	Limit	Horizontal Measured Emission Equiv Pwr Into Ideal Dipole (dBm)	Vertical Measured Emission Equiv Pwr Into ideal Dipole (dBm)
918.2500	-20.0000	-82.9197 **	-82.7947 **
1377.3750	-20.0000	-61.7025 **	-60.5860 **
1836.5000	-20.0000	-58.6757 **	-59.1471 **
2295.6250	-20.0000	-57.2541 **	-56.7208 **
2754.7500	-20.0000	-55.5174 **	-55.2556 **
3213.8750	-20.0000	-52.4830 **	-52.6992 **
3673.0000	-20.0000	-53.0002 **	-52.6686 **
4132.1250	-20.0000	-52.1057 **	-52.1541 **
4591.2500	-20.0000	-49.5863 **	-50.5372 **

**RADIATED SPURIOUS EMISSIONS**

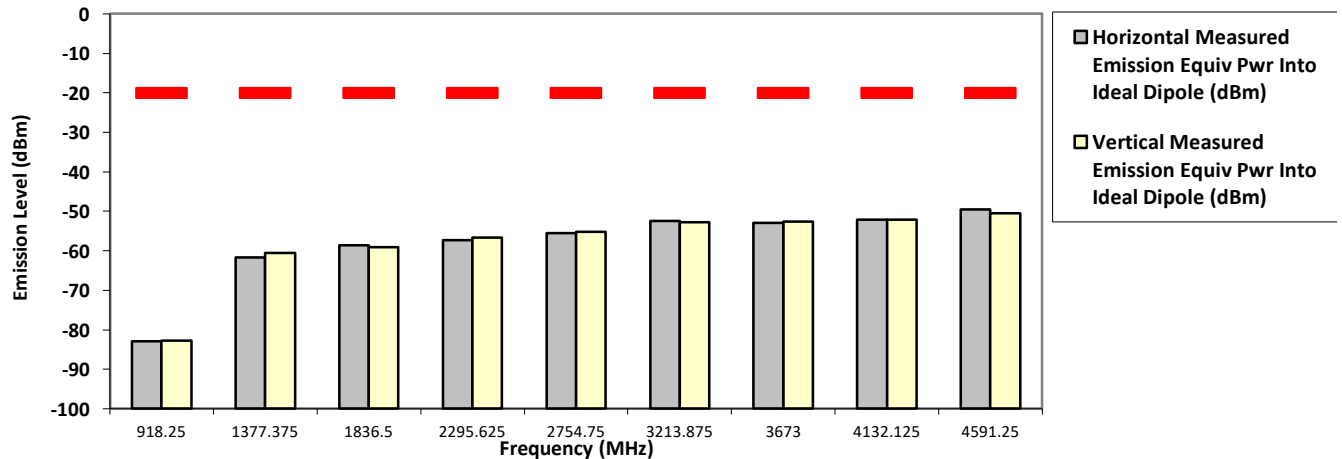

The data presented here was taken using the substitution method as found in the ANSI C63.26-2015 document.  
 Motorola Penang EMC Lab - Test Performed by: Azil & Qawiman      Fri, Jul 05, 2019

Remarks: \*\* Indicates the spurious emission could not be detected due to noise limitations or ambient.  
 \*Pursuant to CFR 47 Part 2.1057 ( c ), emissions attenuated more than 20 dB below the permissible limit are not reported  
 Temp(Deg): 23.6 Hum(%RH): 70.2

System MU: 5.01 dB

Remarks:	Passed Results	Marginal Results	Failed Results
----------	----------------	------------------	----------------

**SAC Transmitter Radiated Emission:**

Model Number: LAH87YDC9JA2AN      S/N: 278TVH0062      SR:09189-EMC-00019  
 Battery Part No: PMNN4476A      Accy Part No: NA  
 Test Mode: TX PCR Digital 4FSK  
 459.125000 MHz      12.5 kHz      4.800 Watt(s) /Max Power

Frequency (MHz)	Limit	Horizontal Measured Emission Equiv Pwr Into Ideal Dipole (dBm)	Vertical Measured Emission Equiv Pwr Into ideal Dipole (dBm)
918.2500	-20.0000	-82.0719 **	-81.2024 **
1377.3750	-20.0000	-61.2576 **	-59.5803 **
1836.5000	-20.0000	-59.4993 **	-59.1557 **
2295.6250	-20.0000	-56.9642 **	-57.1051 **
2754.7500	-20.0000	-55.0643 **	-55.1987 **
3213.8750	-20.0000	-52.4563 **	-52.5709 **
3673.0000	-20.0000	-53.8336 **	-53.0066 **
4132.1250	-20.0000	-50.7221 **	-51.8441 **
4591.2500	-20.0000	-49.6901 **	-50.5578 **

**RADIATED SPURIOUS EMISSIONS**

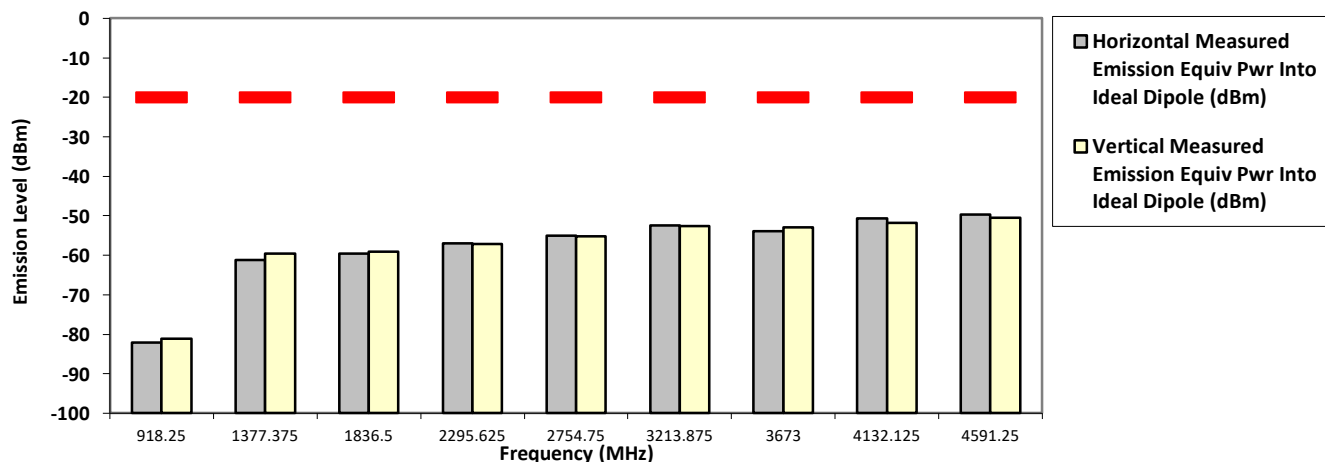

The data presented here was taken using the substitution method as found in the ANSI C63.26-2015 document.  
 Motorola Penang EMC Lab - Test Performed by: Azil & Qawiman      Fri, Jul 05, 2019

Remarks: \*\* Indicates the spurious emission could not be detected due to noise limitations or ambient.  
 \*Pursuant to CFR 47 Part 2.1057 ( c ), emissions attenuated more than 20 dB below the permissible limit are not reported  
 Temp(Deg): 23.6 Hum(%RH): 70.2

System MU: 5.01 dB

Remarks:	Passed Results	Marginal Results	Failed Results
----------	----------------	------------------	----------------



**SAC Transmitter Radiated Emission:**

Model Number: LAH87YDC9JA2AN      S/N: 278TVH0062      SR:09189-EMC-00019  
 Battery Part No: PMNN4476A      Accy Part No: NA  
 Test Mode: TX PCR Digital 4FSK  
 467.775000 MHz      12.5 kHz      1.000 Watt(s) /Low Power

Frequency (MHz)	Limit	Horizontal Measured Emission Equiv Pwr Into Ideal Dipole (dBm)	Vertical Measured Emission Equiv Pwr Into ideal Dipole (dBm)
935.5500	-20.0000	-82.2500 **	-82.4750 **
1403.3250	-20.0000	-60.5627 **	-60.4920 **
1871.1000	-20.0000	-56.8705 **	-58.0815 **
2338.8750	-20.0000	-55.9120 **	-56.7137 **
2806.6500	-20.0000	-54.6239 **	-54.3679 **
3274.4250	-20.0000	-52.7323 **	-52.7905 **
3742.2000	-20.0000	-52.8144 **	-53.3987 **
4209.9750	-20.0000	-52.1110 **	-51.0204 **
4677.7500	-20.0000	-50.4339 **	-51.0355 **

**RADIATED SPURIOUS EMISSIONS**

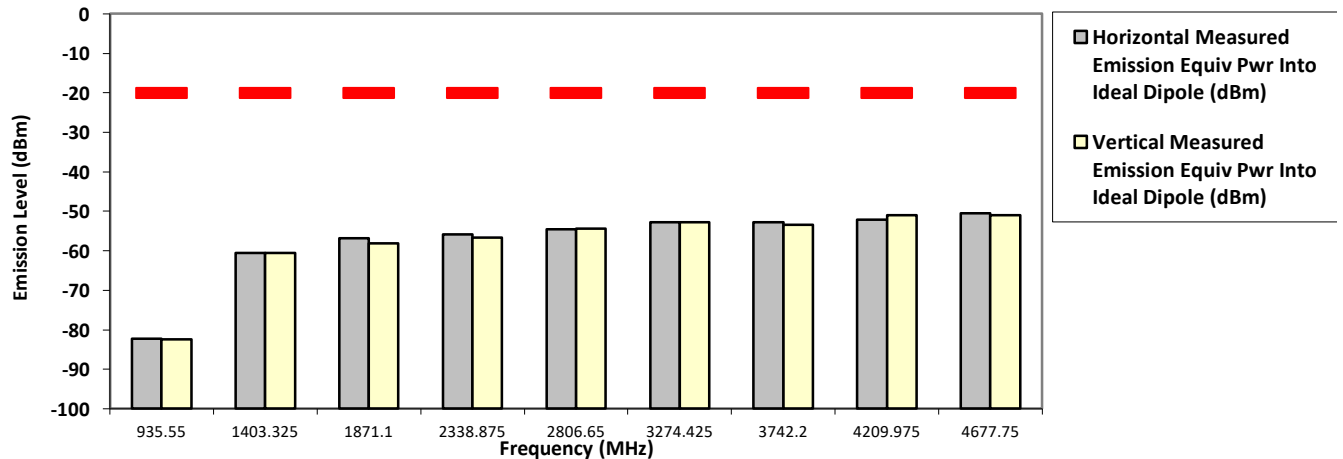

The data presented here was taken using the substitution method as found in the ANSI C63.26-2015 document.  
 Motorola Penang EMC Lab - Test Performed by: Azil & Qawiman      Fri, Jul 05, 2019

Remarks: \*\* Indicates the spurious emission could not be detected due to noise limitations or ambient.  
 \*Pursuant to CFR 47 Part 2.1057 ( c ), emissions attenuated more than 20 dB below the permissible limit are not reported  
 Temp(Deg): 23.6 Hum(%RH): 70.2

System MU: 5.01 dB

Remarks:

Passed Results	Marginal Results	Failed Results
----------------	------------------	----------------

**SAC Transmitter Radiated Emission:**

Model Number: LAH87YDC9JA2AN      S/N: 278TVH0062      SR:09189-EMC-00019  
 Battery Part No: PMNN4476A      Accy Part No: NA  
 Test Mode: TX PCR Digital 4FSK  
 467.775000 MHz      12.5 kHz      4.800 Watt(s) /Max Power

Frequency (MHz)	Limit	Horizontal Measured Emission Equiv Pwr Into Ideal Dipole (dBm)	Vertical Measured Emission Equiv Pwr Into ideal Dipole (dBm)
935.5500	-20.0000	-81.8865 **	-81.2329 **
1403.3250	-20.0000	-61.3628 **	-60.6091 **
1871.1000	-20.0000	-59.0575 **	-58.3708 **
2338.8750	-20.0000	-56.7473 **	-56.5934 **
2806.6500	-20.0000	-54.2263 **	-53.7525 **
3274.4250	-20.0000	-52.7018 **	-52.7416 **
3742.2000	-20.0000	-53.5199 **	-53.7040 **
4209.9750	-20.0000	-52.3338 **	-50.8539 **
4677.7500	-20.0000	-50.2899 **	-48.4597 **

**RADIATED SPURIOUS EMISSIONS**

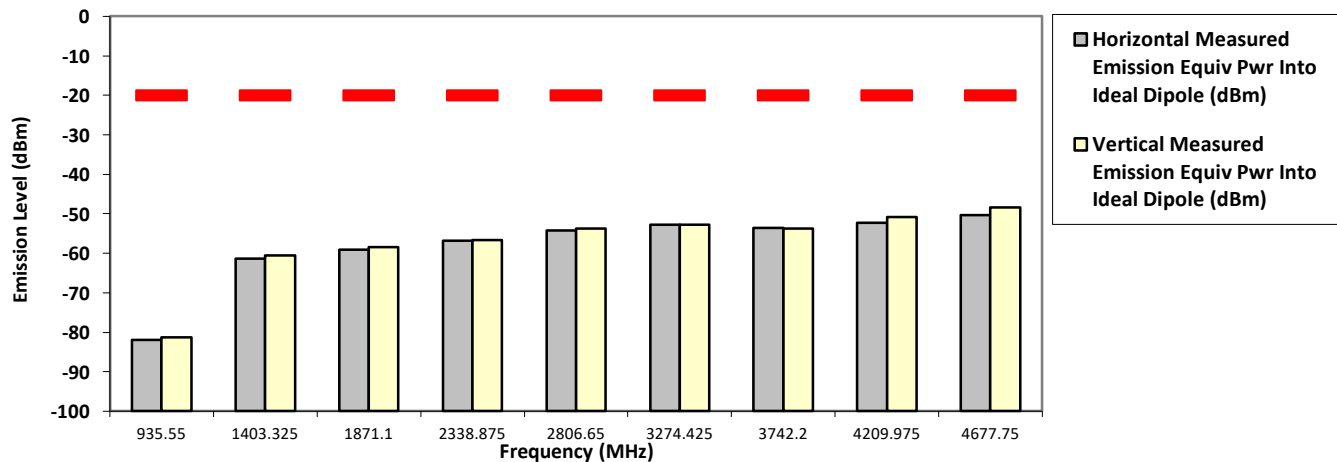

The data presented here was taken using the substitution method as found in the ANSI C63.26-2015 document.  
 Motorola Penang EMC Lab - Test Performed by: Azil & Qawiman      Fri, Jul 05, 2019

Remarks: \*\* Indicates the spurious emission could not be detected due to noise limitations or ambient.  
 \*Pursuant to CFR 47 Part 2.1057 ( c ), emissions attenuated more than 20 dB below the permissible limit are not reported  
 Temp(Deg): 23.6 Hum(%RH): 70.2

System MU: 5.01 dB

Remarks:	Passed Results	Marginal Results	Failed Results
----------	----------------	------------------	----------------

**SAC Transmitter Radiated Emission:**  
**Model Number: LAH87YDC9JA2AN**      **S/N: 278TVH0062**      **SR:09189-EMC-00019**  
**Battery Part No: PMNN4476A**      **Accy Part No: NA**  
**Test Mode: TX PCR Digital 4FSK**  
**479.987500 MHz**      **12.5 kHz**      **1.000 Watt(s) /Low Power**

Frequency (MHz)	Limit	Horizontal Measured Emission Equiv Pwr Into Ideal Dipole (dBm)	Vertical Measured Emission Equiv Pwr Into ideal Dipole (dBm)
959.9750	-20.0000	-81.3391 **	-81.7379 **
1439.9625	-20.0000	-60.3466 **	-59.8391 **
1919.9500	-20.0000	-55.7462 **	-57.1005 **
2399.9375	-20.0000	-54.2487 **	-56.5852 **
2879.9250	-20.0000	-54.0701 **	-55.2448 **
3359.9125	-20.0000	-52.2932 **	-53.6295 **
3839.9000	-20.0000	-52.3221 **	-51.9973 **
4319.8875	-20.0000	-52.4951 **	-51.0836 **
4799.8750	-20.0000	-50.0038 **	-49.2020 **

**RADIATED SPURIOUS EMISSIONS**

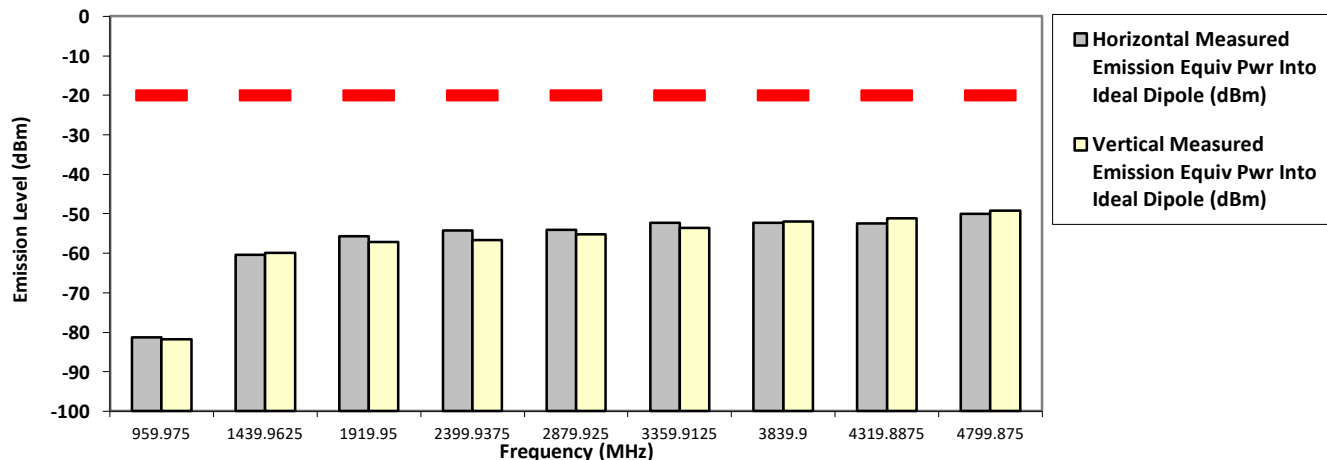

The data presented here was taken using the substitution method as found in the ANSI C63.26-2015 document.  
 Motorola Penang EMC Lab - Test Performed by: Azil & Qawiman      Fri, Jul 05, 2019

Remarks: \*\* Indicates the spurious emission could not be detected due to noise limitations or ambient.  
 \*Pursuant to CFR 47 Part 2.1057 ( c ), emissions attenuated more than 20 dB below the permissible limit are not reported  
 Temp(Deg): 23.6 Hum(%RH): 70.2

System MU: 5.01 dB

Remarks:	Passed Results	Marginal Results	Failed Results
----------	----------------	------------------	----------------

SAC Transmitter Radiated Emission:

Model Number: LAH87YDC9JA2AN

S/N: 278TVH0062

SR:09189-EMC-00019

Battery Part No: PMNN4476A

Accy Part No: NA

Test Mode: TX PCR Digital 4FSK

479.987500 MHz

12.5 kHz

4.800 Watt(s) /Max Power

Frequency (MHz)	Limit	Horizontal Measured Emission Equiv Pwr Into Ideal Dipole (dBm)	Vertical Measured Emission Equiv Pwr Into ideal Dipole (dBm)
959.9750	-20.0000	-81.5785 **	-81.3437 **
1439.9625	-20.0000	-60.8865 **	-60.6621 **
1919.9500	-20.0000	-57.7648 **	-56.8716 **
2399.9375	-20.0000	-56.7113 **	-56.0452 **
2879.9250	-20.0000	-55.3390 **	-54.4635 **
3359.9125	-20.0000	-52.5874 **	-53.4400 **
3839.9000	-20.0000	-52.3506 **	-52.2003 **
4319.8875	-20.0000	-51.3091 **	-51.7370 **
4799.8750	-20.0000	-49.9450 **	-50.5931 **

RADIATED SPURIOUS EMISSIONS

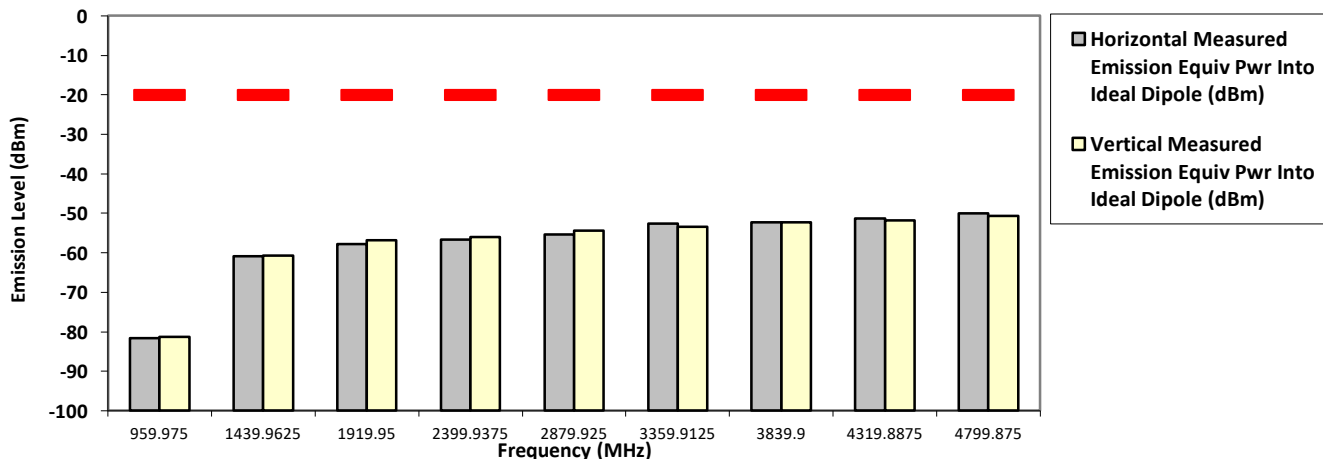

The data presented here was taken using the substitution method as found in the ANSI C63.26-2015 document.  
 Motorola Penang EMC Lab - Test Performed by: Azil & Qawiman Fri, Jul 05, 2019

Remarks: \*\* Indicates the spurious emission could not be detected due to noise limitations or ambient.

\*Pursuant to CFR 47 Part 2.1057 ( c ), emissions attenuated more than 20 dB below the permissible limit are not reported  
 Temp(Deg): 23.6 Hum(%RH): 70.2

System MU: 5.01 dB

Remarks:

Passed Results	Marginal Results	Failed Results
----------------	------------------	----------------

### 6.11.3. Test Limit

Table below summarized the power of any emission outside a licensee’s frequency block shall be attenuated below the transmitter power (P) by at least

Channel Spacing	Part 22	Part 24D	Part 74	Part 80	Part 90 (UHF, VHF, 800, 900)	Part 90 (700)
12.5kHz	43 + log <sub>10</sub> (P) (-13 dBm)	43 + log <sub>10</sub> (P) (-13 dBm)	43 + log <sub>10</sub> (P) (-13 dBm)	Not Applicable	50 + log <sub>10</sub> (P) (-20 dBm)	43 + log <sub>10</sub> (P) (-13 dBm)
25kHz		Not Applicable		43 + log <sub>10</sub> (P) (-13 dBm)	43 + log <sub>10</sub> (P) (-13 dBm)	43 + log <sub>10</sub> (P) (-13 dBm)

Channel Spacing	RSS 134	RSS 182	RSS 119 (UHF, VHF, 800, 900)	RSS 119 (700)
12.5kHz	43 + log <sub>10</sub> (P) (-13 dBm)	Not Applicable	50 + log <sub>10</sub> (P) (-20 dBm)	43 + log <sub>10</sub> (P) (-13 dBm)
25kHz	Not Applicable	43 + log <sub>10</sub> (P) (-13 dBm)	43 + log <sub>10</sub> (P) (-13 dBm)	43 + log <sub>10</sub> (P) (-13 dBm)

## 6.12. Effective Radiated Power (ERP)

### 6.12.1. Test Setup

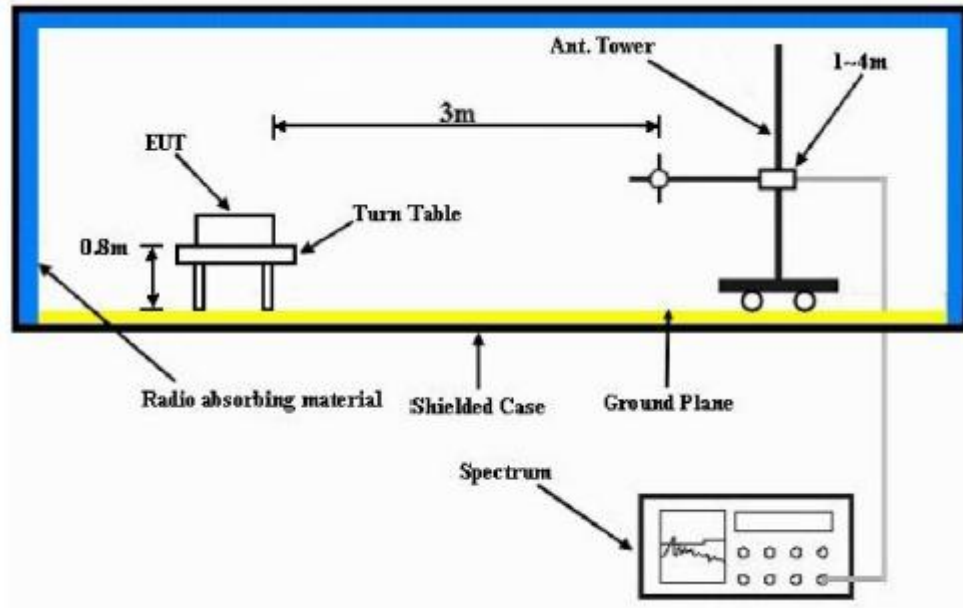

- 1) The Resolution Bandwidth for Equivalent Radiated Power (ERP) below 1 GHz is 100 kHz with Video Bandwidth = 300 kHz and Resolution Bandwidth for EIRP above 1 GHz is 1 MHz with Video Bandwidth = 3 MHz. Detector Mode is RMS.
- 2) In the semi-anechoic chamber, setup as illustrated above the DUT placed on the 0.8m height of Turn Table, rotated the table 45 degree each interval to search the maximum radiation power and receiver antenna shall be rotated vertical and horizontal polarization and moved height from 1m to 4m to find the maximum polar radiated power for each degree interval. The “Read Value” is the spectrum reading of maximum power value.
- 3) The substitution antenna is substituted for DUT at the same position and signals generator (S.G) export the CW signal to the substitution antenna via a TX cable. The receiver antenna shall be rotated vertical and horizontal polarization and moved height from 1m to 4m to find the maximum radiation power. Record the power level of maximum radiation power from spectrum. So, the Measured substitution value = Ref level of S.G + TX cables loss – Substituted Antenna Gain.

### 6.12.2. Test Result

NA → Not Applicable

### 6.12.3. Test Limit

The maximum output power of the transmitter for mobile stations is 100 watts (20 dB). Power is given in terms of effective radiated power (ERP).

### 6.13. GNSS (EIRP for 1559 - 1610MHz)

#### 6.13.1. Test Setup

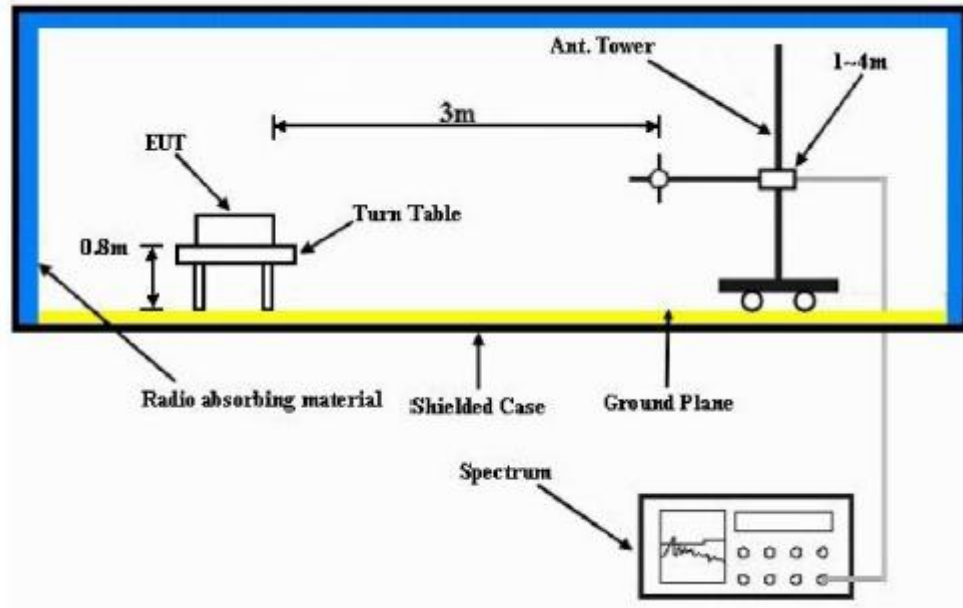

- 4) The Resolution Bandwidth for Equivalent Isotropically Radiated Power (EIRP) below 1 GHz is 100 kHz with Video Bandwidth = 300 kHz and Resolution Bandwidth for EIRP above 1 GHz is 1 MHz with Video Bandwidth = 3 MHz. Detector Mode is RMS.
- 5) In the semi-anechoic chamber, setup as illustrated above the DUT placed on the 0.8m height of Turn Table, rotated the table 45 degree each interval to search the maximum radiation power and receiver antenna shall be rotated vertical and horizontal polarization and moved height from 1m to 4m to find the maximum polar radiated power for each degree interval. The “Read Value” is the spectrum reading of maximum power value.
- 6) The substitution antenna is substituted for DUT at the same position and signals generator (S.G) export the CW signal to the substitution antenna via a TX cable. The receiver antenna shall be rotated vertical and horizontal polarization and moved height from 1m to 4m to find the maximum radiation power. Record the power level of maximum radiation power from spectrum. So, the Measured substitution value = Ref level of S.G + TX cables loss – Substituted Antenna Gain.
- 7)  $EIRP = \text{“Read Value”} + \text{Measured substitution value} + 2.15$ .

#### 6.13.1. Test Result

**NA → Not Applicable**

**6.13.2. Test Limit**

For operations in the 758-775 MHz and 788-805 MHz bands, all emissions including harmonics in the band 1559-1610 MHz shall be limited to  $-70$  dBW/MHz equivalent isotropically radiated power (EIRP) for wideband signals, and  $-80$  dBW EIRP for discrete emissions of less than 700 Hz bandwidth.

**~ End of Report ~**