

	   <p>CERTIFICATE 2518.08</p> <p>MS ISO/IEC 17025          TESTING          SAMM.NO. 0825</p>																																	
<p><b>MOTOROLA PENANG ADV. COMM. LABORATORY</b>          Motorola Solutions Malaysia Sdn Bhd          Plot 2A, Medan Bayan Lepas,          Mukim 12 SWD, 11900 Bayan Lepas,          Penang, Malaysia.</p>	<p><b>FCC / ISED TEST REPORT</b>          Report Revision : Rev.C</p>																																	
<table> <tr> <td><b>Date/s Tested</b></td> <td>: 6-JAN-2020 - 10-JAN-2020</td> <td rowspan="12" style="text-align: center; vertical-align: middle;">  </td> </tr> <tr> <td><b>Report Issue Date</b></td> <td>: 18-FEB-2020</td> </tr> <tr> <td><b>Manufacturer</b></td> <td>: Motorola Solutions Malaysia SDN BHD</td> </tr> <tr> <td><b>Manufacturer Address</b></td> <td>: Plot 2A, Medan Bayan Lepas, Mukim 12 SWD, 11900 Bayan Lepas, Penang, Malaysia</td> </tr> <tr> <td><b>Requestor</b></td> <td>: HENG TUCK CHANG</td> </tr> <tr> <td><b>Product Type</b></td> <td>: Portable</td> </tr> <tr> <td><b>Product Version (PMN)</b></td> <td>: CP100d</td> </tr> <tr> <td><b>Model Number(HVIN)</b></td> <td>: AAH87JDF9JA2AN</td> </tr> <tr> <td><b>Frequency Band</b></td> <td>: 136-174MHz</td> </tr> <tr> <td><b>Firmware Version(FVIN)</b></td> <td>: D01.01.50.0039</td> </tr> <tr> <td><b>Max RF Output Power</b></td> <td>: 6Watts</td> </tr> <tr> <td><b>Applicant Name</b></td> <td>: Motorola Solutions Inc</td> </tr> <tr> <td><b>Applicant Address</b></td> <td>: 8000 West Sunrise Boulevard, Fort Lauderdale, Florida 33322.</td> </tr> <tr> <td><b>ISED Registrations</b></td> <td>: MY0001</td> </tr> <tr> <td><b>FCC Registrations</b></td> <td>: 461337</td> </tr> </table> <p><b>The equipment was tested accordance to the requirement listed below:</b></p> <table> <tr> <td>(LMR )                  FCC 47 CFR Part 2/ 22 / 90                  ISED RSS- Gen Issue 5 / 119 Issue 12</td> <td style="text-align: right; vertical-align: top;"><b>PASS</b></td> </tr> </table>		<b>Date/s Tested</b>	: 6-JAN-2020 - 10-JAN-2020		<b>Report Issue Date</b>	: 18-FEB-2020	<b>Manufacturer</b>	: Motorola Solutions Malaysia SDN BHD	<b>Manufacturer Address</b>	: Plot 2A, Medan Bayan Lepas, Mukim 12 SWD, 11900 Bayan Lepas, Penang, Malaysia	<b>Requestor</b>	: HENG TUCK CHANG	<b>Product Type</b>	: Portable	<b>Product Version (PMN)</b>	: CP100d	<b>Model Number(HVIN)</b>	: AAH87JDF9JA2AN	<b>Frequency Band</b>	: 136-174MHz	<b>Firmware Version(FVIN)</b>	: D01.01.50.0039	<b>Max RF Output Power</b>	: 6Watts	<b>Applicant Name</b>	: Motorola Solutions Inc	<b>Applicant Address</b>	: 8000 West Sunrise Boulevard, Fort Lauderdale, Florida 33322.	<b>ISED Registrations</b>	: MY0001	<b>FCC Registrations</b>	: 461337	(LMR ) FCC 47 CFR Part 2/ 22 / 90 ISED RSS- Gen Issue 5 / 119 Issue 12	<b>PASS</b>
<b>Date/s Tested</b>	: 6-JAN-2020 - 10-JAN-2020																																	
<b>Report Issue Date</b>	: 18-FEB-2020																																	
<b>Manufacturer</b>	: Motorola Solutions Malaysia SDN BHD																																	
<b>Manufacturer Address</b>	: Plot 2A, Medan Bayan Lepas, Mukim 12 SWD, 11900 Bayan Lepas, Penang, Malaysia																																	
<b>Requestor</b>	: HENG TUCK CHANG																																	
<b>Product Type</b>	: Portable																																	
<b>Product Version (PMN)</b>	: CP100d																																	
<b>Model Number(HVIN)</b>	: AAH87JDF9JA2AN																																	
<b>Frequency Band</b>	: 136-174MHz																																	
<b>Firmware Version(FVIN)</b>	: D01.01.50.0039																																	
<b>Max RF Output Power</b>	: 6Watts																																	
<b>Applicant Name</b>	: Motorola Solutions Inc																																	
<b>Applicant Address</b>	: 8000 West Sunrise Boulevard, Fort Lauderdale, Florida 33322.																																	
<b>ISED Registrations</b>	: MY0001																																	
<b>FCC Registrations</b>	: 461337																																	
(LMR ) FCC 47 CFR Part 2/ 22 / 90 ISED RSS- Gen Issue 5 / 119 Issue 12	<b>PASS</b>																																	
<p>This report shall not be reproduced without written approval from an officially designated representative of the Motorola Penang Adv. Comm. Laboratory. The results and statements contained in this report pertain only to the device(s) evaluated.</p>																																		
<p>Prepared By:</p> <p style="text-align: center;"></p> <hr/> <p><b>AARON GOH</b>          Test Personnel</p>	<p>Approved Signatory:</p> <hr/> <p><b>VINCENT FOONG CHUEN KIT</b>          Deputy Technical Manager</p>																																	

# Table of Contents

Report Revision History .....	3
1.0 General Information.....	4
2.0 Summary of Test Results.....	5
3.0 Measurement Uncertainty.....	6
4.0 Equipment List.....	7
5.0 Test Condition.....	11
5.1. Transmitter Test Conditions .....	11
6.0 Transmitter Test Parameters .....	12
6.1. RF Output Power .....	12
6.1.1. Test Setup.....	12
6.1.2. Test Result .....	12
6.2. Frequency Stability .....	13
6.2.1. Test Setup.....	13
6.2.2. Test Result .....	14
6.2.3. Test Limit.....	15
6.3. Audio Frequency Response .....	16
6.3.1. Test Setup.....	16
6.3.2. Test Result .....	17
6.3.3. Test Limit.....	18
6.4. Audio Low Pass Filter Response .....	19
6.4.1. Test Setup.....	19
6.4.2. Test Result .....	20
6.4.3. Test Limit.....	21
6.5. Modulation Limiting.....	22
6.5.1. Test Setup.....	22
6.5.2. Test Result .....	23
6.5.3. Test Limit.....	24
6.6. Occupied Bandwidth.....	25
6.6.1. Test Setup (Analog) .....	25
6.6.2. Test Result (Analog).....	26
6.6.3. Test Setup (Digital).....	32
6.6.4. Test Result (Digital).....	33
6.6.5. Test Limit.....	40
6.7. Band Edge Conducted Spurious Emission (Part 22) .....	41
6.7.1. Test Setup (Analog) .....	41
6.7.2. Test Result (Analog).....	42
6.7.3. Test Setup (Digital).....	43
6.7.4. Test Result (Digital).....	44
6.7.5. Test Limit.....	46
6.8. Transient Frequency Behavior.....	47
6.8.1. Test Setup.....	47
6.8.2. Test Result .....	48
6.8.3. Test Limit.....	50

6.9. Adjacent Channel Power..... 51  
 6.9.1. Test Setup (Analog) ..... 51  
 6.9.2. Test Result(Analog)..... 51  
 6.9.3. Test Setup (Digital)..... 52  
 6.9.4. Test Result (Digital)..... 52  
 6.9.5. Test limit ..... 53  
 6.10. Conducted Spurious Emission ..... 55  
 6.10.1. Test Setup..... 55  
 6.10.2. Test Result (Analog)..... 56  
 6.10.3. Test Result (Digital)..... 62  
 6.10.4. Test Limit..... 68  
 6.11. Radiated Spurious Emission ..... 69  
 6.11.1. Test Setup..... 69  
 6.11.1. Test Result (Analog)..... 70  
 6.11.2. Test Result (Digital)..... 75  
 6.11.3. Test Limit..... 80  
 6.12. Effective Radiated Power (ERP) ..... 82  
 6.12.1. Test Setup..... 82  
 6.12.2. Test Result ..... 82  
 6.12.3. Test Limit..... 82  
 6.13. GNSS (EIRP for 1559 - 1610MHz)..... 83  
 6.13.1. Test Setup..... 83  
 6.13.2. Test Result ..... 83  
 6.13.3. Test Limit..... 84

**Report Revision History**

<b>Revision History</b>	<b>Description</b>	<b>Date</b>	<b>Originator</b>
Rev. A	Initial Report	18-FEB-2020	Aaron Goh
Rev.B	Added Carson’s rule	21-APR-2020	Vincent Foong
Rev.C	Amended incorrect test date, updated emission designator	29-APR-2020	Vincent Foong

## 1.0 General Information

### EUT Description:

<b>Technologies</b>	Land Mobile Radio (LMR)
<b>Modulation Type</b>	Analog, 4FSK

The EUT contains following accessory devices and data cable:

<b>Item</b>	<b>Brand</b>	<b>Model or P/N</b>
BATTERY	MOTOROLA	PMNN4080AR

### General Description of Applied Standards

The EUT is a RF Product. According to the specifications of the manufacturer, the EUT is to comply with the requirements of the following standards:

**ANSI C63.4-2014**  
**ANSI C63.26-2015**

No modifications were done to the UUT to facilitate the tests in this report.

### Deviation from standard

Not applicable as no deviation from standard test method

## 2.0 Summary of Test Results

FCC General Rules Part (47CFR)	ISED General Rules Part	Test Item	Result	Remark	Serial number tested
2.1046, 90.541(700MHz), 22.565,74.461, 74.534, 80.215,80,90,22	RSS-119 RSS-182	RF Power Output	Pass	-	278TVZ3115 278TVZ3117
2.1055, 90.213, 22.355	RSS-119	Frequency Stability	Pass	-	278TVZ3115 278TVZ3117
2.1047,74.463, 80.213, 22,90,80	RSS-119	Audio Frequency Response	Pass	-	278TVZ3115 278TVZ3117
2.1047,74.463, 80.213, 22,90,80	RSS-119	Audio Low Pass Filter Response	Pass	-	278TVZ3115 278TVZ3117
2.1047,74.463, 80.213, 22,90,80	RSS-119	Modulation limiting	Pass	-	278TVZ3115 278TVZ3117
2.1049,90.210, 22.359,74.462(c), 80.211(c),90.210, 80.211(f),22.359(b)	RSS-119 RSS-182	Occupied Bandwidth	Pass	16K0F3E-15.0292kHz 11K0F3E-9.9001kHz 7K60F1D/7K60FXD-7.3778kHz 7K60F1E/7K60FXE-7.1893kHz 7K60F1W-7.5253kHz	278TVZ3115 278TVZ3117
22.359(a),(b)	RSS-119	Band Edge Conducted Spurious Emission	Pass	-	278TVZ3115 278TVZ3117
90.214	RSS-119	Transient Frequency Behavior	Pass	-	278TVZ3115 278TVZ3117
-	-	Adjacent Channel Power	NA	-	-
Low end of the band,22,90,74D, 74H,80	RSS-119 RSS-182	Conducted Spurious Emissions	Pass	No spur detected (noise floor)	278TVZ3115 278TVZ3117
Low end of the band,22,90,74D, 74H,80	RSS-119 RSS-182	Radiated Spurious Emission	Pass	No spur detected (noise floor)	278TVZ3108
-	-	GNSS (EIRP for 1559 – 1610MHz)	NA	-	-
-	-	Effective Radiated Power (ERP)	NA	-	-

NA → Not Applicable

### 3.0 Measurement Uncertainty

Measurement	Frequency	Expanded Uncertainty (k=1.96) (±)
AC Power Line Conducted Spurious Emission	150KHz ~ 30MHz	3.43
Radiated Emissions up to 1 GHz	30MHz ~ 200MHz	4.03
	200MHz ~ 1000MHz	4.03
Radiated Emissions above 1 GHz	1GHz ~ 18GHz	4.03
	18GHz ~ 25GHz	4.03
Conducted Spurious Emissions	9kHz ~ 12.75GHz	2.82

#### 4.0 Equipment List

##### FCC Analog ATE#1: (SW version: 2.4.5 & FCC\_Frequency Stability 1.0.3 rev.)

Description	Model	Serial Number	Calibration Date	Calibration Due Date
AUDIO ANALYZER	8903B	3729A17612	15-Nov-17	15-Nov-20
SIGNAL GENERATOR	2042	203002/747	22-Jan-19	22-Jan-20
MODULATION ANALYZER	8901B	3538A5696	4-Apr-19	4-Apr-20
DSA Dynamic Signal Analyzer	36570A	MY42506790	4-Apr-19	4-Apr-20
POWER SENSOR	E4412A	MY41502652	31-Jul-19	31-Jul-20
POWER METER	E4416A	GB41293747	19-Nov-18	19-Nov-20
POWER SUPPLY	6623A	2916A01562	31-Mar-19	31-Mar-20
CHAMBER	SH-641	92009188	29-Mar-19	29-Mar-20
N to N RF Cable # 1	M17/128-RG400	NA	NA	NA
BNC to N RF Cable # 1	RG 58	NA	NA	NA
BNC to BNC RF Cable # 1	RG 58	NA	NA	NA
BNC to BNC RF Cable # 2	RG 58	NA	NA	NA
BNC to BNC RF Cable # 3	RG 58	NA	NA	NA
BNC to BNC RF Cable # 4	RG 58	NA	NA	NA
BNC to BNC RF Cable # 5	RG 58	NA	NA	NA
BNC to BNC RF Cable # 6	RG 58	NA	NA	NA
BNC to BNC RF Cable # 7	RG 58	NA	NA	NA
N to SMA RF Cable # 1	RG 58	NA	NA	NA
N to SMA RF Cable # 2	RG 58	NA	NA	NA
N to SMA RF Cable # 3	RG 58	NA	NA	NA
Aeroflex Attenuator 30dB	49-30-34-LIM	NA	NA	NA

**FCC Transient ATE #1: (SW version: FCC Transient ATE\_R1.1.2)**

Description	Model	Serial Number	Calibration Date	Calibration Due Date
POWER SUPPLY	6031A	2430A00146	5-Apr-19	5-Apr-20
POWER SENSOR	E4412A	MY41498918	31-Jul-19	31-Jul-20
POWER METER	E4416A	GB41293866	26-Feb-19	26-Feb-21
ATTENUATORS/SWITCH DRIVER	11713A	2508A10141	CNR	CNR
STEP ATTENUATOR/11dB	8494G	MY42143870	17-May-19	17-May-20
STEP ATTENUATOR/110dB	8496G	MY42143622	17-May-19	17-May-20
OSCILLOSCOPE	MSO8104A	MY45002372	17-Jun-19	17-Jun-20
AUDIO ANALYZER	8903B	3011A08952	5-Jul-19	5-Jul-20
AUDIO ANALYZER	8903B	3729A17409	4-Jul-19	4-Jul-20
MODULATION ANALYZER	8901B	3226A04052	3-Apr-19	3-Apr-20
SIGNAL GENERATOR	8657B	3427U06025	5-Apr-19	5-Apr-20
SPECTRUM ANALYZER	E4440A	MY48250517	1-Aug-19	1-Aug-20
N to N RF Cable # 1	SF126/11N/11N	NA	NA	NA
N to N RF Cable # 2	M17/128-RG400	NA	NA	NA
N to N RF Cable # 3	M17/128-RG400	NA	NA	NA
N to N RF Cable # 4	M17/128-RG400	NA	NA	NA
N to N RF Cable # 5	M17/128-RG400	NA	NA	NA
N to N RF Cable # 6	M17/128-RG400	NA	NA	NA
N to N RF Cable # 7	M17/128-RG400	NA	NA	NA
N to N RF Cable # 8	M17/128-RG400	NA	NA	NA
N to N RF Cable # 9	M17/128-RG400	NA	NA	NA
BNC to BNC RF Cable # 1	RG 58	NA	NA	NA
BNC to BNC RF Cable # 2	RG 58	NA	NA	NA
BNC to BNC RF Cable # 3	RG 58	NA	NA	NA
BNC to BNC RF Cable # 4	RG 58	NA	NA	NA
BNC to BNC RF Cable # 5	RG 58	NA	NA	NA
BNC to BNC RF Cable # 6	RG 58	NA	NA	NA
BNC to N RF Cable # 1	RG 58	NA	NA	NA
Aeroflex Attenuator 10dB	49-10-43-LIM	NA	NA	NA
Aeroflex Attenuator 10dB	33-10-34-LIM	NA	NA	NA



SWITCH CONTROL UNIT	3488A	2719A36210	CNR	CNR
---------------------	-------	------------	-----	-----

**CONDUCTED SPUR EMISSION ATE # 1 (SW version: Conducted Spur ATE rev 1.23.02)**

Description	Model	Serial Number	Calibration Date	Calibration Due Date
SWITCH CONTROL UNIT	3488A	2719A32735	CNR	CNR
PSA Series Spectrum Analyzer	E4445A	MY46181732	12-Mar-19	12-Mar-21
POWER SUPPLY	6032A	2723A02219	2-Jul-19	2-Jul-20
HIGH PASS FILTER SWITCH BOX	-	CS001	4-Jul-19	4-Jul-20
N to N RF Cable # 1	SF126/11N/11N	NA	NA	NA
N to N RF Cable # 2	SF126/11N/11N	NA	NA	NA
BNC to BNC RF Cable # 1	RG 58	NA	NA	NA
Aeroflex Attenuator 30dB	49-30-43-LIM	NA	NA	NA
Aeroflex Attenuator 10dB	33-10-34-LIM	NA	NA	NA

**Radiated Emission: EMC Chamber 1**

DESCRIPTION	MODEL	SERIAL NUMBER	CALIBRATION DATE	CALIBRATION DUE DATE
DRG HORN_FREQ.	SAS-571	720	21-Mar-19	21-Mar-21
DRG HORN_FREQ.	SAS-571	1143	14-Feb-19	14-Feb-21
POWER SUPPLY ( 0-60V / 0-50A, 1000W )	6032A	MY41001736	25-May-19	25-May-20
SIGNAL GENERATOR	SMB 100A	181117	8-Nov-18	8-Nov-21
EMI TEST RECEIVER	ESW44	101750	24-Jul-19	24-Jul-20
EMI TEST RECEIVER	ESIB26	100017	19-Jul-19	19-Jul-20
5m Semi-anechoic Chamber	S800-HX	J2308	No Cal. Req'd	No Cal. Req'd
BILOG ANTENNA	CBL6112D	30991	5-Aug-19	5-Aug-20
BILOG ANTENNA	CBL6112B	2964	16-Feb-18	16-Feb-20
DATA LOGGER	SDL500	A.016800	19-Mar-19	18-Mar-20
SYSTEM CONTROLLER	SC104V	050806-1	No Cal. Req'd	No Cal. Req'd
TURNTABLE FLUSH MOUNT 2M	FM2011	NA	No Cal. Req'd	No Cal. Req'd
ANTENNA POSITIONING TOWER	TLT2	NA	No Cal. Req'd	No Cal. Req'd
BROAD-BAND HORN ANTENNA	BBHA9170	BBHA9170143	23-Jun-19	23-Jun-20
18 - 40GHz PREAMPLIFIER	Miteq Hi Gain Sucoflex	001	No Cal. Req'd	No Cal. Req'd
PREAMPLIFIER	PAM-0118	269	24-May-19	24-May-20
LOOP ANTENNA	6502	00208416	5-Sep-19	5-Sep-20
Test Software	EMC_FCC_IC_Bluetooth_RE_Test			
Version	EMC FCC RE v1.6.1			

**CNR → Calibration Not Required**

## 5.0 Test Condition

### 5.1. Transmitter Test Conditions

Test Item, (Channel Spacing)	Power(W)	Modulation	Test Frequency (MHz)	Tested By	Environmental Conditions
RF Output Power	Low & Max	Analog	138.0125,157.77,158.55,158.67,161.7,173.3875	AARON GOH	28.1°C, 64.2%RH
Frequency Stability	Max	Analog	158.55	AARON GOH	25.1°C, 54.3%RH, 60.3°C, 50%RH, -30.1°C, 50%RH
Audio Frequency Response (12.5kHz / 25kHz)	Max	Analog	158.55	AARON GOH	28.1°C, 64.2%RH
Audio Low Pass Filter Response (12.5kHz / 25kHz)	Max	Analog	158.55	AARON GOH	28.1°C, 64.2%RH
Modulation limiting (12.5kHz / 25kHz)	Max	Analog	158.55	AARON GOH	28.1°C, 64.2%RH
Occupied Bandwidth (12.5kHz / 25kHz)	Max	Analog, 4SFK	138.0125,158.55, 161.7, 173.3875	AARON GOH	28.1°C, 64.2%RH
Band Edge Conducted Spurious Emissions (Part 22) (12.5kHz / 20kHz / 25kHz)	Max	Analog, 4SFK	157.77,158.67	AARON GOH	28.1°C, 64.2%RH
Transient Frequency Behavior (UHF & VHF Band) (12.5kHz / 25kHz)	Max	Analog	158.55	AARON GOH	28.1°C, 64.2%RH
Adjacent Channel Power (700MHz Band) (12.5kHz)	Max	Analog	NA	NA	NA
Conducted Spurious Emissions- (12.5kHz / 25kHz)	Low / Max	Analog, 4SFK	138.0125,158.55, 161.7, 173.3875	AARON GOH	28.1°C, 64.2%RH
Radiated Spurious Emission (12.5kHz / 25kHz)	Low / Max	Analog, 4SFK	138.0125, 158.55,161.7, 173.3875	Nazrin&Azil	22.8°C, 70.1%RH
GNSS (EIRP for 1559 - 1610MHz) (12.5kHz / 25kHz)	Max	Analog	NA	NA	NA
Effective Radiated Power (ERP) (12.5kHz / 25kHz)	Max	Analog	NA	NA	NA

NA → Not Applicable

## 6.0 Transmitter Test Parameters

### 6.1 RF Output Power

#### 6.1.1 Test Setup

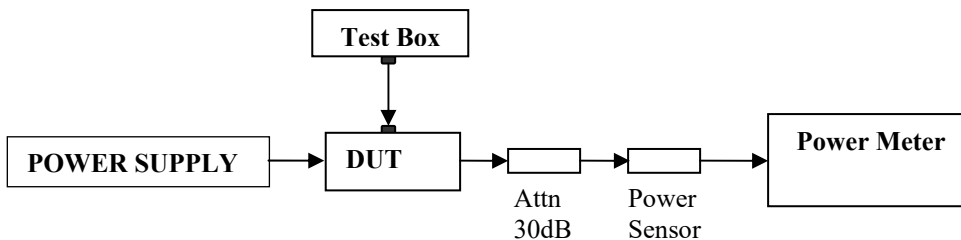

- 1) The DUT transmitter connected to Power Meter using the 30 dB attenuator and power sensor with above setup.
- 2) Path loss for the measurement included.
- 3) All the measurement was done at low, mid, high frequency for each band.
- 4) Record the power into the test report.

#### 6.1.2 Test Result

Temperature	25°C				Remarks
Voltage (V)	7.5V				
Frequency (MHz)	Low Power (W)	Current (A)	Max Power (W)	Current (A)	
138.0125	0.99	0.45	5.77	1.47	
157.77	0.96	0.30	5.94	0.99	
158.55	0.99	0.30	5.92	1.02	
158.67	0.98	0.30	5.92	1.02	
161.7	0.97	0.36	5.83	1.08	
173.3875	0.99	0.48	5.8	1.62	

## 6.2. Frequency Stability

### 6.2.1. Test Setup

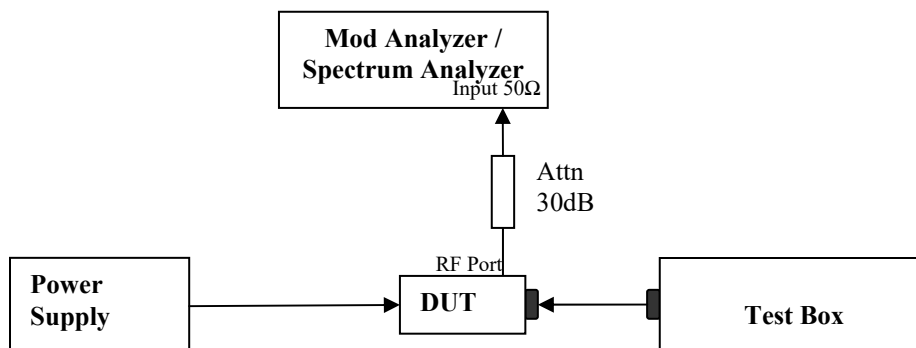

- 1) The DUT transmitter output port was connected to Modulation / Spectrum Analyzer.
- 2) Path loss for the measurement included.
- 3) Transmit the DUT and record the freq in  $MCF_{MHz}$ .
- 4) Test in 2 conditions:
  - Temperature: The frequency of the transmitter was measured from -30°C to 50°C.
  - Supply Voltage:
    - Mobile: The frequency of the transmitter was measured from 85% to 115% of the nominal operating input voltage.
    - Portable: The frequency of the transmitter was measured from nominal  $\pm x$  % as specified by the manufacturer
- 5) Calculate the ppm frequency error by the following:

$$ppm\ error = \left( \frac{MCF_{MHz}}{ACF_{MHz}} - 1 \right) * 10^6$$

Where:  $MCF_{MHz}$  is the Measured Carrier Frequency in MHz  
 $ACF_{MHz}$  is the Assigned Carrier Frequency in MHz

**6.2.2. Test Result**

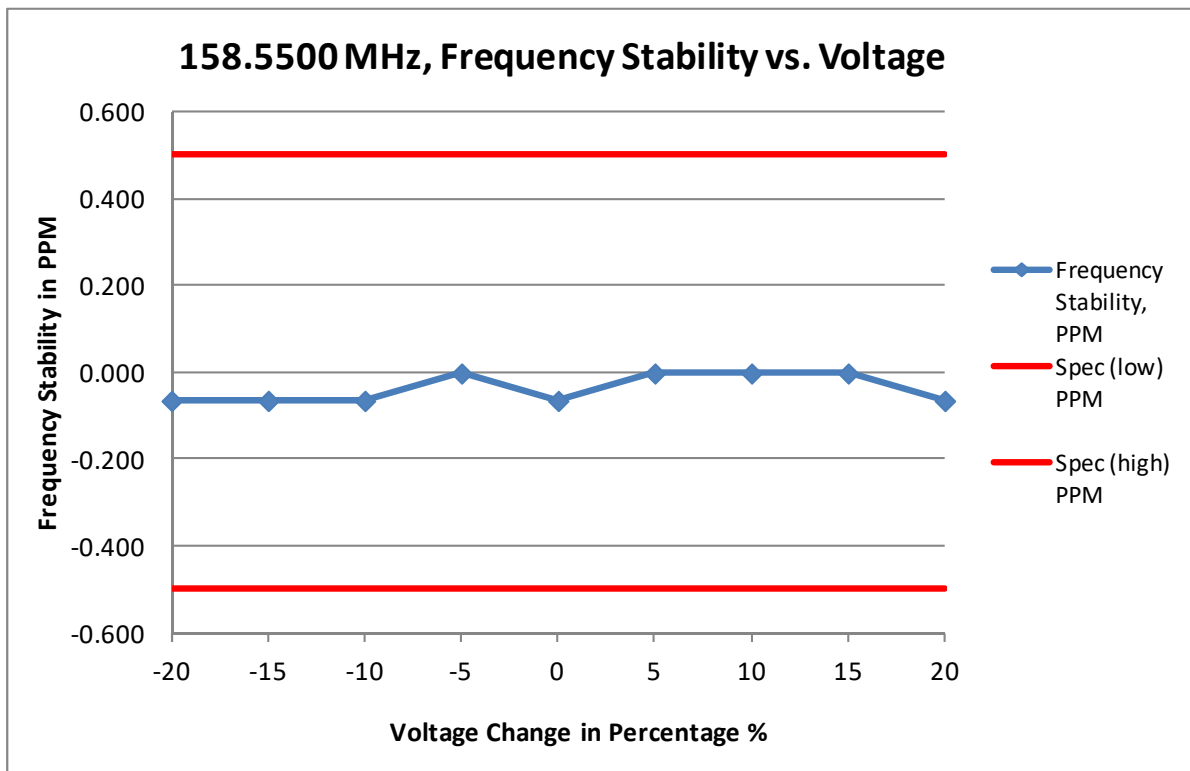

Frequency / Channel Spacing	158.5500 MHz / 12.5 kHz				
Temperature, °C	25				
Voltage %	Voltage, V	Frequency, MHz	Frequency Stability, PPM	Spec (low) PPM	Spec (high) PPM
-20	6.000	158.549990	-0.063	-0.500	0.500
-15	6.375	158.549990	-0.063	-0.500	0.500
-10	6.750	158.549990	-0.063	-0.500	0.500
-5	7.125	158.550000	0.000	-0.500	0.500
0	7.500	158.549990	-0.063	-0.500	0.500
5	7.875	158.550000	0.000	-0.500	0.500
10	8.250	158.550000	0.000	-0.500	0.500
15	8.625	158.550000	0.000	-0.500	0.500
20	9.000	158.549990	-0.063	-0.500	0.500

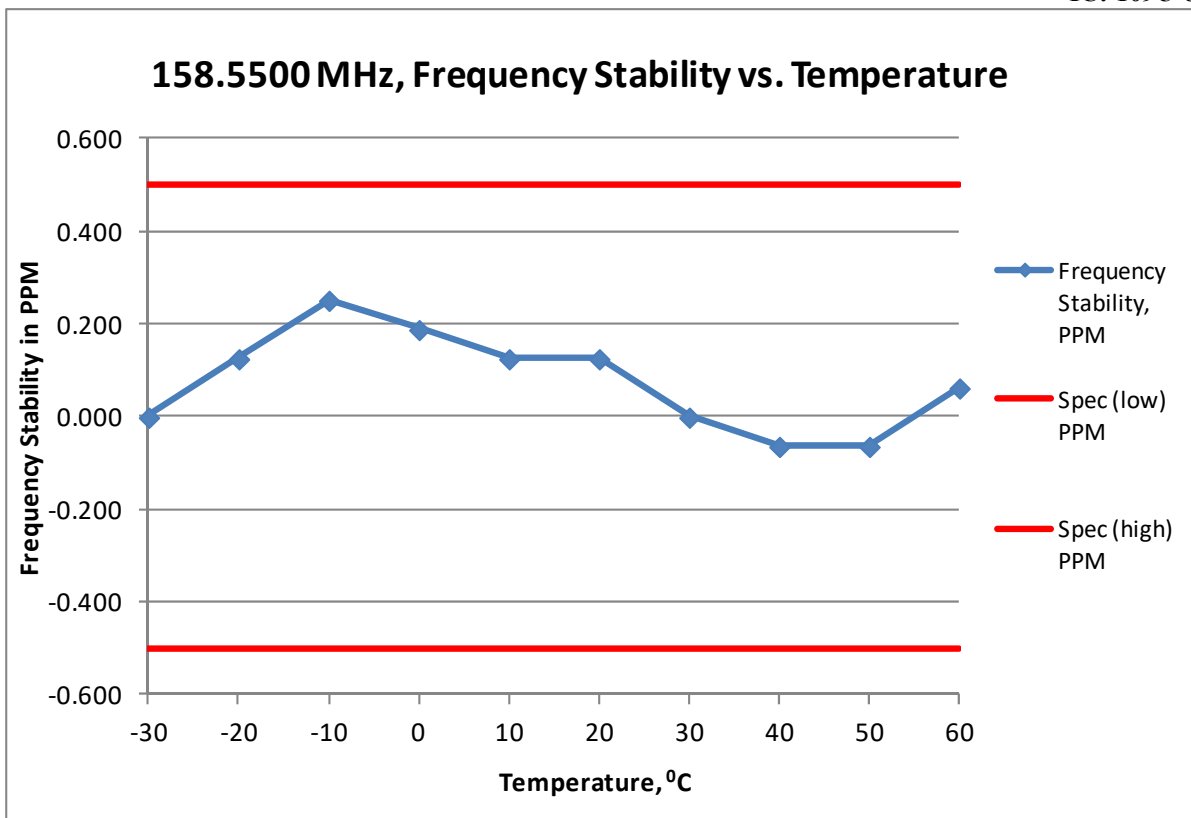

Frequency / Channel Spacing	158.5500 MHz / 12.5 kHz			
Voltage, V	7.5			
Temperature, °C	Frequency, MHz	Frequency Stability, PPM	Spec (low) PPM	Spec (high) PPM
-30	158.550000	0.000	-0.500	0.500
-20	158.550020	0.126	-0.500	0.500
-10	158.550040	0.252	-0.500	0.500
0	158.550030	0.189	-0.500	0.500
10	158.550020	0.126	-0.500	0.500
20	158.550020	0.126	-0.500	0.500
30	158.550000	0.000	-0.500	0.500
40	158.549990	-0.063	-0.500	0.500
50	158.549990	-0.063	-0.500	0.500
60	158.550010	0.063	-0.500	0.500

**6.2.3. Test Limit**

As per manufacturer declared spec +/- 0.5ppm

### 6.3. Audio Frequency Response

#### 6.3.1. Test Setup

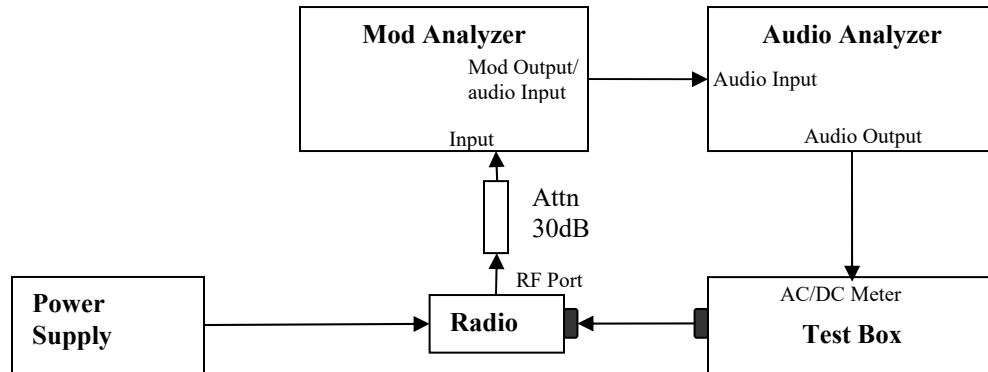

- 1) The DUT transmitter output port was connected to Modulation Analyzer.
- 2) Path loss for the measurement included.
- 3) Set the audio bandwidth filter to 15 kHz and 50 kHz.
- 4) Transmit the radio and set the audio analyzer to 1 kHz audio frequency and 20% of the Full rated system deviation.
- 5) On audio analyzer, set the rated level as reference to zero.
- 6) Vary the audio frequency from 300 Hz to 3 kHz. Record the change in dB on the audio analyzer.



**6.3.2. Test Result**

Not for FCC Review

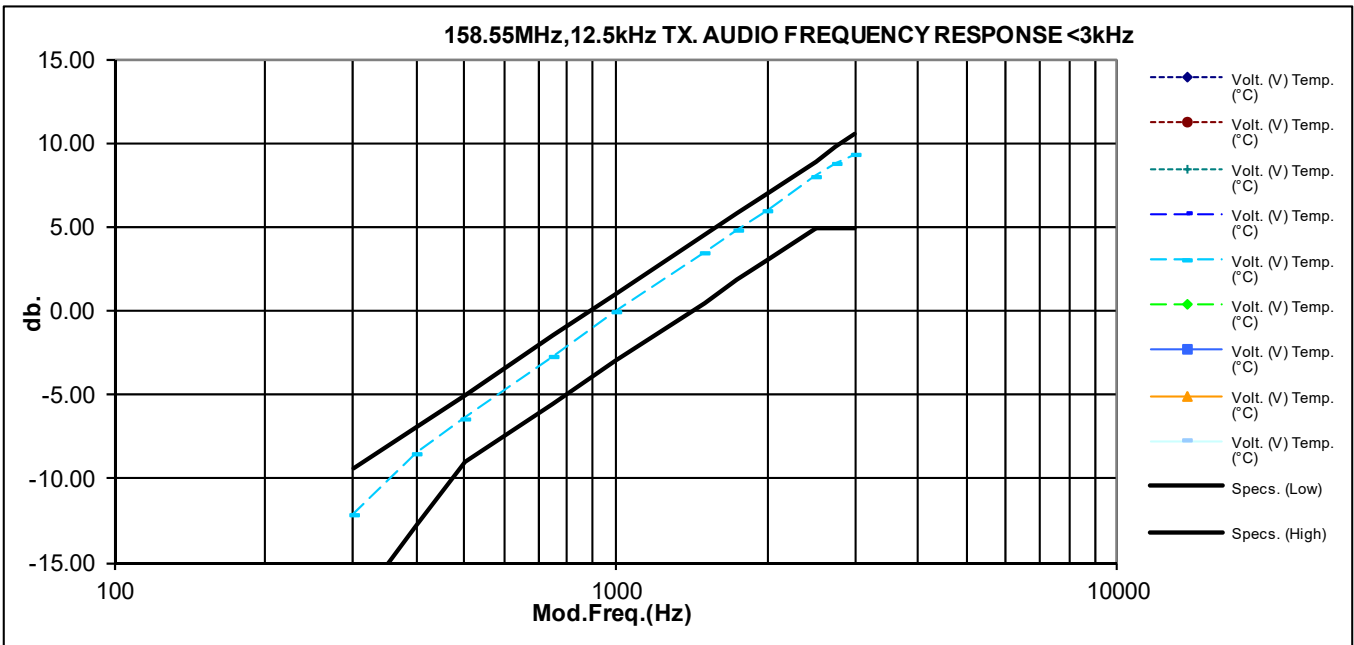
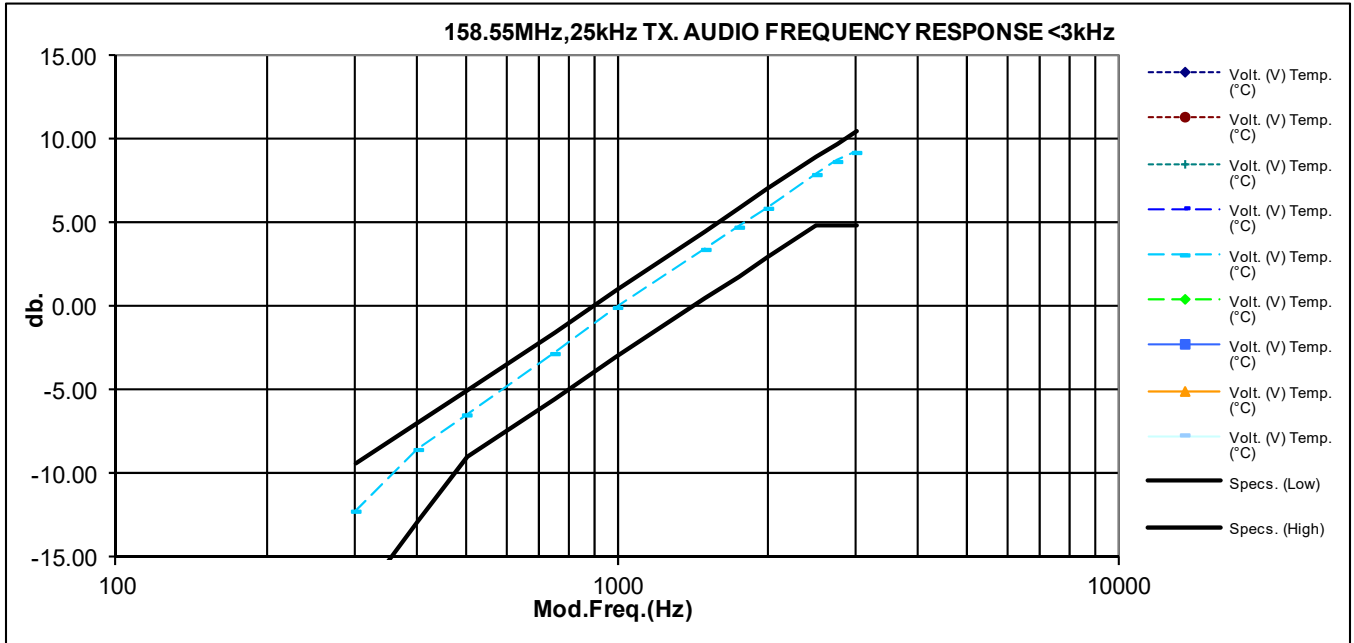

### 6.3.3. Test Limit

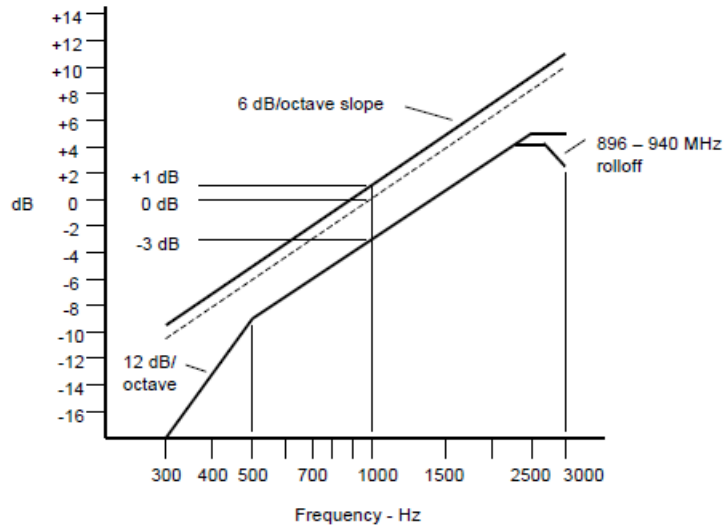

Note:

- o There are additional 6 dB per octave attenuation is allowed from 2.5KHz to 3KHz in equipment 25MHz to 869MHz radio.
- o Additional 6 dB per octave attenuation is allowed from 2.3KHz to 2.7KHz & additional 12 dB per octave attenuation is allowed from 2.7KHz to 3KHz in equipment 896MHz to 940MHz radio.

## 6.4. Audio Low Pass Filter Response

### 6.4.1. Test Setup

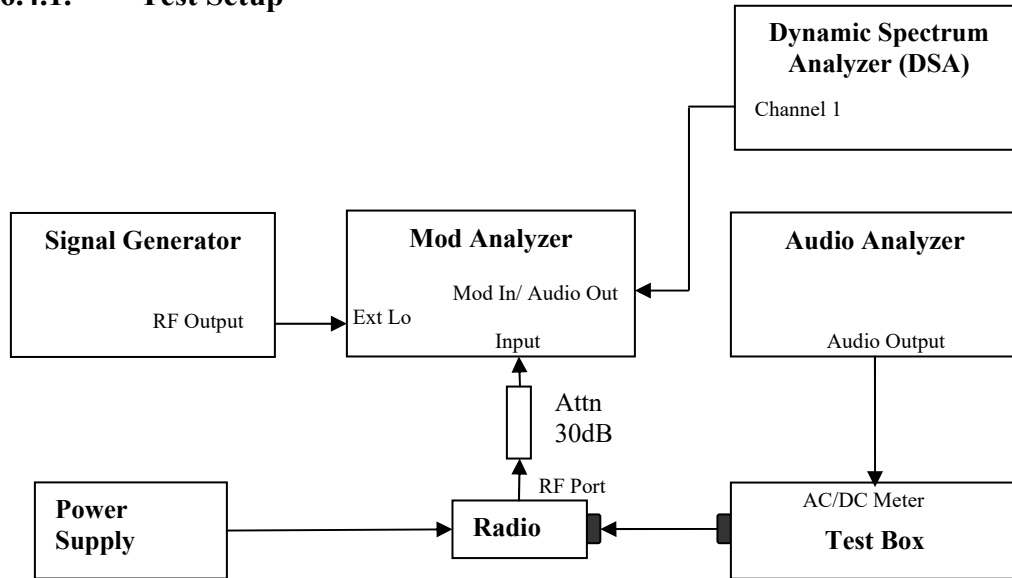

- 1) The DUT transmitter output port was connected to Modulation Analyzer.
- 2) Path loss for the measurement included.
- 3) Press 23.1SPCL on modulation analyzer to enable the external LO from Sigen.
- 4) Set the Sigen frequency to  $F_c + 1.5$  MHz, RF output level to 0dBm without modulation.
- 5) Transmit the radio and set the audio analyzer to 1 kHz audio frequency and 60% of the Full rated system deviation.
- 6) Up the amplitude by 20dB.
- 7) On DSA, get the reference point to 0dB.
- 8) Vary the frequency on audio analyzer from 3 kHz to 20 kHz, record the audio tone from DSA.

### 6.4.2. Test Result

Not for FCC Review

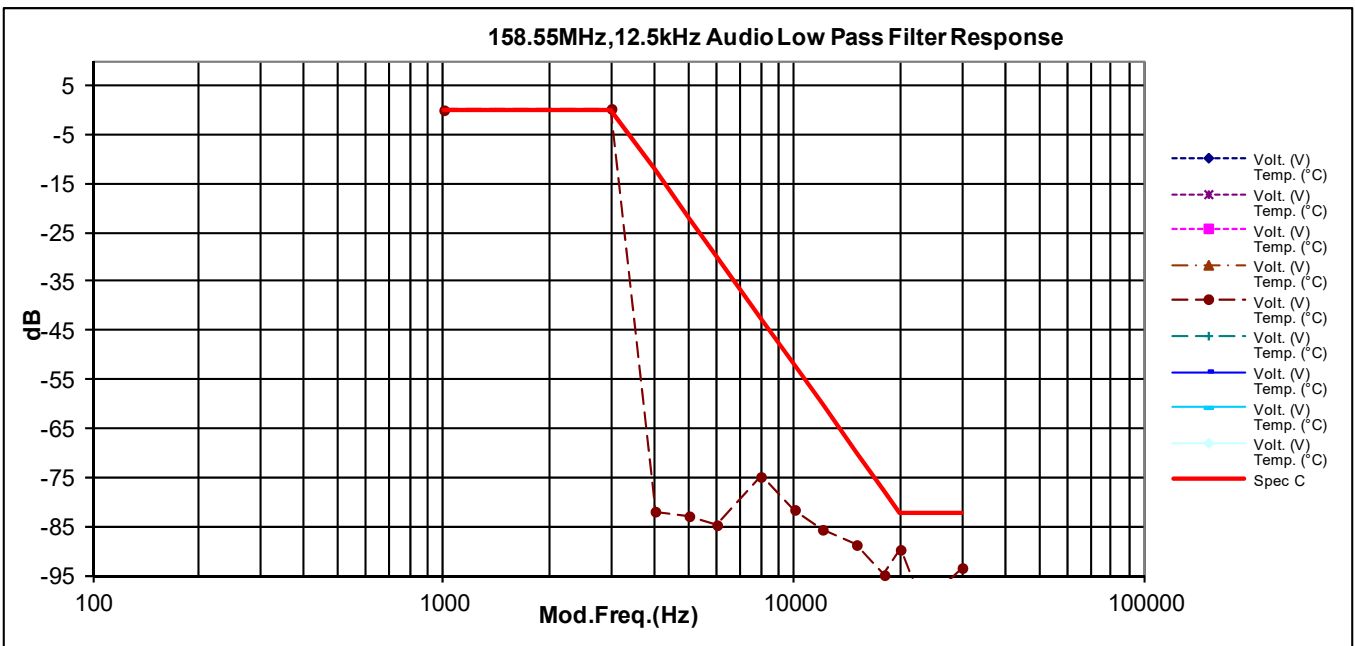
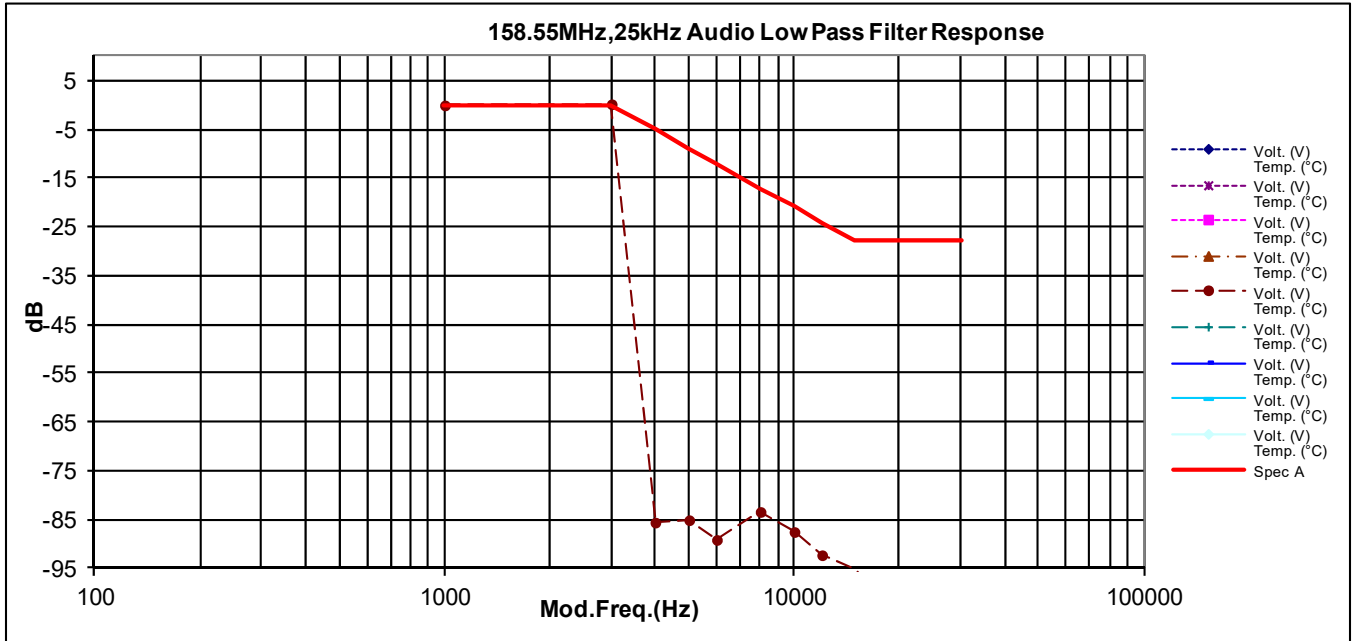

### 6.4.3. Test Limit

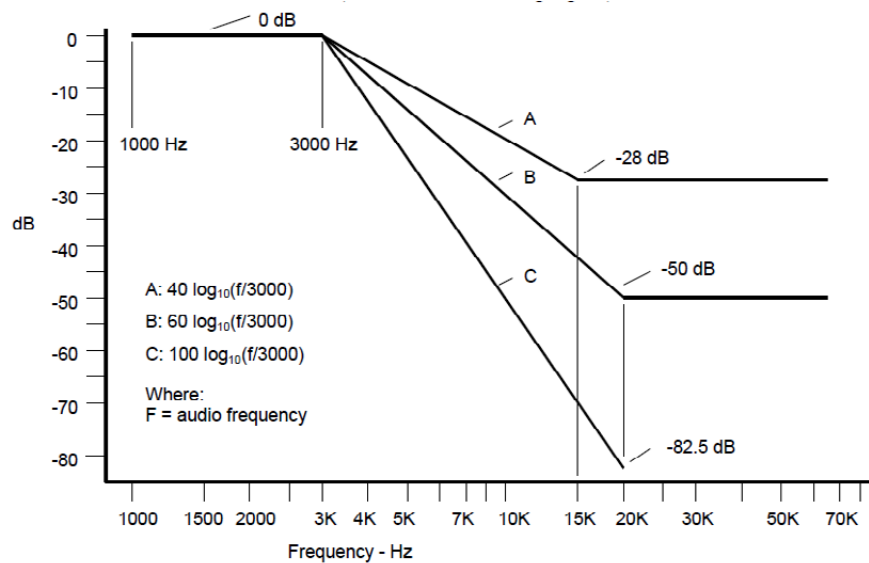

For audio frequencies above 3000 Hz, the audio response of the post limiter low-pass filter shall meet or exceed the following requirements:

- a) For equipment operating on 20, 25 or 30 kHz channel bandwidth in the 25 MHz to 174 MHz range:

At frequencies from 3000 Hz through 15,000 Hz the attenuation shall be greater than the attenuation at 1000 Hz by at least:  $40 \log_{10}(f/3000)$  dB

where:  $f$  is the audio frequency in Hz.

At frequencies above 15,000 Hz, the attenuation shall be greater than the attenuation at 1000 Hz, by at least: 28 dB.

- b) For equipment operating with 25 kHz bandwidth channels between 406 and 512 MHz through 896 MHz, and between 929 MHz through 930 MHz:

At frequencies from 3000 Hz through 20,000 Hz, the attenuation shall be greater than the attenuation at 1000 Hz by at least:  $60 \log_{10}(f/3000)$  dB

where:  $f$  is the audio frequency in Hz.

At frequencies above 20,000 Hz the attenuation shall be greater than the attenuation at 1000 Hz by at least: 50 dB.

- c) For equipment operating on channels between 896 MHz through 901 MHz, between 935 MHz through 940 MHz, and 12.5 or 15 kHz spaced channels in the frequency range 138-174 MHz and 406-512 MHz.

At frequencies from 3000 Hz through 20,000 Hz the attenuation shall be greater than the attenuation at 1000 Hz by at least:  $100 \log_{10}(f/3000)$  dB

where:  $f$  is the audio frequency in Hz.

## 6.5. Modulation Limiting

### 6.5.1. Test Setup

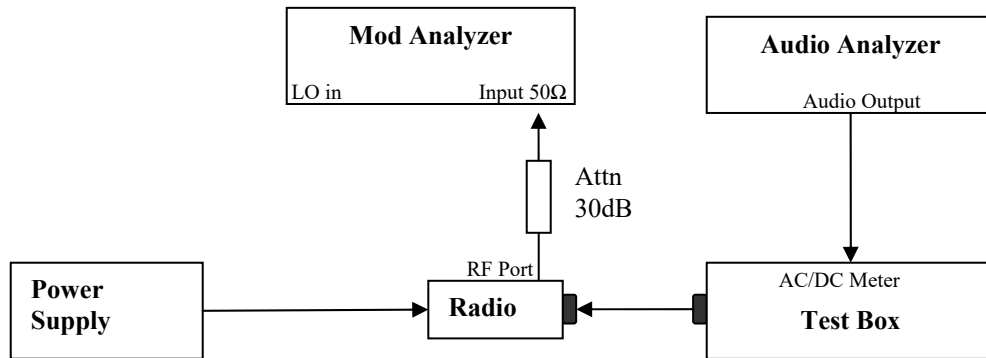

- 1) The DUT transmitter output port was connected to Modulation Analyzer.
- 2) Path loss for the measurement included.
- 3) Set the audio bandwidth filter to 15 kHz.
- 4) Transmit the radio and set the audio analyzer to 1 kHz audio frequency and 60% of the Full rated system deviation.
- 5) Record the frequency deviation as 0dB input level at 1kHz audio frequency.
- 6) Repeat the step and record the frequency deviation from -20 dB to 20dB by 5 dB increments and different audio freq 300 Hz, 2.5 kHz and 3 kHz.

### 6.5.2. Test Result

Not for FCC Review

#### 158.5500MHz, 25.0kHz Modulation Limiting

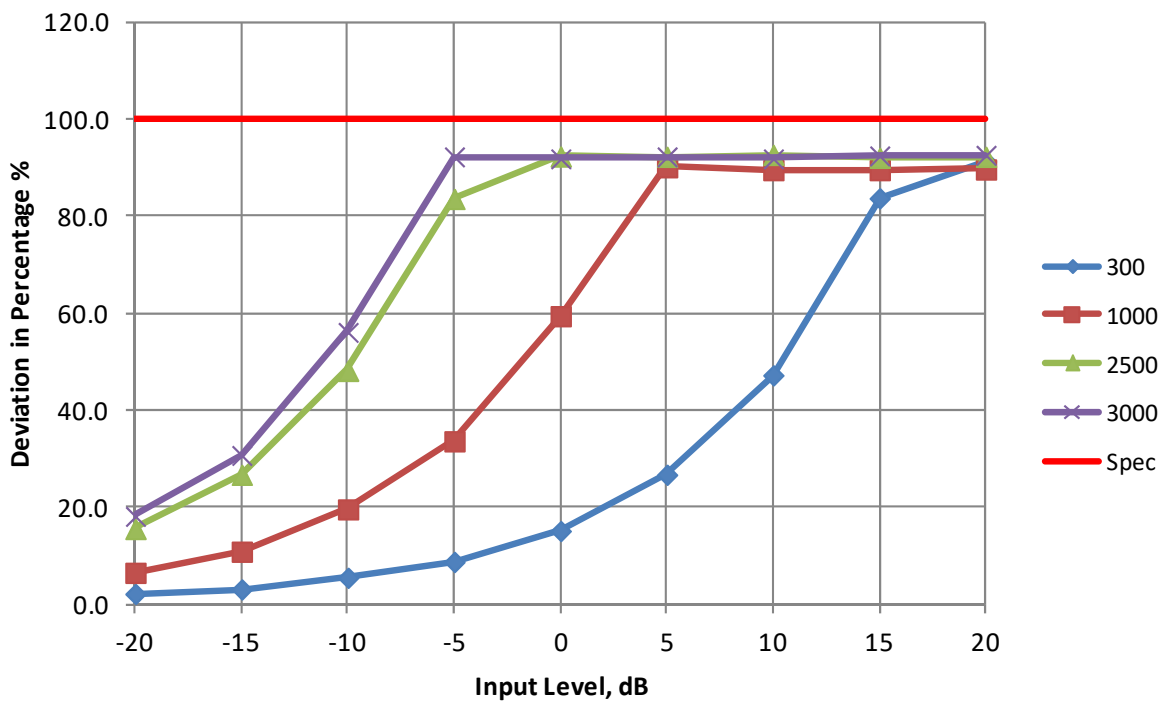

#### 158.5500MHz, 12.5kHz Modulation Limiting

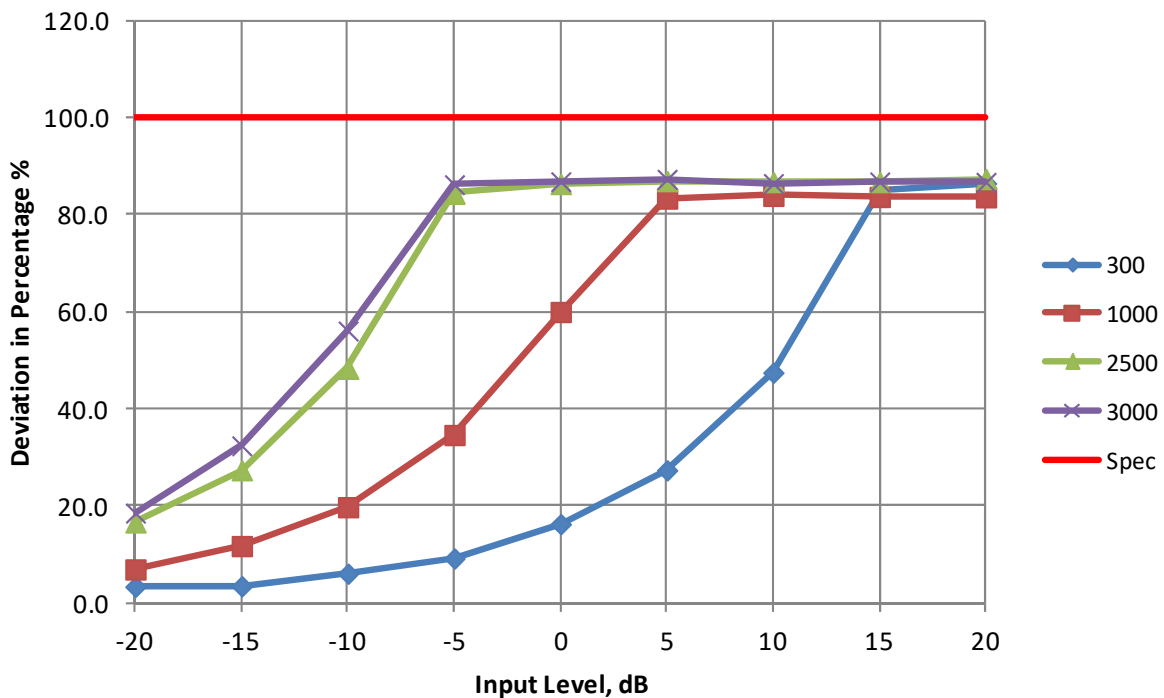

**6.5.3. Test Limit**

Modulation Limiting shall not exceed 100 percent.



## 6.6. Occupied Bandwidth

### 6.6.1. Test Setup (Analog)

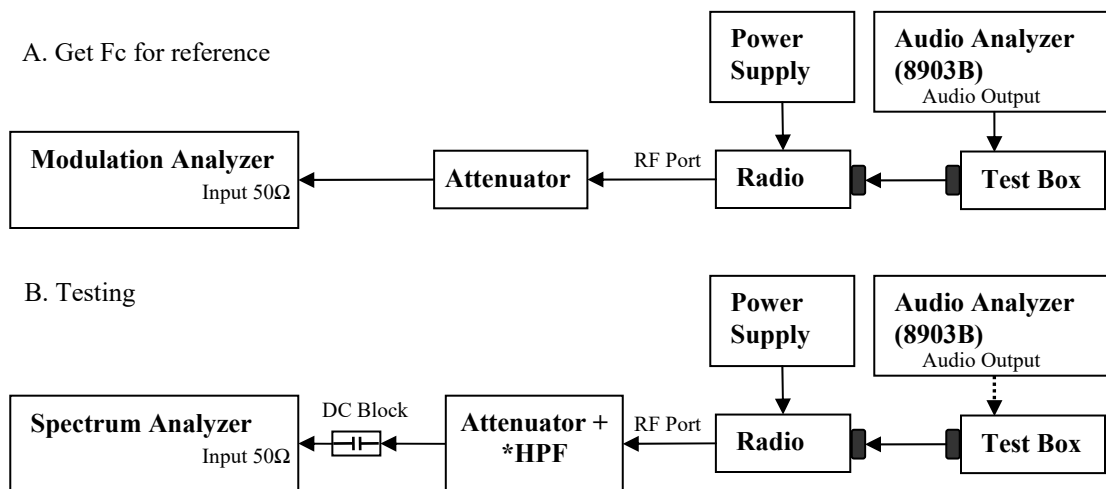

- 1) The DUT transmitter output port was connected to Modulation Analyzer.
- 2) Set the audio bandwidth filter to 15 kHz low pass filter and 50 kHz high pass filter.
- 3) Transmit the radio and set the audio analyzer to 2.5 kHz audio frequency and 50% of the rated deviation. Up the amplitude by 16 dB. Dekey the DUT.
- 4) Path loss for the measurement included.
- 5) Select the Occupied Bandwidth measurement for 99% Emissions Bandwidth Measurement.
- 6) Key in the Fc and Resolution Bandwidth (1 ~ 5 % of emission designator).
- 7) Transmit the DUT and record the occupied Bandwidth frequency.
- 8) Preset the spectrum analyzer for sideband spectrum measurement.
- 9) Set the span and Resolution Bandwidth (according to FCC/ ISED standard).
- 10) Save the screen shot as modulated signal
- 11) Remove the audio tone from audio analyzer to capture unmodulated signal.

\* Only HPF added for Mask 80.211 measurement with attenuator.

## **6.6.2. Test Result (Analog)**

### Standard Audio Modulation (12.5 kHz Channelization, Analog Voice):

Emission Designator 11K0F3E

In this case, the maximum modulating frequency is 3.0 kHz with a 2.5 kHz deviation.

$BW = 2(M+D) = 2*(3.0 \text{ kHz} + 2.5 \text{ kHz}) = 11 \text{ kHz} \Rightarrow 11K0$   
F3E portion of the designator indicates voice.

Therefore, the entire designator for 12.5 kHz channelization analog voice is 11K0F3E.

### Standard Audio Modulation (25 kHz Channelization, Analog Voice):

Emission Designator 16K0F3E

In this case, the maximum modulating frequency is 3 kHz with a 5 kHz deviation.

$BW = 2(M+D) = 2*(3 \text{ kHz} + 5 \text{ kHz}) = 16 \text{ kHz} \Rightarrow 16K0$   
F3E portion of the designator indicates voice.

Therefore, the entire designator for 25 kHz channelization analog voice is 16K0F3E

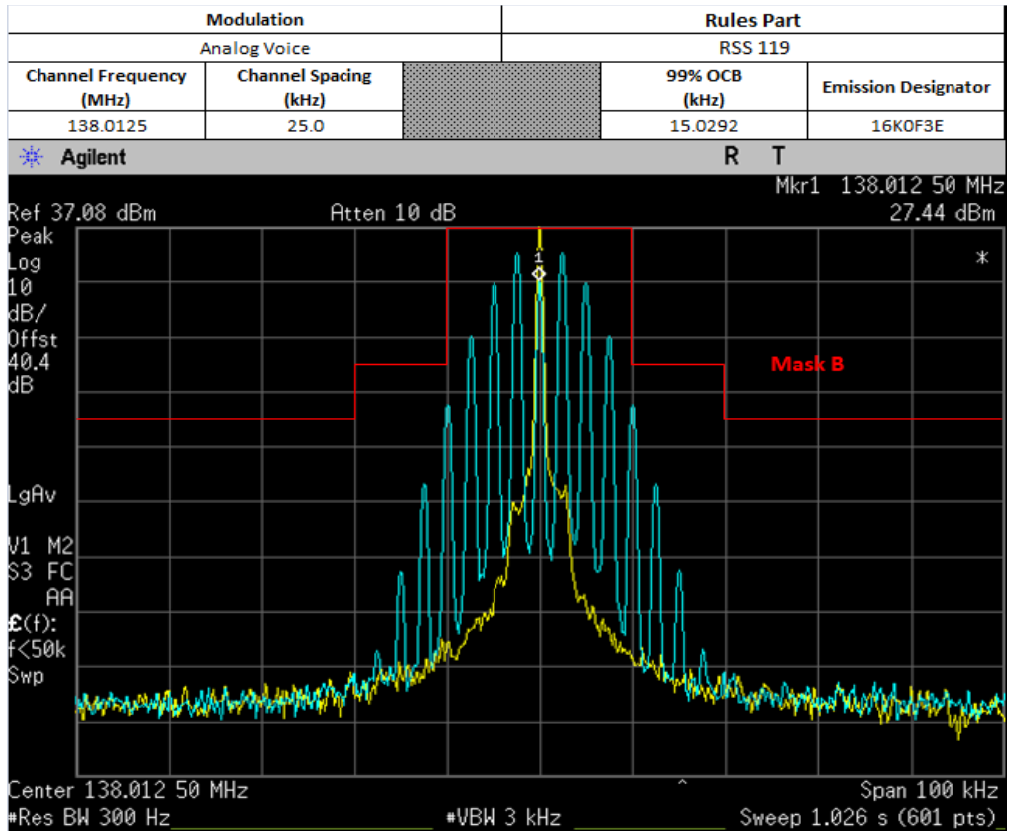

**Not for FCC Review**

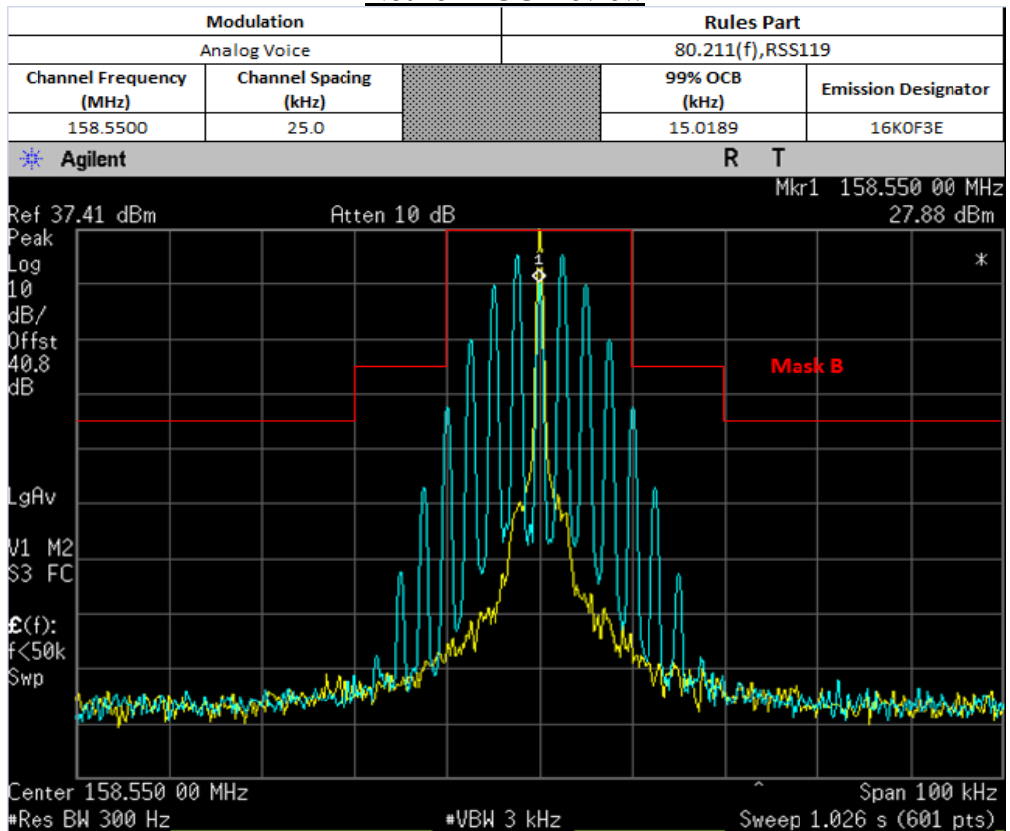

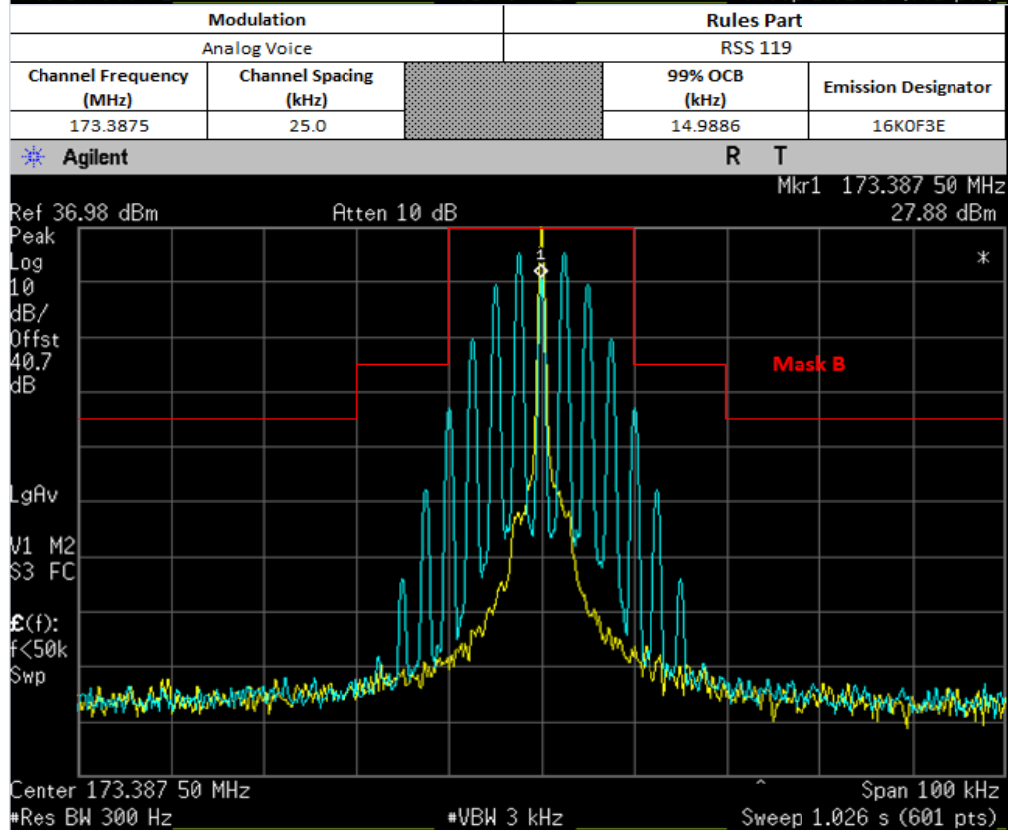
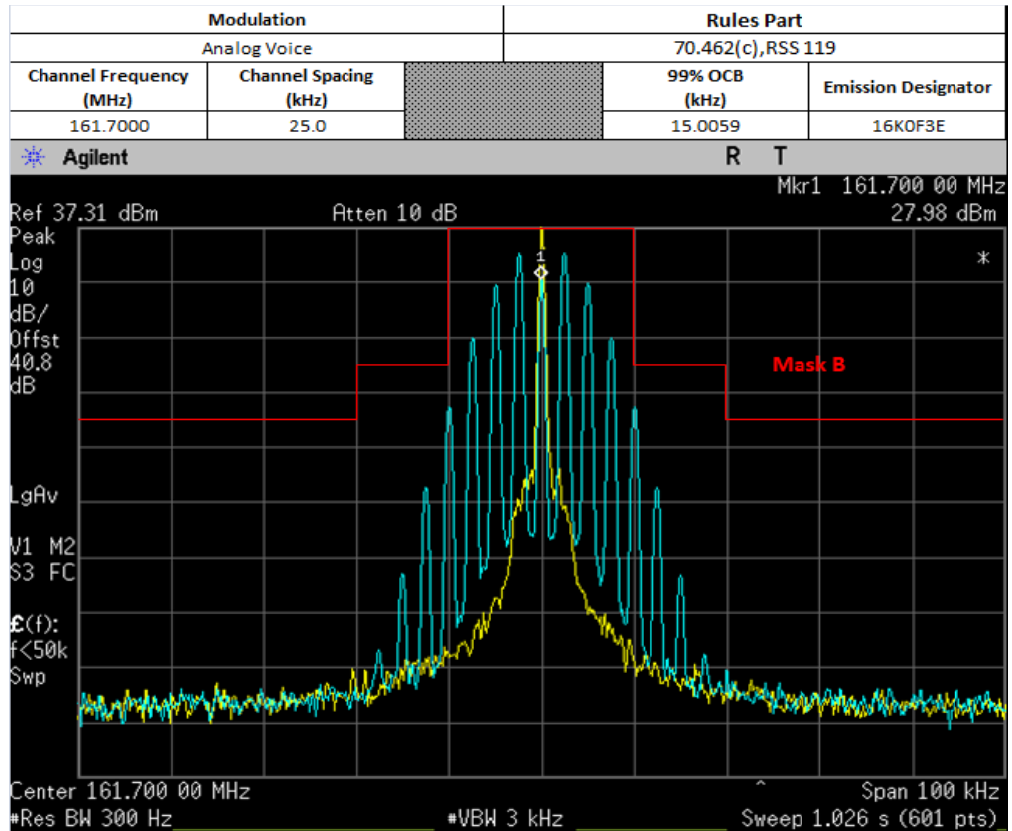

**Not for FCC Review**

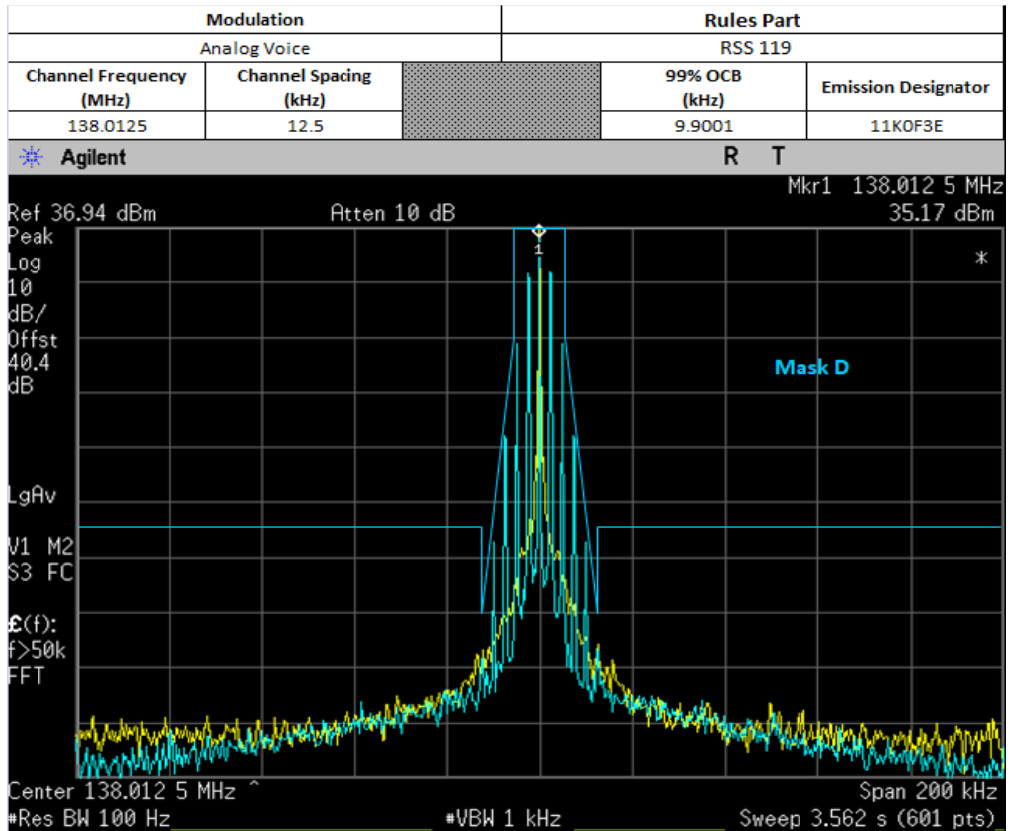

**Not for FCC Review**

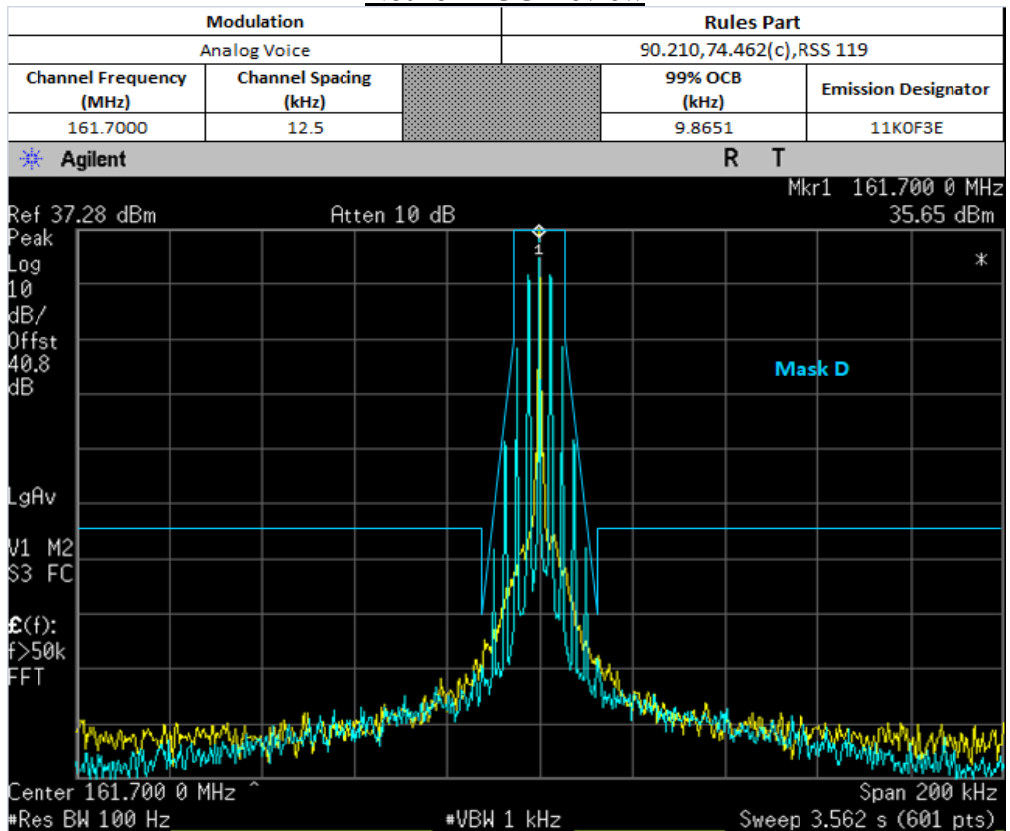

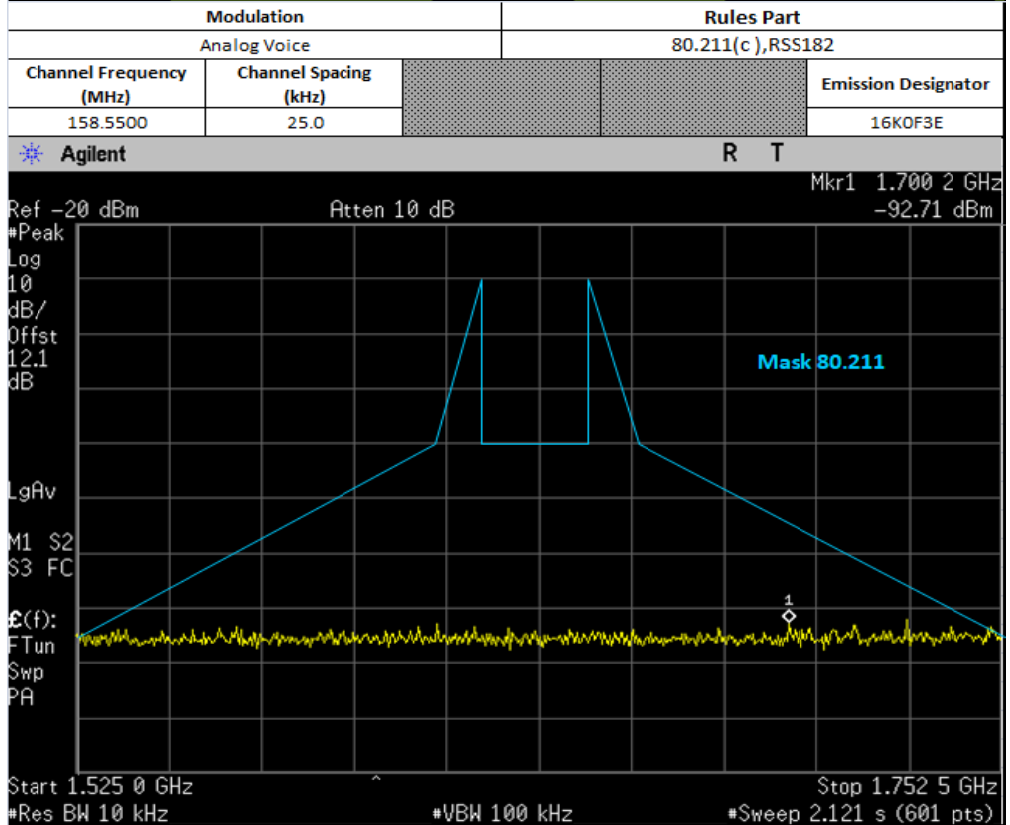
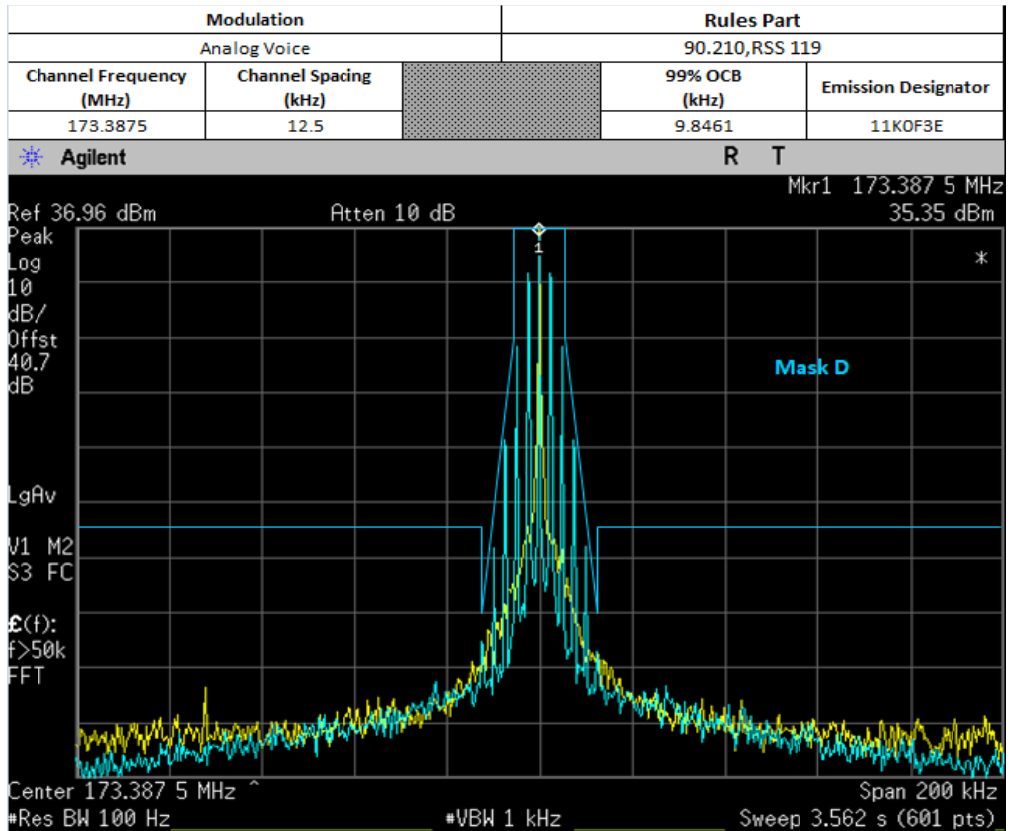

NOT FOR FCC REVIEW

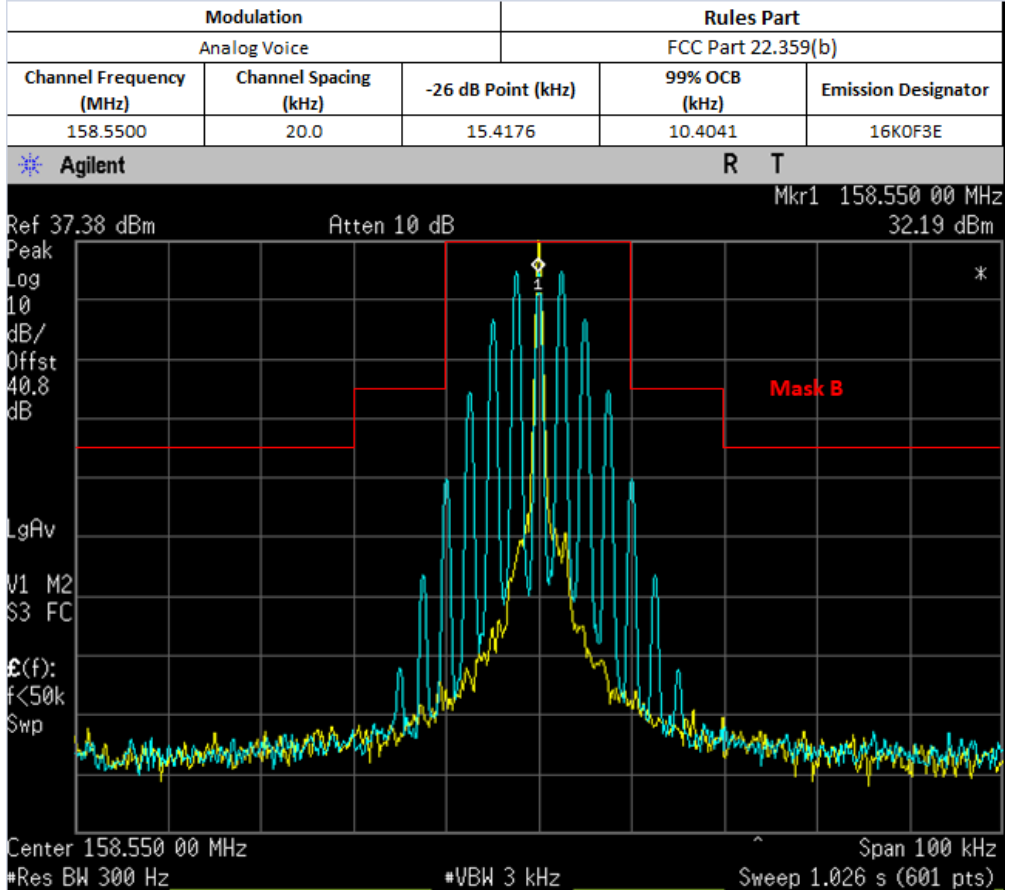
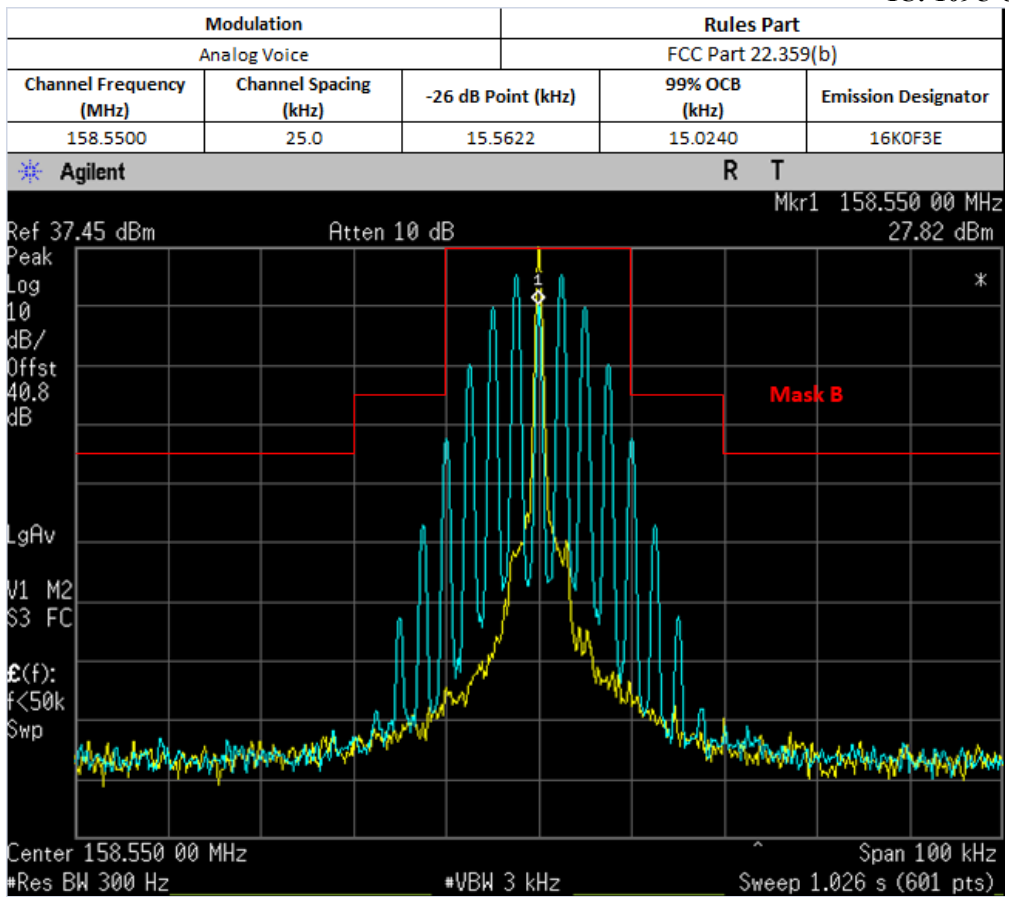

### 6.6.3. Test Setup (Digital)

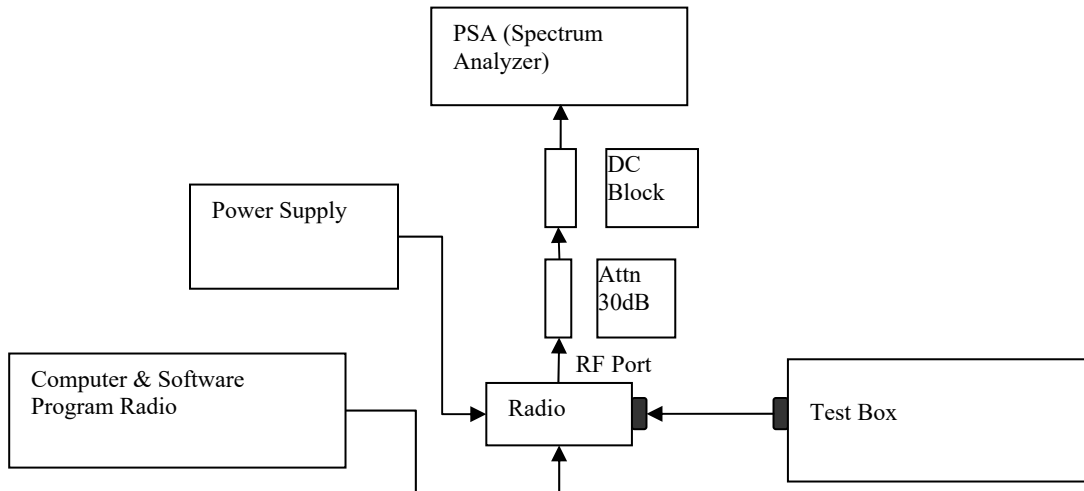

- 1) Program and set radio to operate in desire test frequency and digital mode with modulation. (\*4FSK, C4FM or other digital modulation form).
- 2) Path loss for the measurement included.
- 3) Select the Occupied Bandwidth measurement for 99% Emissions Bandwidth Measurement.
- 4) Key in the Fc and Resolution Bandwidth (1 ~ 5 % of emission designator).
- 5) Transmit the DUT and record the occupied Bandwidth frequency.
- 6) Preset the spectrum analyzer for modulation emission spectrum measurement.
- 7) Set the span and Resolution Bandwidth (according to FCC/ ISED standard).
- 8) Capture the screen shot as modulated signal.

\*Note:

- For Digital Modulation, 12.5 kHz Data F1D & FXD would be the same. Therefore only measurements with F1D modulation shown below.
- For Digital Modulation, 12.5 kHz Data F1E & FXE would be the same. Therefore only measurements with F1E modulation shown below.



#### **6.6.4. Test Result (Digital)**

Digital (12.5 kHz Channelization, Digital Data, Voice, Voice + Data):

Emission Designator 7K60F1D / 7K60F1E / 7K60F1W

The 99% energy rule (title 47CFR 2.989) was used for digital mode and is more accurate than Carson's rule. It basically states that 99% of the modulation energy falls within X kHz, in this case, 7.6 kHz. Measurements were performed in accordance with TIA/EIA TSB102.CAAB Section 2.2.5.2. The emission mask was obtained from 47CFR 90.210(d).

F1D / F1E / F1W portion of the designator indicates digital data, voice and voice+data respectively.

Therefore, the entire designator for 12.5 kHz channelization digital data / voice / voice+data is 7K60F1D / 7K60F1E / 7K60F1W respectively

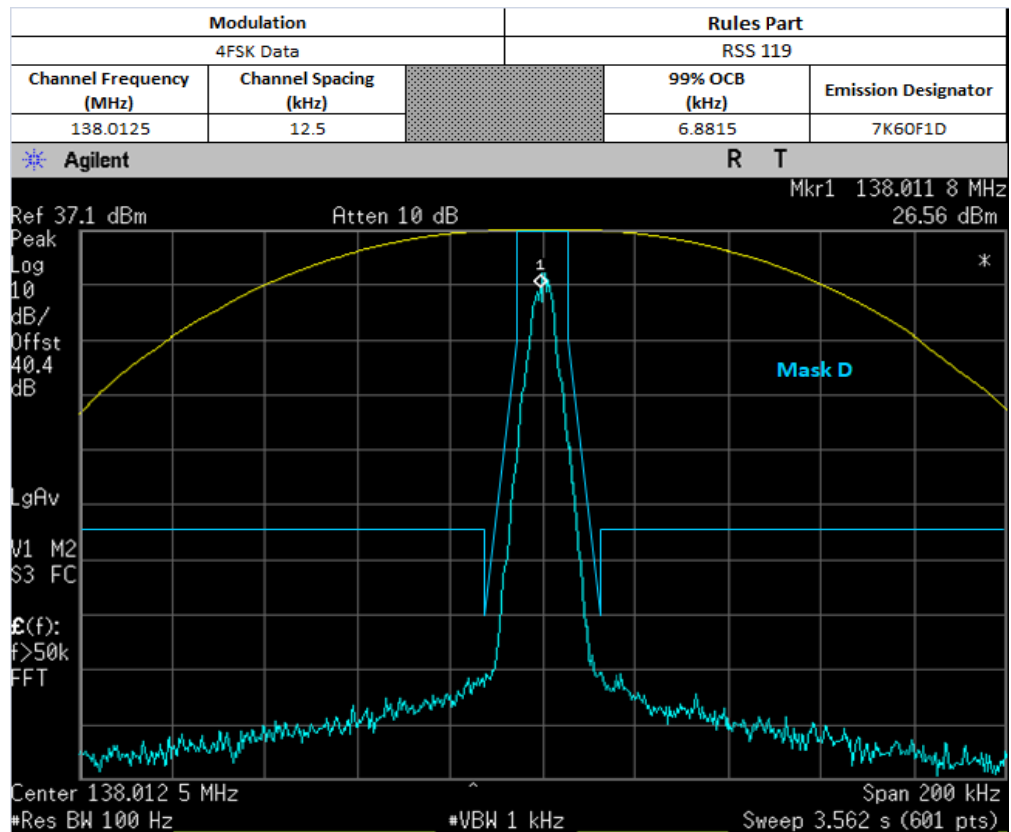

**Not for FCC Review**

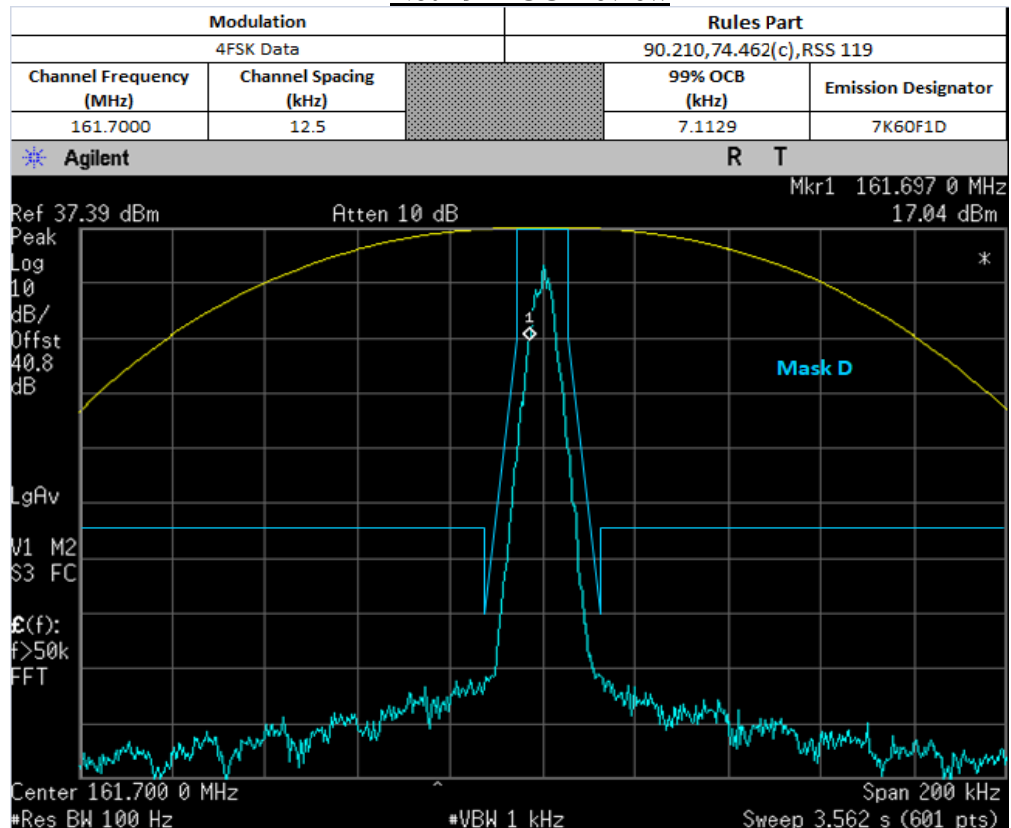

Modulation		Rules Part		
4FSK Data		90.210,RSS 119		
Channel Frequency (MHz)	Channel Spacing (kHz)	99% OCB (kHz)	Emission Designator	
173.3875	12.5	7.1538	7K60F1D	

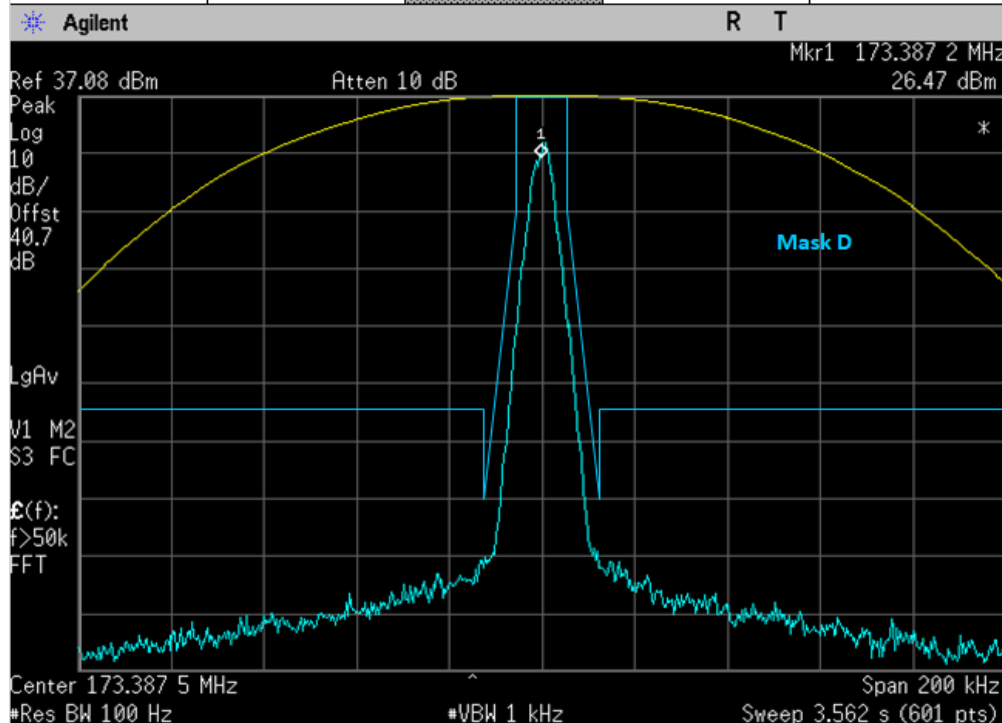

Modulation		Rules Part		
4FSK Voice		RSS 119		
Channel Frequency (MHz)	Channel Spacing (kHz)	99% OCB (kHz)	Emission Designator	
138.0125	12.5	5.9913	7K60F1E	

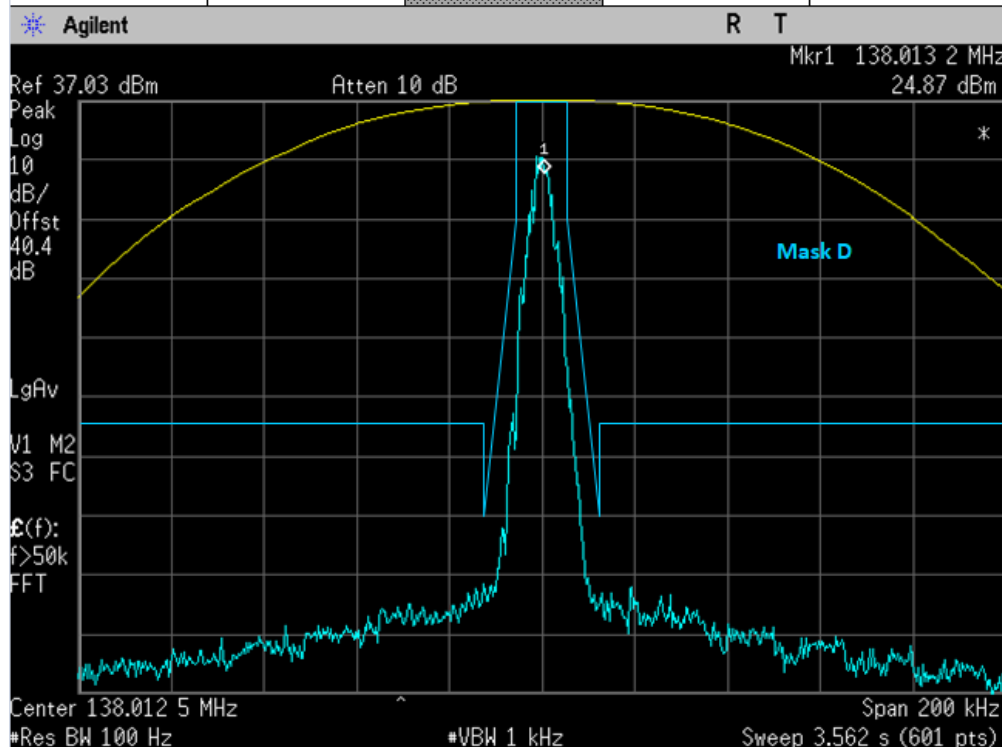

**Not for FCC Review**

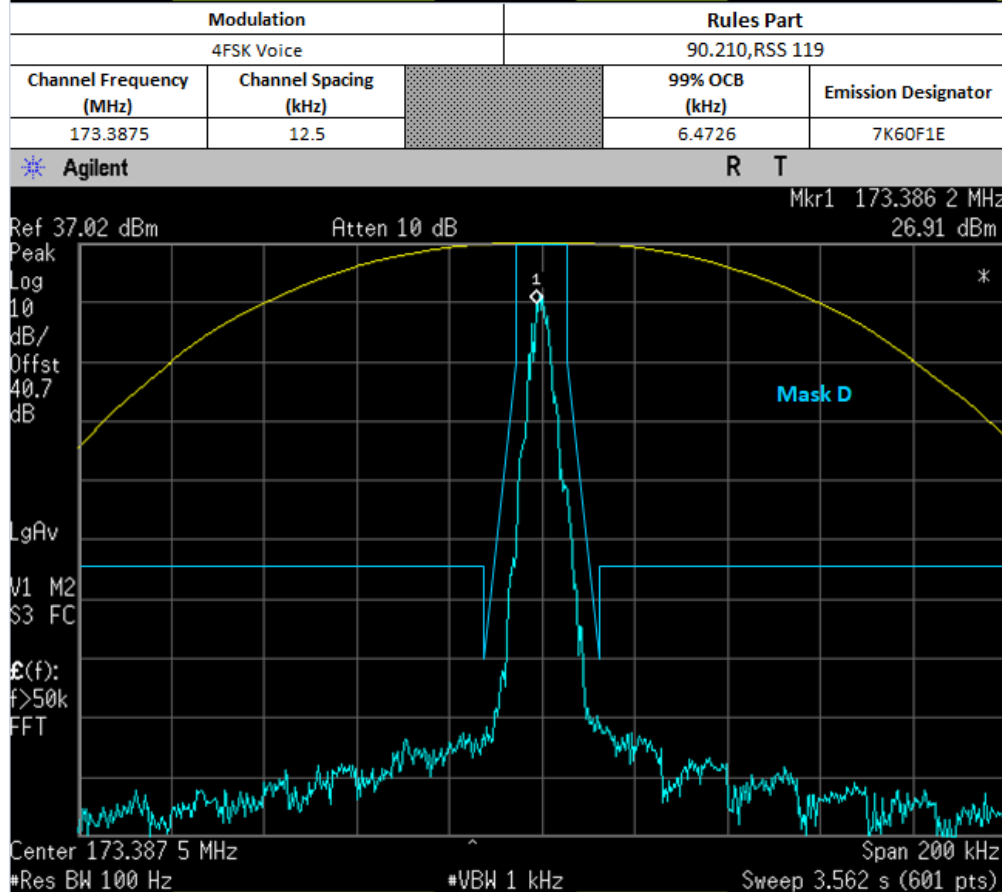
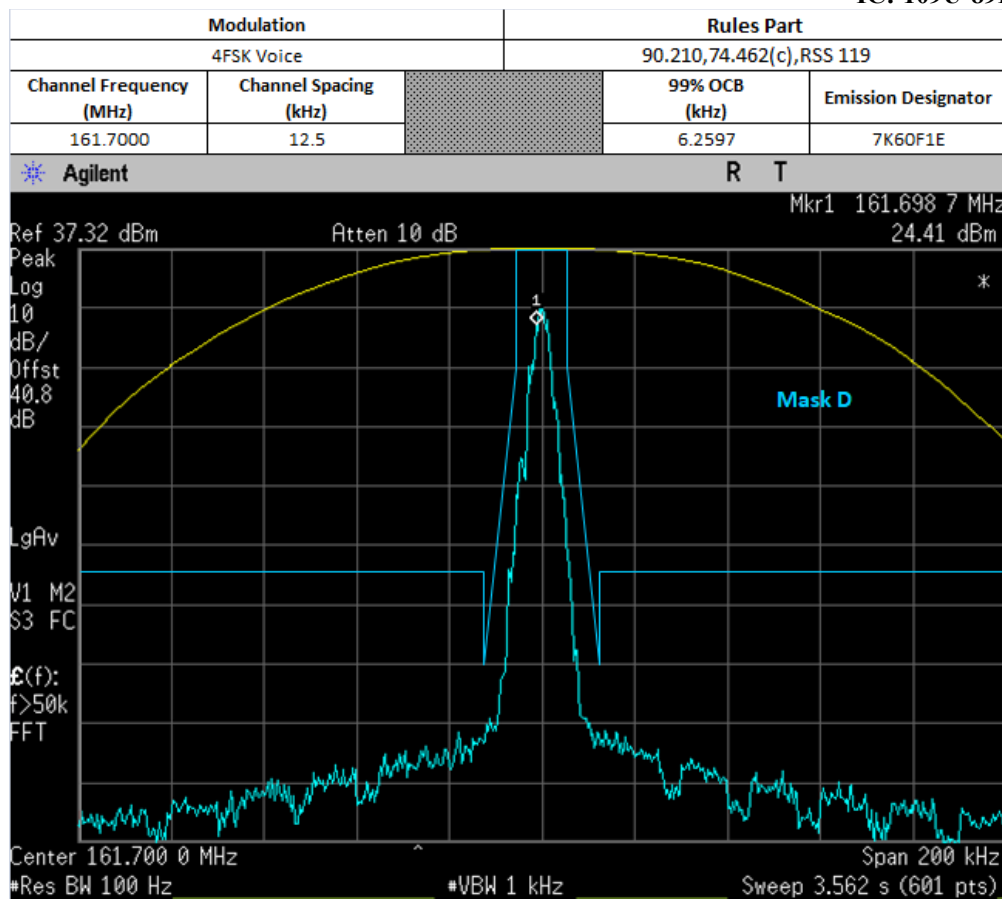

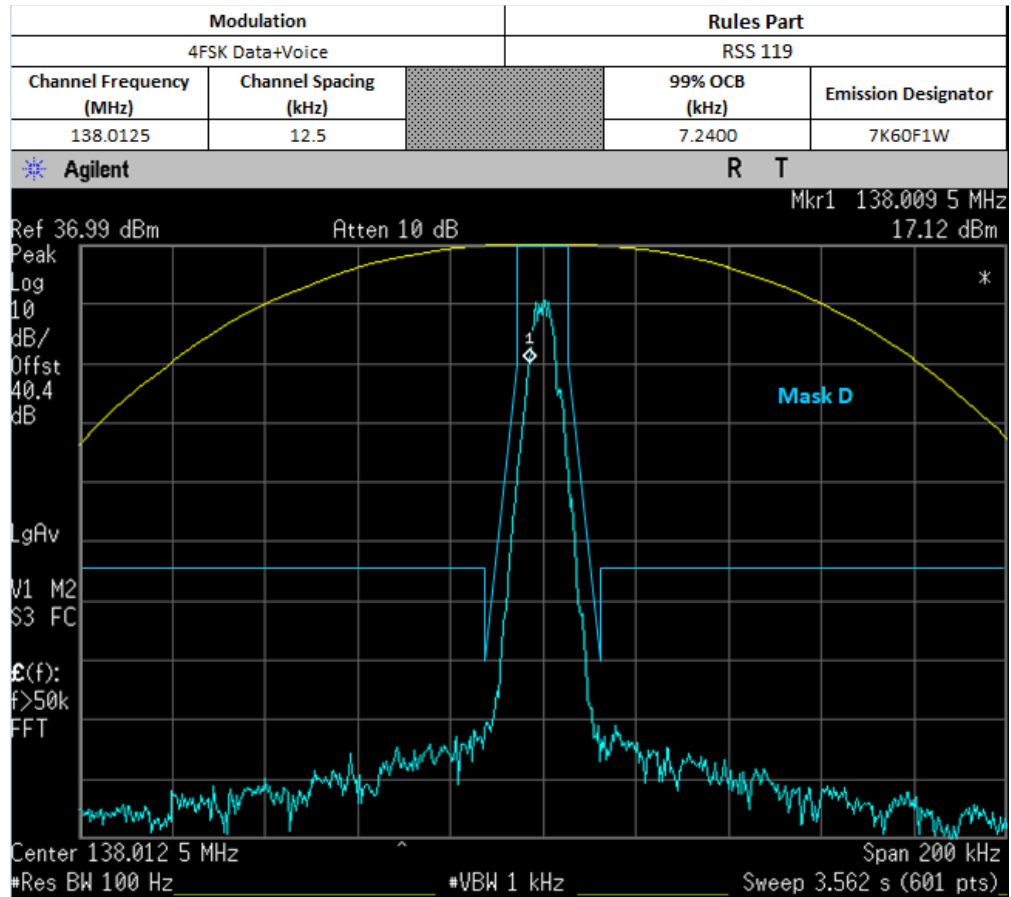

**Not for FCC Review**

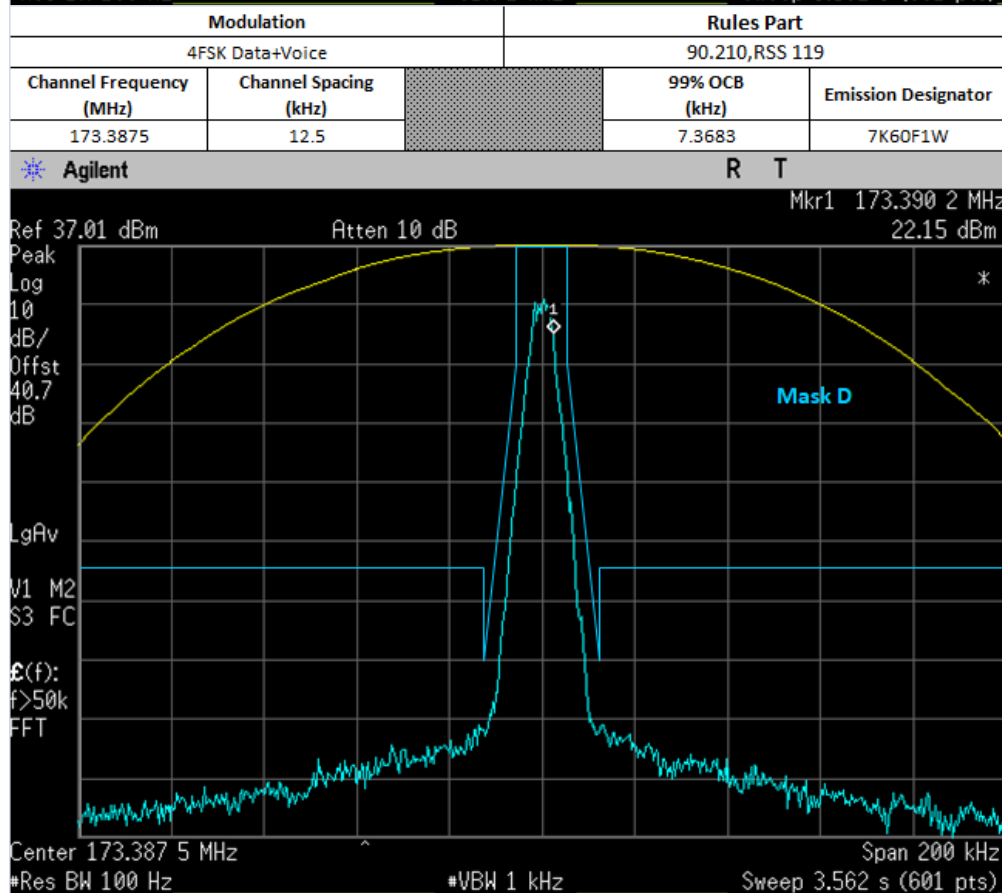
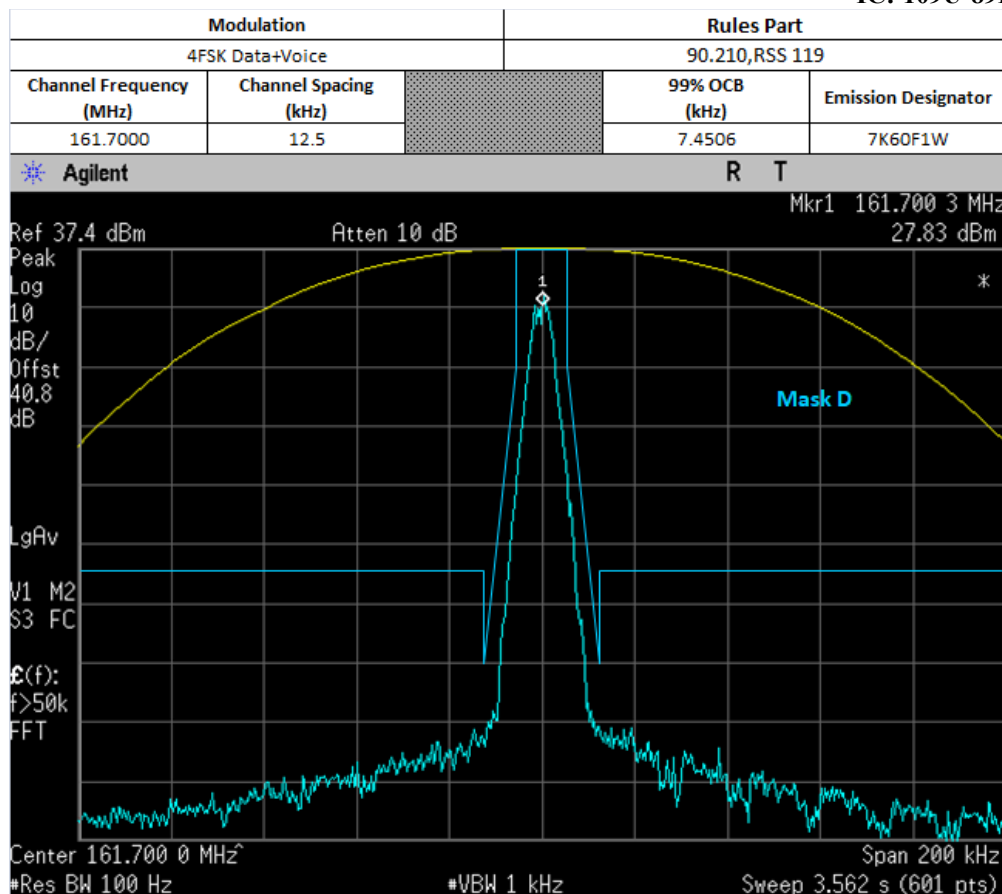

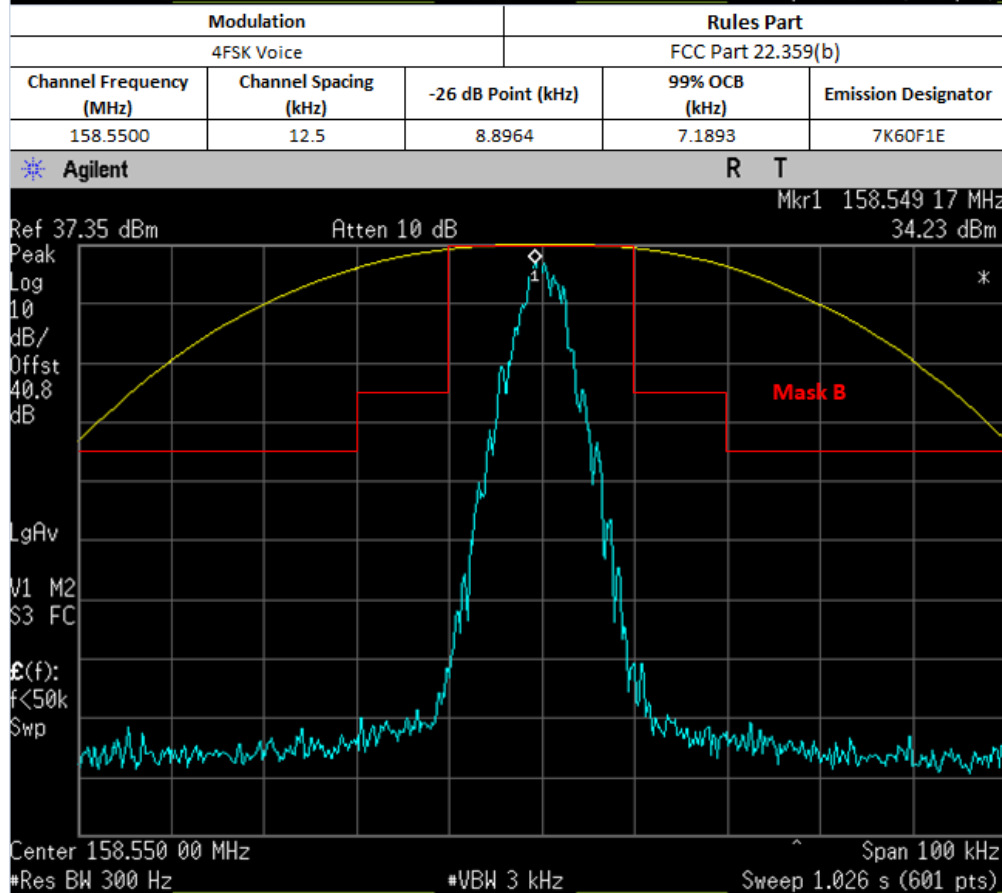
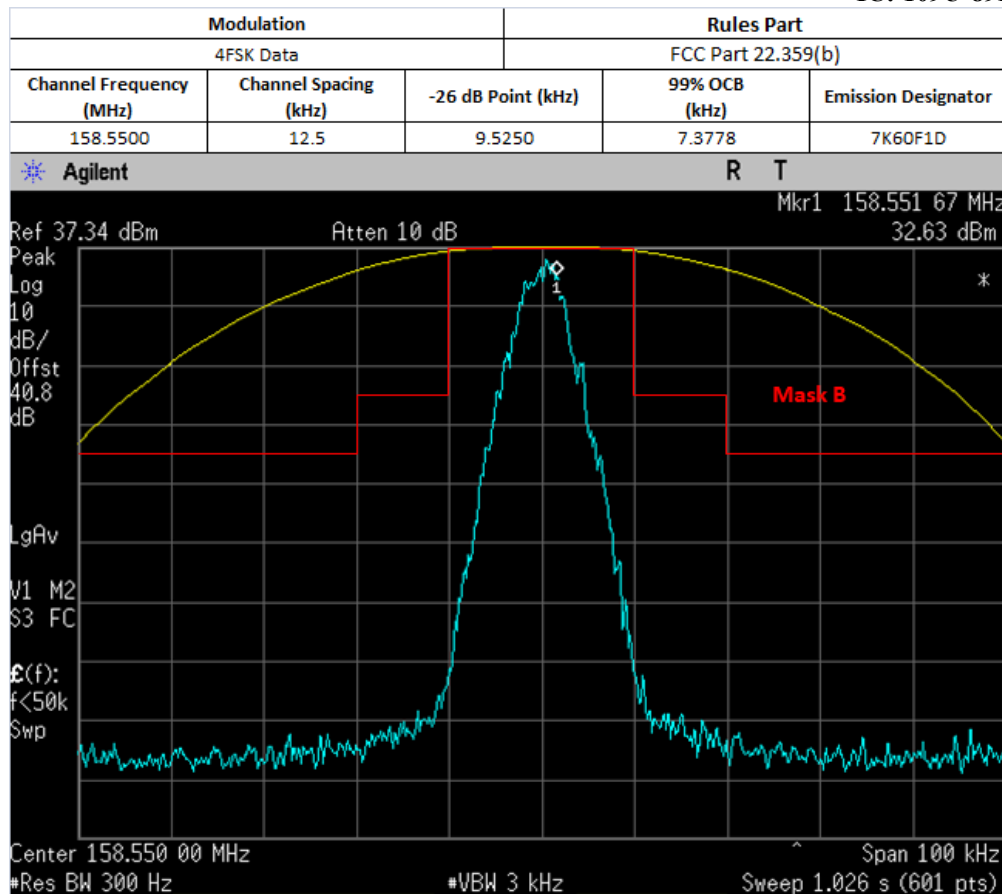

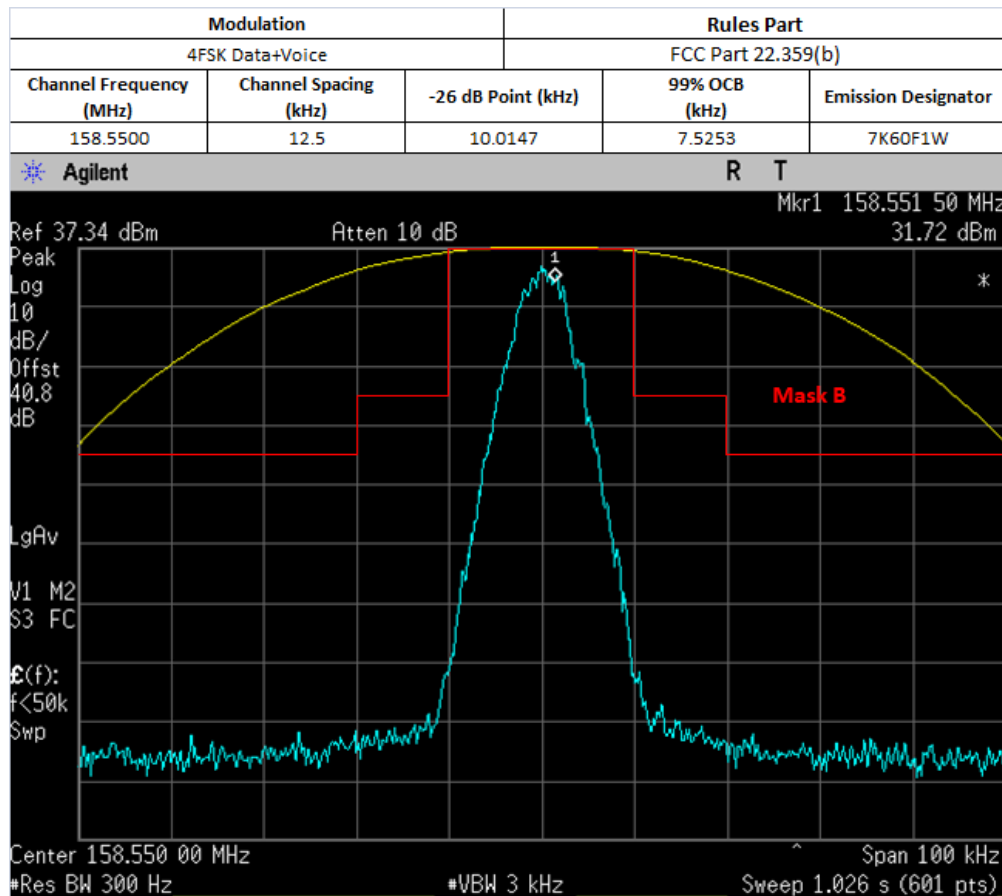

**6.6.5. Test Limit**

The 99% occupied bandwidth is the width of a frequency band such that, below the lower and above the upper frequency limits, the mean powers emitted are each equal to a specified percentage 0.5% of the total mean transmitted power.



## 6.7. Band Edge Conducted Spurious Emission (Part 22)

### 6.7.1. Test Setup (Analog)

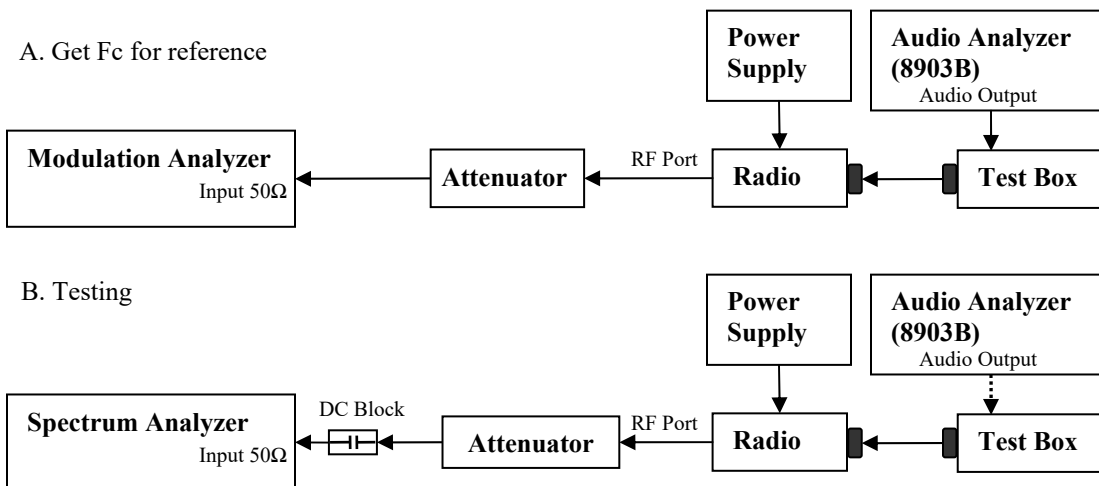

- 1) The DUT transmitter output port was connected to Modulation Analyzer.
- 2) Set the audio bandwidth filter to 15 kHz low pass filter and 50 kHz high pass filter.
- 3) Transmit the radio and set the audio analyzer to 2.5 kHz audio frequency and 50% of the rated deviation. Up the amplitude by 16 dB. Dekey the DUT.
- 4) Path loss for the measurement included.
- 5) Select the Occupied Bandwidth measurement for 99% and 26dB Emissions Bandwidth Measurement.
- 6) Key in the Fc and Resolution Bandwidth.
- 7) Transmit the DUT and record the occupied Bandwidth frequencies.
- 8) Preset the spectrum analyzer for band edge measurement.
- 9) The band edges of lowest and highest channels were measured.
- 10) Key in the Lowest and highest channel frequency, span is 60 kHz and Resolution Bandwidth is at least 1% of Emission Bandwidth.
- 11) Save the screen shot as modulated signal.
- 12) Remove the audio tone from audio analyzer to capture unmodulated signal.

\*Note:

- For emission designator ending with F3E, 16K0F3E is the worst case and therefore only 16K0F3E will be shown.

### 6.7.2. Test Result (Analog)

#### Max Power

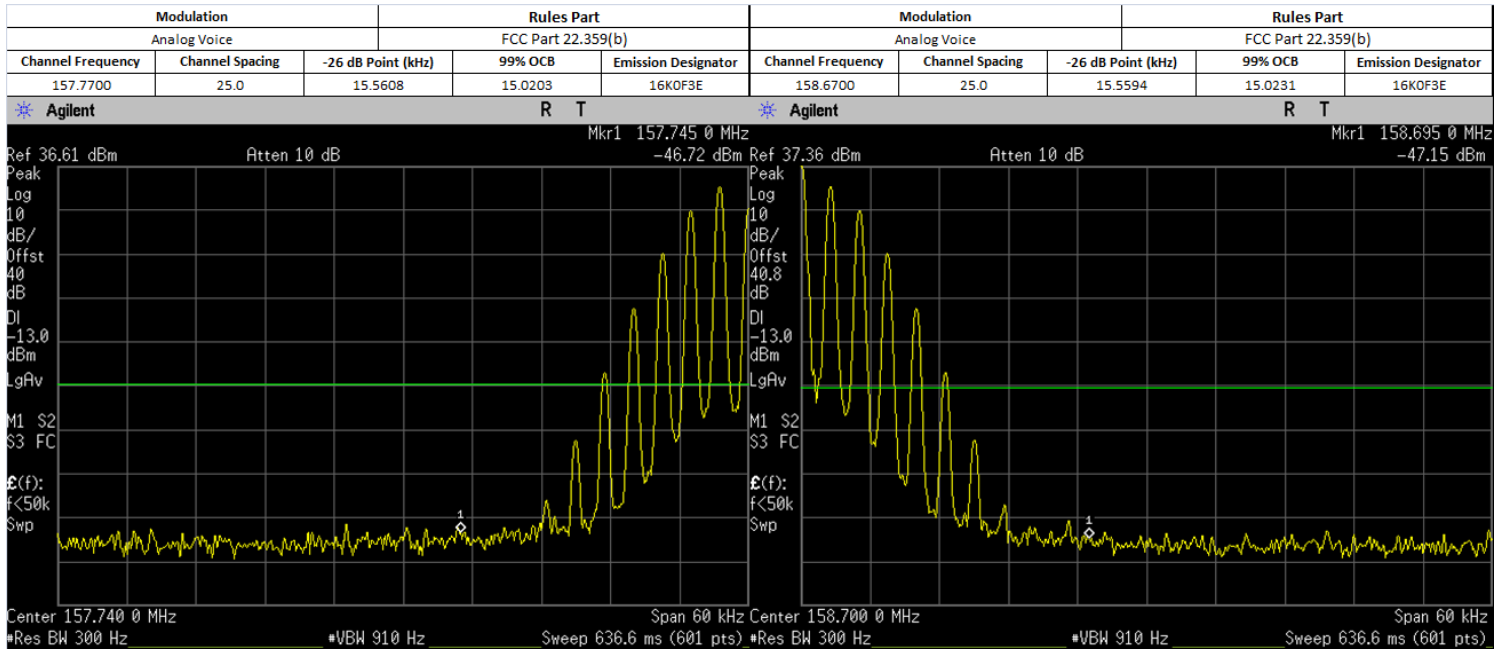

#### Low Power

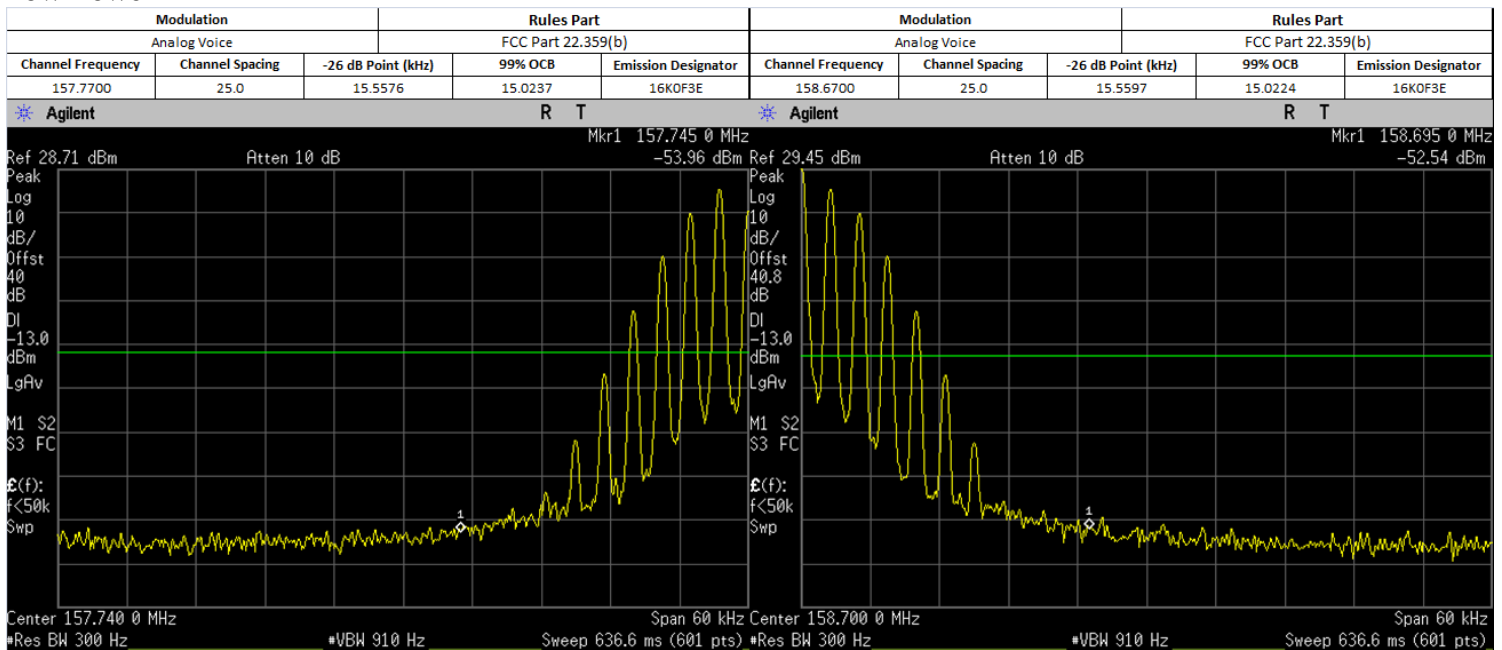

### 6.7.3. Test Setup (Digital)

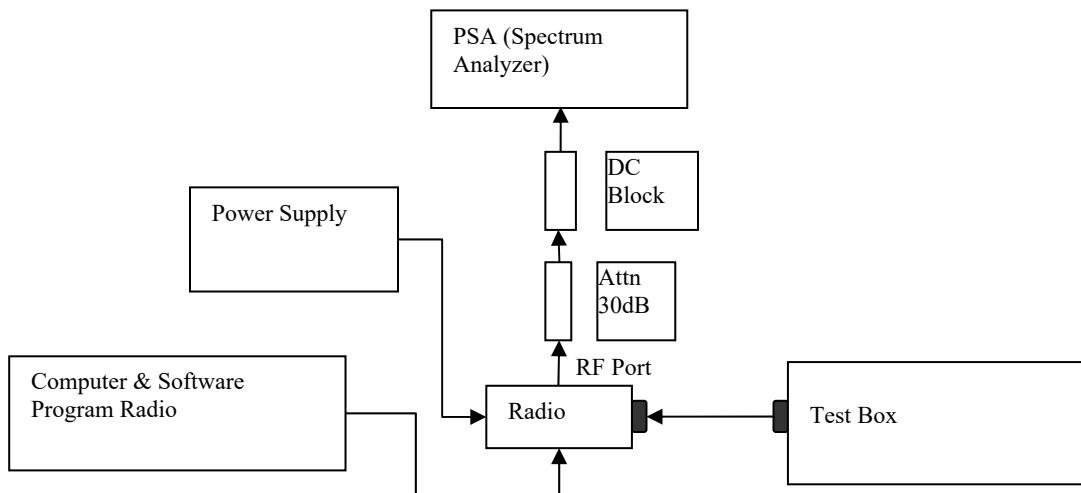

- 1) Program and set radio to operate in desire test frequency and digital mode with modulation. (\*4FSK, C4FM or other digital modulation form).
- 2) Path loss for the measurement included.
- 3) Select the Occupied Bandwidth measurement for 99% and 26dB Emissions Bandwidth Measurement.
- 4) Key in the Fc and Resolution Bandwidth.
- 5) Transmit radio record the occupied Bandwidth frequencies.
- 6) Preset the spectrum analyzer for band edge measurement.
- 7) Key in the lowest and highest channels frequency, span is 60 kHz and Resolution Bandwidth is at least 1% of Emission Bandwidth.
- 8) Save the screen shot.

\*Note:

- All digital modulation modes utilize the same high deviation test pattern, and they are therefore identical. Hence, only one plot per digital modulation scheme is shown

### 6.7.4. Test Result (Digital)

#### Max Power

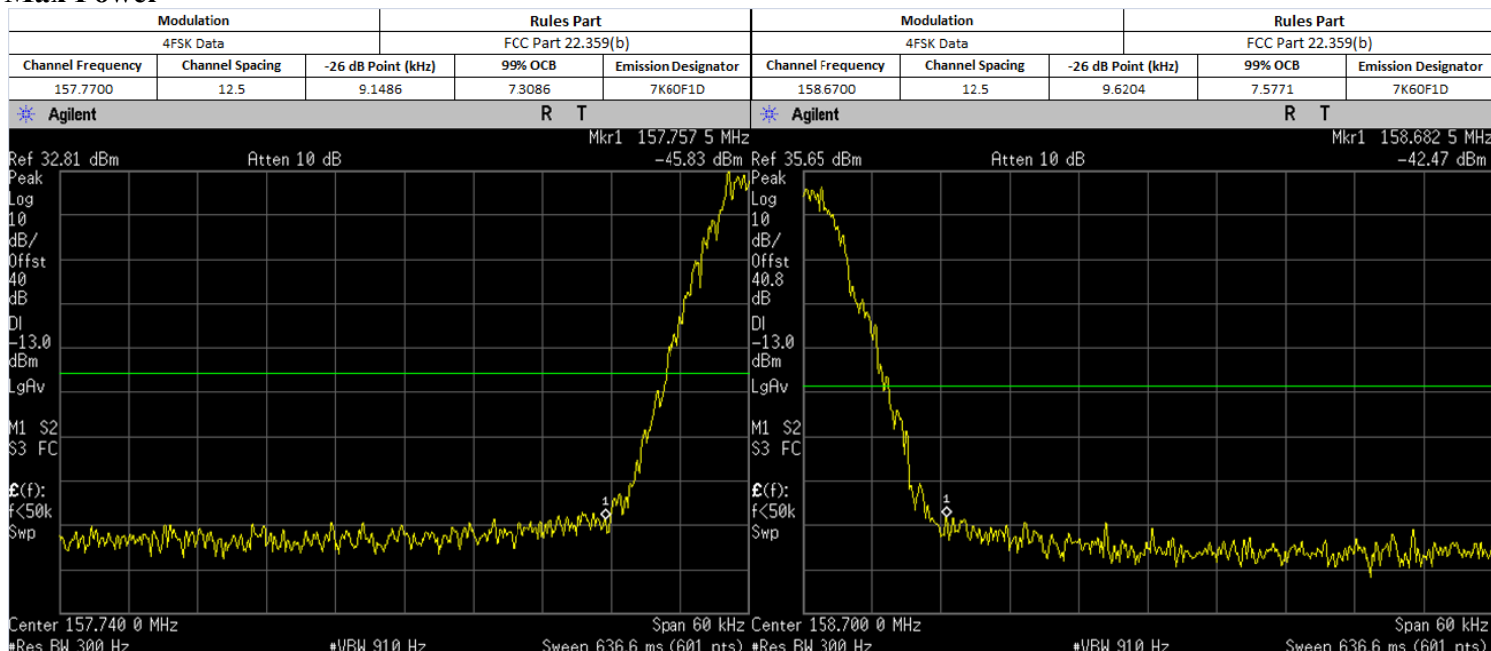

#### Low Power

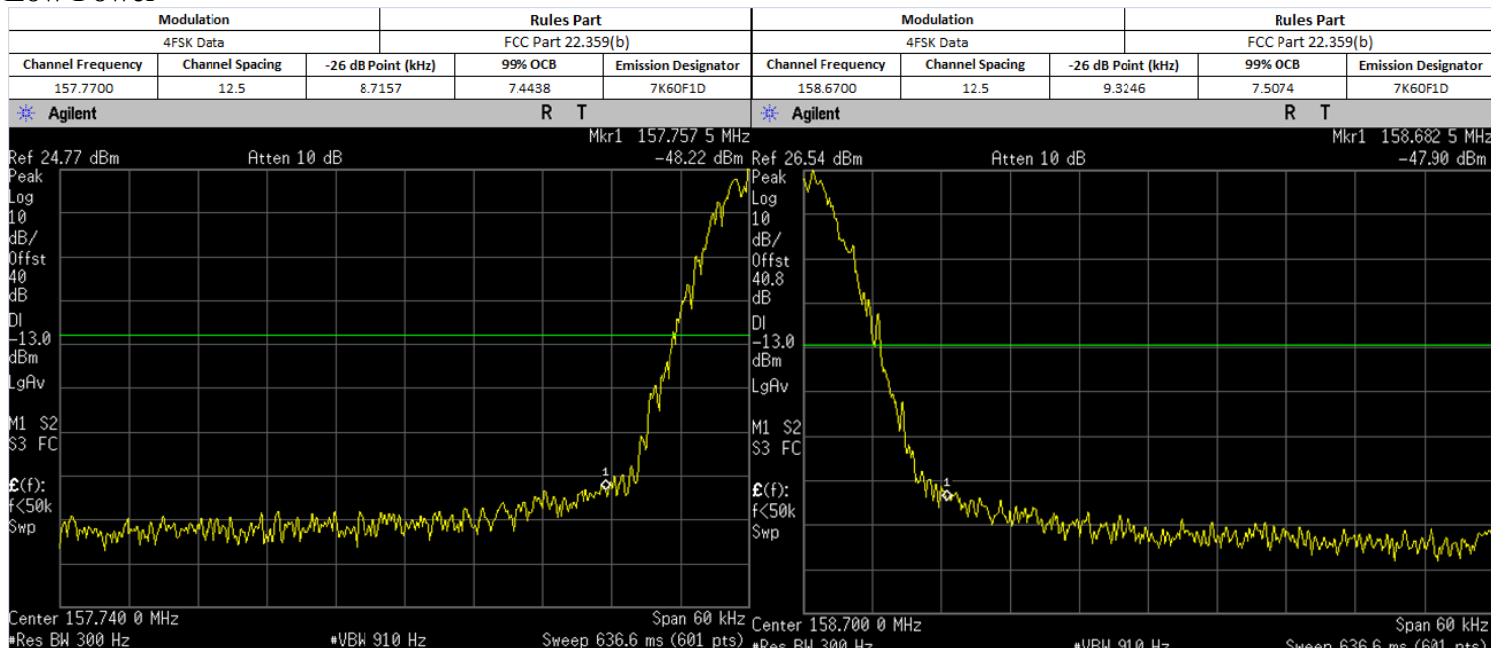

### Max Power

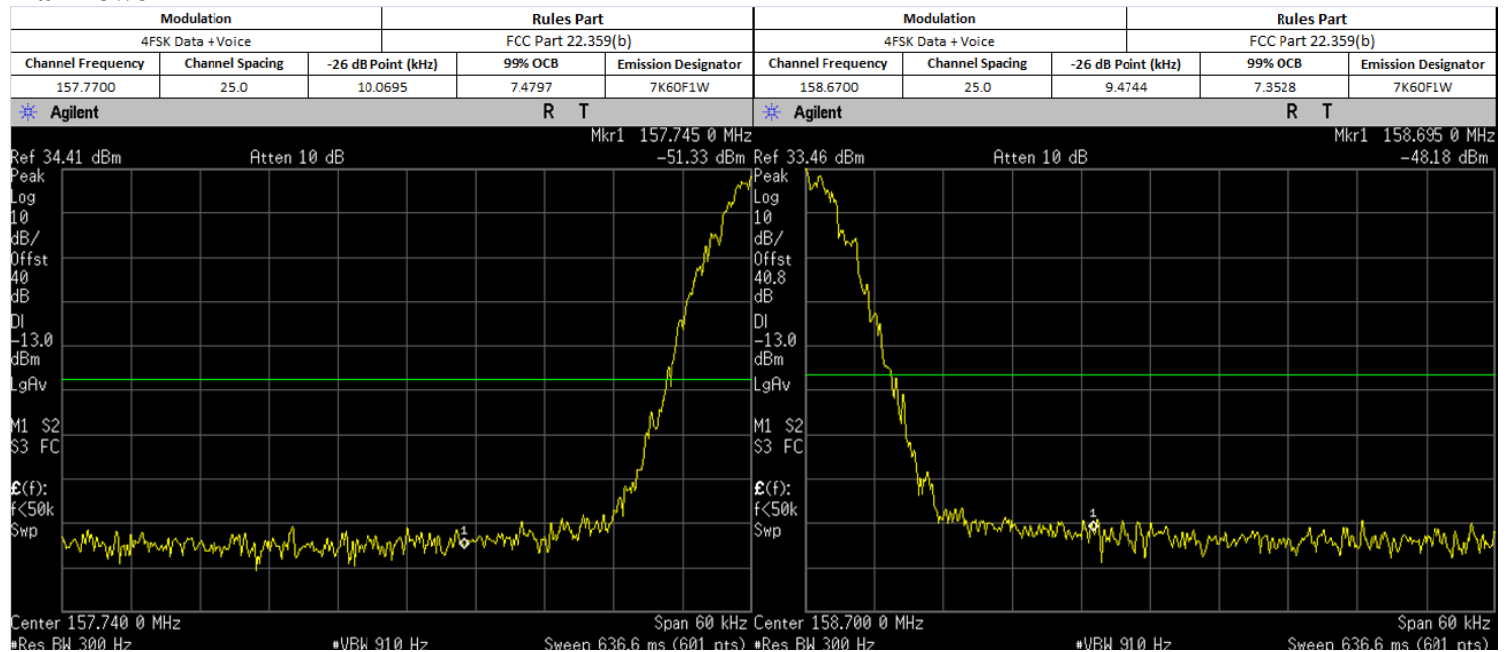

### Low Power

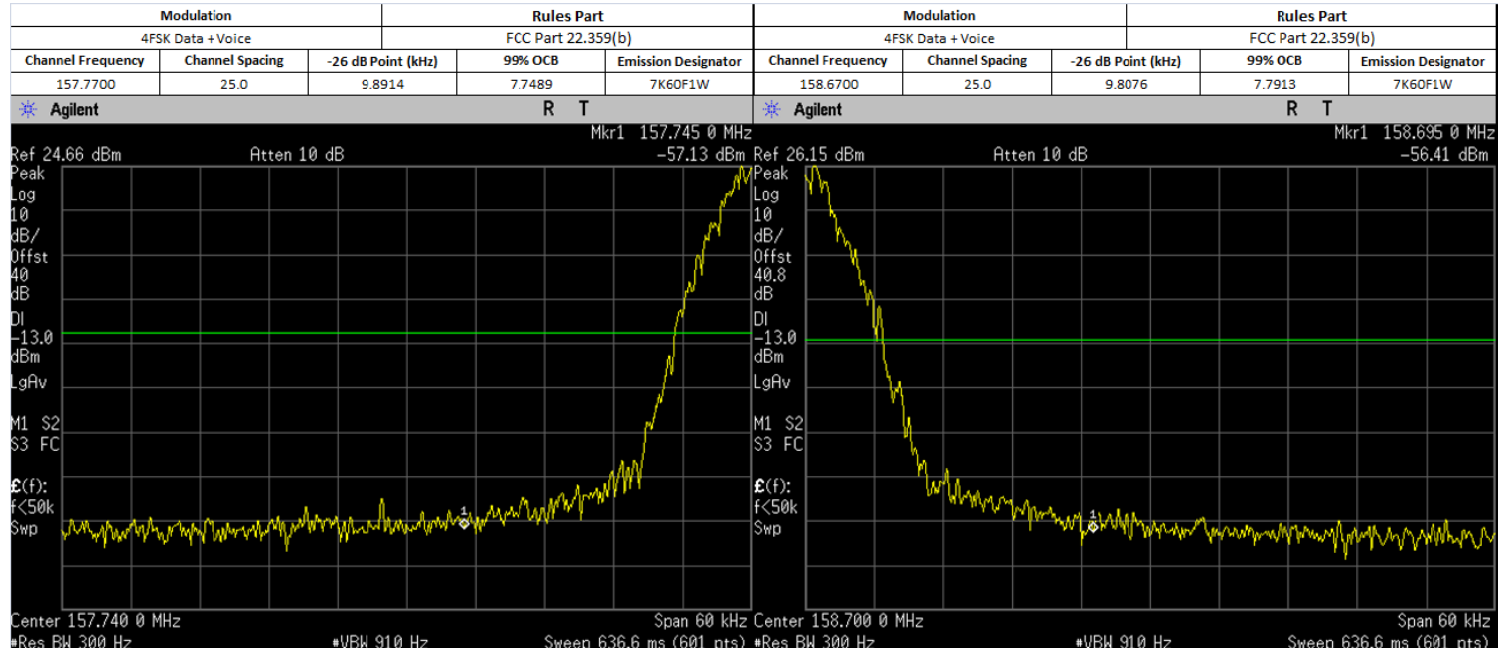

**6.7.5. Test Limit**

The power of any emission outside of the authorized operating frequency ranges must be attenuated below the transmitting power (P) by a factor of at least  $43 + 10 \log(P)$  dB.

## 6.8. Transient Frequency Behavior

### 6.8.1. Test Setup

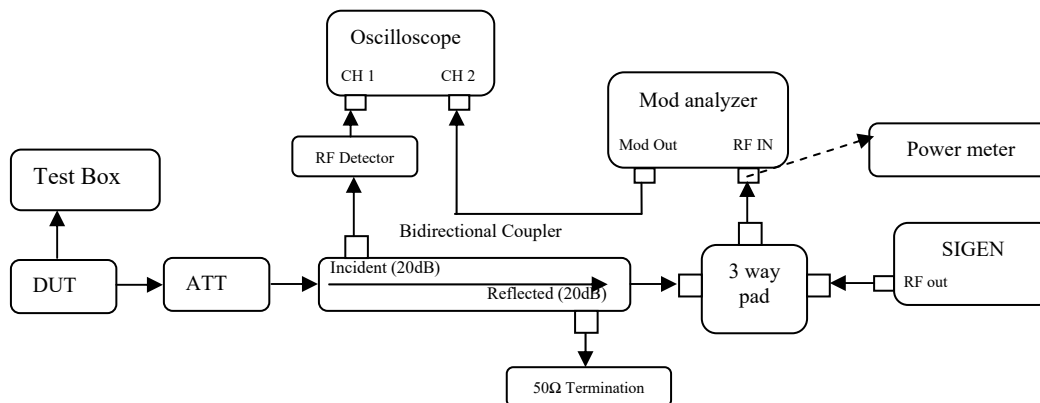

- 1) Connect the setup as figure above.
- 2) Path loss for the measurement included.
- 3) Set on Sigen with the assigned center frequency, internal 1 kHz FM tone.  
FM Deviation: Analog 25kHz Channel Spacing = 25 kHz  
Analog 12.5 kHz Channel Spacing = 12.5 kHz  
C4FM = 12.5 kHz
- 4) Turn on 50 kHz high pass filter and 15 kHz low pass filter on modulation analyzer.
- 5) Supply sufficient attenuation ATT to provide the output power of  $\leq -11$ dBm into power meter when DUT is keying up.
- 6) Note the power level on power meter and dekey the DUT.
- 7) Adjust the amplitude of the signal generator to the level power meter, maintained the amplitude throughout the rest of the measurement.
- 8) Connect the output to modulation analyzer.
- 9) Reduce 30dB attenuation and transmit the radio to get the trigger line.
- 10) Capture the screen shot for key-up (rising edge) and de-key (falling edge) mode.

### 6.8.2. Test Result

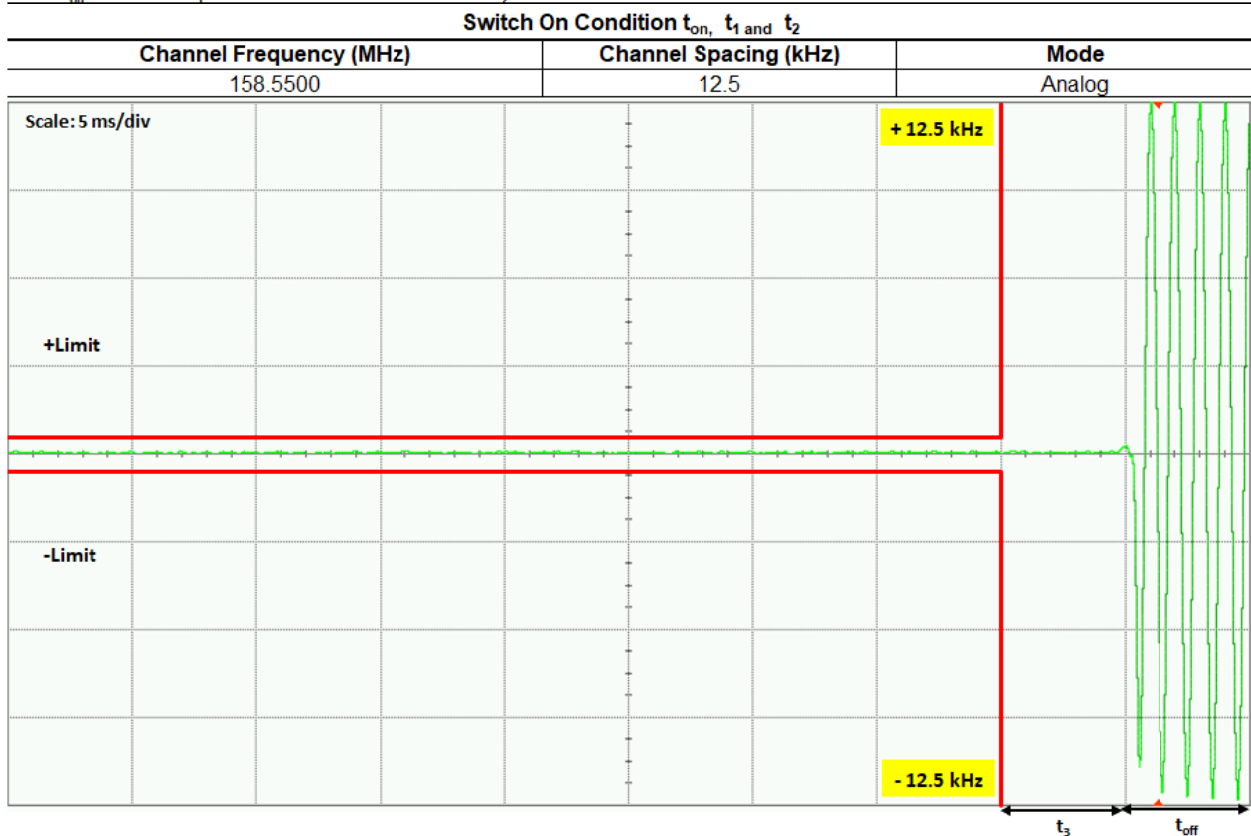
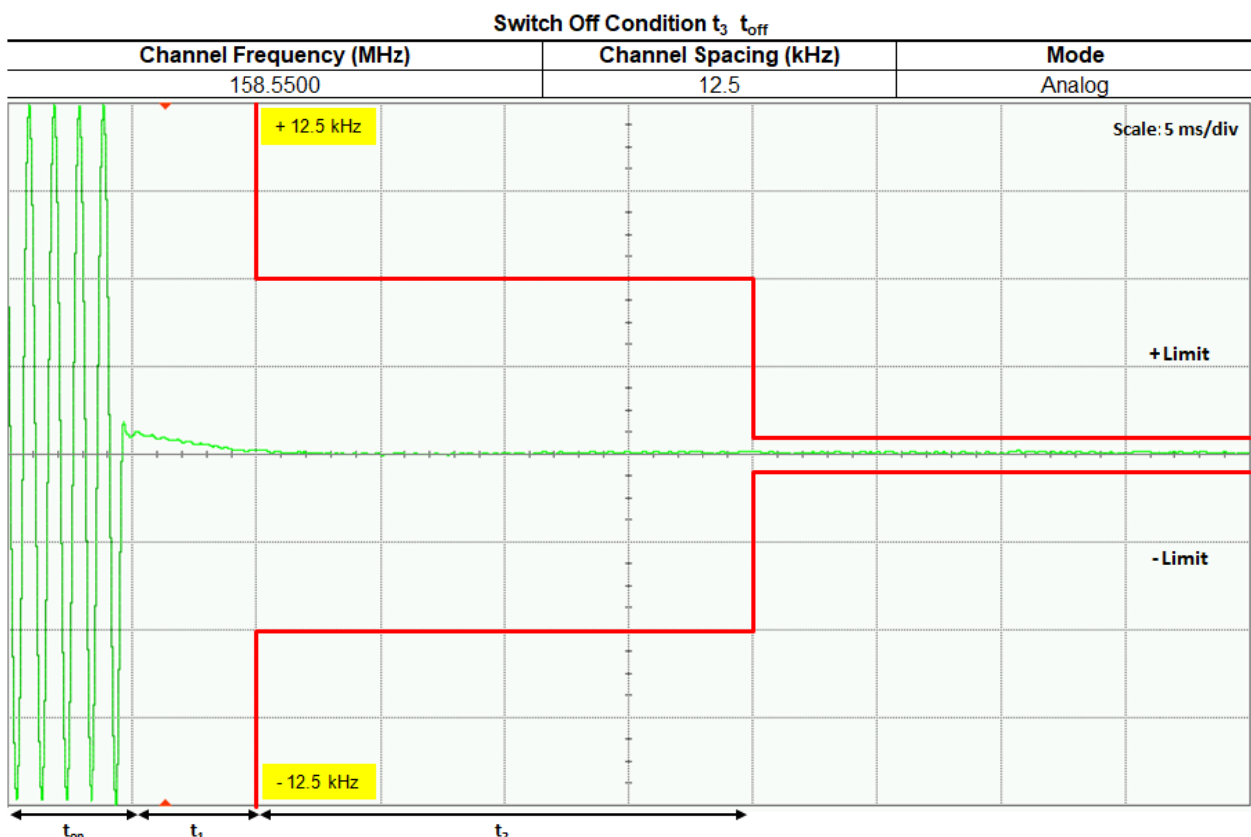



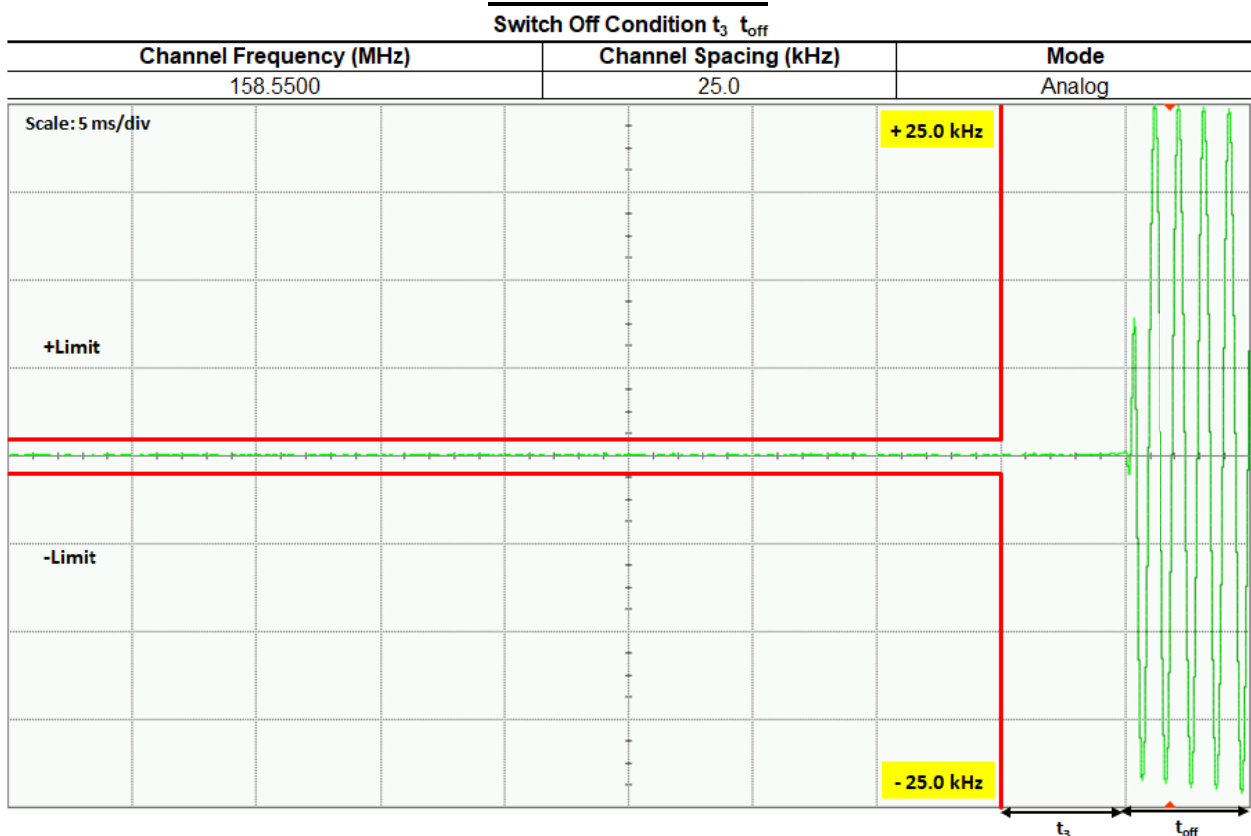
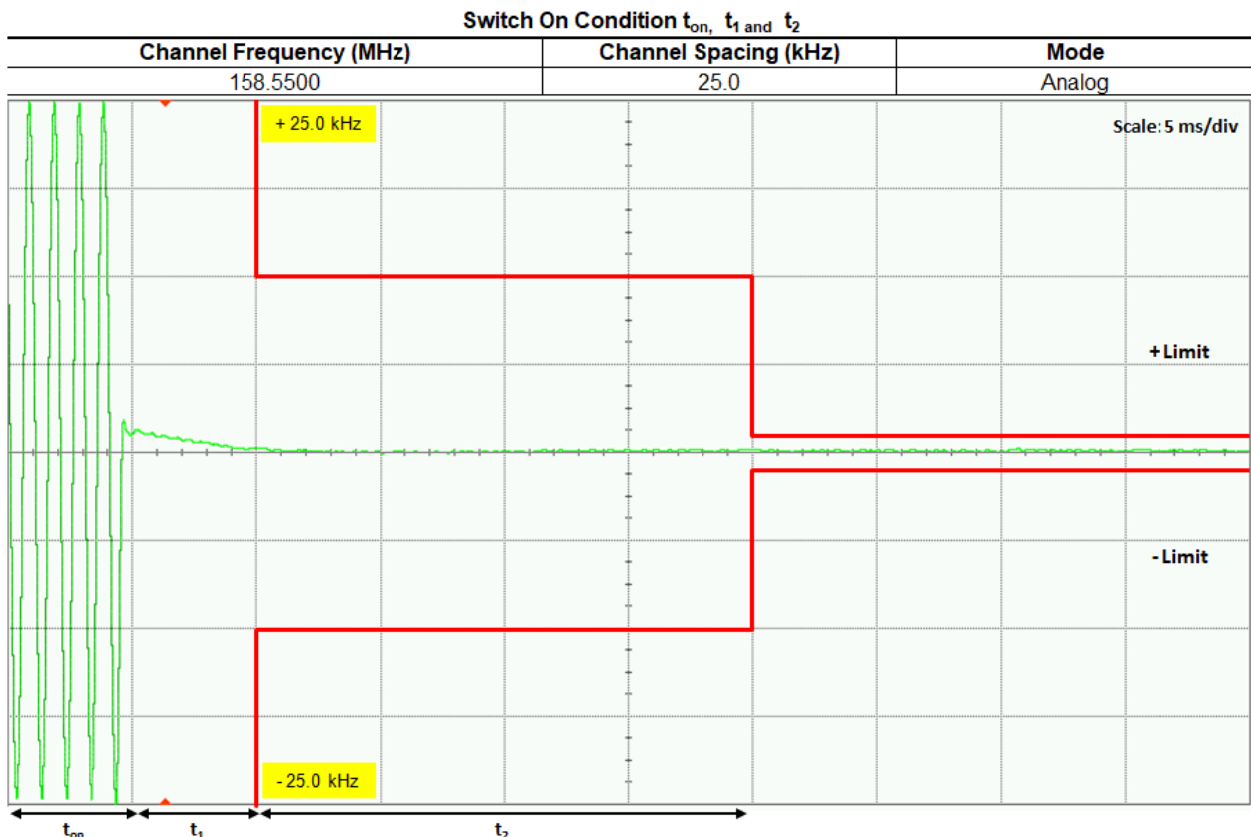

### 6.8.3. Test Limit

Transmitters designed to operate in the 150-174 MHz and 421-512 MHz frequency bands must maintain transient frequencies within the maximum frequency difference limits during the time intervals indicated:

Time intervals <sup>1 2</sup>	Maximum frequency difference <sup>3</sup>	All equipment	
		150 to 174 MHz	421 to 512 MHz
Transient Frequency Behavior for Equipment Designed to Operate on 25 kHz Channels			
t <sub>1</sub> <sup>4</sup>	±25.0 kHz	5.0 ms	10.0 ms
t <sub>2</sub>	±12.5 kHz	20.0 ms	25.0 ms
t <sub>3</sub> <sup>4</sup>	±25.0 kHz	5.0 ms	10.0 ms
Transient Frequency Behavior for Equipment Designed to Operate on 12.5 kHz Channels			
t <sub>1</sub> <sup>4</sup>	±12.5 kHz	5.0 ms	10.0 ms
t <sub>2</sub>	±6.25 kHz	20.0 ms	25.0 ms
t <sub>3</sub> <sup>4</sup>	±12.5 kHz	5.0 ms	10.0 ms
Transient Frequency Behavior for Equipment Designed to Operate on 6.25 kHz Channels			
t <sub>1</sub> <sup>4</sup>	±6.25 kHz	5.0 ms	10.0 ms
t <sub>2</sub>	±3.125 kHz	20.0 ms	25.0 ms
t <sub>3</sub> <sup>4</sup>	±6.25 kHz	5.0 ms	10.0 ms

<sup>1</sup> t<sub>on</sub> is the instant when a 1 kHz test signal is completely suppressed, including any capture time due to phasing.

t<sub>1</sub> is the time period immediately following t<sub>on</sub>.

t<sub>2</sub> is the time period immediately following t<sub>1</sub>.

t<sub>3</sub> is the time period from the instant when the transmitter is turned off until t<sub>off</sub>.

t<sub>off</sub> is the instant when the 1 kHz test signal starts to rise.

<sup>2</sup> During the time from the end of t<sub>2</sub> to the beginning of t<sub>3</sub>, the frequency difference must not exceed the limits specified in §90.213.

<sup>3</sup> Difference between the actual transmitter frequency and the assigned transmitter frequency.

<sup>4</sup> If the transmitter carrier output power rating is 6 watts or less, the frequency difference during this time period may exceed the maximum frequency difference for this time period.

## 6.9. Adjacent Channel Power

### 6.9.1. Test Setup (Analog)

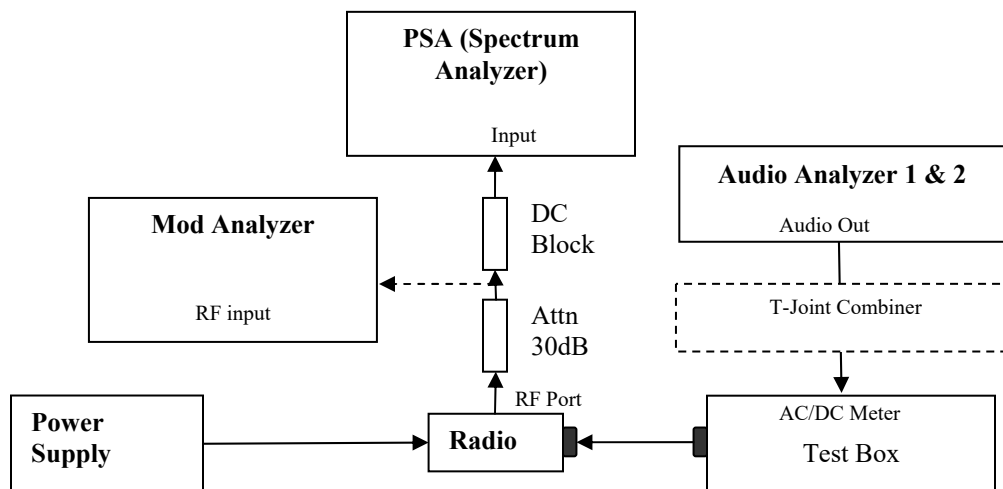

- 1) The DUT transmitter output port was connected to modulation analyzer.
- 2) Transmit the radio and turn on 1<sup>st</sup> audio analyzer with audio frequency 650Hz, 50% rated deviation, and record the amplitude value as AmpT1.
- 3) Turn off Audio analyzer 1 and turn on audio analyzer 2, set the audio frequency to 2.2 kHz and 50% deviation. Record the amplitude as AmpT2.
- 4) Turn both audio analyzers ON and up 10dB amplitude level.
- 5) Connect the output to PSA and set to assigned center frequency.
- 6) Set Span, Resolution Bandwidth and Video Bandwidth per rules part.
- 7) Transmit the radio and record the Adjacent Channel Power value in dBc.

### 6.9.2. Test Result(Analog) NA → Not Applicable

### 6.9.3. Test Setup (Digital)

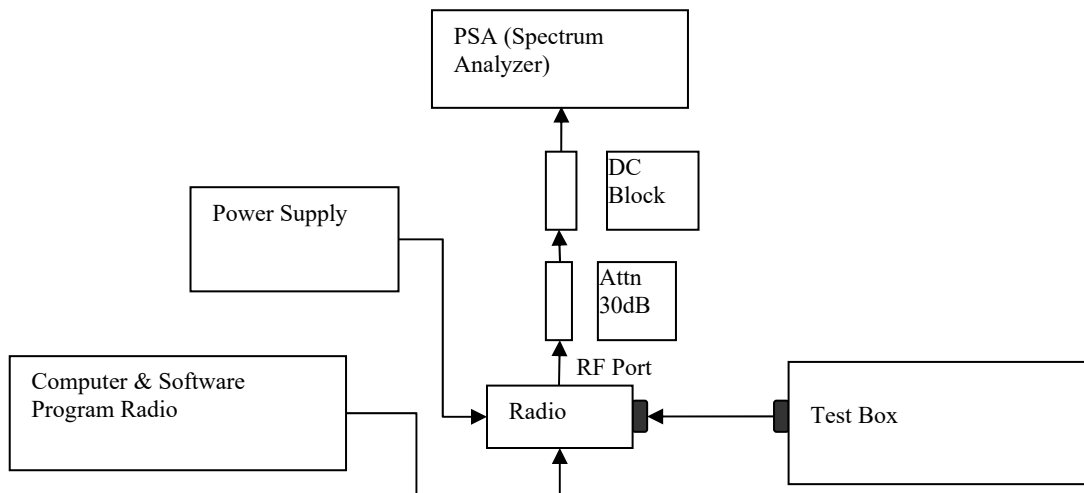

- 1) Program and set radio to operate in desire test frequency and digital mode with modulation. (4FSK, C4FM or other digital modulation form).
- 2) Prepare setup as per picture.
- 3) Turn on the ACP Measurement – Press Measure, ACP.
- 4) Set Span, Resolution Bandwidth and Video Bandwidth as per rules part.
- 5) Transmit the radio and record the Adjacent Channel Power value in dBc.

### 6.9.4. Test Result (Digital) NA → Not Applicable

**6.9.5. Test limit**

**12.5 kHz MOBILE TRANSMITTER ACP REQUIREMENTS**

Offset from center frequency (kHz)	Measurement bandwidth (kHz)	Maximum ACP relative (dBc)
9.375	6.25	-40
15.625	6.25	-60
21.875	6.25	-60
37.50	25.00	-60
62.50	25.00	-65
87.50	25.00	-65
150.00	100	-65
250.00	100	-65
350.00	100	-65
>400 to 12 MHz	30 (s)	-75
12 MHz to paired receive band	30 (s)	-75
In the paired receive band	30 (s)	-100

**25 kHz MOBILE TRANSMITTER ACP REQUIREMENTS**

Offset from center frequency (kHz)	Measurement bandwidth (kHz)	Maximum ACP relative (dBc)
15.625	6.25	-40
21.875	6.25	-60
37.50	25	-60
62.50	25	-65
87.50	25	-65
150.00	100	-65
250.00	100	-65
350.00	100	-65
>400 kHz to 12 MHz	30 (s)	-75
12 MHz to paired receive band	30 (s)	-75
In the paired receive band	30 (s)	-100

**12.5 kHz BASE TRANSMITTER ACP REQUIREMENTS**

Offset from center frequency (kHz)	Measurement bandwidth (kHz)	Maximum ACP (dBc)
9.375	6.25	-40
15.625	6.25	-60
21.875	6.25	-60
37.5	25	-60
62.5	25	-65
87.5	25	-65
150	100	-65
250	100	-65
350.00	100	-65
>400 kHz to 12 MHz	30 (s)	-80
12 MHz to paired receive band	30 (s)	-80
In the paired receive band	30 (s)	1-85

**25 kHz BASE TRANSMITTER ACP REQUIREMENTS**

Offset from center frequency (kHz)	Measurement bandwidth (kHz)	Maximum ACP (dBc)
15.625	6.25	-40
21.875	6.25	-60
37.5	25	-60
62.5	25	-65
87.5	25	-65
150	100	-65
250	100	-65
350	100.00	-65
>400 kHz to 12 MHz	30 (s)	-80
12 MHz to paired receive band	30 (s)	-80
In the paired receive band	30 (s)	1-85

## 6.10. Conducted Spurious Emission

### 6.10.1. Test Setup

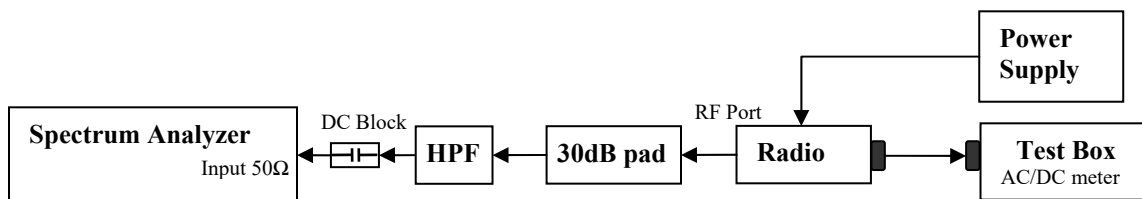

- 1) The DUT transmitter output port was connected to Spectrum Analyzer with above setup.
- 2) Program and set radio to operate in desire test frequency and mode. (Analog / digital modulation form).
- 3) Path loss for the measurement included.
- 4) Set the PSA Resolution Bandwidth as per rules part.
- 5) Set the Ref offset from the pathloss offset calibration file.
- 6) Adjust the center frequency of the spectrum analyzer for incremental coverage of the range from:
  - a. 9 KHz to  $F_c - \text{Test Bandwidth}$
  - b.  $F_c + \text{Test Bandwidth}$  to  $2F_c - 5\text{MHz}$ .
- 7) Key up the DUT, Peak Search the highest Spur and record the levels of spurious emissions
- 8) Dekey the DUT.
- 9) Turn On High Pass Filter path and Key up the DUT.
- 10) Adjust the PSA Freq for incremental coverage of range from  $2F_c$  to  $10F_c$
- 11) Key up the DUT and record the highest spur levels of spurious emissions.

**6.10.2. Test Result (Analog)**

**Analog: 138.0125 MHz, 25.0kHz Channel Spacing, Max Power**  
**Not for FCC Review**

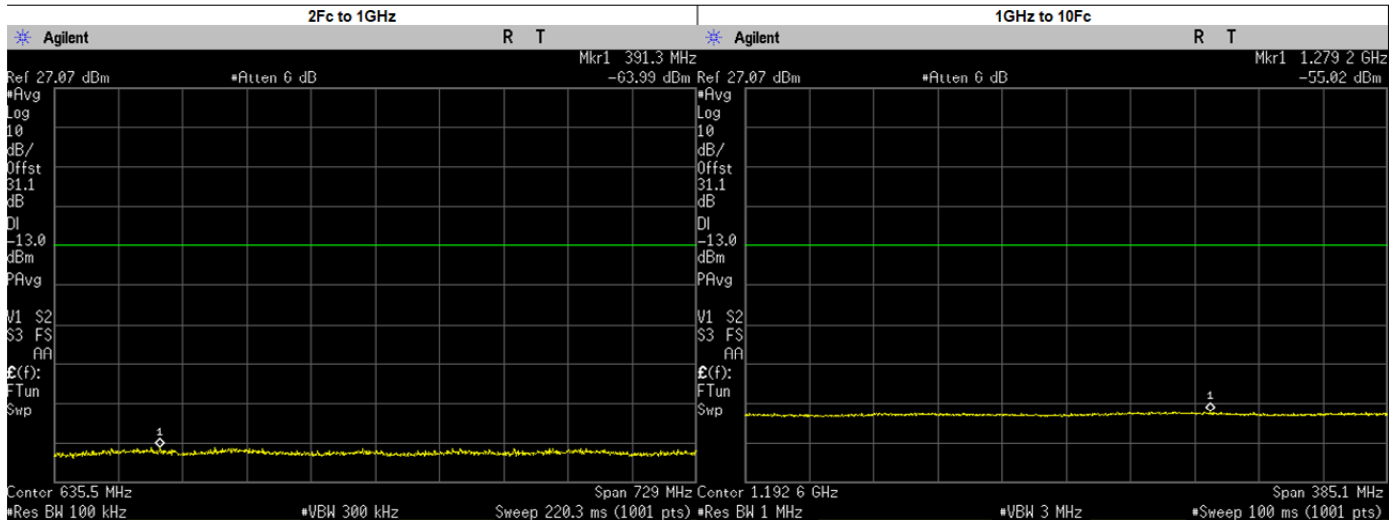
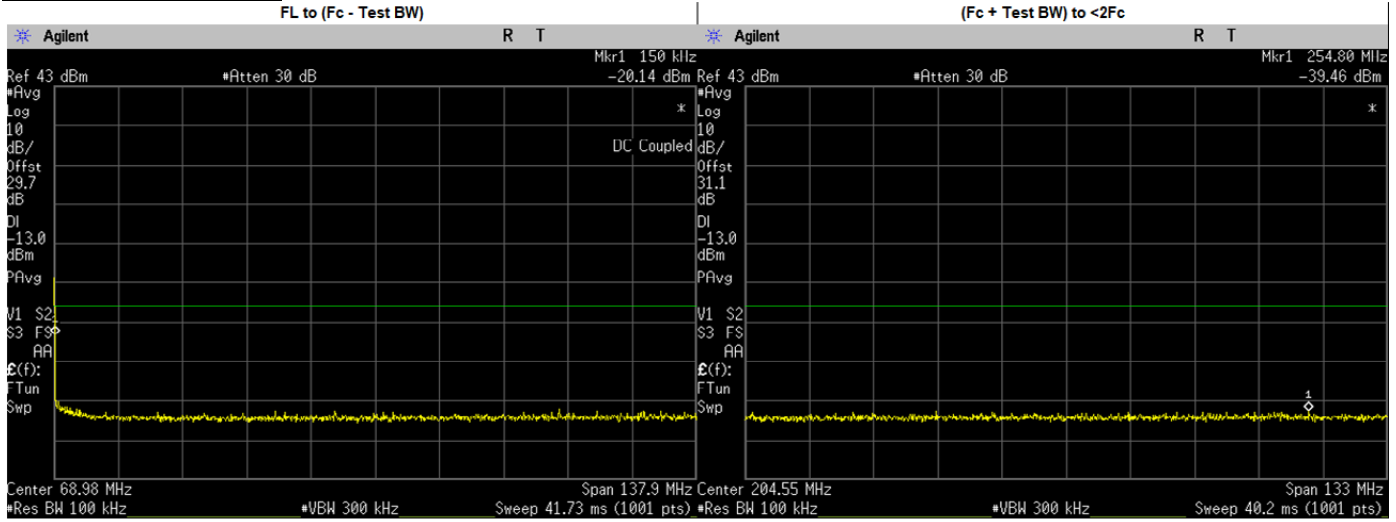

Frequency Range	Highest Spur Frequency (MHz)	Spurious Level (dbm)	Failing Limit (dBm)	Results
FL to (Fc - Test BW)	0.8367	-37.2500	-13	PASS
(Fc + Test BW) to <2Fc	254.8043	-39.4600	-13	PASS
2Fc to 1GHz	391.3059	-63.9900	-13	PASS
	276.0250	-65.9125	-13	PASS
	414.0375	-65.8278	-13	PASS
	552.0500	-65.8145	-13	PASS
	690.0625	-65.5798	-13	PASS
	828.0750	-64.9448	-13	PASS
	966.0875	-65.7634	-13	PASS
1GHz to 10Fc	1279.2160	-55.0200	-13	PASS
	1104.1000	-55.6403	-13	PASS
	1242.1120	-55.4754	-13	PASS
	1380.1250	-55.6636	-13	PASS



**Analog: 158.55 MHz, 25.0kHz Channel Spacing, Max Power  
 FCC Part 22, RSS 119**

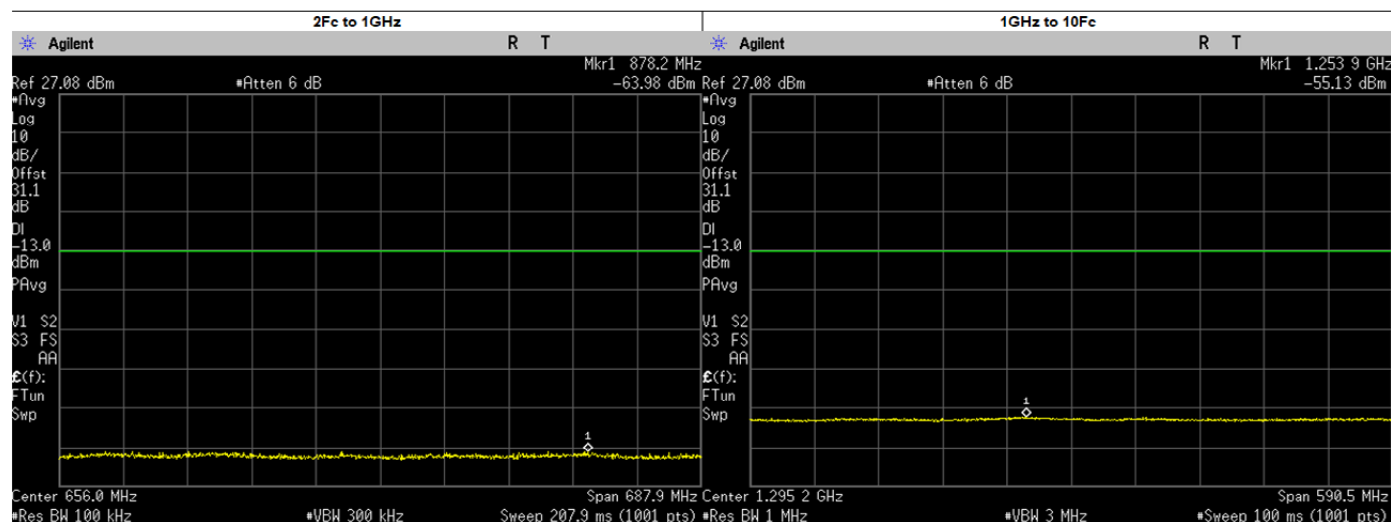
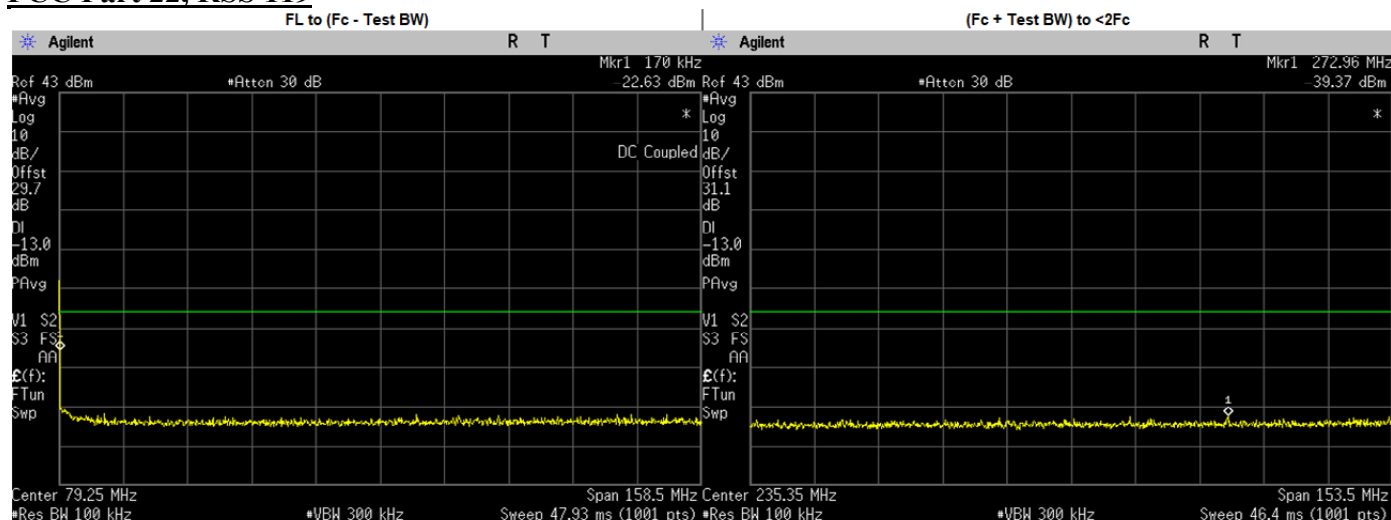

Frequency Range	Highest Spur Frequency (MHz)	Spurious Level (dbm)	Failing Limit (dBm)	Results
FL to (Fc - Test BW)	0.1675	-22.6963	-13	PASS
(Fc + Test BW) to <2Fc	272.9589	-39.3700	-13	PASS
2Fc to 1GHz	878.2417	-63.9800	-13	PASS
	317.1000	-65.2062	-13	PASS
	475.6500	-64.6200	-13	PASS
	634.2000	-65.1129	-13	PASS
	792.7500	-65.4388	-13	PASS
	951.3000	-65.2578	-13	PASS
1GHz to 10Fc	1253.9150	-55.1300	-13	PASS
	1109.8500	-55.5965	-13	PASS
	1268.4000	-55.4813	-13	PASS
	1426.9500	-55.8109	-13	PASS
	1585.5000	-55.8198	-13	PASS

**Analog: 158.55 MHz, 25.0kHz Channel Spacing, Low Power  
 FCC Part 22, RSS 119**

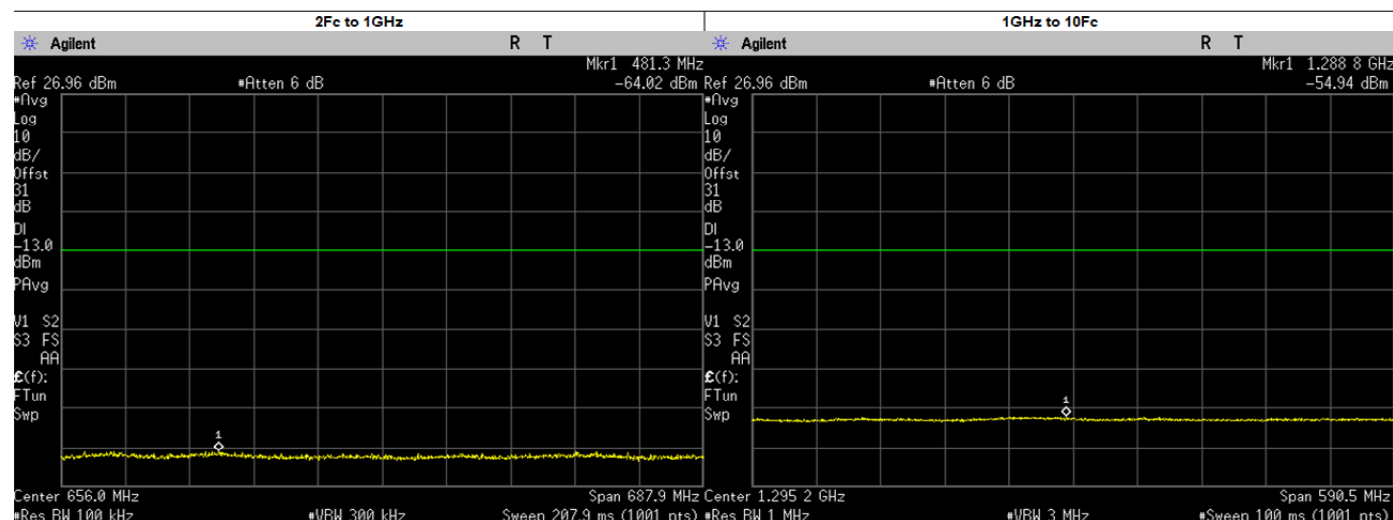
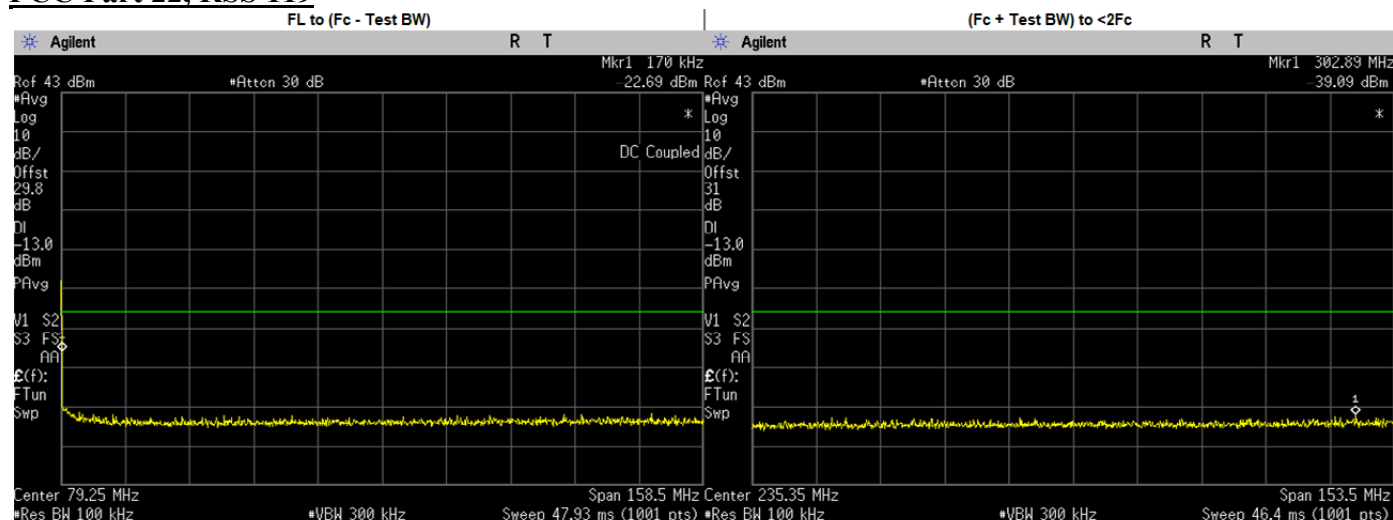

Frequency Range	Highest Spur Frequency (MHz)	Spurious Level (dbm)	Failing Limit (dBm)	Results
FL to (Fc - Test BW)	0.1675	-22.7768	-13	PASS
(Fc + Test BW) to <2Fc	302.8903	-39.0900	-13	PASS
2Fc to 1GHz	481.3234	-64.0200	-13	PASS
	317.1000	-65.5686	-13	PASS
	475.6500	-64.6419	-13	PASS
	634.2000	-65.6378	-13	PASS
	792.7500	-65.5806	-13	PASS
	951.3000	-66.0473	-13	PASS
1GHz to 10Fc	1288.8000	-54.9400	-13	PASS
	1109.8500	-55.7748	-13	PASS
	1268.4000	-55.5960	-13	PASS
	1426.9500	-55.8628	-13	PASS
	1585.5000	-55.8481	-13	PASS

**Analog: 161.7 MHz, 25.0kHz Channel Spacing, Max Power  
 RSS 119**

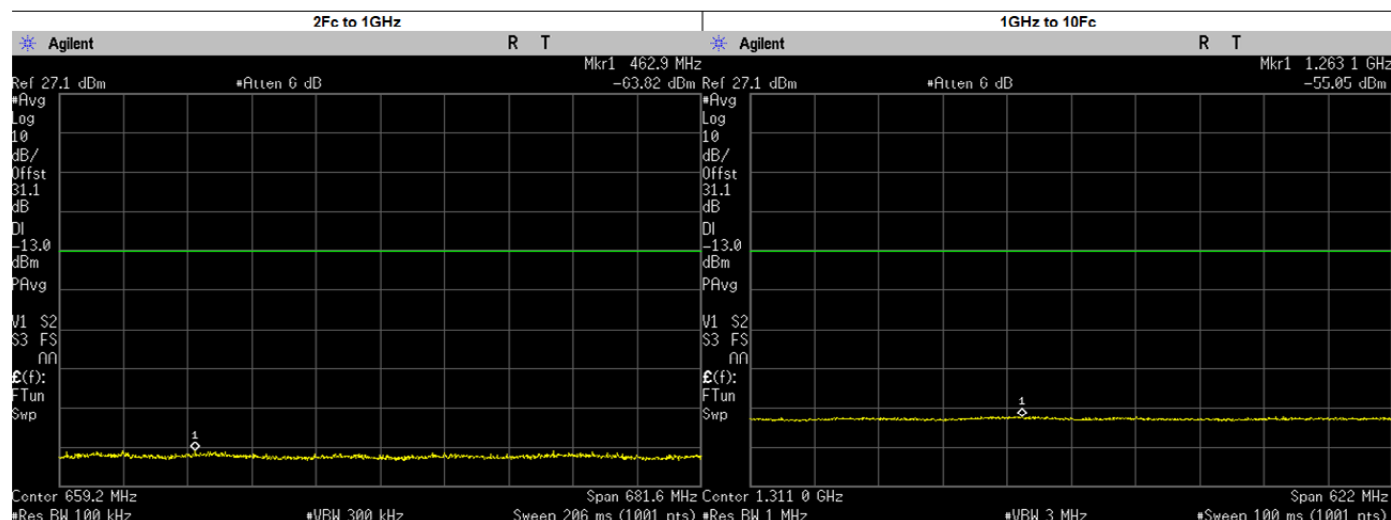
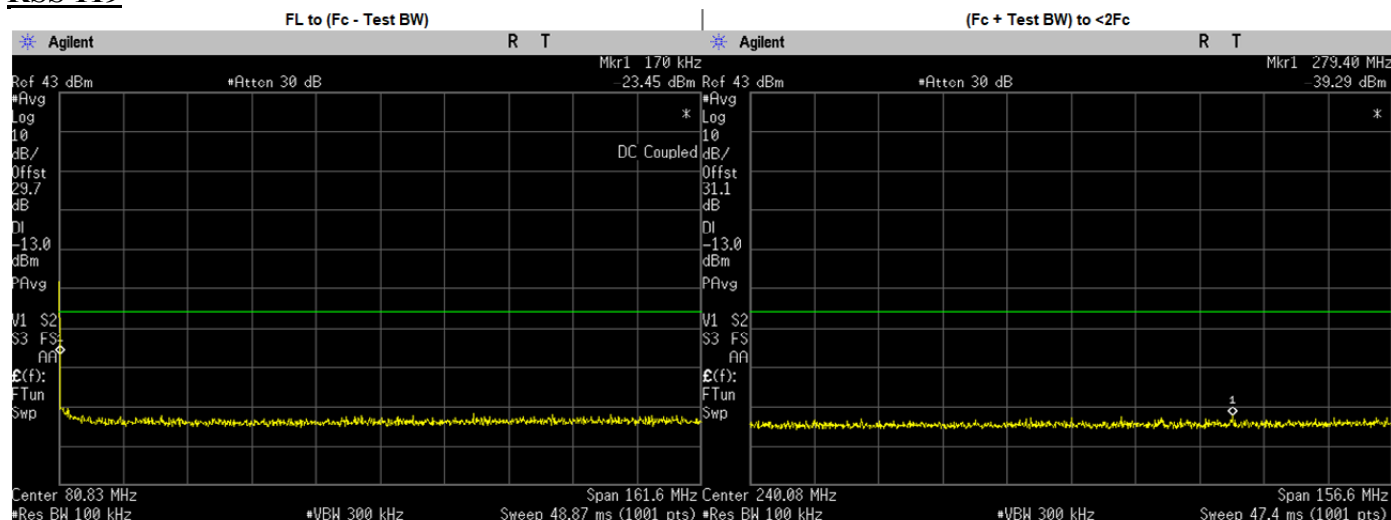

Frequency Range	Highest Spur Frequency (MHz)	Spurious Level (dbm)	Failing Limit (dBm)	Results
FL to (Fc - Test BW)	0.1706	-23.5116	-13	PASS
(Fc + Test BW) to <2Fc	279.3956	-39.2900	-13	PASS
2Fc to 1GHz	462.8992	-63.8200	-13	PASS
	323.4000	-65.2882	-13	PASS
	485.1000	-64.7214	-13	PASS
	646.8000	-65.4602	-13	PASS
	808.5000	-65.0120	-13	PASS
	970.2000	-65.7918	-13	PASS
1GHz to 10Fc	1263.1060	-55.0500	-13	PASS
	1131.9000	-55.7282	-13	PASS
	1293.6000	-55.6535	-13	PASS
	1455.3000	-55.8890	-13	PASS
	1617.0000	-55.5486	-13	PASS

**Analog: 161.7 MHz, 25.0kHz Channel Spacing, Low Power  
 RSS 119**

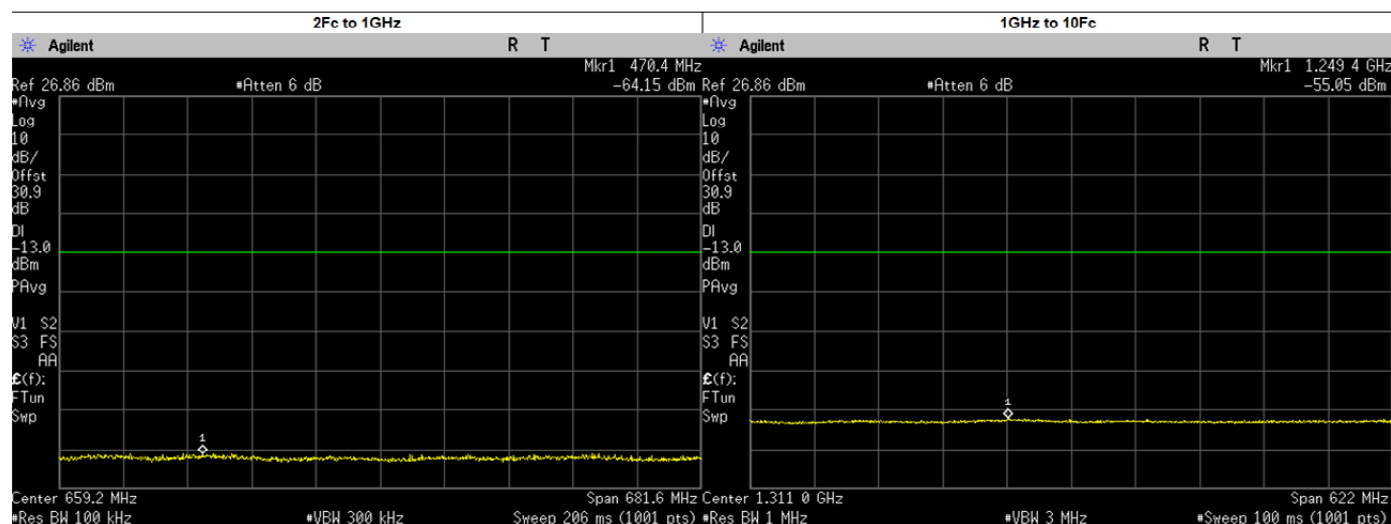
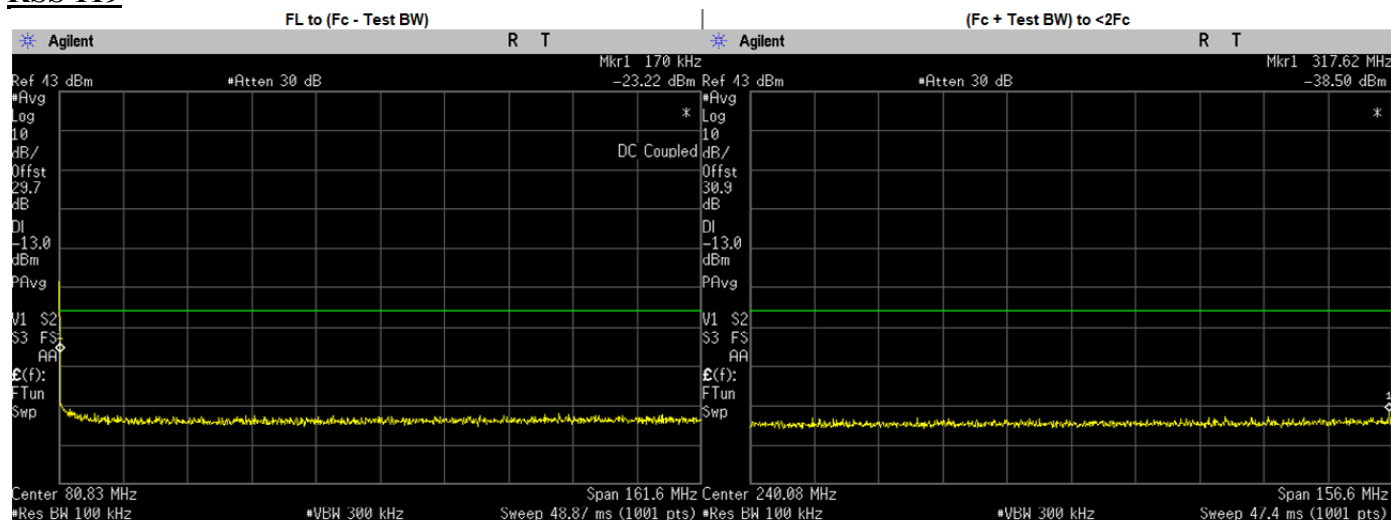

Frequency Range	Highest Spur Frequency (MHz)	Spurious Level (dbm)	Failing Limit (dBm)	Results
FL to (Fc - Test BW)	0.1706	-23.2816	-13	PASS
(Fc + Test BW) to <2Fc	317.6168	-38.5000	-13	PASS
2Fc to 1GHz	470.3968	-64.1500	-13	PASS
	323.4000	-65.1678	-13	PASS
	485.1000	-65.2953	-13	PASS
	646.8000	-65.5968	-13	PASS
	808.5000	-65.4176	-13	PASS
	970.2000	-65.7069	-13	PASS
1GHz to 10Fc	1249.4220	-55.0500	-13	PASS
	1131.9000	-56.0829	-13	PASS
	1293.6000	-55.9576	-13	PASS
	1455.3000	-56.0211	-13	PASS
	1617.0000	-55.9635	-13	PASS

**Analog: 173.3875 MHz, 25.0kHz Channel Spacing, Max Power**  
**Not for FCC Review**

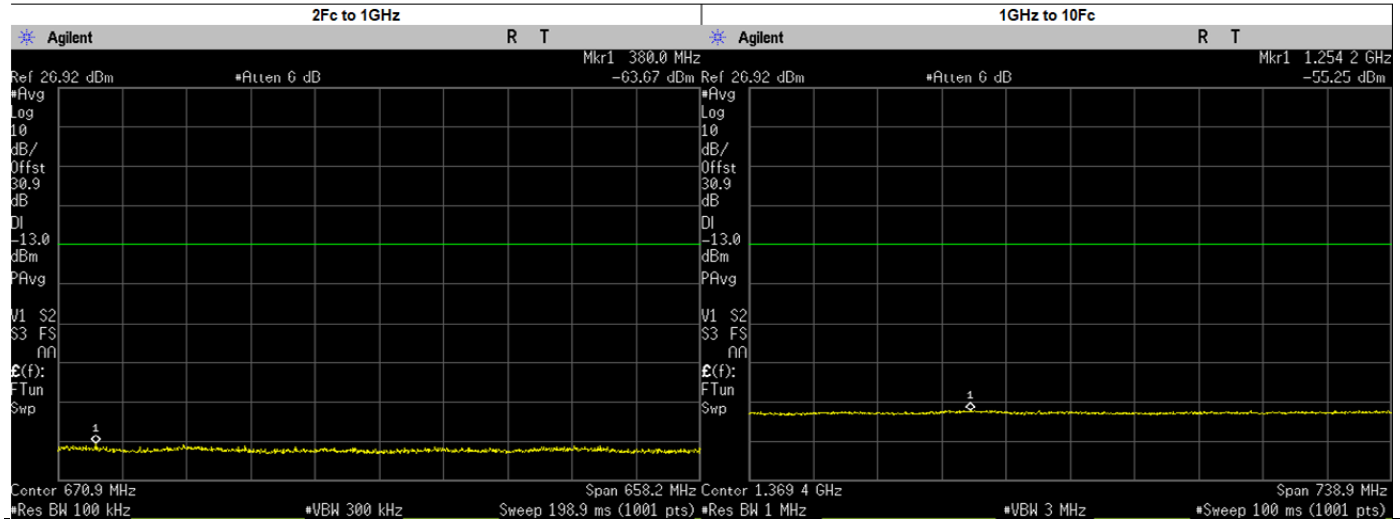
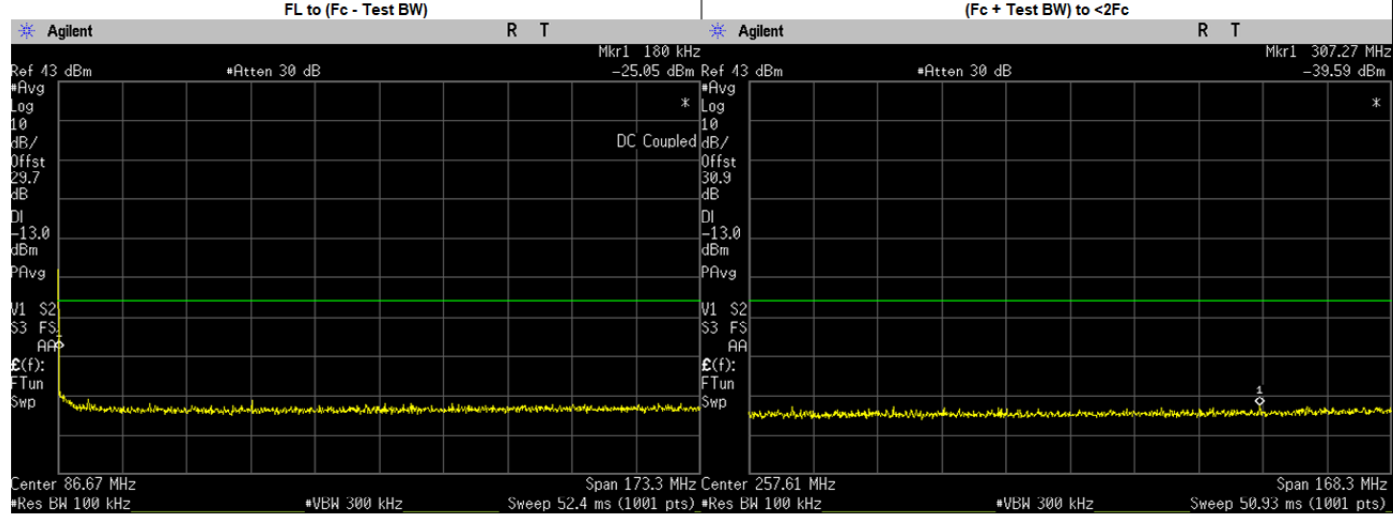

Frequency Range	Highest Spur Frequency (MHz)	Spurious Level (dbm)	Failing Limit (dBm)	Results
FL to (Fc - Test BW)	0.1823	-25.1133	-13	PASS
(Fc + Test BW) to <2Fc	307.2670	-39.5900	-13	PASS
2Fc to 1GHz	379.9520	-63.6700	-13	PASS
	346.7750	-64.9196	-13	PASS
	520.1625	-65.0769	-13	PASS
	693.5500	-65.3544	-13	PASS
	866.9375	-64.8505	-13	PASS
1GHz to 10Fc	1254.1730	-55.2500	-13	PASS
	1040.3250	-56.3060	-13	PASS
	1213.7130	-55.9744	-13	PASS
	1387.1000	-55.7042	-13	PASS
	1560.4870	-55.9866	-13	PASS
	1733.8750	-55.7700	-13	PASS

### 6.10.3. Test Result (Digital)

#### Digital: 138.0125 MHz, 12.5kHz Channel Spacing, Max Power

#### Not for FCC Review

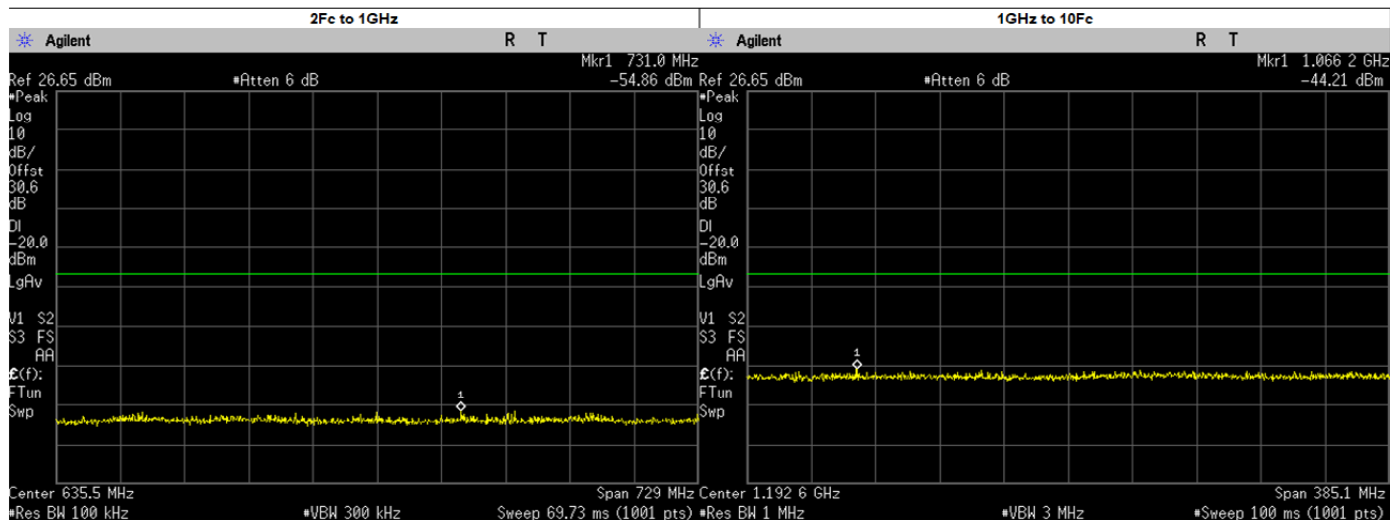
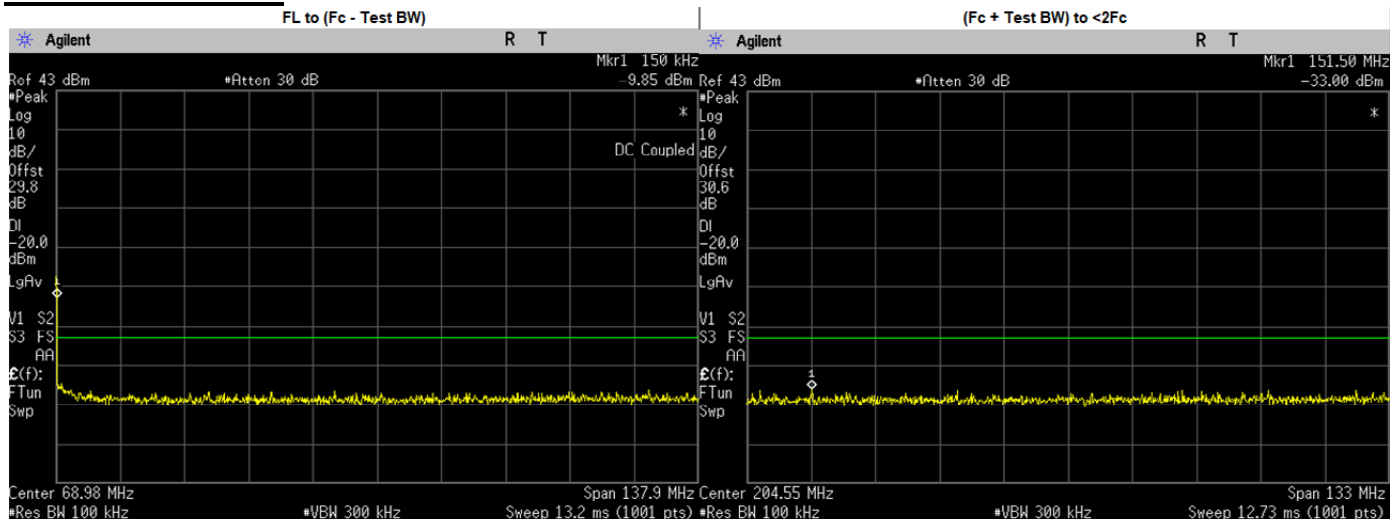

Frequency Range	Highest Spur Frequency (MHz)	Spurious Level (dbm)	Failing Limit (dBm)	Results
FL to (Fc - Test BW)	1.2505	-31.8562	-20	PASS
(Fc + Test BW) to <2Fc	151.4968	-33.0000	-20	PASS
2Fc to 1GHz	731.0082	-54.8600	-20	PASS
	276.0250	-57.3659	-20	PASS
	414.0375	-56.7573	-20	PASS
	552.0500	-57.3139	-20	PASS
	690.0625	-57.3974	-20	PASS
	828.0750	-57.2390	-20	PASS
1GHz to 10Fc	966.0875	-56.9561	-20	PASS
	1066.2420	-44.2100	-20	PASS
	1104.1000	-45.7375	-20	PASS
	1242.1120	-46.3009	-20	PASS
	1380.1250	-46.1282	-20	PASS

**Digital : 158.55 MHz, 12.5kHz Channel Spacing, Max Power  
 FCC Part 90, RSS 119**

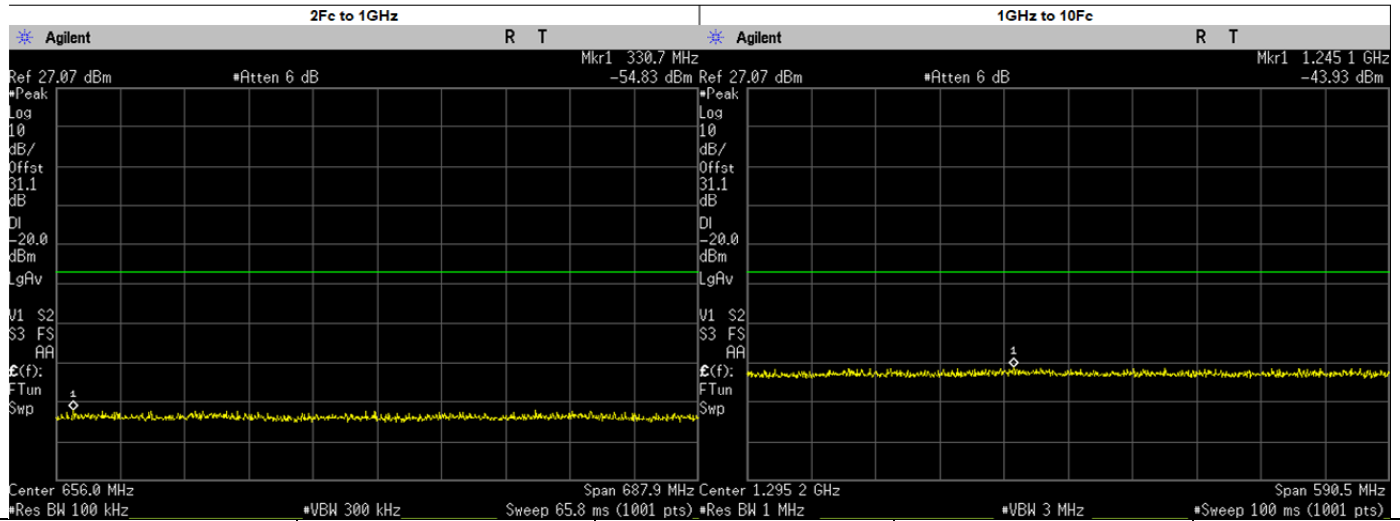
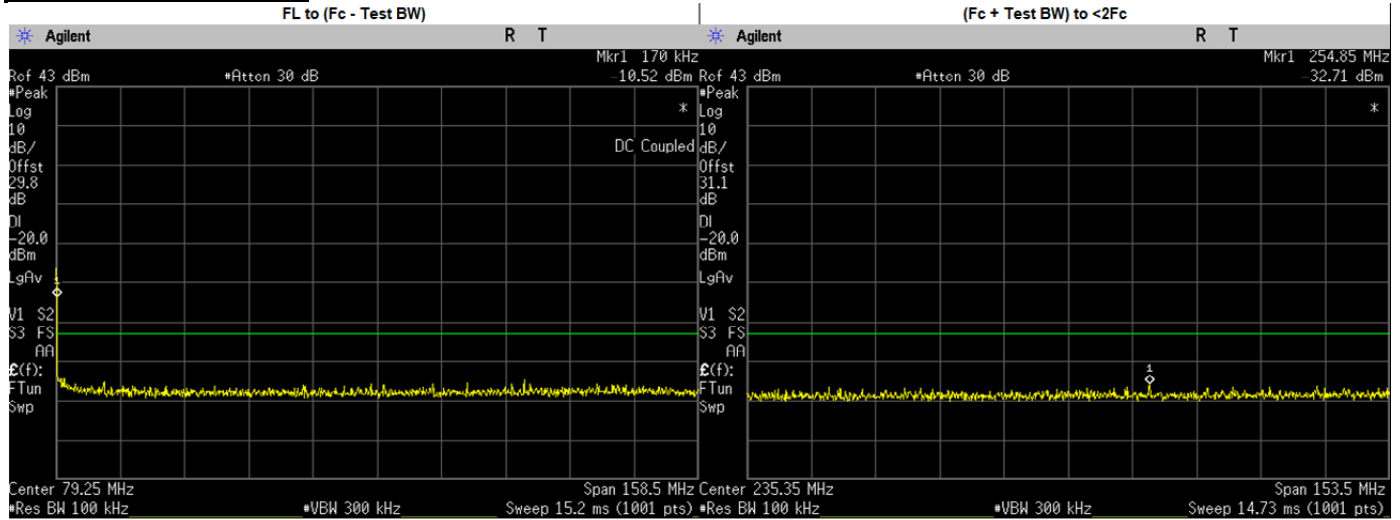

Frequency Range	Highest Spur Frequency (MHz)	Spurious Level (dbm)	Failing Limit (dBm)	Results
FL to (Fc - Test BW)	1.2769	-31.3662	-20	PASS
(Fc + Test BW) to <2Fc	254.8466	-32.7100	-20	PASS
2Fc to 1GHz	330.6733	-54.8300	-20	PASS
	317.1000	-57.2343	-20	PASS
	475.6500	-56.0968	-20	PASS
	634.2000	-56.8361	-20	PASS
	792.7500	-57.1271	-20	PASS
	951.3000	-56.6523	-20	PASS
1GHz to 10Fc	1245.0570	-43.9300	-20	PASS
	1109.8500	-46.2764	-20	PASS
	1268.4000	-45.6513	-20	PASS
	1426.9500	-45.7855	-20	PASS
	1585.5000	-45.8695	-20	PASS



**Digital: 158.55 MHz, 12.5kHz Channel Spacing, Low Power  
 FCC Part 90, RSS 119**

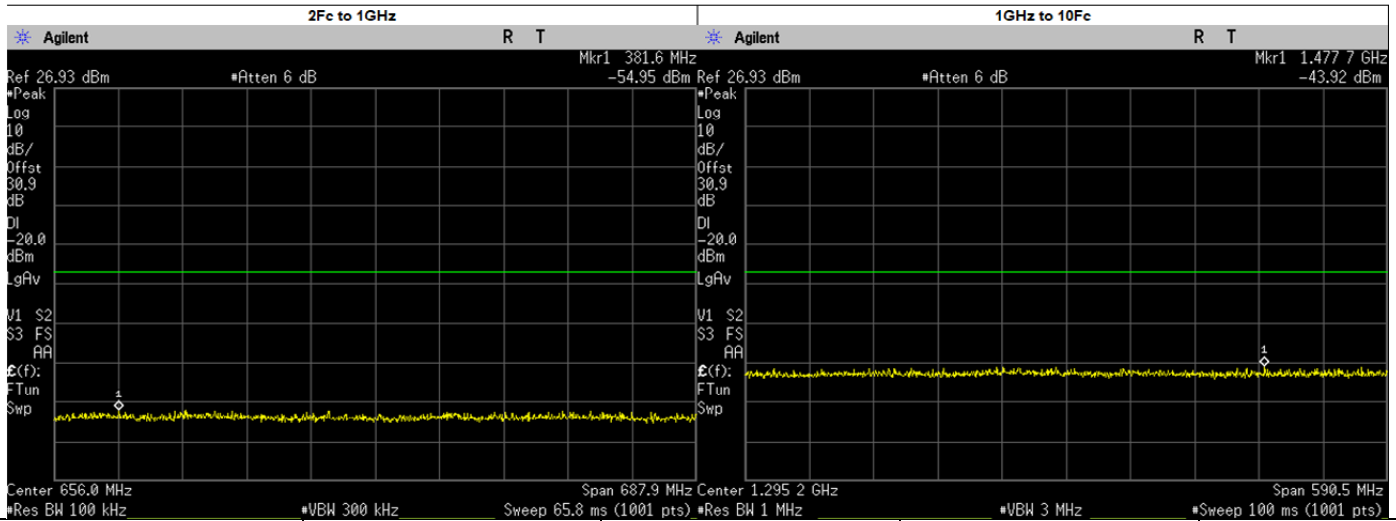
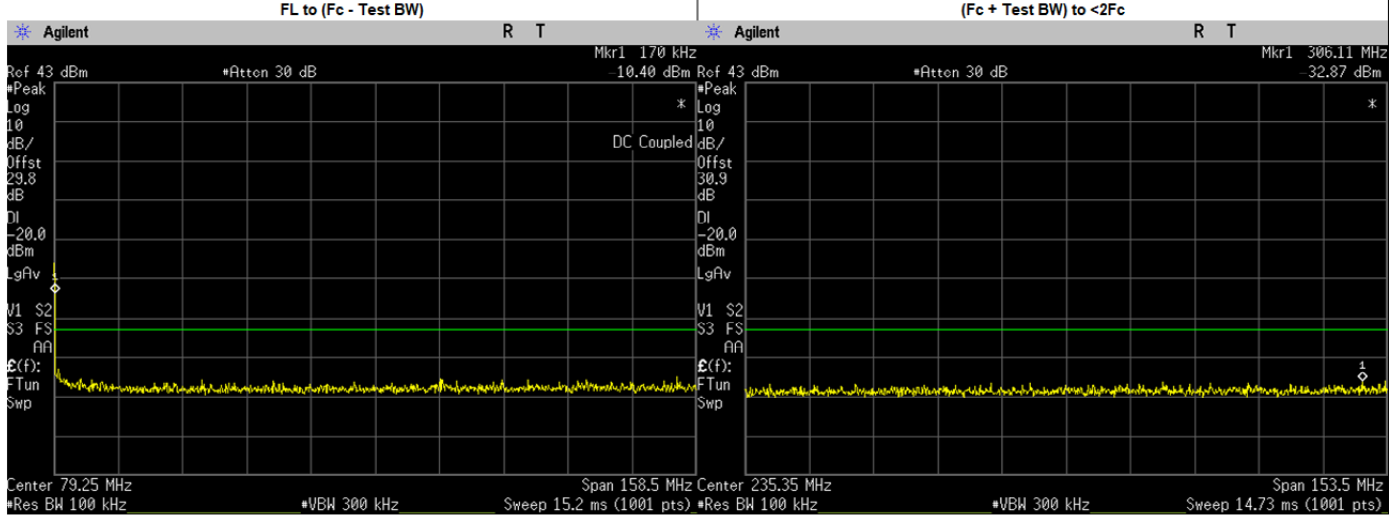

Frequency Range	Highest Spur Frequency (MHz)	Spurious Level (dbm)	Failing Limit (dBm)	Results
FL to (Fc - Test BW)	1.1184	-29.8868	-20	PASS
(Fc + Test BW) to <2Fc	306.1137	-33.8700	-20	PASS
2Fc to 1GHz	381.5779	-54.9500	-20	PASS
	317.1000	-56.9919	-20	PASS
	475.6500	-55.9140	-20	PASS
	634.2000	-57.4998	-20	PASS
	792.7500	-57.4043	-20	PASS
	951.3000	-57.0556	-20	PASS
1GHz to 10Fc	1477.7150	-43.9200	-20	PASS
	1109.8500	-46.3693	-20	PASS
	1268.4000	-45.8889	-20	PASS
	1426.9500	-46.0078	-20	PASS
	1585.5000	-46.3501	-20	PASS



**Digital : 161.7 MHz, 12.5kHz Channel Spacing, Max Power  
 FCC Part 90, RSS 119**

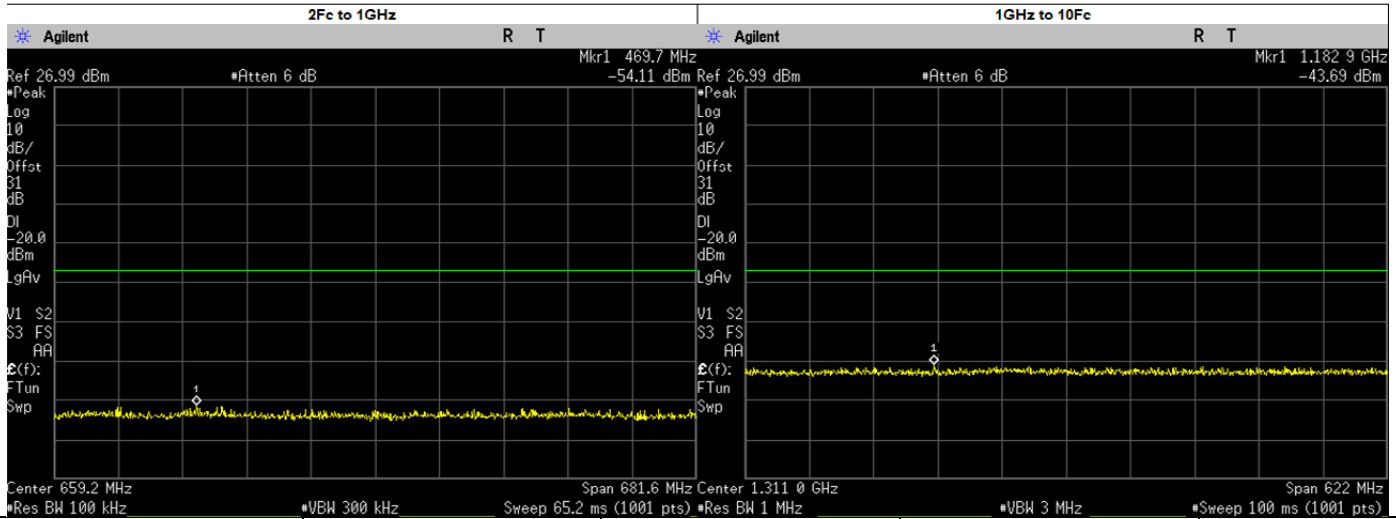
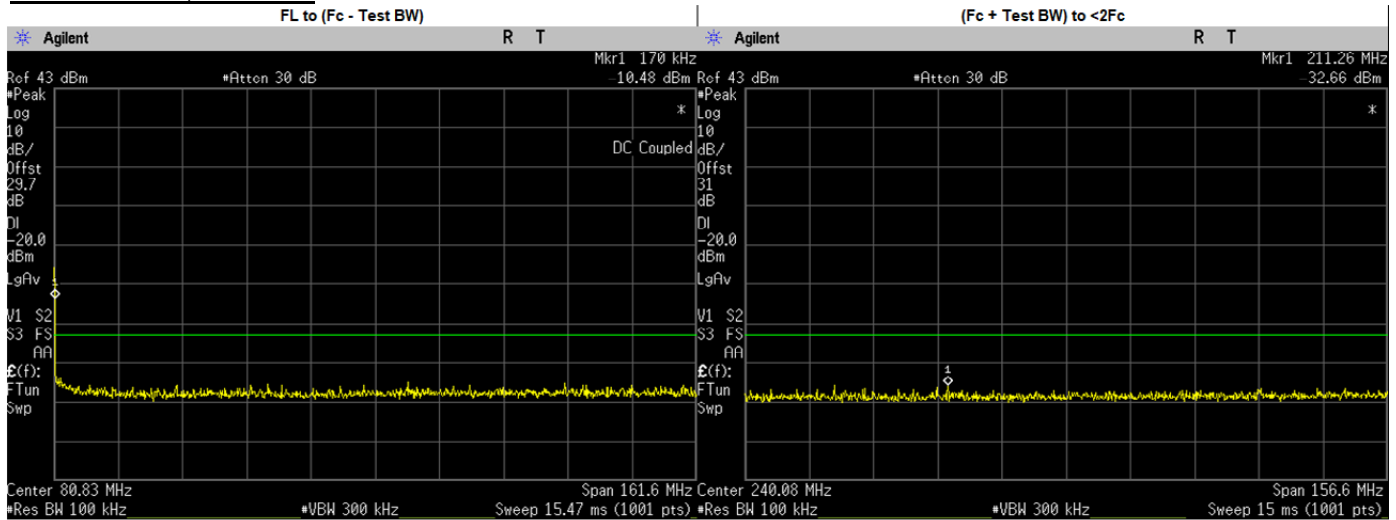

Frequency Range	Highest Spur Frequency (MHz)	Spurious Level (dbm)	Failing Limit (dBm)	Results
FL to (Fc - Test BW)	1.6254	-30.9684	-20	PASS
(Fc + Test BW) to <2Fc	211.2552	-32.6600	-20	PASS
2Fc to 1GHz	469.7152	-54.1100	-20	PASS
	323.4000	-57.8378	-20	PASS
	485.1000	-56.8560	-20	PASS
	646.8000	-56.8737	-20	PASS
	808.5000	-57.7463	-20	PASS
	970.2000	-56.7932	-20	PASS
1GHz to 10Fc	1182.8680	-43.6900	-20	PASS
	1131.9000	-45.6188	-20	PASS
	1293.6000	-45.5722	-20	PASS
	1455.3000	-45.6511	-20	PASS
	1617.0000	-45.8085	-20	PASS

**Digital : 161.7 MHz, 12.5kHz Channel Spacing, Low Power  
 FCC Part 90, RSS 119**

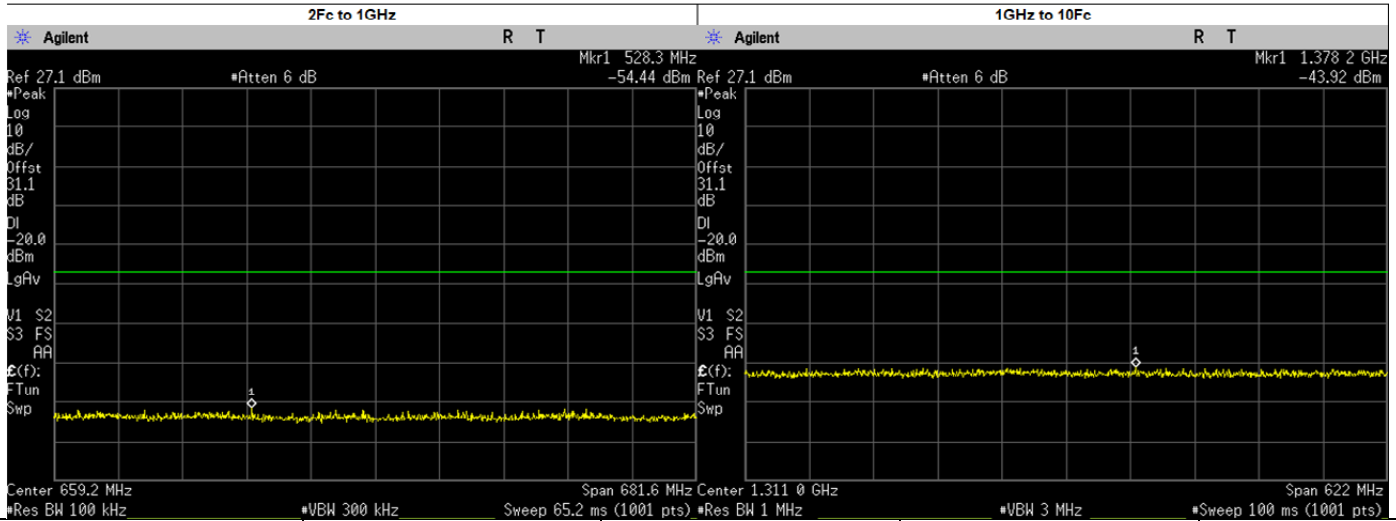
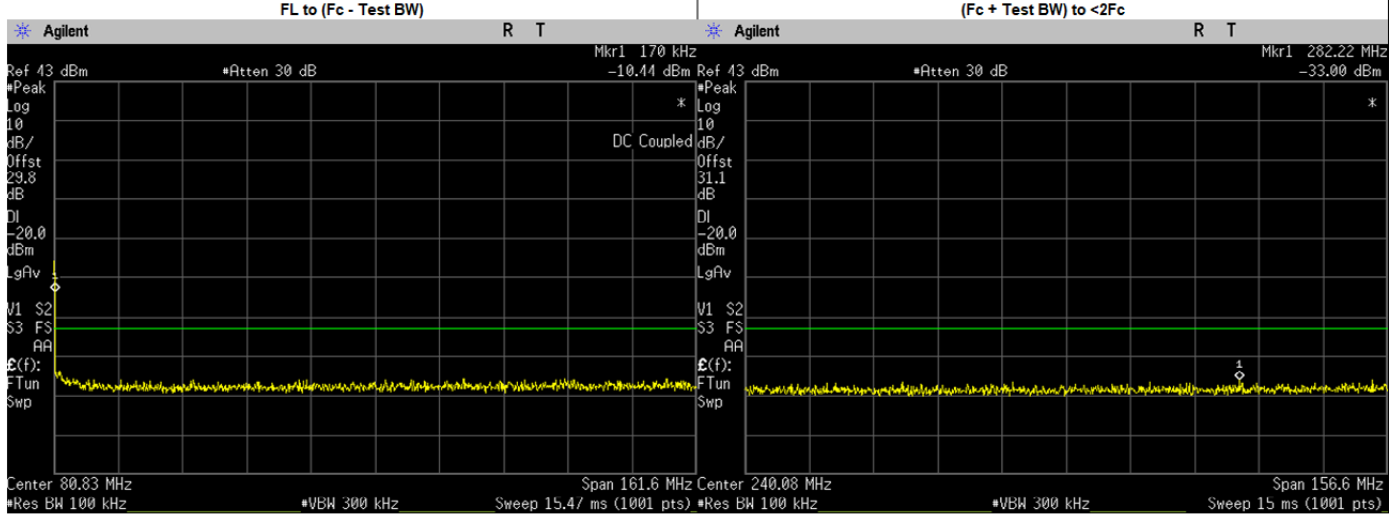

Frequency Range	Highest Spur Frequency (MHz)	Spurious Level (dbm)	Failing Limit (dBm)	Results
FL to (Fc - Test BW)	1.4637	-30.6852	-20	PASS
(Fc + Test BW) to <2Fc	282.2152	-33.0000	-20	PASS
2Fc to 1GHz	528.3328	-54.4400	-20	PASS
	323.4000	-56.0891	-20	PASS
	485.1000	-56.4200	-20	PASS
	646.8000	-57.1119	-20	PASS
	808.5000	-56.9802	-20	PASS
	970.2000	-56.9194	-20	PASS
1GHz to 10Fc	1378.1760	-43.9200	-20	PASS
	1131.9000	-45.4125	-20	PASS
	1293.6000	-45.9747	-20	PASS
	1455.3000	-45.6350	-20	PASS
	1617.0000	-45.0458	-20	PASS

**Digital : 173.3875 MHz, 12.5kHz Channel Spacing, Max Power  
 FCC Part 90, RSS 119**

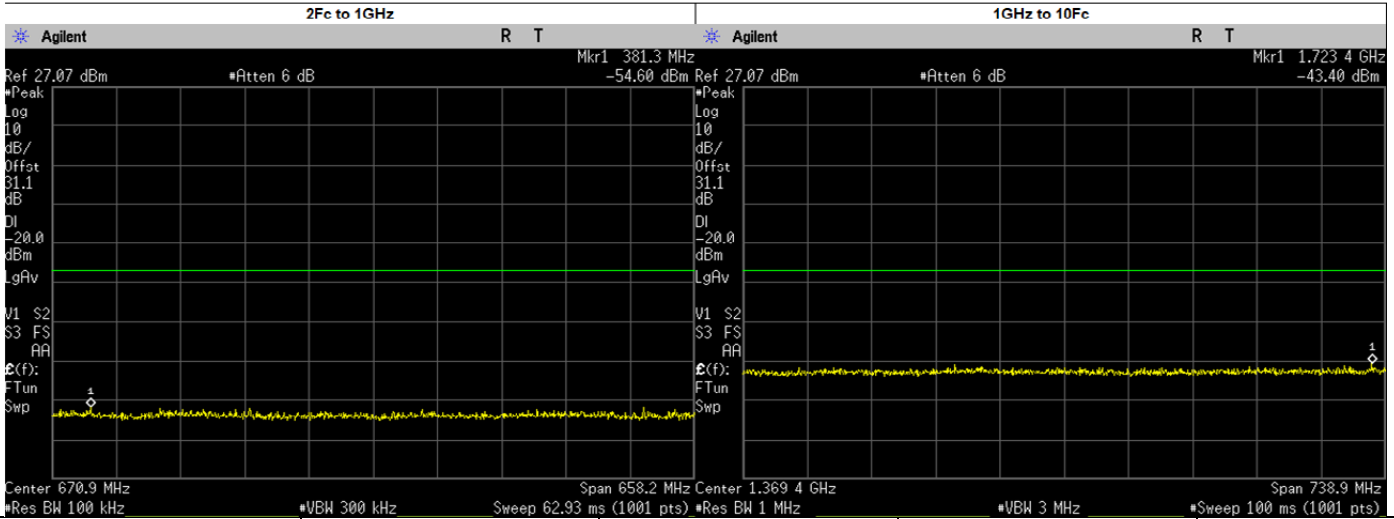
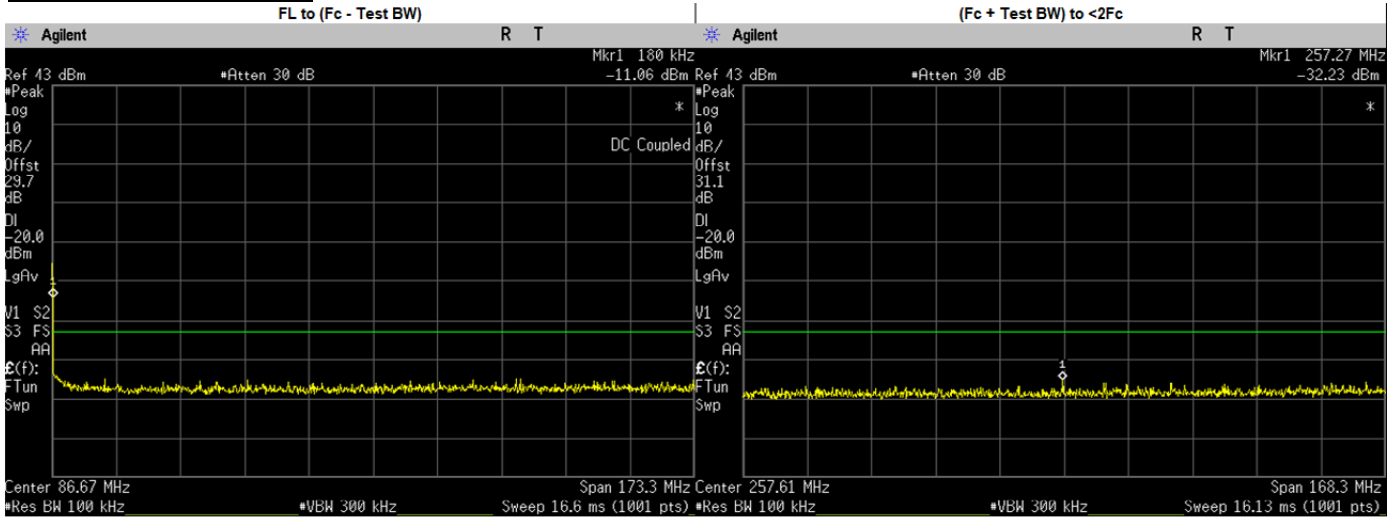

Frequency Range	Highest Spur Frequency (MHz)	Spurious Level (dbm)	Failing Limit (dBm)	Results
FL to (Fc - Test BW)	1.0489	-31.0504	-20	PASS
(Fc + Test BW) to <2Fc	257.2724	-32.2300	-20	PASS
2Fc to 1GHz	381.2685	-54.6000	-20	PASS
	346.7750	-56.5848	-20	PASS
	520.1625	-57.2483	-20	PASS
	693.5500	-57.4072	-20	PASS
	866.9375	-55.8297	-20	PASS
1GHz to 10Fc	1723.3590	-43.4000	-20	PASS
	1040.3250	-46.5692	-20	PASS
	1213.7130	-45.8734	-20	PASS
	1387.1000	-46.3396	-20	PASS
	1560.4870	-45.9223	-20	PASS
	1733.8750	-45.4649	-20	PASS

**6.10.4. Test Limit**

Table below summarized the power of any emission outside a licensee’s frequency block shall be attenuated below the transmitter power (P) by at least

Channel Spacing	Part 22	Part 24D	Part 74	Part 80	Part 90 (UHF, VHF, 800, 900)	Part 90 (700)
12.5kHz	43 + log <sub>10</sub> (P) (-13 dBm)	43 + log <sub>10</sub> (P) (-13 dBm)	43 + log <sub>10</sub> (P) (-13 dBm)	Not Applicable	50 + log <sub>10</sub> (P) (-20 dBm)	43 + log <sub>10</sub> (P) (-13 dBm)
25kHz		Not Applicable		43 + log <sub>10</sub> (P) (-13 dBm)	43 + log <sub>10</sub> (P) (-13 dBm)	43 + log <sub>10</sub> (P) (-13 dBm)

Channel Spacing	RSS 134	RSS 182	RSS 119 (UHF, VHF, 800, 900)	RSS 119 (700)
12.5kHz	43 + log <sub>10</sub> (P) (-13 dBm)	Not Applicable	50 + log <sub>10</sub> (P) (-20 dBm)	43 + log <sub>10</sub> (P) (-13 dBm)
25kHz	Not Applicable	43 + log <sub>10</sub> (P) (-13 dBm)	43 + log <sub>10</sub> (P) (-13 dBm)	43 + log <sub>10</sub> (P) (-13 dBm)

## 6.11. Radiated Spurious Emission

### 6.11.1. Test Setup

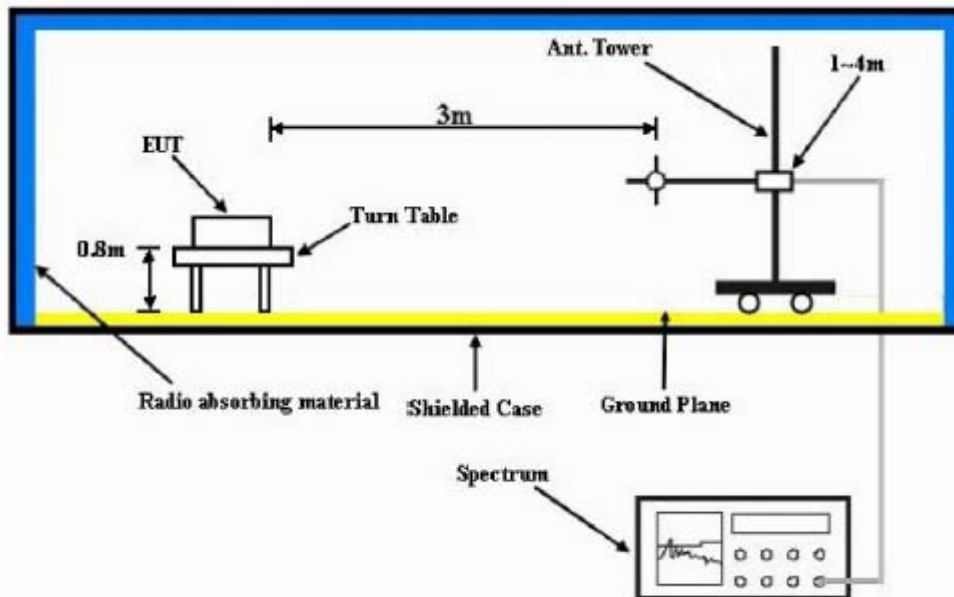

- 1) The Resolution Bandwidth for scanning Radiated Emission below 1 GHz is 100 kHz with Video Bandwidth = 300 kHz and Resolution Bandwidth for above 1 GHz is 1 MHz with Video Bandwidth = 3 MHz. Detector mode is positive peak.
- 2) In the semi- anechoic chamber, setup as illustrated above the DUT placed on the 0.8m height (for frequencies < 1GHz) or 1.5m (for frequencies > 1GHz) of Turn Table, rotated the table around 360 degrees to search the maximum radiation power and receiver antenna shall be rotated vertical and horizontal polarization and moved height from 1m to 4m to find the maximum polar radiated power. The “Read Value” is the spectrum reading the maximum power value.
- 3) The substitution antenna is substituted for DUT at the same position and signals generator (S.G) export the CW signal to the substitution antenna via a TX cable. The receiver antenna shall be rotated vertical and horizontal polarization and moved height from 1m to 4m to find the maximum radiation power. Record the power level of maximum radiation power from spectrum. So, the measured substitution value = Ref level of S.G + TX cables loss – Substituted Antenna Gain.
- 4) Final Radiated Spurious Emission = “Read Value” + Measured substitution value.

**6.11.1. Test Result (Analog)**

**SAC Transmitter Radiated Emission:**  
**Model Number: AAH87JDF9JA2AN S/N: 278TVZ3108 SR:20216-EMC-00022**  
**Battery Part No: PMNN4080AR Accy Part No: NA**  
**Test Mode: TX Analog 6.000 Watt(s) /Max Power**  
**138.012500 MHz 25 kHz**

Frequency (MHz)	Limit	Horizontal Measured Emission Equiv Pwr Into Ideal Dipole (dBm)	Vertical Measured Emission Equiv Pwr Into ideal Dipole (dBm)
276.0250	-13.0000	-98.5695 **	-98.0900 **
414.0375	-13.0000	-92.6743 **	-93.2310 **
552.0500	-13.0000	-88.3100 **	-87.8560 **
690.0625	-13.0000	-88.2837 **	-87.9313 **
828.0750	-13.0000	-87.1934 **	-87.3000 **
966.0875	-13.0000	-86.4562 **	-86.3348 **
1104.1000	-13.0000	-62.4753 **	-61.9509 **
1242.1125	-13.0000	-59.8207 **	-60.3519 **
1380.1250	-13.0000	-60.5710 **	-59.6099 **

**RADIATED SPURIOUS EMISSIONS**

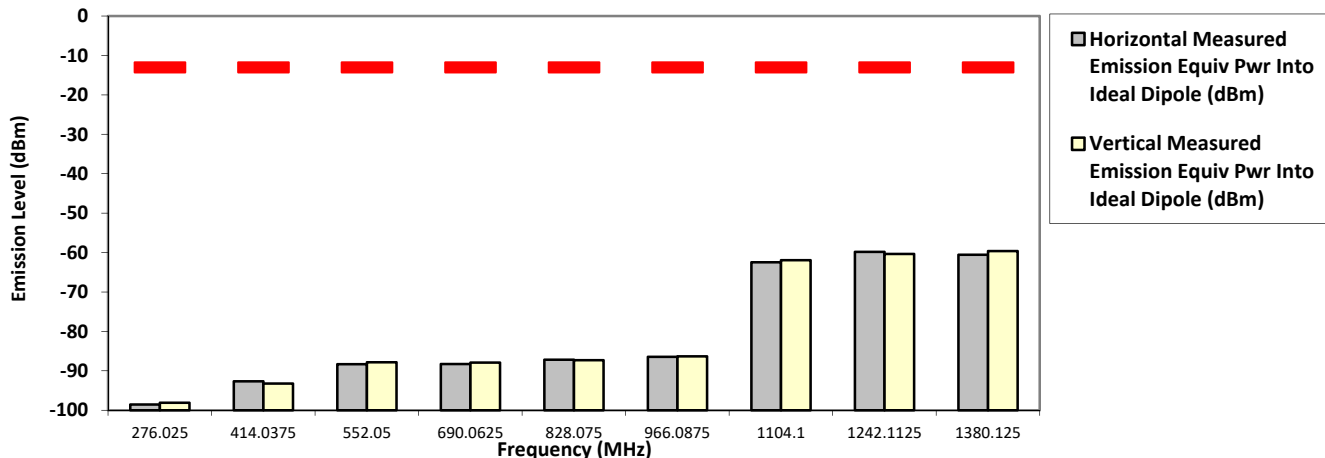

The data presented here was taken using the substitution method as found in the ANSI C63.26-2015 document.  
 Motorola Penang EMC Lab - Test Performed by: Nazrin&Azil Tue, Feb 11, 2020

Remarks: \*\* Indicates the spurious emission could not be detected due to noise limitations or ambient.  
 \*Pursuant to CFR 47 Part 2.1057 ( c ), emissions attenuated more than 20 dB below the permissible limit are not reported  
 Temp(Deg): 22.8 Hum(%RH): 70.1

System MU: 4.03 dB

Remarks:	Passed Results	Marginal Results	Failed Results
----------	----------------	------------------	----------------

**SAC Transmitter Radiated Emission:**  
**Model Number: AAH87JDF9JA2AN**      **S/N: 278TVZ3108**      **SR:20216-EMC-00022**  
**Battery Part No: PMNN4080AR**      **Test Mode: TX Analog**      **Accy Part No: NA**  
**158.55000 MHz**      **25 kHz**      **1.000 Watt(s) /Low Power**

Frequency (MHz)	Limit	Horizontal Measured Emission Equip Pwr Into Ideal Dipole (dBm)	Vertical Measured Emission Equip Pwr Into ideal Dipole (dBm)
317.1000	-13.0000	-96.4270 **	-96.4415 **
475.6500	-13.0000	-91.3494 **	-92.1619 **
634.2000	-13.0000	-89.8881 **	-88.9248 **
792.7500	-13.0000	-87.6689 **	-87.5961 **
951.3000	-13.0000	-86.3095 **	-87.1242 **
1109.8500	-13.0000	-62.1075 **	-61.9332 **
1268.4000	-13.0000	-60.5442 **	-60.2592 **
1426.9500	-13.0000	-61.4211 **	-60.7663 **
1585.5000	-13.0000	-59.8771 **	-60.7890 **

**RADIATED SPURIOUS EMISSIONS**

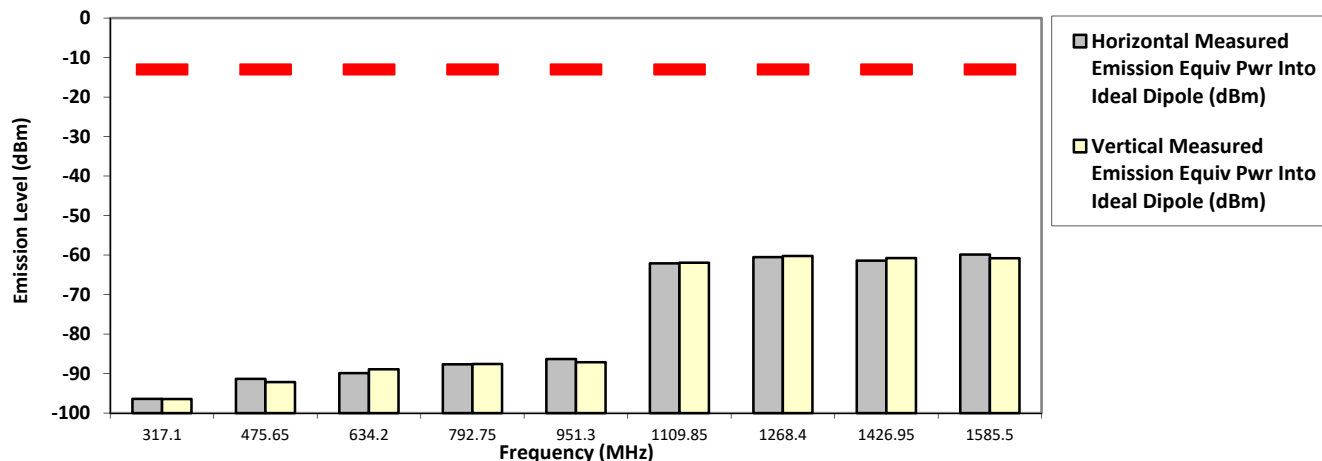

The data presented here was taken using the substitution method as found in the ANSI C63.26-2015 document.  
 Motorola Penang EMC Lab - Test Performed by: Nazrin&Azil      Tue, Feb 11, 2020

Remarks: \*\* Indicates the spurious emission could not be detected due to noise limitations or ambient.  
 \*Pursuant to CFR 47 Part 2.1057 ( c ), emissions attenuated more than 20 dB below the permissible limit are not reported  
 Temp(Deg): 22.8 Hum(%RH): 70.1

System MU: 4.03 dB

Remarks: Passed Results Marginal Results Failed Results

**SAC Transmitter Radiated Emission:**  
**Model Number: AAH87JDF9JA2AN**      **S/N: 278TVZ3108**      **SR:20216-EMC-00022**  
**Battery Part No: PMNN4080AR**      **Accy Part No: NA**  
**Test Mode: TX Analog**  
**158.55000 MHz**      **25 kHz**      **6.000 Watt(s) /Max Power**

Frequency (MHz)	Limit	Horizontal Measured Emission Equiv Pwr Into Ideal Dipole (dBm)	Vertical Measured Emission Equiv Pwr Into ideal Dipole (dBm)
317.1000	-13.0000	-98.3642 **	-97.6183 **
475.6500	-13.0000	-91.0380 **	-91.1800 **
634.2000	-13.0000	-87.7140 **	-89.0835 **
792.7500	-13.0000	-87.3564 **	-87.8112 **
951.3000	-13.0000	-86.3854 **	-85.3685 **
1109.8500	-13.0000	-62.1820 **	-62.5408 **
1268.4000	-13.0000	-61.5284 **	-61.1631 **
1426.9500	-13.0000	-61.1572 **	-61.6688 **
1585.5000	-13.0000	-60.2089 **	-60.0909 **

**RADIATED SPURIOUS EMISSIONS**

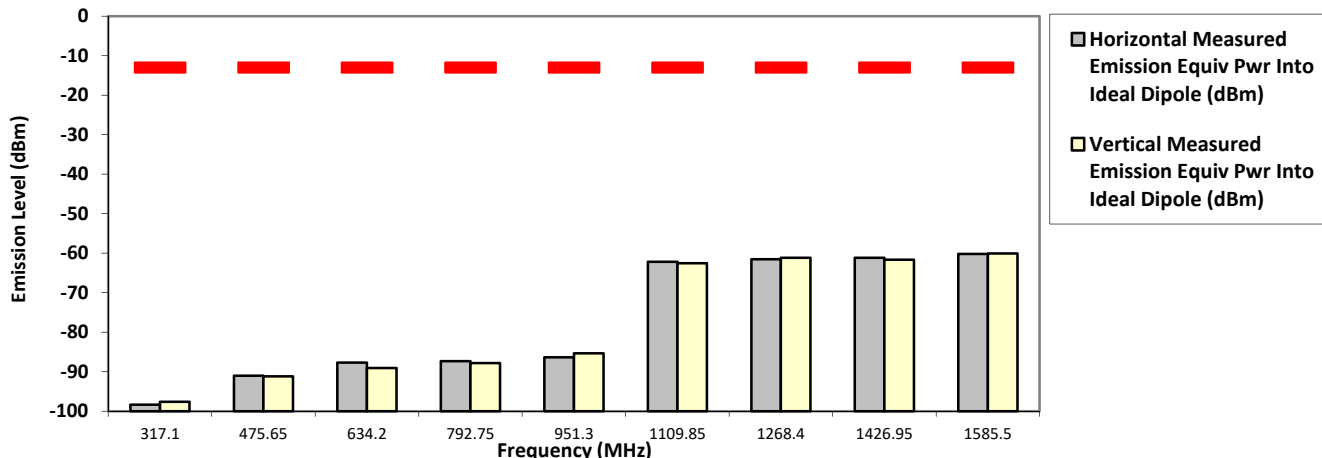

The data presented here was taken using the substitution method as found in the ANSI C63.26-2015 document.  
 Motorola Penang EMC Lab - Test Performed by: Nazrin&Azil      Tue, Feb 11, 2020

Remarks: \*\* Indicates the spurious emission could not be detected due to noise limitations or ambient.  
 \*Pursuant to CFR 47 Part 2.1057 ( c ), emissions attenuated more than 20 dB below the permissible limit are not reported  
 Temp(Deg): 22.8 Hum(%RH): 70.1

System MU: 4.03 dB

Remarks:	Passed Results	Marginal Results	Failed Results
----------	----------------	------------------	----------------



**SAC Transmitter Radiated Emission:**  
**Model Number: AAH87JDF9JA2AN**      **S/N: 278TVZ3108**      **SR:20216-EMC-00022**  
**Battery Part No: PMNN4080AR**      **Test Mode: TX Analog**      **Accy Part No: NA**  
**161.70000 MHz**      **25 kHz**      **1.000 Watt(s) /Low Power**

Frequency (MHz)	Limit	Horizontal Measured Emission Equiv Pwr Into Ideal Dipole (dBm)	Vertical Measured Emission Equiv Pwr Into ideal Dipole (dBm)
323.4000	-13.0000	-97.6297 **	-97.0643 **
485.1000	-13.0000	-92.4109 **	-89.9366 **
646.8000	-13.0000	-88.9824 **	-89.6527 **
808.5000	-13.0000	-87.3985 **	-88.0485 **
970.2000	-13.0000	-86.4267 **	-86.1945 **
1131.9000	-13.0000	-61.6838 **	-62.1612 **
1293.6000	-13.0000	-60.5856 **	-62.1445 **
1455.3000	-13.0000	-60.5207 **	-61.1202 **
1617.0000	-13.0000	-59.6916 **	-60.3600 **

**RADIATED SPURIOUS EMISSIONS**

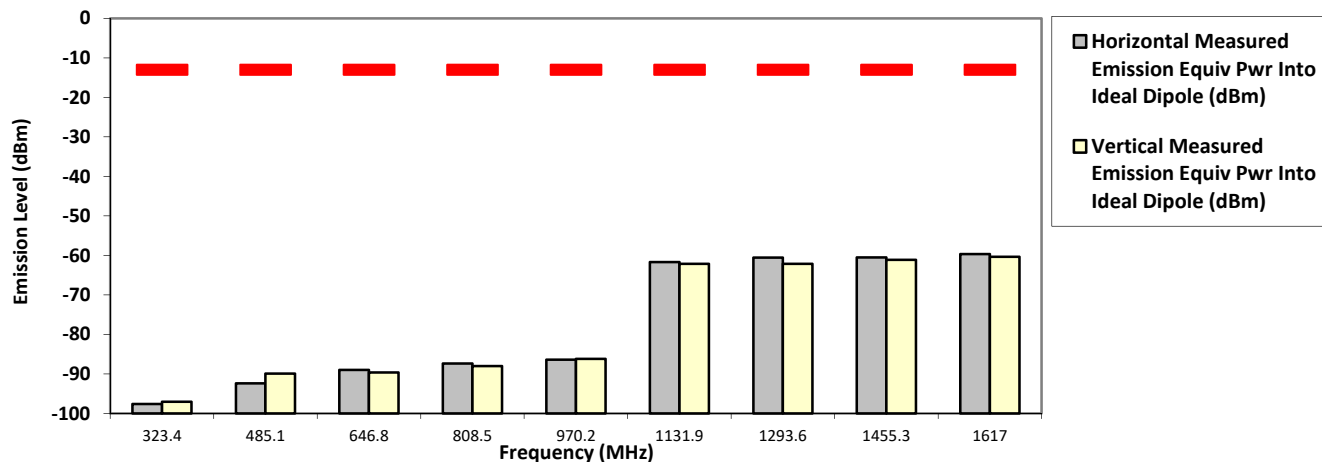

The data presented here was taken using the substitution method as found in the ANSI C63.26-2015 document.  
 Motorola Penang EMC Lab - Test Performed by: Nazrin&Azil      Tue, Feb 11, 2020

Remarks: \*\* Indicates the spurious emission could not be detected due to noise limitations or ambient.  
 \*Pursuant to CFR 47 Part 2.1057 ( c ), emissions attenuated more than 20 dB below the permissible limit are not reported  
 Temp(Deg): 22.8 Hum(%RH): 70.1

System MU: 4.03 dB

<b>Remarks:</b>	Passed Results	Marginal Results	Failed Results
-----------------	----------------	------------------	----------------

**SAC Transmitter Radiated Emission:**  
**Model Number: AAH87JDF9JA2AN**      **S/N: 278TVZ3108**      **SR:20216-EMC-00022**  
**Battery Part No: PMNN4080AR**      **Test Mode: TX Analog**      **Accy Part No: NA**  
**173.387500 MHz**      **25 kHz**      **6.000 Watt(s) /Max Power**

Frequency (MHz)	Limit	Horizontal Measured Emission Equip Pwr Into Ideal Dipole (dBm)	Vertical Measured Emission Equip Pwr Into ideal Dipole (dBm)
346.7750	-13.0000	-97.1896 **	-95.1781 **
520.1625	-13.0000	-91.6962 **	-91.3187 **
693.5500	-13.0000	-88.7540 **	-89.2813 **
866.9375	-13.0000	-86.1774 **	-86.2419 **
1040.3250	-13.0000	-62.4387 **	-62.6036 **
1213.7125	-13.0000	-61.1531 **	-61.8993 **
1387.1000	-13.0000	-58.8423 **	-61.1546 **
1560.4875	-13.0000	-60.1870 **	-60.3884 **
1733.8750	-13.0000	-59.3736 **	-58.6219 **

**RADIATED SPURIOUS EMISSIONS**

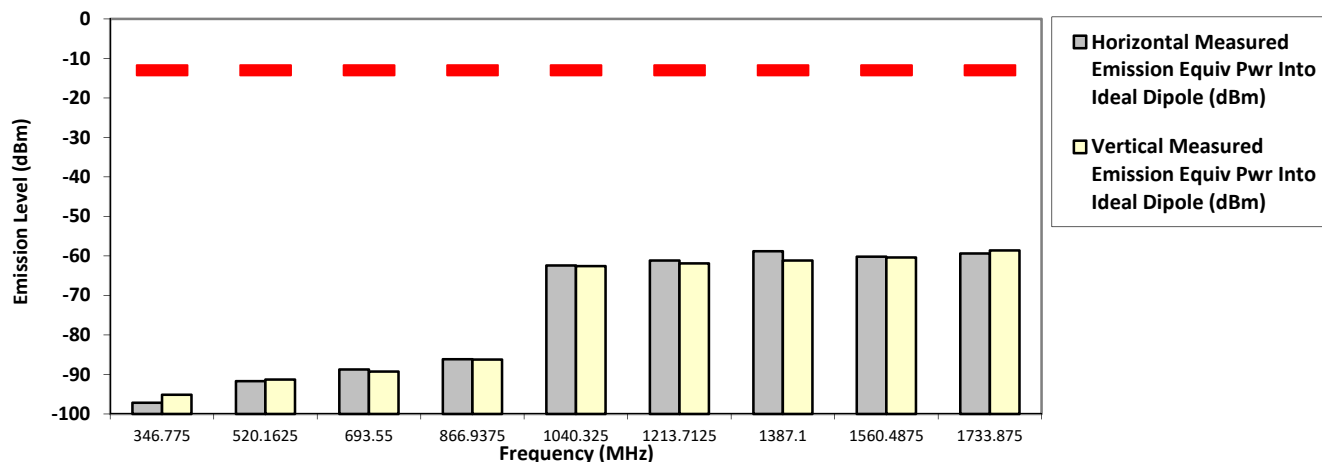

The data presented here was taken using the substitution method as found in the ANSI C63.26-2015 document.  
 Motorola Penang EMC Lab - Test Performed by: Nazrin&Azil      Tue, Feb 11, 2020

Remarks: \*\* Indicates the spurious emission could not be detected due to noise limitations or ambient.  
 \*Pursuant to CFR 47 Part 2.1057 ( c ), emissions attenuated more than 20 dB below the permissible limit are not reported  
 Temp(Deg): 22.8 Hum(%RH): 70.1

System MU: 4.03 dB

Remarks: Passed Results Marginal Results Failed Results

**6.11.2. Test Result (Digital)**

**SAC Transmitter Radiated Emission:**

**Model Number: AAH87JDF9JA2AN**

**S/N: 278TVZ3108**

**SR:20216-EMC-00022**

**Battery Part No: PMNN4080AR**

**Accy Part No: NA**

**Test Mode: TX Digital**

**138.012500 MHz**

**12.5 kHz**

**6.000 Watt(s) /Max Power**

Frequency (MHz)	Limit	Horizontal Measured Emission Equiv Pwr Into Ideal Dipole (dBm)	Vertical Measured Emission Equiv Pwr Into ideal Dipole (dBm)
276.0250	-20.0000	-98.5919 **	-98.3745 **
414.0375	-20.0000	-93.5766 **	-93.3055 **
552.0500	-20.0000	-87.8352 **	-88.1067 **
690.0625	-20.0000	-87.9729 **	-88.6113 **
828.0750	-20.0000	-87.2925 **	-87.0734 **
966.0875	-20.0000	-86.0470 **	-86.4926 **
1104.1000	-20.0000	-62.0203 **	-61.6737 **
1242.1125	-20.0000	-61.2976 **	-60.7104 **
1380.1250	-20.0000	-61.6299 **	-61.1016 **

**RADIATED SPURIOUS EMISSIONS**

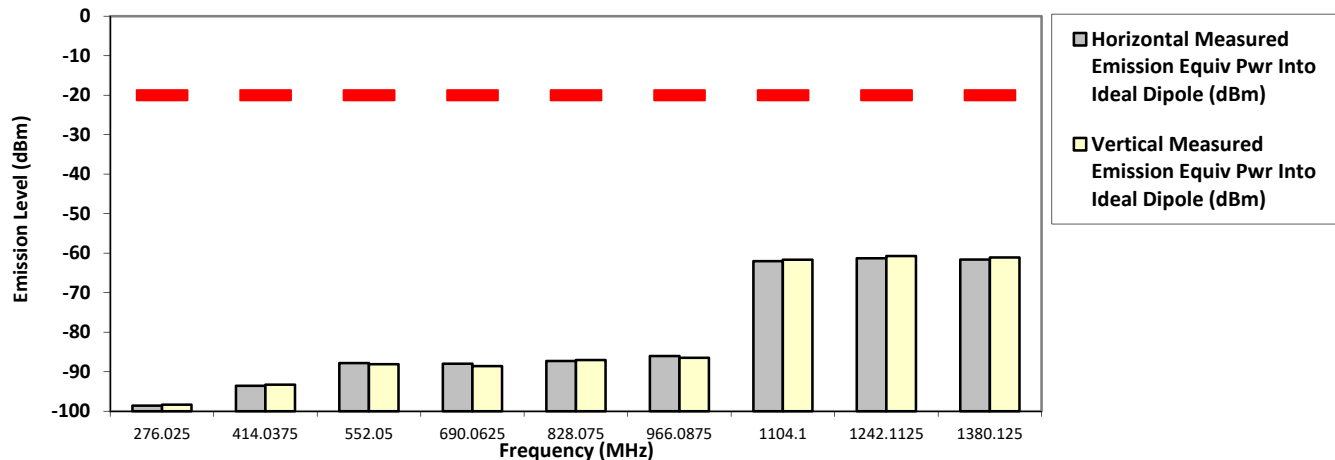

The data presented here was taken using the substitution method as found in the ANSI C63.26-2015 document.  
 Motorola Penang EMC Lab - Test Performed by: Nazrin&Azil Tue, Feb 11, 2020

Remarks: \*\* Indicates the spurious emission could not be detected due to noise limitations or ambient.

\*Pursuant to CFR 47 Part 2.1057 ( c ), emissions attenuated more than 20 dB below the permissible limit are not reported  
 Temp(Deg): 22.8 Hum(%RH): 70.1

System MU: 4.03 dB

Remarks:	Passed Results	Marginal Results	Failed Results
----------	----------------	------------------	----------------

**SAC Transmitter Radiated Emission:**  
**Model Number: AAH87JDF9JA2AN**      **S/N: 278TVZ3108**      **SR:20216-EMC-00022**  
**Battery Part No: PMNN4080AR**      **Test Mode: TX Digital**      **Accy Part No: NA**  
**158.550000 MHz**      **12.5 kHz**      **1.000 Watt(s) /Low Power**

Frequency (MHz)	Limit	Horizontal Measured Emission Equip Pwr Into Ideal Dipole (dBm)	Vertical Measured Emission Equip Pwr Into ideal Dipole (dBm)
317.1000	-20.0000	-97.5984 **	-97.9648 **
475.6500	-20.0000	-91.7291 **	-90.0834 **
634.2000	-20.0000	-89.9867 **	-88.8576 **
792.7500	-20.0000	-86.2487 **	-87.8437 **
951.3000	-20.0000	-86.1723 **	-85.6980 **
1109.8500	-20.0000	-62.0304 **	-61.2335 **
1268.4000	-20.0000	-61.4451 **	-61.4462 **
1426.9500	-20.0000	-60.9209 **	-61.6923 **
1585.5000	-20.0000	-59.4652 **	-59.9073 **

**RADIATED SPURIOUS EMISSIONS**

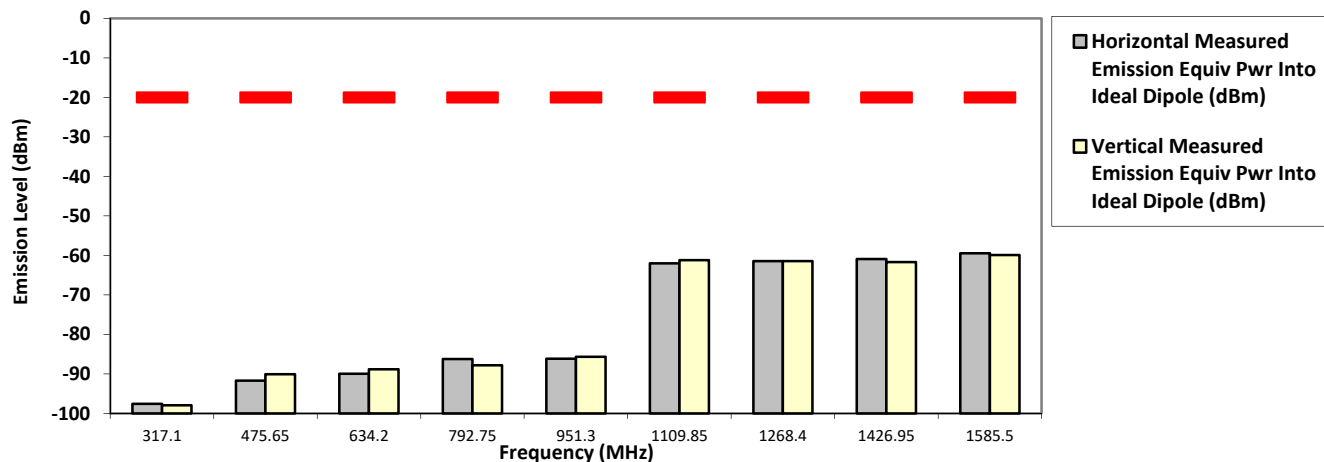

The data presented here was taken using the substitution method as found in the ANSI C63.26-2015 document.  
 Motorola Penang EMC Lab - Test Performed by: Nazrin&Azil      Tue, Feb 11, 2020

Remarks: \*\* Indicates the spurious emission could not be detected due to noise limitations or ambient.  
 \*Pursuant to CFR 47 Part 2.1057 ( c ), emissions attenuated more than 20 dB below the permissible limit are not reported  
 Temp(Deg): 22.8 Hum(%RH): 70.1

System MU: 4.03 dB

Remarks: Passed Results Marginal Results Failed Results

**SAC Transmitter Radiated Emission:**

Model Number: AAH87JDF9JA2AN

S/N: 278TVZ3108

SR:20216-EMC-00022

Battery Part No: PMNN4080AR

Accy Part No: NA

Test Mode: TX Digital

158.55000 MHz

12.5 kHz

6.000 Watt(s) /Max Power

Frequency (MHz)	Limit	Horizontal Measured Emission Equiv Pwr Into Ideal Dipole (dBm)	Vertical Measured Emission Equiv Pwr Into ideal Dipole (dBm)
317.1000	-20.0000	-96.2418 **	-97.5018 **
475.6500	-20.0000	-91.9177 **	-91.7633 **
634.2000	-20.0000	-89.6023 **	-89.1327 **
792.7500	-20.0000	-86.1851 **	-86.5107 **
951.3000	-20.0000	-86.7445 **	-84.8286 **
1109.8500	-20.0000	-62.2733 **	-62.2822 **
1268.4000	-20.0000	-60.1875 **	-61.1349 **
1426.9500	-20.0000	-60.7909 **	-61.1537 **
1585.5000	-20.0000	-60.4067 **	-60.2725 **

### RADIATED SPURIOUS EMISSIONS

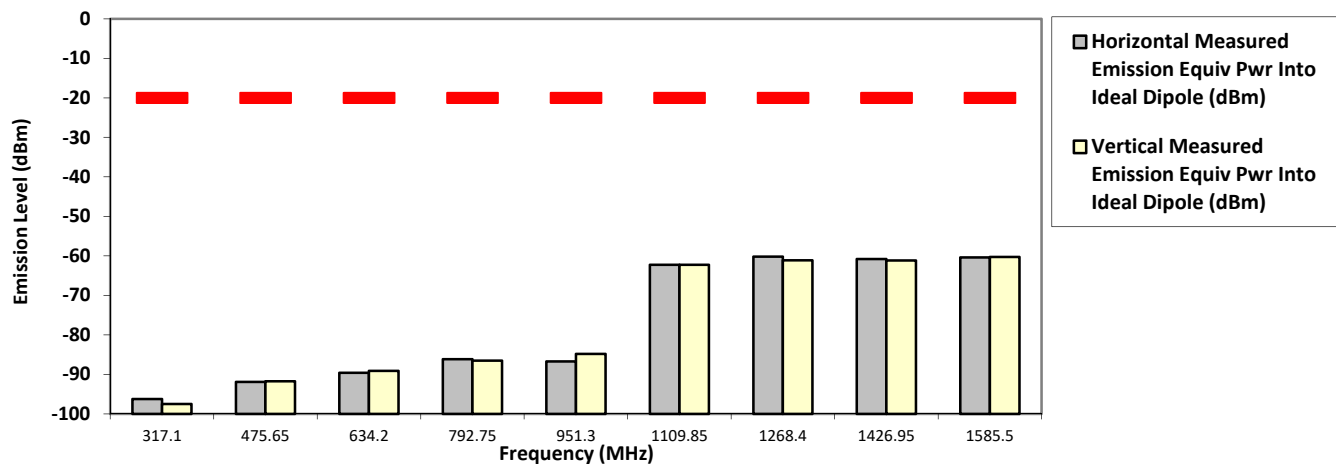

The data presented here was taken using the substitution method as found in the ANSI C63.26-2015 document.  
 Motorola Penang EMC Lab - Test Performed by: Nazrin&Azil  
 Tue, Feb 11, 2020

Remarks: \*\* Indicates the spurious emission could not be detected due to noise limitations or ambient.

\*Pursuant to CFR 47 Part 2.1057 ( c ), emissions attenuated more than 20 dB below the permissible limit are not reported  
 Temp(Deg): 22.8 Hum(%RH): 70.1

System MU: 4.03 dB

Remarks:	Passed Results	Marginal Results	Failed Results
----------	----------------	------------------	----------------

SAC Transmitter Radiated Emission:

Model Number: AAH87JDF9JA2AN

S/N: 278TVZ3108

SR:20216-EMC-00022

Battery Part No: PMNN4080AR

Accy Part No: NA

Test Mode: TX Digital

161.70000 MHz

12.5 kHz

1.000 Watt(s) /Low Power

Frequency (MHz)	Limit	Horizontal Measured Emission Equiv Pwr Into Ideal Dipole (dBm)	Vertical Measured Emission Equiv Pwr Into ideal Dipole (dBm)
323.4000	-20.0000	-97.1526 **	-97.2787 **
485.1000	-20.0000	-90.1677 **	-90.9216 **
646.8000	-20.0000	-88.9889 **	-88.4606 **
808.5000	-20.0000	-87.1928 **	-87.2981 **
970.2000	-20.0000	-85.3256 **	-84.0316 **
1131.9000	-20.0000	-62.1817 **	-62.2572 **
1293.6000	-20.0000	-61.1753 **	-60.7772 **
1455.3000	-20.0000	-60.2657 **	-61.4994 **
1617.0000	-20.0000	-60.3523 **	-59.9561 **

RADIATED SPURIOUS EMISSIONS

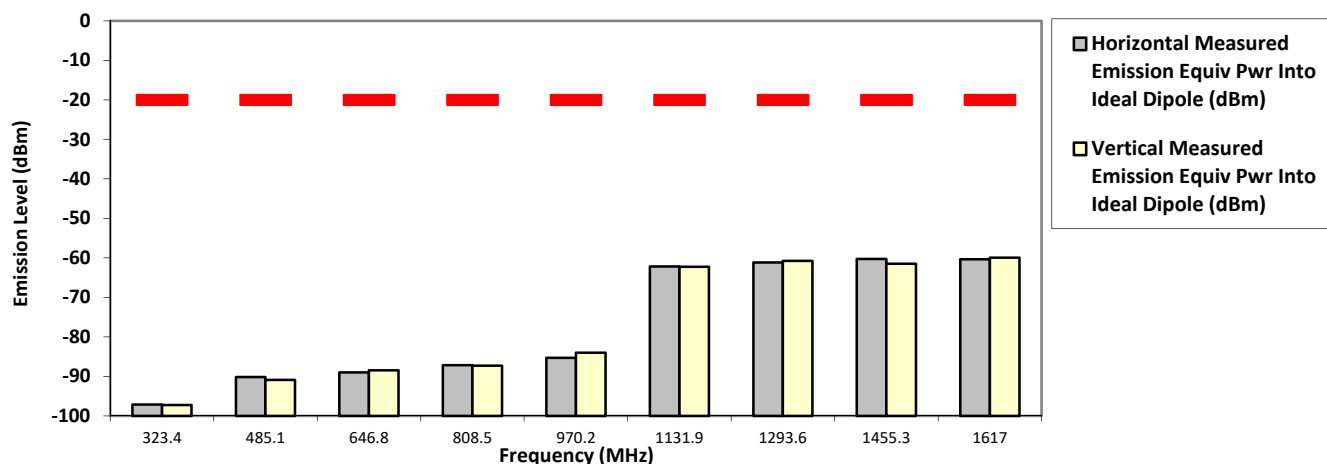

The data presented here was taken using the substitution method as found in the ANSI C63.26-2015 document.  
 Motorola Penang EMC Lab - Test Performed by: Nazrin&Azil Tue, Feb 11, 2020

Remarks: \*\* Indicates the spurious emission could not be detected due to noise limitations or ambient.  
 \*Pursuant to CFR 47 Part 2.1057 ( c ), emissions attenuated more than 20 dB below the permissible limit are not reported  
 Temp(Deg): 22.8 Hum(%RH): 70.1

System MU: 4.03 dB

Remarks: Passed Results Marginal Results Failed Results

SAC Transmitter Radiated Emission:

Model Number: AAH87JDF9JA2AN

S/N: 278TVZ3108

SR:20216-EMC-00022

Battery Part No: PMNN4080AR

Accy Part No: NA

Test Mode: TX Digital

161.70000 MHz

12.5 kHz

6.000 Watt(s) /Max Power

Frequency (MHz)	Limit	Horizontal Measured Emission Equiv Pwr Into Ideal Dipole (dBm)	Vertical Measured Emission Equiv Pwr Into ideal Dipole (dBm)
323.4000	-20.0000	-97.1612 **	-97.8217 **
485.1000	-20.0000	-90.4377 **	-91.3001 **
646.8000	-20.0000	-89.1576 **	-89.2209 **
808.5000	-20.0000	-87.1979 **	-86.1611 **
970.2000	-20.0000	-85.1573 **	-86.6403 **
1131.9000	-20.0000	-61.9449 **	-62.9855 **
1293.6000	-20.0000	-61.5304 **	-60.3020 **
1455.3000	-20.0000	-60.8746 **	-61.5919 **
1617.0000	-20.0000	-60.3579 **	-59.3250 **

RADIATED SPURIOUS EMISSIONS

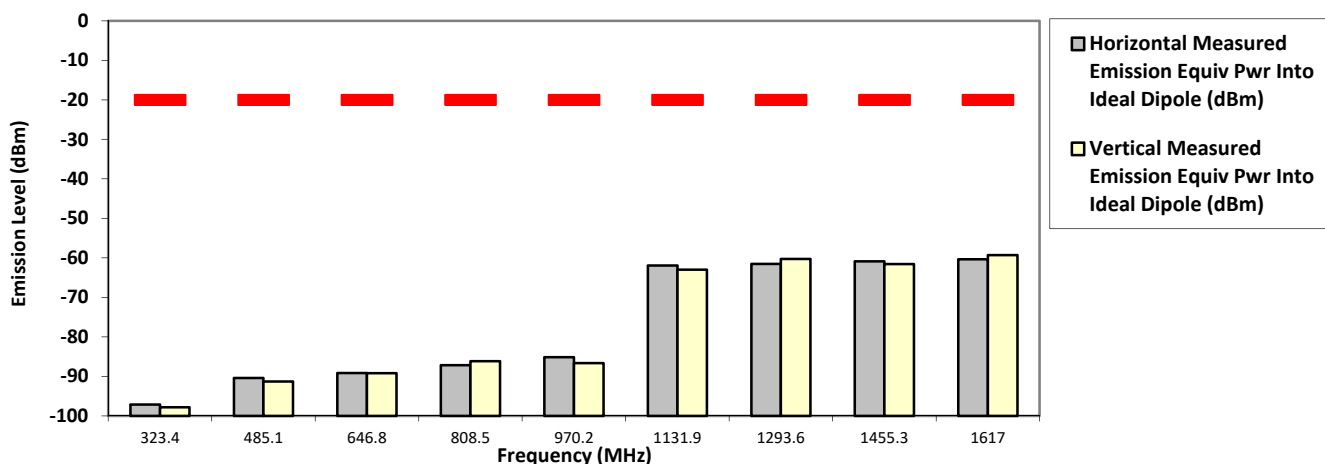

The data presented here was taken using the substitution method as found in the ANSI C63.26-2015 document.  
 Motorola Penang EMC Lab - Test Performed by: Nazrin&Azil Tue, Feb 11, 2020

Remarks: \*\* Indicates the spurious emission could not be detected due to noise limitations or ambient.  
 \*Pursuant to CFR 47 Part 2.1057 ( c ), emissions attenuated more than 20 dB below the permissible limit are not reported  
 Temp(Deg): 22.8 Hum(%RH): 70.1

System MU: 4.03 dB

Remarks:

Passed Results	Marginal Results	Failed Results
----------------	------------------	----------------

SAC Transmitter Radiated Emission:

Model Number: AAH87JDF9JA2AN

S/N: 278TVZ3108

SR:20216-EMC-00022

Battery Part No: PMNN4080AR

Accy Part No: NA

Test Mode: TX Digital

173.387500 MHz

12.5 kHz

6.000 Watt(s) /Max Power

Frequency (MHz)	Limit	Horizontal Measured Emission Equiv Pwr Into Ideal Dipole (dBm)	Vertical Measured Emission Equiv Pwr Into ideal Dipole (dBm)
346.7750	-20.0000	-96.7948 **	-96.9912 **
520.1625	-20.0000	-90.9061 **	-90.6826 **
693.5500	-20.0000	-89.3625 **	-86.7431 **
866.9375	-20.0000	-86.8565 **	-85.7383 **
1040.3250	-20.0000	-62.8529 **	-61.7885 **
1213.7125	-20.0000	-60.9579 **	-60.9084 **
1387.1000	-20.0000	-61.0973 **	-61.3034 **
1560.4875	-20.0000	-59.0672 **	-59.9665 **
1733.8750	-20.0000	-59.5184 **	-59.3704 **

**RADIATED SPURIOUS EMISSIONS**

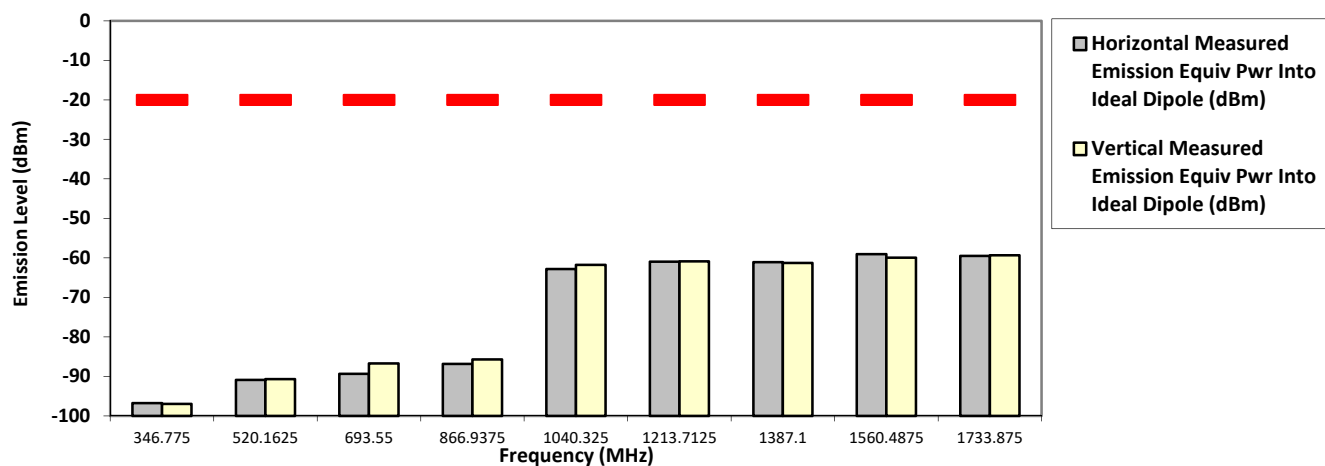

The data presented here was taken using the substitution method as found in the ANSI C63.26-2015 document.  
 Motorola Penang EMC Lab - Test Performed by: Nazrin&Azil Tue, Feb 11, 2020

Remarks: \*\* Indicates the spurious emission could not be detected due to noise limitations or ambient.  
 \*Pursuant to CFR 47 Part 2.1057 ( c ), emissions attenuated more than 20 dB below the permissible limit are not reported  
 Temp(Deg): 22.8 Hum(%RH): 70.1

System MU: 4.03 dB

Remarks: Passed Results Marginal Results Failed Results

**6.11.3. Test Limit**



Table below summarized the power of any emission outside a licensee’s frequency block shall be attenuated below the transmitter power (P) by at least

Channel Spacing	Part 22	Part 24D	Part 74	Part 80	Part 90 (UHF, VHF, 800, 900)	Part 90 (700)
12.5kHz	43 + log <sub>10</sub> (P) (-13 dBm)	43 + log <sub>10</sub> (P) (-13 dBm)	43 + log <sub>10</sub> (P) (-13 dBm)	Not Applicable	50 + log <sub>10</sub> (P) (-20 dBm)	43 + log <sub>10</sub> (P) (-13 dBm)
25kHz		Not Applicable		43 + log <sub>10</sub> (P) (-13 dBm)	43 + log <sub>10</sub> (P) (-13 dBm)	43 + log <sub>10</sub> (P) (-13 dBm)

Channel Spacing	RSS 134	RSS 182	RSS 119 (UHF, VHF, 800, 900)	RSS 119 (700)
12.5kHz	43 + log <sub>10</sub> (P) (-13 dBm)	Not Applicable	50 + log <sub>10</sub> (P) (-20 dBm)	43 + log <sub>10</sub> (P) (-13 dBm)
25kHz	Not Applicable	43 + log <sub>10</sub> (P) (-13 dBm)	43 + log <sub>10</sub> (P) (-13 dBm)	43 + log <sub>10</sub> (P) (-13 dBm)

## 6.12. Effective Radiated Power (ERP)

### 6.12.1. Test Setup

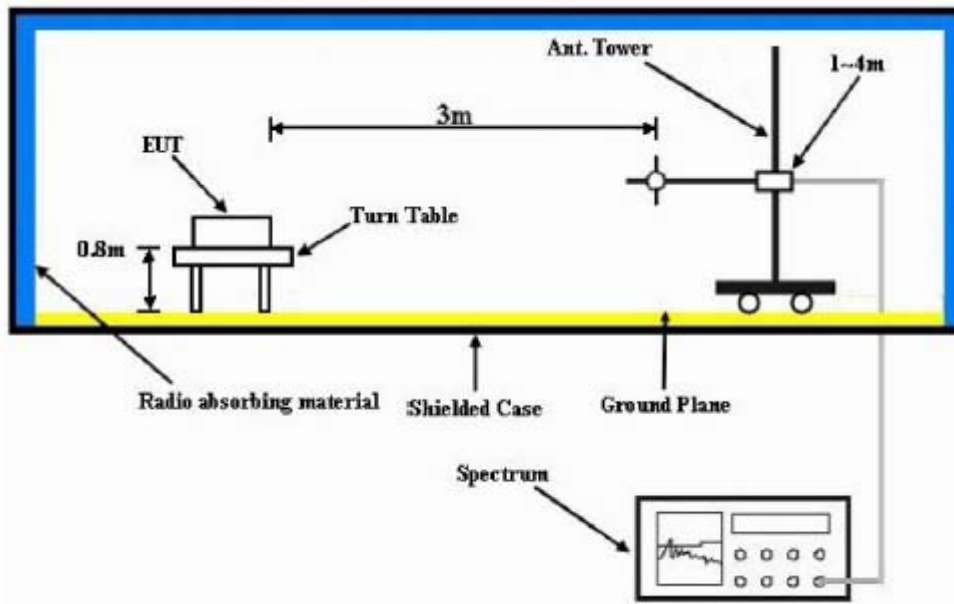

- 1) The Resolution Bandwidth for Equivalent Radiated Power (ERP) below 1 GHz is 100 kHz with Video Bandwidth = 300 kHz and Resolution Bandwidth for EIRP above 1 GHz is 1 MHz with Video Bandwidth = 3 MHz. Detector Mode is RMS.
- 2) In the semi-anechoic chamber, setup as illustrated above the DUT placed on the 0.8m height of Turn Table, rotated the table 45 degree each interval to search the maximum radiation power and receiver antenna shall be rotated vertical and horizontal polarization and moved height from 1m to 4m to find the maximum polar radiated power for each degree interval. The "Read Value" is the spectrum reading of maximum power value.
- 3) The substitution antenna is substituted for DUT at the same position and signals generator (S.G) export the CW signal to the substitution antenna via a TX cable. The receiver antenna shall be rotated vertical and horizontal polarization and moved height from 1m to 4m to find the maximum radiation power. Record the power level of maximum radiation power from spectrum. So, the Measured substitution value = Ref level of S.G + TX cables loss – Substituted Antenna Gain.

### 6.12.2. Test Result

NA → Not Applicable

### 6.12.3. Test Limit

The maximum output power of the transmitter for mobile stations is 100 watts (20 dB). Power is given in terms of effective radiated power (ERP).

### 6.13. GNSS (EIRP for 1559 - 1610MHz)

#### 6.13.1. Test Setup

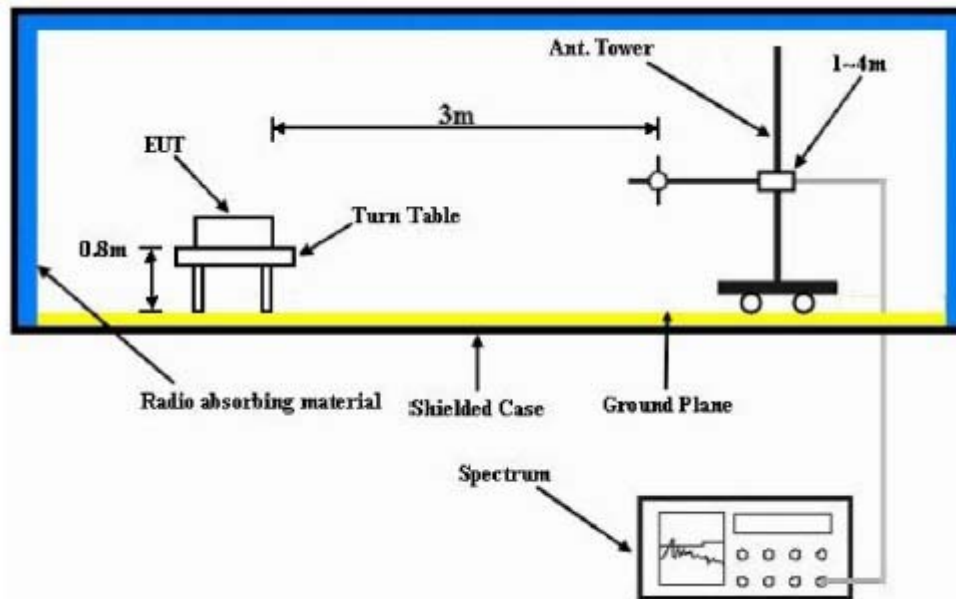

- 4) The Resolution Bandwidth for Equivalent Isotropically Radiated Power (EIRP) below 1 GHz is 100 kHz with Video Bandwidth = 300 kHz and Resolution Bandwidth for EIRP above 1 GHz is 1 MHz with Video Bandwidth = 3 MHz. Detector Mode is RMS.
- 5) In the semi-anechoic chamber, setup as illustrated above the DUT placed on the 0.8m height of Turn Table, rotated the table 45 degree each interval to search the maximum radiation power and receiver antenna shall be rotated vertical and horizontal polarization and moved height from 1m to 4m to find the maximum polar radiated power for each degree interval. The “Read Value” is the spectrum reading of maximum power value.
- 6) The substitution antenna is substituted for DUT at the same position and signals generator (S.G) export the CW signal to the substitution antenna via a TX cable. The receiver antenna shall be rotated vertical and horizontal polarization and moved height from 1m to 4m to find the maximum radiation power. Record the power level of maximum radiation power from spectrum. So, the Measured substitution value = Ref level of S.G + TX cables loss – Substituted Antenna Gain.
- 7)  $EIRP = \text{“Read Value”} + \text{Measured substitution value} + 2.15$ .

#### 6.13.2. Test Result

NA → Not Applicable

**6.13.3. Test Limit**

For operations in the 758-775 MHz and 788-805 MHz bands, all emissions including harmonics in the band 1559-1610 MHz shall be limited to  $-70$  dBW/MHz equivalent isotropically radiated power (EIRP) for wideband signals, and  $-80$  dBW EIRP for discrete emissions of less than 700 Hz bandwidth.

**~ End of Report ~**