



Copyright 2019
Vertex Standard LMR, Inc.
All rights reserved. No portion of this manual may be reproduced without the
permission of Vertex Standard LMR, Inc.

Printed in China
17072019A



VX-80

User's Manual

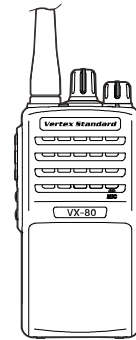

Programmable Functions

- 16 Analog Channels
- Programmable keys function
- Support communicate with radio directly and via repeater
- Support emergency alarm function
- Support high and low power switch
- Support talk around/reverse frequency function
- Support scan function
- Support wired clone function
- Support VOX function
- Support squelch tail elimination
- Support channel annunciation
- Support monitoring, 10 kinds of proportion of power saving
- Support 50 CTCSS frequency + 105 DCS code
- Support CPS software program

Table of Contents

Warnings	01
Check Equipment	14
Preparation	15
Charge the Battery Pack.....	15
Install / Remove Battery Pack.....	18
Install / Remove Antenna.....	19
Install Belt Clip.....	20
Install Earphone / Programming Jack.....	21
Get Familiar with the Radio	22
Guidance.....	22
LED Indicators.....	24
Manual Operation	25
Power ON / OFF.....	25
VOL Control.....	25
Channel Choosing.....	25
Channel Annunciation.....	25
Power On Tone.....	25

Table of Contents

TX.....	25
RX.....	26
Power Saving.....	26
TOT.....	27
VOX.....	27
Squelch Tail Elimination.....	27
Wide / Narrow Band Choice.....	27
Scan.....	27
Voice Annunciation.....	27
Wired Clone.....	28
Side-Button and Top-Button Definitions	29
Troubleshooting	31
Appendix I CTCSS(Hz)	32
Appendix II DCS	33

Congratulations!

Please take a few minutes to read this manual carefully. This information will help you troubleshoot and understand the products carefully.

Note: The parts of radio should not be operated by yourself. All maintenance services must be operated by an authorized service personnel. For any assistance, please contact  **Vertex Standard** authorized dealer.

Warnings:

The radio produced frequency electromagnetic energy during transmitting. The radio was designed and classified as only for professional purposes, represents only during work, operated by the employee who know the danger and know how to minimize the risk. This radio is not suitable for general staff in uncontrolled environment.

Caution

Before using this radio, read this booklet which contains important operating instructions. For information on product details, brochures, user manuals and approved accessories. Please refer to www.motorolasolutions.com.

Compliance with RF Exposure Standards

National and international regulations require manufacturers to comply with the RF energy exposure limits for portable two-way radios before they can be marketed. Your  **Vertex Standard** two-way radio is designed, manufactured, and tested to comply with all applicable national and international regulations for human exposure to radio frequency electromagnetic energy. When two-way radios are used as a consequence of employment, applicable regulations may require users to be fully aware of and able to control their exposure to meet occupational requirements.

RF Energy Exposure Awareness and Control Information and Operational Instructions for Occupational Use

 **Notice:** This radio is intended for use in occupational/controlled conditions where users are aware of their exposure and can exercise control over their exposure to meet the requirements in national

and international regulations. This radio device is not authorized for general population, consumer use.

For more information on what RF energy exposure is, and how to control your exposure to ensure compliance with established RF exposure limits, consult the following websites:

- <https://www.fcc.gov/>
- <https://www.osha.gov/>
- <https://osha.europa.eu/en>
- <http://www.who.int/peh-emf/project/en/>

For additional user training information on exposure requirements, consult the following websites:

- https://www.motorolasolutions.com/en_us/about/company-overview/corporate-responsibility/governance-and-policies/wireless-communication-and-health-faqs.html
- <http://learning.motorolasolutions.com/>

RF Exposure Compliance and Control Guidelines

To control your exposure, and ensure compliance with the relevant RF exposure limits, always adhere to the following guidelines:

- Do not remove any of the RF Exposure Labels if present from this device or its related accessories.
- Attach these instructions to the device when you transfer it to other users.
- Do not use this device if the operational requirements described herein are not met.

Operating Instructions

- Transmit no more than 50% of the time. To transmit (talk), press the Push-To-Talk (PTT) button. To receive calls, release the PTT button. Transmitting more than 50% of the time may cause RF exposure compliance requirements to be exceeded.
- Hold the radio in a vertical position in front of the face with the microphone (and other parts of the radio including the antenna) at least 1 in. (2.5 cm) away from the nose or lips. Antenna should be kept away from the eye.
- When worn on the body, always place the radio in a Vertex Standard-approved clip, holder, holster, case, or body harness for this product.
- DO NOT hold the antenna when the radio is transmitting.
- DO NOT use any portable radio that has a damaged antenna. If a damaged antenna comes into contact with your skin, a minor burn can result.
- To ensure continued compliance with applicable RF exposure limits, use only  Vertex Standard approved, supplied or replacement antennas, batteries, and accessories.
- For a list of Vertex Standard approved accessories please refer to your user manual or visit www.motorolasolutions.com

Acoustic Safety

Exposure to loud noises from any source for extended periods of time may temporarily or permanently affect your hearing. The louder the volume of the radio, the sooner your hearing will be affected. Hearing damage from loud noise is sometimes undetectable at first, and can have a cumulative effect.

To protect your hearing, follow these precautions:

- Use the lowest volume necessary to do your job.
- Turn up the volume only if you are in noisy surroundings.
- Turn down the volume before putting on a headset or headphones.
- Limit the amount of time you use a headset or headphones at high volume.
- When using the radio without a headset or headphones, do not place the speaker of the radio directly against your ear.

Medical Devices

If you use a personal medical device, such as a pacemaker or hearing aid, consult the manufacturer of your device to determine if it is adequately shielded from RF energy. Your physician may be able to assist you in obtaining this information.

Operational Warnings

The following explains the operational warnings:

For Vehicle With Air Bags



Warning:

- Refer to vehicle manufacturer's manual prior to installation of electronic equipment to avoid interference with air bag wiring.
- DO NOT place a portable radio in the area over an air bag or in the air bag deployment area. Air

bags inflate with great force. If a portable radio is placed in the air bag deployment area and the air bag inflates, the radio may be propelled with great force and cause serious injury to occupants of the vehicle.

Potentially Explosive Atmospheres



Warning:

- Use of a radio that is not intrinsically safe in a potentially explosive atmosphere could result in a serious injury or death. You should only use a certified Intrinsically Safe radio in potentially explosive atmospheres.
- Explosive atmospheres refer to hazard classified locations that may contain hazardous gas, vapors, dusts, such as fueling areas below decks on boats, fuel or chemical transfer or storage facilities, and areas where the air contains chemicals or particles such as grain, dust or metal powders. Areas with potentially explosive atmospheres are often, but not always, posted.
- Turn off your radio prior to entering any area with a potentially explosive atmosphere unless it is a radio type specifically certified for use in hazardous location areas.
- DO NOT remove, install, or charge batteries in such areas, or remove or install antennas. Sparks in a potentially explosive atmosphere can cause an explosion or fire resulting in bodily injury or even death.

Blasting Caps and Blasting Areas



Warning:

To avoid possible interference with blasting operations, turn off your radio when you are near

electrical blasting caps, in a blasting area, or in areas posted: "Turn off two-way radio." Obey all signs and instructions.

Batteries

- Charge your battery using the approved Vertex Standard charger.
Use the battery in accordance with its water and/or dust Ingress Protection (IP) rating.
- Do not discard your battery into a fire.
- Do not replace the battery in any area labeled "Hazardous Atmosphere".
- Do not disassemble, crush, puncture, shred, or otherwise attempt to change the form of your battery.
- Do not dry a wet or damp battery with an appliance or heat source, such as a hair dryer or microwave oven.
- Do not allow conductive material such as jewelry, keys, or beaded chains to touch exposed battery terminals.
- Do not dispose of batteries with household waste.

Repair



Warning:

Repairs to a Vertex Standard intrinsically safe radio product certified by, for example, FM, UL, CSA, CENELEC, should only be done at a location that has been audited under the certifying body's repair and service standard.

Contact Vertex Standard for assistance regarding repairs and service of  intrinsically safe equipment.

A repair constitutes something done internally to the unit that would bring it back to its original condition. Items not considered as repairs are those in which an action is performed on a unit which does not require the outer casing of the unit to be opened in a manner that exposes the internal electrical circuits of the unit.

Do Not Substitute Options or Accessories

The Vertex Standard communications equipment certified as intrinsically safe by the approving agency (FM, UL, CSA, CENELEC) is tested as a complete system which consists of the listed agency Approved portable, Approved battery, and Approved accessories or options, or both. This Approved portable and battery combination must be strictly observed. There must be no substitution of items, even if the substitute has been previously Approved with a different Vertex Standard communications equipment unit. Approved configurations are list Approving Agency (FM, UL, CSA, CENELEC).

The Intrinsically Safe Approval Label affixed to radio refers to the intrinsically safe classification of that radio product, and the approved batteries that can be used with that system.

The manual PN referenced on the Intrinsically Safe Approval Label identifies the approved Accessories and or options that can be used with that portable radio unit. Using a non-Vertex Standard-intrinsically safe battery and/or accessory with the  approved radio unit will void the intrinsically safe approval of that radio unit.

European Union(EU) Waste of Electrical and Electronic Equipment (WEEE) Directive



The European Union's WEEE directive requires that products sold into EU countries must have the crossed out trash bin label on the product (or the package in some cases). As defined by the WEEE

directive, this cross-out trash bin label means that customers and end-users in EU countries should not dispose of electronic and electrical equipment or accessories in household waste. Customers or end-users in EU countries should contact their local equipment supplier representative or service centre for information about the waste collection system in their country.

- This radio is not allowed to use by the general staff in uncontrolled radiation environment. The radio is limited to professional use and work-related operations, Radio operator must be able to control his knowledge of radio frequency radiation condition.
- When transmitting, hold the radio in a vertical position, the microphone 5 cm away from the mouth, holding the antenna at least 5 cm away from the head and body.
- When typical key configuration, the maximum operating cycle of radio does not exceed 50%. Do not exceed the total time of 50% (50% duty cycle).
When the red LED light on, means the radio is transmitting. Pressing the PTT key, the radio signal can be transmitted.
- Always use  **Vertex Standard** certified accessories.
- Electromagnetic interference / compatibility.
During transmission, the radio produced frequency energy which may interfere in other devices or systems. To avoid such interference, turn off the radio equipment in some occasion which posted turn off radio equipment signs.
- Does not use the radio in some occasions which is sensitive to electromagnetic radiation, such as hospitals, health care facilities, aircraft, and blasting place.

FCC Compliance Statement

This device complies with Part 15 of the FCC Rules.

Operation is subject to the following condition.

- (1) This device may not cause harmful interference.
- (2) This device must accept any interference received, including interference that may cause undesired operation.
- (3) Changes or modification not expressly approved by Motorola may void the user's authority to operate this equipment.

Supplier's Declaration of Conformity

Per FCC CFR 47 Part 2 Section 2.1077(a)



Responsible Party

Name: Motorola Solutions, Inc.

Address: 1303 East Algonquin Road,
Schaumburg IL 60196-1078, U.S.A.

Phone Number: 1-800-927-2744

Hereby declares that the product:

Model Name: VX-80

conforms to the following regulations:

FCC Part 15, subpart B, section 15.107(a)

15.107(d), and section 15.109(a)

Licensing Information (Brazil)

“Este produto está homologado pela Anatel de acordo com os procedimentos regulamentados para avaliação da conformidade de produtos para telecomunicações e atende aos requisitos técnicos aplicados, incluindo os limites de exposição da Taxa de Absorção Específica referente a campos elétricos, magnéticos e eletromagnéticos de radiofrequência.”

SAR

The device is homologated by Anatel according the regulatory procedures to compliance evaluate for telecommunications devices and it attends to the technical requirement applied, including the specific Absorption Rate exposition limits related to the electric fields, magnetic and electromagnetic of radio frequency. The maximum SAR value measured for this device are:

___ W/Kg (Head)

___ W/Kg (Body)

Check Equipment

Welcome to use  **Vertex Standard** radios, before using we suggest you:

- Please check the packing box of this product and see if there are signs of damage.
- Please open the packing box carefully. We recommend that you identify the items listed in the following packing list. If you find that our product and its accessories in handling are lost or damaged during the shipment. Please immediately contact  **Vertex Standard** dealers.

Preparations

■ Charge the Battery Pack

1. Using the battery

The battery is not completely charged at the factory, please charge it before using.

To extend the battery life time, please power off the battery when you don't use two way radio, and save battery in a cool (temperature less than 25 C) and dry place.

2. Battery Characteristics

- The battery will be wear out even if it is never used.
- After repeatedly being charged/discharging, its capacity will gradually reduce.
- Under the high temperature environment, charging the battery will shorten its lifetime.
- For optimum battery life, do not charge the battery for prolonged periods after it is fully charged.
- Even correct charging the battery, if use time of the two way radio significantly reduce, which means battery lifetime is over, please change the new battery.

3 Charging the Battery

Please use the battery charger designated by  **Vertex Standard** to charge battery After purchase or extended storage (more than two months), the first time to charge battery cannot make battery reach its normal operating capacity. After repeating charge /discharge it two or three times, the operating capacity will increase to its normal capacity.

Preparations

4. Please Charge the Battery as Follows:

When the battery capacity is lower than the preset value, two way radio will forbid to transmit. Light status indicator will flash in red ; And voice prompts available .

You can also set by PC program if TX at lower battery .To extend the battery lifetime ,we suggest to prohibit TX at low battery .

Note:

Do NOT turn on the radio while charging.

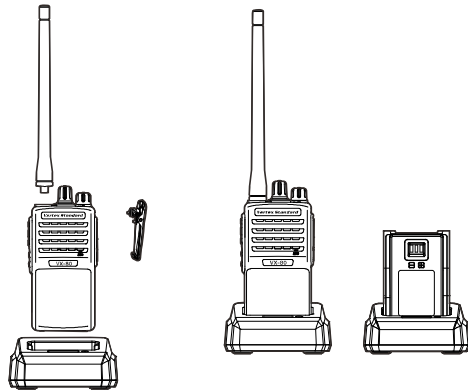

Preparations

Status	Indicator
Power Connected	Orange light is on about 0.5 seconds then goes out
No battery(temperature end judges)	All go out
Charge normally	Red light is on
The battery is fully charged	Green light is on
Fault (over temperature, battery short circuit or over discharge state)	Red light flashes

Please Charge the Radio According to Operation Steps as Follows:

1.Use only approved Power Supply. List of approved Power Supply as below:

Part Number	Model
CZ083P005	Brazil
CZ083P007	Argentina
CZ083P008	UL

Preparations

2. Insert power adapter into power supply socket.
3. Insert output terminal of power adapter into DC jack behind the charging kit, now the charging
4. orange indicator lights about 0.5 seconds then goes out.
Insert the battery or radio equipped with battery into the charging kit.
5. Confirm the battery and charging kit terminal contact reliably, when charging indicator light turns into red and charging starts.
6. After completion of charge (charging time about 5 hours), light turns to be green.

■ Install / Remove Battery Pack

- Make the two bulge positioning latch of the battery pack correspond with the hole of radio;
- Press the battery pack into the radio lightly until buckling together;
- To remove the battery pack, please confirm that the radio is off, then press the battery pack lightly before push outward the buckle at bottom of the radio, then remove the battery pack.

Note:

- * DO NOT make the battery pack short-circuit or throw into the fire.
- * DO NOT disassemble the battery pack.

Preparations

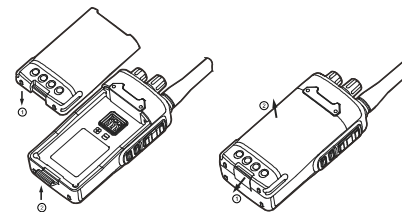

■ Install / Remove Antenna

Hold the bottom part of the antenna and screw the antenna in clockwise direction into the antenna base on the top of the radio, until it is tight.

To remove the antenna, screw the antenna in an anti-clockwise direction to remove the antenna from the radio.

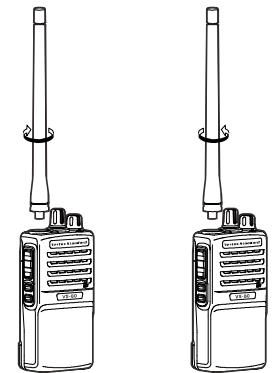

Preparations

■ Install Belt Clip

Where necessary, you can lock the belt clip provided together with the radio into the screw holes for easy carrying;
To remove the belt clip, unscrew the two screws.

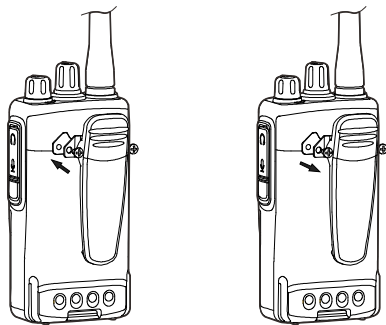

Preparations

■ Installing Earphone /Programming Jack

Uncover earphone lid, directly insert earphones into earphone holes (earphones need to be additionally purchased).

You can use computer programming software to operate (consult with local dealers about computer programming software).

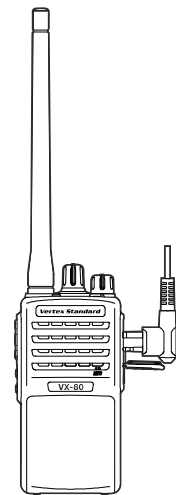

Get Familiar with the Radio

■ Guidance

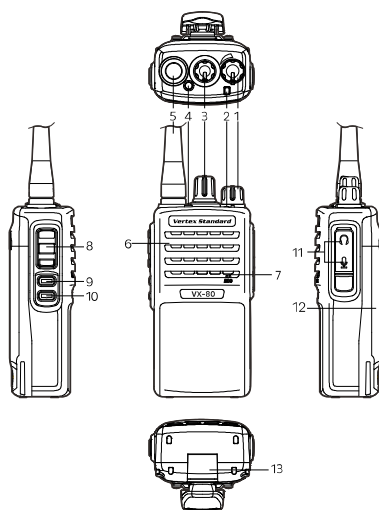

Get Familiar with the Radio

● 1. Power On/Off/Volume Adjustment

It is for use to turn the radio on/off and to adjust the volume level.

● 2. LED State Indicator

The indicator glows red when transmitting and green when receiving.

● 3. Channel Knob

It is used to select channels.

● 4. Top Key (TK)

As defined by programming software.

● 5. Antenna

It is for use to transmit/receive signals.

● 6. Speaker

It is used to output voices.

● 7. Microphone

It is used to input voices.

● 8. Push-To-Talk Button (PTT)

Press (PTT) button to put the radio in transmitting state; release the button to restore to

receiving state.

● 9. Programmable Side Key 1 (SB1)

As defined by programming software.

● 10. Programmable Side Key 2 (SB2)

As defined by programming software.

● 11. Microphone/Speaker Jack

It is for use to connect to earphone you have purchased. If needed, you can connect to a PC programmable cable in order to read/write the frequency of the radio via PC software.

● 12. Battery Pack

Power source to radio.

● 13. Battery Latch

To install / remove the battery pack.

Get Familiar with the Radio

■ LED Indicators

The LED on the top of the radio helps you to understand the current status of the radio.

LED State	Radio State
Red light always on	Indicating transmitting or within a call on hold period
Blinking Red	Low battery voltage state
Green light always on	Indicating receiving
Green lights flashing	Is scanning
Programming	Green light fast flashing indicates RXD; Green light fast flashing and then red light fast flashing means TXD

Manual Operation

■ Power ON / OFF

Power ON: Turn the power switch knob clockwise to turn on radio power;
Power OFF: To turn it off, turn the power switch knob counter-clockwise.

■ VOL Control

Turn the volume switch knob clockwise to increase volume;
To decrease the volume, rotate the volume switch knob counter-clockwise.

■ Channel Choosing

Rotate the channel knob to select the channel you want to use.
XV-80 a total of 16 channels to choose from.
Remarks: If some channels are not programmed, they will not be used. When choose the channel which is not been programmed, the radio will

issue "du" sound.

■ Channel Annunciation

The radio provides a personalized channel voice broadcast function. Voice broadcast can be off by computer programming software.

■ Power On Tone

When you open this function, will be issued a "du, power on" tone, then the voice broadcast channel. There are 5 kinds of tone available.

■ TX

1. According to different settings of monitor, please monitor the radio for some while. Ensure there is no radio transmitting at the chosen channel.
2. Press PTT and face to microphone talking.

Manual Operation

- Please make the distance between your lip and microphone at 2.5-5 cm, and talk as usual to get the best voice quality.
 - Press and Hold PTT, LED red light is on.
 - Release PTT to receive information.
3. Also users can active the VOX function which no need to use earphone.

■ RX

When radio receiving information, green LED lights.

- Only same signaling and CTCSS setting can receive information.
- May not receive any calling if radio is at lower signal and set high level SQL.
- Local dealer maybe program your radio with CTCSS/DCS. Users can receive the same signaling information if chosen channel with

CTCSS/DCS. Or it can not get any calling. Radio with CTCSS/DCS will help you to ignore ineffective calling. Although there seems special channel for CTCSS/DCS, radio also can communicate with other radio which programmed the same CTCSS/DCS.

■ Power Saving

Power saving function allows you to extend the battery life by allowing your radio to enter the standby state. You can set power saving type by programming software. To slightly increase the speed of the response, set the power saving type to no, so that you can be ready to transmit or receive the signal at any time without delay. There are 10 types of power saving options.

Manual Operation

■ TOT

The timeout is to prevent the use of a long time to take over the channel, but also to prevent the radio due to the long time firing caused damage. If you continuous transmit time exceed time limit, the radio will stop work and issue "du" sound. Then you need to release the PTT button, after a period of time to continue to transmit.

■ VOX

VOX function make the radio work without operation, you must set the sound gain level before using VOX (programmable), and open the VOX function.

■ Squelch Tail Elimination

The radio which set this function, will not hear the "ca" sound due to the end of the call or the carrier disappear, which makes you from noise impact problems.

■ Wide / Narrow Band Choice

There are two channels 12.5KHz and 25KHz to choose from.

■ Scan

The scanning function helps you listen to the communication activities on other channels, so as to know the current status of the team members.

■ Voice Annunciation

When you turn on this function, you will be able to open a full English voice broadcast.

Manual Operation

■ Wired Clone

Either the master radio or slave radio must be enabled to enter this mode before clone.

Procedures:

- Connect the master radio and slave radio with clone wire.
- Power on the slave radio. Hold the master radio SB2+PTT buttons to power on the master radio.
- Hold the SB1 key to start cloning. In cloning process, green indication light blinks on the master radio and red indication light blinks on the slave radio.
- After the cloning succeeds, the slave radio will be powered on automatically.
- Press SB1 key to clone next slave radio.

Side-Button and Top-Button Definitions

- There are six operating methods to be programmed by PC software.

SB1	Short Press
	Long Press
SB2	Short Press
	Long Press
TK	Short Press
	Long Press

Side-Button and Top-Button Definitions

■ See following side-button and top-button functions:

English	Details
Off	No function available.
Scan	Scanning memorial channel.
VOX	Turn on/off VOX.
Monitor	Stop/Start monitor the QT or DQT ,meanwhile radio automatically turn on SQL when receives carrier signal.
Adjust Power Level	High/Low power exchange.
Emergency Alarm	Turn on emergency call function.
Squelch Off	Turn on SQL and while receive carrier signal, radio speaker actives.
Battery Volume	Alert tone to indicate battery status.
Squelch Off Momentary	Active this SQ, and keep at SQ state when radio receives carrier wave (Short press is invalid for this function).

Troubleshooting

Symptom	Try This
No power.	<ul style="list-style-type: none"> ● Battery power may have run out, please update battery or recharge it. ● Battery may not be properly installed, please take it off and re-install.
Battery lasts a short time after charge.	<ul style="list-style-type: none"> ● The battery life is over, please replace new battery.
Can not talk to other members of your group.	<ul style="list-style-type: none"> ● Verify transmitting is within effective operating range. ● Verify channel, frequency and code settings are correct.
Hearing other conversation on a channel (not group members').	<ul style="list-style-type: none"> ● Please change code settings, including all two way radio settings of your group.

Appendix I CTCSS (Hz)

1-67.0	14-103.5	27-159.8	40-199.5
2-69.3	15-107.5	28-162.2	41-203.5
3-71.9	16-110.9	29-165.5	42-206.5
4-74.4	17-114.8	30-167.9	43-210.7
5-77.0	18-118.8	31-171.3	44-218.1
6-79.7	19-123.0	32-173.8	45-225.7
7-82.5	20-127.3	33-177.3	46-229.1
8-85.4	21-131.8	34-179.9	47-233.6
9-88.5	22-136.5	35-183.5	48-241.8
10-91.5	23-141.3	36-186.2	49-250.3
11-94.8	24-146.2	37-189.9	50-254.1
12-97.4	25-151.4	38-192.8	
13-100.0	26-156.7	39-196.6	

Appendix II DCS

023	071	143	225	266	356	452	532	664
025	072	145	226	271	364	454	546	703
026	073	152	243	274	365	455	565	712
031	074	155	244	306	371	462	606	723
032	114	156	246	311	411	464	612	731
036	115	162	245	315	412	465	624	732
043	116	165	251	325	413	466	627	734
047	122	172	252	331	423	503	631	743
051	125	174	255	332	431	506	632	754
053	131	205	261	343	432	516	645	
054	132	212	263	346	445	523	654	
065	134	223	265	351	446	526	662	

All of the above suggestions are equally applicable to your two way radio , battery, charger and various accessories. If any equipment can not work normally, please send it to the nearest maintenance agency authorized for repairing.