



# FCC RF Test Report

APPLICANT : HMD BIOMEDICAL INC.  
EQUIPMENT : GSM Meter  
BRAND NAME : GL GoodLife  
MODEL NAME : Cloudia  
MARKETING NAME : GL GoodLife Blood Glucose Monitoring System (Cloudia)  
FCC ID : AYY0000002  
STANDARD : FCC 47 CFR Part 2, 22(H), 24(E)  
CLASSIFICATION : PCS Licensed Transmitter (PCB)

The product was received on Feb. 22, 2016 and testing was completed on May 13, 2016. We, SPORTON INTERNATIONAL INC., would like to declare that the tested sample has been evaluated in accordance with the test procedures given in ANSI / TIA / EIA-603-D-2010 and has been in compliance with the applicable technical standards.

The test results in this report apply exclusively to the tested model / sample. Without written approval of SPORTON INTERNATIONAL INC., the test report shall not be reproduced except in full.

Reviewed by: Joseph Lin / Supervisor

Approved by: Jones Tsai / Manager



## SPORTON INTERNATIONAL INC.

No. 52, Hwa Ya 1<sup>st</sup> Rd., Hwa Ya Technology Park, Kwei-Shan District, Tao Yuan City, Taiwan, R.O.C.

SPORTON INTERNATIONAL INC.

TEL : 886-3-327-3456

FAX : 886-3-328-4978

FCC ID : AYY0000002

Page Number : 1 of 22

Report Issued Date : May 18, 2016

Report Version : Rev. 01

Report Template No.: BU5-FG22/24 Version 1.1



# TABLE OF CONTENTS

REVISION HISTORY..... 3

SUMMARY OF TEST RESULT ..... 4

**1 GENERAL DESCRIPTION ..... 5**

    1.1 Applicant..... 5

    1.2 Manufacturer ..... 5

    1.3 Product Feature of Equipment Under Test ..... 5

    1.4 Product Specification of Equipment Under Test ..... 6

    1.5 Modification of EUT ..... 6

    1.6 Maximum ERP/EIRP Power, Frequency Tolerance, and Emission Designator ..... 7

    1.7 Testing Location ..... 7

    1.8 Applicable Standards ..... 8

**2 TEST CONFIGURATION OF EQUIPMENT UNDER TEST ..... 9**

    2.1 Test Mode..... 9

    2.2 Connection Diagram of Test System ..... 9

    2.3 Support Unit used in test configuration ..... 10

    2.4 Measurement Results Explanation Example ..... 10

**3 CONDUCTED TEST RESULT ..... 11**

    3.1 Measuring Instruments..... 11

    3.2 Test Setup ..... 11

    3.3 Test Result of Conducted Test..... 11

    3.4 Conducted Output Power ..... 12

    3.5 Peak-to-Average Ratio ..... 13

    3.6 99% Occupied Bandwidth and 26dB Bandwidth Measurement..... 14

    3.7 Conducted Band Edge ..... 15

    3.8 Conducted Spurious Emission ..... 16

    3.9 Frequency Stability..... 17

**4 RADIATED TEST ITEMS ..... 18**

    4.1 Measuring Instruments..... 18

    4.2 Test Setup ..... 18

    4.3 Test Result of Radiated Test..... 18

    4.4 Effective Radiated Power and Effective Isotropic Radiated Power Measurement ..... 19

    4.5 Field Strength of Spurious Radiation Measurement ..... 20

**5 LIST OF MEASURING EQUIPMENT ..... 21**

**6 UNCERTAINTY OF EVALUATION ..... 22**

**APPENDIX A. TEST RESULTS OF CONDUCTED TEST**

**APPENDIX B. TEST RESULTS OF RADIATED TEST**

**APPENDIX C. TEST SETUP PHOTOGRAPHS**



### REVISION HISTORY

REPORT NO.	VERSION	DESCRIPTION	ISSUED DATE
FG622202	Rev. 01	Initial issue of report	May 18, 2016



## SUMMARY OF TEST RESULT

Report Section	FCC Rule	Description	Limit	Result	Remark
3.4	§2.1046	Conducted Output Power	Reporting Only	PASS	-
3.5	§24.232(d)	Peak-to-Average Ratio	< 13 dB	PASS	-
3.6	§2.1049 §22.917(b) §24.238(b)	Occupied Bandwidth	Reporting Only	PASS	-
3.7	§2.1051 §22.917(a) §24.238(a)	Band Edge Measurement	< 43+10log10(P[Watts])	PASS	-
3.8	§2.1051 §22.917(a) §24.238(a)	Conducted Emission	< 43+10log10(P[Watts])	PASS	-
3.9	§2.1055 §22.355	Frequency Stability for Temperature & Voltage	< 2.5 ppm for Part 22	PASS	-
	§2.1055 §24.235		Within Authorized Band		
4.4	§22.913(a)(2)	Effective Radiated Power	< 7 Watts	PASS	-
	§24.232(c)	Equivalent Isotropic Radiated Power	< 2 Watts	PASS	
4.5	§2.1053 §22.917(a) §24.238(a)	Field Strength of Spurious Radiation	< 43+10log10(P[Watts])	PASS	Under limit 13.12 dB at 5548.000 MHz



# 1 General Description

## 1.1 Applicant

HMD BIOMEDICAL INC.

No. 181, Minsheng St., Xinpu Township, Hsinchu County 305, Taiwan (R.O.C.)

## 1.2 Manufacturer

HMD BIOMEDICAL INC.

No. 181, Minsheng St., Xinpu Township, Hsinchu County 305, Taiwan (R.O.C.)

## 1.3 Product Feature of Equipment Under Test

Product Feature	
Equipment	GSM Meter
Brand Name	GL GoodLife
Model Name	Cloudia
Marketing Name	GL GoodLife Blood Glucose Monitoring System (Cloudia)
FCC ID	AYY0000002
EUT supports Radios application	GSM/EGPRS/WCDMA/HSPA
HW Version	P801GS2N2CV1.3_T_151119-1
SW Version	1.0
EUT Stage	Identical Prototype

**Remark:** The above EUT's information was declared by manufacturer. Please refer to the specifications or user's manual for more detailed description.



### 1.4 Product Specification of Equipment Under Test

Standards-related Product Specification	
<b>Tx Frequency</b>	<b>GSM/GPRS/EDGE:</b> 850: 824.2 MHz ~ 848.8 MHz 1900: 1850.2 MHz ~ 1909.8MHz <b>WCDMA:</b> Band V: 826.4 MHz ~ 846.6 MHz Band II: 1852.4 MHz ~ 1907.6 MHz
<b>Rx Frequency</b>	<b>GSM/GPRS/EDGE:</b> 850: 869.2 MHz ~ 893.8 MHz 1900: 1930.2 MHz ~ 1989.8 MHz <b>WCDMA:</b> Band V: 871.4 MHz ~ 891.6 MHz Band II: 1932.4 MHz ~ 1987.6 MHz
<b>Maximum Output Power to Antenna</b>	<b>GSM/GPRS/EDGE:</b> 850: 32.11 dBm 1900: 29.03 dBm <b>WCDMA:</b> Band V: 23.40 dBm Band II: 20.09 dBm
<b>Antenna Type</b>	Fixed External Antenna
<b>Type of Modulation</b>	GSM: GMSK GPRS: GMSK EDGE: GMSK / 8PSK WCDMA: QPSK (Uplink) HSDPA: 16QAM (Uplink) HSUPA: QPSK (Uplink)

### 1.5 Modification of EUT

No modifications are made to the EUT during all test items.



### 1.6 Maximum ERP/EIRP Power, Frequency Tolerance, and Emission Designator

FCC Rule	System	Type of Modulation	Maximum ERP/EIRP (W)	Frequency Tolerance (ppm)	Emission Designator
Part 22	GSM850 GPRS class 8	GMSK	1.2888	0.0072 ppm	245KGXW
Part 22	GSM850 EDGE class 8	8PSK	0.3296	0.0072 ppm	248KG7W
Part 22	WCDMA Band V RMC 12.2Kbps	QPSK	0.1854	0.0167 ppm	4M06F9W
Part 24	GSM1900 GPRS class 8	GMSK	1.4420	0.0186 ppm	246KGXW
Part 24	GSM1900 EDGE class 8	8PSK	0.5715	0.0043 ppm	249KG7W
Part 24	WCDMA Band II RMC 12.2Kbps	QPSK	0.3196	0.0027 ppm	4M07F9W

### 1.7 Testing Location

Sporton Lab is accredited to ISO 17025 by Taiwan Accreditation Foundation (TAF code : 1190) and the FCC designation No. TW1022 under the FCC 2.948(e) by Mutual Recognition Agreement (MRA) in FCC Test.

<b>Test Site</b>	SPORTON INTERNATIONAL INC.
<b>Test Site Location</b>	No. 52, Hwa Ya 1 <sup>st</sup> Rd., Hwa Ya Technology Park, Kwei-Shan District, Tao Yuan City, Taiwan, R.O.C. TEL: +886-3-327-3456 FAX: +886-3-328-4978
<b>Test Site No.</b>	<b>Sporton Site No.</b> TH03-HY

<b>Test Site</b>	SPORTON INTERNATIONAL INC.
<b>Test Site Location</b>	No.58, Aly. 75, Ln. 564, Wenhua 3rd Rd. Guishan Dist, Taoyuan City, Taiwan (R.O.C.) TEL: +886-3-327-0868 FAX: +886-3-327-0855
<b>Test Site No.</b>	<b>Sporton Site No.</b> 03CH11-HY



## 1.8 Applicable Standards

According to the specifications of the manufacturer, the EUT must comply with the requirements of the following standards:

- ♦ 47 CFR Part 2, 22(H), 24(E)
- ♦ ANSI / TIA / EIA-603-D-2010
- ♦ FCC KDB 971168 D01 Power Meas. License Digital Systems v02r02

### **Remark:**

1. All test items were verified and recorded according to the standards and without any deviation during the test.
2. This EUT has also been tested and complied with the requirements of FCC Part 15, Subpart B, recorded in a separate test report.



## 2 Test Configuration of Equipment Under Test

### 2.1 Test Mode

Antenna port conducted and radiated test items were performed according to KDB 971168 D01 Power Meas. License Digital Systems v02r02 with maximum output power.

Radiated measurements were performed with rotating EUT in different three orthogonal test planes to find the maximum emission.

Radiated emissions were investigated as following frequency range:

1. 30 MHz to 9000 MHz for GSM850 and WCDMA Band V.
2. 30 MHz to 19000 MHz for GSM1900 and WCDMA Band II.

All modes and data rates and positions were investigated.

Test modes are chosen to be reported as the worst case configuration below:

Test Modes		
Band	Radiated TCs	Conducted TCs
GSM 850	<ul style="list-style-type: none"> <li>■ GPRS class 8 Link</li> <li>■ EDGE class 8 Link</li> </ul>	<ul style="list-style-type: none"> <li>■ GPRS class 8 Link</li> <li>■ EDGE class 8 Link</li> </ul>
GSM 1900	<ul style="list-style-type: none"> <li>■ GPRS class 8 Link</li> <li>■ EDGE class 8 Link</li> </ul>	<ul style="list-style-type: none"> <li>■ GPRS class 8 Link</li> <li>■ EDGE class 8 Link</li> </ul>
WCDMA Band V	<ul style="list-style-type: none"> <li>■ RMC 12.2Kbps Link</li> </ul>	<ul style="list-style-type: none"> <li>■ RMC 12.2Kbps Link</li> </ul>
WCDMA Band II	<ul style="list-style-type: none"> <li>■ RMC 12.2Kbps Link</li> </ul>	<ul style="list-style-type: none"> <li>■ RMC 12.2Kbps Link</li> </ul>

### 2.2 Connection Diagram of Test System





### 2.3 Support Unit used in test configuration

Item	Equipment	Trade Name	Model No.	FCC ID	Data Cable	Power Cord
1.	System Simulator	R&S	CMU 200	N/A	N/A	Unshielded, 1.8 m

### 2.4 Measurement Results Explanation Example

For all conducted test items:

The offset level is set in the spectrum analyzer to compensate the RF cable loss and attenuator factor between RF conducted output port and spectrum analyzer. With the offset compensation, the spectrum analyzer reading level will be exactly the RF output level.

The spectrum analyzer offset is derived from RF cable loss and attenuator factor.

$$\text{Offset} = \text{RF cable loss} + \text{attenuator factor}.$$

The following shows an offset computation example with RF cable loss 4.2 dB and a 10dB attenuator.

Example :

$$\begin{aligned} \text{Offset(dB)} &= \text{RF cable loss(dB)} + \text{attenuator factor(dB)}. \\ &= 4.2 + 10 = 14.2 \text{ (dB)} \end{aligned}$$

### 3 Conducted Test Result

#### 3.1 Measuring Instruments

See list of measuring instruments of this test report.

#### 3.2 Test Setup

##### 3.2.1 Conducted Output Power



##### 3.2.2 Peak-to-Average Ratio, Occupied Bandwidth, Conducted Band-Edge and Conducted Spurious Emission

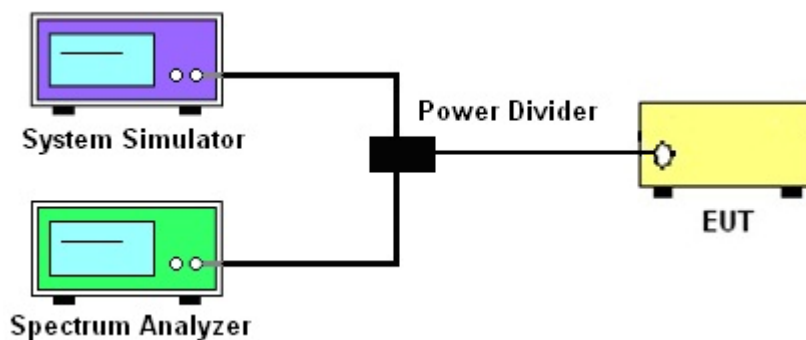

##### 3.2.3 Frequency Stability

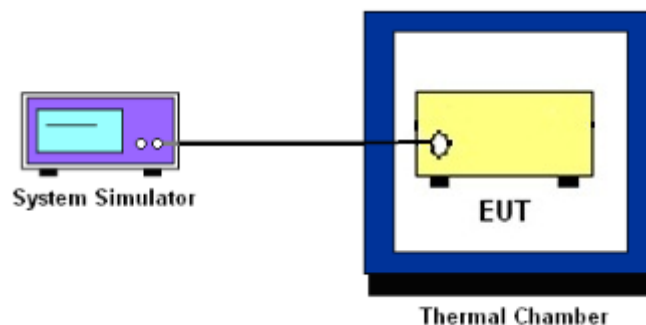

### 3.3 Test Result of Conducted Test

Please refer to Appendix A.



## **3.4 Conducted Output Power**

### **3.4.1 Description of the Conducted Output Power**

A system simulator was used to establish communication with the EUT. Its parameters were set to enforce EUT transmitting at the maximum power. The measured power in the radio frequency on the transmitter output terminals shall be reported.

### **3.4.2 Test Procedures**

1. The transmitter output port was connected to the system simulator.
2. Set EUT at maximum power through system simulator.
3. Select lowest, middle, and highest channels for each band and different modulation.
4. Measure the maximum burst average power for GSM and maximum average power for other modulation signal.



## **3.5 Peak-to-Average Ratio**

### **3.5.1 Description of the PAR Measurement**

The peak-to-average ratio (PAR) of the transmission may not exceed 13 dB.

### **3.5.2 Test Procedures**

1. The testing follows FCC KDB 971168 D01 v02r02 Section 5.7.1.
2. The EUT was connected to spectrum analyzer and system simulator via a power divider.
3. Set EUT to transmit at maximum output power.
4. When the duty cycle is less than 98%, then signal gating will be implemented on the spectrum analyzer by triggering from the system simulator.
5. Set the CCDF (Complementary Cumulative Distribution Function) option of the spectrum analyzer.  
Record the maximum PAPR level associated with a probability of 0.1%.



## **3.6 99% Occupied Bandwidth and 26dB Bandwidth Measurement**

### **3.6.1 Description of 99% Occupied Bandwidth and 26dB Bandwidth Measurement**

The occupied bandwidth is the width of a frequency band such that, below the lower and above the upper frequency limits, the mean powers emitted are each equal to a specified percentage 0.5% of the total mean transmitted power.

The 26 dB emission bandwidth is defined as the frequency range between two points, one above and one below the carrier frequency, at which the spectral density of the emission is attenuated 26 dB below the maximum in-band spectral density of the modulated signal. Spectral density (power per unit bandwidth) is to be measured with a detector of resolution bandwidth equal to approximately 1.0% of the emission bandwidth.

### **3.6.2 Test Procedures**

1. The testing follows FCC KDB 971168 v02r02 Section 4.2.
2. The EUT was connected to spectrum analyzer and system simulator via a power divider.
3. The spectrum analyzer center frequency is set to the nominal EUT channel center frequency. The span range for the spectrum analyzer shall be between two and five times the anticipated OBW.
4. The nominal resolution bandwidth (RBW) shall be in the range of 1 to 5 % of the anticipated OBW, and the VBW shall be at least 3 times the RBW.
5. Set the detection mode to peak, and the trace mode to max hold.
6. Determine the reference value: Set the EUT to transmit a modulated signal. Allow the trace to stabilize. Set the spectrum analyzer marker to the highest level of the displayed trace.  
(this is the reference value)
7. Determine the “-26 dB down amplitude” as equal to (Reference Value – X).
8. Place two markers, one at the lowest and the other at the highest frequency of the envelope of the spectral display such that each marker is at or slightly below the “-X dB down amplitude” determined in step 6. If a marker is below this “-X dB down amplitude” value it shall be placed as close as possible to this value. The OBW is the positive frequency difference between the two markers.
9. Use the 99 % power bandwidth function of the spectrum analyzer and report the measured bandwidth.



### 3.7 Conducted Band Edge

#### 3.7.1 Description of Conducted Band Edge Measurement

The power of any emission outside of the authorized operating frequency ranges must be lower than the transmitter power (P) by a factor of at least  $43 + 10 \log (P)$  dB.

#### 3.7.2 Test Procedures

1. The testing follows FCC KDB 971168 D01 v02r02 Section 6.0.
2. The EUT was connected to the spectrum analyzer and system simulator via a power divider.
3. The RF output of EUT was connected to the spectrum analyzer by an RF cable and attenuator. The path loss was compensated to the results for each measurement.
4. The band edges of low and high channels for the highest RF powers were measured.
5. The RF fundamental frequency should be excluded against the limit line in the operating frequency band.
6. The limit line is derived from  $43 + 10\log(P)$  dB below the transmitter power P(Watts)  
=  $P(W) - [43 + 10\log(P)]$  (dB)  
=  $[30 + 10\log(P)]$  (dBm) -  $[43 + 10\log(P)]$  (dB)  
= -13dBm.



### 3.8 Conducted Spurious Emission

#### 3.8.1 Description of Conducted Spurious Emission Measurement

The power of any emission outside of the authorized operating frequency ranges must be lower than the transmitter power (P) by a factor of at least  $43 + 10 \log (P)$  dB.

It is measured by means of a calibrated spectrum analyzer and scanned from 30 MHz up to a frequency including its 10<sup>th</sup> harmonic.

#### 3.8.2 Test Procedures

1. The testing follows FCC KDB 971168 D01 v02r02 Section 6.0.
2. The EUT was connected to the spectrum analyzer and system simulator via a power divider.
3. The RF output of EUT was connected to the spectrum analyzer by an RF cable and attenuator. The path loss was compensated to the results for each measurement.
4. The middle channel for the highest RF power within the transmitting frequency was measured.
5. The conducted spurious emission for the whole frequency range was taken.
6. The RF fundamental frequency should be excluded against the limit line in the operating frequency band.
7. The limit line is derived from  $43 + 10\log(P)$  dB below the transmitter power P(Watts)  
=  $P(W) - [43 + 10\log(P)]$  (dB)  
=  $[30 + 10\log(P)]$  (dBm) -  $[43 + 10\log(P)]$  (dB)  
= -13dBm.





### **3.9 Frequency Stability**

#### **3.9.1 Description of Frequency Stability Measurement**

The frequency stability shall be measured by variation of ambient temperature and variation of primary supply voltage to ensure that the fundamental emission stays within the authorized frequency block. The frequency stability of the transmitter shall be maintained within  $\pm 0.00025\%$  ( $\pm 2.5\text{ppm}$ ) of the center frequency.

#### **3.9.2 Test Procedures for Temperature Variation**

1. The testing follows FCC KDB 971168 D01 v02r02 Section 9.0.
2. The EUT was set up in the thermal chamber and connected with the system simulator.
3. With power OFF, the temperature was decreased to  $-30^{\circ}\text{C}$  and the EUT was stabilized before testing. Power was applied and the maximum change in frequency was recorded within one minute.
4. With power OFF, the temperature was raised in  $10^{\circ}\text{C}$  steps up to  $50^{\circ}\text{C}$ . The EUT was stabilized at each step for at least half an hour. Power was applied and the maximum frequency change was recorded within one minute.

#### **3.9.3 Test Procedures for Voltage Variation**

1. The testing follows FCC KDB 971168 D01 v02r02 Section 9.0.
2. The EUT was placed in a temperature chamber at  $25\pm 5^{\circ}\text{C}$  and connected with the system simulator.
3. The power supply voltage to the EUT was varied from 85% to 115% of the nominal value measured at the input to the EUT.
4. The variation in frequency was measured for the worst case.

## 4 Radiated Test Items

### 4.1 Measuring Instruments

See list of measuring instruments of this test report.

### 4.2 Test Setup

#### 4.2.1 For radiated test from 30MHz to 1GHz

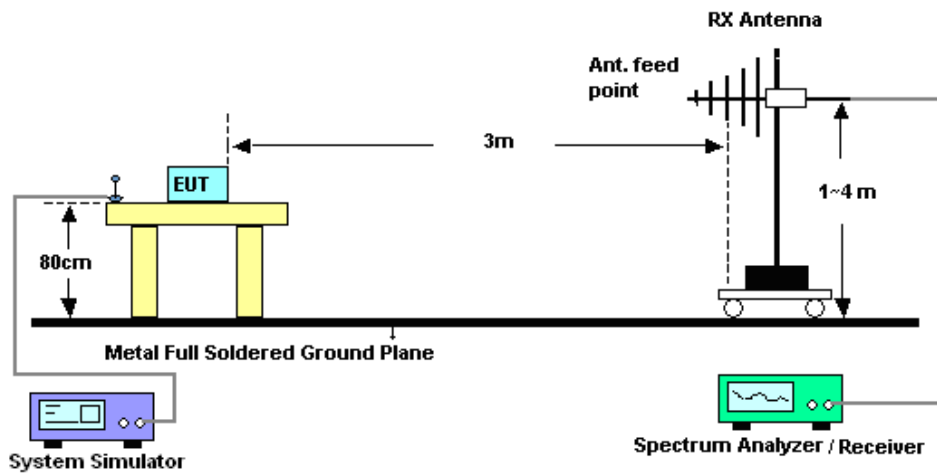

#### 4.2.2 For radiated test above 1GHz

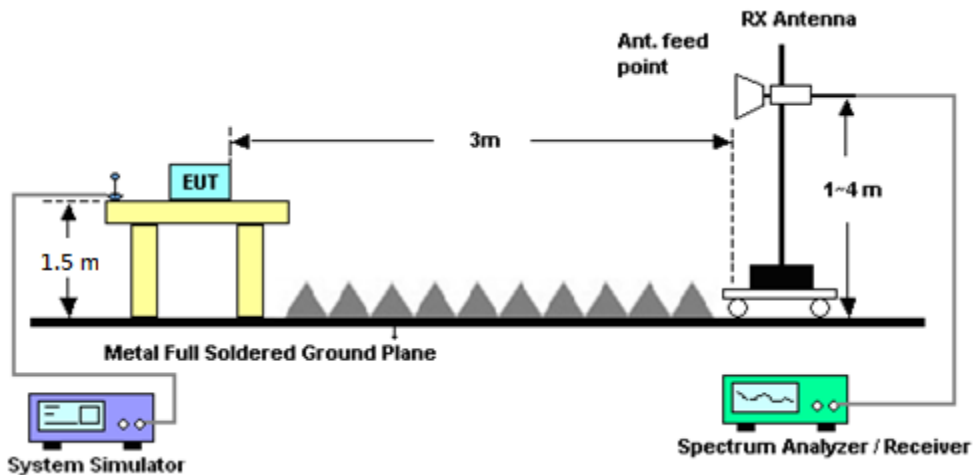

### 4.3 Test Result of Radiated Test

Please refer to Appendix B.



## 4.4 Effective Radiated Power and Effective Isotropic Radiated Power Measurement

### 4.4.1 Description of the ERP/EIRP Measurement

The substitution method, in ANSI / TIA / EIA-603-D-2010, was used for ERP/EIRP measurement, and the spectrum analyzer configuration follows KDB 971168 D01 Power Meas. License Digital Systems v02r02. The ERP of mobile transmitters must not exceed 7 Watts (Cellular Band) and the EIRP of mobile transmitters are limited to 2 Watts (PCS Band).

### 4.4.2 Test Procedures

1. The testing follows FCC KDB 971168 D01 v02r02 Section 5.2.1. (for CDMA/WCDMA), Section 5.2.2.2 (for GSM/GPRS/EDGE) and ANSI / TIA-603-D-2010 Section 2.2.17.
2. The EUT was placed on a non-conductive rotating platform (0.8 meters for frequency below 1GHz and 1.5 meter for frequency above 1GHz) in a semi-anechoic chamber. The radiated emission at the fundamental frequency was measured at 3 m with a test antenna and a spectrum analyzer with RMS detector per section 5. of KDB 971168 D01.
3. During the measurement, the system simulator parameters were set to force the EUT transmitting at maximum output power. The maximum emission was recorded from analyzer power level (LVL) from the 360 degrees rotation of the turntable and the test antenna raised and lowered over a range from 1 to 4 meters in both horizontally and vertically polarized orientations.
4. Effective Isotropic Radiated Power (EIRP) was measured by substitution method according to TIA/EIA-603-D. The EUT was replaced by the substitution antenna at same location, and then a known power from S.G. was applied into the dipole antenna through a Tx cable, and then recorded the maximum Analyzer reading through raised and lowered the test antenna. The correction factor (in dB) = S.G. - Tx Cable loss + Substitution antenna gain - Analyzer reading. Then the EUT's EIRP was calculated with the correction factor,  $EIRP = LVL + \text{Correction factor}$  and  $ERP = EIRP - 2.15$ . Take the record of the output power at substitution antenna.

	GSM/GPRS/EDGE	WCDMA/HSPA
SPAN	500kHz	10MHz
RBW	10kHz	100kHz
VBW	30kHz	300kHz
Detector	RMS	RMS
Trace	Average	Average
Average Type	Power	Power
Sweep Count	100	100



## 4.5 Field Strength of Spurious Radiation Measurement

### 4.5.1 Description of Field Strength of Spurious Radiated Measurement

The power of any emission outside of the authorized operating frequency ranges must be attenuated below the transmitter power (P) by a factor of at least  $43 + 10 \log (P)$  dB. The spectrum is scanned from 30 MHz up to a frequency including its 10th harmonic.

### 4.5.2 Test Procedures

1. The testing follows FCC KDB 971168 D01 v02r02 Section 5.8 and ANSI / TIA-603-D-2010 Section 2.2.12.
2. The EUT was placed on a rotatable wooden table 0.8 meters for frequency below 1GHz and 1.5 meter for frequency above 1GHz above the ground.
3. The EUT was set 3 meters from the receiving antenna, which was mounted on the antenna tower.
4. The table was rotated 360 degrees to determine the position of the highest spurious emission.
5. The height of the receiving antenna is varied between one meter and four meters to search for the maximum spurious emission for both horizontal and vertical polarizations.
6. Make the measurement with the spectrum analyzer's RBW = 1MHz, VBW = 3MHz, taking record of maximum spurious emission.
7. A horn antenna was substituted in place of the EUT and was driven by a signal generator.
8. Tune the output power of signal generator to the same emission level with EUT maximum spurious emission.
9. Taking the record of output power at antenna port.
10. Repeat step 7 to step 8 for another polarization.
11.  $EIRP \text{ (dBm)} = S.G. \text{ Power} - Tx \text{ Cable Loss} + Tx \text{ Antenna Gain}$
12.  $ERP \text{ (dBm)} = EIRP - 2.15$
13. The RF fundamental frequency should be excluded against the limit line in the operating frequency band.
14. The limit line is derived from  $43 + 10\log(P)$  dB below the transmitter power P(Watts)  
 $= P(W) - [43 + 10\log(P)] \text{ (dB)}$   
 $= [30 + 10\log(P)] \text{ (dBm)} - [43 + 10\log(P)] \text{ (dB)}$   
 $= -13\text{dBm}.$



## 5 List of Measuring Equipment

Instrument	Manufacturer	Model No.	Serial No.	Characteristics	Calibration Date	Test Date	Due Date	Remark
Spectrum Analyzer	Rohde & Schwarz	FSP30	101329	9kHz~30GHz	Jun. 24, 2015	Mar. 22, 2016 ~ May 13, 2016	Jun. 23, 2016	Conducted (TH03-HY)
Temperature Chamber	ESPEC	SU-641	92013721	-30℃ ~70℃	Nov. 20, 2015	Mar. 22, 2016 ~ May 13, 2016	Nov. 19, 2016	Conducted (TH03-HY)
Programmable Power Supply	GW Instek	PSS-2005	EL883644	Voltage:0~20V; Current:0~5A	Nov. 26, 2015	Mar. 22, 2016 ~ May 13, 2016	Nov. 25, 2016	Conducted (TH03-HY)
Base Station (Measure)	Rohde & Schwarz	CMU200	117995	GSM / GPRS / WCDMA / CDMA	Jul. 26, 2015	Mar. 22, 2016 ~ May 13, 2016	Jul. 25, 2016	Conducted (TH03-HY)
Bilog Antenna	TESEQ	CBL 6111D	35414	30MHz~1GHz	Nov. 17, 2015	Mar. 25, 2016 ~ Apr. 16, 2016	Nov. 16, 2016	Radiation (03CH11-HY)
Horn Antenna	SCHWARZBECK	BBHA 9120 D	9120D-1326	1GHz ~ 18GHz	Oct. 08, 2015	Mar. 25, 2016 ~ Apr. 16, 2016	Oct. 07, 2016	Radiation (03CH11-HY)
Double Ridge Horn Antenna	ESCO	3117	00075962	1GHz ~ 18GHz	Aug. 21, 2015	Mar. 25, 2016~ Apr. 16, 2016	Aug. 20, 2016	Radiation (03CH11-HY)
Amplifier	SONOMA	310N	187312	9kHz~1GHz	Nov. 20, 2015	Mar. 25, 2016 ~ Apr. 16, 2016	Nov. 19, 2016	Radiation (03CH11-HY)
Preamplifier	MITEQ	AMF-7D-00 101800-30-10P	1902247	1GHz~18GHz	Jul. 01, 2015	Mar. 25, 2016 ~ Apr. 16, 2016	Jun. 30, 2016	Radiation (03CH11-HY)
Preamplifier	Keysight	83017A	MY53270080	1GHz~26.5GHz	Nov. 19, 2015	Mar. 25, 2016~ Apr. 16, 2016	Nov. 18, 2016	Radiation (03CH11-HY)
Spectrum Analyzer	Keysight	N9010A	MY54200486	10Hz ~ 44GHZ	Sep. 24, 2015	Mar. 25, 2016 ~ Apr. 16, 2016	Sep. 23, 2016	Radiation (03CH11-HY)
Antenna Mast	EMEC	AM-BS-450 0-B	N/A	1~4m	N/A	Mar. 25, 2016 ~ Apr. 16, 2016	N/A	Radiation (03CH11-HY)
Turn Table	EMEC	TT 2000	N/A	0-360 degree	N/A	Mar. 25, 2016 ~ Apr. 16, 2016	N/A	Radiation (03CH11-HY)
Preamplifier	MITEQ	JS44-18004 000-33-8P	1840917	18GHz ~ 40GHz	Jun. 02, 2015	Mar. 25, 2016~ Apr. 16, 2016	Jun. 01, 2016	Radiation (03CH11-HY)
SHF-EHF Horn Antenna	SCHWARZBECK	BBHA 9170	BBHA91705 84	18GHz- 40GHz	Nov. 02, 2015	Mar. 25, 2016~ Apr. 16, 2016	Nov. 01, 2016	Radiation (03CH11-HY)
Signal Generator	Rohde & Schwarz	SMF100A	101107	100kHz~40GHz	May 22, 2015	Mar. 25, 2016~ Apr. 16, 2016	May 21, 2016	Radiation (03CH11-HY)



## 6 Uncertainty of Evaluation

### Uncertainty of Radiated Emission Measurement (30 MHz ~ 1000 MHz)

Measuring Uncertainty for a Level of Confidence of 95% ( $U = 2Uc(y)$ )	4.90
---	------



## Appendix A. Test Results of Conducted Test

### Conducted Output Power(Average power)

Conducted Power (*Unit: dBm)						
Band	GSM850			GSM1900		
Channel	128	189	251	512	661	810
Frequency	824.2	836.4	848.8	1850.2	1880.0	1909.8
GPRS class 8	32.11	32.05	31.99	28.98	29.03	28.91
GPRS class 10	29.28	29.19	29.10	26.04	26.07	25.98
GPRS class 11	27.48	27.41	27.31	24.25	24.29	24.18
GPRS class 12	26.40	26.24	26.16	23.05	23.10	22.98
EGPRS class 8	26.27	26.18	26.09	24.84	24.88	24.78
EGPRS class 10	23.38	23.29	23.21	21.96	22.01	21.93
EGPRS class 11	21.54	21.47	21.39	20.16	20.20	20.12
EGPRS class 12	20.37	20.28	20.20	18.98	19.04	18.95

Conducted Power (*Unit: dBm)						
Band	WCDMA Band V			WCDMA Band II		
Channel	4132	4182	4233	9262	9400	9538
Frequency	826.4	836.4	846.6	1852.4	1880	1907.6
RMC 12.2K	23.40	23.30	23.38	20.09	20.01	19.95
HSDPA Subtest-1	23.36	23.26	23.37	19.90	19.45	19.12
HSDPA Subtest-2	22.65	22.51	22.62	19.31	18.90	18.64
HSDPA Subtest-3	22.42	22.29	22.34	19.10	18.70	18.44
HSDPA Subtest-4	22.16	22.03	22.14	18.82	18.38	18.14
HSUPA Subtest-1	21.89	21.75	21.90	18.68	18.22	18.03
HSUPA Subtest-2	20.66	20.51	20.68	17.52	17.05	16.94
HSUPA Subtest-3	21.64	21.50	21.63	18.49	18.15	17.83
HSUPA Subtest-4	20.91	20.80	20.91	17.99	17.69	17.50
HSUPA Subtest-5	22.73	22.58	22.74	19.34	19.00	18.74



# A1. GSM

## Peak-to-Average Ratio

Mode	GSM850		Limit: 13dB
Mod.	GPRS class 8	EDGE class 8	Result
Lowest CH	0.20	3.28	PASS
Middle CH	0.24	3.36	
Highest CH	0.24	3.36	

Mode	GSM1900		Limit: 13dB
Mod.	GPRS class 8	EDGE class 8	Result
Lowest CH	0.24	3.24	PASS
Middle CH	0.20	3.04	
Highest CH	0.24	3.16	



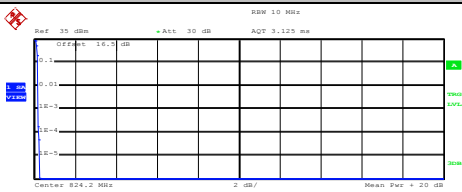
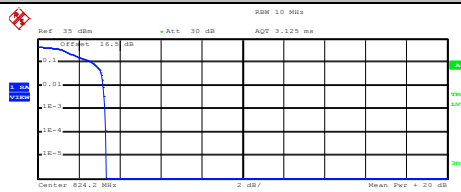
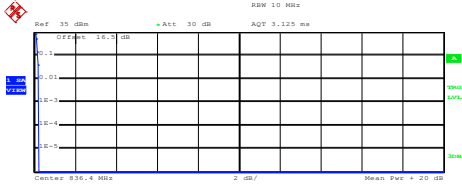
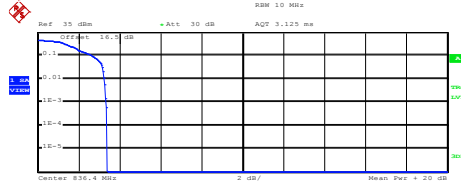
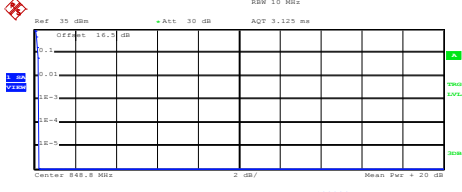
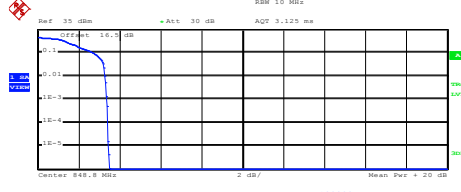

GSM850 (GPRS class 8)	GSM850 (EDGE class 8)																
<p align="center"><b>Lowest Channel</b></p>  <p>Complementary Cumulative Distribution Function (100000 samples) Trace 1 Mean 32.10 dBm Peak 32.36 dBm Crest 0.25 dB</p> <table border="1"> <tr><td>10 %</td><td>0.20 dB</td></tr> <tr><td>1 %</td><td>0.20 dB</td></tr> <tr><td>.1 %</td><td>0.20 dB</td></tr> <tr><td>.01 %</td><td>0.24 dB</td></tr> </table> <p>Date: 22.MAR.2016 10:04:12</p>	10 %	0.20 dB	1 %	0.20 dB	.1 %	0.20 dB	.01 %	0.24 dB	<p align="center"><b>Lowest Channel</b></p>  <p>Complementary Cumulative Distribution Function (100000 samples) Trace 1 Mean 26.36 dBm Peak 29.68 dBm Crest 3.32 dB</p> <table border="1"> <tr><td>10 %</td><td>2.68 dB</td></tr> <tr><td>1 %</td><td>3.20 dB</td></tr> <tr><td>.1 %</td><td>3.28 dB</td></tr> <tr><td>.01 %</td><td>3.32 dB</td></tr> </table> <p>Date: 22.MAR.2016 10:29:29</p>	10 %	2.68 dB	1 %	3.20 dB	.1 %	3.28 dB	.01 %	3.32 dB
10 %	0.20 dB																
1 %	0.20 dB																
.1 %	0.20 dB																
.01 %	0.24 dB																
10 %	2.68 dB																
1 %	3.20 dB																
.1 %	3.28 dB																
.01 %	3.32 dB																
<p align="center"><b>Middle Channel</b></p>  <p>Complementary Cumulative Distribution Function (100000 samples) Trace 1 Mean 31.77 dBm Peak 32.01 dBm Crest 0.24 dB</p> <table border="1"> <tr><td>10 %</td><td>0.16 dB</td></tr> <tr><td>1 %</td><td>0.24 dB</td></tr> <tr><td>.1 %</td><td>0.24 dB</td></tr> <tr><td>.01 %</td><td>0.24 dB</td></tr> </table> <p>Date: 22.MAR.2016 10:04:37</p>	10 %	0.16 dB	1 %	0.24 dB	.1 %	0.24 dB	.01 %	0.24 dB	<p align="center"><b>Middle Channel</b></p>  <p>Complementary Cumulative Distribution Function (100000 samples) Trace 1 Mean 25.94 dBm Peak 29.33 dBm Crest 3.38 dB</p> <table border="1"> <tr><td>10 %</td><td>2.68 dB</td></tr> <tr><td>1 %</td><td>3.24 dB</td></tr> <tr><td>.1 %</td><td>3.36 dB</td></tr> <tr><td>.01 %</td><td>3.40 dB</td></tr> </table> <p>Date: 22.MAR.2016 10:29:46</p>	10 %	2.68 dB	1 %	3.24 dB	.1 %	3.36 dB	.01 %	3.40 dB
10 %	0.16 dB																
1 %	0.24 dB																
.1 %	0.24 dB																
.01 %	0.24 dB																
10 %	2.68 dB																
1 %	3.24 dB																
.1 %	3.36 dB																
.01 %	3.40 dB																
<p align="center"><b>Highest Channel</b></p>  <p>Complementary Cumulative Distribution Function (100000 samples) Trace 1 Mean 31.64 dBm Peak 31.86 dBm Crest 0.22 dB</p> <table border="1"> <tr><td>10 %</td><td>0.20 dB</td></tr> <tr><td>1 %</td><td>0.24 dB</td></tr> <tr><td>.1 %</td><td>0.24 dB</td></tr> <tr><td>.01 %</td><td>0.24 dB</td></tr> </table> <p>Date: 22.MAR.2016 10:04:54</p>	10 %	0.20 dB	1 %	0.24 dB	.1 %	0.24 dB	.01 %	0.24 dB	<p align="center"><b>Highest Channel</b></p>  <p>Complementary Cumulative Distribution Function (100000 samples) Trace 1 Mean 25.77 dBm Peak 29.25 dBm Crest 3.49 dB</p> <table border="1"> <tr><td>10 %</td><td>2.72 dB</td></tr> <tr><td>1 %</td><td>3.28 dB</td></tr> <tr><td>.1 %</td><td>3.36 dB</td></tr> <tr><td>.01 %</td><td>3.44 dB</td></tr> </table> <p>Date: 22.MAR.2016 10:30:10</p>	10 %	2.72 dB	1 %	3.28 dB	.1 %	3.36 dB	.01 %	3.44 dB
10 %	0.20 dB																
1 %	0.24 dB																
.1 %	0.24 dB																
.01 %	0.24 dB																
10 %	2.72 dB																
1 %	3.28 dB																
.1 %	3.36 dB																
.01 %	3.44 dB																



GSM1900 (GPRS class 8)	GSM1900 (EDGE class 8)																												
<p align="center"><b>Lowest Channel</b></p> <p>Center 1.8502 GHz    2 dB/    Mean Pwr + 20 dB</p> <p>Complementary Cumulative Distribution Function (100000 samples) Trace 1</p> <table border="1"> <tr><td>Mean</td><td>28.61 dBm</td></tr> <tr><td>Peak</td><td>28.83 dBm</td></tr> <tr><td>Crest</td><td>0.22 dB</td></tr> </table> <table border="1"> <tr><td>10 %</td><td>0.16 dB</td></tr> <tr><td>1 %</td><td>0.24 dB</td></tr> <tr><td>.1 %</td><td>0.24 dB</td></tr> <tr><td>.01 %</td><td>0.24 dB</td></tr> </table> <p>Date: 22.MAR.2016 10:56:47</p>	Mean	28.61 dBm	Peak	28.83 dBm	Crest	0.22 dB	10 %	0.16 dB	1 %	0.24 dB	.1 %	0.24 dB	.01 %	0.24 dB	<p align="center"><b>Lowest Channel</b></p> <p>Center 1.8502 GHz    2 dB/    Mean Pwr + 20 dB</p> <p>Complementary Cumulative Distribution Function (100000 samples) Trace 1</p> <table border="1"> <tr><td>Mean</td><td>24.48 dBm</td></tr> <tr><td>Peak</td><td>27.77 dBm</td></tr> <tr><td>Crest</td><td>3.30 dB</td></tr> </table> <table border="1"> <tr><td>10 %</td><td>2.76 dB</td></tr> <tr><td>1 %</td><td>3.16 dB</td></tr> <tr><td>.1 %</td><td>3.24 dB</td></tr> <tr><td>.01 %</td><td>3.28 dB</td></tr> </table> <p>Date: 22.MAR.2016 11:24:02</p>	Mean	24.48 dBm	Peak	27.77 dBm	Crest	3.30 dB	10 %	2.76 dB	1 %	3.16 dB	.1 %	3.24 dB	.01 %	3.28 dB
Mean	28.61 dBm																												
Peak	28.83 dBm																												
Crest	0.22 dB																												
10 %	0.16 dB																												
1 %	0.24 dB																												
.1 %	0.24 dB																												
.01 %	0.24 dB																												
Mean	24.48 dBm																												
Peak	27.77 dBm																												
Crest	3.30 dB																												
10 %	2.76 dB																												
1 %	3.16 dB																												
.1 %	3.24 dB																												
.01 %	3.28 dB																												
<p align="center"><b>Middle Channel</b></p> <p>Center 1.88 GHz    2 dB/    Mean Pwr + 20 dB</p> <p>Complementary Cumulative Distribution Function (100000 samples) Trace 1</p> <table border="1"> <tr><td>Mean</td><td>29.09 dBm</td></tr> <tr><td>Peak</td><td>29.33 dBm</td></tr> <tr><td>Crest</td><td>0.24 dB</td></tr> </table> <table border="1"> <tr><td>10 %</td><td>0.16 dB</td></tr> <tr><td>1 %</td><td>0.20 dB</td></tr> <tr><td>.1 %</td><td>0.20 dB</td></tr> <tr><td>.01 %</td><td>0.20 dB</td></tr> </table> <p>Date: 22.MAR.2016 10:57:03</p>	Mean	29.09 dBm	Peak	29.33 dBm	Crest	0.24 dB	10 %	0.16 dB	1 %	0.20 dB	.1 %	0.20 dB	.01 %	0.20 dB	<p align="center"><b>Middle Channel</b></p> <p>Center 1.88 GHz    2 dB/    Mean Pwr + 20 dB</p> <p>Complementary Cumulative Distribution Function (100000 samples) Trace 1</p> <table border="1"> <tr><td>Mean</td><td>25.00 dBm</td></tr> <tr><td>Peak</td><td>28.06 dBm</td></tr> <tr><td>Crest</td><td>3.05 dB</td></tr> </table> <table border="1"> <tr><td>10 %</td><td>2.56 dB</td></tr> <tr><td>1 %</td><td>2.96 dB</td></tr> <tr><td>.1 %</td><td>3.04 dB</td></tr> <tr><td>.01 %</td><td>3.08 dB</td></tr> </table> <p>Date: 22.MAR.2016 11:24:20</p>	Mean	25.00 dBm	Peak	28.06 dBm	Crest	3.05 dB	10 %	2.56 dB	1 %	2.96 dB	.1 %	3.04 dB	.01 %	3.08 dB
Mean	29.09 dBm																												
Peak	29.33 dBm																												
Crest	0.24 dB																												
10 %	0.16 dB																												
1 %	0.20 dB																												
.1 %	0.20 dB																												
.01 %	0.20 dB																												
Mean	25.00 dBm																												
Peak	28.06 dBm																												
Crest	3.05 dB																												
10 %	2.56 dB																												
1 %	2.96 dB																												
.1 %	3.04 dB																												
.01 %	3.08 dB																												
<p align="center"><b>Highest Channel</b></p> <p>Center 1.9098 GHz    2 dB/    Mean Pwr + 20 dB</p> <p>Complementary Cumulative Distribution Function (100000 samples) Trace 1</p> <table border="1"> <tr><td>Mean</td><td>28.81 dBm</td></tr> <tr><td>Peak</td><td>29.04 dBm</td></tr> <tr><td>Crest</td><td>0.23 dB</td></tr> </table> <table border="1"> <tr><td>10 %</td><td>0.16 dB</td></tr> <tr><td>1 %</td><td>0.20 dB</td></tr> <tr><td>.1 %</td><td>0.24 dB</td></tr> <tr><td>.01 %</td><td>0.24 dB</td></tr> </table> <p>Date: 22.MAR.2016 10:57:43</p>	Mean	28.81 dBm	Peak	29.04 dBm	Crest	0.23 dB	10 %	0.16 dB	1 %	0.20 dB	.1 %	0.24 dB	.01 %	0.24 dB	<p align="center"><b>Highest Channel</b></p> <p>Center 1.9098 GHz    2 dB/    Mean Pwr + 20 dB</p> <p>Complementary Cumulative Distribution Function (100000 samples) Trace 1</p> <table border="1"> <tr><td>Mean</td><td>24.64 dBm</td></tr> <tr><td>Peak</td><td>27.84 dBm</td></tr> <tr><td>Crest</td><td>3.20 dB</td></tr> </table> <table border="1"> <tr><td>10 %</td><td>2.64 dB</td></tr> <tr><td>1 %</td><td>3.12 dB</td></tr> <tr><td>.1 %</td><td>3.16 dB</td></tr> <tr><td>.01 %</td><td>3.24 dB</td></tr> </table> <p>Date: 22.MAR.2016 11:24:44</p>	Mean	24.64 dBm	Peak	27.84 dBm	Crest	3.20 dB	10 %	2.64 dB	1 %	3.12 dB	.1 %	3.16 dB	.01 %	3.24 dB
Mean	28.81 dBm																												
Peak	29.04 dBm																												
Crest	0.23 dB																												
10 %	0.16 dB																												
1 %	0.20 dB																												
.1 %	0.24 dB																												
.01 %	0.24 dB																												
Mean	24.64 dBm																												
Peak	27.84 dBm																												
Crest	3.20 dB																												
10 %	2.64 dB																												
1 %	3.12 dB																												
.1 %	3.16 dB																												
.01 %	3.24 dB																												



**26dB Bandwidth**

Mode	GSM850	
Mod.	GPRS class 8	EDGE class 8
Lowest CH	0.310	0.299
Middle CH	0.288	0.298
Highest CH	0.312	0.307

Mode	GSM1900	
Mod.	GPRS class 8	EDGE class 8
Lowest CH	0.312	0.312
Middle CH	0.312	0.308
Highest CH	0.309	0.307

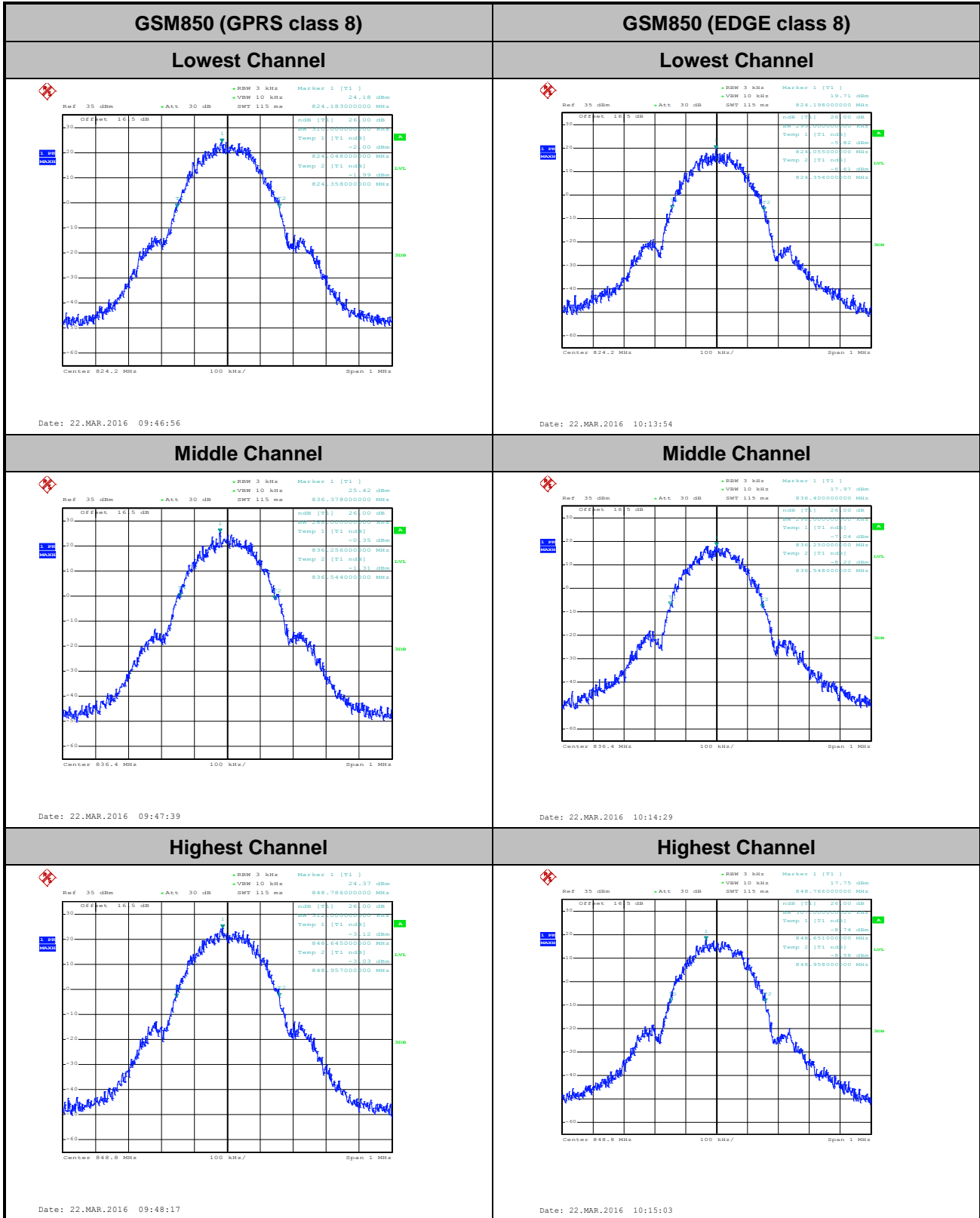

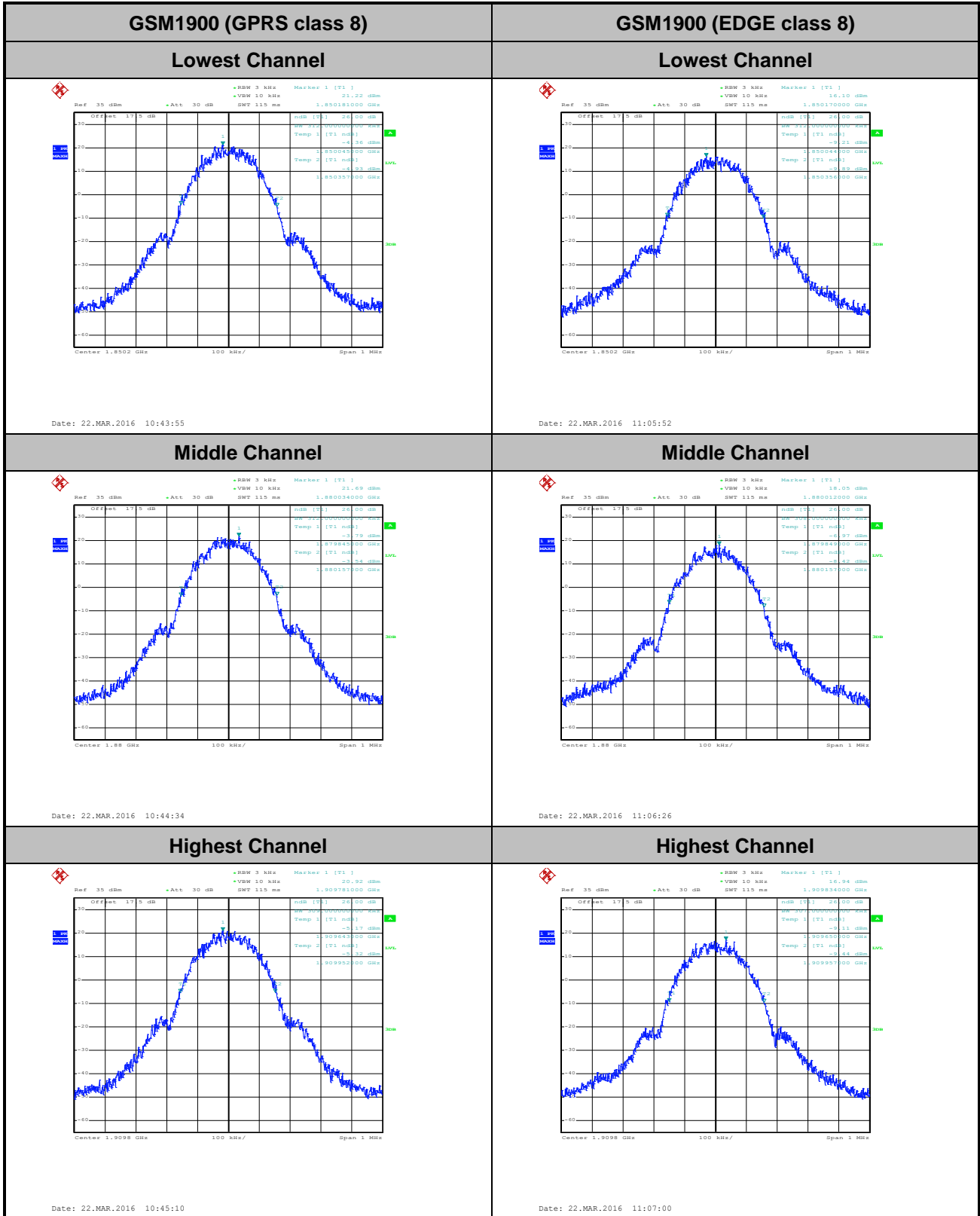



### Occupied Bandwidth

Mode	GSM850	
Mod.	GPRS class 8	EDGE class 8
Lowest CH	0.244	0.246
Middle CH	0.243	0.248
Highest CH	0.245	0.247

Mode	GSM1900	
Mod.	GPRS class 8	EDGE class 8
Lowest CH	0.246	0.249
Middle CH	0.246	0.246
Highest CH	0.244	0.247

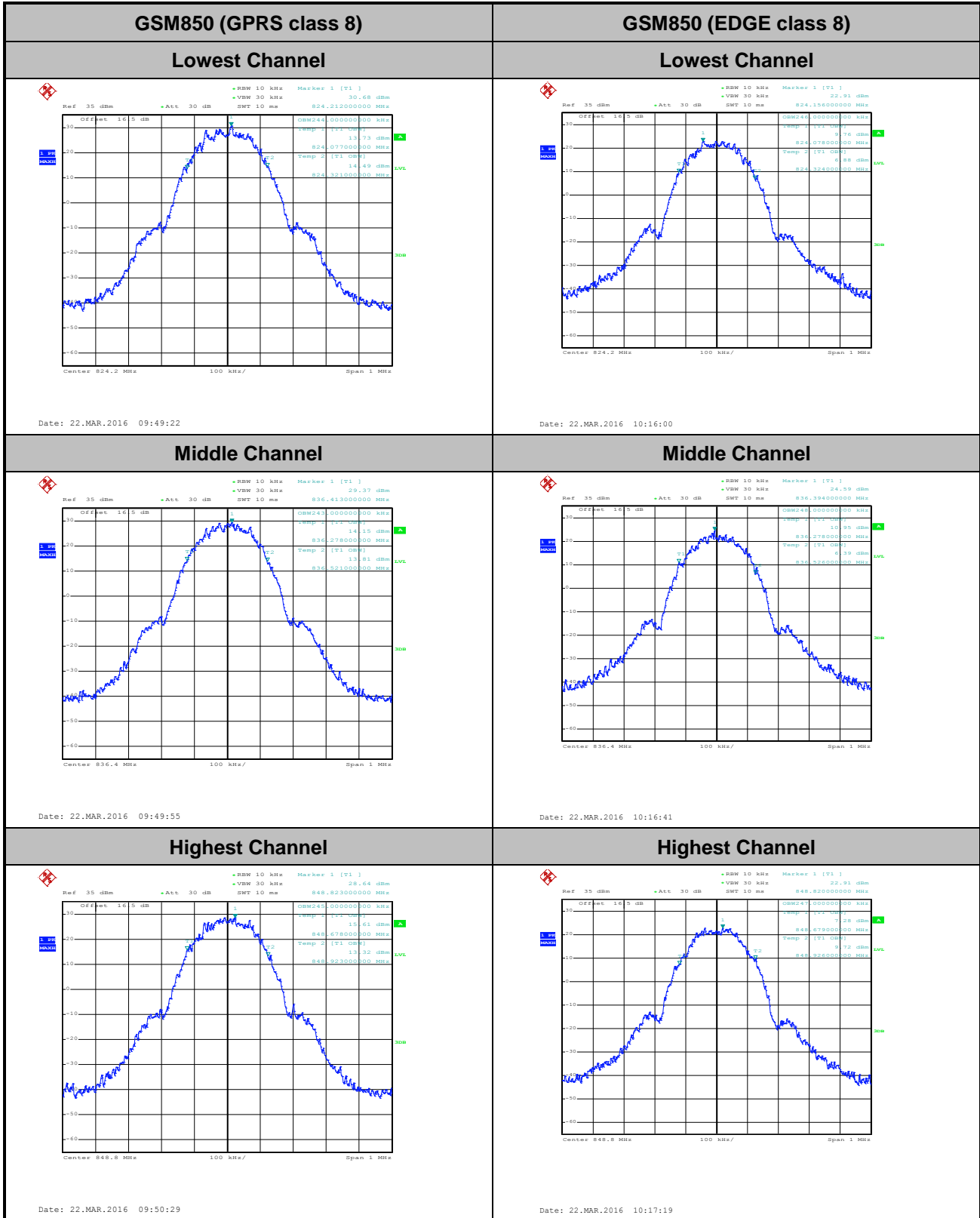

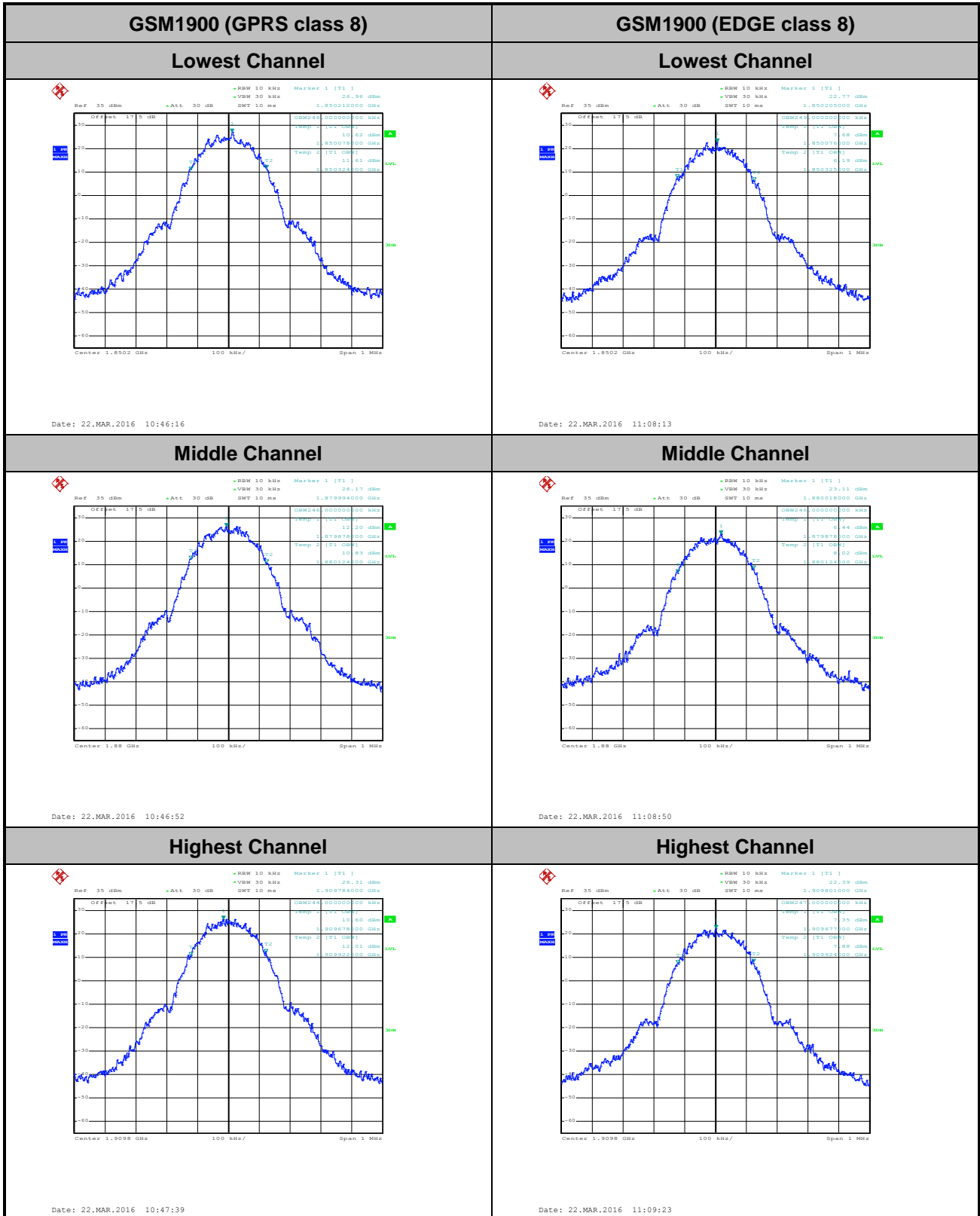





# Conducted Band Edge

## GSM850 (GPRS class 8)

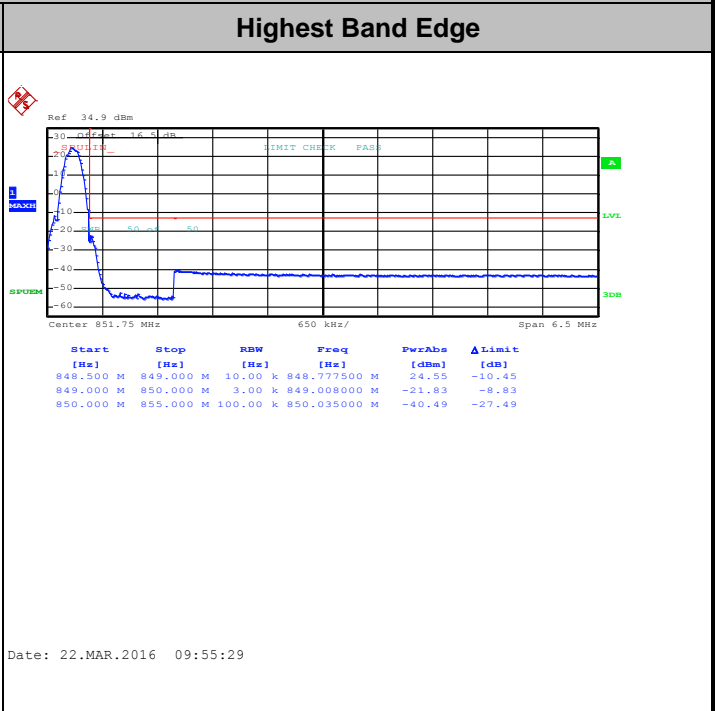
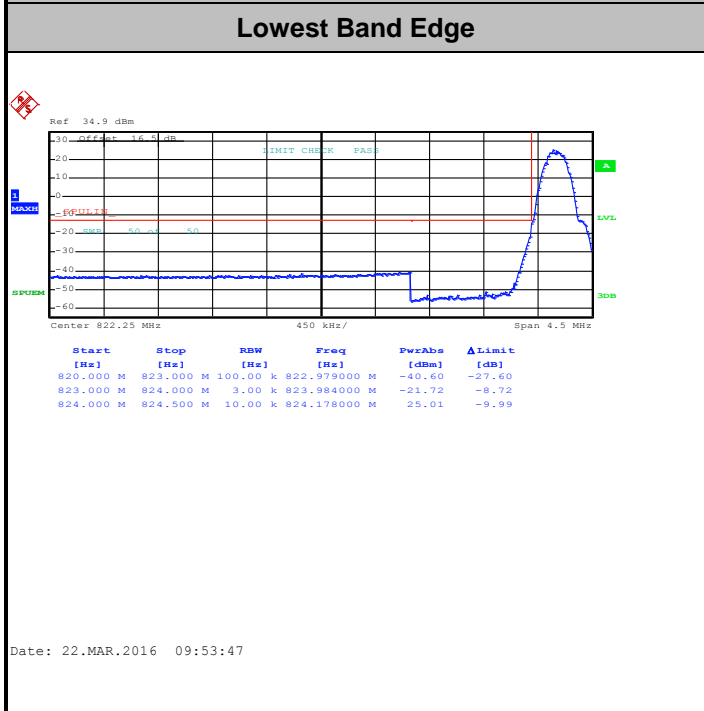

## GSM850 (EDGE class 8)

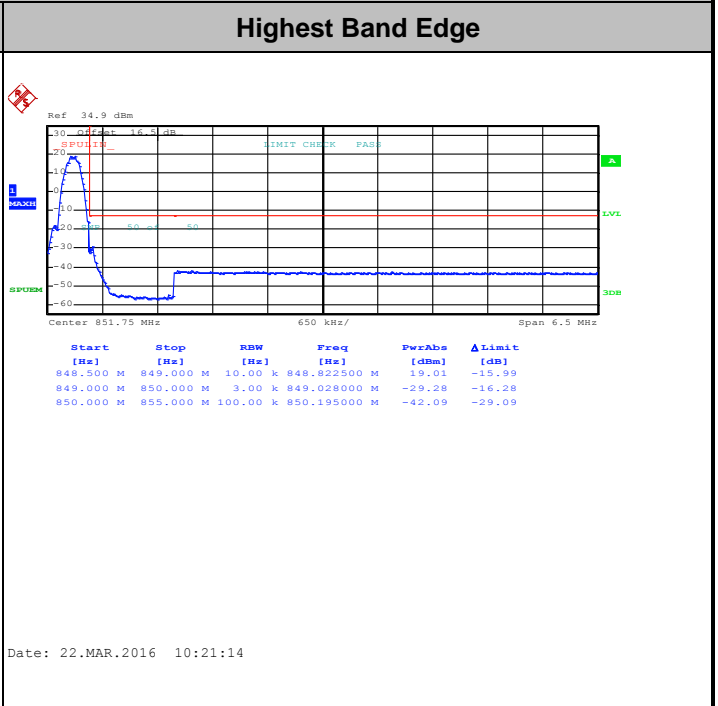
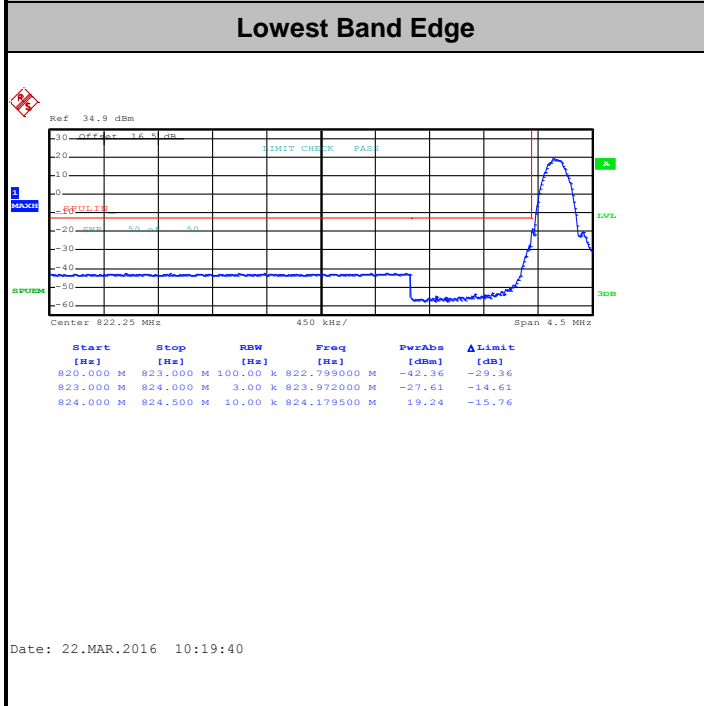



GSM1900 (GPRS class 8)

Lowest Band Edge

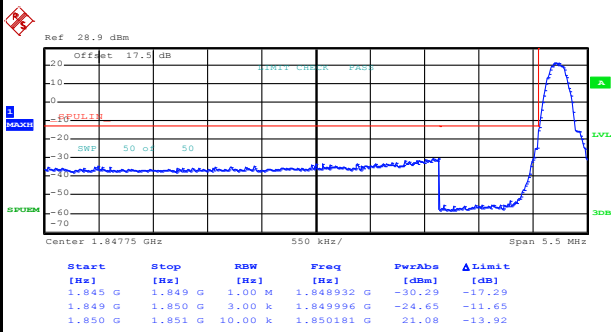

Date: 22.MAR.2016 10:51:33

Highest Band Edge

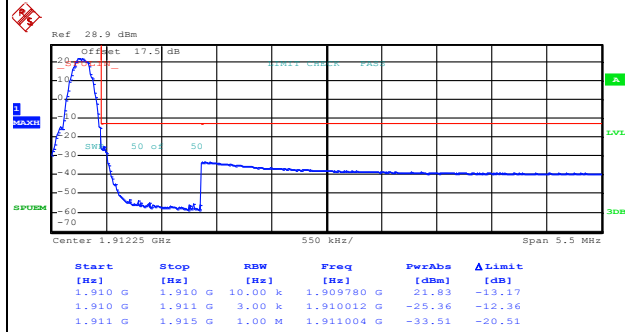

Date: 22.MAR.2016 10:53:10

GSM1900 (EDGE class 8)

Lowest Band Edge

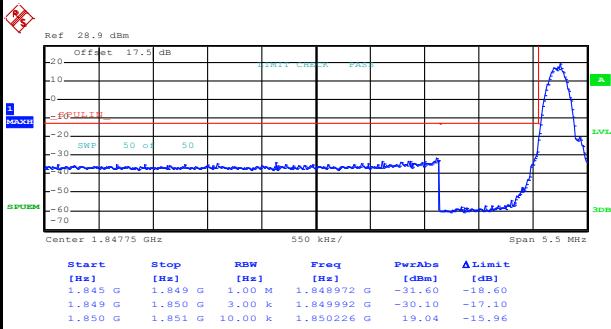

Date: 22.MAR.2016 11:11:11

Highest Band Edge

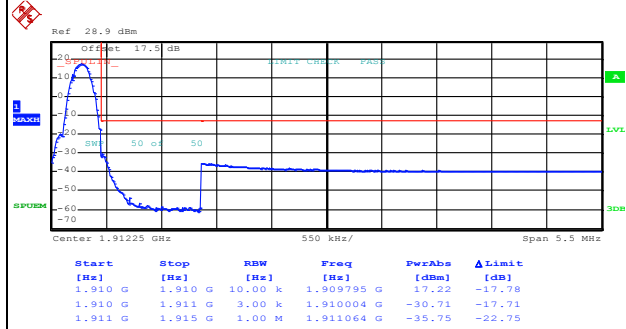

Date: 22.MAR.2016 11:12:47

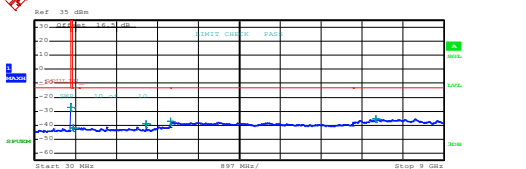
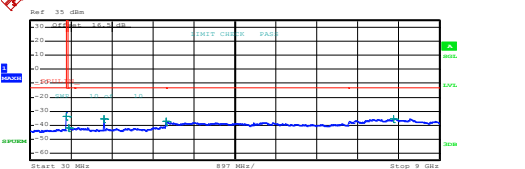
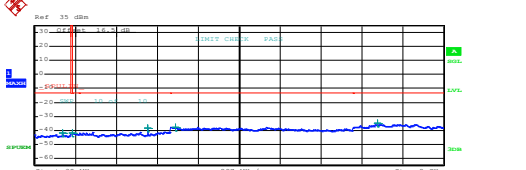
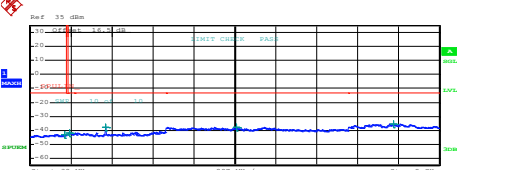
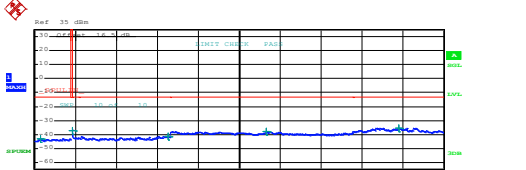
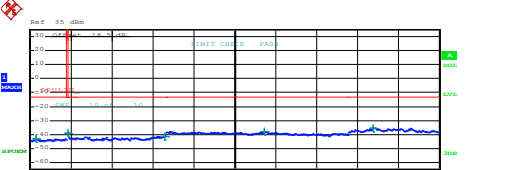

# Conducted Spurious Emission

GSM850 (GPRS class 8)	GSM850 (EDGE class 8)																																																																								
Lowest Channel	Lowest Channel																																																																								
 <table border="1" data-bbox="239 622 702 705"> <thead> <tr> <th>Start [Hz]</th> <th>Stop [Hz]</th> <th>RBW [Hz]</th> <th>Freq [Hz]</th> <th>Power [dBm]</th> <th>Limit [dBm]</th> </tr> </thead> <tbody> <tr> <td>30,000 M</td> <td>820,000 M</td> <td>1,000 M</td> <td>819,802500 M</td> <td>-37.01</td> <td>-14.01</td> </tr> <tr> <td>855,000 M</td> <td>1,000 G</td> <td>1,000 M</td> <td>868,992501 M</td> <td>-41.92</td> <td>-28.92</td> </tr> <tr> <td>1,000 G</td> <td>3,000 G</td> <td>1,000 M</td> <td>2,472500 G</td> <td>-38.97</td> <td>-25.97</td> </tr> <tr> <td>3,000 G</td> <td>7,000 G</td> <td>1,000 M</td> <td>3,009000 G</td> <td>-37.43</td> <td>-24.43</td> </tr> <tr> <td>7,000 G</td> <td>9,000 G</td> <td>1,000 M</td> <td>7,504000 G</td> <td>-35.39</td> <td>-22.39</td> </tr> </tbody> </table> <p>Date: 22.MAR.2016 10:01:31</p>	Start [Hz]	Stop [Hz]	RBW [Hz]	Freq [Hz]	Power [dBm]	Limit [dBm]	30,000 M	820,000 M	1,000 M	819,802500 M	-37.01	-14.01	855,000 M	1,000 G	1,000 M	868,992501 M	-41.92	-28.92	1,000 G	3,000 G	1,000 M	2,472500 G	-38.97	-25.97	3,000 G	7,000 G	1,000 M	3,009000 G	-37.43	-24.43	7,000 G	9,000 G	1,000 M	7,504000 G	-35.39	-22.39	 <table border="1" data-bbox="893 622 1356 705"> <thead> <tr> <th>Start [Hz]</th> <th>Stop [Hz]</th> <th>RBW [Hz]</th> <th>Freq [Hz]</th> <th>Power [dBm]</th> <th>Limit [dBm]</th> </tr> </thead> <tbody> <tr> <td>30,000 M</td> <td>820,000 M</td> <td>1,000 M</td> <td>819,802500 M</td> <td>-37.53</td> <td>-14.53</td> </tr> <tr> <td>855,000 M</td> <td>1,000 G</td> <td>1,000 M</td> <td>869,246251 M</td> <td>-42.04</td> <td>-29.04</td> </tr> <tr> <td>1,000 G</td> <td>3,000 G</td> <td>1,000 M</td> <td>3,048500 G</td> <td>-35.42</td> <td>-22.42</td> </tr> <tr> <td>3,000 G</td> <td>7,000 G</td> <td>1,000 M</td> <td>3,035000 G</td> <td>-37.40</td> <td>-24.40</td> </tr> <tr> <td>7,000 G</td> <td>9,000 G</td> <td>1,000 M</td> <td>8,004000 G</td> <td>-35.24</td> <td>-22.24</td> </tr> </tbody> </table> <p>Date: 22.MAR.2016 10:27:14</p>	Start [Hz]	Stop [Hz]	RBW [Hz]	Freq [Hz]	Power [dBm]	Limit [dBm]	30,000 M	820,000 M	1,000 M	819,802500 M	-37.53	-14.53	855,000 M	1,000 G	1,000 M	869,246251 M	-42.04	-29.04	1,000 G	3,000 G	1,000 M	3,048500 G	-35.42	-22.42	3,000 G	7,000 G	1,000 M	3,035000 G	-37.40	-24.40	7,000 G	9,000 G	1,000 M	8,004000 G	-35.24	-22.24
Start [Hz]	Stop [Hz]	RBW [Hz]	Freq [Hz]	Power [dBm]	Limit [dBm]																																																																				
30,000 M	820,000 M	1,000 M	819,802500 M	-37.01	-14.01																																																																				
855,000 M	1,000 G	1,000 M	868,992501 M	-41.92	-28.92																																																																				
1,000 G	3,000 G	1,000 M	2,472500 G	-38.97	-25.97																																																																				
3,000 G	7,000 G	1,000 M	3,009000 G	-37.43	-24.43																																																																				
7,000 G	9,000 G	1,000 M	7,504000 G	-35.39	-22.39																																																																				
Start [Hz]	Stop [Hz]	RBW [Hz]	Freq [Hz]	Power [dBm]	Limit [dBm]																																																																				
30,000 M	820,000 M	1,000 M	819,802500 M	-37.53	-14.53																																																																				
855,000 M	1,000 G	1,000 M	869,246251 M	-42.04	-29.04																																																																				
1,000 G	3,000 G	1,000 M	3,048500 G	-35.42	-22.42																																																																				
3,000 G	7,000 G	1,000 M	3,035000 G	-37.40	-24.40																																																																				
7,000 G	9,000 G	1,000 M	8,004000 G	-35.24	-22.24																																																																				
Middle Channel	Middle Channel																																																																								
 <table border="1" data-bbox="239 1137 702 1220"> <thead> <tr> <th>Start [Hz]</th> <th>Stop [Hz]</th> <th>RBW [Hz]</th> <th>Freq [Hz]</th> <th>Power [dBm]</th> <th>Limit [dBm]</th> </tr> </thead> <tbody> <tr> <td>30,000 M</td> <td>820,000 M</td> <td>1,000 M</td> <td>647,977500 M</td> <td>-42.28</td> <td>-29.28</td> </tr> <tr> <td>855,000 M</td> <td>1,000 G</td> <td>1,000 M</td> <td>858,190000 M</td> <td>-42.02</td> <td>-29.02</td> </tr> <tr> <td>1,000 G</td> <td>3,000 G</td> <td>1,000 M</td> <td>2,509500 G</td> <td>-38.68</td> <td>-25.68</td> </tr> <tr> <td>3,000 G</td> <td>7,000 G</td> <td>1,000 M</td> <td>3,112000 G</td> <td>-37.90</td> <td>-24.90</td> </tr> <tr> <td>7,000 G</td> <td>9,000 G</td> <td>1,000 M</td> <td>7,943000 G</td> <td>-35.02</td> <td>-22.02</td> </tr> </tbody> </table> <p>Date: 22.MAR.2016 10:02:23</p>	Start [Hz]	Stop [Hz]	RBW [Hz]	Freq [Hz]	Power [dBm]	Limit [dBm]	30,000 M	820,000 M	1,000 M	647,977500 M	-42.28	-29.28	855,000 M	1,000 G	1,000 M	858,190000 M	-42.02	-29.02	1,000 G	3,000 G	1,000 M	2,509500 G	-38.68	-25.68	3,000 G	7,000 G	1,000 M	3,112000 G	-37.90	-24.90	7,000 G	9,000 G	1,000 M	7,943000 G	-35.02	-22.02	 <table border="1" data-bbox="893 1137 1356 1220"> <thead> <tr> <th>Start [Hz]</th> <th>Stop [Hz]</th> <th>RBW [Hz]</th> <th>Freq [Hz]</th> <th>Power [dBm]</th> <th>Limit [dBm]</th> </tr> </thead> <tbody> <tr> <td>30,000 M</td> <td>820,000 M</td> <td>1,000 M</td> <td>720,997500 M</td> <td>-42.84</td> <td>-29.84</td> </tr> <tr> <td>855,000 M</td> <td>1,000 G</td> <td>1,000 M</td> <td>892,808753 M</td> <td>-41.79</td> <td>-28.79</td> </tr> <tr> <td>1,000 G</td> <td>3,000 G</td> <td>1,000 M</td> <td>1,673500 G</td> <td>-37.40</td> <td>-24.40</td> </tr> <tr> <td>3,000 G</td> <td>7,000 G</td> <td>1,000 M</td> <td>4,594000 G</td> <td>-37.55</td> <td>-24.55</td> </tr> <tr> <td>7,000 G</td> <td>9,000 G</td> <td>1,000 M</td> <td>7,986500 G</td> <td>-35.50</td> <td>-22.50</td> </tr> </tbody> </table> <p>Date: 22.MAR.2016 10:28:06</p>	Start [Hz]	Stop [Hz]	RBW [Hz]	Freq [Hz]	Power [dBm]	Limit [dBm]	30,000 M	820,000 M	1,000 M	720,997500 M	-42.84	-29.84	855,000 M	1,000 G	1,000 M	892,808753 M	-41.79	-28.79	1,000 G	3,000 G	1,000 M	1,673500 G	-37.40	-24.40	3,000 G	7,000 G	1,000 M	4,594000 G	-37.55	-24.55	7,000 G	9,000 G	1,000 M	7,986500 G	-35.50	-22.50
Start [Hz]	Stop [Hz]	RBW [Hz]	Freq [Hz]	Power [dBm]	Limit [dBm]																																																																				
30,000 M	820,000 M	1,000 M	647,977500 M	-42.28	-29.28																																																																				
855,000 M	1,000 G	1,000 M	858,190000 M	-42.02	-29.02																																																																				
1,000 G	3,000 G	1,000 M	2,509500 G	-38.68	-25.68																																																																				
3,000 G	7,000 G	1,000 M	3,112000 G	-37.90	-24.90																																																																				
7,000 G	9,000 G	1,000 M	7,943000 G	-35.02	-22.02																																																																				
Start [Hz]	Stop [Hz]	RBW [Hz]	Freq [Hz]	Power [dBm]	Limit [dBm]																																																																				
30,000 M	820,000 M	1,000 M	720,997500 M	-42.84	-29.84																																																																				
855,000 M	1,000 G	1,000 M	892,808753 M	-41.79	-28.79																																																																				
1,000 G	3,000 G	1,000 M	1,673500 G	-37.40	-24.40																																																																				
3,000 G	7,000 G	1,000 M	4,594000 G	-37.55	-24.55																																																																				
7,000 G	9,000 G	1,000 M	7,986500 G	-35.50	-22.50																																																																				
Highest Channel	Highest Channel																																																																								
 <table border="1" data-bbox="239 1653 702 1736"> <thead> <tr> <th>Start [Hz]</th> <th>Stop [Hz]</th> <th>RBW [Hz]</th> <th>Freq [Hz]</th> <th>Power [dBm]</th> <th>Limit [dBm]</th> </tr> </thead> <tbody> <tr> <td>30,000 M</td> <td>820,000 M</td> <td>1,000 M</td> <td>151,007500 M</td> <td>-42.83</td> <td>-29.83</td> </tr> <tr> <td>855,000 M</td> <td>1,000 G</td> <td>1,000 M</td> <td>855,036250 M</td> <td>-36.96</td> <td>-23.96</td> </tr> <tr> <td>1,000 G</td> <td>3,000 G</td> <td>1,000 M</td> <td>2,949500 G</td> <td>-42.08</td> <td>-29.08</td> </tr> <tr> <td>3,000 G</td> <td>7,000 G</td> <td>1,000 M</td> <td>5,114000 G</td> <td>-37.79</td> <td>-24.79</td> </tr> <tr> <td>7,000 G</td> <td>9,000 G</td> <td>1,000 M</td> <td>8,011500 G</td> <td>-35.22</td> <td>-22.22</td> </tr> </tbody> </table> <p>Date: 22.MAR.2016 10:03:16</p>	Start [Hz]	Stop [Hz]	RBW [Hz]	Freq [Hz]	Power [dBm]	Limit [dBm]	30,000 M	820,000 M	1,000 M	151,007500 M	-42.83	-29.83	855,000 M	1,000 G	1,000 M	855,036250 M	-36.96	-23.96	1,000 G	3,000 G	1,000 M	2,949500 G	-42.08	-29.08	3,000 G	7,000 G	1,000 M	5,114000 G	-37.79	-24.79	7,000 G	9,000 G	1,000 M	8,011500 G	-35.22	-22.22	 <table border="1" data-bbox="893 1653 1356 1736"> <thead> <tr> <th>Start [Hz]</th> <th>Stop [Hz]</th> <th>RBW [Hz]</th> <th>Freq [Hz]</th> <th>Power [dBm]</th> <th>Limit [dBm]</th> </tr> </thead> <tbody> <tr> <td>30,000 M</td> <td>820,000 M</td> <td>1,000 M</td> <td>163,115000 M</td> <td>-42.97</td> <td>-29.97</td> </tr> <tr> <td>855,000 M</td> <td>1,000 G</td> <td>1,000 M</td> <td>855,036250 M</td> <td>-39.19</td> <td>-26.19</td> </tr> <tr> <td>1,000 G</td> <td>3,000 G</td> <td>1,000 M</td> <td>2,947000 G</td> <td>-41.38</td> <td>-28.38</td> </tr> <tr> <td>3,000 G</td> <td>7,000 G</td> <td>1,000 M</td> <td>5,118000 G</td> <td>-37.67</td> <td>-24.67</td> </tr> <tr> <td>7,000 G</td> <td>9,000 G</td> <td>1,000 M</td> <td>7,550000 G</td> <td>-35.46</td> <td>-22.46</td> </tr> </tbody> </table> <p>Date: 22.MAR.2016 10:28:58</p>	Start [Hz]	Stop [Hz]	RBW [Hz]	Freq [Hz]	Power [dBm]	Limit [dBm]	30,000 M	820,000 M	1,000 M	163,115000 M	-42.97	-29.97	855,000 M	1,000 G	1,000 M	855,036250 M	-39.19	-26.19	1,000 G	3,000 G	1,000 M	2,947000 G	-41.38	-28.38	3,000 G	7,000 G	1,000 M	5,118000 G	-37.67	-24.67	7,000 G	9,000 G	1,000 M	7,550000 G	-35.46	-22.46
Start [Hz]	Stop [Hz]	RBW [Hz]	Freq [Hz]	Power [dBm]	Limit [dBm]																																																																				
30,000 M	820,000 M	1,000 M	151,007500 M	-42.83	-29.83																																																																				
855,000 M	1,000 G	1,000 M	855,036250 M	-36.96	-23.96																																																																				
1,000 G	3,000 G	1,000 M	2,949500 G	-42.08	-29.08																																																																				
3,000 G	7,000 G	1,000 M	5,114000 G	-37.79	-24.79																																																																				
7,000 G	9,000 G	1,000 M	8,011500 G	-35.22	-22.22																																																																				
Start [Hz]	Stop [Hz]	RBW [Hz]	Freq [Hz]	Power [dBm]	Limit [dBm]																																																																				
30,000 M	820,000 M	1,000 M	163,115000 M	-42.97	-29.97																																																																				
855,000 M	1,000 G	1,000 M	855,036250 M	-39.19	-26.19																																																																				
1,000 G	3,000 G	1,000 M	2,947000 G	-41.38	-28.38																																																																				
3,000 G	7,000 G	1,000 M	5,118000 G	-37.67	-24.67																																																																				
7,000 G	9,000 G	1,000 M	7,550000 G	-35.46	-22.46																																																																				

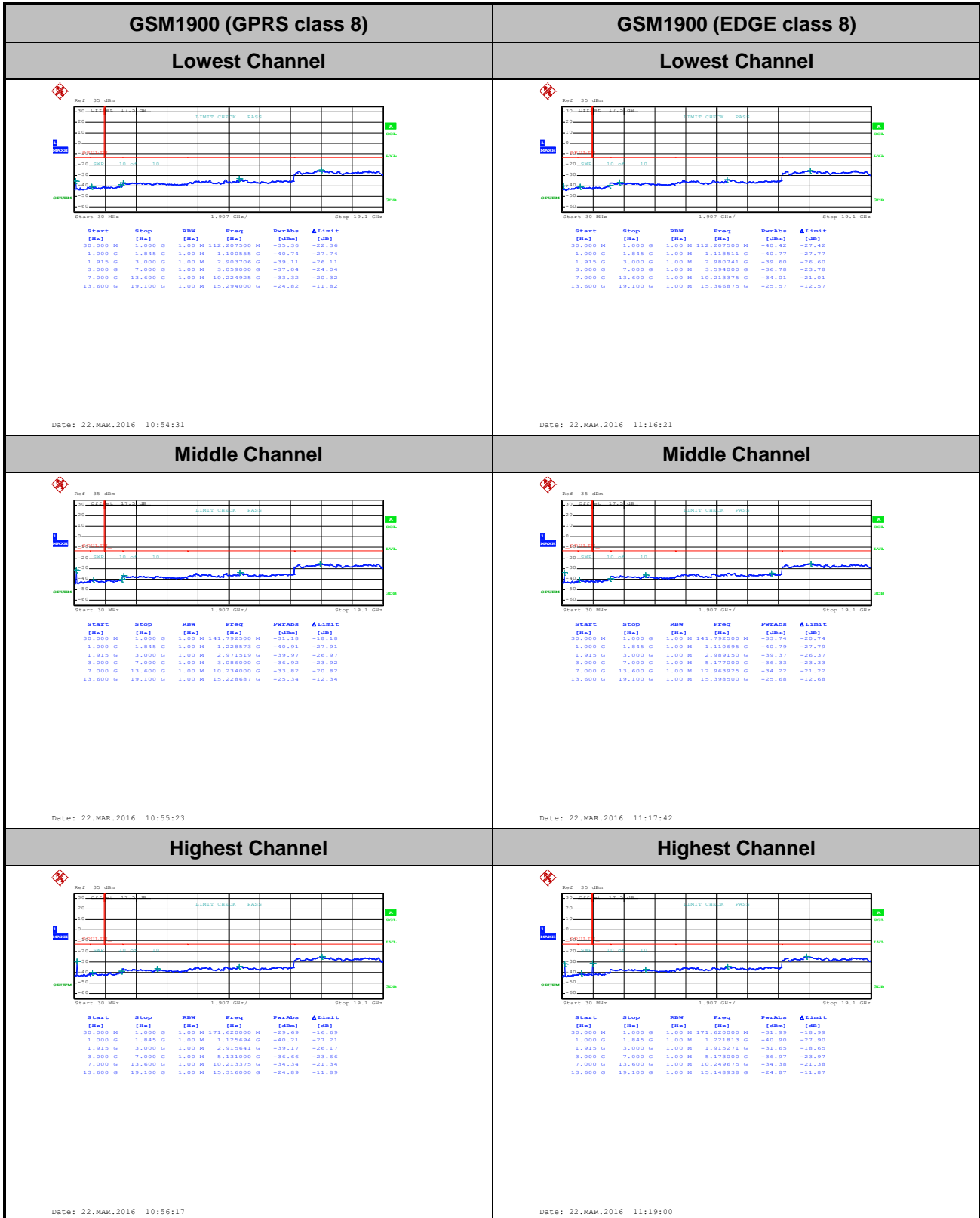



### Frequency Stability

Test Conditions	Middle Channel	GSM850	GSM850	Limit
		(GPRS class 8)	(EDGE class 8)	2.5ppm
Temperature (°C)	Voltage (Volt)	Deviation (ppm)		Result
50	Normal Voltage	0.0036	0.0060	PASS
40	Normal Voltage	0.0048	0.0024	
30	Normal Voltage	0.0012	0.0060	
20(Ref.)	Normal Voltage	0.0000	0.0000	
10	Normal Voltage	0.0024	0.0048	
0	Normal Voltage	0.0012	0.0012	
-10	Normal Voltage	0.0036	0.0024	
-20	Normal Voltage	0.0072	0.0036	
-30	Normal Voltage	0.0024	0.0072	
20	Maximum Voltage	0.0036	0.0012	
20	Normal Voltage	0.0012	0.0048	
20	Battery End Point	0.0024	0.0072	

**Note:**

1. Normal Voltage = 6.0V. ; Battery End Point (BEP) = 4.92 V. ; Maximum Voltage =7.0 V
2. The frequency fundamental emissions stay within the authorized frequency block.



Test Conditions	Middle Channel	GSM1900	GSM1900	Limit
		(GPRS class 8)	(EDGE class 8)	Note 2.
Temperature (°C)	Voltage (Volt)	Deviation (ppm)		Result
50	Normal Voltage	0.0186	0.0021	PASS
40	Normal Voltage	0.0165	0.0016	
30	Normal Voltage	0.0154	0.0005	
20(Ref.)	Normal Voltage	0.0000	0.0000	
10	Normal Voltage	0.0144	0.0037	
0	Normal Voltage	0.0149	0.0011	
-10	Normal Voltage	0.0165	0.0027	
-20	Normal Voltage	0.0176	0.0032	
-30	Normal Voltage	0.0170	0.0043	
20	Maximum Voltage	0.0138	0.0032	
20	Normal Voltage	0.0144	0.0005	
20	Battery End Point	0.0165	0.0043	

**Note:**

- 1. Normal Voltage = 6.0V. ; Battery End Point (BEP) = 4.92 V. ; Maximum Voltage =7.0 V
- 2. The frequency fundamental emissions stay within the authorized frequency block.



## A2. WCDMA

### Peak-to-Average Ratio

Mode	WCDMA Band V	WCDMA Band II	Limit: 13dB
Mod.	RMC 12.2Kbps	RMC 12.2Kbps	Result
Lowest CH	3.56	3.00	<b>PASS</b>
Middle CH	3.56	3.12	
Highest CH	3.56	2.88	

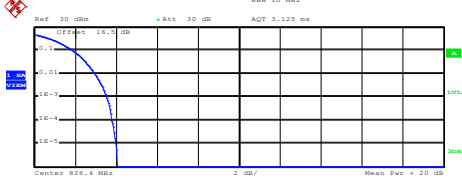
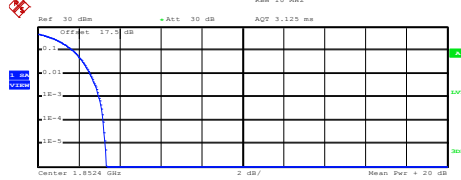
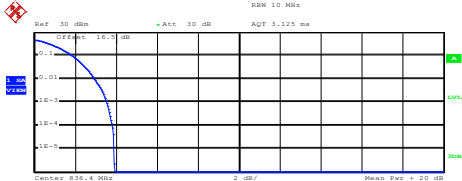
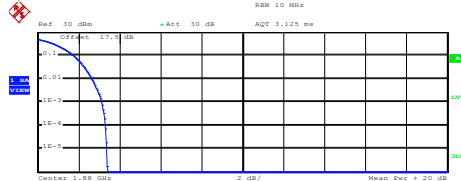
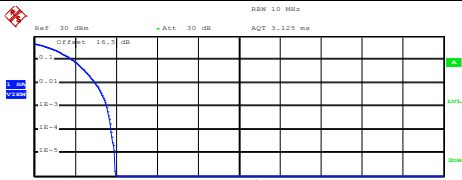
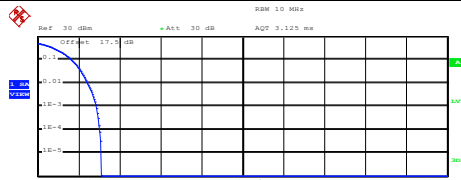

WCDMA Band V (RMC 12.2Kbps)	WCDMA Band II (RMC 12.2Kbps)																
<p align="center"><b>Lowest Channel</b></p>  <p>Center 826.4 MHz    2 dB/    Mean Pwr + 20 dB</p> <p>Complementary Cumulative Distribution Function (100000 samples) Trace 1 Mean 20.11 dBm Peak 24.18 dBm Crest 4.07 dB</p> <table border="1"> <tr><td>10 %</td><td>1.88 dB</td></tr> <tr><td>1 %</td><td>2.96 dB</td></tr> <tr><td>.1 %</td><td>3.56 dB</td></tr> <tr><td>.01 %</td><td>3.80 dB</td></tr> </table> <p>Date: 16.APR.2016 17:21:49</p>	10 %	1.88 dB	1 %	2.96 dB	.1 %	3.56 dB	.01 %	3.80 dB	<p align="center"><b>Lowest Channel</b></p>  <p>Center 1.8524 GHz    2 dB/    Mean Pwr + 20 dB</p> <p>Complementary Cumulative Distribution Function (100000 samples) Trace 1 Mean 19.56 dBm Peak 22.91 dBm Crest 3.35 dB</p> <table border="1"> <tr><td>10 %</td><td>1.72 dB</td></tr> <tr><td>1 %</td><td>2.56 dB</td></tr> <tr><td>.1 %</td><td>3.00 dB</td></tr> <tr><td>.01 %</td><td>3.20 dB</td></tr> </table> <p>Date: 16.APR.2016 16:14:25</p>	10 %	1.72 dB	1 %	2.56 dB	.1 %	3.00 dB	.01 %	3.20 dB
10 %	1.88 dB																
1 %	2.96 dB																
.1 %	3.56 dB																
.01 %	3.80 dB																
10 %	1.72 dB																
1 %	2.56 dB																
.1 %	3.00 dB																
.01 %	3.20 dB																
<p align="center"><b>Middle Channel</b></p>  <p>Center 836.4 MHz    2 dB/    Mean Pwr + 20 dB</p> <p>Complementary Cumulative Distribution Function (100000 samples) Trace 1 Mean 19.78 dBm Peak 23.69 dBm Crest 3.91 dB</p> <table border="1"> <tr><td>10 %</td><td>1.88 dB</td></tr> <tr><td>1 %</td><td>2.96 dB</td></tr> <tr><td>.1 %</td><td>3.56 dB</td></tr> <tr><td>.01 %</td><td>3.84 dB</td></tr> </table> <p>Date: 16.APR.2016 17:21:59</p>	10 %	1.88 dB	1 %	2.96 dB	.1 %	3.56 dB	.01 %	3.84 dB	<p align="center"><b>Middle Channel</b></p>  <p>Center 1.88 GHz    2 dB/    Mean Pwr + 20 dB</p> <p>Complementary Cumulative Distribution Function (100000 samples) Trace 1 Mean 19.52 dBm Peak 22.91 dBm Crest 3.40 dB</p> <table border="1"> <tr><td>10 %</td><td>1.76 dB</td></tr> <tr><td>1 %</td><td>2.64 dB</td></tr> <tr><td>.1 %</td><td>3.12 dB</td></tr> <tr><td>.01 %</td><td>3.32 dB</td></tr> </table> <p>Date: 16.APR.2016 16:14:37</p>	10 %	1.76 dB	1 %	2.64 dB	.1 %	3.12 dB	.01 %	3.32 dB
10 %	1.88 dB																
1 %	2.96 dB																
.1 %	3.56 dB																
.01 %	3.84 dB																
10 %	1.76 dB																
1 %	2.64 dB																
.1 %	3.12 dB																
.01 %	3.32 dB																
<p align="center"><b>Highest Channel</b></p>  <p>Center 846.6 MHz    2 dB/    Mean Pwr + 20 dB</p> <p>Complementary Cumulative Distribution Function (100000 samples) Trace 1 Mean 20.08 dBm Peak 24.04 dBm Crest 3.96 dB</p> <table border="1"> <tr><td>10 %</td><td>1.88 dB</td></tr> <tr><td>1 %</td><td>3.00 dB</td></tr> <tr><td>.1 %</td><td>3.56 dB</td></tr> <tr><td>.01 %</td><td>3.76 dB</td></tr> </table> <p>Date: 16.APR.2016 17:22:09</p>	10 %	1.88 dB	1 %	3.00 dB	.1 %	3.56 dB	.01 %	3.76 dB	<p align="center"><b>Highest Channel</b></p>  <p>Center 1.9076 GHz    2 dB/    Mean Pwr + 20 dB</p> <p>Complementary Cumulative Distribution Function (100000 samples) Trace 1 Mean 19.31 dBm Peak 22.42 dBm Crest 3.11 dB</p> <table border="1"> <tr><td>10 %</td><td>1.64 dB</td></tr> <tr><td>1 %</td><td>2.44 dB</td></tr> <tr><td>.1 %</td><td>2.88 dB</td></tr> <tr><td>.01 %</td><td>3.04 dB</td></tr> </table> <p>Date: 16.APR.2016 16:14:49</p>	10 %	1.64 dB	1 %	2.44 dB	.1 %	2.88 dB	.01 %	3.04 dB
10 %	1.88 dB																
1 %	3.00 dB																
.1 %	3.56 dB																
.01 %	3.76 dB																
10 %	1.64 dB																
1 %	2.44 dB																
.1 %	2.88 dB																
.01 %	3.04 dB																





**26dB Bandwidth**

Mode	WCDMA Band V	WCDMA Band II
Mod.	RMC 12.2Kbps	RMC 12.2Kbps
Lowest CH	4.58	4.63
Middle CH	4.59	4.62
Highest CH	4.58	4.65



WCDMA Band V (RMC 12.2Kbps)

Lowest Channel

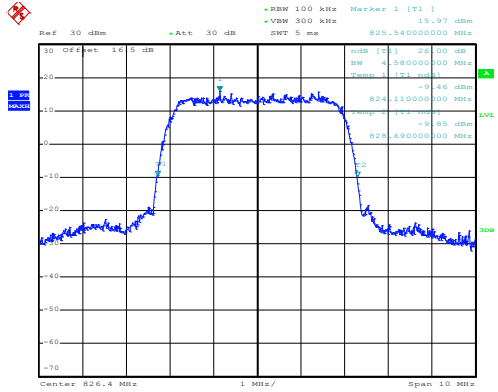

Date: 16.APR.2016 16:32:12

WCDMA Band II (RMC 12.2Kbps)

Lowest Channel

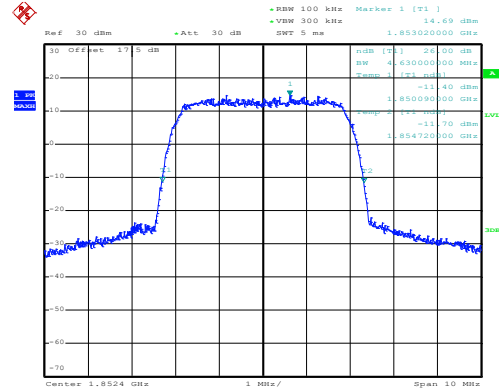

Date: 16.APR.2016 15:52:07

Middle Channel

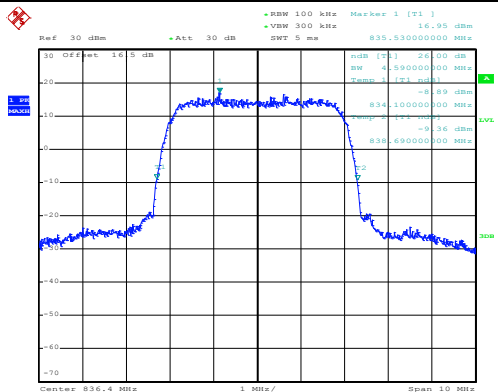

Date: 16.APR.2016 16:32:40

Middle Channel

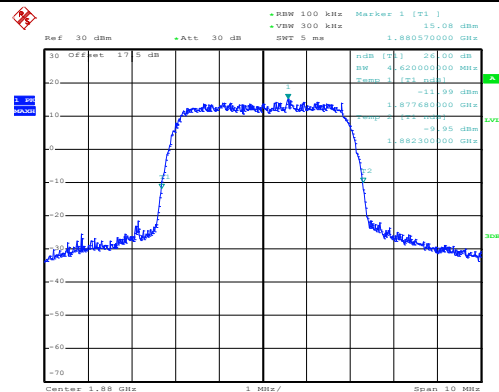

Date: 16.APR.2016 15:52:35

Highest Channel

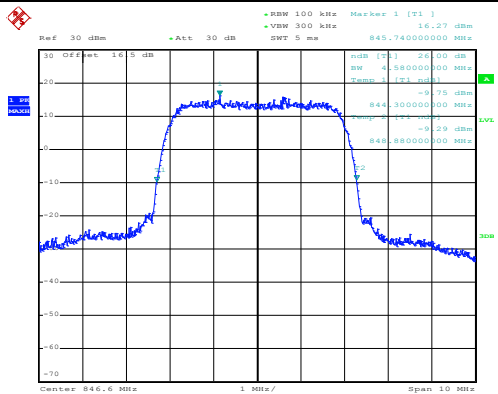

Date: 16.APR.2016 16:33:08

Highest Channel

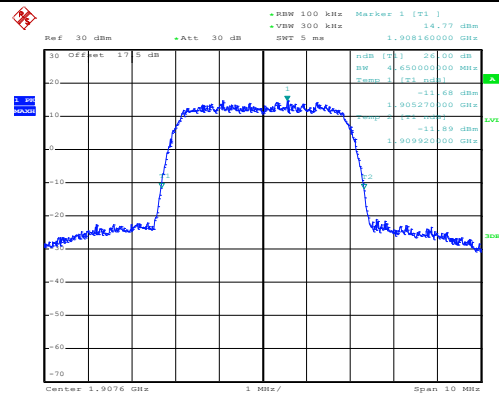

Date: 16.APR.2016 15:53:04



### Occupied Bandwidth

Mode	WCDMA Band V	WCDMA Band II
Mod.	RMC 12.2Kbps	RMC 12.2Kbps
Lowest CH	4.06	4.06
Middle CH	4.06	4.07
Highest CH	4.05	4.07

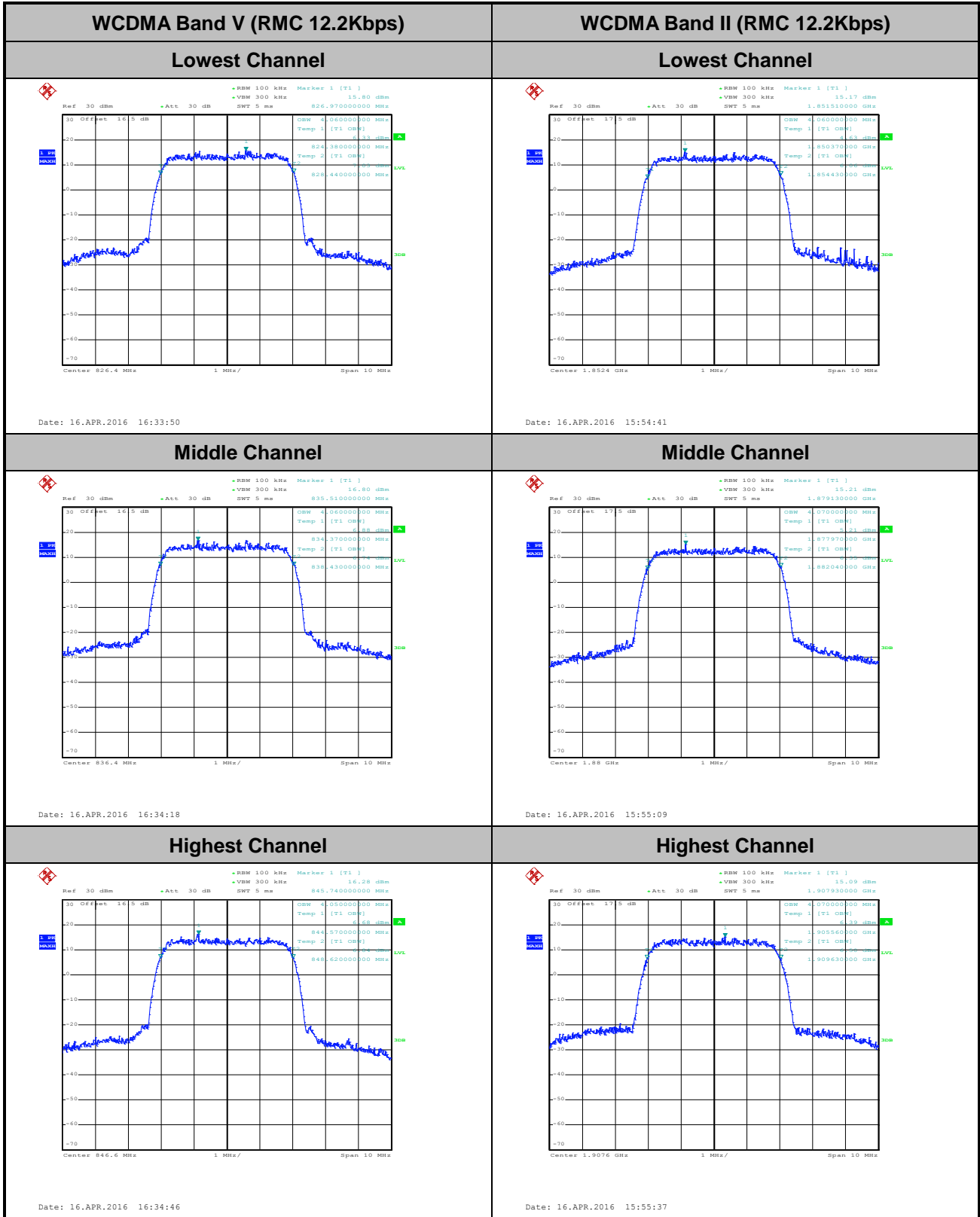



# Conducted Band Edge

## WCDMA Band V (RMC 12.2Kbps)

### Lowest Band Edge

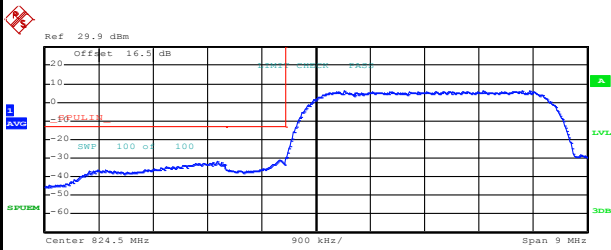

Start [Hz]	Stop [Hz]	RBW [Hz]	Freq [Hz]	PwrAbs [dBm]	ΔLimit [dB]
820.000 M	823.000 M	100.00 k	822.865000 M	-31.14	-18.94
823.000 M	824.000 M	50.00 k	823.884000 M	-31.14	-18.14
824.000 M	829.000 M	100.00 k	827.915000 M	6.30	-28.70

Date: 16.APR.2016 16:37:33

### Highest Band Edge

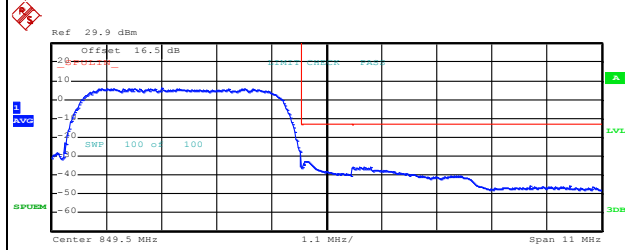

Start [Hz]	Stop [Hz]	RBW [Hz]	Freq [Hz]	PwrAbs [dBm]	ΔLimit [dB]
844.000 M	849.000 M	100.00 k	846.195000 M	6.03	-28.97
849.000 M	850.000 M	50.00 k	849.080000 M	-32.12	-19.72
850.000 M	855.000 M	100.00 k	850.015000 M	-36.01	-23.01

Date: 16.APR.2016 16:40:16

## WCDMA Band II (RMC 12.2Kbps)

### Lowest Band Edge

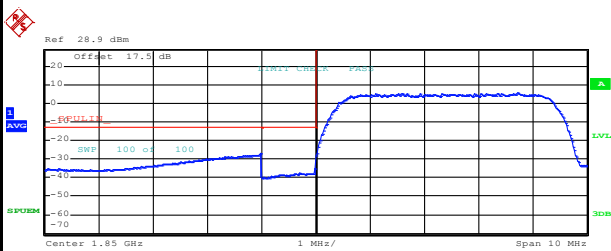

Start [Hz]	Stop [Hz]	RBW [Hz]	Freq [Hz]	PwrAbs [dBm]	ΔLimit [dB]
1.845 G	1.849 G	1.00 M	1.848992 G	-27.10	-14.10
1.849 G	1.850 G	50.00 k	1.849996 G	-35.41	-22.41
1.850 G	1.855 G	100.00 k	1.853720 G	5.60	-29.40

Date: 16.APR.2016 16:18:04

### Highest Band Edge

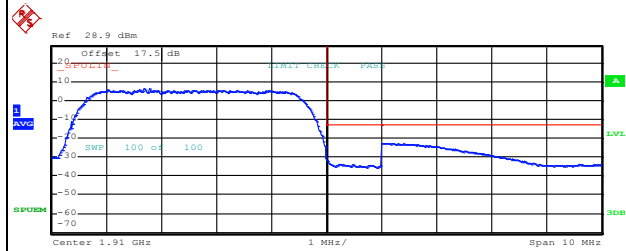

Start [Hz]	Stop [Hz]	RBW [Hz]	Freq [Hz]	PwrAbs [dBm]	ΔLimit [dB]
1.905 G	1.910 G	100.00 k	1.906775 G	6.59	-28.41
1.910 G	1.911 G	50.00 k	1.910008 G	-31.89	-18.89
1.911 G	1.915 G	1.00 M	1.911028 G	-22.59	-9.59

Date: 16.APR.2016 16:20:47

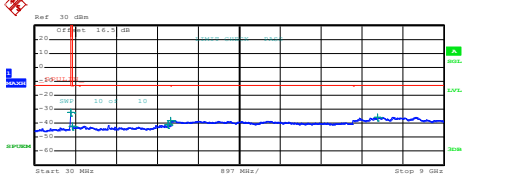
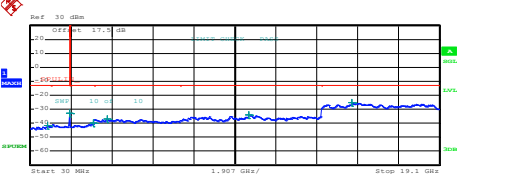
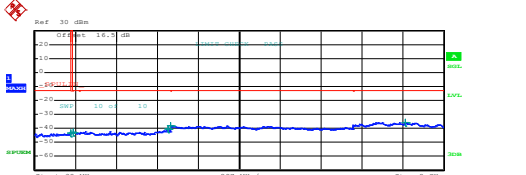
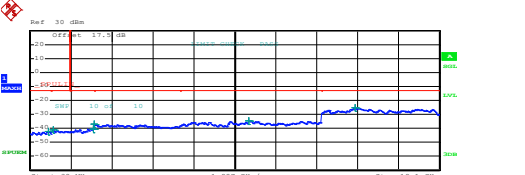
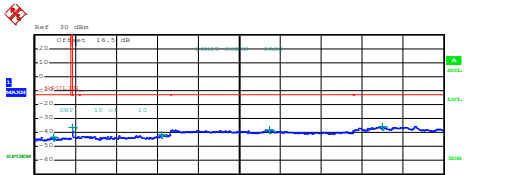
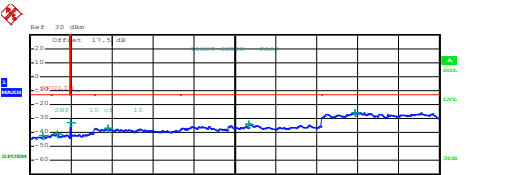

# Conducted Spurious Emission

WCDMA Band V (RMC 12.2Kbps)	WCDMA Band II (RMC 12.2Kbps)																																																																								
Lowest Channel	Lowest Channel																																																																								
 <table border="1" data-bbox="239 622 750 705"> <thead> <tr> <th>Start [Hz]</th> <th>Stop [Hz]</th> <th>RBW [Hz]</th> <th>Freq [Hz]</th> <th>PwrAve [dBm]</th> <th>ΔLimit [dB]</th> </tr> </thead> <tbody> <tr> <td>30,000 M</td> <td>820,000 M</td> <td>1,000 M</td> <td>819,407500 M</td> <td>-32.22</td> <td>-19.22</td> </tr> <tr> <td>855,000 M</td> <td>1,000 G</td> <td>1,000 M</td> <td>859,930000 G</td> <td>-42.30</td> <td>-29.30</td> </tr> <tr> <td>1,000 G</td> <td>3,000 G</td> <td>1,000 M</td> <td>2,962500 G</td> <td>-42.26</td> <td>-28.26</td> </tr> <tr> <td>3,000 G</td> <td>7,000 G</td> <td>1,000 M</td> <td>3,009000 G</td> <td>-37.99</td> <td>-24.99</td> </tr> <tr> <td>7,000 G</td> <td>9,000 G</td> <td>1,000 M</td> <td>7,551000 G</td> <td>-35.72</td> <td>-22.72</td> </tr> </tbody> </table> <p>Date: 16.APR.2016 17:03:04</p>	Start [Hz]	Stop [Hz]	RBW [Hz]	Freq [Hz]	PwrAve [dBm]	ΔLimit [dB]	30,000 M	820,000 M	1,000 M	819,407500 M	-32.22	-19.22	855,000 M	1,000 G	1,000 M	859,930000 G	-42.30	-29.30	1,000 G	3,000 G	1,000 M	2,962500 G	-42.26	-28.26	3,000 G	7,000 G	1,000 M	3,009000 G	-37.99	-24.99	7,000 G	9,000 G	1,000 M	7,551000 G	-35.72	-22.72	 <table border="1" data-bbox="893 622 1404 705"> <thead> <tr> <th>Start [Hz]</th> <th>Stop [Hz]</th> <th>RBW [Hz]</th> <th>Freq [Hz]</th> <th>PwrAve [dBm]</th> <th>ΔLimit [dB]</th> </tr> </thead> <tbody> <tr> <td>30,000 M</td> <td>1,000 G</td> <td>1,000 M</td> <td>832,432100 M</td> <td>-41.36</td> <td>-28.36</td> </tr> <tr> <td>1,000 G</td> <td>3,000 G</td> <td>1,000 M</td> <td>3,044578 G</td> <td>-33.14</td> <td>-20.14</td> </tr> <tr> <td>3,000 G</td> <td>7,000 G</td> <td>1,000 M</td> <td>3,079300 G</td> <td>-39.88</td> <td>-26.88</td> </tr> <tr> <td>7,000 G</td> <td>13,600 G</td> <td>1,000 M</td> <td>10,230700 G</td> <td>-33.98</td> <td>-20.98</td> </tr> <tr> <td>13,600 G</td> <td>19,100 G</td> <td>1,000 M</td> <td>15,003875 G</td> <td>-25.52</td> <td>-12.52</td> </tr> </tbody> </table> <p>Date: 16.APR.2016 15:57:00</p>	Start [Hz]	Stop [Hz]	RBW [Hz]	Freq [Hz]	PwrAve [dBm]	ΔLimit [dB]	30,000 M	1,000 G	1,000 M	832,432100 M	-41.36	-28.36	1,000 G	3,000 G	1,000 M	3,044578 G	-33.14	-20.14	3,000 G	7,000 G	1,000 M	3,079300 G	-39.88	-26.88	7,000 G	13,600 G	1,000 M	10,230700 G	-33.98	-20.98	13,600 G	19,100 G	1,000 M	15,003875 G	-25.52	-12.52
Start [Hz]	Stop [Hz]	RBW [Hz]	Freq [Hz]	PwrAve [dBm]	ΔLimit [dB]																																																																				
30,000 M	820,000 M	1,000 M	819,407500 M	-32.22	-19.22																																																																				
855,000 M	1,000 G	1,000 M	859,930000 G	-42.30	-29.30																																																																				
1,000 G	3,000 G	1,000 M	2,962500 G	-42.26	-28.26																																																																				
3,000 G	7,000 G	1,000 M	3,009000 G	-37.99	-24.99																																																																				
7,000 G	9,000 G	1,000 M	7,551000 G	-35.72	-22.72																																																																				
Start [Hz]	Stop [Hz]	RBW [Hz]	Freq [Hz]	PwrAve [dBm]	ΔLimit [dB]																																																																				
30,000 M	1,000 G	1,000 M	832,432100 M	-41.36	-28.36																																																																				
1,000 G	3,000 G	1,000 M	3,044578 G	-33.14	-20.14																																																																				
3,000 G	7,000 G	1,000 M	3,079300 G	-39.88	-26.88																																																																				
7,000 G	13,600 G	1,000 M	10,230700 G	-33.98	-20.98																																																																				
13,600 G	19,100 G	1,000 M	15,003875 G	-25.52	-12.52																																																																				
Middle Channel	Middle Channel																																																																								
 <table border="1" data-bbox="239 1137 750 1220"> <thead> <tr> <th>Start [Hz]</th> <th>Stop [Hz]</th> <th>RBW [Hz]</th> <th>Freq [Hz]</th> <th>PwrAve [dBm]</th> <th>ΔLimit [dB]</th> </tr> </thead> <tbody> <tr> <td>30,000 M</td> <td>820,000 M</td> <td>1,000 M</td> <td>816,442500 M</td> <td>-43.21</td> <td>-30.21</td> </tr> <tr> <td>855,000 M</td> <td>1,000 G</td> <td>1,000 M</td> <td>869,318751 M</td> <td>-42.32</td> <td>-29.32</td> </tr> <tr> <td>1,000 G</td> <td>3,000 G</td> <td>1,000 M</td> <td>2,947500 G</td> <td>-40.61</td> <td>-27.61</td> </tr> <tr> <td>3,000 G</td> <td>7,000 G</td> <td>1,000 M</td> <td>3,003000 G</td> <td>-38.03</td> <td>-25.03</td> </tr> <tr> <td>7,000 G</td> <td>9,000 G</td> <td>1,000 M</td> <td>8,139500 G</td> <td>-35.67</td> <td>-22.67</td> </tr> </tbody> </table> <p>Date: 16.APR.2016 17:03:51</p>	Start [Hz]	Stop [Hz]	RBW [Hz]	Freq [Hz]	PwrAve [dBm]	ΔLimit [dB]	30,000 M	820,000 M	1,000 M	816,442500 M	-43.21	-30.21	855,000 M	1,000 G	1,000 M	869,318751 M	-42.32	-29.32	1,000 G	3,000 G	1,000 M	2,947500 G	-40.61	-27.61	3,000 G	7,000 G	1,000 M	3,003000 G	-38.03	-25.03	7,000 G	9,000 G	1,000 M	8,139500 G	-35.67	-22.67	 <table border="1" data-bbox="893 1137 1404 1220"> <thead> <tr> <th>Start [Hz]</th> <th>Stop [Hz]</th> <th>RBW [Hz]</th> <th>Freq [Hz]</th> <th>PwrAve [dBm]</th> <th>ΔLimit [dB]</th> </tr> </thead> <tbody> <tr> <td>30,000 M</td> <td>1,000 G</td> <td>1,000 M</td> <td>874,587500 M</td> <td>-42.29</td> <td>-29.29</td> </tr> <tr> <td>1,000 G</td> <td>3,000 G</td> <td>1,000 M</td> <td>3,051894 G</td> <td>-40.87</td> <td>-27.87</td> </tr> <tr> <td>3,000 G</td> <td>7,000 G</td> <td>1,000 M</td> <td>2,981826 G</td> <td>-40.25</td> <td>-27.25</td> </tr> <tr> <td>7,000 G</td> <td>13,600 G</td> <td>1,000 M</td> <td>3,003000 G</td> <td>-36.97</td> <td>-23.97</td> </tr> <tr> <td>13,600 G</td> <td>19,100 G</td> <td>1,000 M</td> <td>15,165675 G</td> <td>-34.38</td> <td>-21.38</td> </tr> </tbody> </table> <p>Date: 16.APR.2016 15:57:46</p>	Start [Hz]	Stop [Hz]	RBW [Hz]	Freq [Hz]	PwrAve [dBm]	ΔLimit [dB]	30,000 M	1,000 G	1,000 M	874,587500 M	-42.29	-29.29	1,000 G	3,000 G	1,000 M	3,051894 G	-40.87	-27.87	3,000 G	7,000 G	1,000 M	2,981826 G	-40.25	-27.25	7,000 G	13,600 G	1,000 M	3,003000 G	-36.97	-23.97	13,600 G	19,100 G	1,000 M	15,165675 G	-34.38	-21.38
Start [Hz]	Stop [Hz]	RBW [Hz]	Freq [Hz]	PwrAve [dBm]	ΔLimit [dB]																																																																				
30,000 M	820,000 M	1,000 M	816,442500 M	-43.21	-30.21																																																																				
855,000 M	1,000 G	1,000 M	869,318751 M	-42.32	-29.32																																																																				
1,000 G	3,000 G	1,000 M	2,947500 G	-40.61	-27.61																																																																				
3,000 G	7,000 G	1,000 M	3,003000 G	-38.03	-25.03																																																																				
7,000 G	9,000 G	1,000 M	8,139500 G	-35.67	-22.67																																																																				
Start [Hz]	Stop [Hz]	RBW [Hz]	Freq [Hz]	PwrAve [dBm]	ΔLimit [dB]																																																																				
30,000 M	1,000 G	1,000 M	874,587500 M	-42.29	-29.29																																																																				
1,000 G	3,000 G	1,000 M	3,051894 G	-40.87	-27.87																																																																				
3,000 G	7,000 G	1,000 M	2,981826 G	-40.25	-27.25																																																																				
7,000 G	13,600 G	1,000 M	3,003000 G	-36.97	-23.97																																																																				
13,600 G	19,100 G	1,000 M	15,165675 G	-34.38	-21.38																																																																				
Highest Channel	Highest Channel																																																																								
 <table border="1" data-bbox="239 1653 750 1736"> <thead> <tr> <th>Start [Hz]</th> <th>Stop [Hz]</th> <th>RBW [Hz]</th> <th>Freq [Hz]</th> <th>PwrAve [dBm]</th> <th>ΔLimit [dB]</th> </tr> </thead> <tbody> <tr> <td>30,000 M</td> <td>820,000 M</td> <td>1,000 M</td> <td>438,212500 M</td> <td>-43.33</td> <td>-30.33</td> </tr> <tr> <td>855,000 M</td> <td>1,000 G</td> <td>1,000 M</td> <td>855,036250 M</td> <td>-36.54</td> <td>-23.54</td> </tr> <tr> <td>1,000 G</td> <td>3,000 G</td> <td>1,000 M</td> <td>2,906000 G</td> <td>-42.64</td> <td>-28.64</td> </tr> <tr> <td>3,000 G</td> <td>7,000 G</td> <td>1,000 M</td> <td>5,180000 G</td> <td>-38.21</td> <td>-25.21</td> </tr> <tr> <td>7,000 G</td> <td>9,000 G</td> <td>1,000 M</td> <td>7,646500 G</td> <td>-35.51</td> <td>-22.51</td> </tr> </tbody> </table> <p>Date: 16.APR.2016 17:04:36</p>	Start [Hz]	Stop [Hz]	RBW [Hz]	Freq [Hz]	PwrAve [dBm]	ΔLimit [dB]	30,000 M	820,000 M	1,000 M	438,212500 M	-43.33	-30.33	855,000 M	1,000 G	1,000 M	855,036250 M	-36.54	-23.54	1,000 G	3,000 G	1,000 M	2,906000 G	-42.64	-28.64	3,000 G	7,000 G	1,000 M	5,180000 G	-38.21	-25.21	7,000 G	9,000 G	1,000 M	7,646500 G	-35.51	-22.51	 <table border="1" data-bbox="893 1653 1404 1736"> <thead> <tr> <th>Start [Hz]</th> <th>Stop [Hz]</th> <th>RBW [Hz]</th> <th>Freq [Hz]</th> <th>PwrAve [dBm]</th> <th>ΔLimit [dB]</th> </tr> </thead> <tbody> <tr> <td>30,000 M</td> <td>1,000 G</td> <td>1,000 M</td> <td>585,325000 M</td> <td>-42.27</td> <td>-29.27</td> </tr> <tr> <td>1,000 G</td> <td>3,000 G</td> <td>1,000 M</td> <td>3,297651 G</td> <td>-41.12</td> <td>-28.12</td> </tr> <tr> <td>3,000 G</td> <td>7,000 G</td> <td>1,000 M</td> <td>3,935000 G</td> <td>-32.85</td> <td>-19.85</td> </tr> <tr> <td>7,000 G</td> <td>13,600 G</td> <td>1,000 M</td> <td>3,653000 G</td> <td>-36.81</td> <td>-23.81</td> </tr> <tr> <td>13,600 G</td> <td>19,100 G</td> <td>1,000 M</td> <td>15,210075 G</td> <td>-34.29</td> <td>-21.29</td> </tr> </tbody> </table> <p>Date: 16.APR.2016 15:58:32</p>	Start [Hz]	Stop [Hz]	RBW [Hz]	Freq [Hz]	PwrAve [dBm]	ΔLimit [dB]	30,000 M	1,000 G	1,000 M	585,325000 M	-42.27	-29.27	1,000 G	3,000 G	1,000 M	3,297651 G	-41.12	-28.12	3,000 G	7,000 G	1,000 M	3,935000 G	-32.85	-19.85	7,000 G	13,600 G	1,000 M	3,653000 G	-36.81	-23.81	13,600 G	19,100 G	1,000 M	15,210075 G	-34.29	-21.29
Start [Hz]	Stop [Hz]	RBW [Hz]	Freq [Hz]	PwrAve [dBm]	ΔLimit [dB]																																																																				
30,000 M	820,000 M	1,000 M	438,212500 M	-43.33	-30.33																																																																				
855,000 M	1,000 G	1,000 M	855,036250 M	-36.54	-23.54																																																																				
1,000 G	3,000 G	1,000 M	2,906000 G	-42.64	-28.64																																																																				
3,000 G	7,000 G	1,000 M	5,180000 G	-38.21	-25.21																																																																				
7,000 G	9,000 G	1,000 M	7,646500 G	-35.51	-22.51																																																																				
Start [Hz]	Stop [Hz]	RBW [Hz]	Freq [Hz]	PwrAve [dBm]	ΔLimit [dB]																																																																				
30,000 M	1,000 G	1,000 M	585,325000 M	-42.27	-29.27																																																																				
1,000 G	3,000 G	1,000 M	3,297651 G	-41.12	-28.12																																																																				
3,000 G	7,000 G	1,000 M	3,935000 G	-32.85	-19.85																																																																				
7,000 G	13,600 G	1,000 M	3,653000 G	-36.81	-23.81																																																																				
13,600 G	19,100 G	1,000 M	15,210075 G	-34.29	-21.29																																																																				



### Frequency Stability

Test Conditions	Middle Channel	WCDMA Band V (RMC 12.2Kbps)	Limit
		Deviation (ppm)	2.5ppm
Temperature (°C)	Voltage (Volt)		Result
50	Normal Voltage	0.0036	PASS
40	Normal Voltage	0.0012	
30	Normal Voltage	0.0012	
20(Ref.)	Normal Voltage	0.0000	
10	Normal Voltage	0.0024	
0	Normal Voltage	0.0012	
-10	Normal Voltage	0.0000	
-20	Normal Voltage	0.0024	
-30	Normal Voltage	0.0012	
20	Maximum Voltage	0.0012	
20	Normal Voltage	0.0167	
20	Battery End Point	0.0024	

**Note:**

- 1. Normal Voltage = 6.0V. ; Battery End Point (BEP) = 4.92 V. ; Maximum Voltage =7.0 V
- 2. The frequency fundamental emissions stay within the authorized frequency block.



Test Conditions	Middle Channel	WCDMA Band II	Limit
		(RMC 12.2Kbps)	Note 2.
Temperature (°C)	Voltage (Volt)	Deviation (ppm)	Result
50	Normal Voltage	0.0027	PASS
40	Normal Voltage	0.0016	
30	Normal Voltage	0.0011	
20(Ref.)	Normal Voltage	0.0000	
10	Normal Voltage	0.0005	
0	Normal Voltage	0.0005	
-10	Normal Voltage	0.0021	
-20	Normal Voltage	0.0027	
-30	Normal Voltage	0.0016	
20	Maximum Voltage	0.0011	
20	Normal Voltage	0.0000	
20	Battery End Point	0.0005	

**Note:**

1. Normal Voltage = 6.0V. ; Battery End Point (BEP) = 4.92 V. ; Maximum Voltage =7.0 V
2. The frequency fundamental emissions stay within the authorized frequency block.





## Appendix B. Test Results of Radiated Test

### ERP/EIRP

Channel	Mode	Horizontal		Vertical	
		ERP(dBm)	ERP(W)	ERP(dBm)	ERP(W)
Lowest	GSM850 GPRS class 8	30.73	1.1832	16.40	0.0436
Middle		30.92	1.2370	17.06	0.0508
Highest		31.10	1.2888	16.90	0.0489
Lowest	GSM850 EDGE class 8	24.96	0.3133	10.88	0.0123
Middle		25.05	0.3202	10.92	0.0124
Highest		25.18	0.3296	11.38	0.0137
Lowest	WCDMA Band V RMC 12.2Kbps	22.68	0.1854	9.09	0.0081
Middle		22.17	0.1649	8.72	0.0074
Highest		22.05	0.1605	8.55	0.0072
Limit	ERP < 7W	Result		PASS	

Channel	Mode	Horizontal		Vertical	
		EIRP(dBm)	EIRP(W)	EIRP(dBm)	EIRP(W)
Lowest	GSM1900 GPRS class 8	30.90	1.2289	28.67	0.7359
Middle		31.45	1.3949	29.29	0.8482
Highest		31.59	1.4420	29.47	0.8851
Lowest	GSM1900 EDGE class 8	27.36	0.5443	24.56	0.2857
Middle		27.56	0.5708	25.20	0.3311
Highest		27.57	0.5715	25.52	0.3563
Lowest	WCDMA Band II RMC 12.2Kbps	25.05	0.3196	22.82	0.1914
Middle		23.93	0.2474	21.92	0.1554
Highest		23.78	0.2389	22.04	0.1599
Limit	EIRP < 2W	Result		PASS	



### Radiated Spurious Emission

GSM850 (GPRS class 8)									
Channel	Frequency ( MHz )	ERP ( dBm )	Limit ( dBm )	Over Limit ( dB )	SPA Reading (dBm)	S.G. Power ( dBm )	TX Cable loss ( dB )	TX Antenna Gain (dBi)	Polarization (H/V)
Lowest	1648	-34.52	-13	-21.52	-15.39	-36.28	0.98	4.89	H
	2472	-30.59	-13	-17.59	-13.66	-32.47	1.28	5.32	H
	3296	-29.64	-13	-16.64	-16.1	-33.05	1.54	7.10	H
	4120	-35.48	-13	-22.48	-25.62	-40.12	1.83	8.62	H
	4944	-39.84	-13	-26.84	-32.77	-44.97	2.30	9.59	H
	5768	-40.34	-13	-27.34	-36.86	-45.22	2.78	9.81	H
	6592	-48.74	-13	-35.74	-46.34	-54.18	2.72	10.31	H
	7416	-46.89	-13	-33.89	-46.28	-53.92	2.46	11.63	H
	8240	-50.22	-13	-37.22	-51.57	-58.04	2.32	12.29	H
	1648	-34.21	-13	-21.21	-15.24	-35.97	0.98	4.89	V
	2472	-29.20	-13	-16.20	-13.47	-31.08	1.28	5.32	V
	3296	-29.21	-13	-16.21	-16.36	-32.62	1.54	7.10	V
	4120	-34.50	-13	-21.50	-24.42	-39.14	1.83	8.62	V
	4944	-41.93	-13	-28.93	-33.26	-47.06	2.30	9.59	V
	5768	-44.87	-13	-31.87	-39.42	-49.75	2.78	9.81	V
	6592	-49.74	-13	-36.74	-47.37	-55.18	2.72	10.31	V
7416	-51.40	-13	-38.40	-50.69	-58.43	2.46	11.63	V	
8240	-53.67	-13	-40.67	-53.85	-61.49	2.32	12.29	V	
Middle	1672	-33.58	-13	-20.58	-14	-35.26	0.99	4.82	H
	2512	-27.14	-13	-14.14	-11.44	-29.11	1.29	5.41	H
	3344	-28.81	-13	-15.81	-15.42	-32.42	1.56	7.31	H
	4184	-37.26	-13	-24.26	-21.82	-41.88	1.87	8.64	H
	5016	-37.71	-13	-24.71	-30.98	-42.91	2.35	9.70	H
	5856	-35.16	-13	-22.16	-31.83	-40.02	2.83	9.84	H
	6688	-40.75	-13	-27.75	-38.41	-46.33	2.69	10.43	H
	7528	-49.04	-13	-36.04	-49.76	-56.29	2.42	11.82	H
	8368	-45.04	-13	-32.04	-47.38	-52.94	2.35	12.39	H
	1672	-33.60	-13	-20.60	-14.62	-35.28	0.99	4.82	V
	2512	-27.17	-13	-14.17	-11.73	-29.14	1.29	5.41	V
	3344	-33.48	-13	-20.48	-20.17	-37.09	1.56	7.31	V
	4184	-32.26	-13	-19.26	-21.75	-36.88	1.87	8.64	V
	5016	-41.99	-13	-28.99	-34.22	-47.19	2.35	9.70	V
	5856	-43.20	-13	-30.20	-38.71	-48.06	2.83	9.84	V
	6688	-46.13	-13	-33.13	-44.39	-51.71	2.69	10.43	V
7528	-46.57	-13	-33.57	-45.37	-53.82	2.42	11.82	V	
8368	-48.53	-13	-35.53	-49.33	-56.43	2.35	12.39	V	



GSM850 (GPRS class 8)									
Channel	Frequency ( MHz )	ERP ( dBm )	Limit ( dBm )	Over Limit ( dB )	SPA Reading (dBm)	S.G. Power ( dBm )	TX Cable loss ( dB )	TX Antenna Gain (dBi)	Polarization (H/V)
Highest	1696	-35.61	-13	-22.61	-15.73	-37.21	1.00	4.75	H
	2544	-28.86	-13	-15.86	-12.45	-30.84	1.30	5.44	H
	3392	-28.86	-13	-15.86	-15.25	-32.66	1.57	7.52	H
	4248	-27.24	-13	-14.24	-17.82	-31.84	1.90	8.65	H
	5096	-36.39	-13	-23.39	-30.8	-41.55	2.39	9.70	H
	5944	-35.22	-13	-22.22	-32.07	-40.07	2.88	9.88	H
	6792	-46.15	-13	-33.15	-45.32	-51.89	2.66	10.55	H
	7640	-39.56	-13	-26.56	-39.42	-46.91	2.38	11.88	H
	8488	-43.97	-13	-30.97	-44.75	-51.94	2.37	12.49	H
	1696	-34.92	-13	-21.92	-15.69	-36.52	1.00	4.75	V
	2544	-28.45	-13	-15.45	-12.65	-30.43	1.30	5.44	V
	3392	-26.58	-13	-13.58	-13.09	-30.38	1.57	7.52	V
	4248	-29.59	-13	-16.59	-19.16	-34.19	1.90	8.65	V
	5096	-38.92	-13	-25.92	-31.63	-44.08	2.39	9.70	V
	5944	-42.07	-13	-29.07	-37.39	-46.92	2.88	9.88	V
	6792	-32.68	-13	-19.68	-30.69	-38.42	2.66	10.55	V
	7640	-40.38	-13	-27.38	-40.48	-47.73	2.38	11.88	V
	8488	-39.09	-13	-26.09	-40.71	-47.06	2.37	12.49	V

Remark: Spurious emissions within 30-1000MHz were found more than 20dB below limit line.



GSM850 (EDGE class 8)									
Channel	Frequency ( MHz )	ERP ( dBm )	Limit ( dBm )	Over Limit ( dB )	SPA Reading (dBm)	S.G. Power ( dBm )	TX Cable loss ( dB )	TX Antenna Gain (dBi)	Polarization (H/V)
Lowest	1648	-37.49	-13	-24.49	-18.38	-39.25	0.98	4.89	H
	2472	-33.20	-13	-20.20	-17.13	-35.08	1.28	5.32	H
	3296	-40.46	-13	-27.46	-27.5	-43.87	1.54	7.10	H
	4120	-44.42	-13	-31.42	-34.27	-49.06	1.83	8.62	H
	4944	-50.05	-13	-37.05	-43.62	-55.18	2.30	9.59	H
	5768	-53.85	-13	-40.85	-49.88	-58.73	2.78	9.81	H
	6592	-58.75	-13	-45.75	-55.89	-64.19	2.72	10.31	H
	7416	-60.08	-13	-47.08	-60.37	-67.11	2.46	11.63	H
	8240	-59.23	-13	-46.23	-60.94	-67.05	2.32	12.29	H
	1648	-36.26	-13	-23.26	-17.45	-38.02	0.98	4.89	V
	2472	-37.28	-13	-24.28	-21.92	-39.16	1.28	5.32	V
	3296	-37.94	-13	-24.94	-24.55	-41.35	1.54	7.10	V
	4120	-41.62	-13	-28.62	-30.98	-46.26	1.83	8.62	V
	4944	-55.18	-13	-42.18	-47.75	-60.31	2.30	9.59	V
	5768	-56.14	-13	-43.14	-51.34	-61.02	2.78	9.81	V
	6592	-59.98	-13	-46.98	-57.29	-65.42	2.72	10.31	V
	7416	-59.78	-13	-46.78	-28.8	-66.81	2.46	11.63	V
	8240	-61.25	-13	-48.25	-62.08	-69.07	2.32	12.29	V
Middle	1672	-37.38	-13	-24.38	-17.84	-39.06	0.99	4.82	H
	2512	-32.98	-13	-19.98	-16.44	-34.95	1.29	5.41	H
	3344	-35.21	-13	-22.21	-21.99	-38.82	1.56	7.31	H
	4184	-43.44	-13	-30.44	-33.8	-48.06	1.87	8.64	H
	5016	-49.94	-13	-36.94	-43.58	-55.14	2.35	9.70	H
	5856	-51.43	-13	-38.43	-48.02	-56.29	2.83	9.84	H
	6688	-53.21	-13	-40.21	-51.47	-58.79	2.69	10.43	H
	7528	-57.19	-13	-44.19	-57.24	-64.44	2.42	11.82	H
	8368	-54.45	-13	-41.45	-56.08	-62.35	2.35	12.39	H
	1672	-36.78	-13	-23.78	-17.49	-38.46	0.99	4.82	V
	2512	-34.32	-13	-21.32	-18.49	-36.29	1.29	5.41	V
	3344	-35.80	-13	-22.80	-22.04	-39.41	1.56	7.31	V
	4184	-41.46	-13	-28.46	-31.44	-46.08	1.87	8.64	V
	5016	-51.02	-13	-38.02	-44.17	-56.22	2.35	9.70	V
	5856	-54.56	-13	-41.56	-49.44	-59.42	2.83	9.84	V
	6688	-56.36	-13	-43.36	-54.37	-61.94	2.69	10.43	V
	7528	-59.81	-13	-46.81	-58.53	-67.06	2.42	11.82	V
	8368	-58.21	-13	-45.21	-59.16	-66.11	2.35	12.39	V



GSM850 (EDGE class 8)									
Channel	Frequency ( MHz )	ERP ( dBm )	Limit ( dBm )	Over Limit ( dB )	SPA Reading (dBm)	S.G. Power ( dBm )	TX Cable loss ( dB )	TX Antenna Gain (dBi)	Polarization (H/V)
Highest	1696	-37.65	-13	-24.65	-18.16	-39.25	1.00	4.75	H
	2544	-33.06	-13	-20.06	-17	-35.04	1.30	5.44	H
	3392	-37.09	-13	-24.09	-24.91	-40.89	1.57	7.52	H
	4248	-41.22	-13	-28.22	-31.93	-45.82	1.90	8.65	H
	5096	-48.88	-13	-35.88	-42.87	-54.04	2.39	9.70	H
	5944	-46.26	-13	-33.26	-42.52	-51.11	2.88	9.88	H
	6792	-52.93	-13	-39.93	-50.6	-58.67	2.66	10.55	H
	7640	-51.69	-13	-38.69	-51.97	-59.04	2.38	11.88	H
	8488	-55.51	-13	-42.51	-57.34	-63.48	2.37	12.49	H
	1696	-36.86	-13	-23.86	-17.3	-38.46	1.00	4.75	V
	2544	-33.98	-13	-20.98	-18.4	-38.11	1.30	5.44	V
	3392	-30.13	-13	-17.13	-17.67	-36.08	1.57	7.52	V
	4248	-40.46	-13	-27.46	-30.29	-47.21	1.90	8.65	V
	5096	-47.37	-13	-34.37	-40.37	-54.68	2.39	9.70	V
	5944	-47.91	-13	-34.91	-43.18	-54.91	2.88	9.88	V
	6792	-53.03	-13	-40.03	-51.22	-60.92	2.66	10.55	V
	7640	-55.99	-13	-42.99	-55.48	-65.49	2.38	11.88	V
	8488	-58.92	-13	-45.92	-59.53	-69.04	2.37	12.49	V

Remark: Spurious emissions within 30-1000MHz were found more than 20dB below limit line.



GSM1900 (GPRS class 8)									
Channel	Frequency ( MHz )	EIRP ( dBm )	Limit ( dBm )	Over Limit ( dB )	SPA Reading (dBm)	S.G. Power ( dBm )	TX Cable loss ( dB )	TX Antenna Gain (dBi)	Polarization (H/V)
Lowest	3700	-37.74	-13	-24.74	-25.95	-44.31	1.67	8.24	H
	5548	-31.00	-13	-18.00	-26.65	-38.07	2.65	9.72	H
	7403	-55.94	-13	-42.94	-54.89	-65.09	2.46	11.61	H
	9251	-51.05	-13	-38.05	-52.78	-61.11	2.54	12.60	H
	11102	-58.66	-13	-45.66	-61.2	-68.43	2.69	12.46	H
	12954	-55.32	-13	-42.32	-63.15	-65.35	2.92	12.94	H
	3700	-44.36	-13	-31.36	-32.97	-50.93	1.67	8.24	V
	5548	-26.12	-13	-13.12	-21.38	-33.19	2.65	9.72	V
	7403	-55.88	-13	-42.88	-54.76	-65.03	2.46	11.61	V
	9251	-44.66	-13	-31.66	-45.22	-54.72	2.54	12.60	V
	11102	-56.29	-13	-43.29	-59.98	-66.06	2.69	12.46	V
12954	-50.41	-13	-37.41	-58.04	-60.44	2.92	12.94	V	
Middle	3763	-42.39	-13	-29.39	-31.07	-49.02	1.69	8.32	H
	5639	-32.44	-13	-19.44	-28.37	-39.49	2.71	9.76	H
	7522	-50.38	-13	-37.38	-50.37	-59.77	2.42	11.81	H
	9398	-47.26	-13	-34.26	-49.51	-57.23	2.57	12.54	H
	11282	-56.34	-13	-43.34	-60.48	-66.04	2.68	12.39	H
	13163	-52.66	-13	-39.66	-60.67	-62.92	2.97	13.23	H
	3763	-43.52	-13	-30.52	-34.43	-50.15	1.69	8.32	V
	5639	-29.04	-13	-16.04	-24.65	-36.09	2.71	9.76	V
	7522	-56.45	-13	-43.45	-56.03	-65.84	2.42	11.81	V
	9398	-50.40	-13	-37.40	-50.94	-60.37	2.57	12.54	V
	11282	-57.65	-13	-44.65	-62	-67.35	2.68	12.39	V
13163	-49.85	-13	-36.85	-57	-60.11	2.97	13.23	V	
Highest	3819	-37.63	-13	-24.63	-26.54	-44.31	1.70	8.38	H
	5730	-40.04	-13	-27.04	-36.84	-47.07	2.76	9.79	H
	7641	-55.21	-13	-42.21	-55.73	-64.71	2.38	11.88	H
	9552	-51.07	-13	-38.07	-53.42	-60.94	2.60	12.47	H
	3819	-39.85	-13	-26.85	-28.62	-46.53	1.70	8.38	V
	5730	-41.98	-13	-28.98	-36.23	-49.01	2.76	9.79	V
	7641	-59.05	-13	-46.05	-59.25	-68.55	2.38	11.88	V
	9552	-52.89	-13	-39.89	-53.19	-62.76	2.60	12.47	V
13372	-52.11	-13	-39.11	-60.22	-62.61	3.02	13.52	V	

Remark: Spurious emissions within 30-1000MHz were found more than 20dB below limit line.



GSM1900 (EDGE class 8)									
Channel	Frequency ( MHz )	EIRP ( dBm )	Limit ( dBm )	Over Limit ( dB )	SPA Reading (dBm)	S.G. Power ( dBm )	TX Cable loss ( dB )	TX Antenna Gain (dBi)	Polarization (H/V)
Lowest	3700	-38.69	-13	-25.69	-26.86	-45.26	1.67	8.24	H
	5548	-30.21	-13	-17.21	-25.81	-37.28	2.65	9.72	H
	7403	-58.19	-13	-45.19	-57.91	-67.34	2.46	11.61	H
	9251	-54.65	-13	-41.65	-56.34	-64.71	2.54	12.60	H
	3700	-44.88	-13	-31.88	-32.93	-51.45	1.67	8.24	V
	5548	-37.10	-13	-24.10	-31.7	-44.17	2.65	9.72	V
	7403	-56.62	-13	-43.62	-55.74	-65.77	2.46	11.61	V
	9251	-53.08	-13	-40.08	-53.79	-63.14	2.54	12.60	V
Middle	3763	-37.68	-13	-24.68	-26.19	-44.31	1.69	8.32	H
	5639	-39.26	-13	-26.26	-35.05	-46.31	2.71	9.76	H
	7522	-58.32	-13	-45.32	-58.28	-67.71	2.42	11.81	H
	9398	-54.66	-13	-41.66	-56.48	-64.63	2.57	12.54	H
	13163	-53.77	-13	-40.77	-61.73	-64.03	2.97	13.23	H
	3763	-41.99	-13	-28.99	-30.38	-48.62	1.69	8.32	V
	5639	-40.21	-13	-27.21	-35.08	-47.26	2.71	9.76	V
	7522	-57.51	-13	-44.51	-56.86	-66.9	2.42	11.81	V
	9398	-52.86	-13	-39.86	-53.54	-62.83	2.57	12.54	V
	11282	-58.73	-13	-45.73	-62.32	-68.43	2.68	12.39	V
13163	-48.84	-13	-35.84	-57.08	-59.1	2.97	13.23	V	
Highest	3819	-36.60	-13	-23.60	-25.35	-43.28	1.70	8.38	H
	5730	-32.59	-13	-19.59	-28.57	-39.62	2.76	9.79	H
	7641	-57.14	-13	-44.14	-57.33	-66.64	2.38	11.88	H
	9552	-51.62	-13	-38.62	-53.49	-61.49	2.60	12.47	H
	3819	-36.93	-13	-23.93	-25.59	-43.61	1.70	8.38	V
	5730	-41.11	-13	-28.11	-36.06	-48.14	2.76	9.79	V
	7641	-59.55	-13	-46.55	-59.19	-69.05	2.38	11.88	V
	9552	-52.33	-13	-39.33	-52.99	-62.2	2.60	12.47	V

Remark: Spurious emissions within 30-1000MHz were found more than 20dB below limit line.



WCDMA Band V(RMC 12.2Kbps)									
Channel	Frequency ( MHz )	ERP ( dBm )	Limit ( dBm )	Over Limit ( dB )	SPA Reading (dBm)	S.G. Power ( dBm )	TX Cable loss ( dB )	TX Antenna Gain (dBi)	Polarization (H/V)
Lowest	1656	-43.58	-13	-30.58	-23.96	-45.31	0.98	4.86	H
	2480	-49.03	-13	-36.03	-32.82	-50.94	1.28	5.34	H
	3304	-59.74	-13	-46.74	-46.12	-63.18	1.54	7.14	H
	4136	-62.80	-13	-49.80	-52.58	-67.44	1.84	8.63	H
	4968	-61.92	-13	-48.92	-54.95	-67.09	2.32	9.64	H
	5776	-63.24	-13	-50.24	-59.26	-68.12	2.78	9.81	H
	1656	-41.55	-13	-28.55	-22.08	-43.28	0.98	4.86	V
	2480	-50.28	-13	-37.28	-34.72	-52.19	1.28	5.34	V
	3304	-60.80	-13	-47.80	-46.82	-64.24	1.54	7.14	V
	4136	-62.67	-13	-49.67	-52.04	-67.31	1.84	8.63	V
	4968	-62.77	-13	-49.77	-54.65	-67.94	2.32	9.64	V
5776	-62.17	-13	-49.17	-58.01	-67.05	2.78	9.81	V	
Middle	1672	-42.60	-13	-29.60	-22.66	-44.28	0.99	4.82	H
	2512	-51.97	-13	-38.97	-35.56	-53.94	1.29	5.41	H
	3344	-63.12	-13	-50.12	-50.72	-66.73	1.56	7.31	H
	4176	-63.29	-13	-50.29	-53.51	-67.91	1.86	8.64	H
	5016	-62.18	-13	-49.18	-56.08	-67.38	2.35	9.70	H
	5864	-62.23	-13	-49.23	-58.69	-67.09	2.83	9.85	H
	1672	-40.65	-13	-27.65	-21.06	-42.33	0.99	4.82	V
	2512	-48.10	-13	-35.10	-32.3	-50.07	1.29	5.41	V
	3344	-57.22	-13	-44.22	-44.73	-60.83	1.56	7.31	V
	4176	-63.63	-13	-50.63	-53.15	-68.25	1.86	8.64	V
	5016	-63.99	-13	-50.99	-55.57	-69.19	2.35	9.70	V
5864	-64.35	-13	-51.35	-60.18	-69.21	2.83	9.85	V	
Highest	1696	-40.23	-13	-27.23	-20.85	-41.83	1.00	4.75	H
	2536	-50.69	-13	-37.69	-34.68	-52.67	1.30	5.43	H
	3384	-55.56	-13	-42.56	-42.6	-59.33	1.57	7.49	H
	4240	-61.65	-13	-48.65	-51.67	-66.25	1.90	8.65	H
	5072	-59.75	-13	-46.75	-53.3	-64.92	2.38	9.70	H
	5936	-62.16	-13	-49.16	-59.36	-67.01	2.88	9.87	H
	1696	-40.93	-13	-27.93	-21.26	-42.53	1.00	4.75	V
	2536	-49.64	-13	-36.64	-33.75	-51.62	1.30	5.43	V
	3384	-57.38	-13	-44.38	-44.26	-61.15	1.57	7.49	V
	4240	-63.74	-13	-50.74	-52.74	-68.34	1.90	8.65	V
	5072	-59.57	-13	-46.57	-52.79	-64.74	2.38	9.70	V
5936	-62.37	-13	-49.37	-57.62	-67.22	2.88	9.87	V	

Remark: Spurious emissions within 30-1000MHz were found more than 20dB below limit line.





WCDMA Band II(RMC 12.2Kbps)									
Channel	Frequency ( MHz )	EIRP ( dBm )	Limit ( dBm )	Over Limit ( dB )	SPA Reading (dBm)	S.G. Power ( dBm )	TX Cable loss ( dB )	TX Antenna Gain (dBi)	Polarization (H/V)
Lowest	3707	-50.60	-13	-37.60	-39.16	-57.18	1.67	8.25	H
	5555	-61.50	-13	-48.50	-57.1	-68.57	2.66	9.72	H
	7417	-61.04	-13	-48.04	-61.45	-70.22	2.46	11.63	H
	3707	-55.95	-13	-42.95	-43.52	-62.53	1.67	8.25	V
	5555	-63.02	-13	-50.02	-58.06	-70.09	2.66	9.72	V
	7417	-62.13	-13	-49.13	-61.41	-71.31	2.46	11.63	V
Middle	3763	-56.78	-13	-43.78	-45.47	-63.41	1.69	8.32	H
	5646	-60.14	-13	-47.14	-56.34	-67.19	2.71	9.76	H
	7526	-61.67	-13	-48.67	-61.66	-71.06	2.42	11.82	H
	3763	-60.96	-13	-47.96	-48.93	-67.59	1.69	8.32	V
	5646	-62.18	-13	-49.18	-57.49	-69.23	2.71	9.76	V
	7526	-62.80	-13	-49.80	-61.45	-72.19	2.42	11.82	V
Highest	3819	-48.58	-13	-35.58	-37.48	-55.26	1.70	8.38	H
	5723	-60.05	-13	-47.05	-56.09	-67.09	2.75	9.79	H
	7638	-61.04	-13	-48.04	-62.08	-70.54	2.38	11.88	H
	3819	-50.53	-13	-37.53	-39.44	-57.21	1.70	8.38	V
	5723	-61.53	-13	-48.53	-56.11	-68.57	2.75	9.79	V
	7638	-62.56	-13	-49.56	-62.32	-72.06	2.38	11.88	V

Remark: Spurious emissions within 30-1000MHz were found more than 20dB below limit line.