



SAR EVALUATION CERTIFICATE OF COMPLIANCE

FCC ID: AY5PS3D

APPLICANT: NEC America Inc.

APPLICANT NAME AND ADDRESS:

NEC America Inc.
6535 N. State Highway 161
Irving, Texas 75039-2402

DATE OF TEST:

July 21-22, 2003

TEST LOCATION:

MET LABORATORIES
914 West Patapsco Ave.
Baltimore, Maryland 21230

EUT: NEC Model PS3D Handset
Date of Receipt: July 21, 2003
Device Category: Part 15 C
RF exposure environment: Uncontrolled
RF exposure category: Portable
Power supply: Powered by Battery and AC/DC adaptor
Antenna: Integrated Antenna
Production/prototype: Identical Prototype
Measured Standards: Oet 65 Supplement C
Modulation: TDMA
Crest Factor: 8
TX Range: 1920.35 – 1929.65 MHz
RX Range: 1920.35 – 1929.65 MHz
Used TX Channels: Low: ch.1 1920.35 MHz Center: ch 10 1924.55MHz High: ch20 1929.65MHz
Maximum RF Power Output: 0.026W Conducted (PEP) and 0.04 W EIRP
Maximum SAR Measurement (averaged over: 1g) **0.019** W/kg Body

This wireless portable device has been tested in accordance with the measurement procedures specified in FCC/OET Bulletin 65 Supplement C (2001) and IEEE Std. 1528-200X (July 2001), and has been shown to be capable of compliance for localized specific absorption rate (SAR) for uncontrolled environment/general population exposure limits specified in ANSI/IEEE Std. C95.1 - 1992.

I attest to the accuracy of this data. All reported measurements were performed by me, or were made under my supervision, and are correct to the best of my knowledge and belief. I assume full responsibility for the completeness of these measurements and vouch for the qualifications of all persons taking them.

I also certify that no party to this application has been denied the FCC benefits pursuant to Section 5.301 of the Anti-Drug Abuse Act of 1988, 21 U.S.C. 862.

Len Knight
EMC Lab Manager





NEC America Inc.

Model PS3D Handset

July 23, 2003

July 23, 2003

NEC America Inc.
6535 N. State Highway 161
Irving Texas 75039 - 2402

Reference: Model PS3D Handset

Dear Ms. Pat Von Praying:

Enclosed is the EMC SAR Evaluation Report for the NEC Model PS3D Handset was tested in accordance with the measurement procedures specified in FCC OET 65 Supplement C:01-01 and shown to be capable to be in compliance for localized specific absorption rate (SAR) for uncontrolled environment/general population exposure limits specified in FCC OET 65 Supplement C:01-01.

Thank you for using the testing services of MET Laboratories. If you have any questions regarding these results or if MET can be of further assistance to you, please feel free to contact me. We appreciate your business and look forward to working with you again soon.

Kindest Regards,
MET LABORATORIES, INC.

Marianne T. Bosley
EMC Administrator

Enclosures:

DOCTEM-23 Jan 02

Certificates and reports shall not be reproduced except in full, without the written permission of MET Laboratories, Inc.

The Nation's First Licensed Nationally Recognized Testing Laboratory

Dosimetric Assessment

Test Report

for the

NEC America Inc. Model PS3D Handset

**Tested and Evaluated
In Accordance With
FCC OET 65 Supplement C:01-01**

MET REPORT: EMC14132-SAR

July 23, 2003

PREPARED FOR:

NEC America Inc.
6535 N. State Highway 161
Irving Texas 75039 - 2402

PREPARED BY:

MET Laboratories, Inc.
914 West Patapsco Avenue
Baltimore, Maryland 21230-3432

Dosimetric Assessment TEST REPORT



for the

**NEC America Inc.
Model PS3D Handset**

**In Accordance With
FCC OET Supplement C: 01-01**

Prepared for

NEC America Inc.
6535 N. State Highway 161
Irving Texas 75039 - 2402

Report Prepared By	Marianne T. Bosley EMC ADMINISTRATOR	
Report Reviewed By	Liming Xu TEST ENGINEER	
Final Review By	EMC LAB MANAGER	

Engineering Statement: The measurements shown in this report were made in accordance with the procedures specified in Supplement C to OET Bulletin 65 of the Federal Communications Commission (FCC) Guidelines [FCC 2001] for uncontrolled exposure. I assume full responsibility for the accuracy and completeness of these measurements, and for the qualifications of all persons taking them. It is further stated that upon the basis of the measurements made, the equipment evaluated is capable of compliance for localized specific absorption rate (SAR) for uncontrolled environment/general population exposure limits specified in ANSI/IEEE Std. C95.1-1992.



Len Knight
EMC LAB MANAGER



Quick Links

- [*Summary of test Report*](#)
- [*EUT Description*](#)
- [*Test Conditions*](#)
- [*Host Laptops Used*](#)
- [*System Validation*](#)
- [*SAR results summary*](#)
- [*SAR Area Scans*](#)
- [*Setup Pictures*](#)
- [*Measurement System*](#)

OBJECTIVE

The objective of the procedure was to perform a dosimetric assessment one of the TDMA UPCS handset. The measurements have been carried out with the dosimetric assessment system "SARA2", and were made according to the Supplement C to OET Bulletin 65 of the Federal Communications Commission (FCC) Guidelines [FCC 2001] for evaluating compliance of mobile and portable devices with FCC limits for human exposure in the general population to radio frequency emissions.

INTRODUCTION

In the United States, the most recent FCC RF exposure criteria is documented in the publication OET 65 Supplement C Edition 01-01 [FCC 2001], which sets limits for human exposure to radio frequency electromagnetic fields in the frequency range 3kHz to 300GHz.

The safety limits used for the environmental evaluation measurements are based on the criteria published by the American National Standards Institute (ANSI) for localized specific absorption rate (SAR) in IEEE/ANSI C95.1-1992 Standard for Safety Levels with Respect to Human Exposure to Radio Frequency Electromagnetic Fields, 3 kHz to 300 GHz. (c) 1992 by the Institute of Electrical and Electronics Engineers, Inc., New York, New York 10017. The measurement procedure described in IEEE/ANSI C95.3-1992 Recommended Practice for the Measurement of Potentially Hazardous Electromagnetic Fields - RF and Microwave is used for guidance in measuring SAR due to the RF radiation exposure from the Equipment Under Test (EUT).

SAR DEFINITION

Specific absorption rate (SAR) is the biological relevant parameter describing the effects of electromagnetic fields in the frequency range of interest. It is a measure of the power absorbed per unit mass and may be spatially averaged over the total mass of an exposed body or its parts.

In mathematical terms Specific Absorption Rate (SAR) is defined as the time derivative (rate) of the incremental energy absorbed by (dissipated in) an incremental mass contained in a volume element of a given density. It is also defined as the rate of RF energy absorption per unit mass at a point in an absorbing body as given below. The SAR is calculated from the r.m.s. electric field strength E inside the human body, the conductivity F and the mass density D of the biological tissue:

$$SAR = \frac{|E|^2 \sigma}{\rho}$$

SAR is expressed in units of Watts per Kilogram (W/kg)

F = Conductivity of the tissue-simulant material (S/m)

D = Mass density of the tissue-simulant material (kg/m³)

E = Total RMS electric field strength (V/m)

NOTE: The primary factors that control rate of energy absorption were found to be the wavelength of the incident field in relations to the dimensions and geometry of the irradiated organism, the orientation of the organism in relation to the polarity of field vectors, the presence of reflecting surfaces, and whether conductive contact is made by the organism with a ground plane.

SUMMARY FOR SAR TEST REPORT

EUT	Model PS3D Handset
FCC ID	AY5PS3D
Date of receipt	July 21, 2003
Date of Test	July 21 - 22, 2003
RF Exposure Category	Uncontrolled
Measured Standard	OET 65 Supplement C
Measurement done by	Liming Xu

Maximum Results Found during SAR Evaluation

The equipment is deemed to fulfill the requirements if the measured values are less than or equal to the limit.

Head Configuration

Phantom Configuration	Test Position	Channel	Power (dBm)	Frequency (MHz)	Max. 1g SAR (W/kg)
SAM	LE and RE	Middle	14.2	1924.55	0

Table 1: The Max SAR value for Head Testing (The power mentioned above is the Conducted)

Body Worn Configuration

Test Configurations	Power (dBm)	Channel	Frequency (MHz)	Max. 1g SAR (W/kg)
Body	14.2	Middle	1924.55	0.019

Table 2: The Max SAR value for Body Testing (The power mentioned above is the Conducted)

DESCRIPTION OF TESTED DEVICE

FCC ID	AY5PS3D
Modes of Operation	TDMA
Modulation Mode(s)	TDMA
Duty Cycle(s) (=1/ Crest Factor)	1/8
Transmitter Frequency Range	1920.35 – 1929.65 MHz

Picture of EUT



Picture of accessories

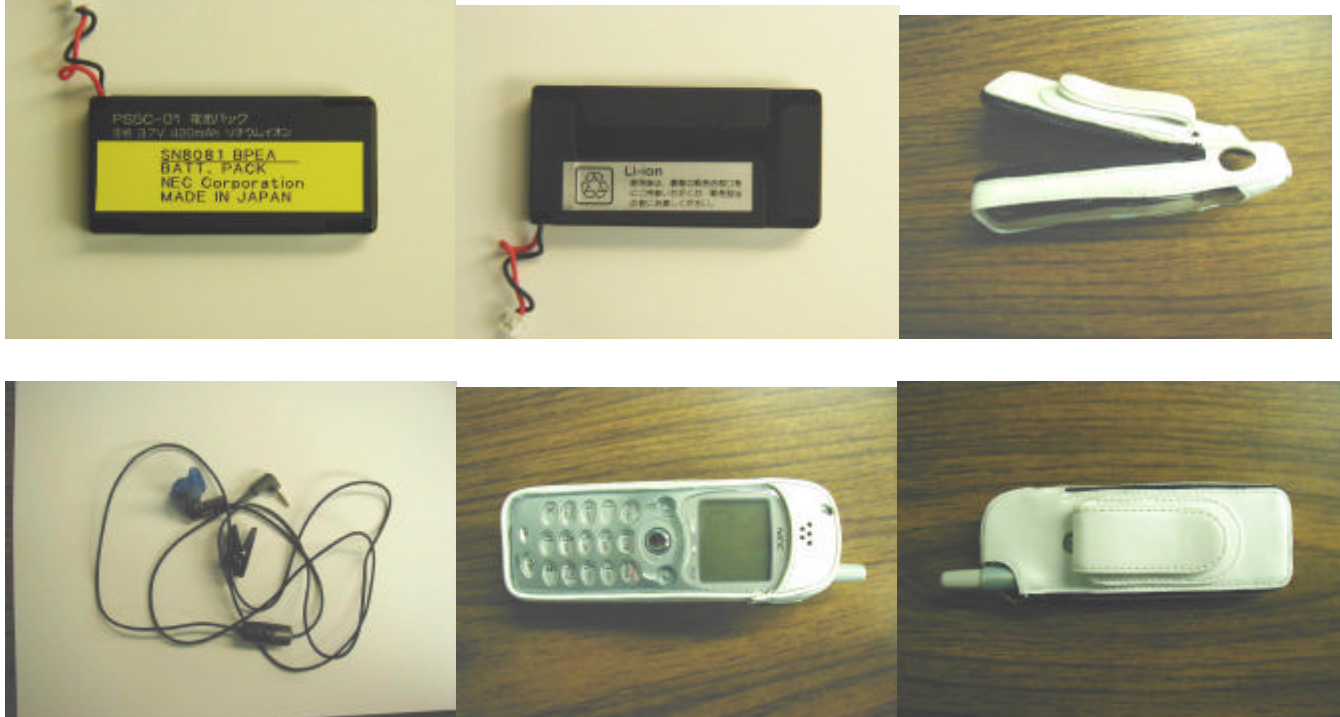

Description of the Antenna

Retractable Antenna.

Battery or AC/DC adaptor

TEST CONDITIONS

Environment

Test Environment	Dedicated test area
Ambient temperature	24.4°C ± 1 °C
Tissue simulating liquid temperature	24.2°C ± 1 °C
Shielded Chamber	Anechoic material strategically positioned to minimize room reflections
Ambient Noise	Very low

Table 3: Summary of Test Environment conditions

Test Signal, Frequencies and Output Power

1. The measurements are first performed at the middle channel of the operating band of the EUT. If the SAR value of the middle channel for each test configuration (Left, Right, Cheek, Tilt, Extended, Retracted) is at least 3 dB below the SAR limit, testing at the high and low channels is optional for such test configurations.
2. The EUT was set to maximum power level during all the tests. Power output was measured before and after each test.
3. T The EUT was equipped with a special software, which allowed the EUT transmitting Maximum RF power with selectable channel

TEST DETAILS

Tissue Recipes

The following recipes are provided in percentage by weight.

1900 MHz, Head: **54.00% De-Ionized Water**
 0.37% Salt
 45.63% DGBE

1900 MHz, Body: **70% De-Ionized Water**
 0.3% Salt
 29.7% DGBE

Material Parameters

Simulant	Freq [MHz]	Room Temp [C]	Liquid Temp [C]	Parameters	Target Value	Measured Value	Deviation [%]	Limit [%]
Head	1900	24.8	24.4	ϵ_r	40.0	39.9	-0.25	$\pm 5\%$
				σ	1.40	1.40	0	$\pm 5\%$
Body	1900	24.8	24.4	ϵ_r	53.3	52.5	-1.5	$\pm 5\%$
				σ	1.52	1.52	0	$\pm 5\%$

Table 5: Parameters of the tissue simulating liquid,.

NOTES:

- Parameters were measured before and after testing. These values reflect both measurements.

System Validation

Following equipment is used for the system validation:

Signal Generator (Agilent E4432B)
 RF Amplifier (Mini Circuits ZHL-42.)
 Dual Directional Coupler (HP 778D)
 The HP 8564E Spectrum Analyzer (used for RF power measurement)
 Cables, Attenuate and Adapters

The recommended (IEEE Std 1528) set-up was used:

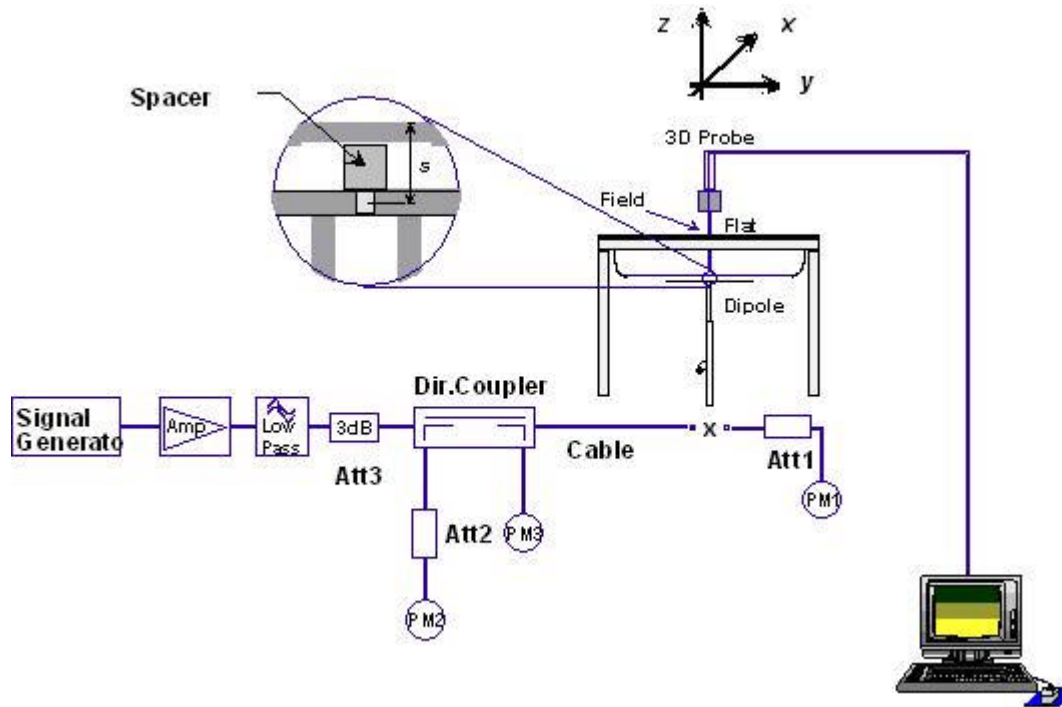
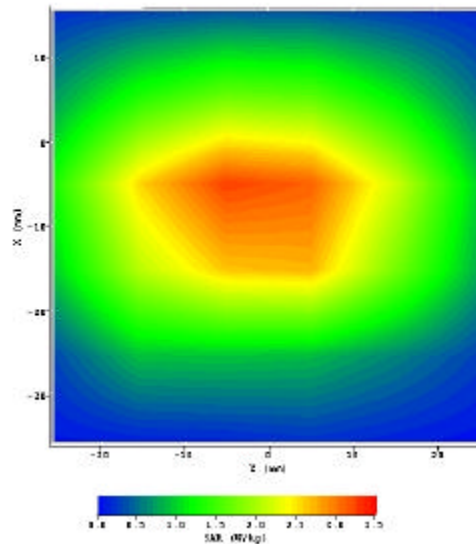

Figure 13. Performance Check Setup Diagram

Performance Checking

Test Position: Flat Phantom
Test Date: July 21, 2003
Antenna Position: Balanced Dipole
Probe: IXP-050/SN 0122 – SARf (0.673,0.673,0.673) Probe Cal Date 10/10/2002
Med. Parameters: Head: $\epsilon_r = 39.9$; $s = 1.40$
Pre Test Room Temp. 24.3C
Post Test Room Temp. 24.6C
Pre Test Simulant Liquid Temp. 24.5C
Post Test Simulant Liquid Temp. 24.7C
CH NA
SAR Drift <5%
SAR (1g): 39.72



Simulant	Freq [MHz]	Room Temp [C]	Liquid Temp [C]	Parameters	Target Value	Measured Value	Deviation [%]	Limit [%]
Head	1900	24.3	24.5	ϵ_r	40.0	39.9	-1.5	$\pm 5\%$
				σ	1.40	1.40	0	$\pm 5\%$
				1g SAR	39.7	39.72	0.05	$\pm 10\%$

Table 6. System Validation Results (July 21, 2003)

NOTE:

RF Forward power = 0.10W. The results are normalized to 1 Watts (CW) RF forward power
 Validation was done within 100MHz of test frequency

Performance Checking

Test Position: Flat Phantom
Test Date: July 22, 2003
Antenna Position: Balanced Dipole
Probe: IXP-050/SN 0122 – SARf (0.673,0.673,0.673) Probe Cal Date 10/10/2002
Med. Parameters: Head: $\epsilon_r = 39.8$; $s = 1.38$
Pre Test Room Temp. 23.3C
Post Test Room Temp. 23.8C
Pre Test Simulant Liquid Temp. 23.5C
Post Test Simulant Liquid Temp. 23.7C
CH NA
SAR Drift <5%
SAR (1g): 36.7

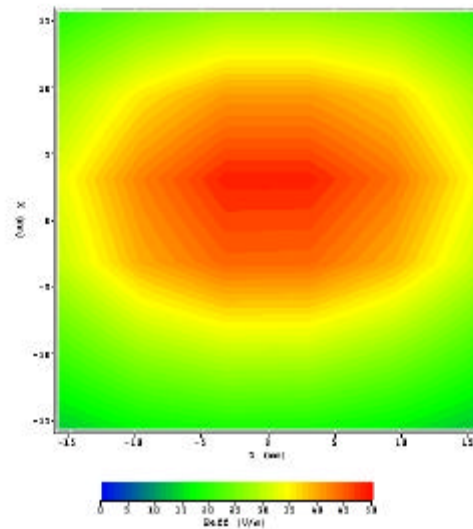

1900 MHz in Head tissue

Simulant	Freq [MHz]	Room Temp [C]	Liquid Temp [C]	Parameters	Target Value	Measured Value	Deviation [%]	Limit [%]
Head	1900	24.3	24.5	ϵ_r	40.0	39.8	-1.5	$\pm 5\%$
				σ	1.40	1.38	-1.4	$\pm 5\%$
				1g SAR	39.7	36.7	-7.5	$\pm 10\%$

Table 6. System Validation Results (July 22, 2003)

NOTE:

RF Forward power = 0.10W. The results are normalized to 1 Watts (CW) RF forward power
 Validation was done within 100MHz of test frequency

SAR Results Summary

MEASUREMENT RESULTS (Body SAR)

	Description	Power dBm	Channel	Frequency (MHz)	Max. 1g SAR (W/kg)	2 nd spot (W/kg)
1	Back of phone facing and touch phantom w/o Holster (Antenna in)	14.2	Ch. 10	1924.55	0.004	N/A
2	Back of phone facing and touch phantom w/o Holster (Antenna out)	14.2	Ch. 10	1924.55	0.019	N/A
3	Back of phone facing and touch phantom w/ Holster and headset (Antenna in)	14.2	Ch. 10	1924.55	0	N/A
4	Back of phone facing and touch phantom w/ Holster and headset (Antenna out)	14.2	Ch. 10	1924.55	0	N/A

Table 7. Measured Body SAR results for NEC Model PS3D Handset

NOTES:

- 1 The measurements are first performed at the middle channel of the operating band of the EUT. If the SAR value of the middle channel for each test configuration (Left, Right, Cheek, Tilt, Extended, Retracted) is at least 3 dB below the SAR limit, testing at the high and low channels is optional for such test configurations.
- 2 The test data reported are the worst-case SAR values with the antenna-head position set in a typical configuration.
- 3 All modes of operation are investigated and worst cases are reported.
- 4 Multiple Hot Spots TNone SAR was less than 3 dB of the highest peak Reported
- 5 Battery Type TStandard Extended Both
- 6 Power Measured TConducted EIRP ERP
- 7 SAR Measurement System SARA2
- 8 SAR Configuration Head TBody
- 9 Before the measurements, the test site ambient conditions were checked performing SAR measurements with the EUT powered off.

MEASUREMENT RESULTS (Head SAR)

	Test Position	Phantom Configuration	Power dBm	Channel	Frequency (GHz)	Max. 1g SAR (W/kg)	2 nd spot (W/kg)
1	Cheek (0 ⁰)	Left Side of Head Antenna in	14.2	Ch.10	1924.55	0	NA
2	Tilted (15 ⁰)		14.2	Ch.10	1924.55	0	NA
3	Tilted (15 ⁰)	Left Side of Head Antenna out	14.2	Ch.10	1924.55	0	NA
4	Cheek (0 ⁰)		14.2	Ch.10	1924.55	0	NA
5	Cheek (0 ⁰)	Right Side of Head Antenna in	14.2	Ch.10	1924.55	0	NA
6	Tilted (15 ⁰)		14.2	Ch.10	1924.55	0	NA
7	Tilted (15 ⁰)	Right Side of Head Antenna out	14.2	Ch.10	1924.55	0	NA
8	Cheek (0 ⁰)		14.2	Ch.10	1924.55	0	NA

Table 8. Measured head-phantom results for NEC Model PS3D Handset

NOTES:

- The measurements are first performed at the middle channel of the operating band of the EUT. If the SAR value of the middle channel for each test configuration (Left, Right, Cheek, Tilt, Extended, Retracted) is at least 3 dB below the SAR limit, testing at the high and low channels is optional for such test configurations.
- The test data reported are the worst-case SAR values with the antenna-head position set in a typical configuration.
- All modes of operation are investigated and worst cases are reported.
- Multiple Hot Spots TNone SAR was less than 3 dB of the highest peak Reported
- Battery Type TStandard Extended Both
- Power Measured TConducted EIRP ERP
- SAR Measurement System SARA2
- SAR Configuration THead Body
- Before the measurements, the test site ambient conditions were checked performing SAR measurements with the phone powered off.

SAR DISTRIBUTIONS (AREA SCANS)

Test Position:	Configuration 1-4 Per Test process Table 8
Test Date:	July 21, 2003
Antenna Position:	In / Out
Probe:	IXP-050/SN 0122 – SARf (0.673,0.673,0.673) Probe Cal Date 10/10/2002
Med. Parameters:	Head: $\epsilon_r = 39.8$; $s = 1.38$
Pre Test Room Temp.	24.3C
Post Test Room Temp.	24.6C
Pre Test Simulant Liquid Temp.	24.5C
Post Test Simulant Liquid Temp.	24.7C
CH 10	Crest factor 8
SAR Drift	<5%
SAR (1g) W/Kg	0

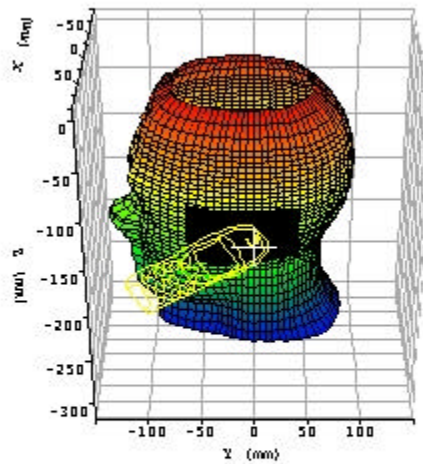
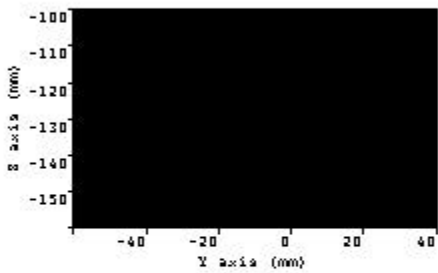

Test Position:	Configuration 5-8 Per Test process Table 8
Test Date:	July 21, 2003
Antenna Position:	In / Out
Probe:	IXP-050/SN 0122 – SARf (0.673,0.673,0.673) Probe Cal Date 10/10/2002
Med. Parameters:	Head: $\epsilon_r = 39.8$; $s = 1.38$
Pre Test Room Temp.	24.3C
Post Test Room Temp.	24.6C
Pre Test Simulant Liquid Temp.	24.5C
Post Test Simulant Liquid Temp.	24.7C
CH 10	Crest factor 8
SAR Drift	<5%
SAR (1g) W/Kg	0

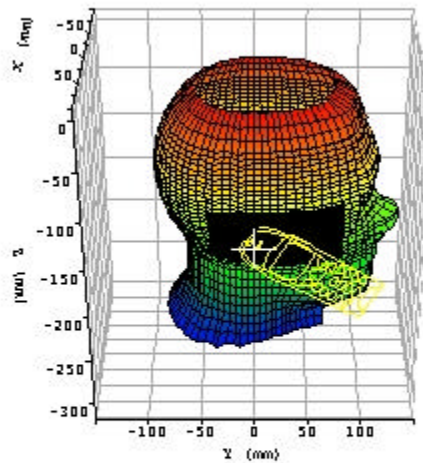
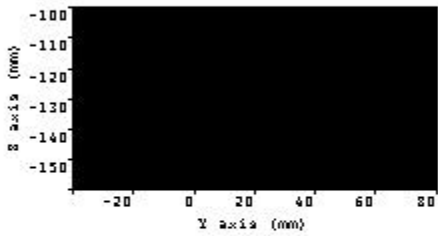

Test Position:	Configuration 1 Per Test process Table 7
Test Date:	July 22, 2003
Antenna Position:	In
Probe:	IXP-050/SN 0122 – SARf (0.713,0.713,0.713) Probe Cal Date 10/10/2002
Med. Parameters:	body: $\epsilon_r = 52.5$; $s = 1.52$
Pre Test Room Temp.	23.3C
Post Test Room Temp.	23.6C
Pre Test Simulant Liquid Temp.	23.5C
Post Test Simulant Liquid Temp.	23.7C
CH 10	Crest factor 8
SAR Drift	<5%
SAR (1g) W/Kg	0.004

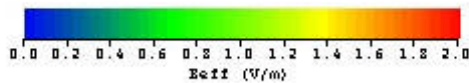
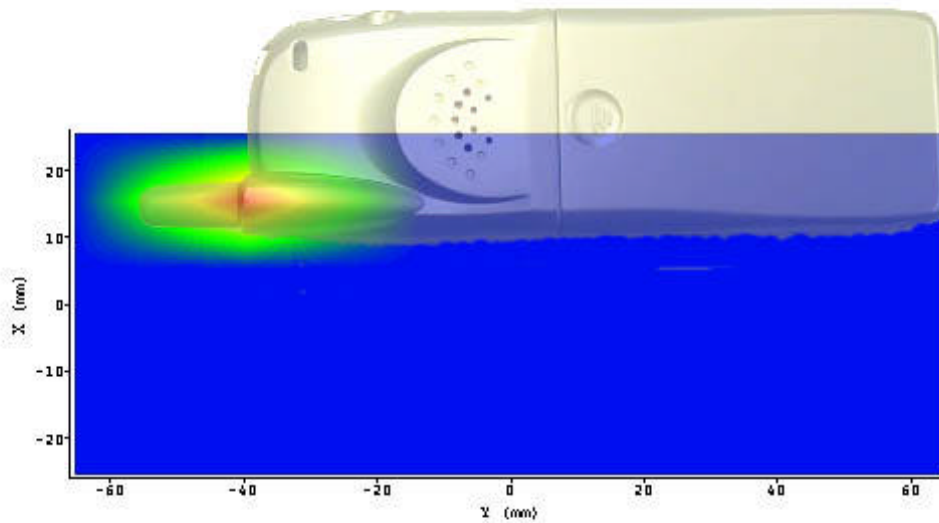

Test Position:	Configuration 2 Per Test process Table 7
Test Date:	July 22, 2003
Antenna Position:	Out
Probe:	IXP-050/SN 0122 – SARf (0.713,0.713,0.713) Probe Cal Date 10/10/2002
Med. Parameters:	body: $\epsilon_r = 52.5$; $s = 1.52$
Pre Test Room Temp.	23.3C
Post Test Room Temp.	23.6C
Pre Test Simulant Liquid Temp.	23.5C
Post Test Simulant Liquid Temp.	23.7C
CH 10	Crest factor 8
SAR Drift	<5%
SAR (1g) W/Kg	0.019

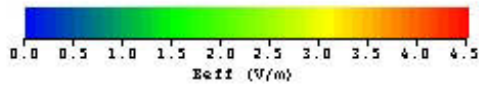
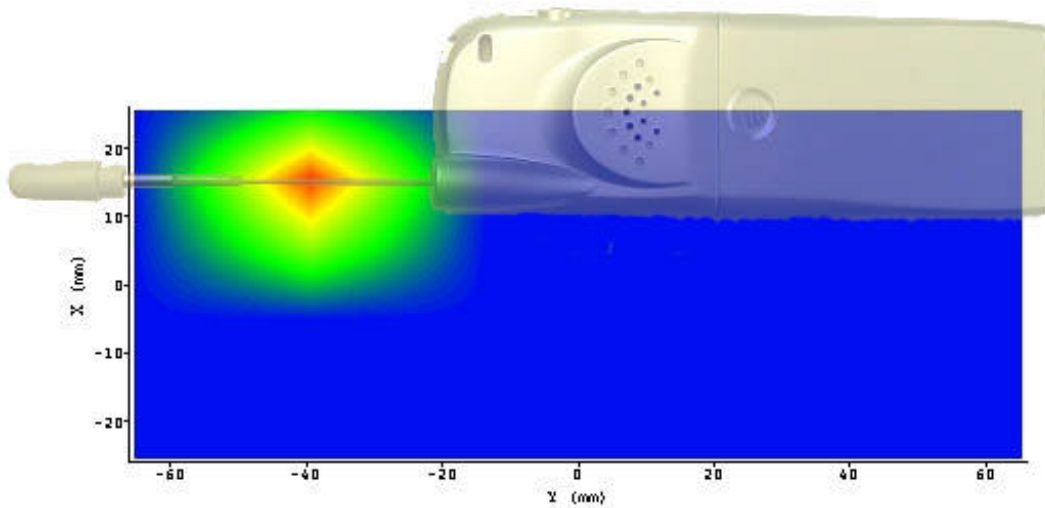

Test Position:	Configuration 3 Per Test process Table 7
Test Date:	July 22, 2003
Antenna Position:	In
Probe:	IXP-050/SN 0122 – SARf (0.713,0.713,0.713) Probe Cal Date 10/10/2002
Med. Parameters:	body: $\epsilon_r = 52.5$; $s = 1.52$
Pre Test Room Temp.	23.3C
Post Test Room Temp.	23.6C
Pre Test Simulant Liquid Temp.	23.5C
Post Test Simulant Liquid Temp.	23.7C
CH 10	Crest factor 8
SAR Drift	<5%
SAR (1g) W/Kg	0

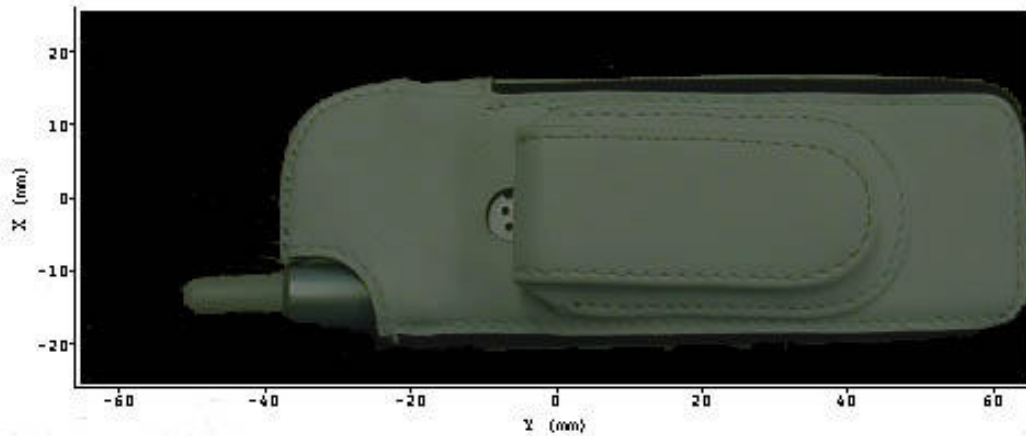

Test Position:	Configuration 4 Per Test process Table 7
Test Date:	July 22, 2003
Antenna Position:	Out
Probe:	IXP-050/SN 0122 – SARf (0.713,0.713,0.713) Probe Cal Date 10/10/2002
Med. Parameters:	body: $\epsilon_r = 52.5$; $s = 1.52$
Pre Test Room Temp.	23.3C
Post Test Room Temp.	23.6C
Pre Test Simulant Liquid Temp.	23.5C
Post Test Simulant Liquid Temp.	23.7C
CH 10	Crest factor 8
SAR Drift	<5%
SAR (1g) W/Kg	0

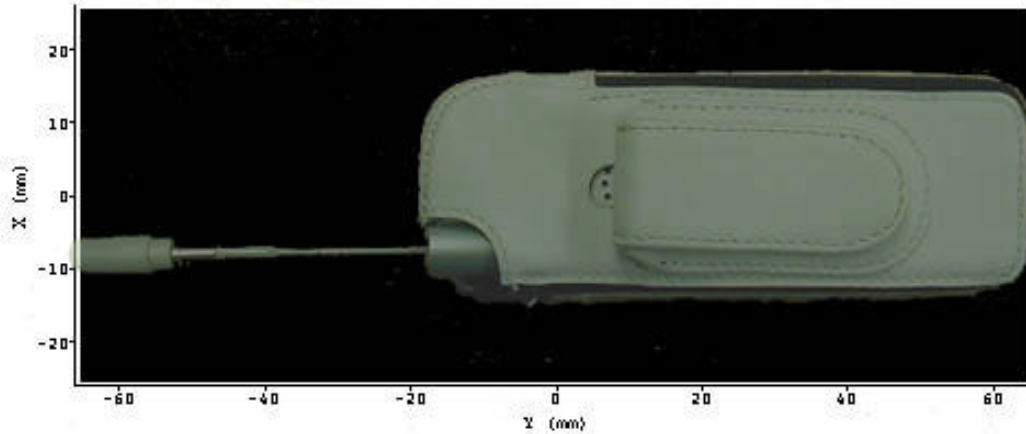

Setup Pictures

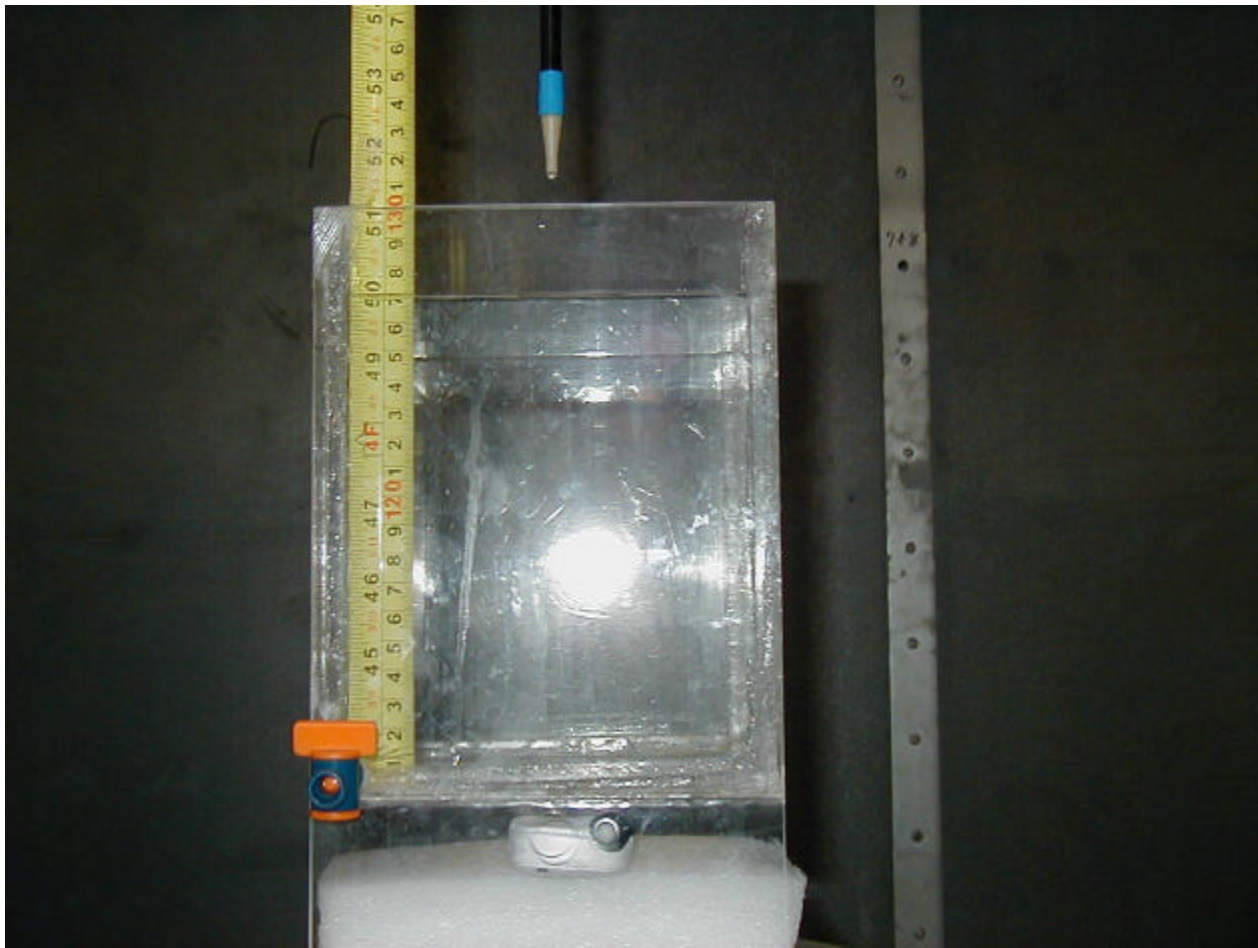

Figure S0. Measurement of the body liquid phantom depth (17 cm)



Figure S1. Setup Configuration 1 per table 8



Figure S2. Setup Configuration 2 per table 8

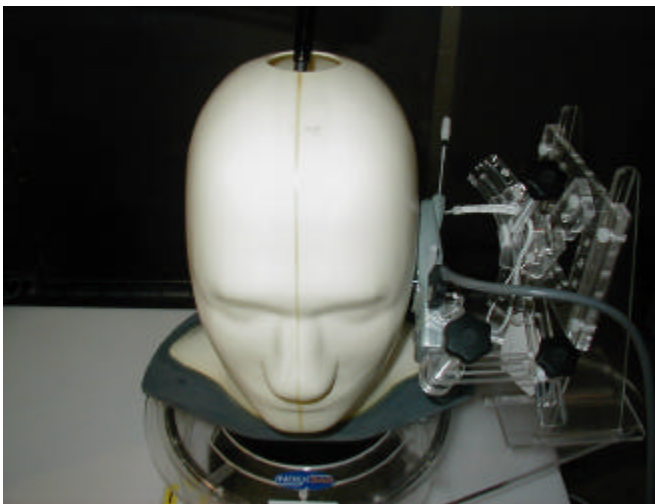

Figure S3. Setup Configuration 4 per table 8

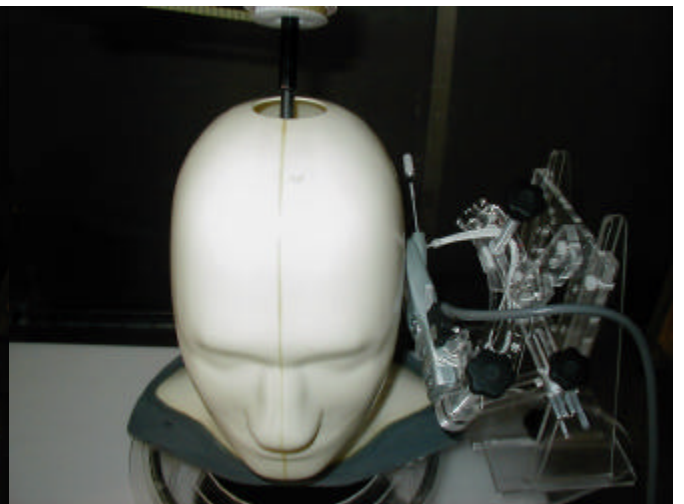

Figure S4. Setup Configuration 3 per table 8



Figure S5. Setup Configuration 5 per table 8

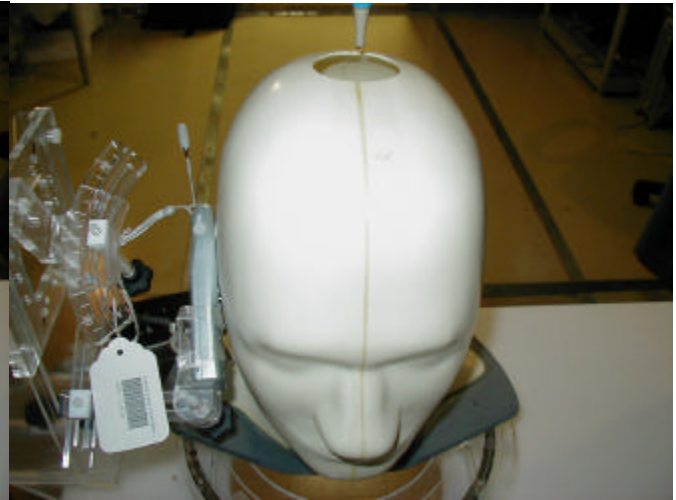

Figure S6. Setup Configuration 7 per table 8



Figure S7. Setup Configuration 6 per table 8

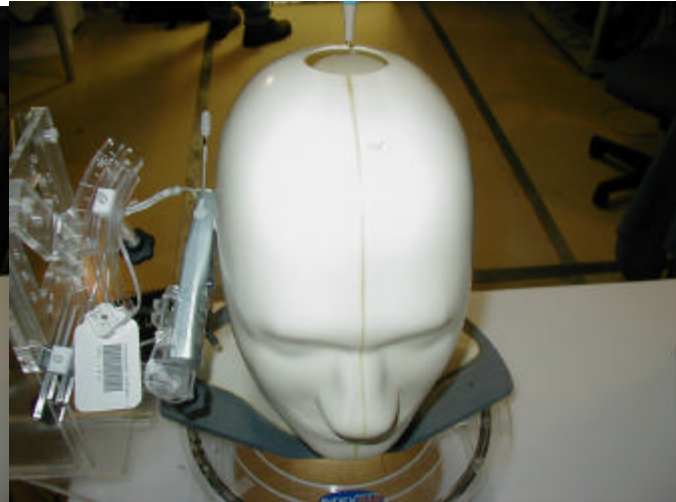

Figure S8. Setup Configuration 8 per table 8

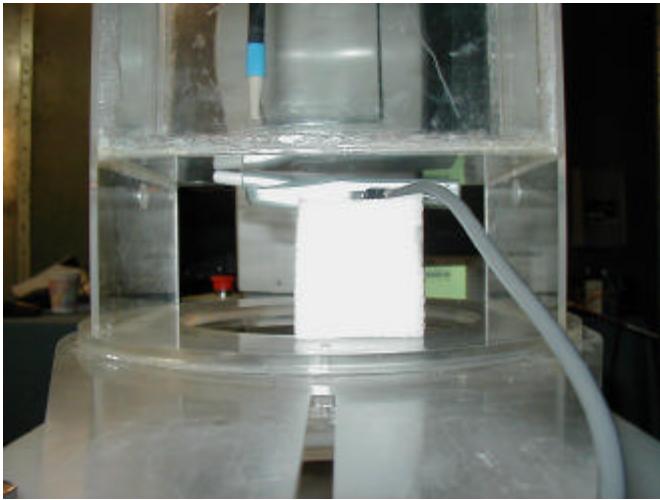

Figure S9. Setup Configuration 1 per table 7

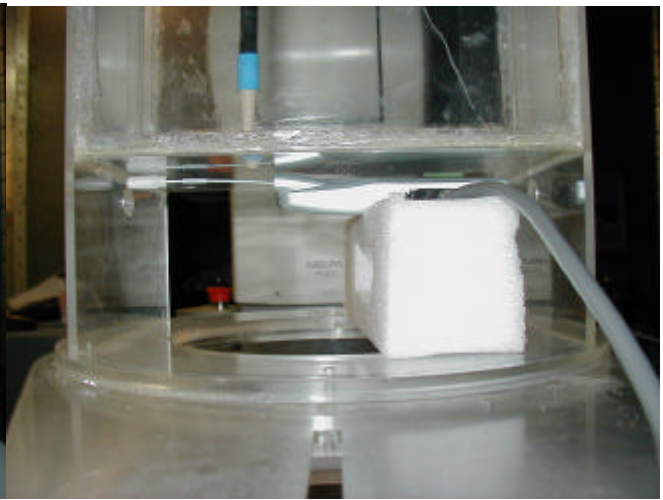

Figure S9. Setup Configuration 2 per table 7

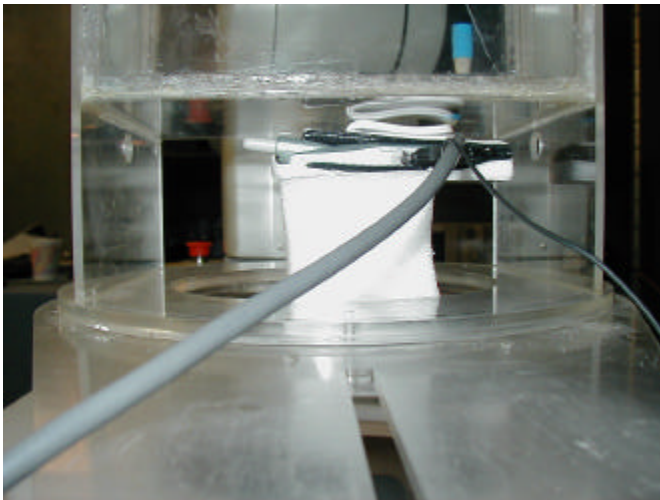

Figure S11. Setup Configuration 3 per table 7

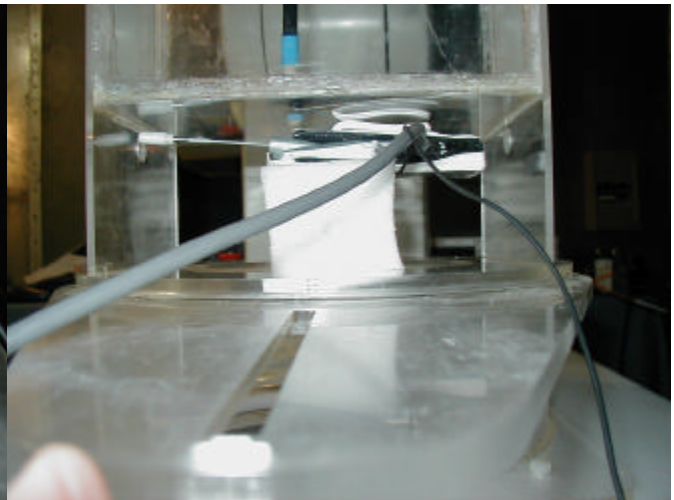

Figure S12. Setup Configuration 4 per table 7

Measurement System

Measurement System - SARA2 System Specification

The SAR measurement system being used is the IndexSAR SARA2 system, which consists of a Mitsubishi RV-E2 6-axis robot arm and controller, IndexSAR probe and amplifier and SAM phantom Head Shape. The robot is used to articulate the probe to programmed positions inside the phantom head to obtain the SAR readings from the EUT.

The system is controlled remotely from a PC, which contains the software to control the robot and data acquisition equipment. The software also displays the data obtained from test scans.

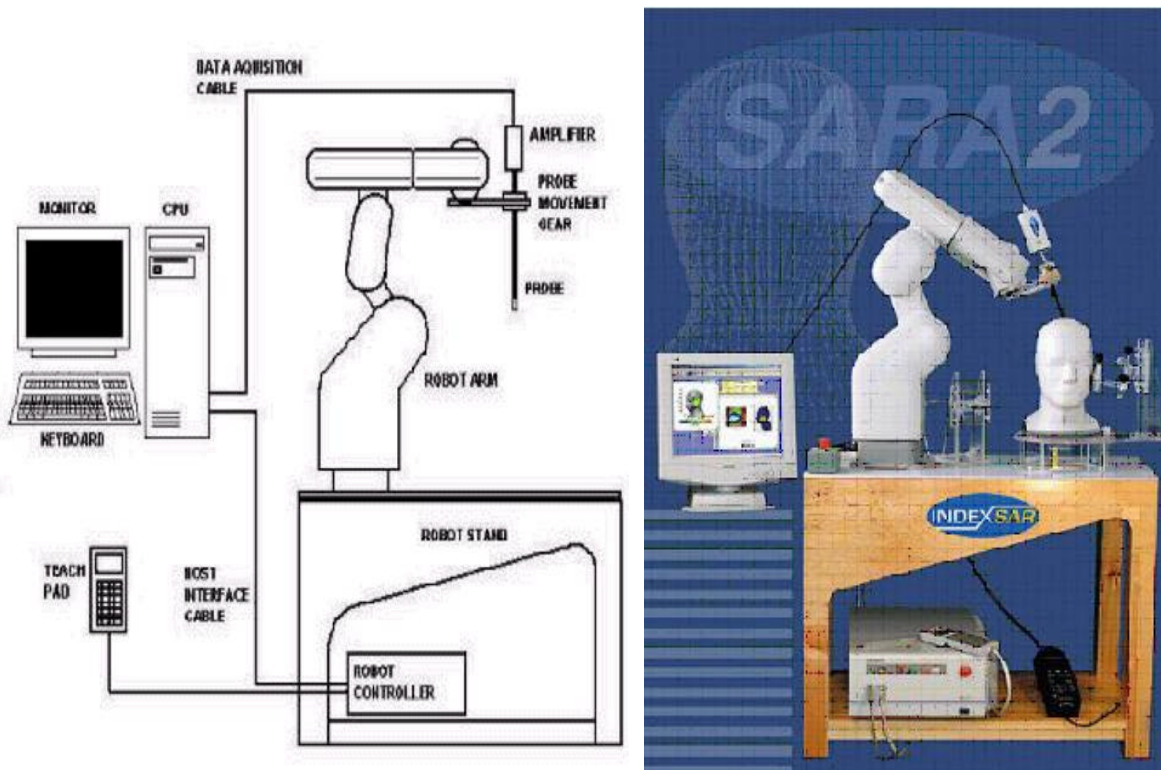

Figure 9. Block Diagram of SARA 2 System

The position and digitized shape of the phantom heads/flat baths are made available to the software for accurate positioning of the probe and reduction of set-up time.

The SAM phantom heads/flat baths are individually digitized using a Mitutoyo CMM machine to a precision of 0.001mm. The data is then converted into a shape format for the software, providing an accurate description of the phantom shell.

In operation, the system first performs an area (2D) scan at a fixed depth within the liquid from the inside wall of the phantom. When the maximum SAR point has been found, the system will then carry out a 3D scan centred at that point to determine volume averaged SAR level.

Specifications

ROBOTIC SYSTEM



Type:	Mitsubishi Movemaster RV-2E/ 6 Axis vertical articulated robot
Dimensions (Robot):	Height: 790mm (in home position)
Dimensions (Robot Stand):	1010L x 450W x 820H mm
Weight:	Approx. 36 kgf
Position Repeatability:	+/- 0.04mm
Drive Method:	AC servomotor

CONTROLLER UNIT



Type:	CR-E116
Dimensions:	422W x 512D x 202H mm
Weight:	Approx. 27 kgf
Power source:	single-phase AC200V

E-FIELD PROBE



Type:	Three orthogonal dipole sensors arranged on triangular, interlocking substrates Overall length: 350mm
Dimensions:	Tip length: 10mm Body diameter: 12mm Tip diameter: 5mm
Isotropy:	Distance from probe tip to dipole centers: 2.5mm +/- 0.5 dB in brain liquids (rotation about probe axis) +/- 1.0 dB in brain liquids (rotation normal to probe axis)
Calibration:	Indexsar calibration in brain tissue simulating liquids at frequencies of 900 MHz and 1800 MHz
Dynamic Range:	0.01 W/kg to 100 W/kg in liquid. Linearity +/- 0.2 W/kg

**Data Acquisition**

Processor	Pentium III
Clock Speed	700MHz
Operating System	Windows 98 or 2000
I/O	Two RS232, or One RS232 and One USB
Software	SARA2 Ver.281, IXU-010X Utility Software Ver.400, Microsoft Excel
Memory	10GB Hard drive, CDROM

IXP-010 Amplifier

The amplifier unit has multi-pole connector to connect to the probe and a multiplexer selects between the 3-channel single-ended inputs. A 16-bit AtoD converter with programmable gain is used along with an on-board micro-controller with non-volatile firmware. Battery life is around 150 hours and data are transferred to the PC via 3m of duplex optical fibre and a self-powered RS232 to optical converter.

Amplifier Specification

1	Input	Multipole connector to suit probe in use
2	Channels	Multiple wd 3 channel single ended inputs
3	Amplifier	16 bit A/D Converter with programmable gain
4	Dimensions	120x60x30 mm
5	Weight	170g(with batteries)
6	Optical Link	3 m duplex optical fiber

INDEXSAR ISOTROPIC SAR PROBES

E-Field Probe

The near field probe is an implant-able isotropic E-field probe that measures the voltages proportional to $|E|^2$ or $|H|^2$ fields. The probes are constructed using three orthogonal dipole sensors arranged on an interlocking, triangular prism core. The probes have built-in shielding against static charges and are contained within a PEEK cylindrical enclosure material at the tip. Probe calibration is described in more detail in the Calibration report appendix..

The overall length of probe is 350mm with a Body diameter of 12mm and tip diameter of 5mm.



Probe with Amplifier

E-FIELD PROBE CALIBRATION

The E-field probe calibration method is based on setting up a calculable specific absorption rate (SAR) in a vertically-mounted WG8 (R22) wave-guide section [1]. The wave-guide has an air-filled, launcher section and a liquid-filled section separated by a matching window that is designed to minimize reflections at the liquid interface. A TE₀₁ mode is launched into the wave-guide by means of a N-type-to-wave-guide adapter. The power delivered to the liquid section is calculated from the forward power and reflection coefficient measured at the input to the wave-guide. For a detailed description of the E-field probe calibration please refer to the calibration report provided.

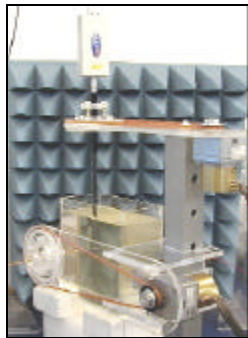

Spherical isotropy jig showing probe

The probe was calibrated at 900, 1800, 1900 and 2450MHz in liquid samples representing both brain liquid and body fluid at these frequencies.

The dielectric properties of the brain and body tissue-Simulant liquids employed for calibration are listed in the table below. The measurements were performed prior to each wave-guide test using an Indexsar DiLine measurement kit, which uses the TEM method as recommended in IEEE 1528.

<i>Liquid used</i>	<i>Relative permittivity (measured)</i>	<i>Conductivity (S/m) (measured)</i>
835 MHz BRAIN	43.3	0.911
835 MHz BODY	58.9	0.985
900 MHz BRAIN	42.5	0.97
900 MHz BODY	58.45	1.044
1800 MHz BRAIN	38.97	1.33
1800 MHz BODY	52.53	1.51
1900 MHz BRAIN	38.43	1.429
1900 MHz BODY	52.02	1.62
2000 MHz BRAIN	37.42	1.36
2450 MHz BRAIN	39.29	1.737
2450 MHz BODY	62.9	2.08

Table indicating the dielectric parameters of the liquids used for calibrations at each frequency

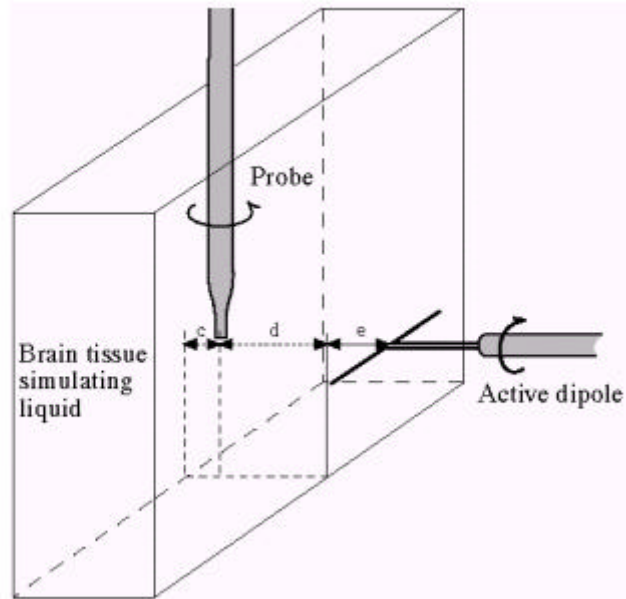

Calibration jig showing probe, dipole and box filled with simulated brain liquid

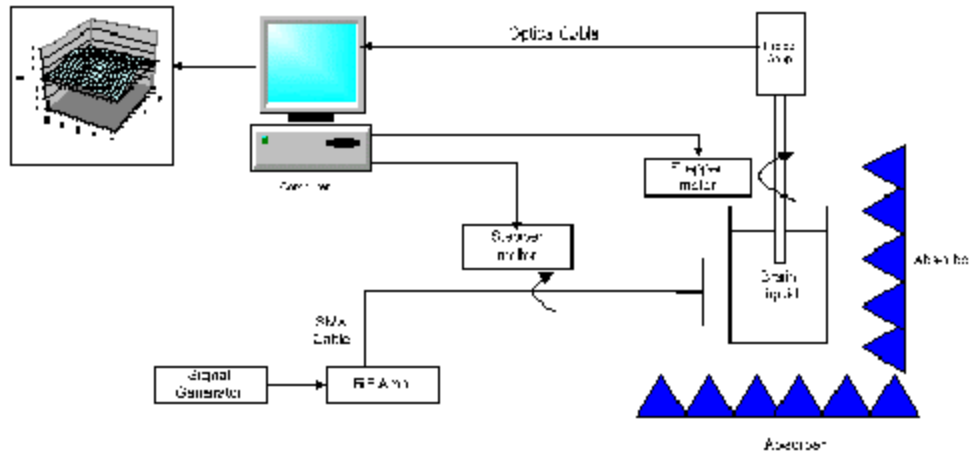

Schematic diagram of the test geometry used for isotropy

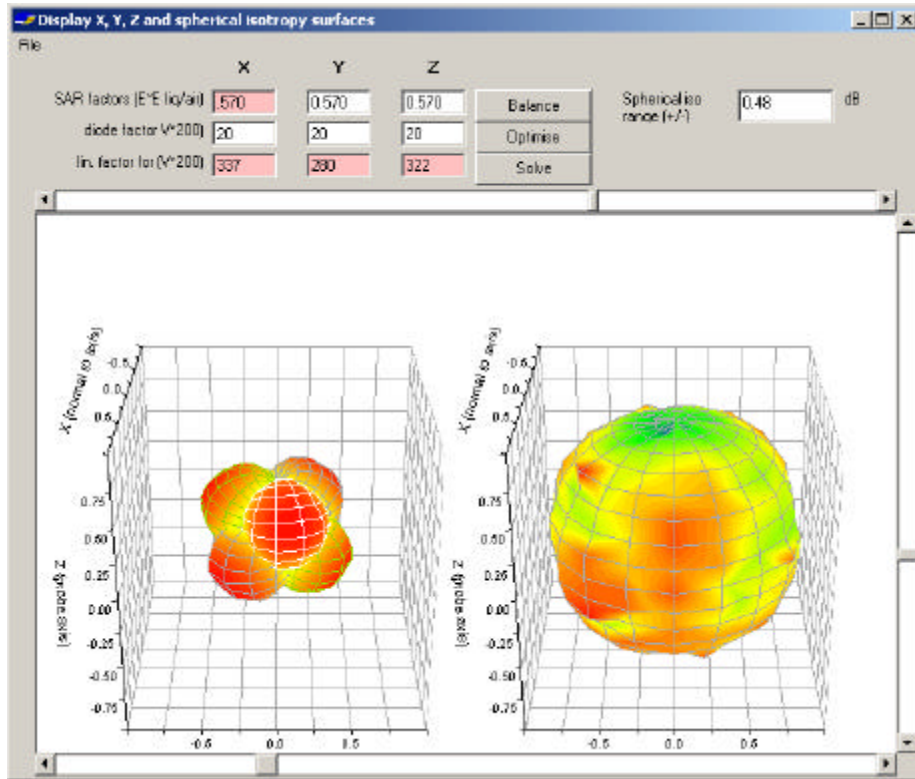

Graphical representation of the probe response to fields applied from each direction. The diagram on the left shows the individual response characteristics of each of the three channels and the diagram on the right shows the resulting probe sensitivity in each direction. The colour range in the figure images the lowest values as blue and the maximum values as red. For the probe S/N 0122, this range is (+/-) 0.48 dB. The probe is more sensitive to fields parallel to the axis and less sensitive to fields normal to the probe axis.

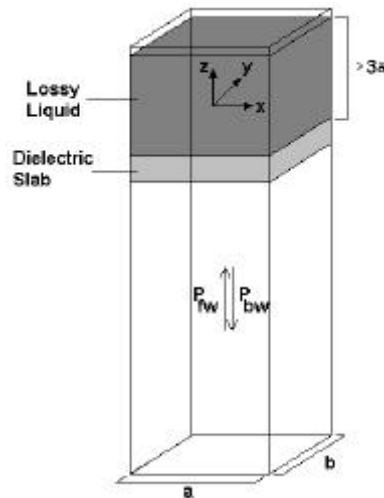

Geometry used for wave-guide calibration (after Ref [2]. Section A.3.2.2)

PHANTOMS

SAM Twin Horizontal Phantom per IEEE Draft 1528

The SAM Twin Horizontal is fabricated to the CAD files as specified by FCC OET 65 Supplement C 01-01 and IEEE Draft 1528. It is mounted on a dielectric table which includes mounting brackets for EUT positioners and a shelf for dipole holders. The phantom has three integrated positioning reference points.

SAM Upright Phantom per CENELEC EN50361

The SAM Upright Phantom is fabricated to the CAD files as specified by CENELEC EN50361. It is mounted on the base table which holds the robotic positioner. The phantom and robot alignment is assured by both mechanical and laser registration systems.

Flat Bath Phantom for testing above 800 MHz

The Flat Bath Box Phantom is fabricated to the specifications of the OET 65 Supplement C and CENELEC EN50361 standard. It is mounted on a similar rotational base to that of which the SAM upright phantom is attached to. It is positioned in place of the SAM upright head when doing validations or flat bath testing.



Phantom Specifications

Phantom Type	Material	Permittivity (g)	Conductivity (F - S/m)
SAM Upright Phantom	Head:polyurethane Resin Base:PVC	<3.15 above 200 MHz	<0.02 below 2 GHz
Box Phantom	Clear: Perspex	<2.85 above 500 MHz	<0.015 below 2 GHz

Phantom Properties



Experience has shown that SAR results can vary considerably when plastic or material fixtures used to position the test devices are too close to the antennas (especially for phones with internal antennas). The MapSAR positioner has been designed to have no support material close the top of the phone and is arranged so that the phone pivots around the earpiece position. The positioner gives a range of phone angles from the starting touch position to +15° as required by CENELEC Pr EN 50361 or any position within a range of 30°. A graduated scale allows for easy setting. Adjustment is made by means of simple hand screws. For tests requiring phantom hands or hand material, space is made available behind the phone.

Measurement Procedure

The major components of the test bench are shown in the picture above. A test set and dipole antenna control the handset via an air link and a low-mass phone holder can position the phone at either ear. Graduated scales are provided to set the phone in the 15 degree position. The upright phantom head holds approx. 7 liters of simulant liquid. The phantom is filled and emptied through a 45mm diameter penetration hole in the top of the head.

After an area scan has been performed at a fixed distance of 8mm from the surface of the phantom on the source side, a 3D scan is set up around the location of the maximum spot SAR. First, a point within the scan area is visited by the probe and a SAR reading taken at the start of testing. At the end of testing, the probe is returned to the same point and a second reading is taken. Comparison between these start and end readings enables the power drift during measurement to be assessed.

SARA2 Interpolation and Extrapolation schemes

SARA2 software contains support for both 2D cubic B-spline interpolation as well as 3D cubic B-spline interpolation. In addition, for extrapolation purposes, a general n-th order polynomial fitting routine is implemented following a singular value decomposition algorithm presented in [4]. A 4th order polynomial fit is used by default for data extrapolation, but a linear-logarithmic fitting function can be selected as an option. The polynomial fitting procedures have been tested by comparing the fitting coefficients generated by the SARA2 procedures with those obtained using the polynomial fit functions of Microsoft Excel when applied to the same test input data.

Interpolation of 2D area scan

The 2D cubic B-spline interpolation is used after the initial area scan at fixed distance from the phantom shell wall. The initial scan data are collected with approx. 10mm spatial resolution and spline interpolation is used to find the location of the local maximum to within a 1mm resolution for positioning the subsequent 3D scanning.

Extrapolation of 3D scan

For the 3D scan, data are collected on a spatially regular 3D grid having (by default) 6.4 mm steps in the lateral dimensions and 3.5 mm steps in the depth direction (away from the source). SARA2 enables full control over the selection of alternative step sizes in all directions.

The digitized shape of the head is available to the SARA2 software, which decides which points in the 3D array are sufficiently well within the shell wall to be 'visited' by the SAR probe. After the data collection, the data are extrapolated in the depth direction to assign values to points in the 3D array closer to the shell wall. A notional extrapolation value is also assigned to the first point outside the shell wall so that subsequent interpolation schemes will be applicable right up to the shell wall boundary.

Interpolation of 3D scan and volume averaging

The procedure used for defining the shape of the volumes used for SAR averaging in the SARA2 software follow the method of adapting the surface of the 'cube' to conform with the curved inner surface of the phantom. This is called, here, the conformal scheme.

For each row of data in the depth direction, the data are extrapolated and interpolated to less than 1mm spacing and average values are calculated from the phantom surface for the row of data over distances corresponding to the requisite depth for 10g and 1g cubes. This results in two 2D arrays of data, which are then cubic B-spline interpolated to sub mm lateral resolution. A search routine then moves an averaging square around through the 2D array and records the maximum value of the Corresponding 1g and 10g volume averages. For the definition of the surface in this procedure, the digitized position of the



head shell surface is used for measurement in head-shaped phantoms. For measurements in rectangular, box phantoms, the distance between the phantom wall and the closest set of gridded data points is entered into the software.

For measurements in box-shaped phantoms, this distance is under the control of the user. The effective distance must be greater than 2.5mm as this is the tip-sensor distance and to avoid interface proximity effects, it should be at least 5mm. A value of 6 or 8mm is recommended. This distance is called db_e in EN 50361.

For automated measurements inside the head, the distance cannot be less than 2.5mm, which is the radius of the probe tip and to avoid interface proximity effects, a minimum clearance distance of x mm is retained. The actual value of db_e will vary from point to point depending upon how the spatially-regular 3D grid points fit within the shell. The greatest separation is when a grid point is just not visited due to the probe tip dimensions. In this case the distance could be as large as the step-size plus the minimum clearance distance (i.e with $x=5$ and a step size of 3.5, db_e will be between 3.5 and 8.5mm).

The default step size (dstep in EN 50361) used is 3.5mm, but this is under user-control. The compromise is with time of scan, so it is not practical to make it much smaller or scan times become long and power-drop influences become larger. The robot positioning system specification for the repeatability of the positioning (dss in EN50361) is ± 0.04 mm.

The phantom shell is made by an industrial molding process from the CAD files of the SAM shape, with both internal and external moulds. For the upright phantoms, the external shape is subsequently digitised on a Mitutoyo CMM machine (Euro C574) to a precision of 0.001mm. Wall thickness measurements made non-destructively with an ultrasonic sensor indicate that the shell thickness (dph) away from the ear is 2.0 \pm 0.1mm. The ultrasonic measurements were calibrated using additional mechanical measurements on available cut surfaces of the phantom shells. See support document IXS-020x.

For the upright phantom, the alignment is based upon registration of the rotation axis of the phantom on its 253mm diameter baseplate bearing and the position of the probe axis when commanded to go to the axial position. A laser alignment tool is provided (procedure detailed elsewhere). This enables the registration of the phantom tip (dmis) to be assured to within approx. 0.2mm. This alignment is done with reference to the actual probe tip after installation and probe alignment. The rotational positioning of the phantom is variable – offering advantages for special studies, but locating pins ensure accurate repositioning at the principal positions (LH and RH ears).

Uncertainty Assessment

Uncertainty Component	Sec.	Tol. (+/-)		Prob. Dist.	Divisor (descrip)		Divisor (value)	c1	Standard Uncertainty (%)	
		(dB)	(%)							
sqr										
Measurement System										
Probe Calibration	E1.1			10	N	1 or k	2	1	5.00	25.00
Axial Isotropy	E1.2	0.25	5.93	5.93	R	v3	1.73	0	0.00	0.00
Hemispherical Isotropy	E1.2	0.5	12.2	12.20	R	v3	1.73	1	7.04	49.63
Boundary effects	E1.3		4	4.00	R	v3	1.73	1	2.31	5.33
Linearity	E1.4	0.04	0.93	0.93	R	v3	1.73	1	0.53	0.29
System Detection Limits	E1.5		1	1.00	R	v3	1.73	1	0.58	0.33
Readout Electronics	E1.6		1	1.00	N	1 or k	1.00	1	1	1.00
Response time	E1.7		0	0.00	R	v3	1.73	1	0	0.00
Integration time	E1.8		1.8	1.80	R	v3	1.73	1	1.04	1.08
RF Ambient Conditions	E5.1		3	3.00	R	v3	1.73	1	1.73	3
Probe Positioner Mechanical Tolerance	E5.2		0.6	0.60	R	v3	1.73	1	0.35	0.12
Probe Position wrt. Phantom Shell	E5.3		5	3.80	R	v3	1.73	1	2.19	4.81
SAR Evaluation Algorithms	E4.2		8	4.00	R	v3	1.73	1	2.31	5.33
Test Sample Related										
Test Sample Positioning	E3.2.1		10	10.00	R	v3	1.73	1	5.77	33.33
Device Holder Uncertainty	E3.1.1		10	8.00	R	v3	1.73	1	4.62	21.33
Output Power Variation	E5.6.2		5	5.00	R	v3	1.73	1	2.89	8.33
Phantom and Tissue Parameters										
Phantom Uncertainty (shape and thickness)	E2.1		4	4.00	R	v3	1.73	0.5	1.15	1.33
Liquid conductivity (Deviation from target)	E2.2		5	5.00	R	v3	1.73	0.5	1.44	2.08
Liquid conductivity (measurement uncert.)	E2.2		10	10.00	R	v3	1.73	0.5	2.89	8.33
Liquid permittivity (Deviation from target)	E2.2		5	5	R	v3	1.73	0.5	1.44	2.08
Liquid permittivity (measurement uncert.)	E2.2		5	5.00	R	v3	1.73	0.5	1.44	2.08
Combined standard uncertainty					RSS			13.2		
Expanded uncertainty k=2(95% Confidence Level)					25.9%					

Table 8. Uncertainty budget of SARA2

Table 8 includes the preliminary uncertainty budget. The expanded uncertainty is assessed to be 25.9%. This uncertainty includes probe calibration, positioning and evaluation errors, as well as errors of the correct dielectric parameters for the tissue simulating liquid, etc.

Appendix

Z-SCAN PLOTS

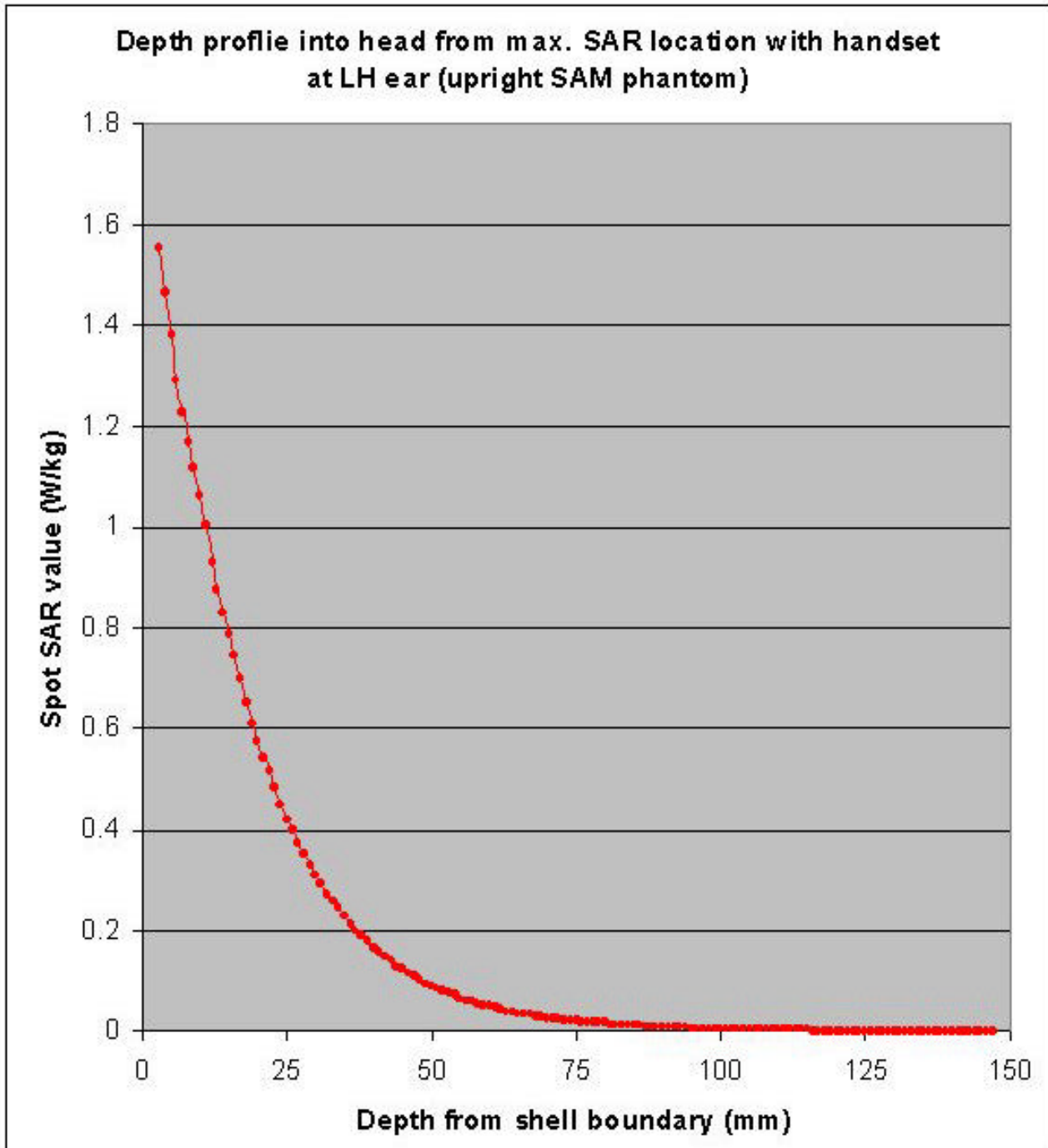

FCC Exposure Criteria

In the USA the recent FCC exposure criteria [FCC 2001] are based upon the IEEE Standard C95.1 [IEEE 1999]. The IEEE standard C95.1 sets limits for human exposure to radio frequency electromagnetic fields in the frequency range 3 kHz to 300 GHz.

2.1 Distinction Between Exposed Population, Duration of Exposure and Frequencies

The American Standard [IEEE 1999] distinguishes between controlled and uncontrolled environment. Controlled environments are locations where there is exposure that may be incurred by persons who are aware of the potential for exposure as a concomitant of employment or by other cognizant persons. Uncontrolled environments are locations where there is the exposure of individuals who have no knowledge or control of their exposure. The exposures may occur in living quarters or workplaces. For exposure in controlled environments higher field strengths are admissible. In addition the duration of exposure is considered.

Due to the influence of frequency on important parameters, as the penetration depth of the electromagnetic fields into the human body and the absorption capability of different tissues, the limits in general vary with frequency.

2.2 Distinction between Maximum Permissible

The biological relevant parameter describing the effects of electromagnetic fields in the frequency range of interest is the specific absorption rate SAR (dimension: power/mass). It is a measure of the power absorbed per unit mass. The SAR may be spatially averaged over the total mass of an exposed body or its parts. The SAR is calculated from the r.m.s. electric field strength E inside the human body, the conductivity σ and the mass density ρ of the biological tissue:

$$SAR = \sigma \frac{E^2}{\rho}$$

The specific absorption rate describes the initial rate of temperature rise as a function of the specific heat capacity c of the tissue. A limitation of the specific absorption rate prevents an excessive heating of the human body by electromagnetic energy.

As it is sometimes difficult to determine the SAR directly by measurement (e.g. whole body averaged SAR), the standard specifies more readily measurable maximum permissible exposures in terms of external electric E and magnetic field strength H and power density S , derived from the SAR limits. The limits for E , H and S have been fixed so that even under worst case conditions, the limits for the specific absorption rate SAR are not exceeded. For the relevant frequency range the maximum permissible exposure may be exceeded if the exposure can be shown by appropriate techniques to produce SAR values below the corresponding limits.

2.3 SAR Limit

In this report the comparison between the American exposure limits and the measured data is made using the spatial peak SAR; the power level of the device under test guarantees that the whole body averaged SAR is not exceeded. Having in mind a worst case consideration, the SAR limit is valid for uncontrolled environment and mobile respectively portable transmitters. According to Table 1 the SAR values have to be averaged over a mass of 1 g (SAR1g) with the shape of a cube.

Standard	Status	SAR limit [W/kg]
OET 65 Supplement C Edition 01-01	In Force	1.6

SAR Limit

The FCC Measurement Procedure

The Federal Communications Commission (FCC) has published a report and order on the 1 st of August 1996 [FCC 1996], which requires routine dosimetric assessment of mobile telecom-communications devices, either by laboratory measurement techniques or by computational modeling, prior to equipment authorization or use. In 2001 the Commission's Office of Engineering and Technology has released Edition 01-01 of Supplement C to OET Bulletin 65.

This revised edition, which replaces Edition 97-01, provides additional guidance and information for evaluating compliance of mobile and portable devices with FCC limits for human exposure to radio frequency emissions [FCC 2001].

General Requirements

The test shall be performed in a laboratory with an environment which avoids influence on SAR measurements by ambient EM sources and any reflection from the environment itself. The ambient temperature shall be in the range of 20°C to 26°C and 30-70% humidity.

Device Operating Next to a Person's Ear

3.2.1 Phantom Requirements

The phantom is a simplified representation of the human anatomy and comprised of material with electrical properties similar to the corresponding tissues. The physical characteristics of the phantom model shall resemble the head and the neck of a user since the shape is a dominant parameter for exposure.

Test Positions

As it cannot be expected that the user will hold the mobile phone exactly in one well defined position, different operational conditions shall be tested. The Supplement C to OET Bulletin 65 requires two test positions. For an exact description helpful geometrical definitions are introduced and shown in Fig. 2 - 3.

There are two imaginary lines on the mobile, the vertical centerline and the horizontal line. The vertical centerline passes through two points on the front side of the handset: the midpoint of the width w_t of the handset at the level of the acoustic output (point A on Fig. 2), and the midpoint of the width w_b of the bottom of the handset (point B). The horizontal line is perpendicular to the vertical centerline and passes through the center of the acoustic output (see Fig. 2). The two lines intersect at point A.

According to Fig. 3 the human head position is given by means of the following three reference points: auditory canal opening of both ears (RE and LE) and the center of the closed mouth (M). The ear reference points are 15-17 mm above the entrance to the ear canal along the BM line (back-mouth), as shown in Fig. 3. The plane passing through the two ear canals and M is defined as the reference plane. The line NF (Neck-Front) perpendicular to the reference plane and passing through the RE (or LE) is called the reference pivoting line. Line BM is perpendicular to the NF line. With this definitions the test positions are given by;

Check position (see Fig. 4):

Position the handset close to the surface of the phantom such that point A is on the (virtual) extension of the line passing through points RE and LE on the phantom (see Fig. 3), such that the plane defined by the vertical center line and the horizontal line of the phone is approximately parallel to the sagittal plane of the phantom. Translate the handset towards the phantom along the line passing through RE and LE until the handset touches the ear. While maintaining the handset in this plane, rotate it around the LE-RE line until the vertical centerline is in the plane normal to MB-NF including the line MB (called the reference plane). Rotate the phone around the vertical centerline until the phone (horizontal line) is symmetrical with respect to the line NF. While maintaining the vertical centerline in the reference plane, keeping point A on the line passing through RE and LE, and maintaining the phone contact with the ear, rotate the handset about the line NF until any point on the handset is in contact with a phantom point below the ear. While maintaining the orientation of the phone retract the phone parallel to the reference plane far enough to enable a rotation of the phone by 15°. Rotate the phone around the horizontal line by 15°. While maintaining the orientation of the phone, move the phone parallel to the reference plane until any part of the phone touches the head. In this position, point A will be located on the line RE-LE.

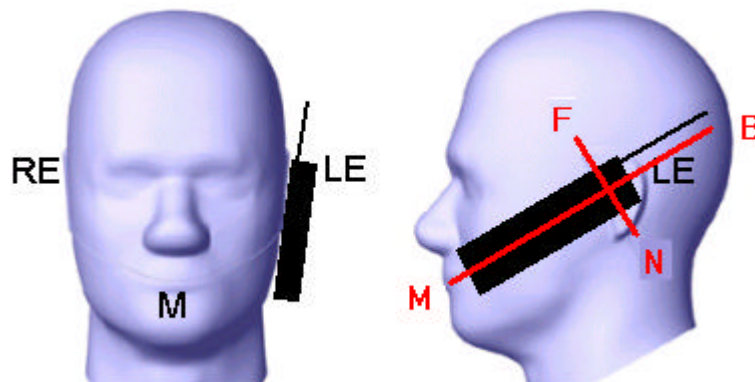
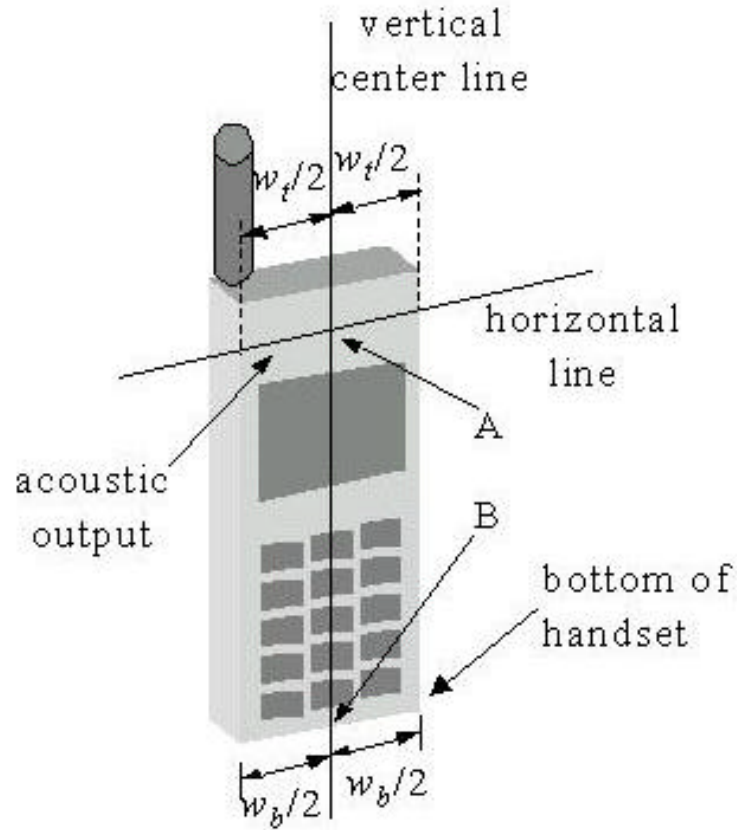

Phantom reference points.

Test to be Performed

The SAR test shall be performed with both phone positions described above, on the left and right side of the phantom. The device shall be measured for all modes operating when the device is next to the ear, even if the different modes operate in the same frequency band.

For devices with retractable antenna the SAR test shall be performed with the antenna fully extended and fully retracted. Other factors that may affect the exposure shall also be tested. For example, optional antennas or optional battery packs which may significantly change the volume, lengths, flip open/closed, etc. of the device, or any other accessories which might have the potential to considerably increase the peak spatial-average SAR value. The SAR test shall be performed at the high, middle and low frequency channels of each operating mode. If the SAR measured at the middle channel for each test configuration is at least 2.0 dB lower than the SAR limit, testing at the high and low channels is optional.

Body-worn and Other Configurations

Phantom Requirements

For body-worn and other configurations a flat phantom shall be used which is comprised of material with electrical properties similar to the corresponding tissues.

Test Position

The body-worn configurations shall be tested with the supplied accessories (belt-clips, holsters, etc.) attached to the device in normal use configuration. Devices with a headset output shall be tested with a connected headset.

Test to be Performed

For purpose of determining test requirements, accessories may be divided into two categories: those that do not contain metallic components and those that do. For multiple accessories that do not contain metallic components, the device may be tested only with that accessory which provides the closest spacing to the body.

For multiple accessories that contain metallic components, the device must be tested with each accessory that contains a unique metallic component. If multiple accessories share an identical metallic component, only the accessory that provides the closest spacing to the body must be tested.

If the manufacturer provides none body-worn accessories a separation distance of 1.5 cm between the back of the device and the flat phantom is recommended. Other separation distances may be used, but they shall not exceed 2.5 cm. In these cases, the device may use body-worn accessories that provide a separation distance greater than that tested for the device provided however that the accessory contains no metallic components.

For devices with retractable antenna the SAR test shall be performed with the antenna fully extended and fully retracted. Other factors that may affect the exposure shall also be tested. For example, optional antennas or optional battery packs which may significantly change the volume, lengths, flip open/closed, etc. of the device, or any other accessories which might have the potential to considerably increase the peak spatial-average SAR value. The SAR test shall be performed at the high, middle and low frequency channels of each operating mode. If the SAR measured at the middle channel for each test configuration is at least 2.0 dB lower than the SAR limit, testing at the high and low channels is optional.

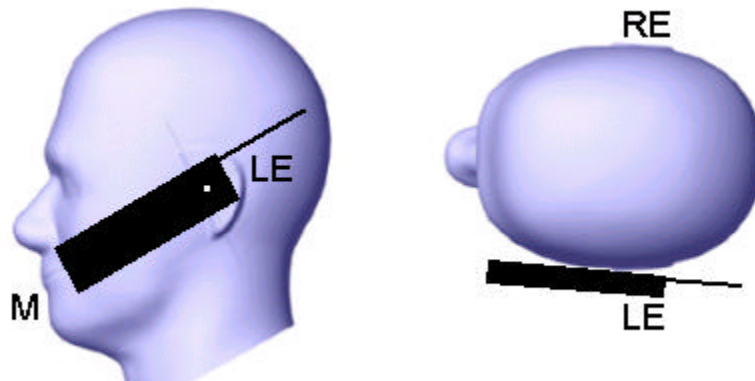

The cheek position.

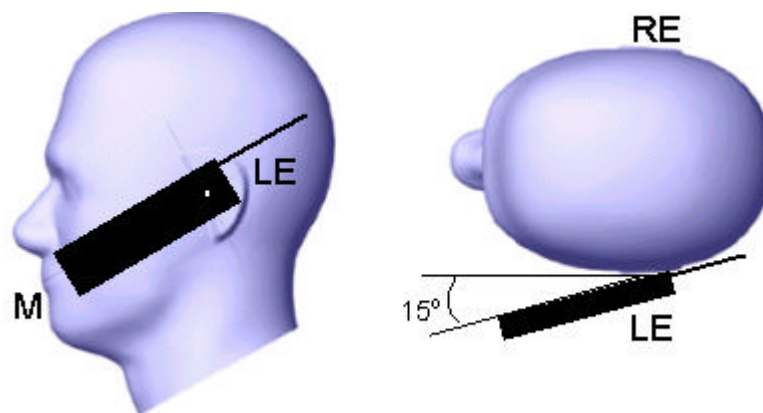

The tilted position

List of Terms and Abbreviations

AC	Alternating Current
ANSI	American National Standards Institute
Cal	Calibration
d	Measurement Distance
dB	Decibels
dBFA	Decibels above one microamp
dBV	Decibels above one microvolt
dBFA/m	Decibels above one microamp per meter
dBV/m	Decibels above one microvolt per meter
DC	Direct Current
E	Electric Field
EUT	Equipment Under Test
f	Frequency
FCC	Federal Communications Commission
CISPR	Comite International Special des Perturbations Radioelectriques (International Special Committee on Radio Interference)
GRP	Ground Reference Plane
H	Magnetic Field
Hz	Hertz
IEC	International Electrotechnical Commission
IEEE	Institute for Electrical and Electronic Engineers
kHz	kilohertz
kPa	kilopascal
kV	kilovolt
LISN	Line Impedance Stabilization Network
MHz	Megahertz
MPE	Maximum Permissible Exposure
FH	microhenry
FF	microfarad
Fs	microseconds
PRF	Pulse Repetition Frequency
RF	Radio Frequency
RMS	Root-Mean-Square
SAR	Specific Absorption Rate
TWT	Traveling Wave Tube
V/m	Volts per meter

END of Report
