



clarion®

Owner's manual & Installation manual
Mode d'emploi et manuel d'installation
Manual de instrucciones y de instalación



CZ702



CD/USB/MP3/WMA RECEIVER
LECTEUR CD/USB/MP3/WMA
RECEPTOR CD/USB/MP3/WMA



CLARION PRODUCT REGISTRATION INFORMATION

For USA and Canada only
www.clarion.com

Dear Customer:

Congratulations on your purchase of a Clarion mobile electronic products. We are confident that you'll enjoy your Clarion experience.

There are many benefits to registering your product. We invite you to visit our website at www.clarion.com to register your Clarion product.

We have made product registration simple with our easy to use website. The registration form is short and easy to complete. Once you're registered, we can keep you informed of important product information.

Register at www.clarion.com - it's easy to keep your Clarion product up to date.

INFORMATIONS DE L'ENREGISTREMENT DE PRODUITS CLARION

Pour les États Unis et le Canada seulement
www.clarion.com

Cher client:

Nous vous remercions d'avoir acheté ce produit électronique mobile Clarion. Nous sommes confiants que vous apprécierez votre expérience Clarion.

Il y a beaucoup d'avantage à enregistrer votre produits. Nous vous invitons à visiter notre site Web www.clarion.com pour enregistrer votre produit Clarion.

Nous avons facilité la tâche d'enregistrement de produit simple et facile grâce à notre site Web. Le formulaire d'enregistrement est court et facile à compléter. Lorsque vous êtes enregistrer, nous pouvons vous tenir informé des informations important de produits.

Enregistrer à www.clarion.com - c'est facile de mettre à jour votre produit Clarion.

INFORMACIÓN DEL REGISTRO DE PRODUCTO DE CLARION

Para USA y Canada nomas
www.clarion.com

Querido Cliente:

Felicitaciones por su compra de producto electrónico móvil de Clarion. Estamos seguros que usted gozará de su experiencia con el producto de Clarion.

Hay muchas ventajas al registrar su producto. Le invitamos a que visite nuestro sitio en internet www.clarion.com para registrar su producto de Clarion.

Hemos hecho el registro de producto fácil en nuestro sitio. La forma de registro es corta y fácil de completar. Una vez que lo registre, podremos proporcionarle la información de su producto.

Regístrese en www.clarion.com - es fácil mantener su producto de Clarion actualizado.

Contents

Thank you for purchasing this Clarion product.

- Please fully read this owner's manual before operating this equipment.
- Check the contents of the enclosed warranty card and store it in a safe place with this manual.

1. FEATURES	2
2. PRECAUTIONS	2
Front Panel / Generalities	3
USB Port	3
Remove the DCP	3
Attach the DCP	3
3. CONTROLS	4
Operational Panel	4
Names of Buttons	4
Remote Control (RCX001)	4
Notes of remote control using	4
4. CAUTIONS ON HANDLING	5
Handling Discs	5
5. OPERATIONS	5
Basic Operations	5
System Setup	6
Audio Setup	6
Radio Operations	6
HD Radio Operations	7
iTunes® Tagging	7
SiriusXM Satellite Radio Operations	8
CD/MP3/WMA Operations	10
USB Operations	11
iPod & iPhone Operations	11
AUX Operations	13
6. TROUBLE SHOOTING	13
7. ERROR DISPLAYS	14
8. SPECIFICATIONS	14
9. INSTALLATION / WIRE CONNECTION GUIDE	15

1. FEATURES

- **Compatible with iPod® / iPhone® with PANDORA® internet radio App**
- **Front Panel Auxiliary Input and 4ch RCA Output with Subwoofer Control**
- **BEAT-EQ with 3 Band Parametric Equalizer and MAGNA BASS EX Dynamic Bass Enhancement**



Expanding Systems

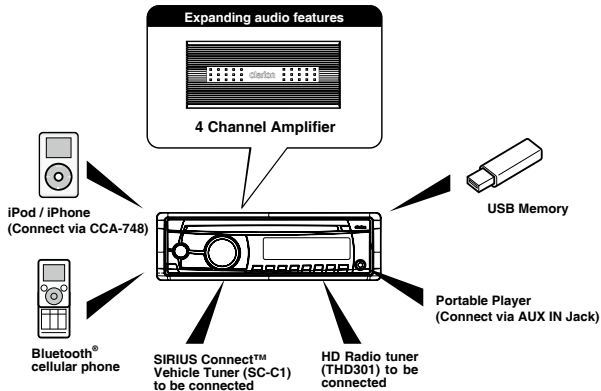

Note:

- The items listed outside of the frames are the commercial products generally sold.
- CCA-748: Sold by separately.

2. PRECAUTIONS

⚠ WARNING

For your safety, the driver should not operate the controls while driving. Also, while driving, keep the volume to a level at which external sounds can be heard.

- This unit uses precision parts and components for its operation. In the event that trouble arises, never open the case, disassemble the unit, or lubricate the rotating parts. Contact your **Clarion** dealer or service center.
- FCC STATEMENT**
 - This device complies with Part 15 of the FCC Rules. Operation is subject to the following two conditions:
 - (1) This device may not cause harmful interference.
 - (2) This device must accept any interference received, including interference that may cause undesired operation.
 - Changes or modifications not expressly approved by the party responsible for compliance could void the user's authority to operate the equipment.

NOTE: This equipment has been tested and found to comply with the limits for a Class B digital device, pursuant to Part 15 of the FCC Rules. These limits are designed to provide reasonable protection against harmful interference in a residential installation.

This equipment generates uses and can radiate radio frequency energy and, if not installed and used in accordance with the instructions, may cause harmful interference to radio communications. However, there is no guarantee that interference will not occur in a particular installation. If this equipment does cause harmful interference to radio or television reception, which can be determined by turning the equipment off and on, the user is encouraged to try to correct the interference by one or more of the following measures:

 - Reorient or relocate the receiving antenna.
 - Increase the separation between the equipment and receiver.
 - Connect the equipment into an outlet on a circuit different from that to which the receiver is connected.
 - Consult the dealer or an experienced radio/TV technician for help.

FCC Radiation Exposure Statement

This equipment complies with FCC radiation exposure limits set forth for an uncontrolled environment. This equipment should be installed and operated with minimum distance 20cm between the radiator & your body.

"Made for iPod," and "Made for iPhone" mean that an electronic accessory has been designed to connect specifically to iPod, or iPhone, respectively, and has been certified by the developer to meet Apple performance standards.

Apple is not responsible for the operation of this device or its compliance with safety and regulatory standards. Please note that the use of this accessory with iPod or iPhone may affect wireless performance.

iPhone and iPod are trademarks of Apple Inc., registered in the U.S. and other countries.
- Pandora, the Pandora logo and other Pandora marks are trademarks or registered trademarks of Pandora Media, Inc. or its subsidiaries worldwide.
- If you have any issues with the Pandora application on your mobile phone, please direct them to pandora-support@pandora.com.
- The Bluetooth® word mark and logos are registered trademarks owned by Bluetooth SIG, Inc. and any use of such marks by Clarion Co.,Ltd, is under license.

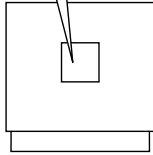

INFORMATION FOR USERS:

Changes or modifications to this product unapproved by the manufacturer will void the warranty and will violate FCC approval.

Front Panel / Generalities

For a longer service life, be sure to read the following cautions.

- Do not allow any liquids on the unit from drinks, umbrellas, etc. Doing so may damage the internal circuitry.
- Do not disassemble or modify the unit in any way. Doing so may result in damage.
- Do not let cigarettes burn the display. Doing so may damage or deform the body.
- If a problem should occur, have the unit inspected at your store of purchase.
- The remote control unit may not work if the remote control sensor is exposed to direct sunlight.

Cleaning the body

- Use a soft, dry cloth and gently wipe off any dirt or dust.
- For tough dirt, apply some neutral detergent diluted in water to a soft cloth, wipe off the dirt gently, then wipe again with a dry cloth.
- Do not use benzene, thinner, car cleaner, etc., as these substances may damage the body or cause the paint to peel. Also, leaving rubber or plastic products in contact with the body for long periods of time may cause stains.

USB Port

- The USB memory stick may stick out when inserted, so it may cause damage during driving. When connect USB memory stick to the main unit, please use a USB extension cable (CCA-755).
- The USB memory sticks must be recognized as "USB mass storage class" to work properly. Some models may not operate correctly.

When the memorized data is lost or damaged by any chance, Clarion shall not be liable for any damage.

When using a USB memory stick, we recommend that you backup your data stored on it before using a personal computer etc.

- Data files may be broken when using USB memory sticks in the following situation: When disconnecting the USB memory stick or turning the power off during reading data. When affected by static electricity or electric noise. Connect/disconnect the USB memory stick when it is not accessed.
- Connecting with the computer is not covered.

Remove the DCP

The control panel can be detached to prevent theft. When detaching the control panel, keep it in the safety place and prevent scratches. We recommend taking the DCP (DETACHABLE CONTROL PANEL) with you when leaving the car.

- Press the [SRC / \odot] button (1 sec.) to turn off the power.
- Deeply push in [OPEN] button to unlock the DCP.
- Hold the side popped out, remove the DCP.

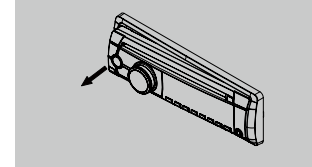

Attach the DCP

- Hold the DCP and ensure that the panel faces towards you. Set the right side of the DCP into the DCP bracket.
- Press the left side of the DCP until it locks.

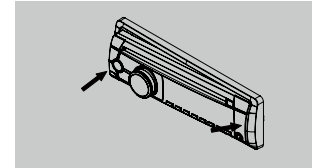

CAUTION

- The DCP can easily be damaged by shocks. After removing it, be carefully not to drop it or subject it to strong shocks.
- Once the [OPEN] button is pressed and DCP is unlocked, car vibrations can cause the DCP to fall.
- The connector for the main unit and DCP is extremely important. Be careful not to damage it by pressing on it with fingernails, screwdrivers, etc.

Note:

If the DCP is dirty, wipe off the dirt with a soft, dry cloth only.

3. CONTROLS

Operational Panel

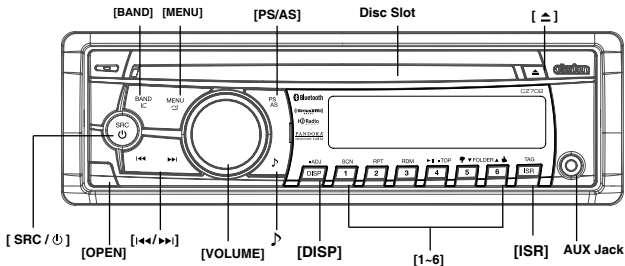

Names of Buttons

- [SRC / ⏏] Button**
 - Power / Toggle the audio source
 - Sound effect setting
- [BAND] Button**
 - Select tuner band(RADIO mode)
 - Skip(PANDORA mode)
- [MENU] Button**
 - MP3/WMA mode – Search function.
 - CD mode – No function.
 - RADIO mode – No function.
 - AUX mode – No function.
 - iPod mode – iPod menu
 - PANDORA mode – Station select
- [▲] Button**
 - Press to eject disc.
- [◀▶] Buttons**
 - Previous / next track
 - Search (long press)
 - Station up/down(PANDORA mode)
- [Open] Button**
 - Unlock the front panel.
- [PS / AS] Button**
 - Scan play / Preset scan
 - Auto memory store (long press)
- [▶] Button**
 - Play / Pause
- [VOLUME] Knob**
 - Adjust volume level / Confirm (press)
 - Bookmark (PANDORA mode)
- [ISR] Button**
 - Recall ISR station stored in memory and store current station in ISR memory (long press)
- [1-6] Buttons**
 - [1] Button: Scan play / Preset station 1 / Create new station(PANDORA mode)
 - [2] Button: Repeat play / Preset station 2.
 - [3] Button: Random play / Preset station 3.
 - [4] Button: Play / Pause / Top play (long press) / Preset station 4.
 - [5] Button: Previous folder / Preset station 5. 10 tracks down (long press) / Thumbs up(PANDORA mode)
 - [6] Button: Next folder / Preset station 6. 10 tracks up (long press) / Thumbs down(PANDORA mode)
- [DISP] Button**
 - Display switch
 - System setup (long press)

Remote Control (RCX001)

- [SRC / ⏏] Button**
 - Toggle the audio source
 - Power on / Power off (long press)
- [DISP] Button**
 - Display switch
- [RDM] Button**
 - Random play
 - Thumbs up (PANDORA mode)
- [RPT] Button**
 - Repeat play
 - Bookmark (PANDORA mode)
- [MUTE] Button**
 - Mute the volume
- [SCN/PS/AS] Button**
 - Scan play / Preset scan
 - Auto memory store (long press)
 - Thumbs down (PANDORA mode)
- [BAND/TOP] Button**
 - Select tuner band (RADIO mode)
 - Top play (long press-CD/MP3/WMA mode)
 - Skip (PANDORA mode)
- [▲, ▼] Buttons**
 - Volume up / down
- [▶] Button**
 - Play / Pause
- [ISR] Button**
 - Recall ISR station stored in memory and store current station in ISR memory (long press)

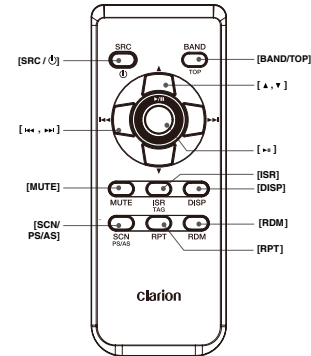

Notes of remote control using

1. Aim the remote control at the remote sensor on the unit.
2. Remove the battery from the remote control or insert a battery insulator if the battery has not been used for a month or longer.
3. DO NOT store the remote control under direct sunlight or in high temperature environment, or it may not function properly.
4. Use "button shaped" lithium battery "CR2025" (3V) only.
5. DO NOT subject battery to recharge, disassemble, heat or dispose in fire or water.
6. Insert the battery in proper direction according to the (+) and (-) polarities.
7. Store the battery in a place where children cannot reach to avoid the risk of accident.

Inserting the Battery

1. Slide remote control unit's rear cover in the direction shown.
2. Insert battery (CR2025) into insertion guides with printed side (+) up.
3. Press battery into compartment as shown.
4. Replace and slide cover until it clicks into place.



4. CAUTIONS ON HANDLING

Handling Discs

Handling

- New discs may have some roughness around the edges. If such discs are used, the player may not work or the sound may skip. Use a ball-point pen or the like to remove any roughness from the edge of the disc.

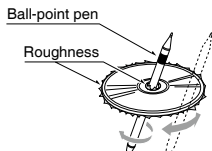

- Never stick labels on the surface of the disc or mark the surface with a pencil or pen.
- Never play a disc with any cellophane tape or other glue on it or with peeling off marks. If you try to play such a disc, you may not be able to get it back out of the player or it may damage the player.
- Do not use discs that have large scratches, are misshapen, cracked, etc. Use of such discs may cause misoperation or damage.
- To remove a disc from its storage case, press down on the center of the case and lift the disc out, holding it carefully by the edges.
- Do not use commercially available disc protection sheets or discs equipped with stabilizers, etc. These may damage the disc or cause breakdown of the internal mechanism.

Storage

- Do not expose discs to direct sunlight or any heat source.
- Do not expose discs to excess humidity or dust.
- Do not expose discs to direct heat from heaters.

Cleaning

- To remove fingermarks and dust, use a soft cloth and wipe in a straight line from the center of the disc to the circumference.
- Do not use any solvents, such as commercially available cleaners, anti-static spray, or thinner to clean discs.
- After using special disc cleaner, let the disc dry off well before playing it.

On Discs

- Never turn off the power and remove the unit from the car with a disc loaded.

CAUTION

For your safety, the driver should not insert or eject a disc while driving.

5. OPERATIONS

Basic Operations

Note:

- Refer to the diagrams in "3. CONTROLS" when reading this chapter.

CAUTION

When the unit is turned on, starting and stopping the engine with its volume raised to the maximum level may harm your hearing.

Be careful about adjusting the volume.

Power on / off

Notes:

- Start the engine before using this unit.
 - Be careful about using this unit for a long time without running the engine. If you drain the car's battery too far, you may not be able to start the engine and this can reduce the service life of the battery.
- Start the engine. The power button / knob illumination on the unit will light up.



- Press the [SRC / Φ] button on the front panel or the remote control to turn on the power under standby mode. The unit goes back to the last status after power on.
- Press and hold the [SRC / Φ] button on the front panel or the remote control to turn off the power.

Mute

Press the [MUTE] button on the remote control to mute the volume from the unit.

Note:

Doing the operation above again or adjusting volume will release muting.

Volume adjustment

Turn the [VOLUME] knob on the front panel or press the [▲] or [▼] button on the remote control.

The adjustable range of volume is 0 to 40.

CAUTION

While driving, keep the volume level at which external sounds can still be heard.

Playing source selection

Press [SRC / Φ] button on the front panel or remote control repeatedly to choose desired playing source.

Notes:

Playing source selection means selecting which mode, such as DISC mode, RADIO mode and AUX mode.

Display system time

Press the [DISP] button on the front panel or [DISP] button on the remote control to switch the display information from clock, station information (radio mode), or track information (CD mode).

RESET

Note:

* When the [RESET] button is pressed, preset radio stations, titles, etc. stored in memory are cleared.

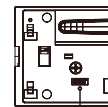

RESET

System Setup

In any mode, press and hold [DISP] button to enter system setup. Press [◀] or [▶] button to select options, rotate the [VOLUME] knob to adjust.

CLOCK

Press the [VOLUME] knob to enter clock setting mode, rotate the [VOLUME] knob to set clock, press [◀] or [▶] button to select hour or minute, press and hold the [VOLUME] knob to confirm.

DX/LO (RADIO mode)

Rotate the [VOLUME] knob to choose radio local or distant at RADIO mode.

- **LO:** Only stations with strong signal can be received.
- **DX:** Stations with strong and weak signals can be received.

AUX SENS (AUX mode)

Rotate the [VOLUME] knob to choose AUX Input sensitivity LOW, MID or HIGH at AUX mode.

SCRN SVR: ON/OFF

Rotate the [VOLUME] knob to choose SCR N SVR (screen saver) ON or OFF.

SCROLL: ON/OFF

For track information that is longer than the display panel:

When SCROLL is ON, the LCD will scroll the ID3 TAG information across the display, e.g.: TRACK->FOLDER->FILE->ALBUM->TITLE->ARTIST->TRACK->...

When SCROLL is OFF, the LCD will display one of the ID3 TAG information, the default is

TRACK, but user can adjust it to other ID3 TAG information by press [DISP] button.

S-CTRL (IPOD mode) : ON/OFF

Rotate the [VOLUME] knob to choose S-CTRL (Simple control) ON or OFF.

* Refer to P9.

DIMMER: ON/OFF

Rotate the [VOLUME] knob to choose DIMMER ON or OFF.

ON: LCD dimmer is active when small light of vehicle is turned ON.

• **OFF:** LCD always maximum brightness regardless of the vehicle small light.

PANDORA: ON/OFF

Select OFF if the PANDORA application has not been installed on your iPod touch or iPhone.

REAR/S-W

Rotate the [VOLUME] knob to choose REAR or S-WOOFER (SUB-WOOFER).

BEEP: ON/OFF

Rotate the [VOLUME] knob to choose button beep sound ON or OFF.

12/24H

Rotate the [VOLUME] knob to choose time format: 12 or 24 hours.

Rotate the [VOLUME] knob to change the CUSTOM, and press the [VOLUME] knob, the press [◀] or [▶] button to select it including: BAS-G -> BAS-F -> BAS-Q -> MID-G -> MID-F -> MID-Q -> TRE-G -> TRE-F, rotate the [VOLUME] knob to select a

Audio Setup

value.

BAS-G / MID-G / TRE-G: (-7) - (+7)

BAS-F: 60 / 80 / 100 / 200

BAS-Q: 1.0 / 1.25 / 1.5 / 2.0

MID-F: 500 / 1K / 1.5K / 2.5K

MID-Q: 0.5 / 0.75 / 1.00 / 1.25

TRE-F: 10.0K / 12.5K / 15.0K / 17.5K

Press the [] button, then press [◀] or [▶] button to select USER preset

including:

BALANCE -> FADER -> M-B EX -> LPF (low

pass filter) -> S-W VOL (Subwoofer Volume),

rotate the [VOLUME] knob to select a value.

BALANCE:LEFT 1-7->CENTER->RIGHT 1-7

FADER:FRONT 1-7->CENTER->REAR 1-7

M-BEX: ON/OFF

LPF: THROUGH/80/120/160

SUBW VOL: (-6)-(+6)

Radio Operations

Select tuner as playing source

Press [SRC /] button once or more to enter RADIO mode.

Selecting the radio band

Press the [BAND] button on the panel or on the remote control to select one radio band among FM1, FM2, FM3, AM.

Manual tuning

During manual tuning, the frequency will be changed in steps.

Press the [◀] or [▶] button on the panel to tune in a higher / lower station.

Press the [◀] or [▶] button on the remote control to select preset stations.

Auto tuning

Press and hold the [◀] or [▶] button to seek a higher / lower station.

To stop searching, repeat the operation above or press other buttons having radio functions.

Note:

When a station is received, searching stops and the station is played.

Preset scan

Preset scan receives the stations stored in preset memory in order. This function is useful when searching for a desired station in memory.

1. Press the [PS/AS] button.
2. When a desired station is tuned in, press the [PS/AS] button again to continue receiving that station.

Note:

Be careful not to press and hold the [PS/AS] button for 1 second or longer, otherwise the auto store function will begin and the unit starts storing stations.

Auto store

Only stations with sufficient signal strength will be detected and stored in the memory. Press and hold the [PS/AS] button (1 sec.) to start automatic station search.

To stop auto store, press other buttons having radio functions.

Notes:

1. After auto store, the previous stored stations will be overwritten.
2. The unit has 4 bands, such as FM1, FM2, FM3 and AM. FM3 and AM can store by AS function. Each bands can store 6 stations, CZ302 can store 24 stations in total.

Manual store

When one expected radio station has been detected, press and hold number button 1-6 to store it in the memory.

Recall the stored stations

Press one numeric button among 1 to 6 on CZ702

Radio Operations

the panel to select the corresponding stored station.

Local seeking

When LOCAL seeking is ON, only those radio stations with strong radio signal could be received.

To select LOCAL function, press and hold the [**DISP**] button on the front panel, then

press [**▶▶**] button repeatedly until **LO** or **DX** displays on the screen, and rotate the [**VOLUME**] knob to select Local or Distant mode.

Note:

The number of radio stations that can be received will decrease after the local seeking mode is ON.

HD Radio Operations

About HD Radio™ Technology

HD Radio Technology allows CD-quality digital broadcasting of your local AM and FM radio stations. HD Radio broadcasts can include multiple channels on the same frequency, which is called multicasting. With multicasting, you can receive up to eight additional multicast channels: HD1-HD8.

With an HD Radio tuner connected, you will receive HD Radio digital broadcasts automatically when tuned to a station that offers HD Radio Technology.

NOTE: Not all FM or AM stations offer HD Radio (digital) broadcasting. You can receive both analog and digital stations with the unit.

Accessing radio mode

Press the [**SRC** / **⏮**] button on the front panel or remote control to switch to the HD RADIO source, and HD icon will illuminate.

Select a band

Press the [**BAND**] button to change between three FM and one AM bands. Each band stores up to six preset stations.

Tuning

- Seek Tuning

Press and hold the [**◀▶**] or [**▶▶**] button to seek the next/previous station automatically.

- Manual Tuning

Press the [**◀▶**] or [**▶▶**] button to move the radio frequency number up or down one step.

HD Radio multicast channels

To tune to an HD Radio multicast channel, tune to the main signal and then press the [**MENU**] button on the panel. **PTY** and **SUB CH** are displayed. Select **PTY** or **SUB CH** by rotate [**VOLUME**] knob and push to confirm.

- Select **PTY** type from the category list by rotate [**VOLUME**] knob and push.
- Select **SUB CH** by rotate [**VOLUME**] knob and push.
- Multi channel is available when a digital signal is detected, the **DIGITAL** icon will illuminate. If the digital signal becomes

Preset stations

Up to six stations on each band can be stored as presets, which can then be instantly recalled by pressing the associated preset button. To store a station, turn the radio on and select the desired band and station. Press and hold the desired preset button (numbered one through six on the face of the radio or remote control) for more than 1 second. When stored, the preset number will appear in the display. The station is now stored and can be recalled by pressing the corresponding preset button. Repeat for the remaining five presets on the current band and for presets on the other four bands.

HD Radio Operations

NOTE: Multicast stations can be stored as presets, but the unit must be in Digital or Auto reception mode to receive them.

Preset scan

Press the [**PS/AS**] button to scan and play all preset stations for 10 seconds each. Press [**PS/AS**] again to stop scanning and play the current station.

Note:

Be careful not to press and hold the [**PS/AS**] button for 1 second or longer, otherwise the auto store function is engaged and the unit starts storing stations.

iTunes® Tagging

The CZ501 offers iTunes® Tagging, which allows the user to "Tag" songs playing on HD Radio™ stations for purchase later through iTunes. When press [**ISR**] button, the unit stores the title and artist song information that can then be transferred to your iPod when connected to the unit. A list titled "Tagged" will appear in iTunes, allowing you the option to purchase your tagged songs.

Note:

"iTunes® Tagging" function works by connecting THD301 (sold separately).

iPod compatibility

For detailed information on the playable iPod models, see our home page: www.clarion.com

Note:

- iPhones can also be connected to this system and "iPod" appearing in this manual should be referred to as "iPod/iPhone".
- This system will not operate or may operate improperly with unsupported versions.

Tagging music

To begin tagging music, tune to an HD Radio station. The **DIGITAL** icon at the display must

Automatic store (AS)

Press and hold the [**PS/AS**] button (1 sec.) to select six strong stations and store them in the FM3 or AM band using the Auto Store feature. After entering the stations into memory, the unit will automatically stop at each station for five seconds, allowing you to preview each selection. When using the Auto Store feature, the new stations replace any stations already stored in preset memory.

Note:

You can stop the Auto Store function at any time by pressing the [**PS/AS**] button again.

be illuminated, indicating a digital station is being received. **TAG** icon lights up when Tagging function is ready. Press the [**ISR**] button on the unit. The tagging function is highly depends on the receptions of the radio station. If the channel reception is insufficient, it will effect the operation of the tagging function.

"**Stored Tag ## of 64**" will appear in the display. The song information is saved to the unit memory until an iPod is connected. You can tag up to 64 songs before the tags must be transferred to an iPod or deleted. When the Tag memory reaches capacity (64 tags) the bottom of the screen displays "**Memory Full**".

Table 5: TAG Messages

Tag Message	Reason
STORED TAG ## OF 64	If the Tag data is ready, and [ISR] button is pressed
SENDING TAG ##	Tag data is sending to iPod
MEMORY FULL	Tag storage is full
TAG DATA IS NOT AVAILABLE	Tag data is not available
IPOD FULL	iPod memory is full
TAG NOT SUPPORT	When connect and press [ISR] button, the iPod without Tagging function

iTunes® Tagging

Note:

Tags saved to your iPod can be managed using the iTunes software, available at www.apple.com/itunes.

Downloading tags to your iPod

To download tags to your iPod, plug an iPod into the unit. All existing tags are automatically transferred to the iPod and deleted from the head unit's memory. If an iPod is connected when a song is tagged, the Tag will be immediately transferred to the iPod.

Note:

When transferring Tags to an iPod, the unit must remain in HD Radio mode. To purchase tagged songs, you must sync your iPod to iTunes and then click the "Tagged" list on the left side of the iTunes software screen. Click the "view" button for purchasing information.

Note:

- How to enter the iTunes tagging function? "TAG" and "DIGITAL" light up when Tagging function is ready, press [ISR] button to start iTunes Tagging.
- What is seen on the radio's display to let me know I have tagged the tune? Press [ISR] button to show "STORED TAG ## OF 64". After connect to a iPod, the display shows "SENDING TAG ##". If no connection, the display will show "STORED TAG ## OF 64". You could save 64 Tag into memory in total. When you connect to a iPod, Tag information will be saved in the iPod, and the data in memory will be cleared.
- Then how do I get the tagged tune from my iPod to the computer? If you have install iTunes, connect your iPod to your computer and buy songs online.

SiriusXM Satellite Radio Operations

SiriusXM Tuner operation:

When a SiriusXM Tuner is connected to this unit, the following operations may performed.

Receiving Channels with the SiriusXM Tuner

About SiriusXM Satellite Radio

Everything worth listening to is on SiriusXM. get over 130 channels, including the most commercial-free music, plus the best sports, news, talk and entertainment. A SiriusXM Tuner and Subscription are required. For more information, visit www.siriusxm.com.

Notes:

- The SiriusXM Tuner Satellite Radio controls on this unit are available only when a SiriusXM Tuner is connected.
- Press [SRC /] button to activate the Satellite Radio(SIRIUSXM) mode.
 - Press[] or [] to select the desired channel.

Holding down [] or [] will rapidly b r o w s e through the channels. alternatively you can enter the number of the desired channel using the numeric keypad on an optional remote control.

Checking the SiriusXM Radio ID Number

To subscribe to the SiriusXM Satellite Radio service, it is necessary to locate and identify the Radio ID of your SiriusXM Tuner. The Radio ID contains 8 characters and can be found on the bottom of your SiriusXM Tuner or can be displayed on when selecting Channel 0 by following the steps below:

- While in the Satellite Radio Mode, press [] or [] to select channel "0". The unit displays "RADIO ID" and ID number alternately.

SiriusXM Satellite Radio Operations

Notes:

- The Radio ID does not include the letters I, O, S or F.
- To cancel the ID number display, select a channel other than "0".

Storing Channel Presets

- Press [BAND] to select the desired band you want to store the preset in. There are 3 Satellite Radio Preset bands. Each press of [BAND] changes the band: SXM1 -> SXM2 -> SXM3 -> SXM1
- Tune to the desired channel and then press and hold one of the preset buttons (1 through 6), for at least 2 seconds, to store the channel. The display then shows the stored Band and preset number (for example, SXM1-3 is shown when preset 3 of band 1 is selected).
- Repeat the procedure to store up to 5 other channels on to the same band.

Notes:

- A total of 18 channels can be stored in the preset memory, 6 channels for each band (SXM1, SXM2 and SXM3).
- If you store a new channel into a preset which the new one.

Tuning Channels using Presets

- Press [BAND] to select the desired band of Presets you wish to access.
- Press the preset buttons (1 through 6) that has your desired Satellite Radio channel stored in memory.

Category Browsing

- Press [] or [] in the select the SiriusXM mode to activate the Category Browsing mode.
- Press [] or [] to select desired category.
- Rotate the [VOLUME] knob to select to desired channel within the selected Category, and then press [VOLUME] enter.

Notes:

- If no operation is performed for 10 seconds, the Category Browsing mode is canceled.

Tuning Channels using Presets

While listening to SiriusXM Satellite Radio, you can be alerted when your favorite songs or artists are playing on other channels. An interruption ALERT will be displayed when a matching artist or song is found on another channels.

- Press and hold FUNC./VIEW for at least 2 seconds when a Song or the song of an Artist you want to store is playing. The [F] indicator lights up.
- Press the 1 (preset) button to store the Artist/Song. A note to memorize the ART(artist name) or the SNG(song title) is displayed.

Notes:

- If either the artist or song title is not available to save, UNAVAILABLE will be displayed.
- Rotate the [VOLUME] knob to choose SAVE ART or SAVE SNG(when available) and then press [VOLUME] knob enter.
- The new alert was stored in memory. An "ART/SONG SAVED" pop-up screen is following by a "X U(sed)/Y E(mpty)". X is the total number of song titles or artist names stored in memory, and Y is the total number of memory locations still available for storage.

Notes:

- If you try to store when memory is full, "MEM FULL" is displayed followed by "REPLACE/CANCEL". If you want to replace an existing alert item, select "REPLACE" by rotating the [VOLUME] knob, and then press [VOLUME] enter, the existing alert list stored in memory is displayed. Select one of the stored alerts using the [VOLUME] knob. To replace the selected alert, press [VOLUME] knob and an "ART/SONG SAVED" pop-up screen is followed by an "X U(sed)/Y E(mpty)".
- You can manage the stored Alert memory setting on steep mode.
- If no operation is performed for 10 seconds, the setting mode is canceled.

Receiving and Tuning to an Alert

Whenever a stored sports team, artist, or song is playing on another channel, an interruption ALERT appears on the unit display. To tune to game, artist or song identified by the alert, follow the steps below:

- Rotate the [VOLUME] knob to select the desired game, artist or song from the list of active alerts.
- Press [VOLUME] knob enter.

SiriusXM Satellite Radio Operations

Notes:

- If no operating is performed for 5 seconds, the unit returns to normal mode.
- Sports teams/Artist name and Song title which you have stored and which are currently playing will be displayed in a category called "MY GAMES"/"MY MUSIC" in search mode.

Search Function

You can search for SiriusXM programming content by Category or by Channel.

1. Press [VOLUME] knob in the SiriusXM mode.
2. Rotate the [VOLUME] knob to select the desired Category/Channel, and then press [VOLUME] knob enter.

Notes:

- During channel search, pressing [▲] or [▼] to select another Category.

Receiving and Tuning to an Alert

1. When SiriusXM mode, select your favorite SiriusXM Channel.
2. Press and hold [▶|] for at least 2 seconds. The channel you selected is stored as the jump Source.
3. Press and hold [▲] for at least 2 seconds to recall and tune to the saved jump Source channel.

Notes:

- Pressing and holding [▲] again for at 2 seconds will jump back to the previous mode or SiriusXM channel.

Instant Replay Function

When SiriusXM mode, you can pause, rewind and replay up to 30 minutes of live SiriusXM Satellite Radio.

1. While listening to a SiriusXM channel, press [▶|] to enter the Replay mode, which mutes the audio. The display will show "PAUSE" while in this mode.
2. Press [▶|] again to resume playback of the stored audio from the point at which it was paused. During playback, the SiriusXM Tuner will continue to store the channel audio until you exit the Instant Replay mode (up to 30 minutes).

During REPLAY playback:

- Fast rewind: Press and hold [◀◀].
- Fast forward: Press and hold [▶▶].
- Returning to the beginning of the current song: Press [◀◀]. (If you press [◀◀] in the first 2 seconds of a song, you return to the beginning of the previous song.)
- Advancing to the beginning of the next song: press [▶▶].

Notes:

- If you continue to press Fast forward until the end, the Instant Replay mode is canceled, and the unit will change to live SiriusXM radio mode.
- If you change channels while in Replay mode, the unit will exit Replay mode to live Satellite Radio mode and clear the Replay memory.

Using iTunes tagging

iTunes Tagging lets you tag songs you hear on SiriusXM channels with your new CZ702 and then preview, buy, and download them later from your iTunes Tagged playlist the next time you sync your iPod/iPhone.

Notes:

- For details on the iPod/iPhone modes usable with this unit, refer to "Connecting an iPod/iPhone" on page 9.

1. A song may be tagged while listening to a SiriusXM channel if the display shows the "Tag" icon.
2. Press and hold Tag for at least 2 seconds while the desired song is playing. The "Tag" blinks at the same time the "TAGGING" is displayed.
3. When completed, "TAG STORED" is displayed and the "Tag" indicator lights up.

Notes:

- During tagging, the iPod/iPhone takes priority to save the tag information. If no iPod/iPhone is connected, the tag information is saved to this unit.
- When the memory of iPod/iPhone is full, "iPod FULL" is displayed. The tag information will be stored to the unit.
- If the tagging operation is interrupted by a source or channel change, the tagging operation will be canceled and the unit

SiriusXM Satellite Radio Operations

may not display "CANNOT TAG".

- This unit can store up to 50 pieces of tag information. When the memory of the unit is full, "MEMO FULL" may be displayed.
- When iPod/iPhone that doesn't support the tagging function is connected, "NON-TAGGING IPOD" may be displayed.
- When the iPod/iPhone is disconnected from the unit during tagging, its tag information will be stored in the unit.
- If there is stored tag information on the unit, when an iPod/iPhone supporting the tag function is connected, the stored tag information will be transferred to be iPod/iPhone automatically. When the iPod/iPhone memory becomes full, "iPod FULL" will be displayed, and any remaining tag information on the unit will not be transferred to the iPod/iPhone.
- If tag information already exists, "ALREADY TAGGED" will be displayed when you try to tag information again.
- Tagging may be canceled by changing the frequency or station, and the message "CANNOT TAG", etc. may not be displayed.
- If a song is tagged and the remaining storage volume of the connected iPod/iPhone is sufficient to hold the song's tag information, it will be saved on the iPod/iPhone.

- If there is stored tag information on CZ702, when iPod/iPhone models supporting the tag function are connected, the Tag information will be transferred to be the iPod/iPhone with which the USB terminal is activated automatically. When the iPod/iPhone memory becomes full, "iPod FULL" will be displayed, and any remaining tag information on the unit will not be transferred to be iPod/iPhone.

Changing the Display

Text information, such as the channel name, artist name/feature and song/program title, is available with each SiriusXM channel. The unit can display this text information as explained below.

1. In SiriusXM mode, press VIEW.

Each time you press this button, the display changes as shown below.
Band/channel Number -> Clock -> Channel Name* -> Artist Name* -> Song Title* -> Content info.* -> Category Name* -> Band/Channel Number

- * If there is no text information, nothing will be displayed.

CD/MP3/WMA Operations

This unit can playback MP3/WMA files

Notes:

- If you play a WMA file with active DRM (Digital Rights Management), there will be no audio.

To disable DRM

(Digital Rights Management)

When using Windows Media Player 9/10/11, click on Tool -> Options -> Copy Music tab, then under Copy settings, unclick the Check box for copy project music. Then, reconstruct files.

Personally constructed WMA files are used at your own responsibility.

Precautions when creating MP3/WMA file

Usable sampling rates and bit rates

- MP3: Sampling rate 8 kHz-48 kHz, Bit rate 8 kbps-320 kbps / VBR
- WMA: Bit rate 8 kbps-320 kbps

File extensions

- Always add a file extension ".MP3", ".WMA" to MP3, WMA file by using single byte letters. If you add a file extension other than specified or forget to add the file extension, the file cannot be played.
- Files without MP3/WMA data will not play. The files will be played soundlessly if you attempt to play files without MP3/WMA data.

* When VBR files are played, the play time display may differ the play location.

* When MP3/WMA files are played, a little no sound part is caused between tunes.

Logical format (File system)

- When writing MP3/WMA file on a CD-R disc or CD-RW disc, please select "ISO9660 level 1, 2 or Joliet" or Apple ISO as the writing software format. Normal play may not be possible if the disc is recorded on another format.

- The folder name and file name can be displayed as the title during MP3/WMA play but the title must be within 32 single byte alphabetical letters and numerals (including an extension).
- Do not affix a name to a file inside a folder having the same name.

Folder structure

A disc with a folder having more than 8 hierarchical levels will be impossible.

Number of files or folders

- Up to 999 files can be recognized per folder.

Up to 3000 files can be played.

- Tracks are played in the order that they were recorded onto a disc. (Tracks may not always be played in the order displayed on the PC.)
- Some noise may occur depending on the type of encoder software used while recording.

Eject function

Just pressing the [] button, ejects the disc.

Notes:

- If you force a CD into before auto reloading, this can damage the CD.
- If a CD (12 cm) is left ejected for 15 seconds, the CD is automatically reloaded (Auto reload).

Listening to a disc already loaded in the unit

Press the [SRC / ] button to select the CD/MP3/WMA mode.



When the unit enters the CD/MP3/WMA mode, play starts automatically.

Loading a CD

Insert a CD into the center of the CD SLOT with label facing up. The CD plays automatically after loading.

Notes:

CD/MP3/WMA Operations

- Never insert foreign objects into the CD SLOT.
- If the CD is not inserted easily, there may be another CD in the mechanism or the unit may require service.
- Discs without the  or  mark and CD-ROMs cannot be played by this unit.
- Some CD-R/CD-RW discs may not be usable.

Pausing play

- Press the [4] button to pause play. "PAUSE" appears in the display.
- To resume CD play, press the [4] button again.

Displaying CD titles

This unit can display title data for MP3/WMA disc.

When SCROLL is OFF, each time you press the [DISP] button to change the title display.

MP3/WMA disc



Track -> Folder -> File title -> Album -> Title -> Artist -> Track ...

Notes:



- If MP3/WMA disc has no ID3 TAG., "NO TITLE" appears in the display.
- Only ASCII characters can be displayed in Tags.

Selecting a track

Track-up

- Press the [] button to move ahead to the beginning of the next track.
- Each time you press the [] button, the track advances ahead to the beginning of the next track.
- For MP3/WMA disc, press and hold the [6] button (1 sec.) to move ahead to +10 tracks.

Track-down

- Press the [] button to move back to the beginning of the current track.
- Press the [] button twice to move

back to the beginning of the previous track.

- For MP3/WMA disc, press and hold the [5] button (1 sec.) to move back to -10 tracks.

Fast-forward/Fast-reverse

Fast-forward

Press and hold the [] button .



Fast-reverse

Press and hold the [] button .

* For MP3/WMA discs, it takes some time until the start of searching and between tracks. In addition, some errors may occur in the play time.

Folder Select

This function allows you to select a folder containing MP3/WMA files and start playing from the first track in the folder.

- Press the [5] or [6] button. Press the [6] button to move the next folder. Press the [5] button to move the previous folder.
- To select a track, press the [] or [] button.

Search Function

- Press the [MENU] button to enter FOLD SCH mode. Press the [VOLUME] button to enter the folder list search mode.
- Turn the [VOLUME] knob to select a folder.
- Press the [VOLUME] button to enter the file list search mode. And then the track list appears in the display.
- Turn the [VOLUME] knob to select a track.
- Press the [VOLUME] knob to play.
 - When play back MP3 / WMA file, this function is performed in the current folder.

Top function

The top function resets the CD player to the first track of the disc. Press and hold the [4] button (1 sec.) to play the first track (track No. 1) on the disc.

* In case of MP3/WMA, the first track of the current folder will be played.

CD/MP3/WMA Operations

Other various play functions

Scan play

This function allows you to locate and play the first 10 seconds of all the tracks recorded on a disc.

Press the [1] button to perform scan play.

Repeat play

This function allows you to play the current track repeatedly or play a track currently being played in the MP3/WMA folder repeatedly.

CD:

1. Press the [2] button once or more until "RPT ON" appears on the LCD to perform repeat play.
2. Press [2] button again to cancel repeat playback, "RPT OFF" appears on the LCD.

MP3/WMA:

1. Press the [2] button once or more until "TRACK RPT" appears on the display to perform repeat play, and "RPT" segment lights on.
2. For MP3/WMA files, press [2] button repeatedly until "FOLD RPT" appears on the display for folder repeat play.

USB Operations

1. Open the cover of the USB connector to the right. Insert a USB cable (CCA-755) into the USB connector. Insert a USB device into the USB cable.

When connecting a USB device, the unit will read the files automatically.

2. To remove the USB device, you should first select another source or turn off the power, in order to avoid damaging the USB device. Then take off the USB device. Open the cover to the left.

3. Operation is same as MP3/WMA operation.

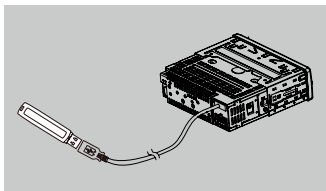

3. Press [2] button repeatedly until "RPT OFF" appears on the display to cancel repeat playback, and "RPT" segment goes off.

Random play

This function allows you to play all tracks recorded on a disc in a random order.

Press the [3] button to perform random play.

iPod & iPhone Operations

Connect

Connect an iPod or iPhone to the USB connector via CCA-748 cable.

When connecting a device, the unit will read the files automatically. The track information display on the screen once playback start.

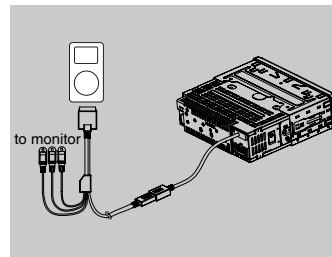

MENU

In the S-CTRL OFF mode, press [MENU] button, rotate the [VOLUME] knob select "MUSIC" or "VIDEO".

Select "MUSIC", press the [VOLUME] knob, then rotate the [VOLUME] knob to show PLAY LISTS / ARTISTS / ALBUMS / GENRES / SONGS / COMPOSERS, press and rotate the [VOLUME] knob to select a desired option, then press the [VOLUME] knob to confirm.

Select "VIDEO", press the [VOLUME] knob, then rotate the [VOLUME] knob to show MOVIES / MUSIC VIDEO / TV SHOWS / VIDEO PODCASTS / RENTALS, press and rotate the [VOLUME] knob to select a desired option, then press the [VOLUME] knob to confirm.

NOTE:

- VIDEO MENU item is different by the model of connected iPod and language setting.

Repeat play

This function allows you to play the current track repeatedly or play all tracks in your iPod/iPhone repeatedly.

1. Press the [2] button once or more until "RPT ON" appears on the LCD to perform repeat play.
2. Press [2] button repeatedly until "RPT OFF" appears on the LCD to cancel repeat playback.

Random play

This function allows you to play all tracks recorded on a disc in a random order.

1. Press [3] button repeatedly until "ALBUM RDM" appears on the LCD for album random play.
2. Press the [3] button once or more until "SONG RDM" appears on the LCD to perform random play.
3. Press [3] button repeatedly until "RDM OFF" appears on the LCD to cancel random playback.

Setting iPod simple control mode

Use this function if you wish to operate through your iPod connected to this unit via the USB cable.

* The factory default setting is "OFF".

1. Press and hold [DISP] button to enter system setup.
2. Press [I◀◀] or [▶▶] button to select "S-CTRL".
3. Rotate the [VOLUME] knob to select "ON" or "OFF".
 - ON: Operations are made through your iPod.
 - OFF: Operations cannot be made through your iPod.

Notes:

- When performing iPod operations using simple control mode, make the operations slowly. If repetitive operations are performed too quickly, unforeseen errors may occur.
- When performing iPod operations using simple control mode, please do not operate

iPod & iPhone Operations

the iPod and the unit at the same time, otherwise there may be unexpected event happened.

- Some iPod models do not support this function. Consult your nearest Clarion dealer or website to confirm which models do not support this function.

iPod menu alphabet search

This function searches the subfolders for desired alphabetical letters.

- Press the [MENU] button to select the iPod menu mode.
- Press the [VOLUME] knob to switch between categories.
MUSIC: PLAYLIST, ARTISTS, ALBUMS, GENRES, SONGS, COMPOSERS

Bluetooth Operations

The Bluetooth allows you to utilize your car's built-in audio system for wireless mobile phone or music handsfree communication. Some Bluetooth mobile phones have the audio features, and some portable audio players support Bluetooth feature. This system can play audio data stored in a Bluetooth audio device. The car stereo with Bluetooth will be able to retrieve phonebook contacts, received call, dialed call, missed call, incoming calls, outgoing call and listen to music.

Note:

- Do not leave the microphone of Bluetooth handsfree in the places with wind passing such as air outlet of the air conditioner, etc. This may cause a malfunction.
- If leave it in the places subjected to direct sun, high temperature can cause distortion, discoloration which may result in a malfunction.
- This system will not operate or may operate improperly with some Bluetooth audio players.
- Clarion cannot guarantee the compatibility of

- VIDEO: MOVIES, MUSIC VIDEOS, TV SHOWS VIDEO PODCASTS, RENTALS
- Press the [VOLUME] knob. (The contents of the category are displayed.)
 - Press and hold the [DISP] button (1 sec.).
 - Rotate the [VOLUME] knob to select the desired letter to search.
 - Press the [DISP] button again to next perform search.
 - Press the [VOLUME] knob to confirm.

- all mobile phones together with unit.
- Audio playback will be set to the same volume level as set during telephone call. This might cause problems, if extreme volume level is set during telephone call.

Handsfree Operations

Pairing

- Turn on Bluetooth function of your mobile phone.
- Enter mobile phone's Bluetooth setup menu.
- Search for new Bluetooth devices.
- Select **CZ702** from the pairing list on the mobile phone.
- Enter "0000" as the password (The password default setting is " 0000 ").
- After pairing successfully, the unit will enter Bluetooth mode automatically, and "CONNECTED" will appear on the LCD.
- The unit can connect three units.

Bluetooth Operations

Making a call

Operation from Bluetooth menu

Press the [SRC / ④] button to switch the source to "BLUETOOTH". Press [MENU / ③] button to select a way to make outgoing call:

• Dial Number

- Press the [MENU / ③] button.
- Press the [VOLUME] knob on the front panel to switch: , "DIAL NUB", "DIALLED", "MISSED", "RECEIVED", "USER PBK" .
- Press the [VOLUME] knob to confirm the selection.
- Rotate the [VOLUME] knob to select a number, press the knob to confirm and ready to input the next digit. Repeat the above until all numbers inputted.
- Press the [BAND / ④] to dial.
- Press [MENU / ③] to terminate call.

• Dialed/Missed/ Received User pbk

You can search any Dialed/Missed/Received / User pbk.

- Rotate the [VOLUME] knob to select "DIALLED", "MISSED", "RECEIVED".
- Press the [VOLUME] knob to enter the selected call history.
- Rotate the [VOLUME] knob to scroll the contacts.
- When the contact name or mobile phone No. is displayed, press the [BAND / ④] button to call the mobile phone No. of that contact.
* Press the [MENU / ③] button to end the call.

• Call from Phonebook

User can search the contact name in the phonebook and make call.

- Rotate the [VOLUME] knob to select "USER PBK" .
- Press the [VOLUME] knob to enter the selected phonebook.
- Rotate the [VOLUME] knob to scroll the contacts.
- The phone number and the name to scroll display. When the contact name is displayed, press the [BAND / ④] button call the mobile phone No. of that contact.

* Press the [MENU / ③] button to end the call.

• Answering a call

You can answer an incoming call by pressing the [BAND / ④] button.

* Press the [MENU / ③] button to reject an incoming call.

Audio Streaming Operations

What is audio streaming?

Audio streaming is a technique for transferring audio data such that it can be processed as a steady and continuous stream. Users can stream music from their external audio player to their car stereo wirelessly and listen to the tracks through the car's speakers. Please consult your nearest Clarion dealer for more information on the product of wireless audio streaming transmitter offered.

⚠ CAUTION

Please avoid operating your connected mobile phone while audio streaming as this may cause noise or sound choppy on the song playback.

Audio streaming may or may not resume after telephone interrupt as this is dependent on mobile phone.

System will always return to Radio mode if audio streaming is disconnected.

Note:

Be sure to read the chapter "Pairing before proceeding."

Play / Pause a track

- Push the [4] button to pause audio playback.
- To resume audio playback, push the [4] knob again.

Selecting a track

Track-up

- Press the [⏪] button to move to the

Bluetooth Operations

- beginning of the next track.
- Each time the [>>>] button is pressed, playback proceeds to another track in the advancing direction.

Track-down

- Press the [<<<] button to move to the beginning of the previous track.
- Each time the [<<<] button is pressed, playback proceeds to previous track in the reverse direction.

Note:

Playing order will depend on Bluetooth audio player. When [<<<] button is pressed, some A2DP devices will restart the current track depends on the duration of playback. During music streaming playback, "A2DP" will be shown on the display. Information about tracks (e.g. the elapsed playtime, song title, etc.) can be displayed on this unit. When A2DP device is disconnected, "BT DISCONNECT" will be shown on the display

and return to previously selected audio source. Some Bluetooth audio players may not have play / pause synchronized with this unit. Please make sure both device and main unit are in the same play / pause status in **BT MUSIC** mode.

ID3 display

SCROLL: ON/OFF

During music streaming playback, for music information that is longer than the display panel:

When SCROLL is ON, the LCD will display ID3 TAG information cyclely, e.g: TRACK->ALBUM->TITLE->ARTIST->TRACK->...
When SCROLL is OFF, the LCD will display one of the ID3 TAG information, the default is TRACK, but user can adjust it to other ID3 TAG information by press [DISP] button.

AUX Operations

Press [SRC / ϕ] button on the panel to select "AUX".
AUX is just for audio content with 3.5mm Jack connector plugged into audio-in socket on the front panel.

AUX Input sensitivity setting

- Press and hold the [DISP] button (1 sec.).
- Turn the [VOLUME] knob to select "AUX SENS".
- If the output level of connected external audio player is "HIGH", rotate [VOLUME] knob and choose "LOW". And if the output level is "LOW", choose "HIGH".

6. TROUBLE SHOOTING

GENERAL

Problem	Cause	Measure
Unit can not power on.	Unit fuse blown.	Replace with new fuse of correct rating.
	Car battery fuse blown.	Replace with new fuse of correct rating.
Unit can not power on. Nothing happens when buttons are pressed.	The microprocessor has malfunctioned due to noise, etc.	Turn off the power and remove the DCP. Press the [RESET] button with a thin rod.
Display is not accurate.		Note: When the [RESET] button is pressed, turn off the ACC power.* * When the [RESET] button is pressed, frequencies of radio stations, titles, etc. stored in memory are cleared.
No/low audio output.	Improper audio output connection.	Check wiring and correct.
	Volume set too low.	Increase volume level.
	Speakers damaged.	Replace speakers.
	Heavily biased volume balance.	Adjust the channel balance to center position.
Poor sound quality or distortion.	Speaker wiring is in contact with metal part of car.	Insulate all speaker wiring connections.
	Non-standard disc used.	Use a standard disc.
	Speaker power rating does not match unit.	Replace speakers.
Unit resets itself when engine is off.	Wrong connections.	Check wiring and correct.
	Speaker is shorted.	Check wiring and correct.
Unit resets itself when engine is off.	Incorrect connection between ACC and Battery.	Check wiring and correct.

DISC Player

Problem	Cause	Measure
Disc cannot be loaded.	Another disc is already loaded.	Eject the disc before loading the new one.
	There is an object install installed the unit.	Remove the object inside the unit.
Sound skips or is noisy.	Compact disc is dirty.	Clean the compact disc with a soft cloth.
	Compact disc is heavily scratched or warped.	Replace with a compact disc with no scratches.
Sound is bad when power is first turned on.	Condensation may form on the internal lens when the car is parked in a humid place.	Let dry for about 1 hour with power on.

USB Devices

Problem	Cause	Measure
USB device cannot be inserted.	The USB device has been inserted with wrong direction.	Reversing the connection direction of the USB device, try it again.
	The USB connector is broken.	Replace with a new USB device.
USB device is not recognized.	The USB device is damaged.	Disconnect the USB device and reconnect. If the device is still not recognized, try replacing with a different USB device.
	Connectors are loose.	
No sound heard with the display "No File" shown.	No MP3/WMA file is stored in the USB device.	Store these files properly in the USB device.
Sound skips or is noisy.	MP3/WMA files are not encoded properly.	Use MP3/WMA files encoded properly.

7. ERROR DISPLAYS

If an error occurs, one of the following displays is displayed. Take the measures described below to solve the problem.

Display	Cause	Measure
ERROR 3	Disc is inserted incorrectly.	Eject the disc then reload it properly.
	The disc format is not supported.	Try another disc.
ERROR 5	This is a failure of deck's mechanism.	Consult your store of purchase.

If an error display other than the ones described above appears, press the **[RESET]** button. If the problem persists, turn off the power and consult your store of purchase.

- * When the **[RESET]** button is pressed, frequencies of radio stations, titles, etc. stored in memory are cleared.

8. SPECIFICATIONS

FM Tuner

Frequency range: 87.9-107.9MHz
 Usable sensitivity: 8dBf
 Frequency response: 30Hz-15kHz
 Stereo separation: 30dB(1kHz)
 Signal/noise ratio: >55dB

AM Tuner

Frequency range: 530-1710kHz
 Usable sensitivity (S/N=20dB): 30dBμ

CD Player

System: Disc digital audio system
 Frequency response: 20Hz-20kHz
 Signal/noise ratio: >94dB
 Total harmonic distortion: Less than 0.1% (1kHz)
 Channel separation: >60dB

MP3/WMA mode

MP3 sampling rate: 8 kHz to 48 kHz
 MP3 bit rate: 8 kbps to 320 kbps / VBR
 WMA bit rate: 8 kbps to 320 kbps
 Logical format: ISO9660 level 1,2
 Joliet file system

USB

Specification: USB 1.0/2.0
 Playable audio format:
 MP3(.mp3): MPEG 1/2/Audio Layer-3
 WMA(.wma): Ver 7/8/9.1/9.2

Audio Amplifier

Maximum power output:
 180W (45W x 4)
 Speaker impedance: 4Ω (4 to 8 Ω allowable)

Input

Audio input sensitivity:
 High: 320mV (at 1V output)
 Mid: 650mV (at 1V output)
 Low: 1.3V (at 1V output)

(input impedance 10 kΩ or greater)
 Aux-in level: ≤2V

General

Power supply voltage:
 14.4VDC (10.8 to 15.6V allowable),
 negative ground
 Pre-Amp output voltage:
 2.0V (CD play mode: 1kHz, 0dB, 10kΩ load)
 Fuse: 15A
 Dimensions of the Main Unit:
 188mm Width x 58mm Height x 190mm Depth
 7-2/5(width) x 2-7/25(Height) x 7-12/25(Depth)
 Weight of the Main Unit: 2.87lb. (1.30kg)
 Dimensions of the Remote Control unit:
 43mm Width x 11mm Height x 113mm Depth
 1-2/3(Width) x 2/5(Height) x 4-2/5(Depth)
 Weight of the Remote Control Unit:
 1.16oz. (36g) (including battery)

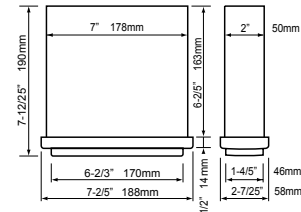

Notes:

- Specifications and design are subject to change without notice for further improvement.

Power Output:
 19W RMS x 4 Channels at 4Ω
 and 1% THD+N

Signal to Noise Ratio:
 94dB (reference: 1W into 4)

9. INSTALLATION / WIRE CONNECTION GUIDE

CONTENTS

1) Before Starting	15
2) Package Contents	15
3) General Cautions	15
4) Cautions on Installation	15
5) Installing the Source Unit	15
6) Removing the Source Unit	16
7) Wiring and Connections	17
8) Connecting the accessories	17

1) Before Starting

1. This set is exclusively for use in cars with a negative ground 12 V power supply.
2. Read these instructions carefully.
3. Be sure to disconnect the battery "terminal" before starting. This is to prevent short circuits during installation. (Figure 1)

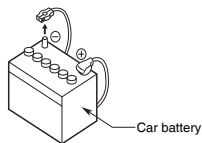

Figure 1

2) Package Contents

Source unit	1	Wire connector	1
Front panel	1	Remote control unit (with battery).....	1
Trim ring	1	Owner's manual.....	1
Mounting bracket.....	1	Warranty card	1
Screws M5x6 mm.....	4	Special screw (Front panel lock)	1
L-key.....	2		

3) General Cautions

1. Do not open the case. There are no user serviceable parts inside. If you drop anything into the unit during installation, consult your dealer or an authorized **Clarion** service center.
2. Use a soft, dry cloth to clean the case. Never use a rough cloth, thinner, benzine, or alcohol etc. For tough dirt, apply a little cold or warm water to a soft cloth and wipe off the dirt gently.

4) Cautions on Installation

1. Prepare all articles necessary for installing the source unit before starting.
2. Install the unit within 30° of the horizontal plane. (Figure 2)
3. If you have to do any work on the car body, such as drilling holes, consult

- your car dealer beforehand.
4. Use the enclosed screws for installation. Using other screws can cause damage. (Figure 3)

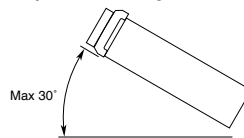

Figure 2

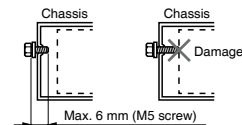

Figure 3

5) Installing the Source Unit

1. Place the mounting bracket into the instrument panel, use a screwdriver to bend each stopper of the mounting bracket inward, then secure the stopper.
2. Wire as shown in Section 7) .
3. Insert the source unit into the mounting bracket until it locks.
4. Take care of the top and bottom of the trim ring and mount it so that all the hooks are locked.

Notes:

1. Some car models require special mounting kits for proper installation. Consult your **Clarion** dealer for details.
2. Fasten the front stopper securely to prevent the source unit from coming loose.

• Console opening dimensions

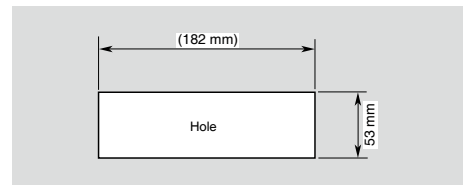

Notes of installation

1. Before installation, please make sure proper connections are conducted and the unit operates normally. Improper connection may result in damage to the unit.
2. Use only accessories designed and manufactured for this unit and other unauthorized accessories may result in damage to the unit.
3. Before installation, please fasten all power cables.
4. DO NOT install the unit in the place where close to hot area to prevent damage to electrical components such as the laser head.
5. Install the unit horizontally. Installing the unit more than 30 degree vertically may result in worse performance.
6. To prevent electric spark, connect the

positive pole first and then the negative pole.

7. DO NOT block the cooling fan exit to ensure sufficient heating dissipation of this unit, or it may result in damage to this unit.

Unit Installation

Method A

1. Insert mounting bracket into dash board, choose appropriate mounting tab according to the gap width, bending the mounting tab outwards with a screwdriver to fix the mounting bracket in place.
2. Slide the unit into the bracket until you hear a click sound.

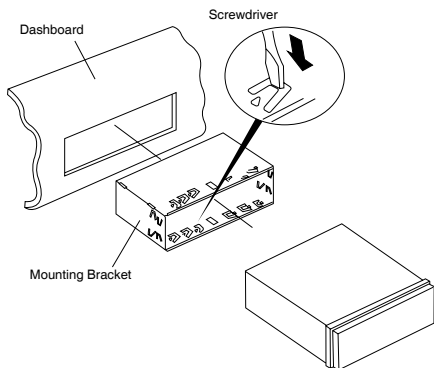

Method B

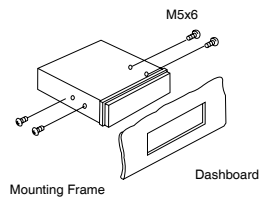
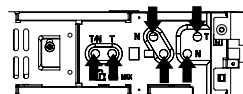

1. Insert this unit directly to the opening of the dashboard.
2. Place M5x6 cylindrical screw through the holes of the mounting frame located inside the opening to holes of the unit and fasten the screws to left & right.

Trim Ring installation

Attach the trim ring around the front panel. Take care of the top and bottom of the trim ring and mount it so that all the hooks are locked.

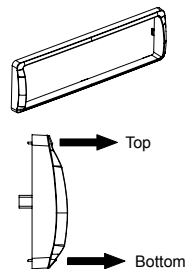

6) Removing the Source Unit

Disassemble trim ring

1. Push the trim ring to right and pull out the right part.
2. Push the trim ring to left and pull out the left part.

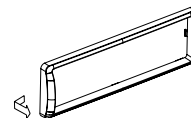
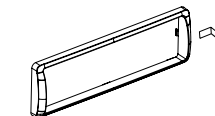

Disassemble the unit

1. Switch off the power.
2. Remove the panel.
3. Remove the trim ring.
4. Insert the removal keys straight back until they lock, then pull the unit out.

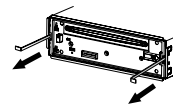

5. Disconnect all the wires.

7) Wiring and Connections

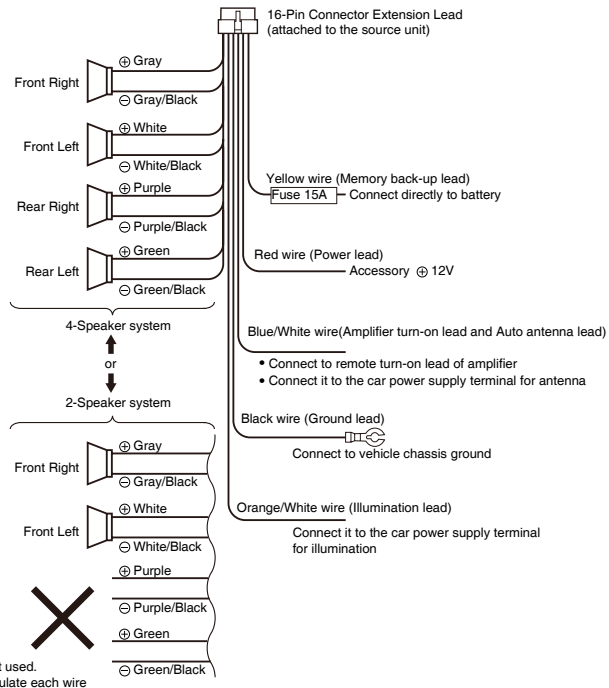
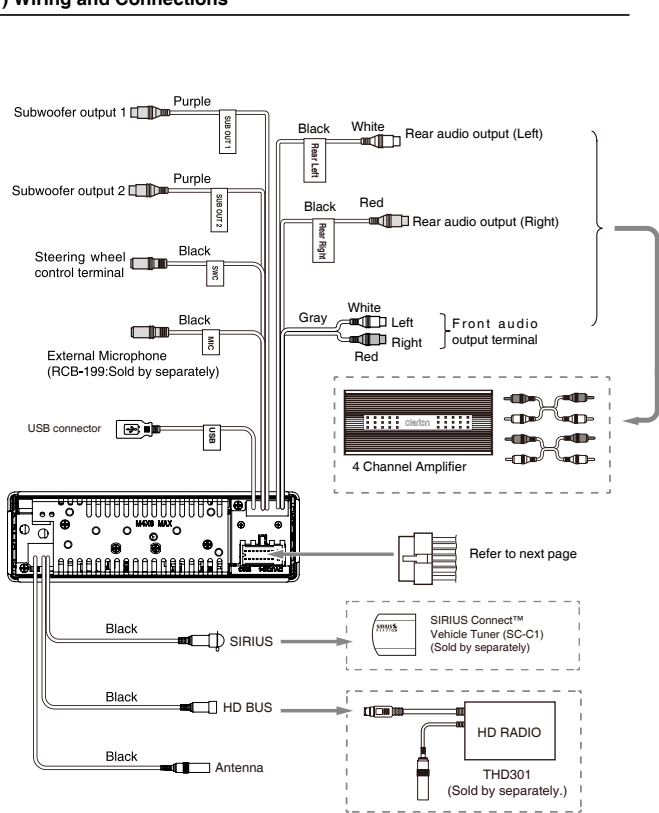

8) Connecting the accessories

• Connecting to the external amplifier

External amplifiers can be connected to the 4 channel RCA output connections. Ensure that the connectors are not grounded or shorted to prevent damage to the unit.