



# FCC TEST REPORT (For BLUETOOTH)

**REPORT NO.:** RF110923D14

**MODEL NO.:** M8935

**FCC ID:** AVHM8935

**RECEIVED:** Sep. 23, 2011

**TESTED:** Nov. 28 ~ Dec. 21, 2011

**ISSUED:** Dec. 27, 2011

**APPLICANT:** ParTech, Inc.

**ADDRESS:** 8383 Seneca Turnpike, New Hartford, New York  
13413-4991 USA

**ISSUED BY:** Bureau Veritas Consumer Products Services (H.K.)  
Ltd., Taoyuan Branch

**LAB LOCATION:** No. 47, 14th Ling, Chia Pau Vil., Lin Kou Dist., New  
Taipei City, Taiwan ( R.O.C. )

This test report consists of 64 pages in total. It may be duplicated completely for legal use with the approval of the applicant. It should not be reproduced except in full, without the written approval of our laboratory. The client should not use it to claim product endorsement by TAF or any government agencies. The test results in the report only apply to the tested sample.





# TABLE OF CONTENTS

RELEASE CONTROL RECORD.....	4
1. CERTIFICATION.....	5
2. SUMMARY OF TEST RESULTS.....	6
2.1 MEASUREMENT UNCERTAINTY.....	7
3. GENERAL INFORMATION.....	8
3.1 GENERAL DESCRIPTION OF EUT.....	8
3.2 DESCRIPTION OF TEST MODES.....	10
3.2.1 CONFIGURATION OF SYSTEM UNDER TEST.....	11
3.2.2 TEST MODE APPLICABILITY AND TESTED CHANNEL DETAIL.....	12
3.2.3 GENERAL DESCRIPTION OF APPLIED STANDARDS.....	14
3.2.4 DESCRIPTION OF SUPPORT UNITS.....	14
4. TEST TYPES AND RESULTS.....	15
4.1 CONDUCTED EMISSION MEASUREMENT.....	15
4.1.1 LIMITS OF CONDUCTED EMISSION MEASUREMENT.....	15
4.1.2 TEST INSTRUMENTS.....	16
4.1.3 TEST PROCEDURES.....	16
4.1.4 DEVIATION FROM TEST STANDARD.....	17
4.1.5 TEST SETUP.....	17
4.1.6 EUT OPERATING CONDITIONS.....	17
4.1.7 TEST RESULTS.....	18
4.2 RADIATED EMISSION MEASUREMENT.....	22
4.2.1 LIMITS OF RADIATED EMISSION MEASUREMENT.....	22
4.2.2 TEST INSTRUMENTS.....	23
4.2.3 TEST PROCEDURES.....	24
4.2.4 DEVIATION FROM TEST STANDARD.....	24
4.2.5 TEST SETUP.....	25
4.2.6 EUT OPERATING CONDITIONS.....	25
4.2.7 TEST RESULTS.....	26
4.3 NUMBER OF HOPPING FREQUENCY USED.....	33
4.3.1 LIMIT OF HOPPING FREQUENCY USED.....	33
4.3.2 TEST INSTRUMENTS.....	33
4.3.3 TEST PROCEDURES.....	33
4.3.4 DEVIATION FROM TEST STANDARD.....	34
4.3.5 TEST SETUP.....	34
4.3.6 TEST RESULTS.....	34
4.4 DWELL TIME ON EACH CHANNEL.....	37
4.4.1 LIMIT OF DWELL TIME USED.....	37
4.4.2 TEST INSTRUMENTS.....	37
4.4.3 TEST PROCEDURES.....	37
4.4.4 DEVIATION FROM TEST STANDARD.....	37
4.4.5 TEST SETUP.....	38
4.4.6 TEST RESULTS.....	38
4.5 CHANNEL BANDWIDTH.....	42
4.5.1 LIMITS OF CHANNEL BANDWIDTH.....	42
4.5.2 TEST INSTRUMENTS.....	42
4.5.3 TEST PROCEDURE.....	42



4.5.4	DEVIATION FROM TEST STANDARD .....	43
4.5.5	TEST SETUP .....	43
4.5.6	EUT OPERATING CONDITION .....	43
4.5.7	TEST RESULTS .....	44
4.6	HOPPING CHANNEL SEPARATION .....	46
4.6.1	LIMIT OF HOPPING CHANNEL SEPARATION .....	46
4.6.2	TEST INSTRUMENTS .....	46
4.6.3	TEST PROCEDURES .....	46
4.6.4	DEVIATION FROM TEST STANDARD .....	47
4.6.5	TEST SETUP .....	47
4.6.6	TEST RESULTS .....	48
4.7	MAXIMUM PEAK OUTPUT POWER .....	50
4.7.1	LIMITS OF MAXIMUM PEAK OUTPUT POWER MEASUREMENT .....	50
4.7.2	TEST INSTRUMENTS .....	50
4.7.3	TEST PROCEDURES .....	50
4.7.4	DEVIATION FROM TEST STANDARD .....	50
4.7.5	TEST SETUP .....	51
4.7.6	EUT OPERATING CONDITION .....	51
4.7.7	TEST RESULTS .....	52
4.8	BAND EDGES MEASUREMENT .....	54
4.8.1	LIMITS OF BAND EDGES MEASUREMENT .....	54
4.8.2	TEST INSTRUMENTS .....	54
4.8.3	TEST PROCEDURE .....	55
4.8.4	DEVIATION FROM TEST STANDARD .....	55
4.8.5	EUT OPERATING CONDITION .....	55
4.8.6	TEST RESULTS .....	56
5.	PHOTOGRAPHS OF THE TEST CONFIGURATION .....	62
6.	INFORMATION ON THE TESTING LABORATORIES .....	63
7.	APPENDIX A – MODIFICATIONS RECORDERS FOR ENGINEERING CHANGES TO THE EUT BY THE LAB .....	64



## RELEASE CONTROL RECORD

ISSUE NO.	REASON FOR CHANGE	DATE ISSUED
RF110923D14	Original release	Dec. 27, 2011



## 1. CERTIFICATION

**PRODUCT:** Temperature Measuring Device  
**BRAND NAME:** Par  
**MODEL NO.:** M8935  
**APPLICANT:** ParTech, Inc.  
**TESTED:** Nov. 28 ~ Dec. 21, 2011  
**TEST SAMPLE:** R&D SAMPLE  
**STANDARDS:** FCC Part 15, Subpart C (Section 15.247)  
ANSI C63.4-2003  
ANSI C63.10-2009

The above equipment has been tested by **Bureau Veritas Consumer Products Services (H.K.) Ltd., Taoyuan Branch**, and found compliance with the requirement of the above standards. The test record, data evaluation & Equipment Under Test (EUT) configurations represented herein are true and accurate accounts of the measurements of the sample's EMC characteristics under the conditions specified in this report.

**PREPARED BY :** Annie Chang , **DATE:** Dec. 27, 2011  
( Annie Chang / Senior Specialist )

**APPROVED BY :** Ken Liu , **DATE:** Dec. 27, 2011  
( Ken Liu / Manager )

## 2. SUMMARY OF TEST RESULTS

The EUT has been tested according to the following specifications:

APPLIED STANDARD: FCC Part 15, Subpart C			
STANDARD SECTION	TEST TYPE AND LIMIT	RESULT	REMARK
15.207	AC Power Conducted Emission	PASS	Meets Class B Limit Minimum passing margin is -12.25dB at 0.398MHz
15.247(a)(1)(iii)	Number of Hopping Frequency Used Spec.: At least 15 channels	PASS	Meet the requirement of limit.
15.247(a)(1)(iii)	Dwell Time on Each Channel Spec.: Max. 0.4 second within 31.6 second	PASS	Meet the requirement of limit.
15.247(a)(1)	1. Hopping Channel Separation Spec. : Min. 25 kHz or 20 dB bandwidth, whichever is greater (see Note) 2. Spectrum Bandwidth of a Frequency Hopping Sequence Spread Spectrum System	PASS	Meet the requirement of limit.
15.247(b)	Maximum Peak Output Power Spec.: max. 21dBm (see Note)	PASS	Meet the requirement of limit.
15.247(d)	Transmitter Radiated Emissions Spec.: Table 15.209	PASS	Meet the requirement of limit. Minimum passing margin is -2.1dB at 81.65MHz.
15.247(d)	Band Edge Measurement	PASS	Meet the requirement of limit.
15.203	Antenna Requirement	PASS	No antenna connector is used.

**NOTE:** If The Frequency Hopping System operating in 2400-2483.5MHz band and the output power less than 125mW. The hopping channel carrier frequencies separated by a minimum of 25kHz or two-thirds of the 20dB bandwidth of hopping channel whichever is greater.

## 2.1 MEASUREMENT UNCERTAINTY

Where relevant, the following measurement uncertainty levels have been estimated for tests performed on the EUT as specified in CISPR 16-4-2:

This uncertainty represents an expanded uncertainty expressed at approximately the 95% confidence level using a coverage factor of  $k=2$ .

MEASUREMENT	FREQUENCY	UNCERTAINTY
Conducted emissions	150kHz ~ 30MHz	2.41 dB
Radiated emissions	30MHz ~ 1GHz	3.87 dB
	Above 1GHz	3.36 dB



A D T

### 3. GENERAL INFORMATION

#### 3.1 GENERAL DESCRIPTION OF EUT

<b>PRODUCT</b>	Temperature Measuring Device
<b>MODEL NO.</b>	M8935
<b>FCC ID</b>	AVHM8935
<b>NOMINAL VOLTAGE</b>	DC 3.7V (from battery) or DC 5V (from AC Adapter or host equipment)
<b>MODULATION TYPE</b>	GFSK, $\pi/4$ -DQPSK, 8DPSK
<b>MODULATION TECHNOLOGY</b>	FHSS
<b>TRANSFER RATE</b>	1/2/3Mbps
<b>OPERATING FREQUENCY</b>	2402 ~ 2480MHz
<b>NUMBER OF CHANNEL</b>	79
<b>OUTPUT POWER</b>	0.2mW
<b>ANTENNA TYPE</b>	Chip antenna with 1.3dBi gain
<b>ANTENNA CONNECTER</b>	N/A
<b>DATA CABLE</b>	Shielded USB cable (1.5 m)
<b>I/O PORTS</b>	Refer to User's manual
<b>ACCESSORY DEVICES</b>	Refer to note below

#### NOTE:

1. The EUT is a Temperature Measuring Device. The functions of EUT listed as below:

<b>FUNCTION</b>	<b>TEST STANDARD</b>	<b>REFERENCE REPORT</b>
<b>Bluetooth Module</b> (Brand: Panasonic, Model: PAN1315 and PAN1325)	FCC Part 15, Subpart C (Section 15.247)	RF110923D14
<b>RFID</b> (Brand: TI, Model: TRF7960RHBT)	FCC Part 15, Subpart C (Section 15.225)	RF110923D14-1

The Bluetooth module itself without antenna is designated PAN1315. The antenna module with mounted antenna is designated PAN1325.



2. The EUT consumes power from an AC adapter, cradle or battery, as follows:

Item	Brand	Model No.	Spec.
Adapter	Elementech International Co., Ltd.	AU1050501z (z=e,u,b,s,c,k,0)	AC I/P: 100-240V, 50/60Hz, 0.2A DC O/P: 5V, 1A AC 2-Pin ( <b>Fixed plug</b> ) Shielded USB cable (1.5 m)
		AU10505040	AC I/P: 100-240V, 50/60Hz, 0.2A DC O/P: 5V, 1A AC 2-Pin ( <b>Detachable plug</b> ) Shielded USB cable (1.5 m)
Cradle	Par	K8935	DC 5V from Adapter
Battery	iEi	MODAT-300	3.7Vdc, 1880mAh, 7Wh

The above adapters are identical to each except for the AC plug type only, therefore, only **model: AU1050501u** was selected for the final test.

3. For Conducted & Radiated Emissions tests, following modes were pre-tested:

- u EUT + Cradle link to Notebook PC
- u EUT link to Notebook PC
- u EUT + Cradle + Adapter
- u EUT + Adapter
- u EUT only (Radiated only)

The worst emission level was found when the EUT was tested under **EUT + Cradle link to Notebook PC** mode, therefore, only its test data was recorded in this report.

4. For more detailed features description, please refer to the manufacturer's specifications or User's Manual.

### 3.2 DESCRIPTION OF TEST MODES

79 channels are provided to this EUT:

CHANNEL	FREQ. (MHz)	CHANNEL	FREQ. (MHz)	CHANNEL	FREQ. (MHz)	CHANNEL	FREQ. (MHz)
0	2402	20	2422	40	2442	60	2462
1	2403	21	2423	41	2443	61	2463
2	2404	22	2424	42	2444	62	2464
3	2405	23	2425	43	2445	63	2465
4	2406	24	2426	44	2446	64	2466
5	2407	25	2427	45	2447	65	2467
6	2408	26	2428	46	2448	66	2468
7	2409	27	2429	47	2449	67	2469
8	2410	28	2430	48	2450	68	2470
9	2411	29	2431	49	2451	69	2471
10	2412	30	2432	50	2452	70	2472
11	2413	31	2433	51	2453	71	2473
12	2414	32	2434	52	2454	72	2474
13	2415	33	2435	53	2455	73	2475
14	2416	34	2436	54	2456	74	2476
15	2417	35	2437	55	2457	75	2477
16	2418	36	2438	56	2458	76	2478
17	2419	37	2439	57	2459	77	2479
18	2420	38	2440	58	2460	78	2480
19	2421	39	2441	59	2461		

### 3.2.1 CONFIGURATION OF SYSTEM UNDER TEST

#### Mode A

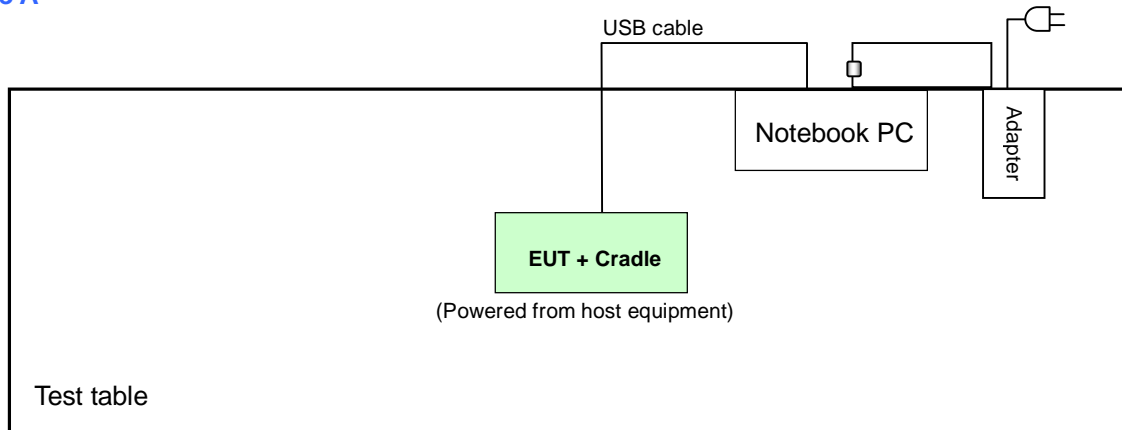

#### Mode B

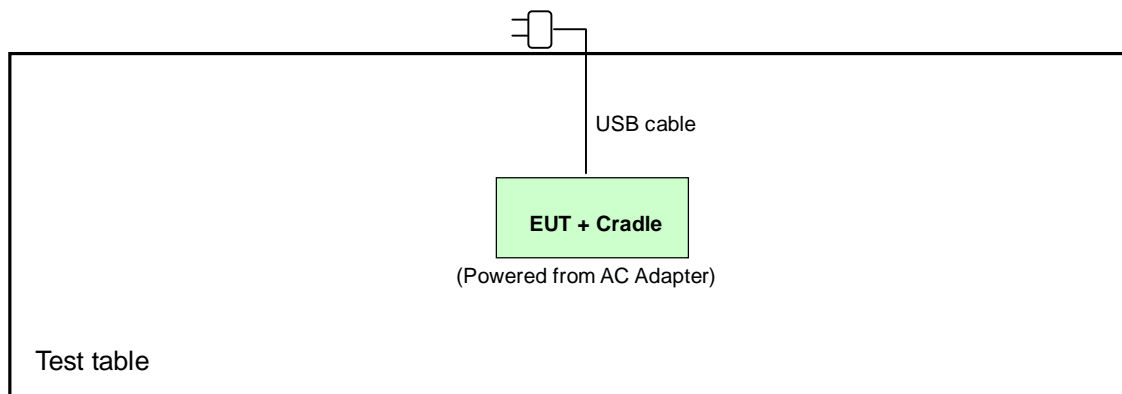



### 3.2.2 TEST MODE APPLICABILITY AND TESTED CHANNEL DETAIL

EUT CONFIGURE MODE	Applicable to				Description
	PLC	RE<1G	RE>1G	APCM	
A	√	√	√	√	EUT + Cradle link to Notebook PC
B	√	-	-	-	EUT + Cradle + Adapter

Where **PLC**: Power Line Conducted Emission

**RE<1G**: Radiated Emission below 1GHz

**RE>1G**: Radiated Emission above 1GHz

**APCM**: Antenna Port Conducted Measurement

**Note**: No need to concern of Conducted Emission due to the EUT is powered by battery.

#### **POWER LINE CONDUCTED EMISSION TEST:**

- Pre-Scan has been conducted to determine the worst-case mode from all possible combinations between available modulations, data rates and antenna ports (if EUT with antenna diversity architecture).
- Following channel(s) was (were) selected for the final test as listed below.

EUT CONFIGURE MODE	AVAILABLE CHANNEL	TESTED CHANNEL	MODULATION TECHNOLOGY	MODULATION TYPE	PACKET TYPE	DATE RATE
A & B	0 to 78	0	FHSS	GFSK	DH1	1

#### **RADIATED EMISSION TEST (BELOW 1 GHz):**

- Pre-Scan has been conducted to determine the worst-case mode from all possible combinations between available modulations, data rates, packet types, X,Y,Z Axis data rate and antenna ports (if EUT with antenna diversity architecture).
- Following channel(s) was (were) selected for the final test as listed below.

EUT CONFIGURE MODE	AVAILABLE CHANNEL	TESTED CHANNEL	MODULATION TECHNOLOGY	MODULATION TYPE	PACKET TYPE	DATE RATE	AXIS
A	0 to 78	0	FHSS	GFSK	DH1	1	Z

#### **RADIATED EMISSION TEST (ABOVE 1 GHz):**

- Pre-Scan has been conducted to determine the worst-case mode from all possible combinations between available modulations, data rates, packet types data rate, X,Y,Z Axis and antenna ports (if EUT with antenna diversity architecture).
- Following channel(s) was (were) selected for the final test as listed below.

EUT CONFIGURE MODE	AVAILABLE CHANNEL	TESTED CHANNEL	MODULATION TECHNOLOGY	MODULATION TYPE	PACKET TYPE	DATE RATE	AXIS
A	0 to 78	0, 39, 78	FHSS	GFSK	DH1	1	Z
A	0 to 78	0, 39, 78	FHSS	8DPSK	DH1	3	Z

**BANDEDGE MEASUREMENT:**

- Pre-Scan has been conducted to determine the worst-case mode from all possible combinations between available modulations and packet types of the antenna and antenna ports (if EUT with antenna diversity architecture).
- Following channel(s) was (were) selected for the final test as listed below.

EUT CONFIGURE MODE	AVAILABLE CHANNEL	TESTED CHANNEL	MODULATION TECHNOLOGY	MODULATION TYPE	PACKET TYPE	DATE RATE
A	0 to 78	0, 78	FHSS	GFSK	DH1	1
A	0 to 78	0, 78	FHSS	8DPSK	DH1	3

**ANTENNA PORT CONDUCTED MEASUREMENT:**

- Pre-Scan has been conducted to determine the worst-case mode from all possible combinations between available modulations and packet types of the antenna and antenna ports (if EUT with antenna diversity architecture).
- Following channel(s) was (were) selected for the final test as listed below.

EUT CONFIGURE MODE	AVAILABLE CHANNEL	TESTED CHANNEL	MODULATION TECHNOLOGY	MODULATION TYPE	PACKET TYPE	DATE RATE
A	0 to 78	0, 39, 78	FHSS	GFSK	DH1	1
A	0 to 78	0, 39, 78	FHSS	8DPSK	DH1	3

**TEST CONDITION:**

APPLICABLE TO	EUT CONFIGURE MOD	ENVIRONMENTAL CONDITIONS	INPUT POWER	TESTED BY
PLC	A	20deg. C, 68% RH	120Vac, 60Hz (SYSTEM)	Chad Lee
	B	20deg. C, 75% RH	120Vac, 60Hz	Nick Chen
RE <sup>3</sup> 1G	A	23deg. C, 65% RH	120Vac, 60Hz(SYSTEM)	Chad Lee
RE<1G	A	18deg. C, 76% RH	120Vac, 60Hz(SYSTEM)	Nick Chen
APCM	A	21deg. C, 70% RH	120Vac, 60Hz(SYSTEM)	Jun Wu



### 3.2.3 GENERAL DESCRIPTION OF APPLIED STANDARDS

The EUT is a RF Product. According to the specifications of the manufacturer, it must comply with the requirements of the following standards:

**FCC Part 15, Subpart C. (15.247)**

**ANSI C63.4- 2003**

**ANSI C63.10-2009**

All test items have been performed and recorded as per the above standards.

**NOTE:** The product has been verified to comply with the requirements of FCC Part 15, Subpart B, Class B (DoC). The test report has been issued separately.

### 3.2.4 DESCRIPTION OF SUPPORT UNITS

The EUT has been tested as an independent unit together with other necessary accessories or support units. The following support units or accessories were used to form a representative test configuration during the tests.

NO.	PRODUCT	BRAND	MODEL NO.	SERIAL NO.	FCC ID
1	NOTEBOOK COMPUTER	DELL	PP05L	24729091408	FCC DoC Approved

NO.	SIGNAL CABLE DESCRIPTION OF THE ABOVE SUPPORT UNITS
1	N/A

**NOTE:** All power cords of the above support units are non shielded (1.8m).

## 4. TEST TYPES AND RESULTS

### 4.1 CONDUCTED EMISSION MEASUREMENT

#### 4.1.1 LIMITS OF CONDUCTED EMISSION MEASUREMENT

FREQUENCY OF EMISSION (MHz)	CONDUCTED LIMIT (dB $\mu$ V)	
	Quasi-peak	Average
0.15 ~ 0.5	66 to 56	56 to 46
0.5 ~ 5	56	46
5 ~ 30	60	50

- NOTE:**
1. The lower limit shall apply at the transition frequencies.
  2. The limit decreases in line with the logarithm of the frequency in the range of 0.15 to 0.50 MHz.
  3. All emanations from a class A/B digital device or system, including any network of conductors and apparatus connected thereto, shall not exceed the level of field strengths specified above.

## 4.1.2 TEST INSTRUMENTS

DESCRIPTION & MANUFACTURER	MODEL NO.	SERIAL NO.	CALIBRATED DATE	CALIBRATED UNTIL
ROHDE & SCHWARZ Test Receiver	ESCS 30	100276	Dec. 31, 2010	Dec. 30, 2011
ROHDE & SCHWARZ Artificial Mains Network (for EUT)	ESH3-Z5	100219	Nov. 24, 2011	Nov. 23, 2012
LISN With Adapter (for EUT)	AD10	C10Ada-001	Nov. 24, 2011	Nov. 23, 2012
ROHDE & SCHWARZ Artificial Mains Network (for peripherals)	ESH3-Z5	100218	Dec. 08, 2011	Dec. 07, 2012
Software	ADT_Cond_V7.3.7	NA	NA	NA
Software	ADT_ISN_V7.3.7	NA	NA	NA
RF cable (JYEBAO)	5D-FB	Cable-C10.01	Feb. 22, 2011	Feb. 21, 2012
SUHNER Terminator (For ROHDE & SCHWARZ LISN)	65BNC-5001	E1-010773	Feb. 26, 2011	Feb. 25, 2012

- NOTE:**
1. The calibration interval of the above test instruments is 12 months and the calibrations are traceable to NML/ROC and NIST/USA.
  2. The test was performed in Shielded Room No. 10.
  3. The VCCI Site Registration No. C-1852.

## 4.1.3 TEST PROCEDURES

- a. The EUT was placed 0.4 meters from the conducting wall of the shielded room with EUT being connected to the power mains through a line impedance stabilization network (LISN). Other support units were connected to the power mains through another LISN. The two LISNs provide 50 ohm/ 50uH of coupling impedance for the measuring instrument.
- b. Both lines of the power mains connected to the EUT were checked for maximum conducted interference.
- c. The frequency range from 150kHz to 30MHz was searched. Emission levels under (Limit - 20dB) were not recorded.



#### 4.1.4 DEVIATION FROM TEST STANDARD

No deviation

#### 4.1.5 TEST SETUP

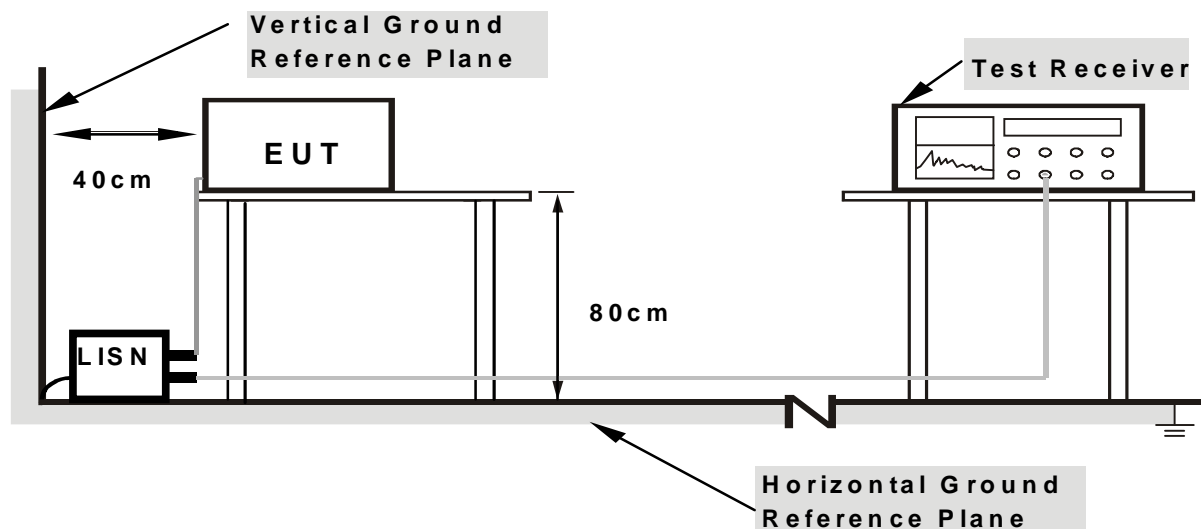

- Note:** 1. Support units were connected to second LISN.  
 2. Both of LISNs (AMN) are 80 cm from EUT and at least 80 cm from other units and other metal planes support units.

For the actual test configuration, please refer to the related item – Photographs of the Test Configuration.

#### 4.1.6 EUT OPERATING CONDITIONS

##### Mode A

- a. Turn on the power of all equipment.
- b. Connected the EUT with Notebook PC placed on testing table.
- c. EUT ran a test program (provided by manufacture) to enable.
- d. Set the EUT under transmission condition continuously at specific channel frequency.

##### Mode B

- e. Turn on the power of all equipment.
- f. Connected the EUT with AC adapter placed on testing table.
- g. EUT ran a test program (provided by manufacture) to enable.
- h. Set the EUT under transmission condition continuously at specific channel frequency.

### 4.1.7 TEST RESULTS

PHASE	Line 1	6dB BANDWIDTH	9kHz
CHANNEL	Channel 0	TEST MODE	A

No	Freq. [MHz]	Corr. Factor (dB)	Reading Value [dB (uV)]		Emission Level [dB (uV)]		Limit [dB (uV)]		Margin (dB)	
			Q.P.	AV.	Q.P.	AV.	Q.P.	AV.	Q.P.	AV.
	1	0.279	0.16	43.16	-	43.32	-	60.85	50.85	-17.53
2	0.361	0.19	44.56	-	44.75	-	58.70	48.70	-13.95	-
<b>3</b>	<b>0.398</b>	<b>0.21</b>	<b>45.43</b>	-	<b>45.64</b>	-	<b>57.89</b>	<b>47.89</b>	<b>-12.25</b>	-
4	0.520	0.22	41.74	-	41.96	-	56.00	46.00	-14.04	-
5	0.920	0.24	40.15	-	40.39	-	56.00	46.00	-15.61	-
6	1.596	0.28	42.74	-	43.02	-	56.00	46.00	-12.98	-

- REMARKS:**
1. Q.P. and AV. are abbreviations of quasi-peak and average individually.
  2. "-": The Quasi-peak reading value also meets average limit and measurement with the average detector is unnecessary.
  3. The emission levels of other frequencies were very low against the limit.
  4. Margin value = Emission level - Limit value
  5. Correction factor = Insertion loss + Cable loss
  6. Emission Level = Correction Factor + Reading Value.

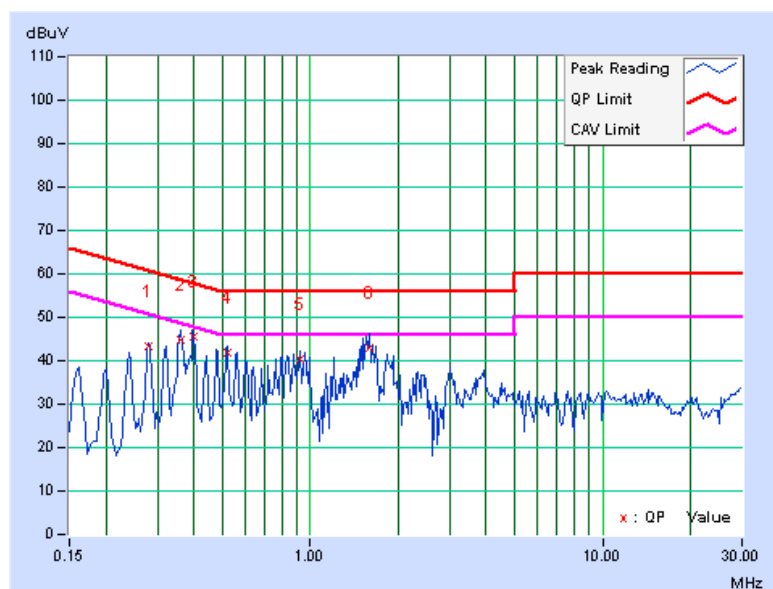



A D T

PHASE	Line 2	6dB BANDWIDTH	9kHz
CHANNEL	Channel 0	TEST MODE	A

No	Freq. [MHz]	Corr. Factor (dB)	Reading Value		Emission Level		Limit		Margin	
			[dB (uV)]		[dB (uV)]		[dB (uV)]		(dB)	
			Q.P.	AV.	Q.P.	AV.	Q.P.	AV.	Q.P.	AV.
1	0.357	0.19	39.73	-	39.92	-	58.79	48.79	-18.87	-
2	0.399	0.21	40.16	-	40.37	-	57.88	47.88	-17.51	-
3	0.560	0.22	36.26	-	36.48	-	56.00	46.00	-19.52	-
4	0.916	0.24	36.19	-	36.43	-	56.00	46.00	-19.57	-
5	1.279	0.25	35.34	-	35.59	-	56.00	46.00	-20.41	-
6	1.630	0.27	35.61	-	35.88	-	56.00	46.00	-20.12	-

- REMARKS:**
1. Q.P. and AV. are abbreviations of quasi-peak and average individually.
  2. "-": The Quasi-peak reading value also meets average limit and measurement with the average detector is unnecessary.
  3. The emission levels of other frequencies were very low against the limit.
  4. Margin value = Emission level - Limit value
  5. Correction factor = Insertion loss + Cable loss
  6. Emission Level = Correction Factor + Reading Value.

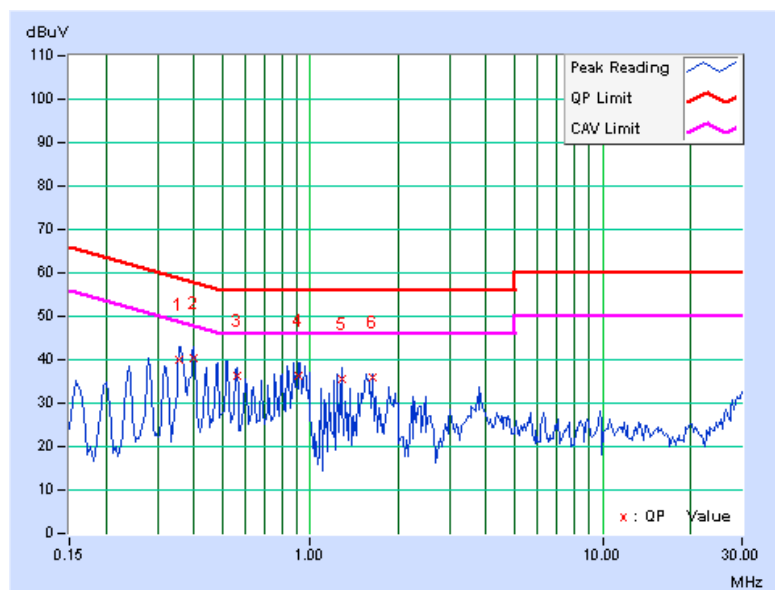



A D T

PHASE	Line 1	6dB BANDWIDTH	9kHz
CHANNEL	Channel 0	TEST MODE	B

No	Freq. [MHz]	Corr. Factor (dB)	Reading Value		Emission Level		Limit		Margin	
			[dB (uV)]		[dB (uV)]		[dB (uV)]		(dB)	
			Q.P.	AV.	Q.P.	AV.	Q.P.	AV.	Q.P.	AV.
1	0.252	0.14	28.39	-	28.53	-	61.71	51.71	-33.18	-
2	0.295	0.14	28.51	-	28.65	-	60.40	50.40	-31.75	-
3	0.523	0.14	25.77	-	25.91	-	56.00	46.00	-30.09	-
4	1.285	0.17	15.99	-	16.16	-	56.00	46.00	-39.84	-
5	1.851	0.19	16.12	-	16.31	-	56.00	46.00	-39.69	-
6	19.594	1.01	14.52	-	15.53	-	60.00	50.00	-44.47	-

- REMARKS:**
1. Q.P. and AV. are abbreviations of quasi-peak and average individually.
  2. "-": The Quasi-peak reading value also meets average limit and measurement with the average detector is unnecessary.
  3. The emission levels of other frequencies were very low against the limit.
  4. Margin value = Emission level - Limit value
  5. Correction factor = Insertion loss + Cable loss
  6. Emission Level = Correction Factor + Reading Value.

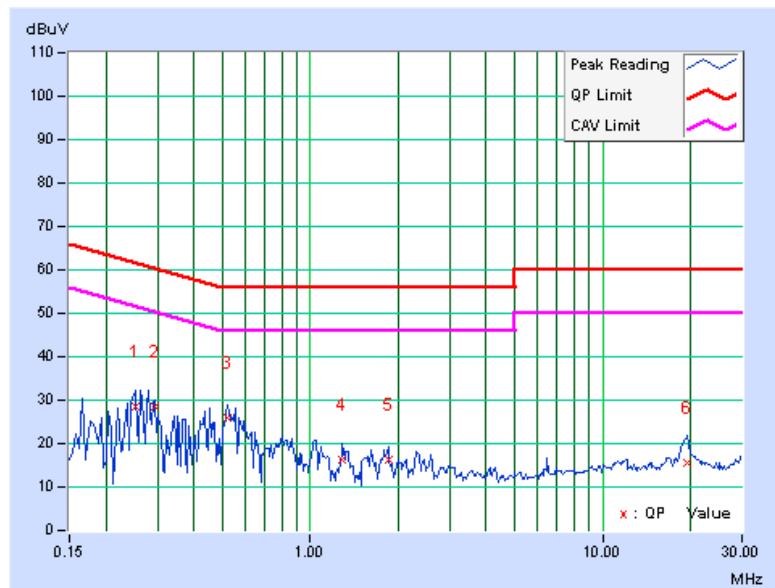



A D T

PHASE	Line 2	6dB BANDWIDTH	9kHz
CHANNEL	Channel 0	TEST MODE	B

No	Freq. [MHz]	Corr. Factor (dB)	Reading Value		Emission Level		Limit		Margin	
			[dB (uV)]		[dB (uV)]		[dB (uV)]		(dB)	
			Q.P.	AV.	Q.P.	AV.	Q.P.	AV.	Q.P.	AV.
1	0.162	0.15	27.99	17.25	28.14	17.40	65.37	55.37	-37.23	-37.97
2	0.295	0.15	34.48	24.78	34.63	24.93	60.39	50.39	-25.76	-25.46
3	0.533	0.15	32.80	23.32	32.95	23.47	56.00	46.00	-23.05	-22.53
4	1.096	0.17	24.00	13.84	24.17	14.01	56.00	46.00	-31.83	-31.99
5	1.807	0.19	24.08	13.86	24.27	14.05	56.00	46.00	-31.73	-31.95
6	19.143	0.66	17.33	9.76	17.99	10.42	60.00	50.00	-42.01	-39.58

- REMARKS:**
1. Q.P. and AV. are abbreviations of quasi-peak and average individually.
  2. "-": The Quasi-peak reading value also meets average limit and measurement with the average detector is unnecessary.
  3. The emission levels of other frequencies were very low against the limit.
  4. Margin value = Emission level - Limit value
  5. Correction factor = Insertion loss + Cable loss
  6. Emission Level = Correction Factor + Reading Value.

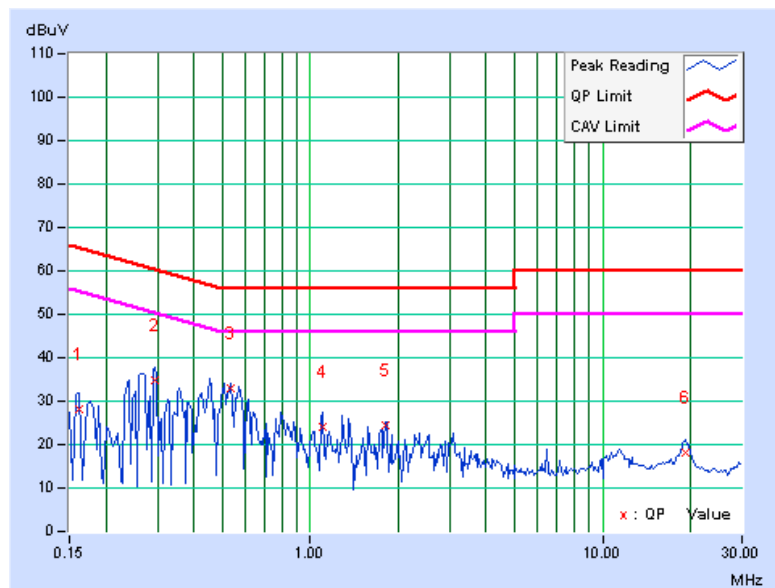

## 4.2 RADIATED EMISSION MEASUREMENT

### 4.2.1 LIMITS OF RADIATED EMISSION MEASUREMENT

Emissions radiated outside of the specified bands, shall be according to the general radiated limits in 15.209 as following:

FREQUENCIES (MHz)	FIELD STRENGTH (microvolts/meter)	MEASUREMENT DISTANCE (meters)
0.009 ~ 0.490	2400/F(kHz)	300
0.490 ~ 1.705	24000/F(kHz)	30
1.705 ~ 30.0	30	30
30 ~ 88	100	3
88 ~ 216	150	3
216 ~ 960	200	3
Above 960	500	3

**NOTE:**

1. The lower limit shall apply at the transition frequencies.
2. Emission level (dBuV/m) = 20 log Emission level (uV/m).
3. As shown in 15.35(b), for frequencies above 1000MHz, the field strength limits are based on average detector, however, the peak field strength of any emission shall not exceed the maximum permitted average limits, specified above by more than 20dB under any condition of modulation.



## 4.2.2 TEST INSTRUMENTS

DESCRIPTION & MANUFACTURER	MODEL NO.	SERIAL NO.	CALIBRATED DATE	CALIBRATED UNTIL
HP Preamplifier	8447D	2432A03504	Mar. 04, 2011	Mar. 03, 2012
HP Preamplifier	8449B	3008A01201	Mar. 04, 2011	Mar. 03, 2012
Agilent Spectrum Analyzer	E4446A	MY46180403	Jun. 22, 2011	Jun. 21, 2012
Schwarzbeck Antenna	VULB 9168	137	Apr. 12, 2011	Apr. 11, 2012
Schwarzbeck Antenna	VHBA 9123	480	May 06, 2011	May 05, 2012
ADT. Turn Table	TT100	0306	NA	NA
ADT. Tower	AT100	0306	NA	NA
Software	ADT_Radiated_V 7.6.15.9.2	NA	NA	NA
SUHNER RF cable	SF102	CABLE-CH6	Aug. 19, 2011	Aug. 18, 2012
Schwarzbeck Horn Antenna	BBHA 9120-D1	D130	May 16, 2011	May 15, 2012
Highpass filter Wainwright Instruments	WHK 3.1/18G-10SS	SN 8	NA	NA

- NOTE:**
1. The calibration interval of the above test instruments is 12/24 months. And the calibrations are traceable to NML/ROC and NIST/USA.
  2. The horn antenna and HP preamplifier (model: 8449B) are used only for the measurement of emission frequency above 1GHz if tested.
  3. The test was performed in Chamber No. 6.
  4. The Industry Canada Reference No. IC 7450E-6.
  5. The FCC Site Registration No. is 447212.

### 4.2.3 TEST PROCEDURES

- a. The EUT was placed on the top of a rotating table 0.8 meters above the ground at a 3 meter semi-anechoic chamber. The table was rotated 360 degrees to determine the position of the highest radiation.
- b. The EUT was set 3 meters away from the interference-receiving antenna, which was mounted on the top of a variable-height antenna tower.
- c. The height of antenna is varied from one meter to four meters above the ground to determine the maximum value of the field strength. Both horizontal and vertical polarizations of the antenna are set to make the measurement.
- d. For each suspected emission, the EUT was arranged to its worst case and then the antenna was tuned to heights from 1 meter to 4 meters and the rotatable table was turned from 0 degrees to 360 degrees to find the maximum reading.
- e. The test-receiver system was set to quasi-peak detect function and specified bandwidth with maximum hold mode when the test frequency is below 1 GHz.
- f. If the emission level of the EUT in peak mode was lower than the limit specified, then testing could be stopped and the peak values of the EUT would be reported. Otherwise the emissions would be re-tested one by one using peak, quasi-peak or average method as specified and then reported in a data sheet.

**NOTE:**

1. The resolution bandwidth and video bandwidth of test receiver/spectrum analyzer is 120kHz for Peak detection (PK) and Quasi-peak detection (QP) at frequency below 1GHz.
2. The resolution bandwidth of test receiver/spectrum analyzer is 1 MHz and video bandwidth is 3MHz for Peak detection at frequency above 1GHz.
3. The resolution bandwidth of test receiver/spectrum analyzer is 1MHz and the video bandwidth is 10Hz for Average detection (AV) at frequency above 1GHz.
4. All modes of operation were investigated and the worst-case emissions are reported.

### 4.2.4 DEVIATION FROM TEST STANDARD

No deviation



## 4.2.5 TEST SETUP

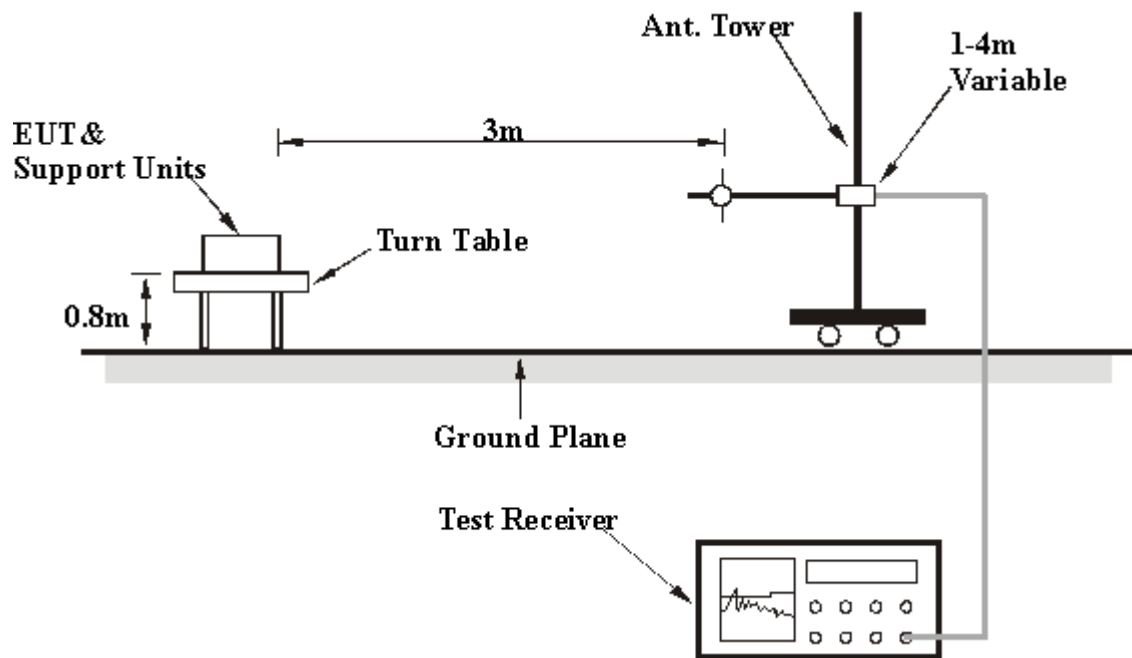

For the actual test configuration, please refer to the related item – Photographs of the Test Configuration.

## 4.2.6 EUT OPERATING CONDITIONS

Same as item 4.1.6.



A D T

## 4.2.7 TEST RESULTS

### GFSK MODULATION

EUT TEST CONDITION		MEASUREMENT DETAIL	
CHANNEL	Channel 0	FREQUENCY RANGE	1 ~ 25GHz
INPUT POWER (SYSTEM)	120Vac, 60Hz	DETECTOR FUNCTION	Peak (PK) Average (AV)
ENVIRONMENTAL CONDITIONS	23deg. C, 65% RH	TESTED BY	Chad Lee
TEST MODE	A		

ANTENNA POLARITY & TEST DISTANCE: HORIZONTAL AT 3 M								
NO.	FREQ. (MHz)	EMISSION LEVEL (dBuV/m)	LIMIT (dBuV/m)	MARGIN (dB)	ANTENNA HEIGHT (m)	TABLE ANGLE (Degree)	RAW VALUE (dBuV)	CORRECTION FACTOR (dB/m)
1	2390.00	50.3 PK	74.0	-23.7	1.32 H	171	20.09	30.24
2	2390.00	40.3 AV	54.0	-13.8	1.32 H	171	10.01	30.24
3	2400.00	45.8 PK	74.0	-28.2	1.32 H	171	15.49	30.29
4	2400.00	7.7 AV	54.0	-46.3	1.32 H	171	-22.61	30.29
5	*2402.00	65.8 PK			1.32 H	171	35.49	30.30
6	*2402.00	27.7 AV			1.32 H	171	-2.61	30.30
7	4804.00	45.5 PK	74.0	-28.5	1.00 H	92	8.90	36.59
8	4804.00	7.4 AV	54.0	-46.6	1.00 H	92	-29.20	36.59
ANTENNA POLARITY & TEST DISTANCE: VERTICAL AT 3 M								
NO.	FREQ. (MHz)	EMISSION LEVEL (dBuV/m)	LIMIT (dBuV/m)	MARGIN (dB)	ANTENNA HEIGHT (m)	TABLE ANGLE (Degree)	RAW VALUE (dBuV)	CORRECTION FACTOR (dB/m)
1	2390.00	51.6 PK	74.0	-22.4	1.00 V	111	21.33	30.24
2	2390.00	41.8 AV	54.0	-12.2	1.00 V	111	11.52	30.24
3	2400.00	39.1 PK	74.0	-34.9	1.00 V	111	8.85	30.29
4	2400.00	1.0 AV	54.0	-53.0	1.00 V	111	-29.25	30.29
5	*2402.00	59.2 PK			1.00 V	111	28.85	30.30
6	*2402.00	21.1 AV			1.00 V	111	-9.25	30.30
7	4804.00	44.6 PK	74.0	-29.4	1.00 V	16	8.05	36.59
8	4804.00	6.5 AV	54.0	-47.5	1.00 V	16	-30.05	36.59

- REMARKS:**
- Emission level (dBuV/m) = Raw Value (dBuV) + Correction Factor (dB/m).
  - Correction Factor (dB/m) = Antenna Factor (dB/m) + Cable Factor (dB).
  - The other emission levels were very low against the limit.
  - Margin value = Emission level – Limit value.
  - \* \* \*: Fundamental frequency.
  - The DH1 packet was the worse case duty cycle for a transmit dwell time on a channel, based upon bluetooth theory the transmitter is on 0.625 \* 2 per 296.25 ms per channel. Therefore, the duty cycle correlation factor be equal to:  $20\log(1.25 / 100) = -38.1$  dB.
  - Average value = peak reading +  $20\log(\text{duty cycle})$ .

EUT TEST CONDITION		MEASUREMENT DETAIL	
CHANNEL	Channel 39	FREQUENCY RANGE	1 ~ 25GHz
INPUT POWER (SYSTEM)	120Vac, 60Hz	DETECTOR FUNCTION	Peak (PK) Average (AV)
ENVIRONMENTAL CONDITIONS	23deg. C, 65% RH	TESTED BY	Chad Lee
TEST MODE	A		

ANTENNA POLARITY & TEST DISTANCE: HORIZONTAL AT 3 M								
NO.	FREQ. (MHz)	EMISSION LEVEL (dBuV/m)	LIMIT (dBuV/m)	MARGIN (dB)	ANTENNA HEIGHT (m)	TABLE ANGLE (Degree)	RAW VALUE (dBuV)	CORRECTION FACTOR (dB/m)
1	*2441.00	64.5 PK			1.24 H	194	34.06	30.43
2	*2441.00	26.4 AV			1.24 H	194	-4.04	30.43
3	4882.00	45.4 PK	74.0	-28.6	1.00 H	6	8.65	36.79
4	4882.00	7.3 AV	54.0	-46.7	1.00 H	6	-29.45	36.79
ANTENNA POLARITY & TEST DISTANCE: VERTICAL AT 3 M								
NO.	FREQ. (MHz)	EMISSION LEVEL (dBuV/m)	LIMIT (dBuV/m)	MARGIN (dB)	ANTENNA HEIGHT (m)	TABLE ANGLE (Degree)	RAW VALUE (dBuV)	CORRECTION FACTOR (dB/m)
1	*2441.00	61.9 PK			1.07 V	184	31.45	30.43
2	*2441.00	23.8 AV			1.07 V	184	-6.65	30.43
3	4882.00	44.3 PK	74.0	-29.7	1.00 V	334	7.54	36.79
4	4882.00	6.2 AV	54.0	-47.8	1.00 V	334	-30.56	36.79

- REMARKS:**
1. Emission level (dBuV/m) = Raw Value (dBuV) + Correction Factor (dB/m).
  2. Correction Factor (dB/m) = Antenna Factor (dB/m) + Cable Factor (dB).
  3. The other emission levels were very low against the limit.
  4. Margin value = Emission level – Limit value.
  5. “ \* “: Fundamental frequency.
  6. The DH1 packet was the worse case duty cycle for a transmit dwell time on a channel, based upon bluetooth theory the transmitter is on 0.625 \* 2 per 296.25 ms per channel. Therefore, the duty cycle correlation factor be equal to:  $20\log(1.25 / 100) = -38.1$  dB.
  7. Average value = peak reading +  $20\log(\text{duty cycle})$ .



A D T

EUT TEST CONDITION		MEASUREMENT DETAIL	
CHANNEL	Channel 78	FREQUENCY RANGE	1 ~ 25GHz
INPUT POWER (SYSTEM)	120Vac, 60Hz	DETECTOR FUNCTION	Peak (PK) Average (AV)
ENVIRONMENTAL CONDITIONS	23deg. C, 65% RH	TESTED BY	Chad Lee
TEST MODE	A		

ANTENNA POLARITY & TEST DISTANCE: HORIZONTAL AT 3 M								
NO.	FREQ. (MHz)	EMISSION LEVEL (dBuV/m)	LIMIT (dBuV/m)	MARGIN (dB)	ANTENNA HEIGHT (m)	TABLE ANGLE (Degree)	RAW VALUE (dBuV)	CORRECTION FACTOR (dB/m)
1	*2480.00	62.2 PK			1.18 H	194	31.63	30.56
2	*2480.00	24.1 AV			1.18 H	194	-6.47	30.56
3	2483.50	42.2 PK	74.0	-31.8	1.18 H	194	11.66	30.57
4	2483.50	4.1 AV	54.0	-49.9	1.18 H	194	-26.44	30.57
5	4960.00	45.6 PK	74.0	-28.4	1.00 H	16	8.61	36.99
6	4960.00	7.5 AV	54.0	-46.5	1.00 H	16	-29.49	36.99
ANTENNA POLARITY & TEST DISTANCE: VERTICAL AT 3 M								
NO.	FREQ. (MHz)	EMISSION LEVEL (dBuV/m)	LIMIT (dBuV/m)	MARGIN (dB)	ANTENNA HEIGHT (m)	TABLE ANGLE (Degree)	RAW VALUE (dBuV)	CORRECTION FACTOR (dB/m)
1	*2480.00	59.1 PK			1.00 V	217	28.53	30.56
2	*2480.00	21.0 AV			1.00 V	217	-9.57	30.56
3	2483.50	39.1 PK	74.0	-34.9	1.00 V	217	8.56	30.57
4	2483.50	1.0 AV	54.0	-53.0	1.00 V	217	-29.54	30.57
5	4960.00	44.1 PK	74.0	-29.9	1.00 V	6	7.10	36.99
6	4960.00	6.0 AV	54.0	-48.0	1.00 V	6	-31.00	36.99

- REMARKS:**
1. Emission level (dBuV/m) = Raw Value (dBuV) + Correction Factor (dB/m).
  2. Correction Factor (dB/m) = Antenna Factor (dB/m) + Cable Factor (dB).
  3. The other emission levels were very low against the limit.
  4. Margin value = Emission level – Limit value.
  5. “ \* “: Fundamental frequency.
  6. The DH1 packet was the worse case duty cycle for a transmit dwell time on a channel, based upon bluetooth theory the transmitter is on 0.625 \* 2 per 296.25 ms per channel. Therefore, the duty cycle correlation factor be equal to:  $20\log(1.25 / 100) = -38.1$  dB.
  7. Average value = peak reading +  $20\log(\text{duty cycle})$ .

## 8DPSK MODULATION

EUT TEST CONDITION		MEASUREMENT DETAIL	
CHANNEL	Channel 0	FREQUENCY RANGE	1 ~ 25GHz
INPUT POWER (SYSTEM)	120Vac, 60Hz	DETECTOR FUNCTION	Peak (PK) Average (AV)
ENVIRONMENTAL CONDITIONS	23deg. C, 65% RH	TESTED BY	Chad Lee
TEST MODE	A		

ANTENNA POLARITY & TEST DISTANCE: HORIZONTAL AT 3 M								
NO.	FREQ. (MHz)	EMISSION LEVEL (dBuV/m)	LIMIT (dBuV/m)	MARGIN (dB)	ANTENNA HEIGHT (m)	TABLE ANGLE (Degree)	RAW VALUE (dBuV)	CORRECTION FACTOR (dB/m)
1	2390.00	53.8 PK	74.0	-20.2	1.20 H	229	23.52	30.24
2	2390.00	43.3 AV	54.0	-10.7	1.20 H	229	13.08	30.24
3	2400.00	45.5 PK	74.0	-28.5	1.20 H	229	15.23	30.29
4	2400.00	7.4 AV	54.0	-46.6	1.20 H	229	-22.87	30.29
5	*2402.00	64.3 PK			1.20 H	229	34.01	30.30
6	*2402.00	26.2 AV			1.20 H	229	-4.09	30.30
7	4804.00	47.8 PK	74.0	-26.3	1.00 H	97	11.16	36.59
8	4804.00	9.7 AV	54.0	-44.4	1.00 H	97	-26.94	36.59
ANTENNA POLARITY & TEST DISTANCE: VERTICAL AT 3 M								
NO.	FREQ. (MHz)	EMISSION LEVEL (dBuV/m)	LIMIT (dBuV/m)	MARGIN (dB)	ANTENNA HEIGHT (m)	TABLE ANGLE (Degree)	RAW VALUE (dBuV)	CORRECTION FACTOR (dB/m)
1	2390.00	50.8 PK	74.0	-23.2	1.06 V	191	20.56	30.24
2	2390.00	40.7 AV	54.0	-13.4	1.06 V	191	10.41	30.24
3	2400.00	41.2 PK	74.0	-32.8	1.06 V	191	10.94	30.29
4	2400.00	3.1 AV	54.0	-50.9	1.06 V	191	-27.16	30.29
5	*2402.00	60.0 PK			1.06 V	191	29.72	30.30
6	*2402.00	21.9 AV			1.06 V	191	-8.38	30.30
7	4804.00	43.6 PK	74.0	-30.5	1.00 V	112	6.96	36.59
8	4804.00	5.5 AV	54.0	-48.6	1.00 V	112	-31.14	36.59

- REMARKS:**
1. Emission level (dBuV/m) = Raw Value (dBuV) + Correction Factor (dB/m).
  2. Correction Factor (dB/m) = Antenna Factor (dB/m) + Cable Factor (dB).
  3. The other emission levels were very low against the limit.
  4. Margin value = Emission level – Limit value.
  5. “ \* “: Fundamental frequency.
  6. The DH1 packet was the worse case duty cycle for a transmit dwell time on a channel, based upon bluetooth theory the transmitter is on 0.625 \* 2 per 296.25 ms per channel. Therefore, the duty cycle correlation factor be equal to:  $20\log(1.25 / 100) = -38.1 \text{ dB}$ .
  7. Average value = peak reading +  $20\log(\text{duty cycle})$ .



A D T

EUT TEST CONDITION		MEASUREMENT DETAIL	
CHANNEL	Channel 39	FREQUENCY RANGE	1 ~ 25GHz
INPUT POWER (SYSTEM)	120Vac, 60Hz	DETECTOR FUNCTION	Peak (PK) Average (AV)
ENVIRONMENTAL CONDITIONS	23deg. C, 65% RH	TESTED BY	Chad Lee
TEST MODE	A		

ANTENNA POLARITY & TEST DISTANCE: HORIZONTAL AT 3 M								
NO.	FREQ. (MHz)	EMISSION LEVEL (dBuV/m)	LIMIT (dBuV/m)	MARGIN (dB)	ANTENNA HEIGHT (m)	TABLE ANGLE (Degree)	RAW VALUE (dBuV)	CORRECTION FACTOR (dB/m)
1	*2441.00	64.1 PK			1.00 H	109	33.67	30.43
2	*2441.00	26.0 AV			1.00 H	109	-4.43	30.43
3	4882.00	45.0 PK	74.0	-29.1	1.00 H	100	8.16	36.79
4	4882.00	6.9 AV	54.0	-47.2	1.00 H	100	-29.94	36.79
ANTENNA POLARITY & TEST DISTANCE: VERTICAL AT 3 M								
NO.	FREQ. (MHz)	EMISSION LEVEL (dBuV/m)	LIMIT (dBuV/m)	MARGIN (dB)	ANTENNA HEIGHT (m)	TABLE ANGLE (Degree)	RAW VALUE (dBuV)	CORRECTION FACTOR (dB/m)
1	*2441.00	61.7 PK			1.00 V	255	31.29	30.43
2	*2441.00	23.6 AV			1.00 V	255	-6.81	30.43
3	4882.00	43.9 PK	74.0	-30.1	1.00 V	16	7.12	36.79
4	4882.00	5.8 AV	54.0	-48.2	1.00 V	16	-30.98	36.79

- REMARKS:**
1. Emission level (dBuV/m) = Raw Value (dBuV) + Correction Factor (dB/m).
  2. Correction Factor (dB/m) = Antenna Factor (dB/m) + Cable Factor (dB).
  3. The other emission levels were very low against the limit.
  4. Margin value = Emission level – Limit value.
  5. “ \* “: Fundamental frequency.
  6. The DH1 packet was the worse case duty cycle for a transmit dwell time on a channel, based upon bluetooth theory the transmitter is on 0.625 \* 2 per 296.25 ms per channel. Therefore, the duty cycle correlation factor be equal to:  $20\log(1.25 / 100) = -38.1$  dB.
  7. Average value = peak reading +  $20\log(\text{duty cycle})$ .



A D T

EUT TEST CONDITION		MEASUREMENT DETAIL	
CHANNEL	Channel 78	FREQUENCY RANGE	1 ~ 25GHz
INPUT POWER (SYSTEM)	120Vac, 60Hz	DETECTOR FUNCTION	Peak (PK) Average (AV)
ENVIRONMENTAL CONDITIONS	23deg. C, 65% RH	TESTED BY	Chad Lee
TEST MODE	A		

ANTENNA POLARITY & TEST DISTANCE: HORIZONTAL AT 3 M								
NO.	FREQ. (MHz)	EMISSION LEVEL (dBuV/m)	LIMIT (dBuV/m)	MARGIN (dB)	ANTENNA HEIGHT (m)	TABLE ANGLE (Degree)	RAW VALUE (dBuV)	CORRECTION FACTOR (dB/m)
1	*2480.00	63.1 PK			1.22 H	193	32.52	30.56
2	*2480.00	25.0 AV			1.22 H	193	-5.58	30.56
3	2483.50	44.5 PK	74.0	-29.5	1.00 H	193	13.96	30.57
4	2483.50	6.4 AV	54.0	-47.6	1.00 H	193	-24.14	30.57
5	4960.00	47.5 PK	74.0	-26.5	1.00 H	18	10.47	36.99
6	4960.00	9.4 AV	54.0	-44.6	1.00 H	18	-27.63	36.99
ANTENNA POLARITY & TEST DISTANCE: VERTICAL AT 3 M								
NO.	FREQ. (MHz)	EMISSION LEVEL (dBuV/m)	LIMIT (dBuV/m)	MARGIN (dB)	ANTENNA HEIGHT (m)	TABLE ANGLE (Degree)	RAW VALUE (dBuV)	CORRECTION FACTOR (dB/m)
1	*2480.00	61.4 PK			1.00 V	271	30.85	30.56
2	*2480.00	23.3 AV			1.00 V	271	-7.25	30.56
3	2483.50	42.9 PK	74.0	-31.1	1.00 V	217	12.29	30.57
4	2483.50	4.8 AV	54.0	-49.2	1.00 V	217	-25.81	30.57
5	4960.00	46.4 PK	74.0	-27.6	1.00 V	214	9.37	36.99
6	4960.00	8.3 AV	54.0	-45.7	1.00 V	214	-28.73	36.99

- REMARKS:**
- Emission level (dBuV/m) = Raw Value (dBuV) + Correction Factor (dB/m).
  - Correction Factor (dB/m) = Antenna Factor (dB/m) + Cable Factor (dB).
  - The other emission levels were very low against the limit.
  - Margin value = Emission level – Limit value.
  - \* \*: Fundamental frequency.
  - The DH1 packet was the worse case duty cycle for a transmit dwell time on a channel, based upon bluetooth theory the transmitter is on 0.625 \* 2 per 296.25 ms per channel. Therefore, the duty cycle correlation factor be equal to:  $20\log(1.25 / 100) = -38.1$  dB.
  - Average value = peak reading +  $20\log(\text{duty cycle})$ .

**BELOW 1GHz WORST-CASE DATA : GFSK MODULATION**

EUT TEST CONDITION		MEASUREMENT DETAIL	
CHANNEL	Channel 0	FREQUENCY RANGE	Below 1000MHz
INPUT POWER (SYSTEM)	120Vac, 60Hz	DETECTOR FUNCTION	Quasi-Peak
ENVIRONMENTAL CONDITIONS	18deg. C, 76% RH	TESTED BY	Nick Chen
TEST MODE	A		

ANTENNA POLARITY & TEST DISTANCE: HORIZONTAL AT 3 M								
NO.	FREQ. (MHz)	EMISSION LEVEL (dBuV/m)	LIMIT (dBuV/m)	MARGIN (dB)	ANTENNA HEIGHT (m)	TABLE ANGLE (Degree)	RAW VALUE (dBuV)	CORRECTION FACTOR (dB/m)
1	54.21	30.2 QP	40.0	-9.9	1.12 H	145	16.52	13.63
2	123.61	32.4 QP	43.5	-11.1	1.24 H	211	19.85	12.53
3	134.91	39.8 QP	43.5	-3.7	1.34 H	229	26.50	13.31
4	175.26	30.7 QP	43.5	-12.8	1.07 H	136	16.91	13.80
5	233.36	32.0 QP	46.0	-14.0	1.24 H	274	19.17	12.81
6	620.72	37.7 QP	46.0	-8.3	1.33 H	241	14.13	23.58
7	796.64	31.9 QP	46.0	-14.1	1.00 H	253	5.36	26.53
ANTENNA POLARITY & TEST DISTANCE: VERTICAL AT 3 M								
NO.	FREQ. (MHz)	EMISSION LEVEL (dBuV/m)	LIMIT (dBuV/m)	MARGIN (dB)	ANTENNA HEIGHT (m)	TABLE ANGLE (Degree)	RAW VALUE (dBuV)	CORRECTION FACTOR (dB/m)
1	62.28	29.9 QP	40.0	-10.2	1.05 V	202	16.71	13.14
2	81.65	37.9 QP	40.0	-2.1	1.11 V	262	27.97	9.94
3	122.00	31.1 QP	43.5	-12.4	1.14 V	157	18.64	12.42
4	134.91	39.6 QP	43.5	-4.0	1.07 V	160	26.24	13.31
5	594.89	34.0 QP	46.0	-12.1	1.24 V	64	10.63	23.32
6	880.57	35.3 QP	46.0	-10.7	1.03 V	289	7.72	27.57
7	948.35	34.2 QP	46.0	-11.8	1.00 V	319	5.79	28.42

- REMARKS:**
1. Emission level (dBuV/m) = Raw Value (dBuV) + Correction Factor (dB/m).
  2. Correction Factor (dB/m) = Antenna Factor (dB/m) + Cable Factor (dB).
  3. The other emission levels were very low against the limit.
  4. Margin value = Emission level – Limit value.





### 4.3 NUMBER OF HOPPING FREQUENCY USED

#### 4.3.1 LIMIT OF HOPPING FREQUENCY USED

At least 15 channels frequencies, and should be equally spaced.

#### 4.3.2 TEST INSTRUMENTS

DESCRIPTION & MANUFACTURER	MODEL NO.	SERIAL NO.	CALIBRATED DATE	CALIBRATED UNTIL
SPECTRUM ANALYZER	FSP 40	100036	Apr. 29, 2011	Apr. 28, 2012

**NOTE:** The calibration interval of the above test instruments is 12 months and the calibrations are traceable to NML/ROC and NIST/USA.

#### 4.3.3 TEST PROCEDURES

- a. Check the calibration of the measuring instrument (SA) using either an internal calibrator or a known signal from an external generator.
- b. Turn on the EUT and connect its antenna terminal to measurement via a low loss cable. Then set it to any one measured frequency within its operating range and make sure the instrument is operated in its linear range.
- c. Set the SA on MaxHold Mode, and then keep the EUT in hopping mode. Record all the signals from each channel until each one has been recorded.
- d. Set the SA on View mode and then plot the result on SA screen.
- e. Repeat above procedures until all frequencies measured were complete.

#### 4.3.4 DEVIATION FROM TEST STANDARD

No deviation.

#### 4.3.5 TEST SETUP

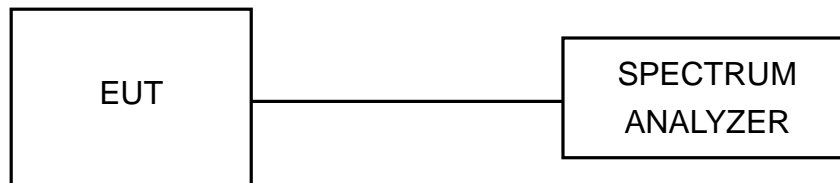

#### 4.3.6 TEST RESULTS

There are 79 hopping frequencies in the hopping mode. Please refer to next two pages for the test result. On the plots, it shows that the hopping frequencies are equally spaced.



A D T

### Mode A: FOR GFSK

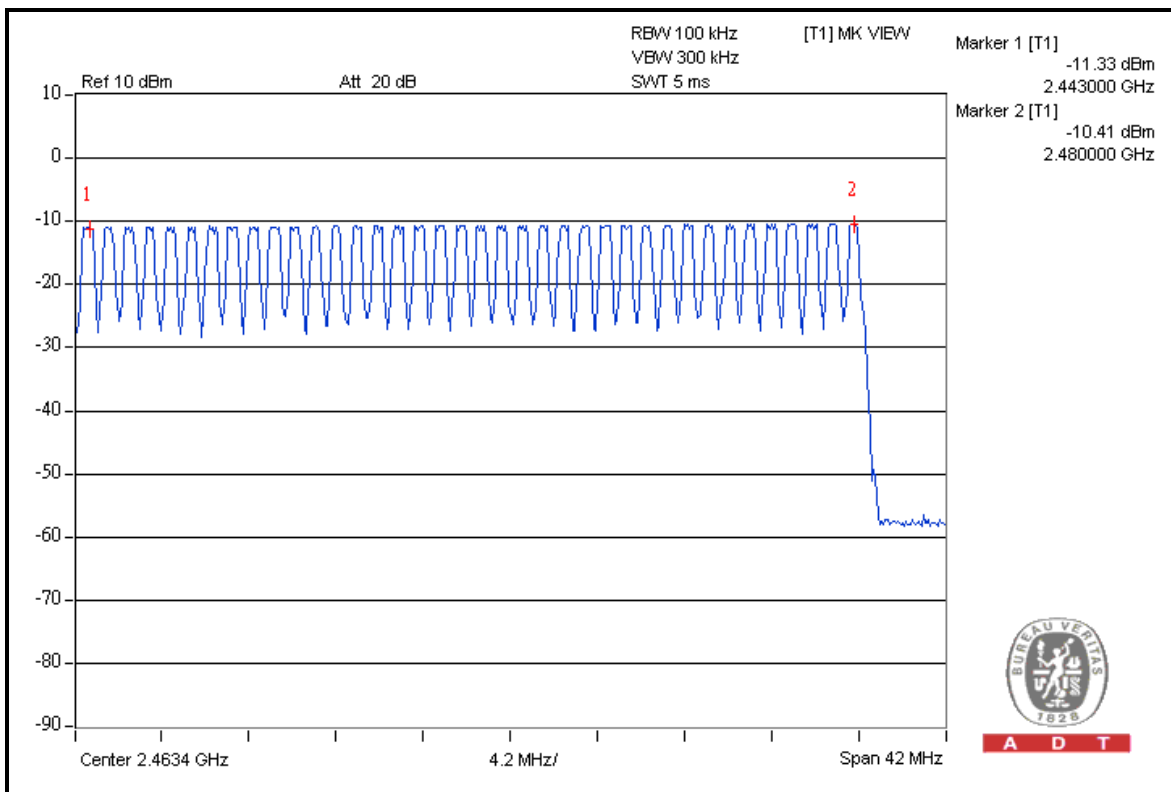
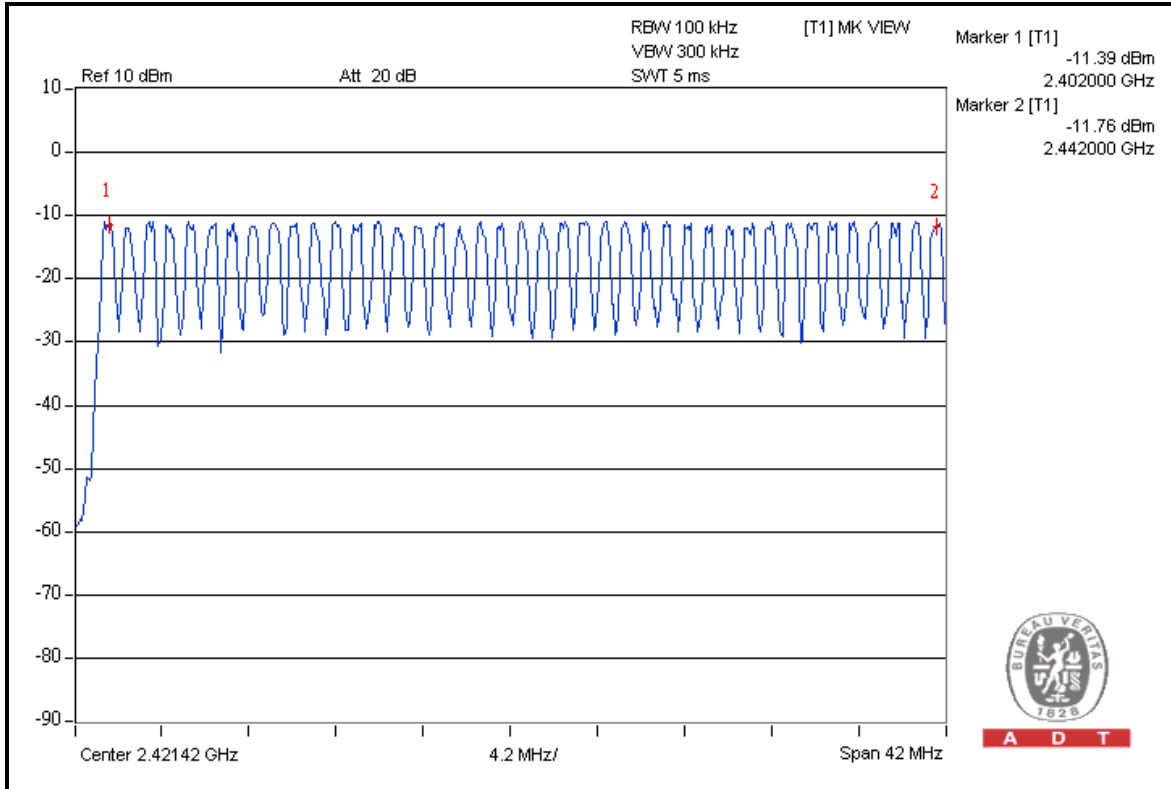



A D T

### Mode A: FOR 8DPSK

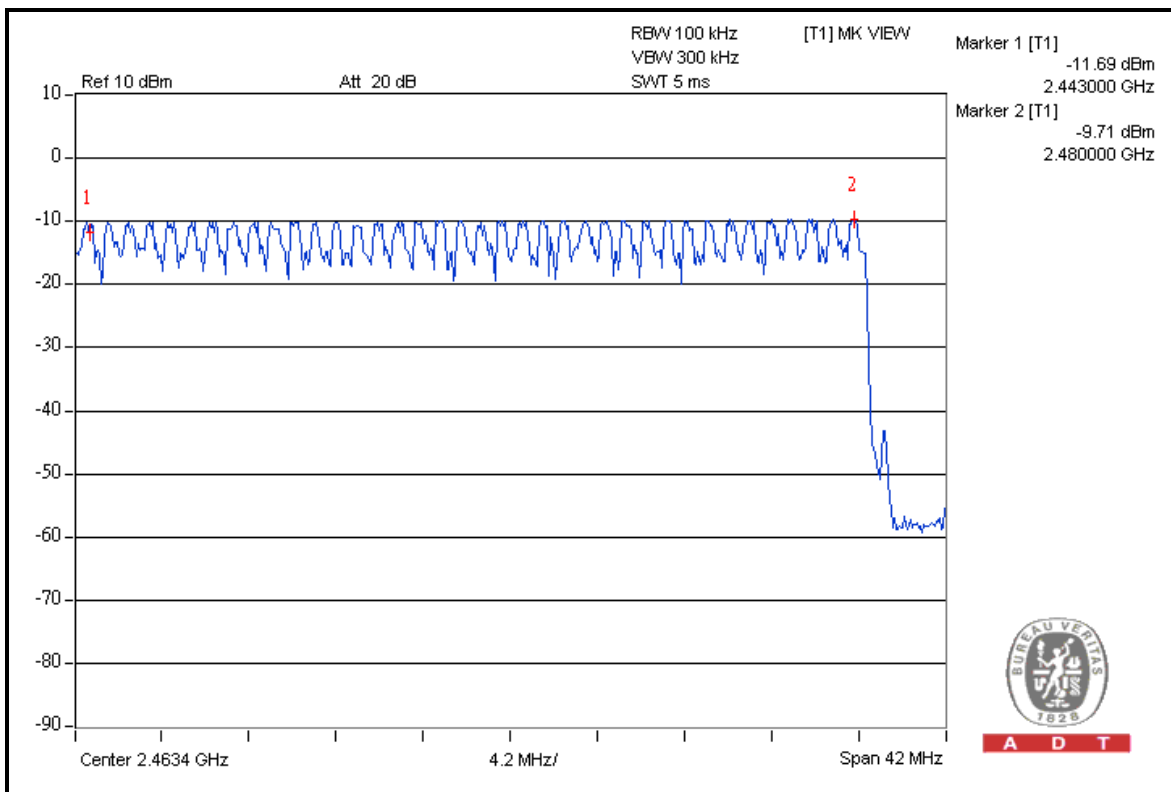
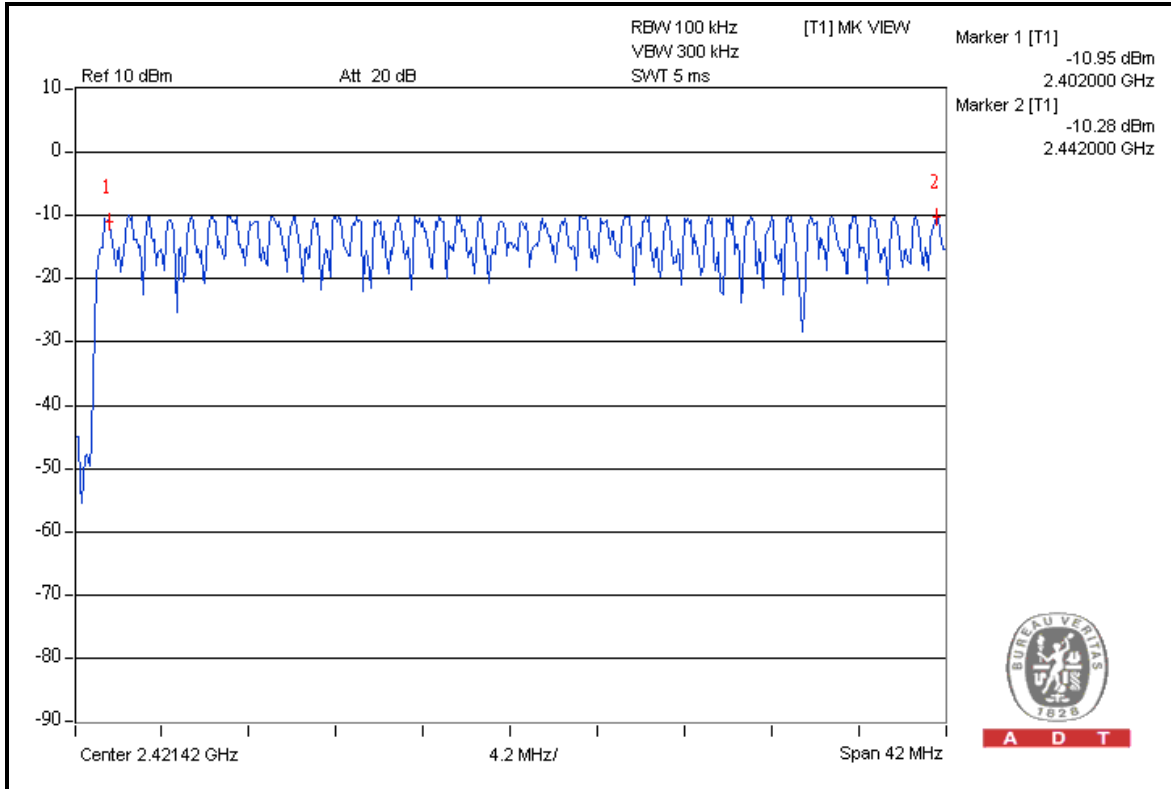

## 4.4 DWELL TIME ON EACH CHANNEL

### 4.4.1 LIMIT OF DWELL TIME USED

The average time of occupancy on any channel shall not be greater than 0.4 seconds within a period of 0.4 seconds multiplied by the number of hopping channels employed.

### 4.4.2 TEST INSTRUMENTS

DESCRIPTION & MANUFACTURER	MODEL NO.	SERIAL NO.	CALIBRATED DATE	CALIBRATED UNTIL
SPECTRUM ANALYZER	FSP 40	100036	Apr. 29, 2011	Apr. 28, 2012

**NOTE:** The calibration interval of the above test instruments is 12 months and the calibrations are traceable to NML/ROC and NIST/USA.

### 4.4.3 TEST PROCEDURES

- a. Check the calibration of the measuring instrument (SA) using either an internal calibrator or a known signal from an external generator.
- b. Turn on the EUT and connect its antenna terminal to measurement via a low loss cable. Then set it to any one measured frequency within its operating range and make sure the instrument is operated in its linear range.
- c. Adjust the center frequency of SA on any frequency be measured and set SA to zero span mode. And then, set RBW and VBW of spectrum analyzer to proper value.
- d. Measure the time duration of one transmission on the measured frequency. And then plot the result with time difference of this time duration.
- e. Repeat above procedures until all different time-slot modes have been completed.

### 4.4.4 DEVIATION FROM TEST STANDARD

No deviation.

#### 4.4.5 TEST SETUP

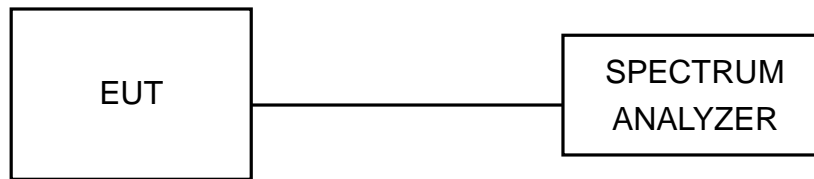

#### 4.4.6 TEST RESULTS

Mode A: FOR GFSK

Mode	Number of transmission in a 31.6 (79Hopping*0.4)	Length of transmission time (msec)	Result (msec)	Limit (msec)
DH1	50 (times / 5 sec) *6.32=316.00times	0.246	77.736	400

**NOTE:** Test plots of the transmitting time slot are shown on next page.



A D T

### DH1

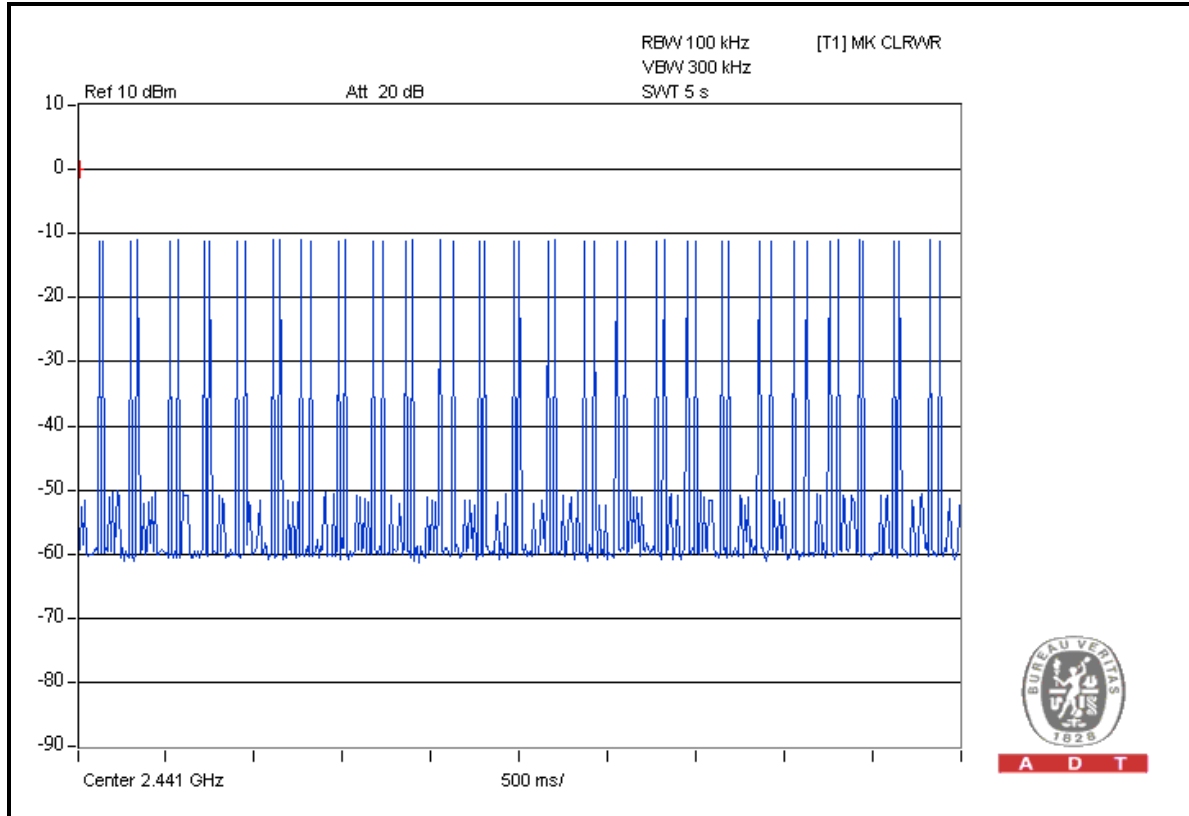

A D T

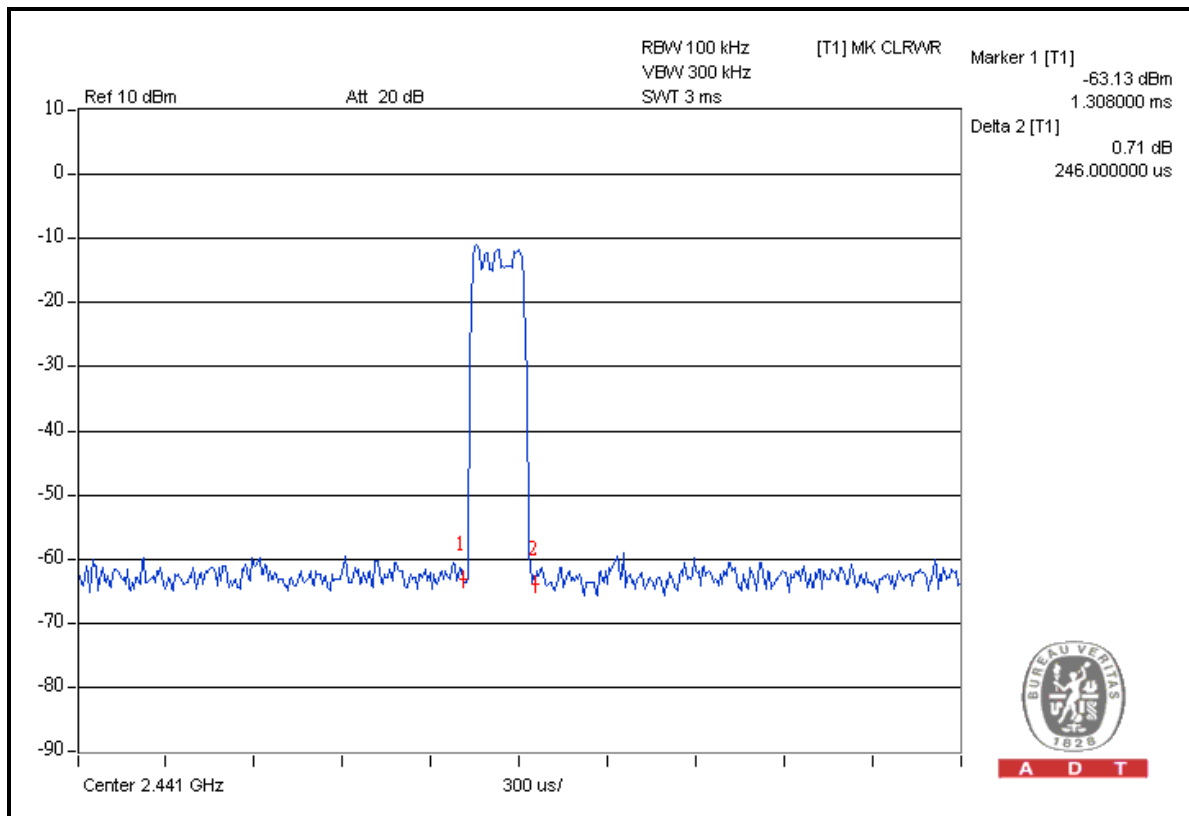

A D T



A D T

**Mode A: FOR 8DPSK**

Mode	Number of transmission in a 31.6 (79Hopping*0.4)	Length of transmission time (msec)	Result (msec)	Limit (msec)
DH1	50 (times / 5 sec) *6.32=316.00times	0.258	81.528	400

**NOTE:** Test plots of the transmitting time slot are shown on next page.





A D T

# DH1

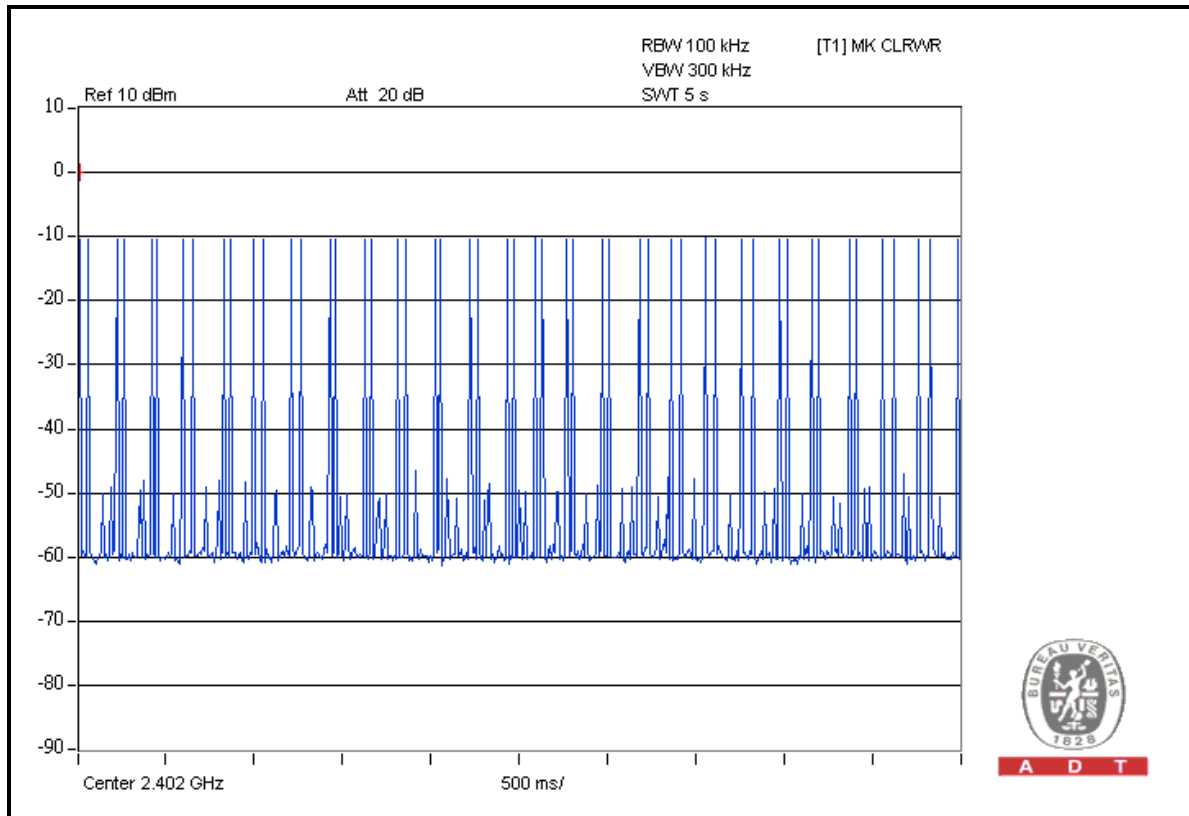

A D T

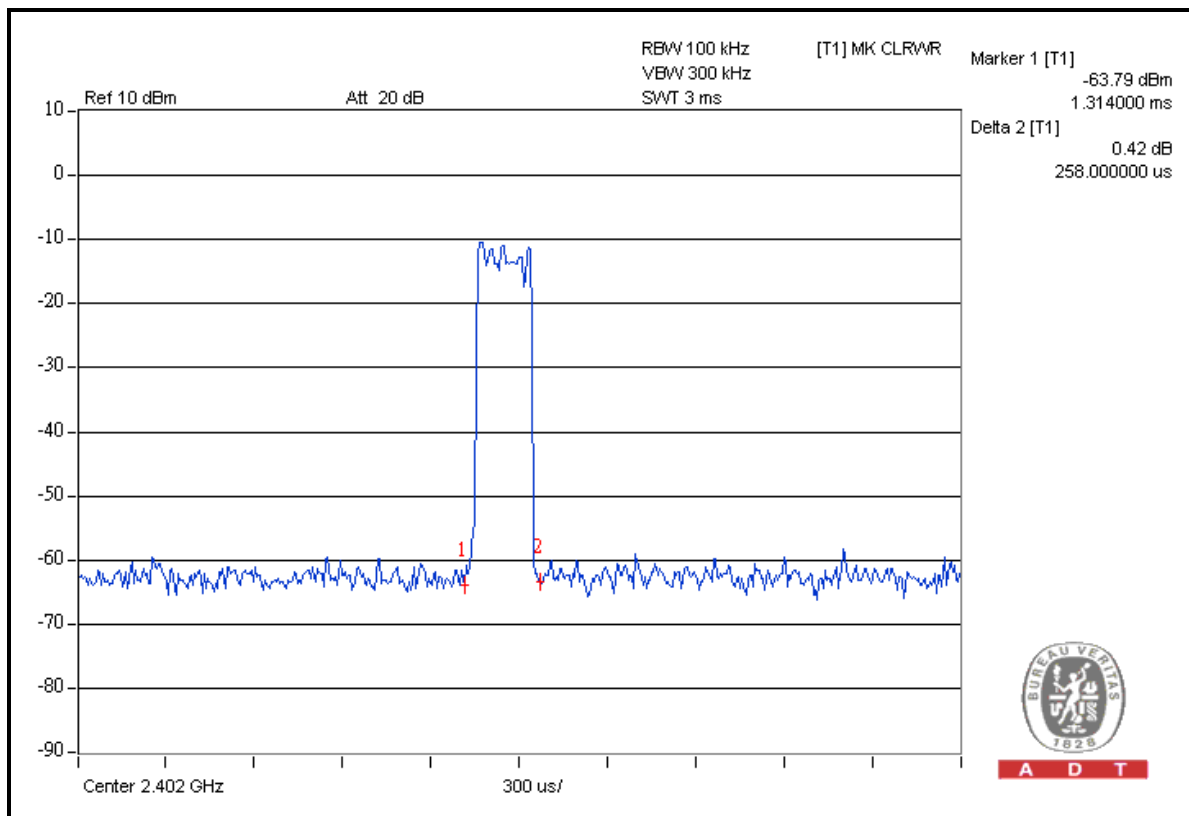

A D T

## 4.5 CHANNEL BANDWIDTH

### 4.5.1 LIMITS OF CHANNEL BANDWIDTH

For frequency hopping system operating in the 2400-2483.5MHz, If the 20dB bandwidth of hopping channel is greater than 25kHz, two-thirds 20dB bandwidth of hopping channel shall be a minimum limit for the hopping channel separation.

### 4.5.2 TEST INSTRUMENTS

DESCRIPTION & MANUFACTURER	MODEL NO.	SERIAL NO.	CALIBRATED DATE	CALIBRATED UNTIL
SPECTRUM ANALYZER	FSP 40	100036	Apr. 29, 2011	Apr. 28, 2012

**NOTE:** The calibration interval of the above test instruments is 12 months and the calibrations are traceable to NML/ROC and NIST/USA.

### 4.5.3 TEST PROCEDURE

- a. Check the calibration of the measuring instrument using either an internal calibrator or a known signal from an external generator.
- b. Turn on the EUT and connect it to measurement instrument. Then set it to any one convenient frequency within its operating range. Set a reference level on the measuring instrument equal to the highest peak value.
- c. Measure the frequency difference of two frequencies that were attenuated 20dB from the reference level. Record the frequency difference as the emission bandwidth.
- d. Repeat above procedures until all frequencies measured were complete.

#### 4.5.4 DEVIATION FROM TEST STANDARD

No deviation.

#### 4.5.5 TEST SETUP

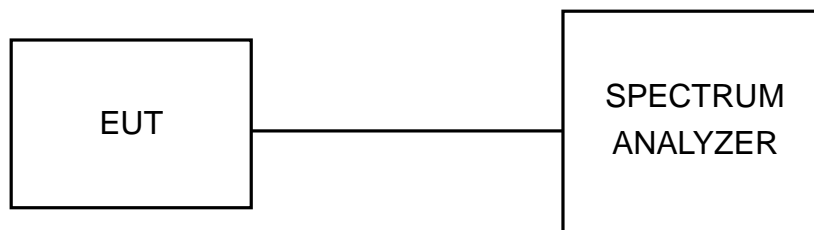

#### 4.5.6 EUT OPERATING CONDITION

The software provided by client enabled the EUT to transmit and receive data at lowest, middle and highest channel frequencies individually.



A D T

### 4.5.7 TEST RESULTS

#### Mode A: FOR GFSK

CHANNEL	CHANNEL FREQUENCY (MHz)	20dB BANDWIDTH (MHz)
0	2402	1.01
39	2441	0.97
78	2480	0.99

#### CH 0

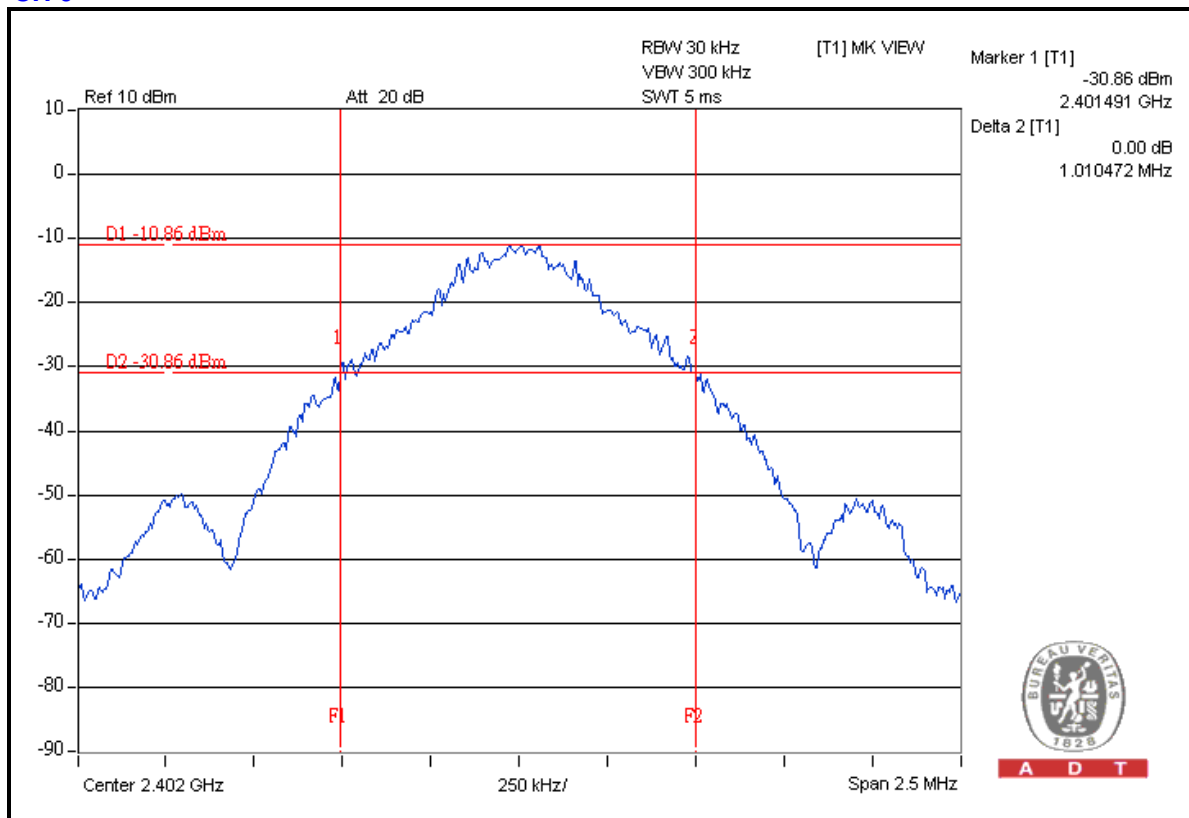



A D T

### Mode A: FOR 8DPSK

CHANNEL	CHANNEL FREQUENCY (MHz)	20dB BANDWIDTH (MHz)
0	2402	1.40
39	2441	1.38
78	2480	1.36

### CH 0

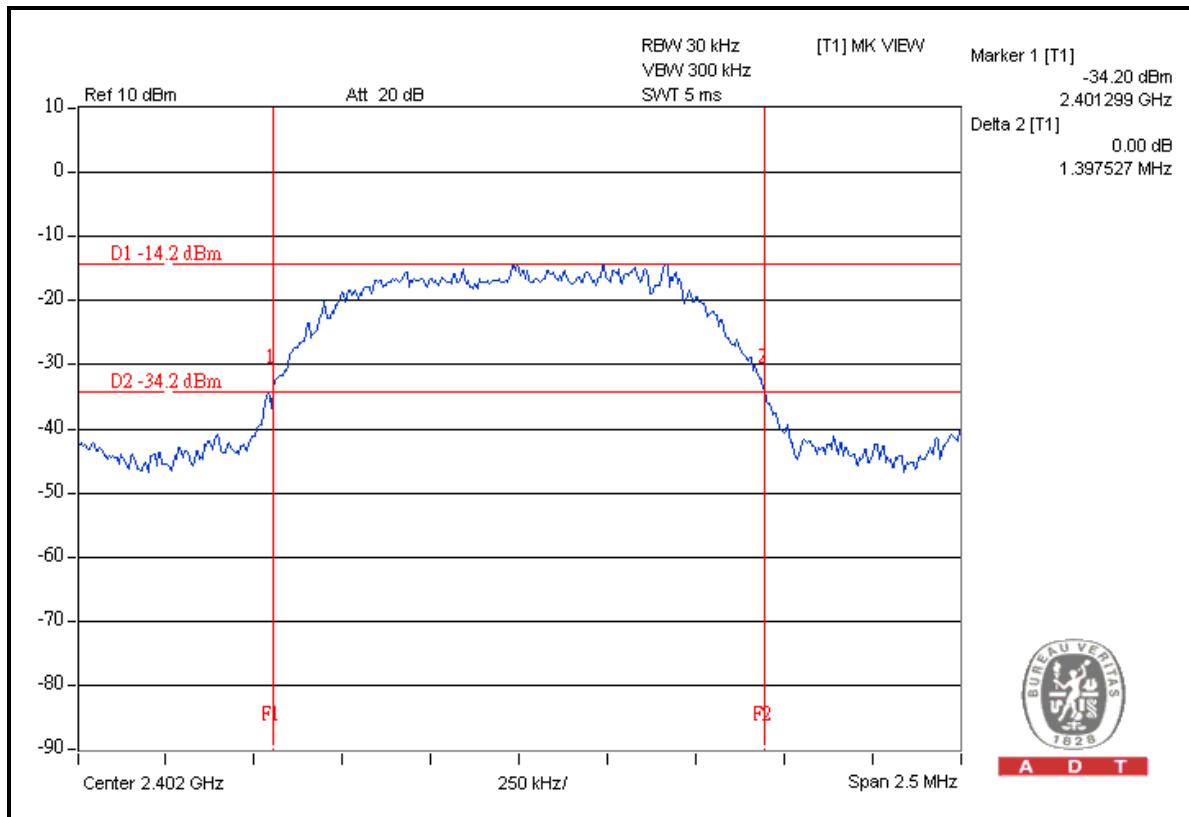

## 4.6 HOPPING CHANNEL SEPARATION

### 4.6.1 LIMIT OF HOPPING CHANNEL SEPARATION

At least 25kHz or two-third of 20dB hopping channel bandwidth (whichever is greater).

### 4.6.2 TEST INSTRUMENTS

DESCRIPTION & MANUFACTURER	MODEL NO.	SERIAL NO.	CALIBRATED DATE	CALIBRATED UNTIL
SPECTRUM ANALYZER	FSP 40	100036	Apr. 29, 2011	Apr. 28, 2012

**NOTE:** The calibration interval of the above test instruments is 12 months and the calibrations are traceable to NML/ROC and NIST/USA.

### 4.6.3 TEST PROCEDURES

1. Check the calibration of the measuring instrument using either an internal calibrator or a known signal from an external generator.
2. Turn on the EUT and connect it to measurement instrument. Then set it to any one convenient frequency within its operating range.
3. By using the MaxHold function record the separation of two adjacent channels.
4. Measure the frequency difference of these two adjacent channels by SA MARK function. And then plot the result on SA screen.
5. Repeat above procedures until all frequencies measured were complete.

#### 4.6.4 DEVIATION FROM TEST STANDARD

No deviation.

#### 4.6.5 TEST SETUP

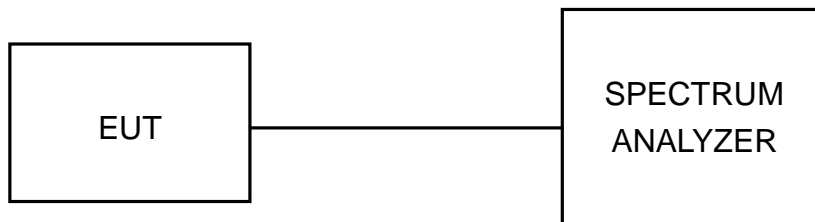



A D T

### 4.6.6 TEST RESULTS

#### Mode A: FOR GFSK

CHANNEL	FREQUENCY (MHz)	ADJACENT CHANNEL SEPARATION (MHz)	20dB BANDWIDTH (MHz)	MINIMUM LIMIT (MHz)	PASS / FAIL
0	2402	1.00	1.01	0.67	PASS
39	2441	1.00	0.97	0.65	PASS
78	2480	1.01	0.99	0.66	PASS

**NOTE:** The minimum limit is two-third 20dB bandwidth. Test results please refer to following plot.

#### CH 78

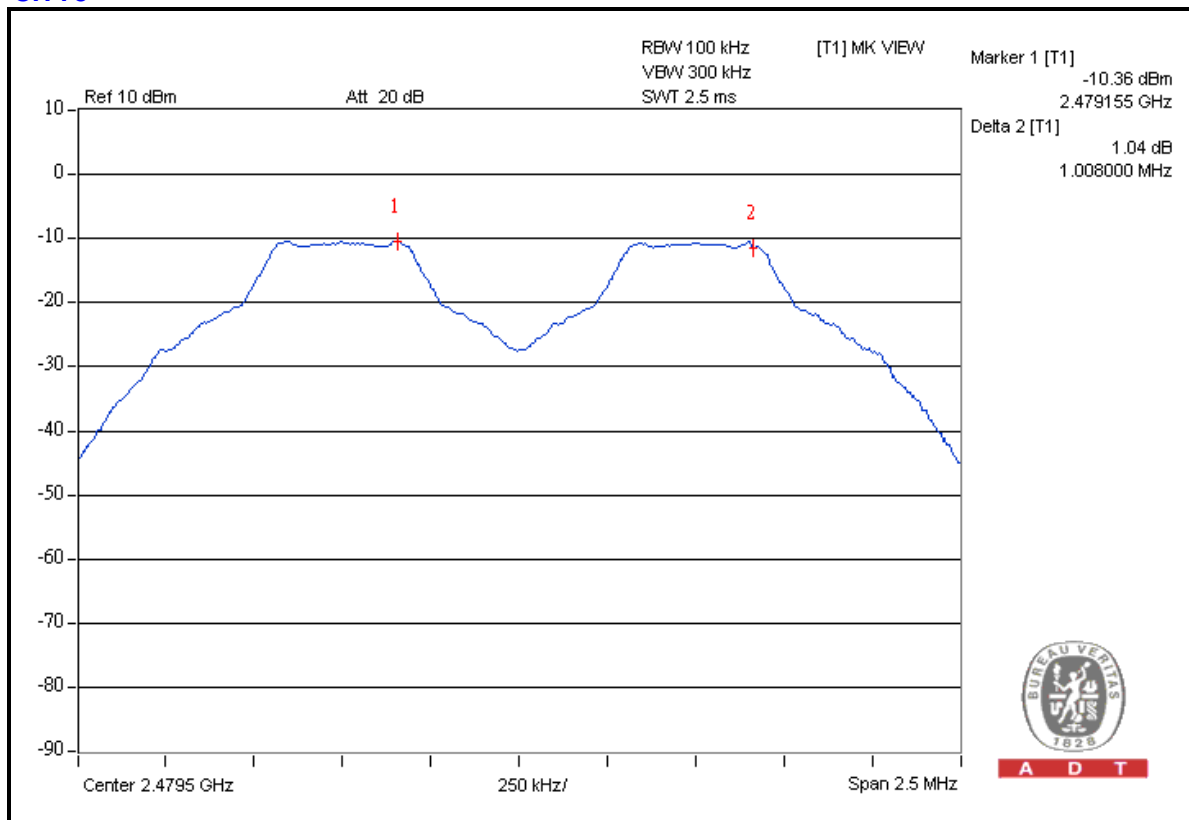





A D T

### Mode A: FOR 8DPSK

CHANNEL	FREQUENCY (MHz)	ADJACENT CHANNEL SEPARATION (MHz)	20dB BANDWIDTH (MHz)	MINIMUM LIMIT (MHz)	PASS / FAIL
0	2402	1.01	1.40	0.93	PASS
39	2441	1.00	1.38	0.92	PASS
78	2480	1.01	1.36	0.91	PASS

**NOTE:** The minimum limit is two-third 20dB bandwidth. Test results please refer to following plot.

### CH 0

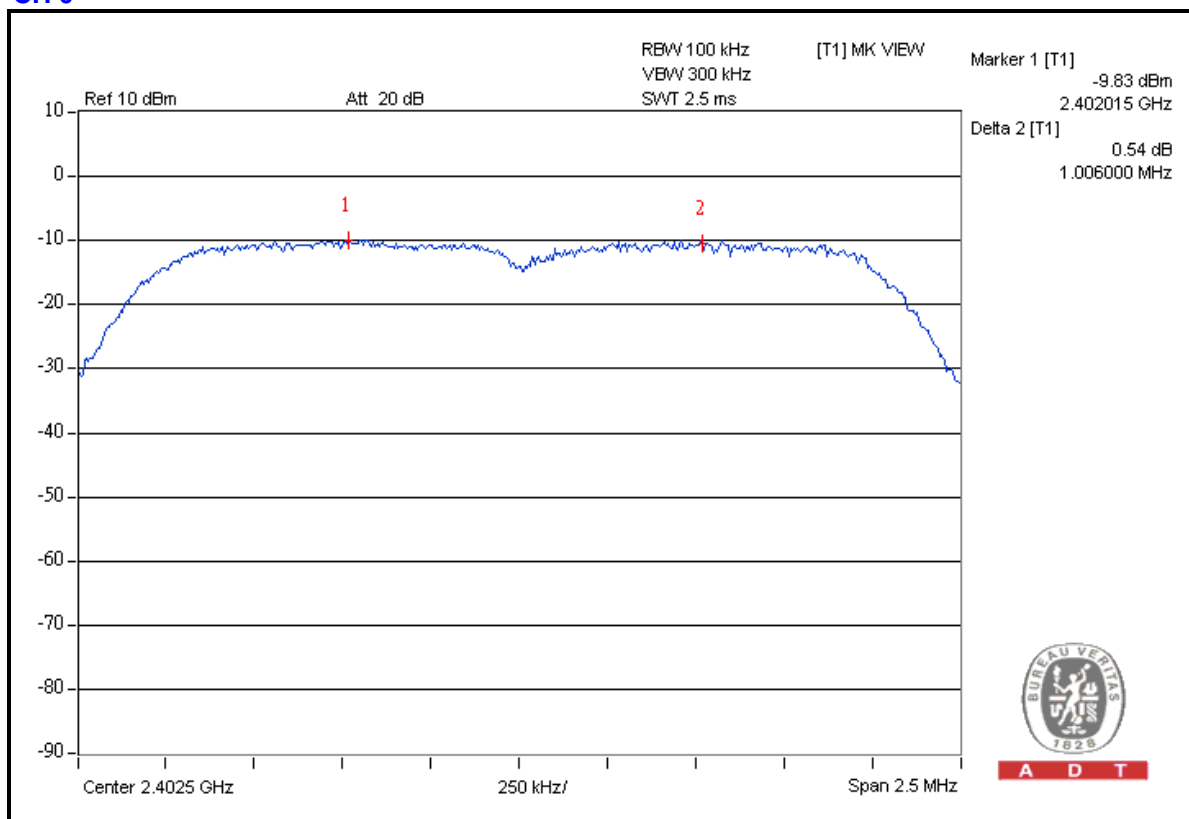

## 4.7 MAXIMUM PEAK OUTPUT POWER

### 4.7.1 LIMITS OF MAXIMUM PEAK OUTPUT POWER MEASUREMENT

The Maximum Peak Output Power Measurement is 125mW.

### 4.7.2 TEST INSTRUMENTS

DESCRIPTION & MANUFACTURER	MODEL NO.	SERIAL NO.	CALIBRATED DATE	CALIBRATED UNTIL
SPECTRUM ANALYZER	FSP 40	100036	Apr. 29, 2011	Apr. 28, 2012

**NOTE:** The calibration interval of the above test instruments is 12 months and the calibrations are traceable to NML/ROC and NIST/USA.

### 4.7.3 TEST PROCEDURES

- a. Check the calibration of the measuring instrument using either an internal calibrator or a known signal from an external generator.
- b. Turn on the EUT and connect it to measurement instrument. Then set it to any one convenient frequency within its operating range. Set a reference level on the measuring instrument equal to the highest peak value.
- c. The center frequency of the spectrum analyzer is set to the fundamental frequency and using 3MHz RBW and 10 MHz VBW.
- d. Measure the captured power within the band and recording the plot.
- e. Repeat above procedures until all frequencies required were complete.

### 4.7.4 DEVIATION FROM TEST STANDARD

No deviation

#### 4.7.5 TEST SETUP

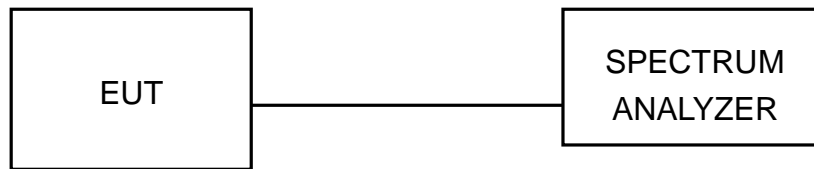

For the actual test configuration, please refer to the related Item – Photographs of the Test Configuration.

#### 4.7.6 EUT OPERATING CONDITION

The software provided by client enabled the EUT to transmit and receive data at lowest, middle and highest channel frequencies individually.



A D T

## 4.7.7 TEST RESULTS

### Mode A: FOR GFSK

CHANNEL	CHANNEL FREQUENCY (MHz)	PEAK POWER OUTPUT (dBm)	PEAK POWER OUTPUT (mW)	PEAK POWER LIMIT (mW)	PASS/FAIL
0	2402	-8.5	0.1	125	PASS
39	2441	-9.3	0.1	125	PASS
78	2480	-9.9	0.1	125	PASS

### CH 0

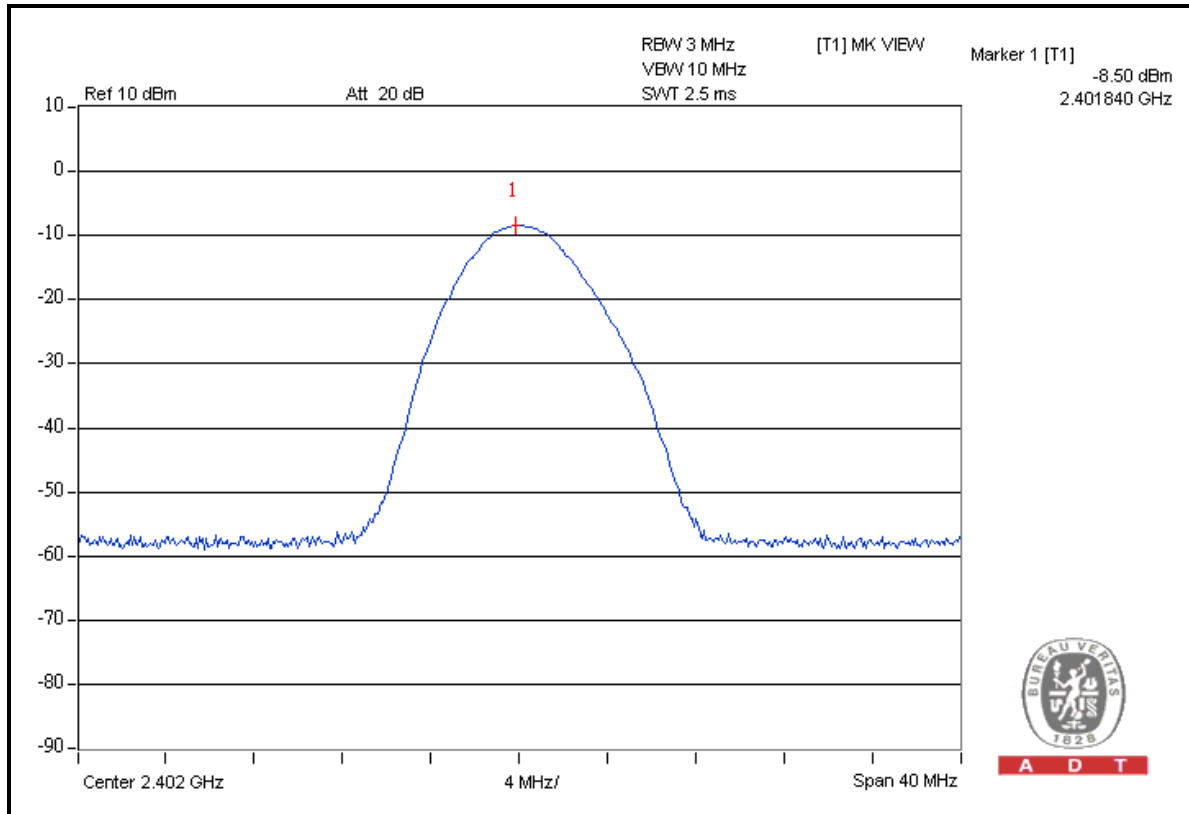



A D T

**Mode A: FOR 8DPSK**

CHANNEL	CHANNEL FREQUENCY (MHz)	PEAK POWER OUTPUT (dBm)	PEAK POWER OUTPUT (mW)	PEAK POWER LIMIT (mW)	PASS/FAIL
0	2402	-6.8	0.2	125	PASS
39	2441	-7.2	0.2	125	PASS
78	2480	-7.3	0.2	125	PASS

**CH 0**

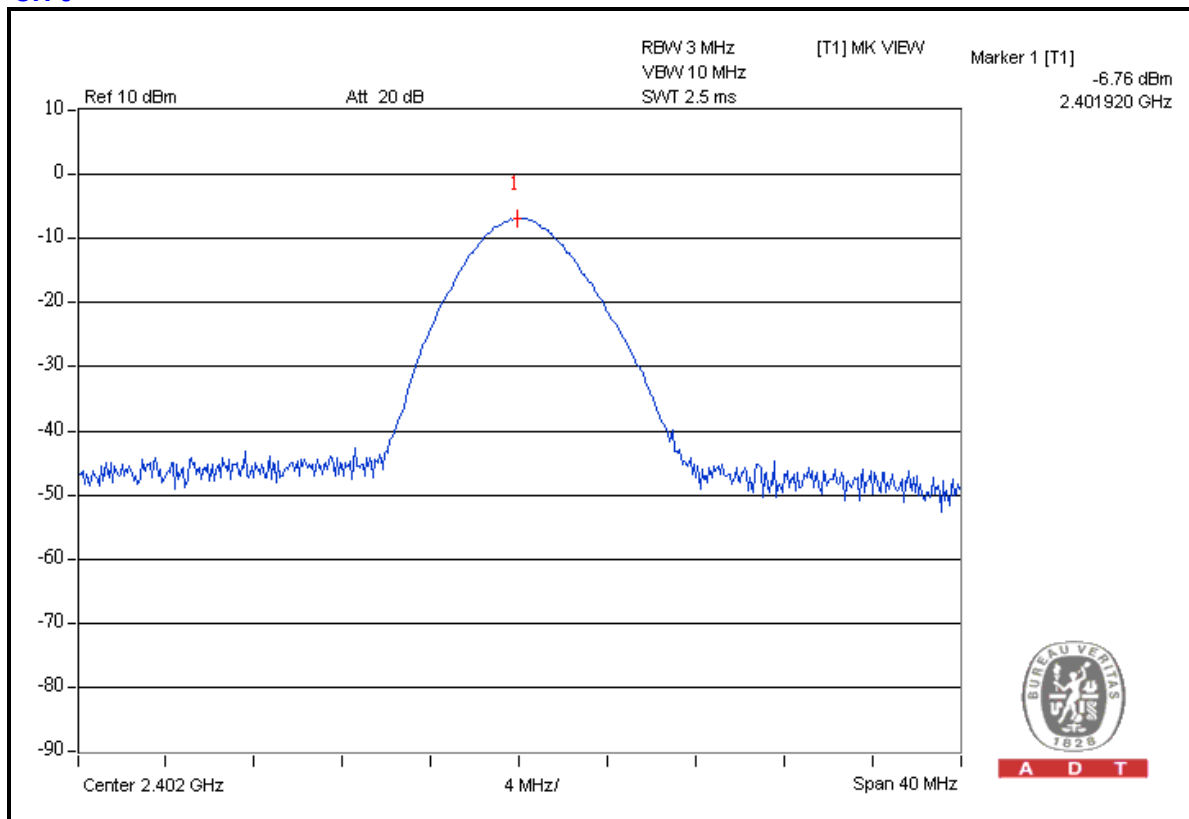

## 4.8 BAND EDGES MEASUREMENT

### 4.8.1 LIMITS OF BAND EDGES MEASUREMENT

Below -20dB of the highest emission level of operating band (in 100KHz RBW).

### 4.8.2 TEST INSTRUMENTS

DESCRIPTION & MANUFACTURER	MODEL NO.	SERIAL NO.	DATE OF CALIBRATION	CALIBRATED UNTIL
<b>FOR CONDUCTED MEASUREMENT:</b>				
R&S SPECTRUM ANALYZER	FSP 40	100036	Apr. 29, 2011	Apr. 28, 2012
<b>FOR RADIATED MEASUREMENT:</b>				
HP Preamplifier	8447D	2432A03504	Mar. 04, 2011	Mar. 03, 2012
HP Preamplifier	8449B	3008A01201	Mar. 04, 2011	Mar. 03, 2012
Agilent Spectrum Analyzer	E4446A	MY46180403	Jun. 22, 2011	Jun. 21, 2012
Schwarzbeck Antenna	VULB 9168	137	Apr. 12, 2011	Apr. 11, 2012
Schwarzbeck Antenna	VHBA 9123	480	May 06, 2011	May 05, 2012
ADT. Turn Table	TT100	0306	NA	NA
ADT. Tower	AT100	0306	NA	NA
Software	ADT_Radiated_V7.6.15.9.2	NA	NA	NA
SUHNER RF cable	SF102	CABLE-CH6	Aug. 19, 2011	Aug. 18, 2012
Schwarzbeck Horn Antenna	BBHA 9120-D1	D130	May 16, 2011	May 15, 2012
Highpass filter Wainwright Instruments	WHK 3.1/18G-10SS	SN 8	NA	NA

- NOTE:**
1. The calibration interval of the above test instruments is 12/24 months. And the calibrations are traceable to NML/ROC and NIST/USA.
  2. The horn antenna and HP preamplifier (model: 8449B) are used only for the measurement of emission frequency above 1GHz if tested.
  3. The test was performed in Chamber No. 6.
  4. The Industry Canada Reference No. IC 7450E-6.
  5. The FCC Site Registration No. is 447212.

### 4.8.3 TEST PROCEDURE

#### FOR CONDUCTED MEASUREMENT:

The transmitter output was connected to the spectrum analyzer via a low loss cable. Set both RBW and VBW of spectrum analyzer to 100 kHz and 300 kHz with suitable frequency span including 100 MHz bandwidth from band edge. The band edges was measured and recorded.

#### FOR RADIATED MEASUREMENT:

- a. The EUT was placed on the top of a rotating table 0.8 meters above the ground at a 3 meter semi-anechoic chamber. The table was rotated 360 degrees to determine the position of the highest radiation.
- b. The EUT was set 3 meters away from the interference-receiving antenna, which was mounted on the top of a variable-height antenna tower.
- c. The antenna is a broadband antenna, and its height is varied from one meter to four meters above the ground to determine the maximum value of the field strength. Both horizontal and vertical polarizations of the antenna are set to make the measurement.
- d. For each suspected emission, the EUT was arranged to its worst case and then the antenna was tuned to heights from 1 meter to 4 meters and the rotatable table was turned from 0 degrees to 360 degrees to find the maximum reading.
- e. Set both RBW and VBW of spectrum analyzer to 1MHz and 3MHz with suitable frequency span including 100MHz bandwidth from band edge. The band edges was measured and recorded.

**NOTE:** The resolution bandwidth of test receiver/spectrum analyzer is 1MHz and the video bandwidth is 10Hz for Average detection (AV) at frequency above 1GHz

### 4.8.4 DEVIATION FROM TEST STANDARD

No deviation.

### 4.8.5 EUT OPERATING CONDITION

The software provided by client enabled the EUT to transmit and receive data at lowest, middle and highest channel frequencies individually.

## 4.8.6 TEST RESULTS

The spectrum plots are attached on the following 8 images. D1 line indicates the highest level, D2 line indicates the 20dB offset below D1. It shows compliance with the requirement in part 15.247(d).

The spectrum plots (RBW =100kHz, VBW = 300kHz) are attached on the following pages.

### Mode A: FOR GFSK

#### RESTRICT BAND (2310 ~ 2390 MHz)

FREQUENCY (MHz)	FUNDAMENTAL EMISSION (dBuV/m)	DELTA (dB)	MAXIMUM FIELD STRENGTH IN RESTRICT BAND (dBuV/m)	LIMIT (dBuV/m)
2402.00 (PK)	65.8	48.1	17.7	74.0
2402.00 (AV)	-	-	-20.4	54.0

#### RESTRICT BAND (2483.5 ~ 2500 MHz)

FREQUENCY (MHz)	FUNDAMENTAL EMISSION (dBuV/m)	DELTA (dB)	MAXIMUM FIELD STRENGTH IN RESTRICT BAND (dBuV/m)	LIMIT (dBuV/m)
2480.00 (PK)	62.2	47.6	14.6	74.0
2480.00 (AV)	-	-	-23.5	54.0

#### NOTE:

1. Delta = Amplitude between the peak of the fundamental and the peak of the band edge emission. Please check following 2 pages.
2. Maximum field strength in restrict band (PK value) = Fundamental emission (PK value) – Delta.
3. Average value = Peak value + 20 Log (duty cycle) = Peak value –38.1dB.
4. The DH5 packet was the worse case duty cycle for a transmit dwell time on a channel, based upon bluetooth theory the transmitter is on 0.625 \* 2 per 296.25 ms per channel. Therefore, the duty cycle be equal to:  $20\log(1.25/100) = -38.1$  dB.





A D T

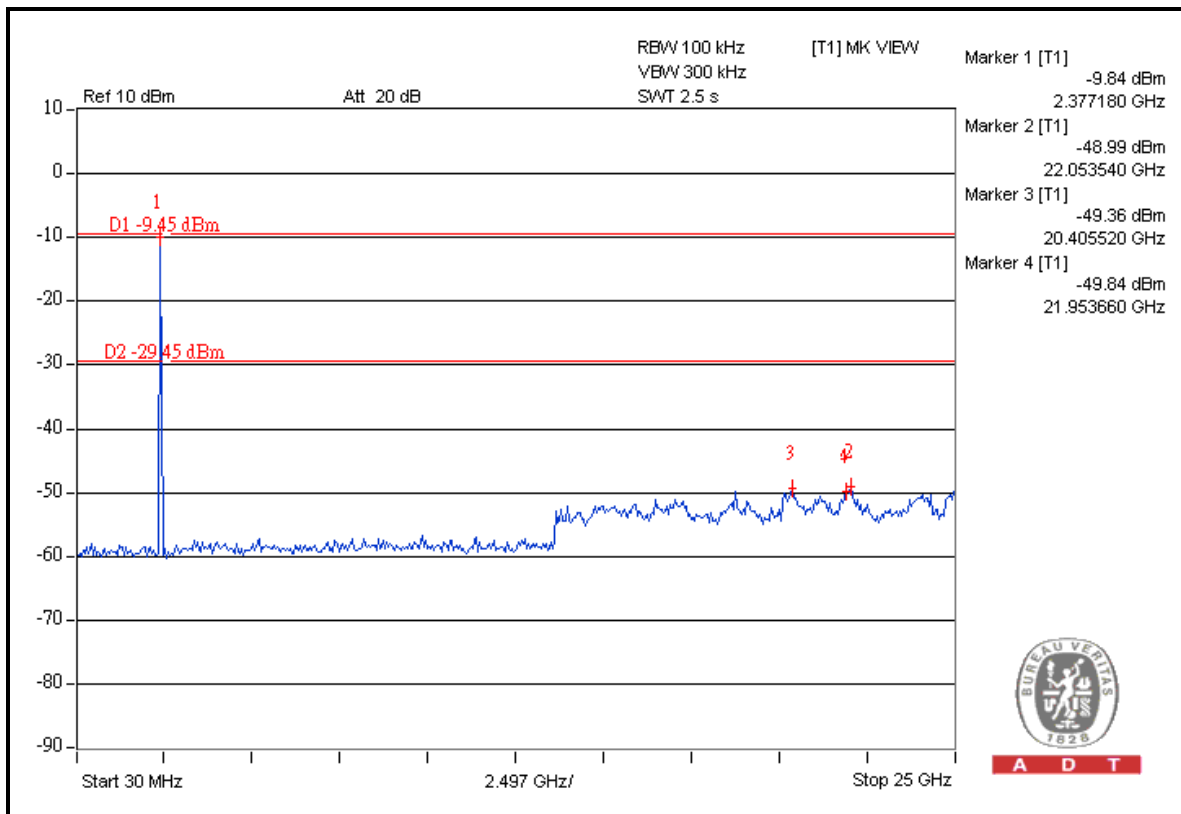
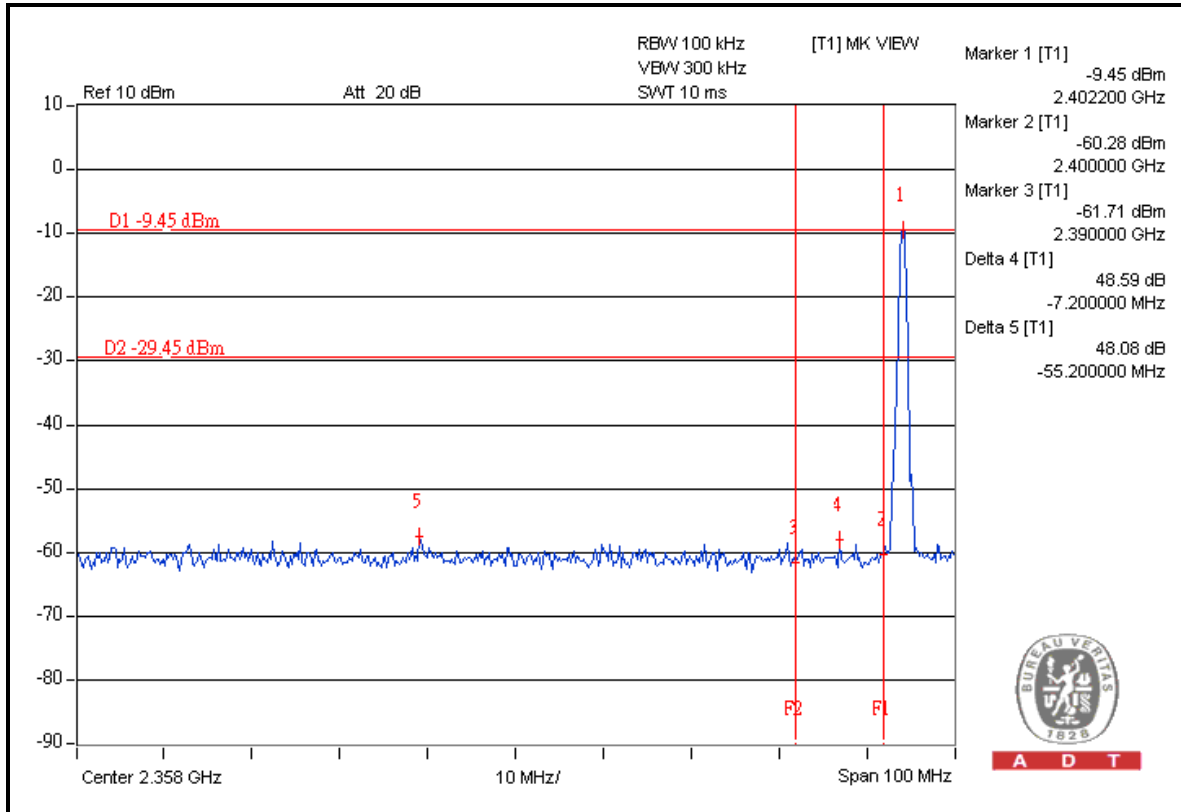



A D T

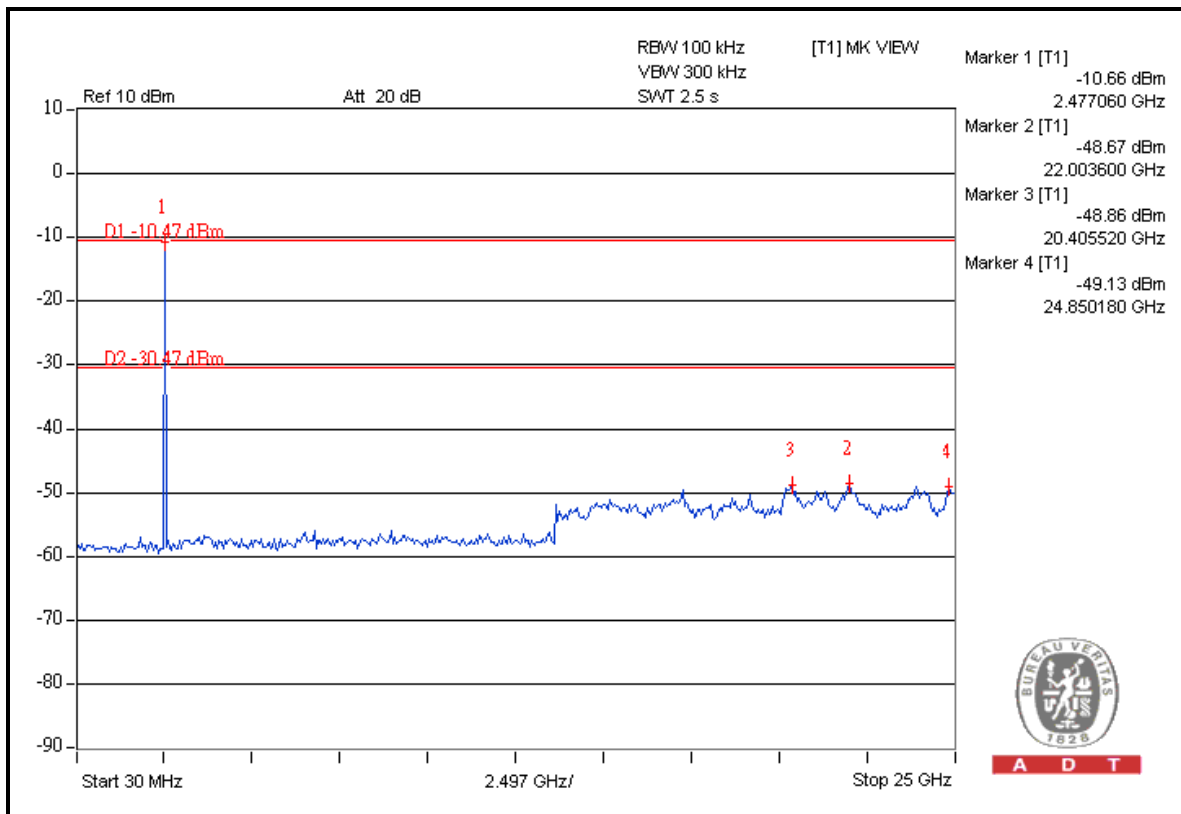
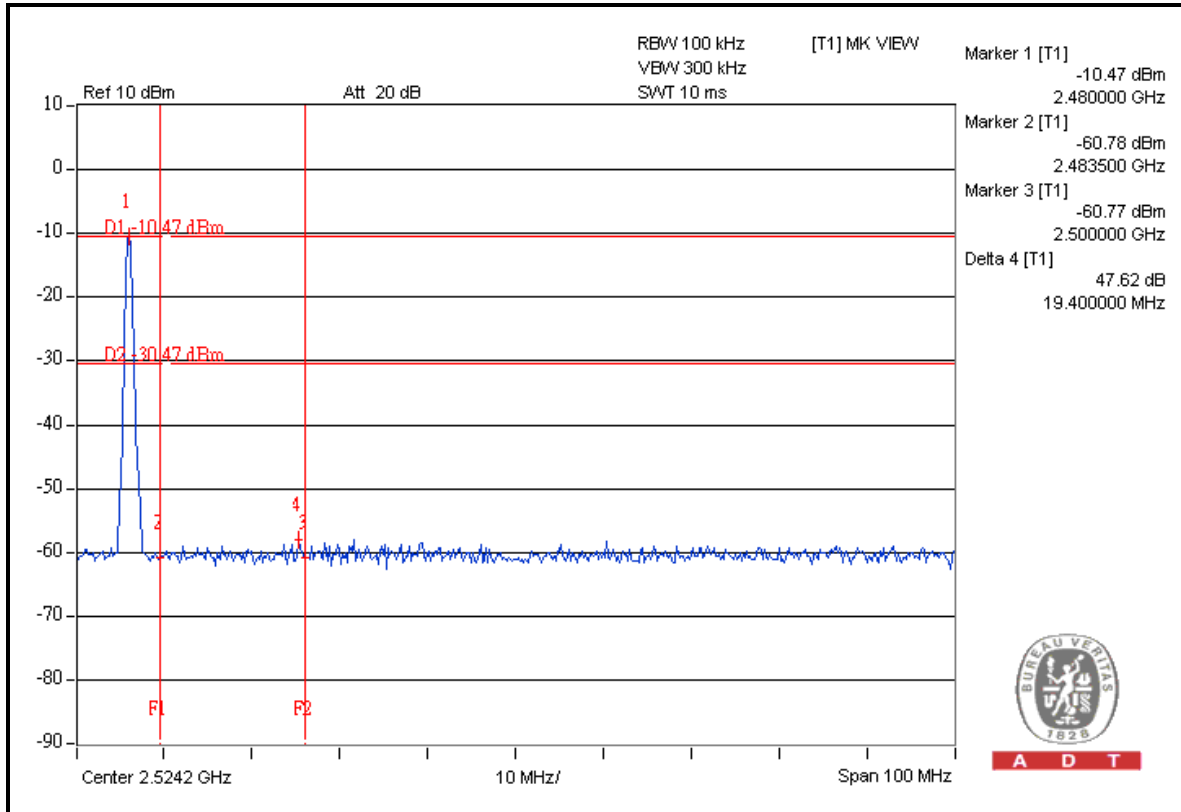

**Mode A: FOR 8DPSK**
**RESTRICT BAND (2310 ~ 2390 MHz)**

FREQUENCY (MHz)	FUNDAMENTAL EMISSION (dBuV/m)	DELTA (dB)	MAXIMUM FIELD STRENGTH IN RESTRICT BAND (dBuV/m)	LIMIT (dBuV/m)
2402.00 (PK)	64.3	48.0	16.3	74.0
2402.00 (AV)	-	-	-21.8	54.0

**RESTRICT BAND (2483.5 ~ 2500 MHz)**

FREQUENCY (MHz)	FUNDAMENTAL EMISSION (dBuV/m)	DELTA (dB)	MAXIMUM FIELD STRENGTH IN RESTRICT BAND (dBuV/m)	LIMIT (dBuV/m)
2480.00 (PK)	63.1	46.4	16.7	74.0
2480.00 (AV)	-	-	-21.4	54.0

**NOTE:**

1. Delta = Amplitude between the peak of the fundamental and the peak of the band edge emission. Please check following 2 pages.
2. Maximum field strength in restrict band (PK value) = Fundamental emission (PK value) – Delta.
3. Average value = Peak value + 20 Log (duty cycle) = Peak value – 38.1 dB.
4. The DH5 packet was the worse case duty cycle for a transmit dwell time on a channel, based upon bluetooth theory the transmitter is on 0.625 \* 2 per 296.25 ms per channel. Therefore, the duty cycle be equal to:  $20\log(1.25/100) = -38.1$  dB.



A D T

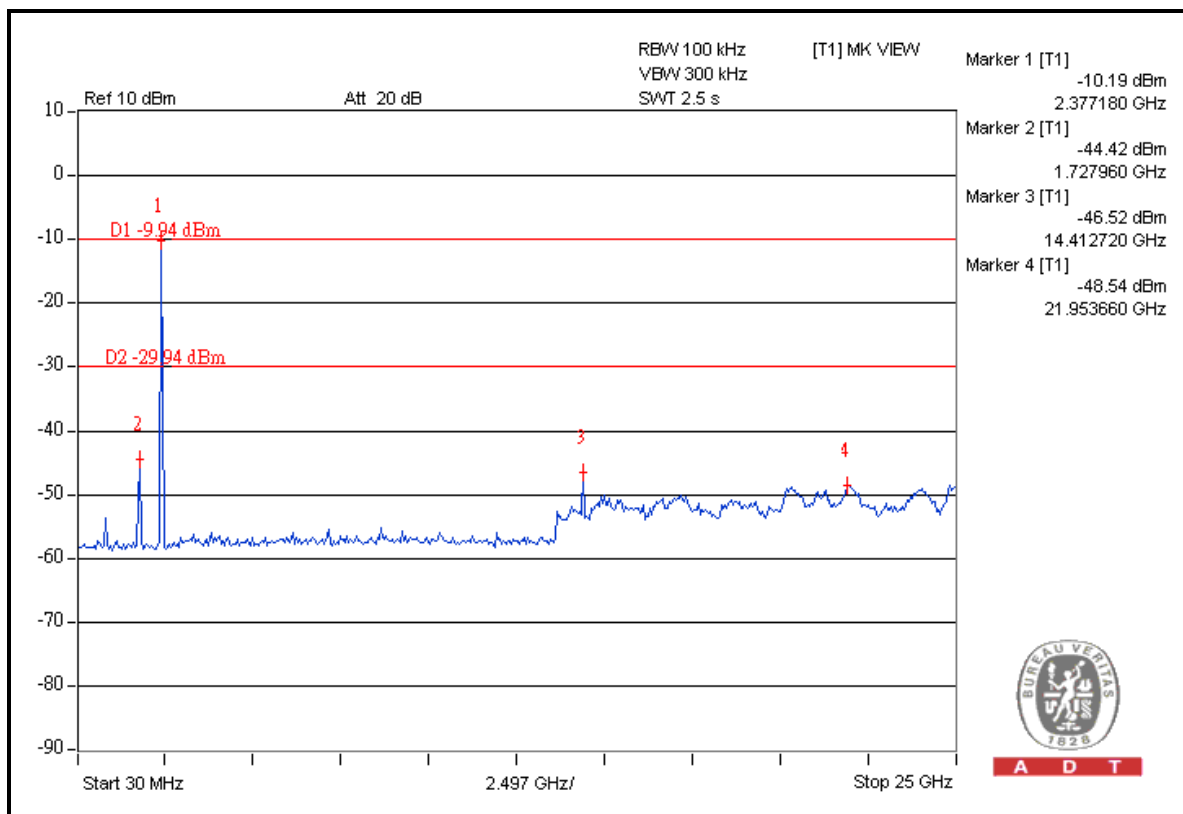
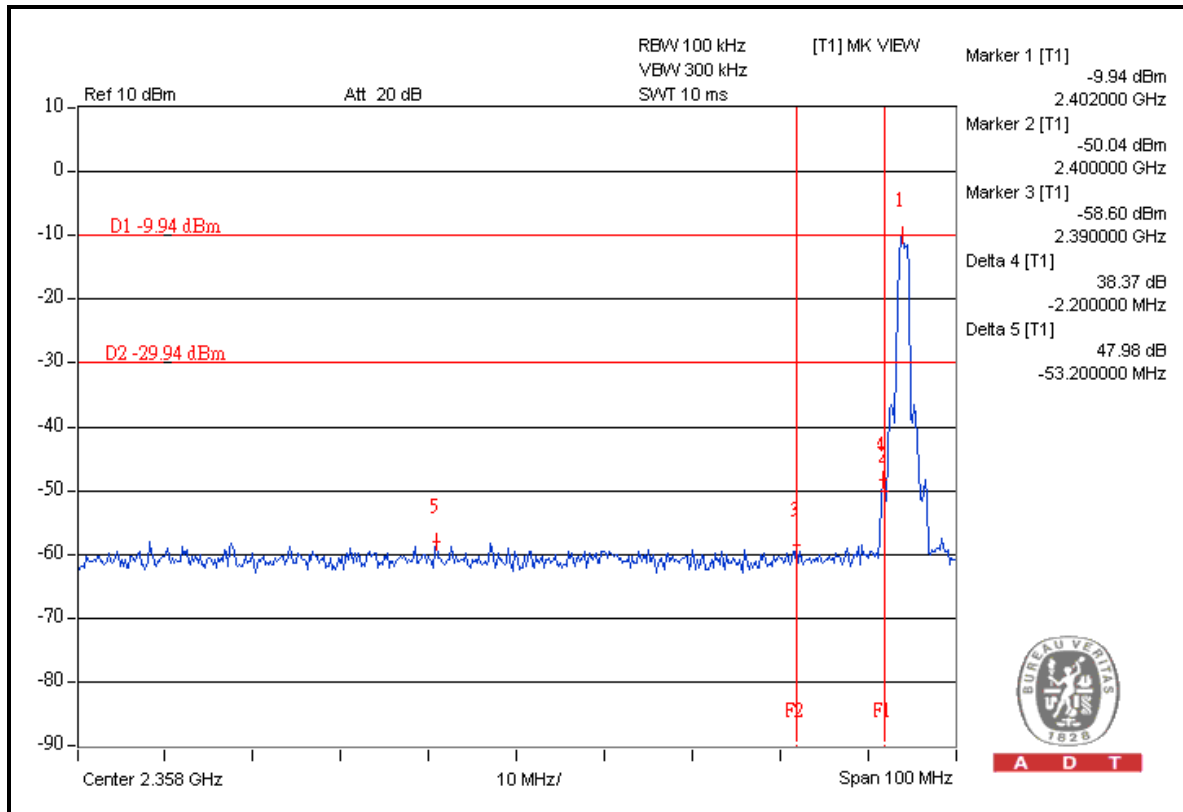



A D T

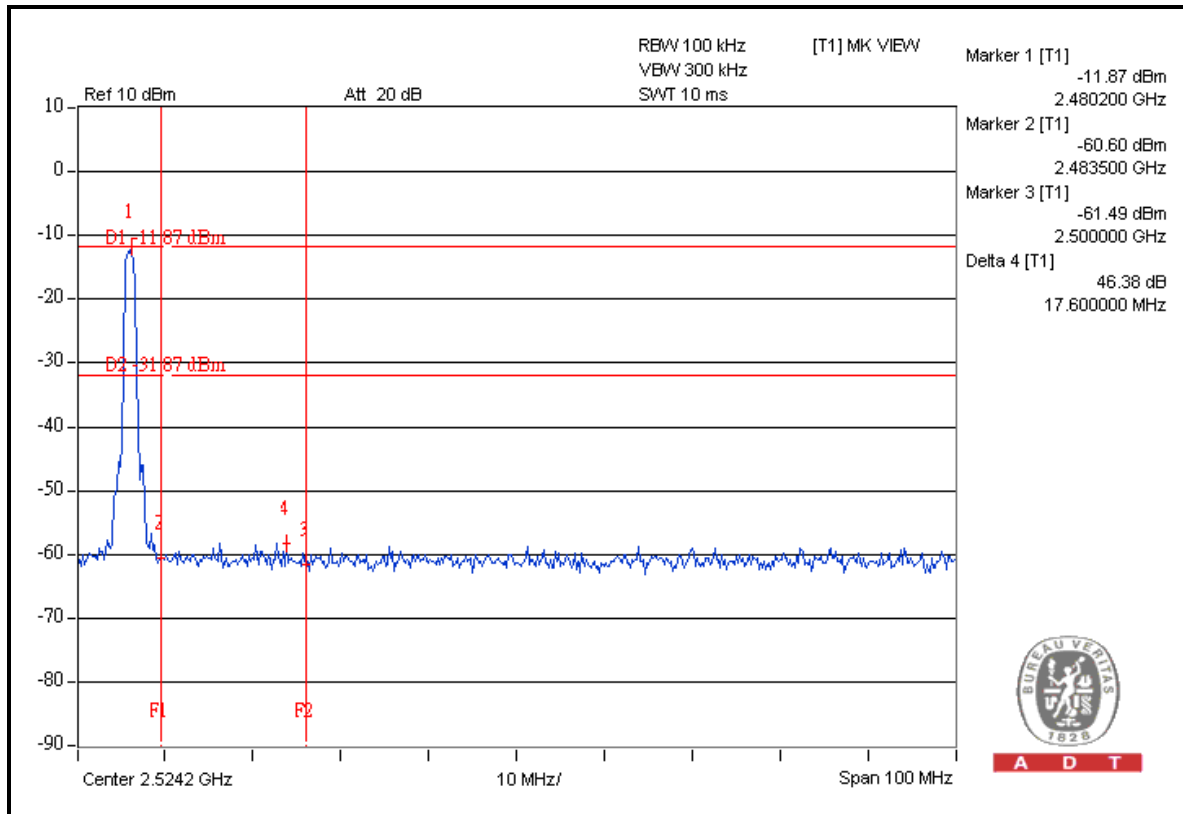

A D T

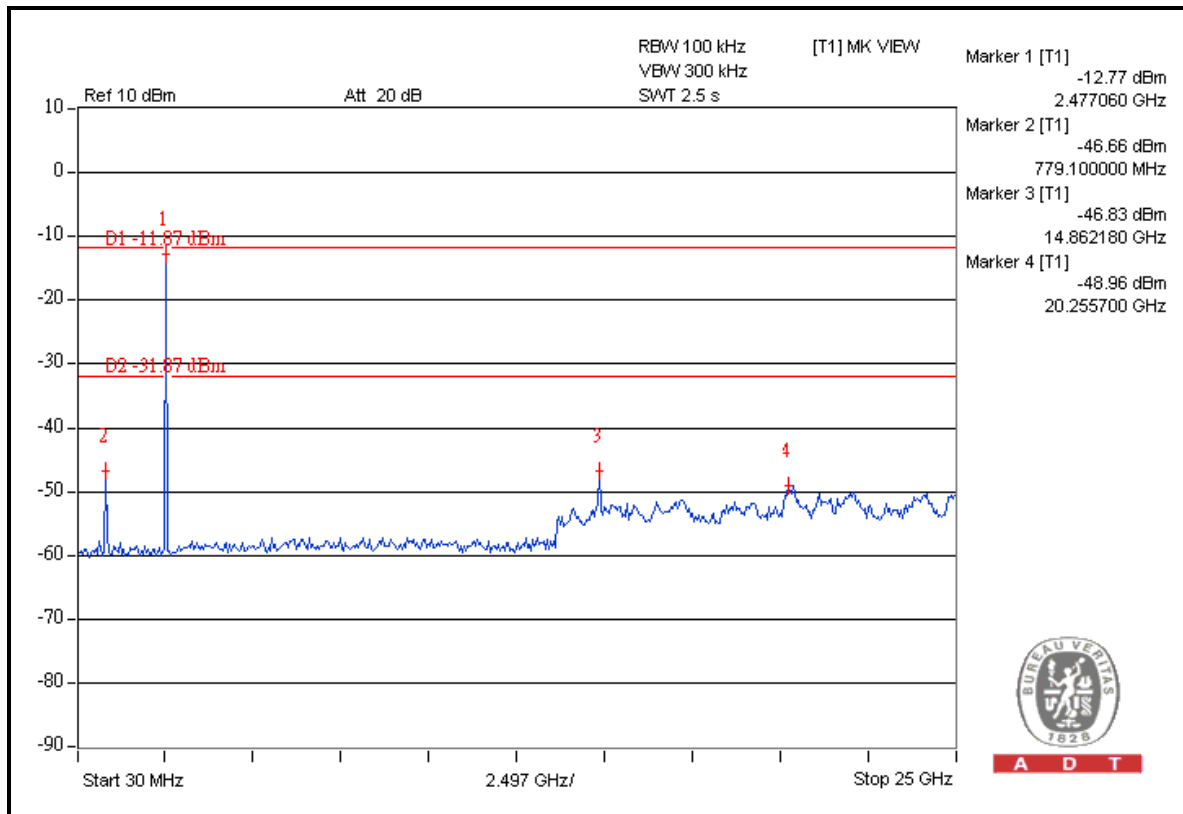

A D T

## 5. PHOTOGRAPHS OF THE TEST CONFIGURATION

Please refer to the attached file (Test Setup Photo).



## 6. INFORMATION ON THE TESTING LABORATORIES

We, Bureau Veritas Consumer Products Services (H.K.) Ltd., Taoyuan Branch, were founded in 1988 to provide our best service in EMC, Radio, Telecom and Safety consultation. Our laboratories are accredited and approved according to ISO/IEC 17025.

Copies of accreditation and authorization certificates of our laboratories obtained from approval agencies can be downloaded from our web site: [www.adt.com.tw/index.5/phtml](http://www.adt.com.tw/index.5/phtml). If you have any comments, please feel free to contact us at the following:

**Linko EMC/RF Lab:**

Tel: 886-2-26052180

Fax: 886-2-26051924

**Hsin Chu EMC/RF Lab:**

Tel: 886-3-5935343

Fax: 886-3-5935342

**Hwa Ya EMC/RF/Safety Telecom Lab:**

Tel: 886-3-3183232

Fax: 886-3-3185050

**Email:** [service.adt@tw.bureauveritas.com](mailto:service.adt@tw.bureauveritas.com)

**Web Site:** [www.adt.com.tw](http://www.adt.com.tw)

The address and road map of all our labs can be found in our web site also.

## **7. APPENDIX A – MODIFICATIONS RECORDERS FOR ENGINEERING CHANGES TO THE EUT BY THE LAB**

No modifications were made to the EUT by the lab during the test.

---END---