



# FCC TEST REPORT

Test report

On Behalf of

Modern Marketing Concepts, Inc.

For

Eclipse Entertainment Center

Model No.: CR7014A-BK, CR7014X-XXXX("X-XXXX" can be replaced by letter from "A" to "Z", number from "0" to "9" or blank)

FCC ID: AUSCR7014A

Prepared for : Modern Marketing Concepts, Inc.

1220 E Oak, St. Louisville, Kentucky, United States 40204

Prepared By : Shenzhen HUAKE Testing Technology Co., Ltd.

1F, B2 Building, Junfeng Zhongcheng Zhizao Innovation Park, Fuhai Street, Bao'an District, Shenzhen City, China

Date of Test: Sep. 18, 2019 ~ Sep. 26, 2019

Date of Report: Sep. 26, 2019

Report Number: HK1909272441-E



### TEST RESULT CERTIFICATION

**Applicant's name** ..... : Modern Marketing Concepts, Inc.  
**Address**..... : 1220 E Oak, St. Louisville, Kentucky, United States 40204  
**Manufacturer's Name**..... : Timsen Development Limited  
**Address**..... : 5F, 447# Tianhebei Road, Guangzhou, China

**Product description**

**Trade Mark:** CROSLEY  
**Product name** ..... : Eclipse Entertainment Center  
**Model and/or type reference** : CR7014A-BK, CR7014X-XXXX("X-XXXX" can be replaced by letter from "A" to "Z", number from "0" to "9" or blank)  
**Standards** ..... : FCC Rules and Regulations Part 15 Subpart C Section 15.249  
 ANSI C63.10: 2013

This publication may be reproduced in whole or in part for non-commercial purposes as long as the Shenzhen HUAKE Testing Technology Co., Ltd. is acknowledged as copyright owner and source of the material. Shenzhen HUAKE Testing Technology Co., Ltd. takes no responsibility for and will not assume liability for damages resulting from the reader's interpretation of the reproduced material due to its placement and context.

**Date of Test**..... :  
**Date (s) of performance of tests**..... : Sep. 18, 2019 ~ Sep. 26, 2019  
**Date of Issue**..... : Sep. 26, 2019  
**Test Result**..... : **Pass**

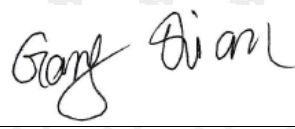
Testing Engineer : 

(Gary Qian)

Technical Manager : 

(Eden Hu)

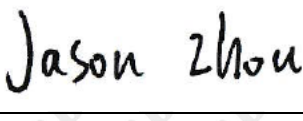
Authorized Signatory : 

(Jason Zhou)



<b>Table of Contents</b>	<b>Page</b>
1 . TEST SUMMARY	4
2 . GENERAL INFORMATION	5
2.1 GENERAL DESCRIPTION OF EUT	5
2.2 Operation of EUT during testing	6
2.3 DESCRIPTION OF TEST SETUP	7
2.4 MEASUREMENT INSTRUMENTS LIST	8
3 . CONDUCTED EMISSIONS TEST	9
3.1 Conducted Power Line Emission Limit	9
3.2 Test Setup	9
3.3 Test Procedure	9
3.4 Test Result	9
4 RADIATED EMISSION TEST	12
4.1 Radiation Limit	12
4.2 Test Setup	12
4.3 Test Procedure	13
4.4 Test Result	13
5 BAND EDGE	19
5.1 Limits	19
5.2 Test Procedure	19
5.3 Test Result	19
6 OCCUPIED BANDWIDTH MEASUREMENT	21
6.1 Test Setup	21
6.2 Test Procedure	21
6.3 Measurement Equipment Used	21
6.4 Test Result	21
7 ANTENNA REQUIREMENT	27
8 PHOTOGRAPH OF TEST	28
8.1 Radiated Emission	28
8.2 Conducted Emission	29





## 1. TEST SUMMARY

### 1.1 TEST PROCEDURES AND RESULTS

DESCRIPTION OF TEST	RESULT
15.207 Conducted Emission	COMPLIANT
15.249&15.209 Fundamental & Radiated Spurious Emission Measurement	COMPLIANT
15.215 Bandwidth	COMPLIANT
15.205 Band Edge Emission	COMPLIANT
15.203 Antenna Requirement	COMPLIANT

### 1.2 TEST FACILITY

Test Firm : Shenzhen HUAKE Testing Technology Co., Ltd.

Address 1F, B2 Building, Junfeng Zhongcheng Zhizao Innovation Park, Fuhai Street, Bao'an District, Shenzhen City, China

### 1.3 MEASUREMENT UNCERTAINTY

Measurement Uncertainty

Conducted Emission Expanded Uncertainty = 2.23dB, k=2

Radiated emission expanded uncertainty(9kHz-30MHz) = 3.08dB, k=2

Radiated emission expanded uncertainty(30MHz-1000MHz) = 4.42dB, k=2

Radiated emission expanded uncertainty(Above 1GHz) = 4.06dB, k=2



## 2. GENERAL INFORMATION

### 2.1 GENERAL DESCRIPTION OF EUT

Equipment	Eclipse Entertainment Center
Model Name	CR7014A-BK, CR7014X-XXXX
Serial No	N/A
Model Difference	All model's the function, software and electric circuit are the same, X-XXXX represents the color, they be replaced by letter from "A" to "Z", number from "0" to "9" or blank Test sample model: CR7014A-BK
FCC ID	<b>AUSCR7014A</b>
Antenna Type	Internal Antenna
Antenna Gain	0.8dBi
BT Operation frequency	2402-2480MHz
Number of Channels	79CH
Modulation Type	GFSK, $\pi/4$ DQPSK, 8DPSK
Battery	N/A
Power Source	AC 9V, 2.3A from transformer
Transformer	Input: AC 120V/60Hz Output: AC 9V 2.3A



## 2.1.1 Carrier Frequency of Channels

Channel List					
Channel	Frequency (MHz)	Channel	Frequency (MHz)	Channel	Frequency (MHz)
00	2402	27	2429	54	2456
01	2403	28	2430	55	2457
02	2404	29	2431	56	2458
03	2405	30	2432	57	2459
04	2406	31	2433	58	2460
05	2407	32	2434	59	2461
06	2408	33	2435	60	2462
07	2409	34	2436	61	2463
08	2410	35	2437	62	2464
09	2411	36	2438	63	2465
10	2412	37	2439	64	2466
11	2413	38	2440	65	2467
12	2414	39	2441	66	2468
13	2415	40	2442	67	2469
14	2416	41	2443	68	2470
15	2417	42	2444	69	2471
16	2418	43	2445	70	2472
17	2419	44	2446	71	2473
18	2420	45	2447	72	2474
19	2421	46	2448	73	2475
20	2422	47	2449	74	2476
21	2423	48	2450	75	2477
22	2424	49	2451	76	2478
23	2425	50	2452	77	2479
24	2426	51	2453	78	2480
25	2427	52	2454		
26	2428	53	2455		

## 2.2 Operation of EUT during testing

Operating Mode

The mode is used: **Transmitting mode**

Low Channel: 2402MHz

Middle Channel: 2441MHz

High Channel: 2480MHz





### 2.3 DESCRIPTION OF TEST SETUP

Operation of EUT during conducted testing:

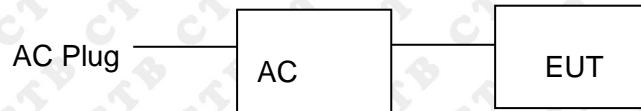

Operation of EUT during Radiation testing and Above1GHz Radiation testing:





## 2.4 MEASUREMENT INSTRUMENTS LIST

Item	Equipment	Manufacturer	Model No.	Serial No.	Last Cal.	Cal. Interval
1.	L.I.S.N. Artificial Mains Network	R&S	ENV216	HKE-002	Dec. 28, 2018	1 Year
2.	Receiver	R&S	ESCI 7	HKE-010	Dec. 28, 2018	1 Year
3.	RF automatic control unit	Tonscend	JS0806-2	HKE-060	Dec. 28, 2018	1 Year
4.	Spectrum analyzer	R&S	FSP40	HKE-025	Dec. 28, 2018	1 Year
5.	Spectrum analyzer	Agilent	N9020A	HKE-048	Dec. 28, 2018	1 Year
6.	Preamplifier	Schwarzbeck	BBV 9743	HKE-006	Dec. 28, 2018	1 Year
7.	EMI Test Receiver	Rohde & Schwarz	ESCI 7	HKE-010	Dec. 28, 2018	1 Year
8.	Bilog Broadband Antenna	Schwarzbeck	VULB9163	HKE-012	Dec. 28, 2018	1 Year
9.	Loop Antenna	Schwarzbeck	FMZB 1519 B	HKE-014	Dec. 28, 2018	1 Year
10.	Horn Antenna	Schwarzbeck	9120D	HKE-013	Dec. 28, 2018	1 Year
11.	Pre-amplifier	EMCI	EMC051845 SE	HKE-015	Dec. 28, 2018	1 Year
12.	Pre-amplifier	Agilent	83051A	HKE-016	Dec. 28, 2018	1 Year
13.	EMI Test Software EZ-EMC	Tonscend	JZOtheBO T120-B Version	HKE-083	N/A	N/A
14.	Power Sensor	Agilent	E9300A	HKE-086	Dec. 28, 2018	1 Year
15.	Spectrum analyzer	Agilent	N9020A	HKE-048	Dec. 28, 2018	1 Year
16.	Signal generator	Agilent	N5182A	HKE-029	Dec. 28, 2018	1 Year
17.	Signal Generator	Agilent	83630A	HKE-028	Dec. 28, 2018	1 Year
18.	Shielded room	Shiel Hong	4*3*3	HKE-039	Dec. 28, 2017	3 Year
19	Hf antenna	Schwarzbeck	LB-180400- KF	HKE-031	Dec. 28, 2018	1 Year





### 3. CONDUCTED EMISSIONS TEST

#### 3.1 Conducted Power Line Emission Limit

For unintentional device, according to § 15.207(a) Line Conducted Emission Limits is as following

Frequency (MHz)	Maximum RF Line Voltage (dB $\mu$ V)			
	CLASS A		CLASS B	
	Q.P.	Ave.	Q.P.	Ave.
0.15 - 0.50	79	66	66-56*	56-46*
0.50 - 5.00	73	60	56	46
5.00 - 30.0	73	60	60	50

\* Decreasing linearly with the logarithm of the frequency

For intentional device, according to §15.207(a) Line Conducted Emission Limit is same as above table.

#### 3.2 Test Setup

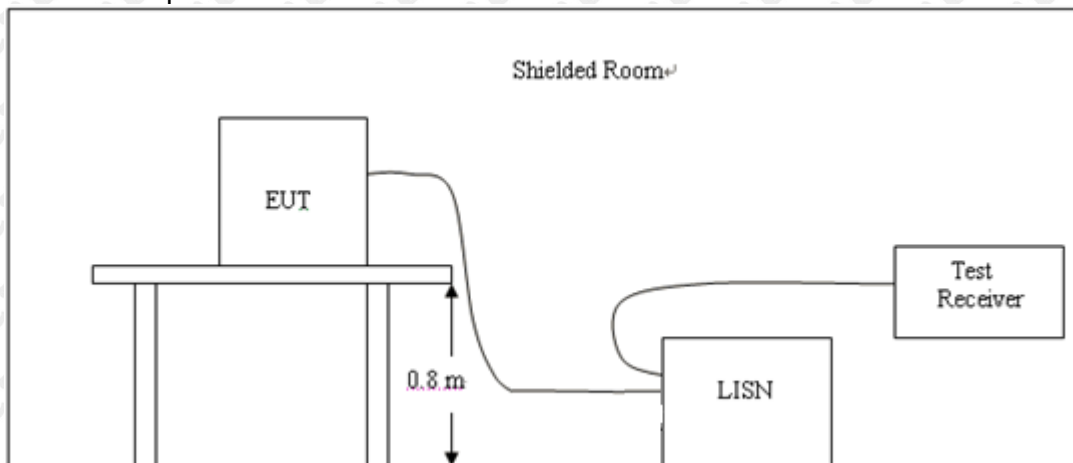

#### 3.3 Test Procedure

- 1, The equipment was set up as per the test configuration to simulate typical actual usage per the user's manual. The EUT is a tabletop system, a wooden table with a height of 0.8 meters is used and is placed on the ground plane as per ANSI C63.10.
- 2, Support equipment, if needed, was placed as per ANSI C63.10.
- 3, All I/O cables were positioned to simulate typical actual usage as per ANSI C63.10.
- 4, If a EUT received DC power from the USB Port of Notebook PC, the PC's adapter received AC120V/60Hz power through a Line Impedance Stabilization Network (LISN) which supplied power source and was grounded to the ground plane.
- 5, All support equipments received AC power from a second LISN, if any.
- 6, The EUT test program was started. Emissions were measured on each current carrying line of the EUT using a spectrum Analyzer / Receiver connected to the LISN powering the EUT. The LISN has two monitoring points: Line 1 (Hot Side) and Line 2 (Neutral Side). Two scans were taken: one with Line 1 connected to Analyzer / Receiver and Line 2 connected to a 50 ohm load; the second scan had Line 1 connected to a 50 ohm load and Line 2 connected to the Analyzer / Receiver.
- 7, Analyzer / Receiver scanned from 150 KHz to 30MHz for emissions in each of the test modes.

#### 3.4 Test Result

PASS

1. All modes were tested at AC 120V and 240V, only the worst result of AC 120V 60Hz was reported.
2. All the test modes completed for test. only the worst result of GFSK Low Channel was reported as below:

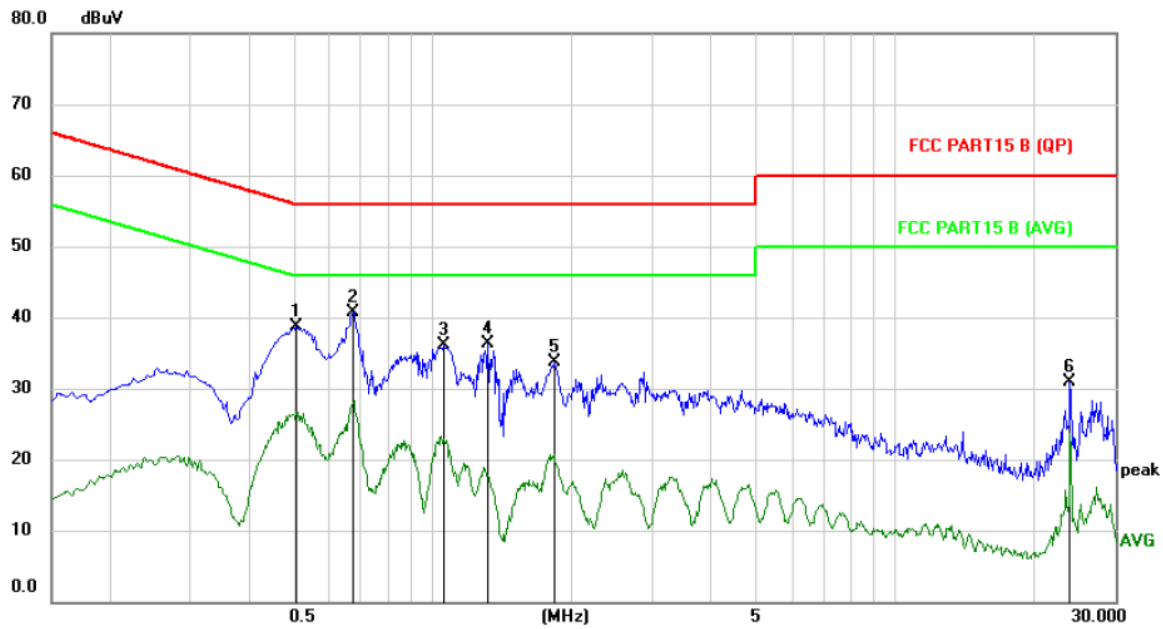

No.	Mk.	Freq. MHz	Reading Level dBuV	Correct Factor dB	Measure- ment dBuV	Limit dBuV	Over dB	Detector
1		0.5100	28.69	9.98	38.67	56.00	-17.33	peak
2	*	0.6740	30.75	10.04	40.79	56.00	-15.21	peak
3		1.0620	26.03	9.99	36.02	56.00	-19.98	peak
4		1.3180	26.21	10.03	36.24	56.00	-19.76	peak
5		1.8300	23.62	10.03	33.65	56.00	-22.35	peak
6		24.0060	19.99	10.86	30.85	60.00	-29.15	peak

Remark:

Factor = Cable loss + LISN factor, Over = Measurement – Limit



Test Specification: Neutral

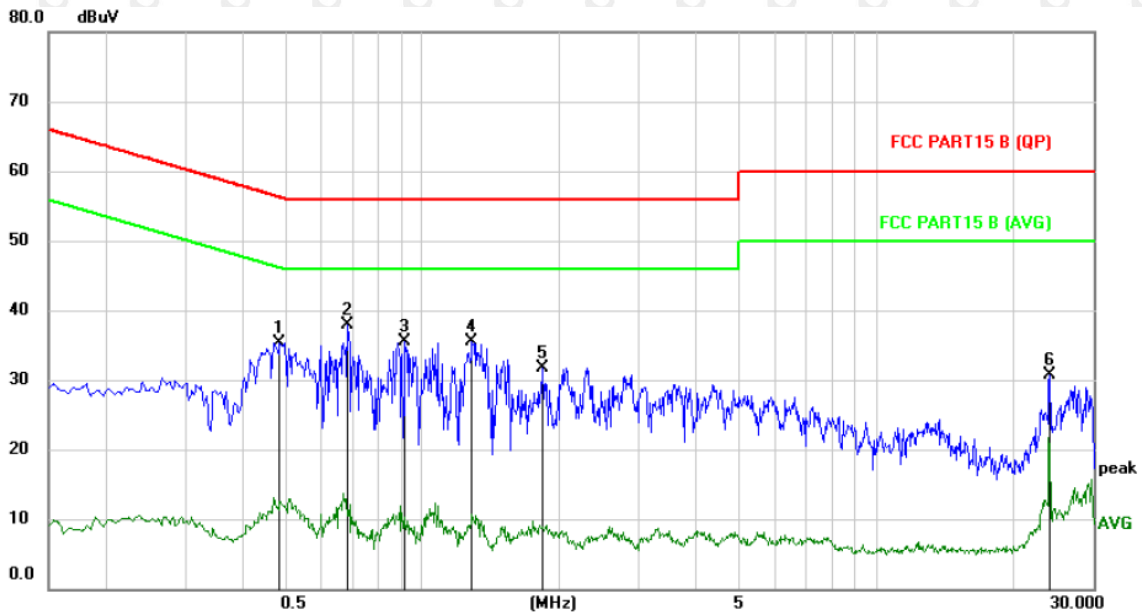

No.	Mk.	Freq. MHz	Reading Level dBuV	Correct Factor dB	Measure- ment dBuV	Limit dBuV	Over dB	Detector
1		0.4860	25.54	9.80	35.34	56.24	-20.90	peak
2	*	0.6860	28.11	9.89	38.00	56.00	-18.00	peak
3		0.9140	25.60	10.00	35.60	56.00	-20.40	peak
4		1.2860	25.47	10.08	35.55	56.00	-20.45	peak
5		1.8420	21.62	10.12	31.74	56.00	-24.26	peak
6		24.0220	19.88	10.84	30.72	60.00	-29.28	peak

Remark:

Factor = Cable loss + LISN factor, Over = Measurement – Limit



## 4 RADIATED EMISSION TEST

### 4.1 Radiation Limit

For unintentional device, according to § 15.209(a), except for Class B digital devices, the field strength of radiated emissions from unintentional radiators at a distance of 3 meters shall not exceed the following values:

Frequency (MHz)	Distance (Meters)	Radiated (dBµV/m)	Radiated (µV/m)
0.009-0.49	3	$20\log(2400/F(\text{KHz}))+40\log(300/3)$	$2400/F(\text{KHz})$
0.49-1.705	3	$20\log(24000/F(\text{KHz}))+40\log(30/3)$	$24000/F(\text{KHz})$
1.705-30	3	$20\log(30)+40\log(30/3)$	30
30-88	3	40.0	100
88-216	3	43.5	150
216-960	3	46.0	200
Above 960	3	54.0	500

For intentional device, according to § 15.209(a), the general requirement of field strength of radiated emissions from intentional radiators at a distance of 3 meters shall not exceed the above table.

### 4.2 Test Setup

#### (1) Radiated Emission Test-Up Frequency Below 30MHz

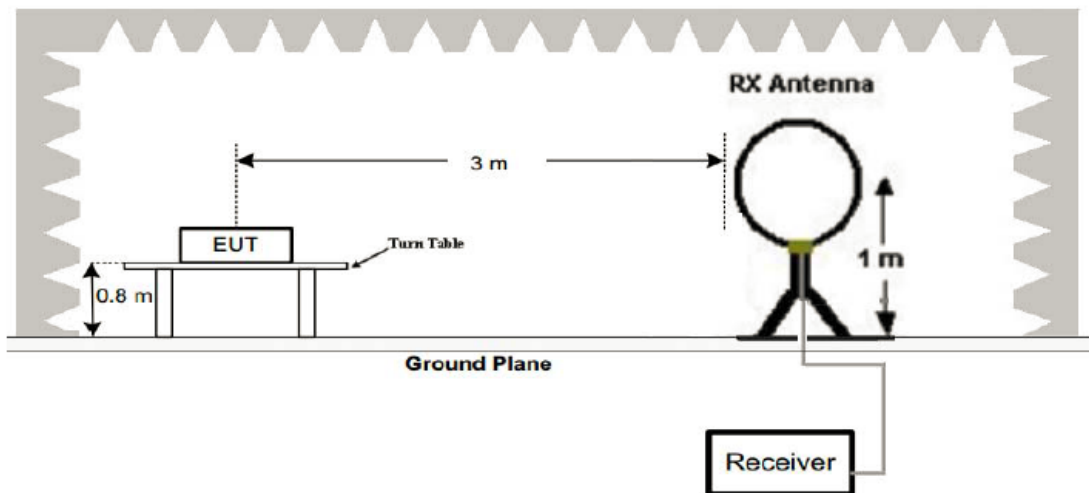

#### (2) Radiated Emission Test-Up Frequency 30MHz~1GHz

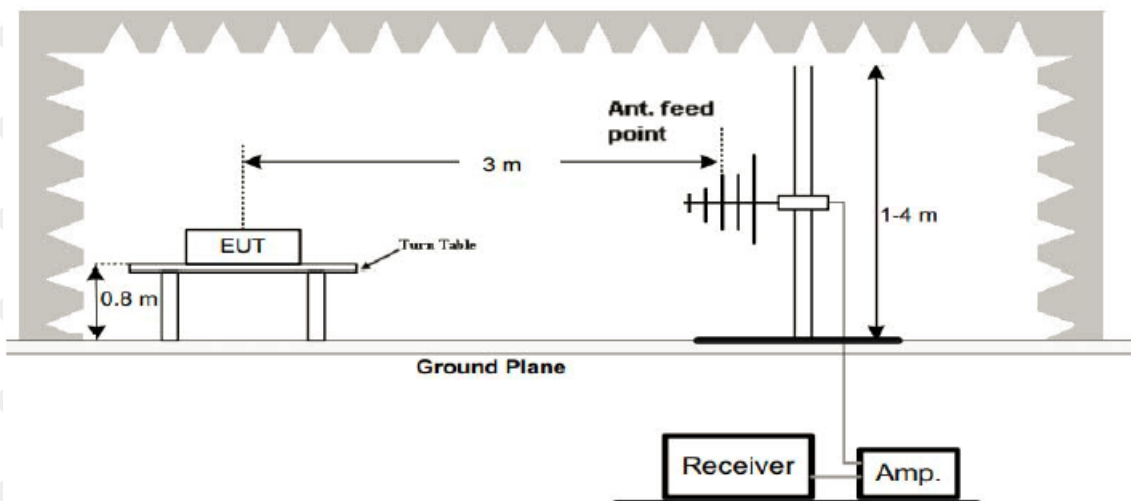

### (3) Radiated Emission Test-Up Frequency Above 1GHz

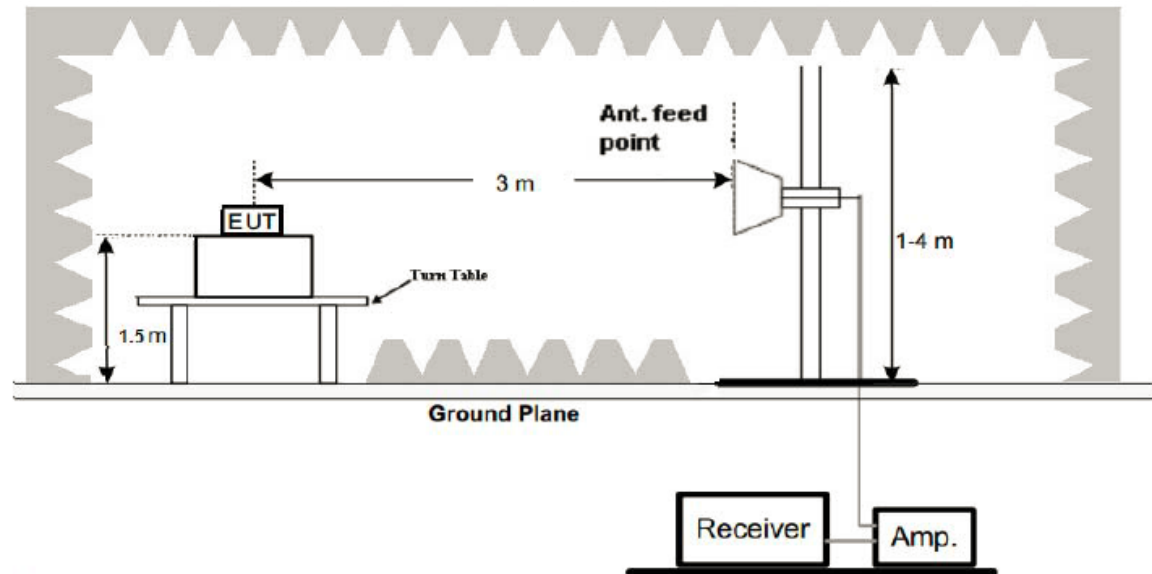

#### 4.3 Test Procedure

1. Below 1GHz measurement the EUT is placed on turntable which is 0.8m above ground plane. And above 1GHz measurement EUT was placed on low permittivity and low tangent turn table which is 1.5m above ground plane.
2. The turntable shall be rotated for 360 degrees to determine the position of maximum emission level.
3. EUT is set 3m away from the receiving antenna, which is varied from 1m to 4m to find out the highest emissions.
4. Maximum procedure was performed on the six highest emissions to ensure EUT compliance.
5. And also, each emission was to be maximized by changing the polarization of receiving antenna both horizontal and vertical.
6. Repeat above procedures until the measurements for all frequencies are complete.
7. The test frequency range from 9KHz to 25GHz per FCC PART 15.33(a).

#### Note:

For battery operated equipment, the equipment tests shall be performed using a new battery.

#### 4.4 Test Result

PASS

#### Remark:

1. All modes of GFSK,  $\pi/4$  DQPSK, 8DPSK were test at Low, Middle, and High channel, only the worst result of GFSK Low Channel was reported for below 1GHz test.
2. For BT above 1GHz test all modes of GFSK,  $\pi/4$  DQPSK, and 8DPSK were test at Low, Middle, and High channel, only the worst result of GFSK was reported.
3. By preliminary testing and verifying three axis (X, Y and Z) position of EUT transmitted status, it was found that "Z axis" position was the worst, and test data recorded in this report.
4. Radiated emission test from 9KHz to 10th harmonic of fundamental was verified, and no emission found except system noise floor in 9KHz to 30MHz and not recorded in this report.



Below 1GHz Test Results:  
Antenna polarity: H

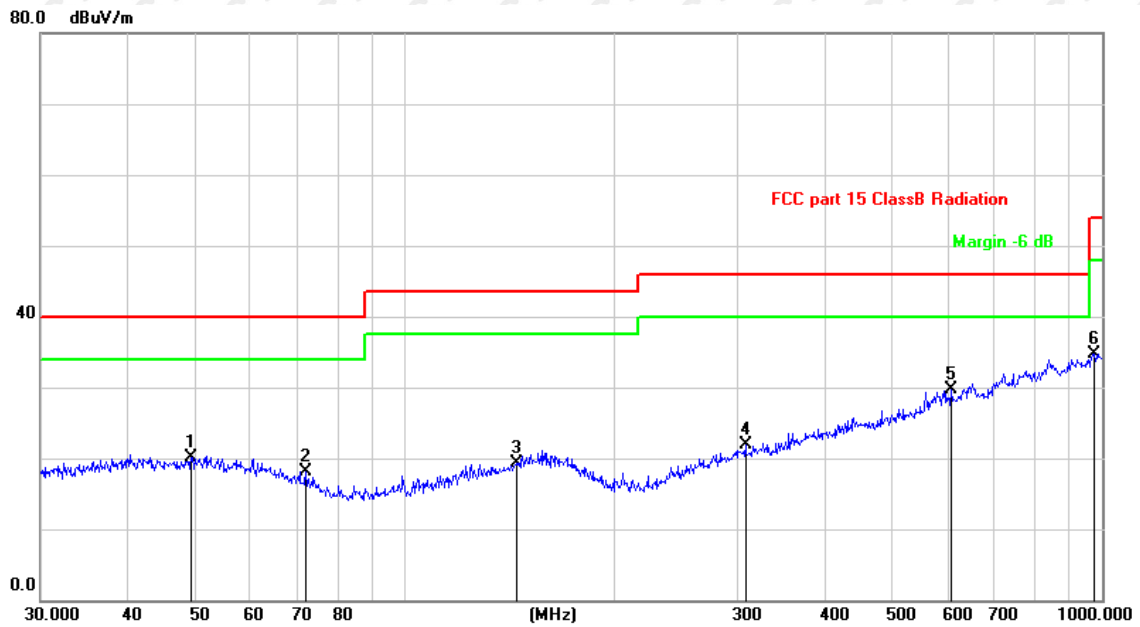

No.	Mk.	Freq. MHz	Reading Level dBuV	Correct Factor dB	Measure- ment dBuV/m	Limit dB/m	Over dB	Detector
1		49.3594	26.70	-6.55	20.15	40.00	-19.85	peak
2		72.0843	27.35	-9.30	18.05	40.00	-21.95	peak
3		144.8418	25.78	-6.53	19.25	43.50	-24.25	peak
4		307.8313	26.99	-5.16	21.83	46.00	-24.17	peak
5	*	607.7867	26.64	3.05	29.69	46.00	-16.31	peak
6		975.7529	26.60	8.19	34.79	54.00	-19.21	peak

Remark: Factor = Cable lose + Antenna factor - Pre-amplifier; Over = Measurement - Limit





Antenna polarity: V

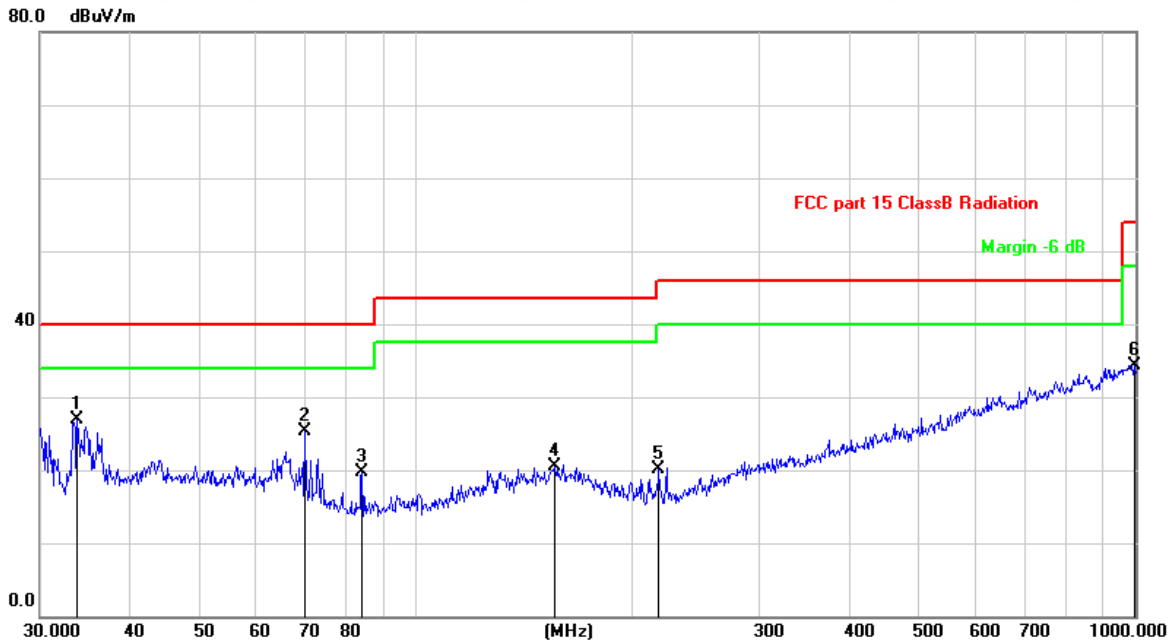

No.	Mk.	Freq. MHz	Reading Level dBuV	Correct Factor dB	Measure- ment dBuV/m	Limit dB/m	Over dB	Detector
1	*	33.7986	34.20	-7.33	26.87	40.00	-13.13	peak
2		70.0903	34.14	-8.89	25.25	40.00	-14.75	peak
3		84.1100	30.59	-10.92	19.67	40.00	-20.33	peak
4		155.9101	26.51	-6.02	20.49	43.50	-23.01	peak
5		217.5443	29.86	-9.71	20.15	46.00	-25.85	peak
6		996.4996	26.20	8.18	34.38	54.00	-19.62	peak

Remark: Factor = Cable lose + Antenna factor - Pre-amplifier; Over = Measurement – Limit

Remark:

- (1) Measuring frequencies from 9 KHz to the 1 GHz, Radiated emission test from 9KHz to 30MHz was verified, and no any emission was found except system noise floor.
- (2) \* denotes emission frequency which appearing within the Restricted Bands specified in provision of 15.205, then the general radiated emission limits in 15.209 apply.
- (3) The IF bandwidth of EMI Test Receiver between 30MHz to 1GHz was 120KHz, 1 MHz for measuring above 1 GHz, below 30MHz was 10KHz.



## Above 1 GHz Test Results:

## CH Low (2402MHz)

## Horizontal:

Frequency (MHz)	Reading Result (dB $\mu$ V)	Factor (dB)	Emission Level (dB $\mu$ V/m)	Limits (dB $\mu$ V/m)	Margin (dB)	Detector Type
2402	110.75	-5.81	104.94	114.00	-9.06	peak
2402	88.84	-5.81	83.03	94.00	-10.97	AVG
4804	56.45	-3.65	52.80	74.00	-21.20	peak
4804	50.51	-3.65	46.86	54.00	-7.14	AVG
7206	58.82	-0.95	57.87	74.00	-16.13	peak
7206	40.02	-0.95	39.07	54.00	-14.93	AVG

Remark: Factor = Antenna Factor + Cable Loss – Pre-amplifier. Emission level = Reading Result + Factor,  
Margin = Emission level - Limits

## Vertical:

Frequency (MHz)	Reading Result (dB $\mu$ V)	Factor (dB)	Emission Level (dB $\mu$ V/m)	Limits (dB $\mu$ V/m)	Margin (dB)	Detector Type
2402	109.84	-5.81	104.03	114.00	-9.97	peak
2402	86.55	-5.81	80.74	94.00	-13.26	AVG
4804	58.59	-3.65	54.94	74.00	-19.06	peak
4804	45.99	-3.65	42.34	54.00	-11.66	AVG
7206	59.68	-0.95	58.73	74.00	-15.27	peak
7206	44.32	-0.95	43.37	54.00	-10.63	AVG

Remark: Factor = Antenna Factor + Cable Loss – Pre-amplifier. Emission level = Reading Result + Factor,  
Margin = Emission level - Limits



CH Middle (2441MHz)

Horizontal:

Frequency (MHz)	Reading Result (dB $\mu$ V)	Factor (dB)	Emission Level (dB $\mu$ V/m)	Limits (dB $\mu$ V/m)	Margin (dB)	Detector Type
2441.00	108.71	-5.73	102.98	114.00	-11.02	peak
2441.00	84.35	-5.73	78.62	94.00	-15.38	AVG
4882.00	57.66	-3.54	54.12	74.00	-19.88	peak
4882.00	46.80	-3.54	43.26	54.00	-10.74	AVG
7323.00	55.28	-0.81	54.47	74.00	-19.53	peak
7323.00	41.61	-0.81	40.80	54.00	-13.20	AVG

Remark: Factor = Antenna Factor + Cable Loss – Pre-amplifier. Emission level = Reading Result + Factor, Margin = Emission level - Limits

Vertical:

Frequency (MHz)	Reading Result (dB $\mu$ V)	Factor (dB)	Emission Level (dB $\mu$ V/m)	Limits (dB $\mu$ V/m)	Margin (dB)	Detector Type
2441.00	106.18	-5.73	100.45	114.00	-13.55	peak
2441.00	86.72	-5.73	80.99	94.00	-13.01	AVG
4882.00	56.52	-3.54	52.98	74.00	-21.02	peak
4882.00	48.12	-3.54	44.58	54.00	-9.42	AVG
7323.00	56.12	-0.81	55.31	74.00	-18.69	peak
7323.00	41.16	-0.81	40.35	54.00	-13.65	AVG

Remark: Factor = Antenna Factor + Cable Loss – Pre-amplifier. Emission level = Reading Result + Factor, Margin = Emission level - Limits





CH High (2480MHz)

Horizontal:

Frequency	Reading Result	Factor	Emission Level	Limits	Margin	Detector Type
(MHz)	(dB $\mu$ V)	(dB)	(dB $\mu$ V/m)	(dB $\mu$ V/m)	(dB)	
2480	109.07	-5.63	103.44	114.00	-10.56	peak
2480	85.82	-5.63	80.19	94.00	-13.81	AVG
4960	56.62	-3.43	53.19	74.00	-20.81	peak
4960	47.28	-3.44	43.84	54.00	-10.16	AVG
7440	58.56	-0.77	57.79	74.00	-16.21	peak
7440	39.66	-0.77	38.89	54.00	-15.11	AVG

Remark: Factor = Antenna Factor + Cable Loss – Pre-amplifier. Emission level = Reading Result + Factor, Margin = Emission level - Limits

Vertical:

Frequency	Reading Result	Factor	Emission Level	Limits	Margin	Detector Type
(MHz)	(dB $\mu$ V)	(dB)	(dB $\mu$ V/m)	(dB $\mu$ V/m)	(dB)	
2480	109.02	-5.63	103.39	114.00	-10.61	peak
2480	85.72	-5.63	80.09	94.00	-13.91	AVG
4960	56.66	-3.43	53.23	74.00	-20.77	peak
4960	47.30	-3.44	43.86	54.00	-10.14	AVG
7440	58.63	-0.77	57.86	74.00	-16.14	peak
7440	39.80	-0.77	39.03	54.00	-14.97	AVG

Remark: Factor = Antenna Factor + Cable Loss – Pre-amplifier. Emission level = Reading Result + Factor, Margin = Emission level - Limits

Remark :

- (1) Measuring frequencies from 1 GHz to the 25 GHz.
- (2) "F" denotes fundamental frequency; "H" denotes spurious frequency. "E" denotes band edge frequency.
- (3) \* denotes emission frequency which appearing within the Restricted Bands specified in provision of 15.205, then the general radiated emission limits in 15.209 apply.
- (4) Data of measurement within this frequency range shown "---" in the table above means the reading of emissions are attenuated more than 20dB below the permissible limits or the field strength is too small to be measured.
- (5) The IF bandwidth of EMI Test Receiver between 30MHz to 1GHz was 120KHz, 1 MHz for measuring above 1 GHz, below 30MHz was 10KHz. The resolution bandwidth of test receiver/spectrum analyzer is 1MHz and video bandwidth is 3MHz for peak measurement with peak detector at frequency above 1GHz. The resolution bandwidth of test receiver/spectrum analyzer is 1MHz and video bandwidth is 10Hz for Average measurement with peak detection at frequency above 1GHz.
- (6) For fundamental frequency ,RBW >20dB BW, VBW=>3XRBW ,PK detector is for PK value ,RMS detector is for AV value.
- (7) All modes of operation were investigated and the worst-case emissions are reported.



## 5 BAND EDGE

### 5.1 Limits

FCC PART 15.249(d) Emissions radiated outside of the specified frequency bands, except for harmonics, shall be attenuated by at least 50 dB below the level of the fundamental or to the general radiated emission limits in §15.209, whichever is the lesser attenuation.

### 5.2 Test Procedure

The band edge compliance of RF radiated emission should be measured by following the guidance in ANSI C63.10 with respect to maximizing the emission by rotating the EUT, measuring the emission while the EUT is situated in three orthogonal planes (if appropriate), adjusting the measurement antenna height and polarization etc. RBW 1MHz VBW 3MHz PK detector is for PK value, RBW 1MHz VBW 10Hz PK detector is for AV value. The conducted RF band edge was measured by using a spectrum analyzer. Set span wide enough to capture the highest in-band emission and the emission at the band edge. Set RBW to 100 KHz and VBW to 300 KHz, to measure the conducted peak band edge.

### 5.3 Test Result

#### PASS

All the test modes completed for test. The worst case of Band Edge is GFSK; the test data of this mode was reported.

Radiated Band Edge Test:

Operation Mode: TX CH Low (2402MHz)

Horizontal (Worst case):

Frequency (MHz)	Reading Result (dBμV)	Factor (dB)	Emission Level (dBμV/m)	Limits (dBμV/m)	Margin (dB)	Detector Type
2310.00	58.58	-5.81	52.77	74.00	-21.23	peak
2310.00	/	-5.81	/	54.00	/	AVG
2390.00	56.15	-5.84	50.31	74.00	-23.69	peak
2390.00	/	-5.84	/	54.00	/	AVG
2400.00	55.95	-5.84	50.11	74.00	-23.89	peak
2400.00	/	-5.84	/	54.00	/	AVG

Remark: Factor = Antenna Factor + Cable Loss – Pre-amplifier. Emission level = Reading Result + Factor, Margin = Emission level - Limits





Vertical:

Frequency	Reading Result	Factor	Emission Level	Limits	Margin	Detector Type
(MHz)	(dB $\mu$ V)	(dB)	(dB $\mu$ V/m)	(dB $\mu$ V/m)	(dB)	
2310.00	58.60	-5.81	52.79	74.00	-21.21	peak
2310.00	/	-5.81	/	54.00	/	AVG
2390.00	56.33	-5.84	50.49	74.00	-23.51	peak
2390.00	/	-5.84	/	54.00	/	AVG
2400.00	55.98	-5.84	50.14	74.00	-23.86	peak
2400.00	/	-5.84	/	54.00	/	AVG

Remark: Factor = Antenna Factor + Cable Loss – Pre-amplifier. Emission level = Reading Result + Factor, Margin = Emission level - Limits

Operation Mode: TX CH High (2480MHz)

Horizontal (Worst case)

Frequency	Reading Result	Factor	Emission Level	Limits	Margin	Detector Type
(MHz)	(dB $\mu$ V)	(dB)	(dB $\mu$ V/m)	(dB $\mu$ V/m)	(dB)	
2483.50	57.54	-5.81	51.73	74.00	-22.27	peak
2483.50	/	-5.81	/	54.00	/	AVG
2500.00	53.81	-6.06	47.75	74.00	-26.25	peak
2500.00	/	-6.06	/	54.00	/	AVG

Remark: Factor = Antenna Factor + Cable Loss – Pre-amplifier. Emission level = Reading Result + Factor, Margin = Emission level - Limits

Vertical:

Frequency	Reading Result	Factor	Emission Level	Limits	Margin	Detector Type
(MHz)	(dB $\mu$ V)	(dB)	(dB $\mu$ V/m)	(dB $\mu$ V/m)	(dB)	
2483.50	54.66	-5.81	48.85	74.00	-25.15	peak
2483.50	/	-5.81	/	54.00	/	AVG
2500.00	53.03	-6.06	46.97	74.00	-27.03	peak
2500.00	/	-6.06	/	54.00	/	AVG

Remark: Factor = Antenna Factor + Cable Loss – Pre-amplifier. Emission level = Reading Result + Factor, Margin = Emission level - Limits

Remark: All the other emissions not reported were too low to read and deemed to comply with FCC limit.





## 6 OCCUPIED BANDWIDTH MEASUREMENT

### 6.1 Test Setup

Same as Radiated Emission Measurement

### 6.2 Test Procedure

1. The EUT was placed on a turn table which is 0.8m above ground plane.
2. Set EUT as normal operation.
3. Based on ANSI C63.10 section 6.9.2: RBW= 30KHz. VBW= 100 KHz, Span=2MHz.
4. The useful radiated emission from the EUT was detected by the spectrum analyser with peak detector.

### 6.3 Measurement Equipment Used

Same as Radiated Emission Measurement

### 6.4 Test Result

**PASS**

Test Mode	Frequency	20dB Bandwidth (MHz)	Result
GFSK	2402 MHz	0.7262	<b>PASS</b>
	2441 MHz	0.8153	<b>PASS</b>
	2480 MHz	0.8225	<b>PASS</b>
$\pi/4$ DQPSK	2402 MHz	1.099	<b>PASS</b>
	2441 MHz	1.1111	<b>PASS</b>
	2480 MHz	1.1115	<b>PASS</b>
8DPSK	2402 MHz	1.1149	<b>PASS</b>
	2441 MHz	1.0884	<b>PASS</b>
	2480 MHz	1.0871	<b>PASS</b>



Test Mode: GFSK

CH: 2402MHz

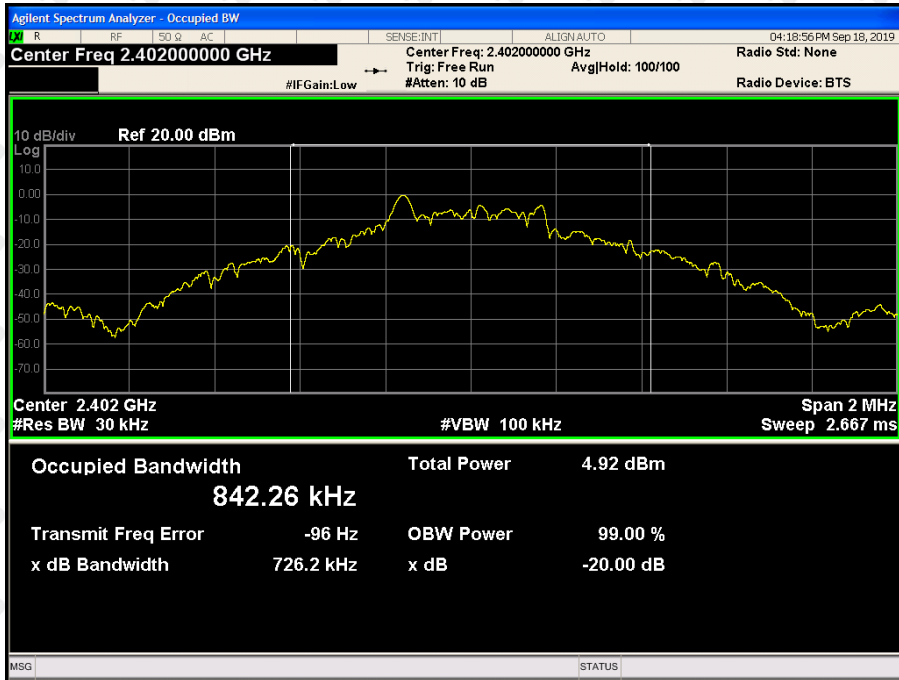

CH: 2441MHz





CH: 2480MHz

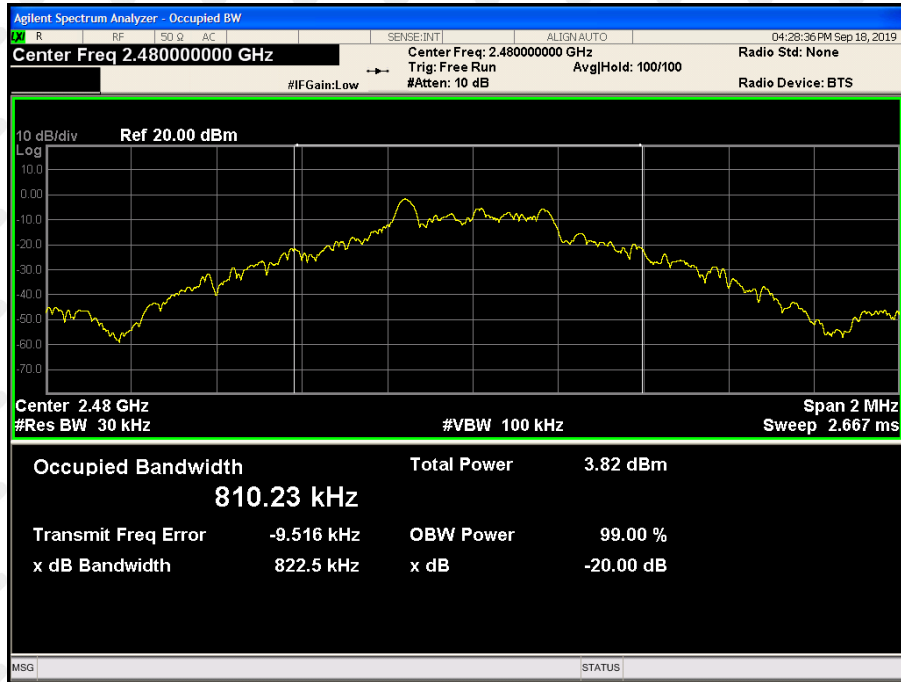

Test Mode:  $\pi/4$ DQPSK

CH: 2402MHz

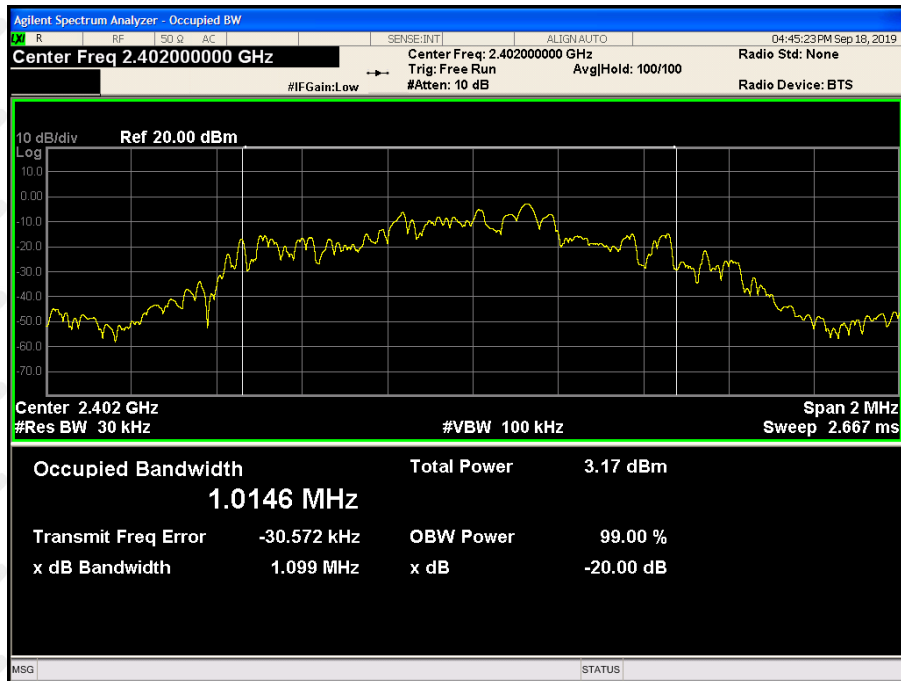





CH: 2441MHz

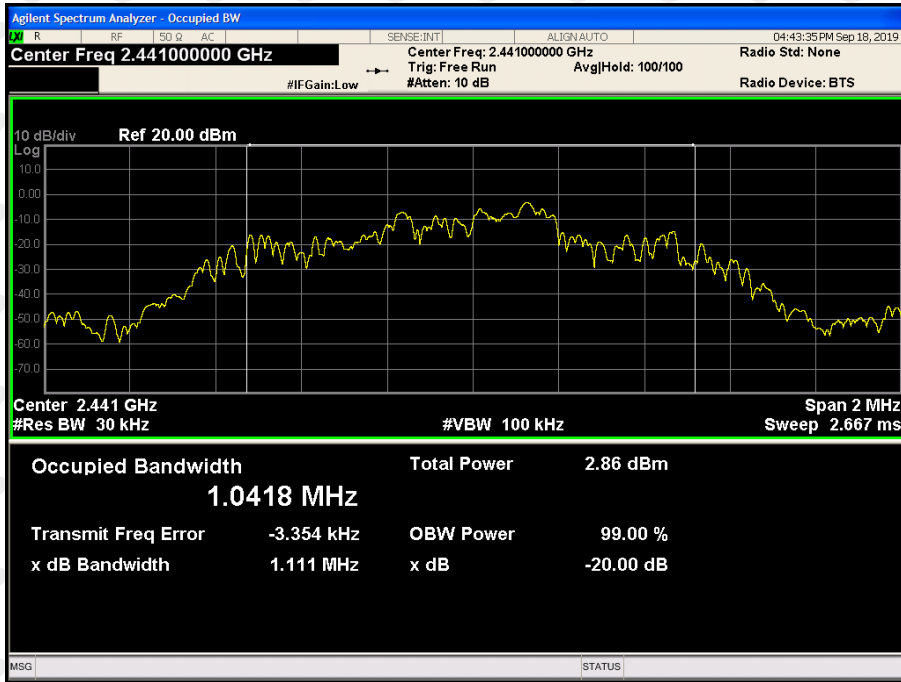

CH: 2480MHz

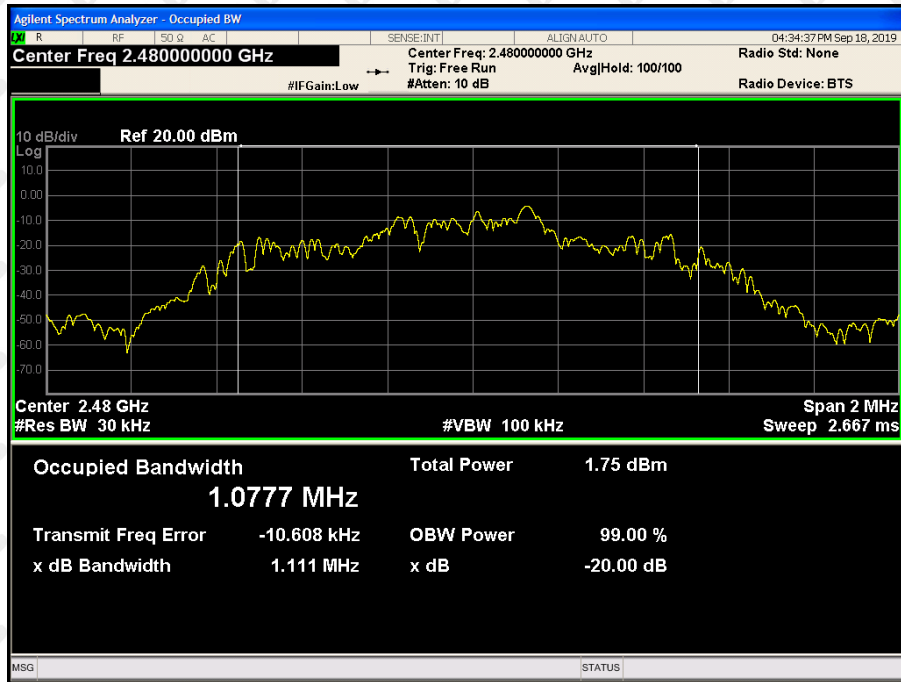



Test Mode: 8DPSK

CH: 2402MHz

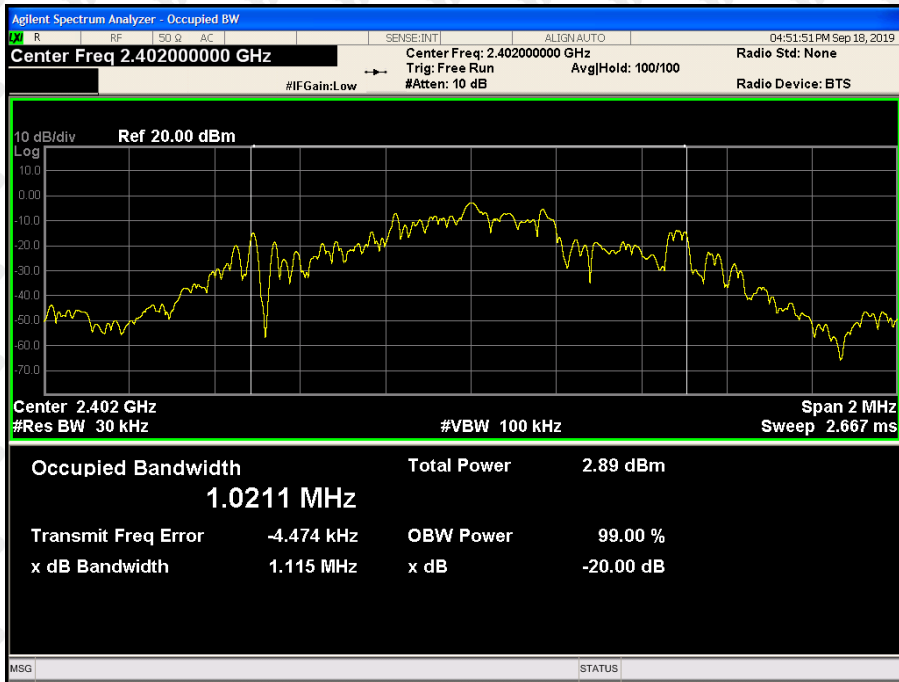

CH: 2441MHz

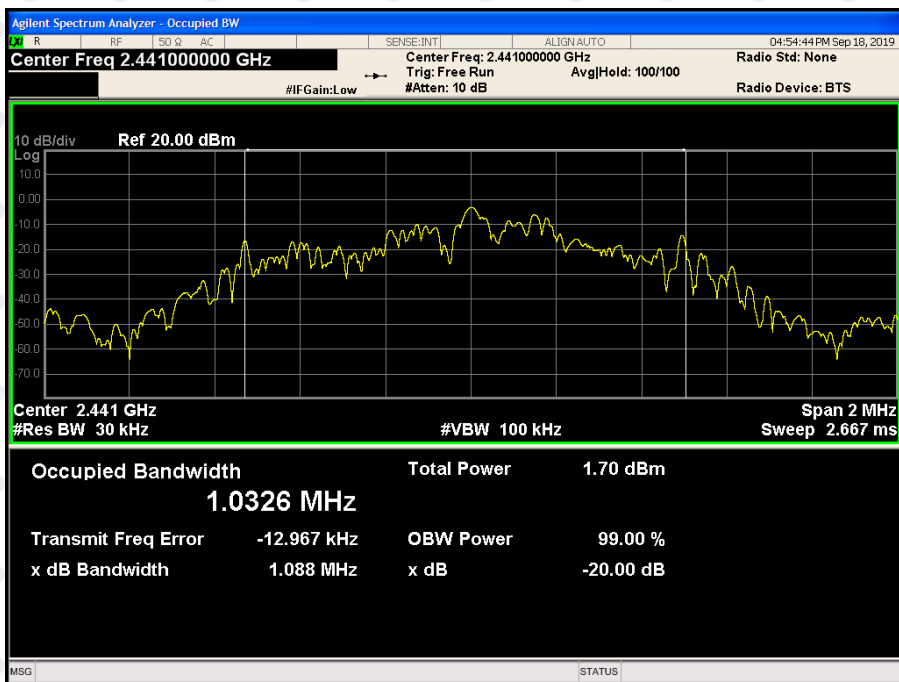



CH: 2480MHz

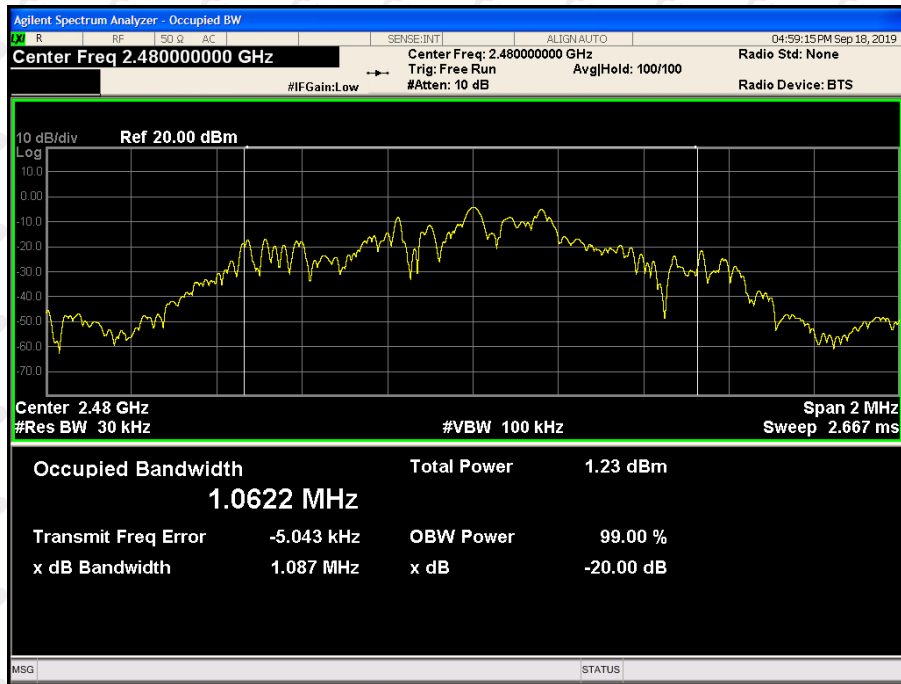





## 7 ANTENNA REQUIREMENT

### Standard Applicable

For intentional device, according to FCC 47 CFR Section 15.203, an intentional radiator shall be designed to ensure that no antenna other than that furnished by the responsible party shall be used with the device. And according to FCC 47 CFR Section 15.249, if transmitting antennas of directional gain greater than 6dBi are used, the power shall be reduced by the amount in dB that the directional gain of the antenna exceeds 6dBi.

### Antenna Connected Construction

The antenna used in this product is Internal Antenna, The directional gains of antenna used for transmitting is 0.8dBi.

### ANTENNA

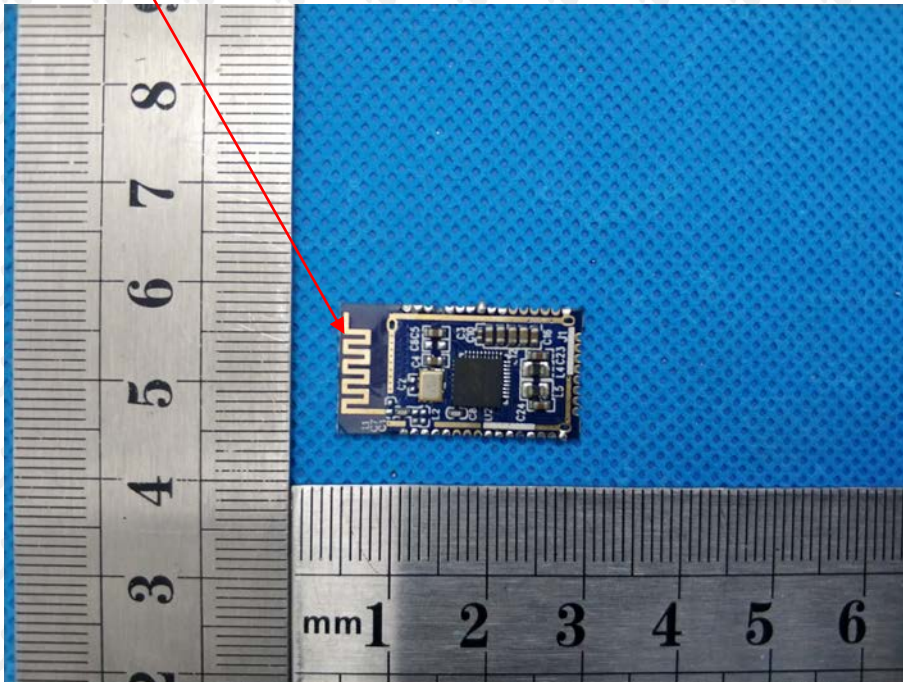



## 8 PHOTOGRAPH OF TEST

### 8.1 Radiated Emission

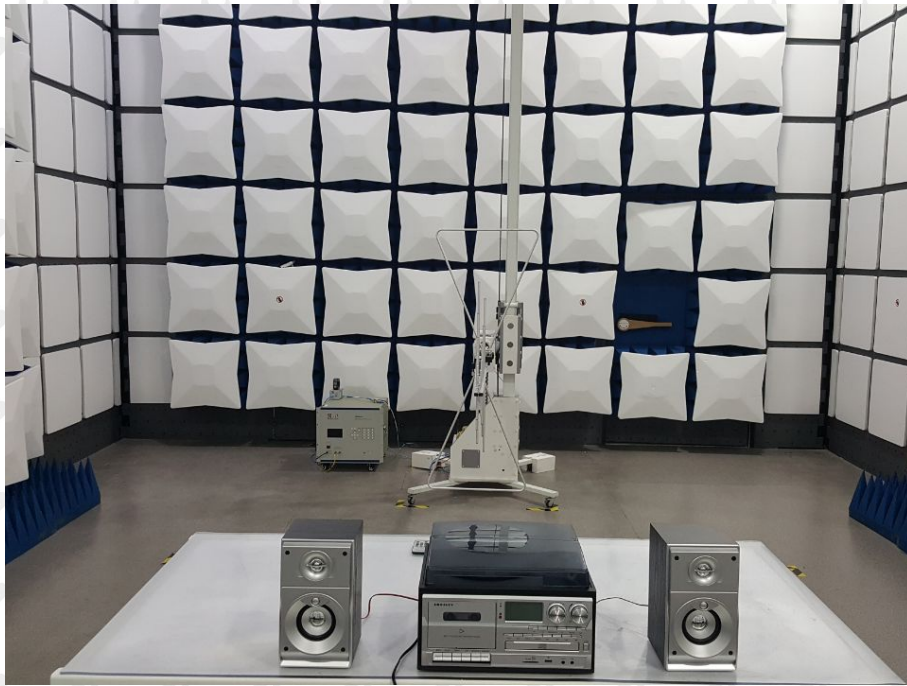





## 8.2 Conducted Emission



\*\*\*End of Report\*\*\*