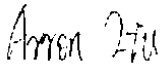

TEST REPORT

Product Name: LEWIS RETRO RADIO
FCC ID: AUSCR3038A
Trademark: CROSLEY
Model Number: CR3038A-BK , CR3038X-XXXX("X-XXXX"can be replaced by letter from"A"to"Z" , number from"0"to"9"or blank)
Prepared For: Modern Marketing Concepts, Inc.
Address: 1220 E Oak, St. Louisville, KY 40204, United States
Manufacturer: Timsen Development Limited
Address: 5F, 447# Tianhebei Road, Guangzhou, China
Prepared By: Shenzhen CTB Testing Technology Co., Ltd.
Address: Floor 1&2, Building A, No. 26 of Xinghe Road, Xinqiao Community, Xinqiao Street, Baoan District, Shenzhen, Guangdong China
Sample Received Date: Jul. 7, 2020
Sample tested Date: Jul. 7, 2020 to Aug. 12, 2020
Issue Date: Aug. 12, 2020
Report No.: CTB200812010RFX
Test Standards: FCC Part15.247
ANSI C63.10:2013
Test Results: PASS
Remark: This is Bluetooth radio test report.

Compiled by:

Arron Liu

Reviewed by:

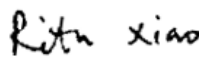
Rita Xiao

Approved by:

Sherwin Qian/ Director

The test report is effective only with both signature and specialized stamp. This result(s) shown in this report refer only to the sample(s) tested. Without written approval of Shenzhen CTB Testing Technology Co., Ltd. this report can't be reproduced except in full. The tested sample(s) and the sample information are provided by the client.

TABLE OF CONTENT

Test Report Declaration	Page
1. VERSION.....	4
2. TEST SUMMARY	5
3. MEASUREMENT UNCERTAINTY	6
4. PRODUCT INFORMATION AND TEST SETUP	7
4.1 Product Information	7
4.2 Test Setup Configuration	7
4.3 Support Equipment	7
4.4 Channel List.....	8
4.5 Test Mode.....	8
4.6 Test Environment.....	8
5. TEST FACILITY AND TEST INSTRUMENT USED.....	9
5.1 Test Facility	9
5.2 Test Instrument Used	9
6. AC POWER LINE CONDUCTED EMISSION	11
6.1 Block Diagram Of Test Setup	11
6.2 Limit	11
6.3 Test procedure.....	11
6.4 Test Result	13
7. RADIATED SPURIOUS EMISSION	15
7.1 Block Diagram Of Test Setup	15
7.2 Limit	15
7.3 Test procedure.....	16
7.4 Test Result	17
8. BAND EDGE AND RF CONDUCTED SPURIOUS EMISSIONS.....	26
8.1 Block Diagram Of Test Setup	26
8.2 Limit	26
8.3 Test procedure.....	26
8.4 Test Result	27
9. CONDUCTED PEAK OUTPUT POWER.....	34
9.1 Block Diagram Of Test Setup	34

9.2	Limit	34
9.3	Test procedure.....	34
9.4	Test Result	35
10.	20DB OCCUPIED BANDWIDTH	39
10.1	Block Diagram Of Test Setup	39
10.2	Limit.....	39
10.3	Test procedure.....	39
10.4	Test Result.....	39
11.	CARRIER FREQUENCIES SEPARATION	43
11.1	Block Diagram Of Test Setup	43
11.2	Limit	43
11.3	Test procedure.....	43
11.4	Test Result.....	43
12.	HOPPING CHANNEL NUMBER	47
12.1	Block Diagram Of Test Setup	47
12.2	Limit	47
12.3	Test procedure.....	47
12.4	Test Result.....	47
13.	DWELL TIME	49
13.1	Block Diagram Of Test Setup	49
13.2	Limit	49
13.3	Test procedure.....	49
13.4	Test Result.....	50
14.	PSEUDORANDOM FREQUENCY	54
14.1	Limit.....	54
14.2	Test procedure.....	54
14.3	Test Result.....	55
15.	ANTENNA REQUIREMENT	56
16.	EUT PHOTOGRAPHS	57
17.	EUT TEST SETUP PHOTOGRAPHS	58

(Note: N/A means not applicable)

1. VERSION

Report No.	Issue Date	Description	Approved
CTB200812010RFX	Aug. 12, 2020	Original	Valid

2. TEST SUMMARY

The Product has been tested according to the following specifications:

Test Item	Test Requirement	Test method	Result
AC Power Line Conducted Emission	47 CFR Part 15 Subpart C Section 15.207	ANSI C63.10-2013	PASS
Radiated Spurious emissions	47 CFR Part 15 Subpart C Section 15.205/15.209	ANSI C63.10-2013	PASS
Band edge and RF Conducted Spurious Emissions	47 CFR Part 15 Subpart C Section 15.247(d)/15.205(a)	ANSI C63.10-2013	PASS
Conducted Peak Output Power	47 CFR Part 15 Subpart C Section 15.247 (b)(1)	ANSI C63.10-2013	PASS
20dB Occupied Bandwidth	47 CFR Part 15 Subpart C Section 15.247 (a)(1)	ANSI C63.10-2013	PASS
Carrier Frequencies Separation	47 CFR Part 15 Subpart C Section 15.247 (a)(1)	ANSI C63.10-2013	PASS
Hopping Channel Number	47 CFR Part 15 Subpart C Section 15.247 (b)	ANSI C63.10-2013	PASS
Dwell Time	47 CFR Part 15 Subpart C Section 15.247 (a)(1)	ANSI C63.10-2013	PASS
Pseudorandom Frequency Hopping Sequence	47 CFR Part 15 Subpart C Section 15.247(b)(4)&TCB Exclusion List (7 July 2002)	ANSI C63.10-2013	PASS
Antenna Requirement	47 CFR Part 15 Subpart C Section 15.203/15.247 (c)	ANSI C63.10-2013	PASS
RF Exposure Evaluation	47 CFR Part 15 Subpart C Section 15.247 (i)/1.1310/2.1093	KDB447498D01v06	PASS

Remark:

Test according to ANSI C63.4-2014 & ANSI C63.10-2013.

3. MEASUREMENT UNCERTAINTY

Where relevant, the following measurement uncertainty levels have been estimated for tests performed on the Product as specified in CISPR 16-4-2. This uncertainty represents an expanded uncertainty expressed at approximately the 95% confidence level using a coverage factor of $k=2$.

Item	Uncertainty
Occupancy bandwidth	54.3kHz
Conducted output power Above 1G	0.9dB
Conducted output power below 1G	0.9dB
Power Spectral Density , Conduction	0.9dB
Conduction spurious emissions	2.0dB
Out of band emission	2.0dB
3m chamber Radiated spurious emission(30MHz-1GHz)	4.6dB
3m chamber Radiated spurious emission(1GHz-18GHz)	5.1dB
3m chamber Radiated spurious emission(18GHz-40GHz)	3.4dB
humidity uncertainty	5.5%
Temperature uncertainty	0.63°C
frequency	1×10^{-7}
Conducted Emission (150KHz-30MHz)	3.2 dB
Radiated Emission(30MHz ~ 1000MHz)	4.8 dB
Radiated Emission(1GHz ~6GHz)	4.9 dB

4. PRODUCT INFORMATION AND TEST SETUP

4.1 Product Information

Model(s):	CR3038A-BK , CR3038X-XXXX("X-XXXX"can be replaced by letter from“A”to“Z” , number from“0”to“9”or blank)
Model Description:	All model’s the function, software and electric circuit are the same, only with the product Installation Method and model named different. Test sample model: CR3038A-BK
Bluetooth Version:	Bluetooth 5.0
Hardware Version:	V-0
Software Version:	V-0
Operation Frequency:	Bluetooth: 2402-2480MHz
Max. RF output power:	Bluetooth: 1.826dBm
Type of Modulation:	Bluetooth: GFSK, $\pi/4$ DQPSK, 8DPSK
Antenna installation:	Bluetooth: PCB Antenna
Antenna Gain:	Bluetooth: 0.5dBi
Ratings:	AC120V/60Hz

4.2 Test Setup Configuration

See test photographs attached in EUT TEST SETUP PHOTOGRAPHS for the actual connections between Product and support equipment.

4.3 Support Equipment

Item	Equipment	Mfr/Brand	Model/Type No.	Series No.	Note
1	LEWIS RETRO RADIO	CROSLEY	CR3038A-BK	N/A	EUT

Notes:

1. All the equipment/cables were placed in the worst-case configuration to maximize the emission during the test.
2. Grounding was established in accordance with the manufacturer’s requirements and conditions for the intended use.

4.4 Channel List

CH	Frequency (MHz)	CH	Frequency (MHz)	CH	Frequency (MHz)	CH	Frequency (MHz)
0	2402	1	2403	2	2404	3	2405
4	2406	5	2407	6	2408	7	2409
8	2410	9	2411	10	2412	11	2413
12	2414	13	2415	14	2416	15	2417
16	2418	17	2419	18	2420	19	2421
20	2422	21	2423	22	2424	23	2425
24	2426	25	2427	26	2428	27	2429
28	2430	29	2431	30	2432	31	2433
32	2434	33	2435	34	2436	35	2437
36	2438	37	2439	38	2440	39	2441
40	2442	41	2443	42	2444	43	2445
44	2446	45	2447	46	2448	47	2449
48	2450	49	2451	50	2452	51	2453
52	2454	53	2455	54	2456	55	2457
56	2458	57	2459	58	2460	59	2461
60	2462	61	2463	62	2464	63	2465
64	2466	65	2467	66	2468	67	2469
68	2470	69	2471	70	2472	71	2473
72	2474	73	2475	74	2476	75	2477
76	2478	77	2479	78	2480	79	/

4.5 Test Mode

All test mode(s) and condition(s) mentioned were considered and evaluated respectively by performing full tests, the worst data were recorded and reported.

Test mode	Low channel	Middle channel	High channel
Transmitting (GFSK/π/4DQPSK/8DPSK)	2402MHz	2441MHz	2480MHz
Receiving (GFSK/π/4DQPSK/8DPSK)	2402MHz	2441MHz	2480MHz

4.6 Test Environment

Humidity(%):	55
Atmospheric Pressure(kPa):	101.1
Normal Voltage(AC):	120V
Normal Temperature(°C)	25
Low Temperature(°C)	0
High Temperature(°C)	40

5. TEST FACILITY AND TEST INSTRUMENT USED

5.1 Test Facility

All measurement facilities used to collect the measurement data are located at Floor 1&2, Building A, No. 26 of Xinghe Road, Xinqiao Street, Baoan District, Shenzhen China. The site and apparatus are constructed in conformance with the requirements of ANSI C63.4 and CISPR 16-1-1 other equivalent standards.

5.2 Test Instrument Used

Item	Equipment	Manufacturer	Type No.	Serial No.	Last calibration	Calibrated until
1	Spectrum Analyzer	Agilent	N9020A	MY52090073	Oct. 17, 2019	Oct. 16, 2020
2	Power Sensor	Agilent	U2021XA	MY56120032	Nov. 02, 2019	Nov. 01, 2020
3	Power Sensor	Agilent	U2021XA	MY56120034	Nov. 02, 2019	Nov. 01, 2020
4	Communication test set	R&S	CMW500	118735	Nov. 02, 2019	Nov. 01, 2020
5	Spectrum Analyzer	R&S	FSP40	100550	Nov. 02, 2019	Nov. 01, 2020
6	Signal Generator	Agilent	N5181A	MY49060920	Nov. 03, 2019	Nov. 02, 2020
7	Signal Generator	Agilent	N5182A	MY47420195	Nov. 03, 2019	Nov. 02, 2020
8	Communication test set	R&S	CMU200	119978	Nov. 02, 2019	Nov. 01, 2020
9	band rejection filter	Shenxiang	MSF2400-24 83.5MS-1154	20181015001	Nov. 02, 2019	Nov. 01, 2020
10	band rejection filter	Shenxiang	MSF5150-58 50MS-1155	20181015001	Nov. 02, 2019	Nov. 01, 2020
11	band rejection filter	Xingbo	XBLBQ-DZA 120	190821-1-1	Nov. 02, 2019	Nov. 01, 2020
12	BT&WI-FI Automatic test software	Microwave	MTS8310	Ver. 2.0.0.0	\	\
13	Rohde & Schwarz SFU Broadcast Test System	R&S	SFU	101017	Nov. 02, 2019	Nov. 01, 2020
14	Temperature humidity chamber	Hongjing	TH-80CH	DG-15174	Nov. 02, 2019	Nov. 01, 2020
15	234G Automatic test software	Microwave	MTS8200	Ver. 2.0.0.0	\	\
16	966 chamber	C.R.T.	966 Room	966	Nov. 10, 2019	Nov. 09, 2020

17	Receiver	R&S	ESPI	100362	Nov. 02, 2019	Nov. 01, 2020
18	Amplifier	HP	8447E	2945A02747	Nov. 03, 2019	Nov. 02, 2020
19	Amplifier	Agilent	8449B	3008A01838	Nov. 03, 2019	Nov. 02, 2020
20	TRILOG Broadband Antenna	Schwarzbeck	VULB 9163	869	Nov. 02, 2019	Nov. 01, 2020
21	Horn Antenna	Schwarzbeck	BBHA9120D	1911	Nov. 02, 2019	Nov. 01, 2020
22	Software	Fala	EZ-EMC	FA-03A2 RE	\	\
23	3-Loop Antenna	Daze	ZN30401	17014	Nov. 02, 2019	Nov. 01, 2020
24	loop antenna	ZHINAN	ZN30900A	/	Nov. 02, 2019	Nov. 01, 2020
25	Horn antenna	A/H/System	SAS-574	588	Nov. 02, 2019	Nov. 01, 2020
26	Amplifier	AEROFLEX	/	S/N/ 097	Nov. 02, 2019	Nov. 01, 2020

Conducted emissions Test						
	Equipment	Manufacturer	Model#	Serial#	Last Cal.	Next Cal.
27	AMN	ROHDE&SC HWARZ	ESH3-Z5	831551852	Nov. 02, 2019	Nov. 01, 2020
29	Pulse limiter	ROHDE&SC HWARZ	ESH3Z2	357881052	Nov. 02, 2019	Nov. 01, 2020
30	EMI TEST RECEIVER	ROHDE&SC HWARZ	ESCS30	834115/006	Nov. 02, 2019	Nov. 01, 2020
31	Coaxial cable	ZDECL	Z302S	18091904	Nov. 02, 2019	Nov. 01, 2020
32	ISN	TESEQ	NTFM8158	NTFM8158# 183	Nov. 02, 2019	Nov. 01, 2020
33	EMI TEST RECEIVER	ROHDE&SC HWARZ	ESCI	10428	Nov. 02, 2019	Nov. 01, 2020
34	Software	Fala	EZ-EMC	EMC-CON 3A1.1	\	\

6. AC POWER LINE CONDUCTED EMISSION

6.1 Block Diagram Of Test Setup

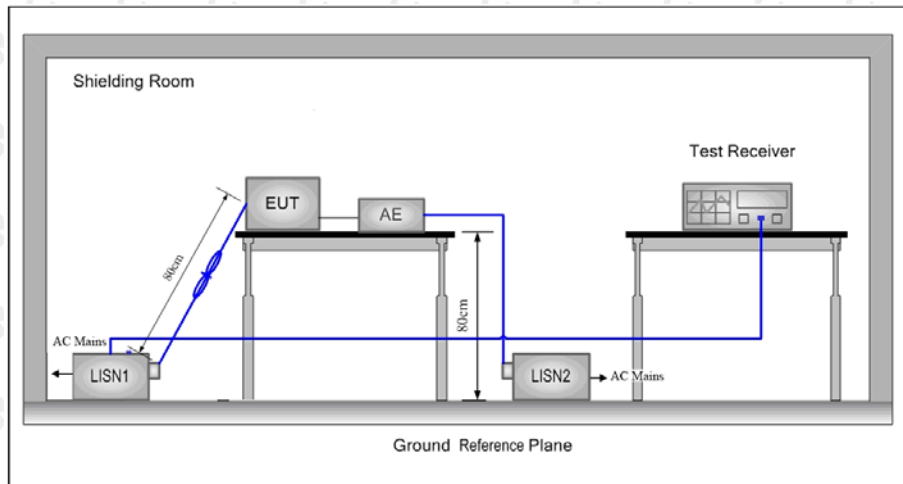

6.2 Limit

Frequency (MHz)	Maximum RF Line Voltage (dB μ V)			
	CLASS A		CLASS B	
	Q.P.	Ave.	Q.P.	Ave.
0.15 - 0.50	79	66	66-56*	56-46*
0.50 - 5.00	73	60	56	46
5.00 - 30.0	73	60	60	50

* Decreasing linearly with the logarithm of the frequency

6.3 Test procedure

- 1) The mains terminal disturbance voltage test was conducted in a shielded room.
- 2) The EUT was connected to AC power source through a LISN 1 (Line Impedance Stabilization Network) which provides a 50 Ω /50 μ H + 5 Ω linear impedance. The power cables of all other units of the EUT were connected to a second LISN 2, which was bonded to the ground reference plane in the same way as the LISN 1 for the unit being measured. A multiple socket outlet strip was used to connect multiple power cables to a single LISN provided the rating of the LISN was not exceeded.
- 3) The tabletop EUT was placed upon a non-metallic table 0.8m above the ground reference plane. And for floor-standing arrangement, the EUT was placed on the horizontal ground reference plane,
- 4) The test was performed with a vertical ground reference plane. The rear of the EUT shall be 0,4 m from the vertical ground reference plane. The vertical ground reference plane was bonded to the horizontal ground reference plane. The LISN 1 was placed 0,8 m from the boundary of the unit under test and bonded to a ground reference plane for LISNs mounted on top of the ground reference plane. This distance was

between the closest points of the LISN 1 and the EUT. All other units of the EUT and associated equipment was at least 0,8 m from the LISN 2.

- 5) In order to find the maximum emission, the relative positions of equipment and all of the interface cables must be changed according to ANSI C63.10 on conducted measurement.
- 6) All modes were tested at AC 120V and 240V, only the worst result of AC 120V 60Hz was reported.
- 7) If a EUT received DC power from the USB Port of Notebook PC, the PC's adapter received AC120V/60Hz power through a Line Impedance Stabilization Network (LISN) which supplied power source and was grounded to the ground plane.

6.4 Test Result

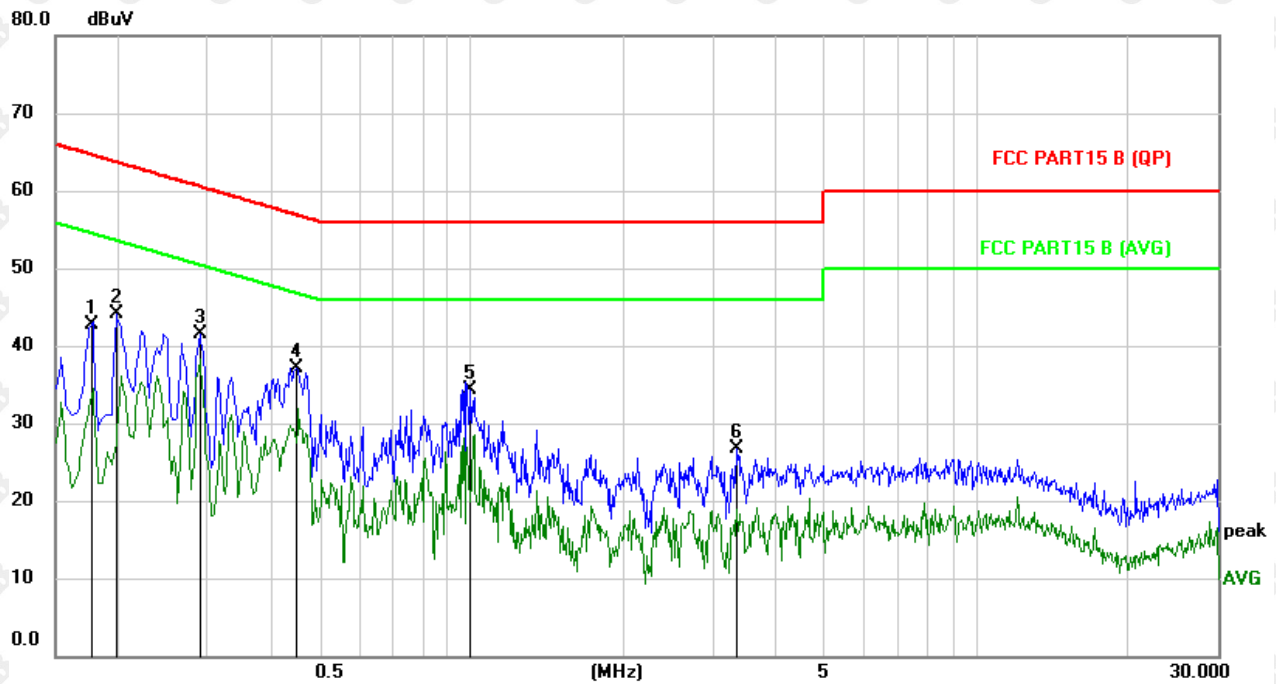

No.	Mk.	Freq. MHz	Reading Level dBuV	Correct Factor dB	Measure- ment dBuV	Limit dBuV	Margin dB	Detector
1		0.1768	32.69	10.10	42.79	64.63	-21.84	peak
2		0.1980	34.00	10.12	44.12	63.69	-19.57	peak
3	*	0.2900	31.31	10.15	41.46	60.52	-19.06	peak
4		0.4500	26.93	10.22	37.15	56.88	-19.73	peak
5		0.9980	24.18	10.15	34.33	56.00	-21.67	peak
6		3.3620	16.49	10.30	26.79	56.00	-29.21	peak

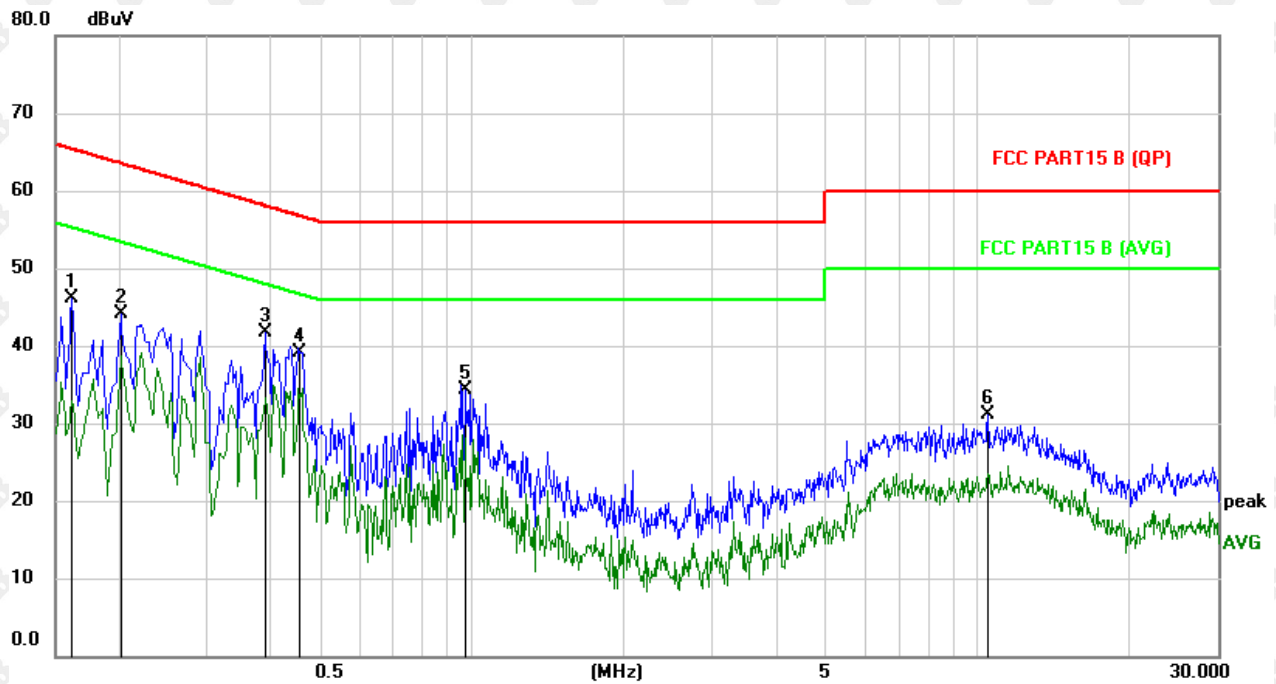

No.	Mk.	Freq. MHz	Reading Level dBuV	Correct Factor dB	Measure- ment dBuV	Limit dBuV	Margin dB	Detector
1		0.1620	35.92	10.21	46.13	65.36	-19.23	peak
2		0.2020	33.81	10.22	44.03	63.53	-19.50	peak
3	*	0.3899	31.56	10.11	41.67	58.07	-16.40	peak
4		0.4580	29.07	10.08	39.15	56.73	-17.58	peak
5		0.9700	24.17	10.22	34.39	56.00	-21.61	peak
6		10.5140	20.65	10.55	31.20	60.00	-28.80	peak

7. RADIATED SPURIOUS EMISSION

7.1 Block Diagram Of Test Setup

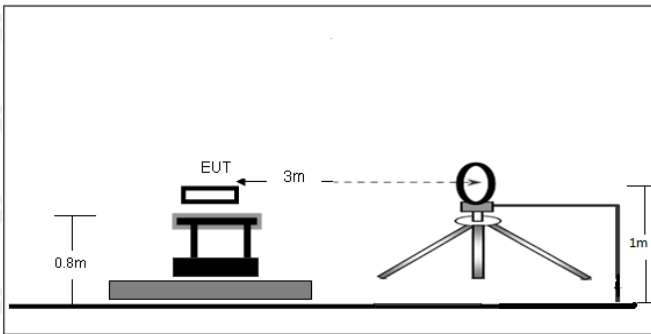

Figure 1. Below 30MHz

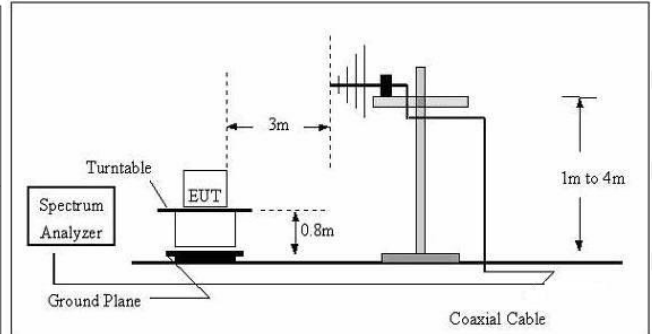

Figure 2. 30MHz to 1GHz

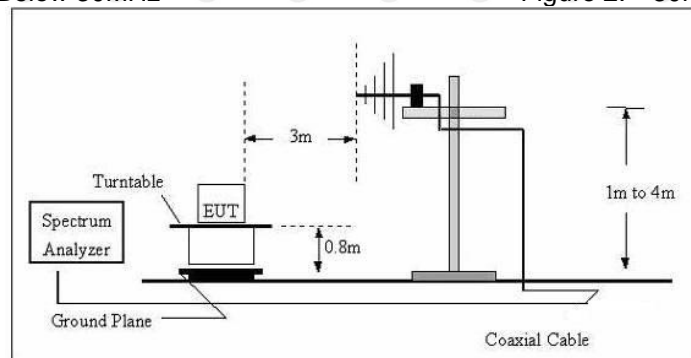

Figure 3. Above 1GHz

7.2 Limit

Spurious Emissions:

Frequency	Field strength (microvolt/meter)	Limit (dB μ V/m)	Remark	Measurement distance (m)
0.009MHz-0.490MHz	2400/F (kHz)	-	-	300
0.490MHz-1.705MHz	24000/F (kHz)	-	-	30
1.705MHz-30MHz	30	-	-	30
30MHz-88MHz	100	40.0	Quasi-peak	3
88MHz-216MHz	150	43.5	Quasi-peak	3
216MHz-960MHz	200	46.0	Quasi-peak	3
960MHz-1GHz	500	54.0	Quasi-peak	3
Above 1GHz	500	54.0	Average	3

Note: 15.35(b), Unless otherwise specified, the limit on peak radio frequency emissions is 20dB above the maximum permitted average emission limit applicable to the equipment under test. This peak limit applies to the total peak emission level radiated by the device.

7.3 Test procedure

Below 1GHz test procedure as below:

- a. The EUT was placed on the top of a rotating table 0.8 meters above the ground at a 3 meter semi-anechoic chamber. The table was rotated 360 degrees to determine the position of the highest radiation.
- b. The EUT was set 3 meters away from the interference-receiving antenna, which was mounted on the top of a variable-height antenna tower.
- c. The antenna height is varied from one meter to four meters above the ground to determine the maximum value of the field strength. Both horizontal and vertical polarizations of the antenna are set to make the measurement.
- d. For each suspected emission, the EUT was arranged to its worst case and then the antenna was tuned to heights from 1 meter to 4 meters (for the test frequency of below 30MHz, the antenna was tuned to heights 1 meter) and the rota table table was turned from 0 degrees to 360 degrees to find the maximum reading.
- e. The test-receiver system was set to Peak Detect Function and Specified Bandwidth with Maximum Hold Mode.
- f. If the emission level of the EUT in peak mode was 10dB lower than the limit specified, then testing could be stopped and the peak values of the EUT would be reported. Otherwise the emissions that did not have 10dB margin would be re-tested one by one using peak, quasi-peak or average method as specified and then reported in a data sheet.

Above 1GHz test procedure as below:

- g. Different between above is the test site, change from Semi- Anechoic Chamber to fully Anechoic Chamber and change form table 0.8 meter to 1.5 meter(Above 18GHz the distance is 1 meter and table is 1.5 meter).
- h. Test the EUT in the lowest channel ,the middle channel ,the Highest channel
- j. Repeat above procedures until all frequencies measured was complete.
- j. Full battery is used during test

Receiver set:

Frequency	Detector	RBW	VBW	Remark
0.009MHz-0.090MHz	Peak	10kHz	30KHz	Peak
0.009MHz-0.090MHz	Average	10kHz	30KHz	Average
0.090MHz-0.110MHz	Quasi-peak	10kHz	30KHz	Quasi-peak
0.110MHz-0.490MHz	Peak	10kHz	30KHz	Peak
0.110MHz-0.490MHz	Average	10kHz	30KHz	Average
0.490MHz -30MHz	Quasi-peak	10kHz	30kHz	Quasi-peak
30MHz-1GHz	Quasi-peak	120 kHz	300KHz	Quasi-peak
Above 1GHz	Peak	1MHz	3MHz	Peak
	Peak	1MHz	10Hz	Average

7.4 Test Result

Below 1GHz Test Results:
Antenna polarity: H

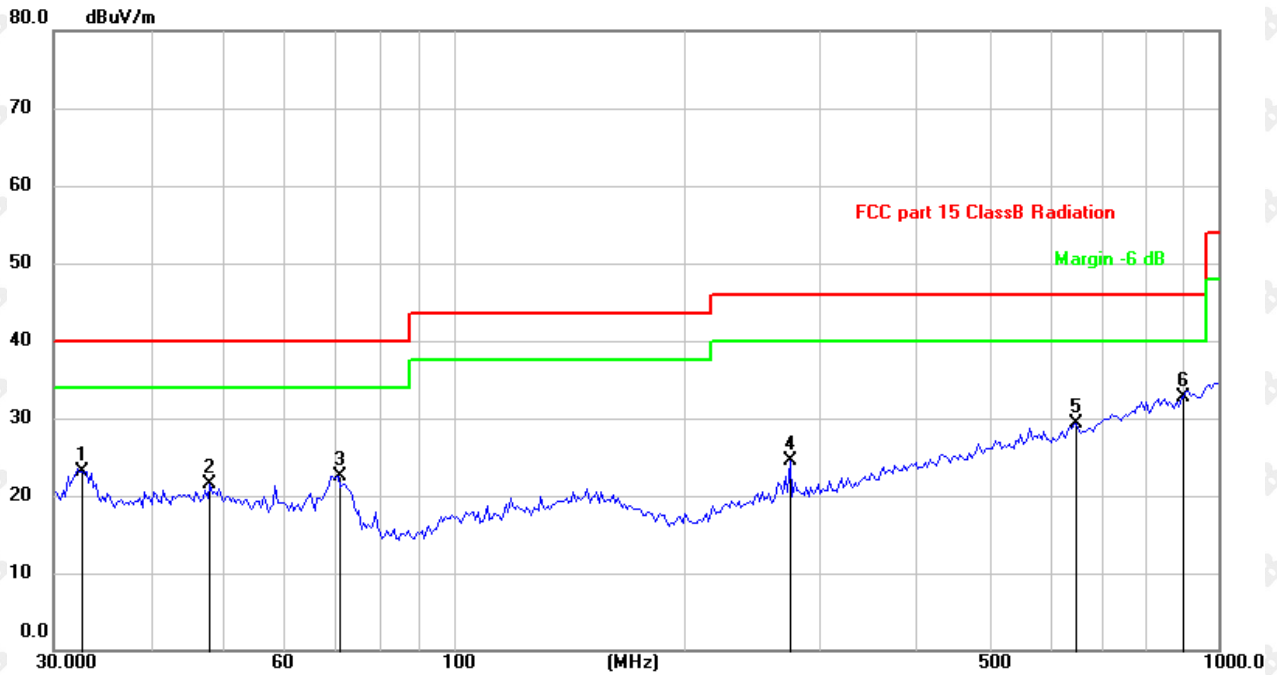

No.	Mk.	Freq. MHz	Reading Level dBuV	Correct Factor dB	Measure- ment dBuV/m	Limit dB/m	Margin dB	Detector
1		32.6340	30.25	-7.14	23.11	40.00	-16.89	peak
2		47.9940	27.44	-5.98	21.46	40.00	-18.54	peak
3		70.5836	31.29	-8.81	22.48	40.00	-17.52	peak
4		275.1570	30.30	-5.75	24.55	46.00	-21.45	peak
5		651.9417	26.36	2.98	29.34	46.00	-16.66	peak
6	*	893.8567	25.81	6.89	32.70	46.00	-13.30	peak

Remark: Factor = Cable lose + Antenna factor - Pre-amplifier; Margin = Measurement- Limit

Antenna polarity: V

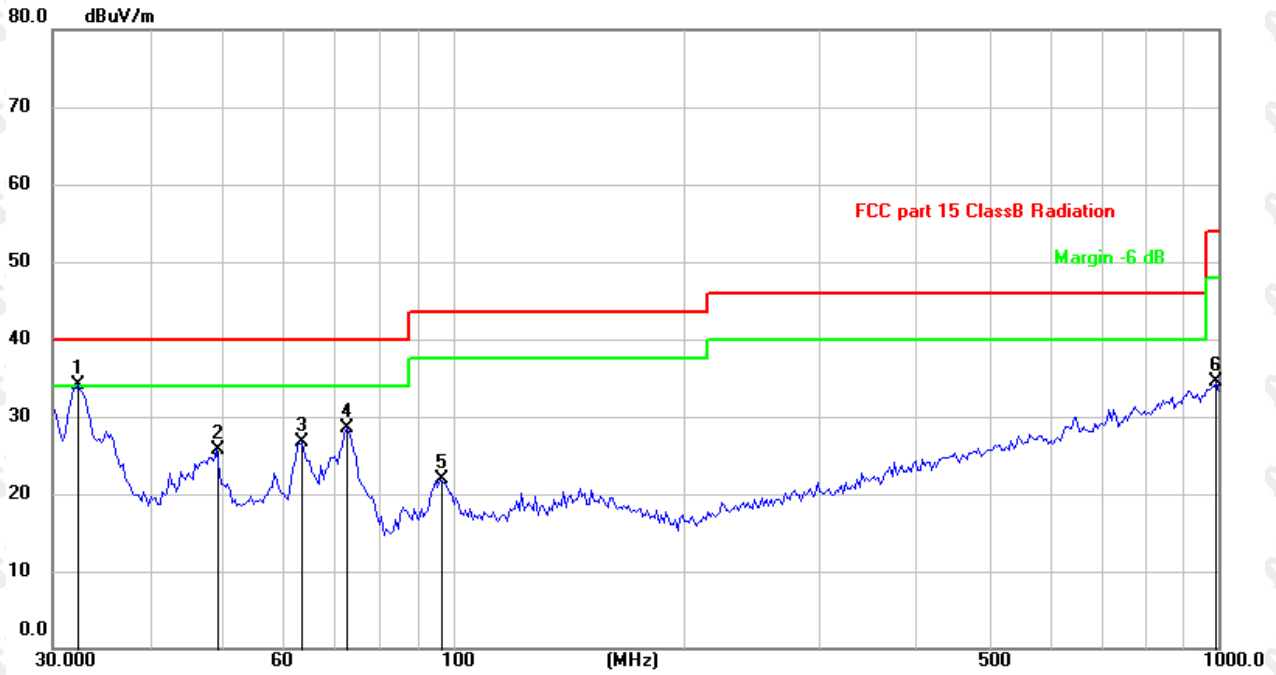

No.	Mk.	Freq. MHz	Reading Level dBuV	Correct Factor dB	Measure- ment dBuV/m	Limit dB/m	Margin dB	Detector
1	*	32.4059	41.38	-7.18	34.20	40.00	-5.80	peak
2		49.0145	31.73	-6.05	25.68	40.00	-14.32	peak
3		63.5356	34.13	-7.45	26.68	40.00	-13.32	peak
4		72.5916	37.60	-9.16	28.44	40.00	-11.56	peak
5		96.0986	31.64	-9.72	21.92	43.50	-21.58	peak
6		993.0114	26.51	8.03	34.54	54.00	-19.46	peak

Remark: Factor = Cable lose + Antenna factor - Pre-amplifier; Margin = Measurement - Limit

Above 1 GHz Test Results:

 CH Low (2402MHz)
 Horizontal:

Frequency (MHz)	Reading Result (dB μ V)	Factor (dB)	Emission Level (dB μ V/m)	Limits (dB μ V/m)	Margin (dB)	Detector Type
4804	59.31	-3.65	55.66	74.00	-18.34	peak
4804	50.61	-3.65	46.96	54.00	-7.04	AVG
7206	59.72	-0.95	58.77	74.00	-15.23	peak
7206	40.08	-0.95	39.13	54.00	-14.87	AVG

Remark: Factor = Antenna Factor + Cable Loss – Pre-amplifier. Emission level = Reading Result + Factor, Margin = Emission level - Limits

Vertical:

Frequency (MHz)	Reading Result (dB μ V)	Factor (dB)	Emission Level (dB μ V/m)	Limits (dB μ V/m)	Margin (dB)	Detector Type
4804	57.19	-3.65	53.54	74.00	-20.46	peak
4804	49.78	-3.65	46.13	54.00	-7.87	AVG
7206	59.49	-0.95	58.54	74.00	-15.46	peak
7206	42.01	-0.95	41.06	54.00	-12.94	AVG

Remark: Factor = Antenna Factor + Cable Loss – Pre-amplifier. Emission level = Reading Result + Factor, Margin = Emission level - Limits

CH Middle (2441MHz)
Horizontal:

Frequency	Reading Result	Factor	Emission Level	Limits	Margin	Detector Type
(MHz)	(dB μ V)	(dB)	(dB μ V/m)	(dB μ V/m)	(dB)	
4882.00	59.44	-3.54	55.90	74.00	-18.10	peak
4882.00	47.34	-3.54	43.80	54.00	-10.20	AVG
7323.00	58.22	-0.81	57.41	74.00	-16.59	peak
7323.00	44.25	-0.81	43.44	54.00	-10.56	AVG

Remark: Factor = Antenna Factor + Cable Loss – Pre-amplifier. Emission level = Reading Result + Factor, Margin = Emission level - Limits

Vertical:

Frequency	Reading Result	Factor	Emission Level	Limits	Margin	Detector Type
(MHz)	(dB μ V)	(dB)	(dB μ V/m)	(dB μ V/m)	(dB)	
4882.00	58.53	-3.54	54.99	74.00	-19.01	peak
4882.00	49.51	-3.54	45.97	54.00	-8.03	AVG
7323.00	58.37	-0.81	57.56	74.00	-16.44	peak
7323.00	42.58	-0.81	41.77	54.00	-12.23	AVG

Remark: Factor = Antenna Factor + Cable Loss – Pre-amplifier. Emission level = Reading Result + Factor, Margin = Emission level - Limits

CH High (2480MHz)
 Horizontal:

Frequency	Reading Result	Factor	Emission Level	Limits	Margin	Detector Type
(MHz)	(dBμV)	(dB)	(dBμV/m)	(dBμV/m)	(dB)	
4960	57.99	-3.43	54.56	74.00	-19.44	peak
4960	48.58	-3.44	45.14	54.00	-8.86	AVG
7440	61.19	-0.77	60.42	74.00	-13.58	peak
7440	42.48	-0.77	41.71	54.00	-12.29	AVG

Remark: Factor = Antenna Factor + Cable Loss – Pre-amplifier. Emission level = Reading Result + Factor, Margin = Emission level - Limits

Vertical:

Frequency	Reading Result	Factor	Emission Level	Limits	Margin	Detector Type
(MHz)	(dBμV)	(dB)	(dBμV/m)	(dBμV/m)	(dB)	
4960	58.85	-3.43	55.42	74.00	-18.58	peak
4960	49.44	-3.44	46.00	54.00	-8.00	AVG
7440	59.03	-0.77	58.26	74.00	-15.74	peak
7440	42.41	-0.77	41.64	54.00	-12.36	AVG

Remark: Factor = Antenna Factor + Cable Loss – Pre-amplifier. Emission level = Reading Result + Factor, Margin = Emission level - Limits

Remark:

- (1) Measuring frequencies from 1 GHz to the 25 GHz.
- (2) All modes of GFSK, $\pi/4$ DQPSK, 8DPSK were test at Low, Middle, and High channel, only the worst result of GFSK DH5 Low Channel was reported for below 1GHz test.
- (3) For BT above 1GHz test all modes of GFSK, $\pi/4$ DQPSK, 8DPSK were test at Low, Middle, and High channel, only the worst result of GFSK DH5 was reported.
- (4) By preliminary testing and verifying three axis (X, Y and Z) position of EUT transmitted status, it was found that "Z axis" position was the worst, and test data recorded in this report.
- (5) Radiated emission test from 9kHz to 10th harmonic of fundamental was verified, and no emission found except system noise floor in 9kHz to 30MHz and not recorded in this report.

Restricted bands around fundamental frequency (Radiated)

hopping
 Operation Mode: TX CH Low (2402MHz)
 Horizontal (Worst case)

Frequency (MHz)	Meter Reading (dBμV)	Factor (dB)	Emission Level (dBμV/m)	Limits (dBμV/m)	Margin (dB)	Detector Type
2310.00	57.71	-5.81	51.90	74.00	-22.10	peak
2310.00	/	-5.81	/	54.00	/	AVG
2390.00	56.44	-5.84	50.60	74.00	-23.40	peak
2390.00	/	-5.84	/	54.00	/	AVG

Remark: Factor = Antenna Factor + Cable Loss – Pre-amplifier.

Vertical:

Frequency (MHz)	Meter Reading (dBμV)	Factor (dB)	Emission Level (dBμV/m)	Limits (dBμV/m)	Margin (dB)	Detector Type
2310.00	56.88	-5.81	51.07	74.00	-22.93	peak
2310.00	/	-5.81	/	54.00	/	AVG
2390.00	55.29	-5.84	49.45	74.00	-24.55	peak
2390.00	/	-5.84	/	54.00	/	AVG

Remark: Factor = Antenna Factor + Cable Loss – Pre-amplifier.

Operation Mode: TX CH High (2480MHz)
Horizontal (Worst case)

Frequency (MHz)	Meter Reading (dB μ V)	Factor (dB)	Emission Level (dB μ V/m)	Limits (dB μ V/m)	Margin (dB)	Detector Type
2483.50	54.02	-5.81	48.21	74.00	-25.79	peak
2483.50	/	-5.81	/	54.00	/	AVG
2500.00	53.70	-6.06	47.64	74.00	-26.36	peak
2500.00	/	-6.06	/	54.00	/	AVG

Remark: Factor = Antenna Factor + Cable Loss – Pre-amplifier.

Vertical:

Frequency (MHz)	Meter Reading (dB μ V)	Factor (dB)	Emission Level (dB μ V/m)	Limits (dB μ V/m)	Margin (dB)	Detector Type
2483.50	56.13	-5.81	50.32	74.00	-23.68	peak
2483.50	/	-5.81	/	54.00	/	AVG
2500.00	54.39	-6.06	48.33	74.00	-25.67	peak
2500.00	/	-6.06	/	54.00	/	AVG

Remark: Factor = Antenna Factor + Cable Loss – Pre-amplifier.

Remark: All the other emissions not reported were too low to read and deemed to comply with FCC limit.

NO hopping

Operation Mode: TX CH Low (2402MHz)
Horizontal (Worst case)

Frequency (MHz)	Meter Reading (dB μ V)	Factor (dB)	Emission Level (dB μ V/m)	Limits (dB μ V/m)	Margin (dB)	Detector Type
2310.00	55.28	-5.81	49.47	74.00	-24.53	peak
2310.00	/	-5.81	/	54.00	/	AVG
2390.00	55.35	-5.84	49.51	74.00	-24.49	peak
2390.00	/	-5.84	/	54.00	/	AVG

Remark: Factor = Antenna Factor + Cable Loss – Pre-amplifier.

Vertical:

Frequency (MHz)	Meter Reading (dB μ V)	Factor (dB)	Emission Level (dB μ V/m)	Limits (dB μ V/m)	Margin (dB)	Detector Type
2310.00	54.80	-5.81	48.99	74.00	-25.01	peak
2310.00	/	-5.81	/	54.00	/	AVG
2390.00	55.64	-5.84	49.80	74.00	-24.20	peak
2390.00	/	-5.84	/	54.00	/	AVG

Remark: Factor = Antenna Factor + Cable Loss – Pre-amplifier.

Operation Mode: TX CH High (2480MHz)
Horizontal (Worst case)

Frequency (MHz)	Meter Reading (dB μ V)	Factor (dB)	Emission Level (dB μ V/m)	Limits (dB μ V/m)	Margin (dB)	Detector Type
2483.50	55.69	-5.81	49.88	74.00	-24.12	peak
2483.50	/	-5.81	/	54.00	/	AVG
2500.00	56.72	-6.06	50.66	74.00	-23.34	peak
2500.00	/	-6.06	/	54.00	/	AVG

Remark: Factor = Antenna Factor + Cable Loss – Pre-amplifier.

Vertical:

Frequency (MHz)	Meter Reading (dB μ V)	Factor (dB)	Emission Level (dB μ V/m)	Limits (dB μ V/m)	Margin (dB)	Detector Type
2483.50	56.64	-5.81	50.83	74.00	-23.17	peak
2483.50	/	-5.81	/	54.00	/	AVG
2500.00	55.01	-6.06	48.95	74.00	-25.05	peak
2500.00	/	-6.06	/	54.00	/	AVG

Remark: Factor = Antenna Factor + Cable Loss – Pre-amplifier.

Remark: All the other emissions not reported were too low to read and deemed to comply with FCC limit.

8. BAND EDGE AND RF CONDUCTED SPURIOUS EMISSIONS

8.1 Block Diagram Of Test Setup

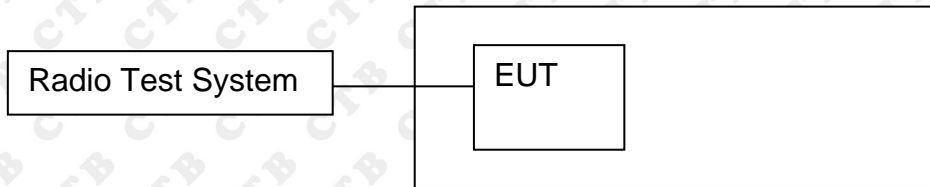

8.2 Limit

In any 100 kHz bandwidth outside the frequency band in which the spread spectrum or digitally modulated intentional radiator is operating, the radio frequency power that is produced by the intentional radiator shall be at least 20 dB below that in the 100 kHz bandwidth within the band that contains the highest level of the desired power, based on either an RF conducted or a radiated measurement, provided the transmitter demonstrates compliance with the peak conducted power limits. If the transmitter complies with the conducted power limits based on the use of RMS averaging over a time interval, as permitted under paragraph (b)(3) of this section, the attenuation required under this paragraph shall be 30 dB instead of 20 dB. Attenuation below the general limits specified in §15.209(a) is not required. In addition, radiated emissions which fall in the restricted bands, as defined in §15.205(a), must also comply with the radiated emission limits specified in §15.209(a) (see §15.205(c)).

8.3 Test procedure

1. Remove the antenna from the EUT and then connect a low RF cable from the antenna port to the spectrum;
2. Set the spectrum analyzer:
Below 30MHz:
RBW = 100kHz, VBW = 300kHz, Sweep = auto
Detector function = peak, Trace = max hold
Above 30MHz:
RBW = 100KHz, VBW = 300KHz, Sweep = auto
Detector function = peak, Trace = max hold

8.4 Test Result

BAND EDGE Graphs																																														
GFSK/LCH/ No Hop	<p>Agilent Spectrum Analyzer - Sweep SA Center Freq 2.35600000 GHz Ref Offset 6.76 dB Ref 26.76 dBm Mkr1 2.4019 GHz 1.512 dBm Start 2.30600 GHz #Res BW 100 kHz #VBW 300 kHz Stop 2.40600 GHz Sweep 9.600 ms (1001 pts)</p> <table border="1"> <thead> <tr> <th>MKR</th> <th>MODE</th> <th>TRIG</th> <th>SCAL</th> <th>F</th> <th>P</th> <th>FUNCTION</th> <th>FUNCTION WIDTH</th> <th>FUNCTION VALUE</th> </tr> </thead> <tbody> <tr> <td>1</td> <td>N</td> <td>1</td> <td>f</td> <td>2.4019 GHz</td> <td>1.512 dBm</td> <td></td> <td></td> <td></td> </tr> <tr> <td>2</td> <td>N</td> <td>1</td> <td>f</td> <td>2.4000 GHz</td> <td>-51.843 dBm</td> <td></td> <td></td> <td></td> </tr> <tr> <td>3</td> <td>N</td> <td>1</td> <td>f</td> <td>2.3900 GHz</td> <td>-55.519 dBm</td> <td></td> <td></td> <td></td> </tr> <tr> <td>4</td> <td>N</td> <td>1</td> <td>f</td> <td>2.3780 GHz</td> <td>-49.646 dBm</td> <td></td> <td></td> <td></td> </tr> </tbody> </table>	MKR	MODE	TRIG	SCAL	F	P	FUNCTION	FUNCTION WIDTH	FUNCTION VALUE	1	N	1	f	2.4019 GHz	1.512 dBm				2	N	1	f	2.4000 GHz	-51.843 dBm				3	N	1	f	2.3900 GHz	-55.519 dBm				4	N	1	f	2.3780 GHz	-49.646 dBm			
MKR	MODE	TRIG	SCAL	F	P	FUNCTION	FUNCTION WIDTH	FUNCTION VALUE																																						
1	N	1	f	2.4019 GHz	1.512 dBm																																									
2	N	1	f	2.4000 GHz	-51.843 dBm																																									
3	N	1	f	2.3900 GHz	-55.519 dBm																																									
4	N	1	f	2.3780 GHz	-49.646 dBm																																									
GFSK/LCH/ Hop	<p>Agilent Spectrum Analyzer - Sweep SA Center Freq 2.35600000 GHz Ref Offset 6.76 dB Ref 26.76 dBm Mkr1 2.4031 GHz 3.570 dBm Start 2.30600 GHz #Res BW 100 kHz #VBW 300 kHz Stop 2.40600 GHz Sweep 9.600 ms (1001 pts)</p> <table border="1"> <thead> <tr> <th>MKR</th> <th>MODE</th> <th>TRIG</th> <th>SCAL</th> <th>F</th> <th>P</th> <th>FUNCTION</th> <th>FUNCTION WIDTH</th> <th>FUNCTION VALUE</th> </tr> </thead> <tbody> <tr> <td>1</td> <td>N</td> <td>1</td> <td>f</td> <td>2.4031 GHz</td> <td>3.570 dBm</td> <td></td> <td></td> <td></td> </tr> <tr> <td>2</td> <td>N</td> <td>1</td> <td>f</td> <td>2.4000 GHz</td> <td>-54.068 dBm</td> <td></td> <td></td> <td></td> </tr> <tr> <td>3</td> <td>N</td> <td>1</td> <td>f</td> <td>2.3900 GHz</td> <td>-53.046 dBm</td> <td></td> <td></td> <td></td> </tr> <tr> <td>4</td> <td>N</td> <td>1</td> <td>f</td> <td>2.3811 GHz</td> <td>-51.000 dBm</td> <td></td> <td></td> <td></td> </tr> </tbody> </table>	MKR	MODE	TRIG	SCAL	F	P	FUNCTION	FUNCTION WIDTH	FUNCTION VALUE	1	N	1	f	2.4031 GHz	3.570 dBm				2	N	1	f	2.4000 GHz	-54.068 dBm				3	N	1	f	2.3900 GHz	-53.046 dBm				4	N	1	f	2.3811 GHz	-51.000 dBm			
MKR	MODE	TRIG	SCAL	F	P	FUNCTION	FUNCTION WIDTH	FUNCTION VALUE																																						
1	N	1	f	2.4031 GHz	3.570 dBm																																									
2	N	1	f	2.4000 GHz	-54.068 dBm																																									
3	N	1	f	2.3900 GHz	-53.046 dBm																																									
4	N	1	f	2.3811 GHz	-51.000 dBm																																									
GFSK/HCH/ No Hop	<p>Agilent Spectrum Analyzer - Sweep SA Center Freq 2.52600000 GHz Ref Offset 6.9 dB Ref 26.80 dBm Mkr1 2.4799 GHz -1.327 dBm Start 2.47600 GHz #Res BW 100 kHz #VBW 300 kHz Stop 2.57600 GHz Sweep 9.600 ms (1001 pts)</p> <table border="1"> <thead> <tr> <th>MKR</th> <th>MODE</th> <th>TRIG</th> <th>SCAL</th> <th>F</th> <th>P</th> <th>FUNCTION</th> <th>FUNCTION WIDTH</th> <th>FUNCTION VALUE</th> </tr> </thead> <tbody> <tr> <td>1</td> <td>N</td> <td>1</td> <td>f</td> <td>2.4799 GHz</td> <td>-1.327 dBm</td> <td></td> <td></td> <td></td> </tr> <tr> <td>2</td> <td>N</td> <td>1</td> <td>f</td> <td>2.4835 GHz</td> <td>-54.893 dBm</td> <td></td> <td></td> <td></td> </tr> <tr> <td>3</td> <td>N</td> <td>1</td> <td>f</td> <td>2.5000 GHz</td> <td>-54.132 dBm</td> <td></td> <td></td> <td></td> </tr> <tr> <td>4</td> <td>N</td> <td>1</td> <td>f</td> <td>2.4866 GHz</td> <td>-52.101 dBm</td> <td></td> <td></td> <td></td> </tr> </tbody> </table>	MKR	MODE	TRIG	SCAL	F	P	FUNCTION	FUNCTION WIDTH	FUNCTION VALUE	1	N	1	f	2.4799 GHz	-1.327 dBm				2	N	1	f	2.4835 GHz	-54.893 dBm				3	N	1	f	2.5000 GHz	-54.132 dBm				4	N	1	f	2.4866 GHz	-52.101 dBm			
MKR	MODE	TRIG	SCAL	F	P	FUNCTION	FUNCTION WIDTH	FUNCTION VALUE																																						
1	N	1	f	2.4799 GHz	-1.327 dBm																																									
2	N	1	f	2.4835 GHz	-54.893 dBm																																									
3	N	1	f	2.5000 GHz	-54.132 dBm																																									
4	N	1	f	2.4866 GHz	-52.101 dBm																																									

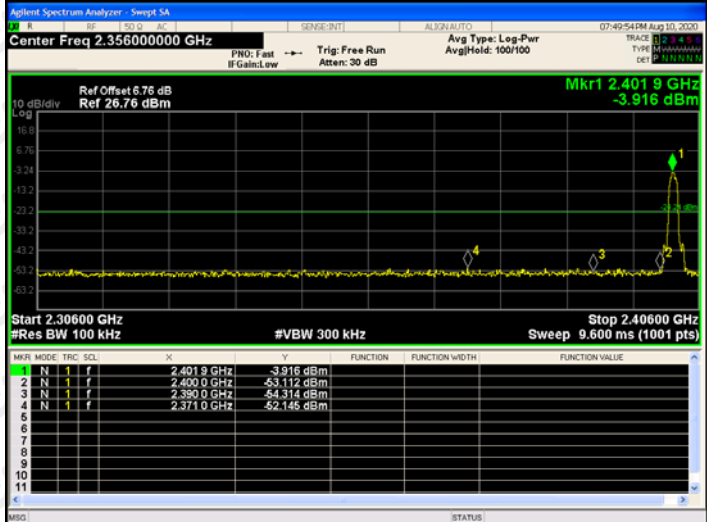
<p>GFSK/HCH/ Hop</p>	 <table border="1" data-bbox="576 577 1286 734"> <thead> <tr> <th>MKR</th> <th>MODE</th> <th>TRIG</th> <th>SCL</th> <th>X</th> <th>Y</th> <th>FUNCTION</th> <th>FUNCTION WIDTH</th> <th>FUNCTION VALUE</th> </tr> </thead> <tbody> <tr> <td>1</td> <td>N</td> <td>1</td> <td>f</td> <td>2.478 2 GHz</td> <td>-3.363 dBm</td> <td></td> <td></td> <td></td> </tr> <tr> <td>2</td> <td>N</td> <td>1</td> <td>f</td> <td>2.483 5 GHz</td> <td>-54.263 dBm</td> <td></td> <td></td> <td></td> </tr> <tr> <td>3</td> <td>N</td> <td>1</td> <td>f</td> <td>2.500 0 GHz</td> <td>-54.271 dBm</td> <td></td> <td></td> <td></td> </tr> <tr> <td>4</td> <td>N</td> <td>1</td> <td>f</td> <td>2.499 1 GHz</td> <td>-51.946 dBm</td> <td></td> <td></td> <td></td> </tr> </tbody> </table>	MKR	MODE	TRIG	SCL	X	Y	FUNCTION	FUNCTION WIDTH	FUNCTION VALUE	1	N	1	f	2.478 2 GHz	-3.363 dBm				2	N	1	f	2.483 5 GHz	-54.263 dBm				3	N	1	f	2.500 0 GHz	-54.271 dBm				4	N	1	f	2.499 1 GHz	-51.946 dBm			
MKR	MODE	TRIG	SCL	X	Y	FUNCTION	FUNCTION WIDTH	FUNCTION VALUE																																						
1	N	1	f	2.478 2 GHz	-3.363 dBm																																									
2	N	1	f	2.483 5 GHz	-54.263 dBm																																									
3	N	1	f	2.500 0 GHz	-54.271 dBm																																									
4	N	1	f	2.499 1 GHz	-51.946 dBm																																									
<p>$\pi/4$DQPSK/LCH/ No Hop</p>	 <table border="1" data-bbox="576 1102 1286 1258"> <thead> <tr> <th>MKR</th> <th>MODE</th> <th>TRIG</th> <th>SCL</th> <th>X</th> <th>Y</th> <th>FUNCTION</th> <th>FUNCTION WIDTH</th> <th>FUNCTION VALUE</th> </tr> </thead> <tbody> <tr> <td>1</td> <td>N</td> <td>1</td> <td>f</td> <td>2.401 9 GHz</td> <td>-3.916 dBm</td> <td></td> <td></td> <td></td> </tr> <tr> <td>2</td> <td>N</td> <td>1</td> <td>f</td> <td>2.400 0 GHz</td> <td>-53.112 dBm</td> <td></td> <td></td> <td></td> </tr> <tr> <td>3</td> <td>N</td> <td>1</td> <td>f</td> <td>2.390 0 GHz</td> <td>-54.314 dBm</td> <td></td> <td></td> <td></td> </tr> <tr> <td>4</td> <td>N</td> <td>1</td> <td>f</td> <td>2.371 0 GHz</td> <td>-52.145 dBm</td> <td></td> <td></td> <td></td> </tr> </tbody> </table>	MKR	MODE	TRIG	SCL	X	Y	FUNCTION	FUNCTION WIDTH	FUNCTION VALUE	1	N	1	f	2.401 9 GHz	-3.916 dBm				2	N	1	f	2.400 0 GHz	-53.112 dBm				3	N	1	f	2.390 0 GHz	-54.314 dBm				4	N	1	f	2.371 0 GHz	-52.145 dBm			
MKR	MODE	TRIG	SCL	X	Y	FUNCTION	FUNCTION WIDTH	FUNCTION VALUE																																						
1	N	1	f	2.401 9 GHz	-3.916 dBm																																									
2	N	1	f	2.400 0 GHz	-53.112 dBm																																									
3	N	1	f	2.390 0 GHz	-54.314 dBm																																									
4	N	1	f	2.371 0 GHz	-52.145 dBm																																									
<p>$\pi/4$DQPSK/LCH/ Hop</p>	 <table border="1" data-bbox="576 1630 1286 1787"> <thead> <tr> <th>MKR</th> <th>MODE</th> <th>TRIG</th> <th>SCL</th> <th>X</th> <th>Y</th> <th>FUNCTION</th> <th>FUNCTION WIDTH</th> <th>FUNCTION VALUE</th> </tr> </thead> <tbody> <tr> <td>1</td> <td>N</td> <td>1</td> <td>f</td> <td>2.402 9 GHz</td> <td>1.437 dBm</td> <td></td> <td></td> <td></td> </tr> <tr> <td>2</td> <td>N</td> <td>1</td> <td>f</td> <td>2.400 0 GHz</td> <td>-52.199 dBm</td> <td></td> <td></td> <td></td> </tr> <tr> <td>3</td> <td>N</td> <td>1</td> <td>f</td> <td>2.390 0 GHz</td> <td>-54.333 dBm</td> <td></td> <td></td> <td></td> </tr> <tr> <td>4</td> <td>N</td> <td>1</td> <td>f</td> <td>2.329 5 GHz</td> <td>-51.636 dBm</td> <td></td> <td></td> <td></td> </tr> </tbody> </table>	MKR	MODE	TRIG	SCL	X	Y	FUNCTION	FUNCTION WIDTH	FUNCTION VALUE	1	N	1	f	2.402 9 GHz	1.437 dBm				2	N	1	f	2.400 0 GHz	-52.199 dBm				3	N	1	f	2.390 0 GHz	-54.333 dBm				4	N	1	f	2.329 5 GHz	-51.636 dBm			
MKR	MODE	TRIG	SCL	X	Y	FUNCTION	FUNCTION WIDTH	FUNCTION VALUE																																						
1	N	1	f	2.402 9 GHz	1.437 dBm																																									
2	N	1	f	2.400 0 GHz	-52.199 dBm																																									
3	N	1	f	2.390 0 GHz	-54.333 dBm																																									
4	N	1	f	2.329 5 GHz	-51.636 dBm																																									

<p>$\pi/4$DQPSK/HCH/ No Hop</p>	<p>Agilent Spectrum Analyzer - Swept SA Center Freq 2.526000000 GHz Ref Offset 6.8 dB Ref 26.80 dBm Mkr1 2.480 1 GHz -5.648 dBm Start 2.47600 GHz #Res BW 100 kHz #VBW 300 kHz Sweep 9.600 ms (1001 pts)</p> <table border="1"> <thead> <tr> <th>MKR</th> <th>MODE</th> <th>TRC</th> <th>SCL</th> <th>X</th> <th>Y</th> <th>FUNCTION</th> <th>FUNCTION WIDTH</th> <th>FUNCTION VALUE</th> </tr> </thead> <tbody> <tr> <td>1</td> <td>N</td> <td>1</td> <td>f</td> <td>2.480 1 GHz</td> <td>-5.648 dBm</td> <td></td> <td></td> <td></td> </tr> <tr> <td>2</td> <td>N</td> <td>1</td> <td>f</td> <td>2.483 5 GHz</td> <td>-54.096 dBm</td> <td></td> <td></td> <td></td> </tr> <tr> <td>3</td> <td>N</td> <td>1</td> <td>f</td> <td>2.500 0 GHz</td> <td>-54.138 dBm</td> <td></td> <td></td> <td></td> </tr> <tr> <td>4</td> <td>N</td> <td>1</td> <td>f</td> <td>2.492 6 GHz</td> <td>-52.507 dBm</td> <td></td> <td></td> <td></td> </tr> </tbody> </table>	MKR	MODE	TRC	SCL	X	Y	FUNCTION	FUNCTION WIDTH	FUNCTION VALUE	1	N	1	f	2.480 1 GHz	-5.648 dBm				2	N	1	f	2.483 5 GHz	-54.096 dBm				3	N	1	f	2.500 0 GHz	-54.138 dBm				4	N	1	f	2.492 6 GHz	-52.507 dBm			
MKR	MODE	TRC	SCL	X	Y	FUNCTION	FUNCTION WIDTH	FUNCTION VALUE																																						
1	N	1	f	2.480 1 GHz	-5.648 dBm																																									
2	N	1	f	2.483 5 GHz	-54.096 dBm																																									
3	N	1	f	2.500 0 GHz	-54.138 dBm																																									
4	N	1	f	2.492 6 GHz	-52.507 dBm																																									
<p>$\pi/4$DQPSK/HCH/ Hop</p>	<p>Agilent Spectrum Analyzer - Swept SA Center Freq 2.526000000 GHz Ref Offset 6.8 dB Ref 26.80 dBm Mkr1 2.479 9 GHz 2.649 dBm Start 2.47600 GHz #Res BW 100 kHz #VBW 300 kHz Sweep 9.600 ms (1001 pts)</p> <table border="1"> <thead> <tr> <th>MKR</th> <th>MODE</th> <th>TRC</th> <th>SCL</th> <th>X</th> <th>Y</th> <th>FUNCTION</th> <th>FUNCTION WIDTH</th> <th>FUNCTION VALUE</th> </tr> </thead> <tbody> <tr> <td>1</td> <td>N</td> <td>1</td> <td>f</td> <td>2.479 9 GHz</td> <td>2.649 dBm</td> <td></td> <td></td> <td></td> </tr> <tr> <td>2</td> <td>N</td> <td>1</td> <td>f</td> <td>2.463 5 GHz</td> <td>-52.266 dBm</td> <td></td> <td></td> <td></td> </tr> <tr> <td>3</td> <td>N</td> <td>1</td> <td>f</td> <td>2.500 0 GHz</td> <td>-52.769 dBm</td> <td></td> <td></td> <td></td> </tr> <tr> <td>4</td> <td>N</td> <td>1</td> <td>f</td> <td>2.498 6 GHz</td> <td>-51.797 dBm</td> <td></td> <td></td> <td></td> </tr> </tbody> </table>	MKR	MODE	TRC	SCL	X	Y	FUNCTION	FUNCTION WIDTH	FUNCTION VALUE	1	N	1	f	2.479 9 GHz	2.649 dBm				2	N	1	f	2.463 5 GHz	-52.266 dBm				3	N	1	f	2.500 0 GHz	-52.769 dBm				4	N	1	f	2.498 6 GHz	-51.797 dBm			
MKR	MODE	TRC	SCL	X	Y	FUNCTION	FUNCTION WIDTH	FUNCTION VALUE																																						
1	N	1	f	2.479 9 GHz	2.649 dBm																																									
2	N	1	f	2.463 5 GHz	-52.266 dBm																																									
3	N	1	f	2.500 0 GHz	-52.769 dBm																																									
4	N	1	f	2.498 6 GHz	-51.797 dBm																																									
<p>8DPSK/LCH/ No Hop</p>	<p>Agilent Spectrum Analyzer - Swept SA Center Freq 2.356000000 GHz Ref Offset 6.76 dB Ref 26.76 dBm Mkr1 2.402 1 GHz -3.199 dBm Start 2.30600 GHz #Res BW 100 kHz #VBW 300 kHz Sweep 9.600 ms (1001 pts)</p> <table border="1"> <thead> <tr> <th>MKR</th> <th>MODE</th> <th>TRC</th> <th>SCL</th> <th>X</th> <th>Y</th> <th>FUNCTION</th> <th>FUNCTION WIDTH</th> <th>FUNCTION VALUE</th> </tr> </thead> <tbody> <tr> <td>1</td> <td>N</td> <td>1</td> <td>f</td> <td>2.402 1 GHz</td> <td>-3.199 dBm</td> <td></td> <td></td> <td></td> </tr> <tr> <td>2</td> <td>N</td> <td>1</td> <td>f</td> <td>2.400 0 GHz</td> <td>-52.390 dBm</td> <td></td> <td></td> <td></td> </tr> <tr> <td>3</td> <td>N</td> <td>1</td> <td>f</td> <td>2.390 0 GHz</td> <td>-54.428 dBm</td> <td></td> <td></td> <td></td> </tr> <tr> <td>4</td> <td>N</td> <td>1</td> <td>f</td> <td>2.388 3 GHz</td> <td>-50.468 dBm</td> <td></td> <td></td> <td></td> </tr> </tbody> </table>	MKR	MODE	TRC	SCL	X	Y	FUNCTION	FUNCTION WIDTH	FUNCTION VALUE	1	N	1	f	2.402 1 GHz	-3.199 dBm				2	N	1	f	2.400 0 GHz	-52.390 dBm				3	N	1	f	2.390 0 GHz	-54.428 dBm				4	N	1	f	2.388 3 GHz	-50.468 dBm			
MKR	MODE	TRC	SCL	X	Y	FUNCTION	FUNCTION WIDTH	FUNCTION VALUE																																						
1	N	1	f	2.402 1 GHz	-3.199 dBm																																									
2	N	1	f	2.400 0 GHz	-52.390 dBm																																									
3	N	1	f	2.390 0 GHz	-54.428 dBm																																									
4	N	1	f	2.388 3 GHz	-50.468 dBm																																									

<p>8DPSK /LCH/ Hop</p>	<table border="1"> <thead> <tr> <th>MKR</th> <th>MODE</th> <th>TRIG</th> <th>SCL</th> <th>X</th> <th>Y</th> <th>FUNCTION</th> <th>FUNCTION WIDTH</th> <th>FUNCTION VALUE</th> </tr> </thead> <tbody> <tr> <td>1</td> <td>N</td> <td>1</td> <td>f</td> <td>2.4021 GHz</td> <td>2.723 dBm</td> <td></td> <td></td> <td></td> </tr> <tr> <td>2</td> <td>N</td> <td>1</td> <td>f</td> <td>2.4003 GHz</td> <td>-51.567 dBm</td> <td></td> <td></td> <td></td> </tr> <tr> <td>3</td> <td>N</td> <td>1</td> <td>f</td> <td>2.3900 GHz</td> <td>-53.710 dBm</td> <td></td> <td></td> <td></td> </tr> <tr> <td>4</td> <td>N</td> <td>1</td> <td>f</td> <td>2.3335 GHz</td> <td>-50.799 dBm</td> <td></td> <td></td> <td></td> </tr> </tbody> </table>	MKR	MODE	TRIG	SCL	X	Y	FUNCTION	FUNCTION WIDTH	FUNCTION VALUE	1	N	1	f	2.4021 GHz	2.723 dBm				2	N	1	f	2.4003 GHz	-51.567 dBm				3	N	1	f	2.3900 GHz	-53.710 dBm				4	N	1	f	2.3335 GHz	-50.799 dBm				
MKR	MODE	TRIG	SCL	X	Y	FUNCTION	FUNCTION WIDTH	FUNCTION VALUE																																							
1	N	1	f	2.4021 GHz	2.723 dBm																																										
2	N	1	f	2.4003 GHz	-51.567 dBm																																										
3	N	1	f	2.3900 GHz	-53.710 dBm																																										
4	N	1	f	2.3335 GHz	-50.799 dBm																																										
<p>8DPSK /HCH/ No Hop</p>	<table border="1"> <thead> <tr> <th>MKR</th> <th>MODE</th> <th>TRIG</th> <th>SCL</th> <th>X</th> <th>Y</th> <th>FUNCTION</th> <th>FUNCTION WIDTH</th> <th>FUNCTION VALUE</th> </tr> </thead> <tbody> <tr> <td>1</td> <td>N</td> <td>1</td> <td>f</td> <td>2.4801 GHz</td> <td>-5.750 dBm</td> <td></td> <td></td> <td></td> </tr> <tr> <td>2</td> <td>N</td> <td>1</td> <td>f</td> <td>2.4935 GHz</td> <td>-50.524 dBm</td> <td></td> <td></td> <td></td> </tr> <tr> <td>3</td> <td>N</td> <td>1</td> <td>f</td> <td>2.5000 GHz</td> <td>-54.188 dBm</td> <td></td> <td></td> <td></td> </tr> <tr> <td>4</td> <td>N</td> <td>1</td> <td>f</td> <td>2.4974 GHz</td> <td>-51.078 dBm</td> <td></td> <td></td> <td></td> </tr> </tbody> </table>	MKR	MODE	TRIG	SCL	X	Y	FUNCTION	FUNCTION WIDTH	FUNCTION VALUE	1	N	1	f	2.4801 GHz	-5.750 dBm				2	N	1	f	2.4935 GHz	-50.524 dBm				3	N	1	f	2.5000 GHz	-54.188 dBm				4	N	1	f	2.4974 GHz	-51.078 dBm				
MKR	MODE	TRIG	SCL	X	Y	FUNCTION	FUNCTION WIDTH	FUNCTION VALUE																																							
1	N	1	f	2.4801 GHz	-5.750 dBm																																										
2	N	1	f	2.4935 GHz	-50.524 dBm																																										
3	N	1	f	2.5000 GHz	-54.188 dBm																																										
4	N	1	f	2.4974 GHz	-51.078 dBm																																										
<p>8DPSK /HCH/ Hop</p>	<table border="1"> <thead> <tr> <th>MKR</th> <th>MODE</th> <th>TRIG</th> <th>SCL</th> <th>X</th> <th>Y</th> <th>FUNCTION</th> <th>FUNCTION WIDTH</th> <th>FUNCTION VALUE</th> </tr> </thead> <tbody> <tr> <td>1</td> <td>N</td> <td>1</td> <td>f</td> <td>2.4782 GHz</td> <td>3.162 dBm</td> <td></td> <td></td> <td></td> </tr> <tr> <td>2</td> <td>N</td> <td>1</td> <td>f</td> <td>2.4935 GHz</td> <td>-53.616 dBm</td> <td></td> <td></td> <td></td> </tr> <tr> <td>3</td> <td>N</td> <td>1</td> <td>f</td> <td>2.5000 GHz</td> <td>-53.548 dBm</td> <td></td> <td></td> <td></td> </tr> <tr> <td>4</td> <td>N</td> <td>1</td> <td>f</td> <td>2.4943 GHz</td> <td>-51.708 dBm</td> <td></td> <td></td> <td></td> </tr> </tbody> </table>	MKR	MODE	TRIG	SCL	X	Y	FUNCTION	FUNCTION WIDTH	FUNCTION VALUE	1	N	1	f	2.4782 GHz	3.162 dBm				2	N	1	f	2.4935 GHz	-53.616 dBm				3	N	1	f	2.5000 GHz	-53.548 dBm				4	N	1	f	2.4943 GHz	-51.708 dBm				
MKR	MODE	TRIG	SCL	X	Y	FUNCTION	FUNCTION WIDTH	FUNCTION VALUE																																							
1	N	1	f	2.4782 GHz	3.162 dBm																																										
2	N	1	f	2.4935 GHz	-53.616 dBm																																										
3	N	1	f	2.5000 GHz	-53.548 dBm																																										
4	N	1	f	2.4943 GHz	-51.708 dBm																																										

RF Conducted Spurious Emissions Graphs

GFSK/LCH

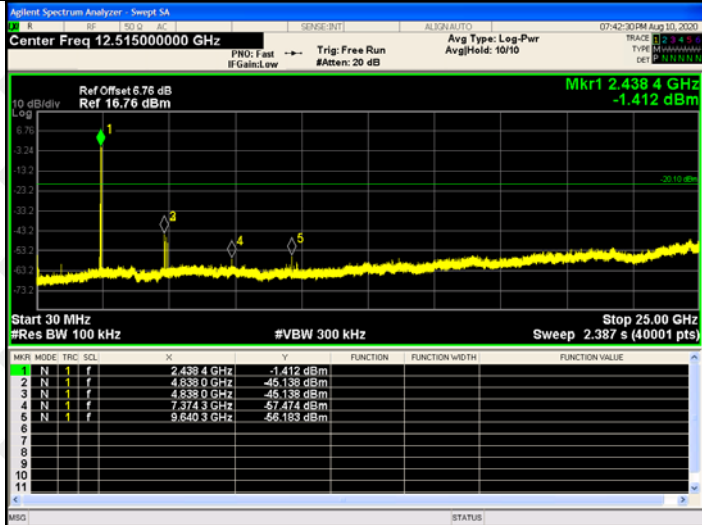

GFSK/MCH

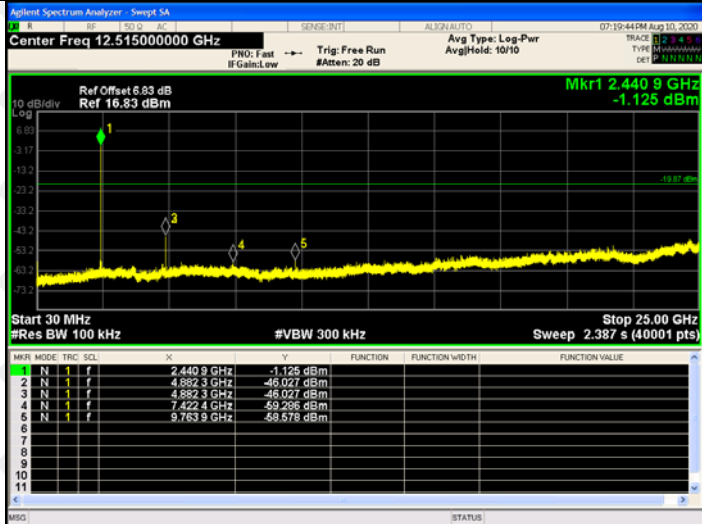

GFSK/HCH

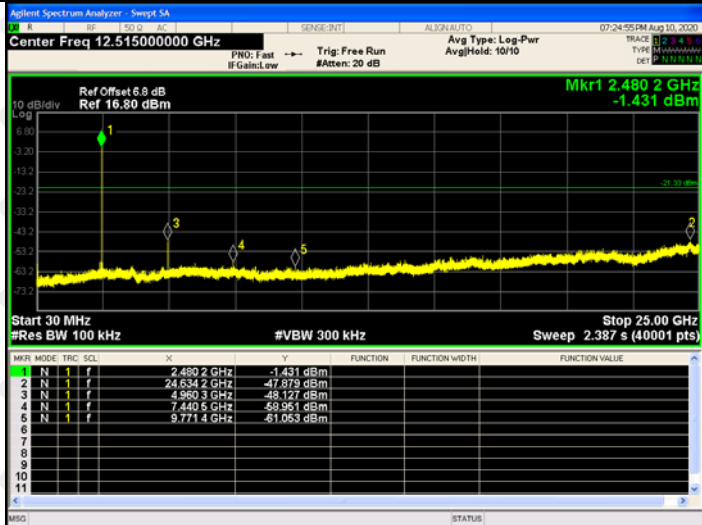

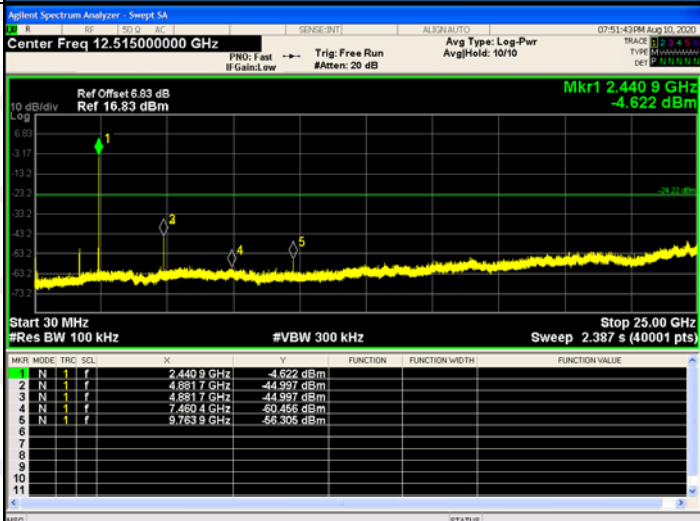
<p>$\pi/4$DQPSK /LCH</p>	 <table border="1" data-bbox="590 571 1292 728"> <thead> <tr> <th>MKR</th> <th>MODE</th> <th>TRC</th> <th>SCL</th> <th>X</th> <th>Y</th> <th>FUNCTION</th> <th>FUNCTION WIDTH</th> <th>FUNCTION VALUE</th> </tr> </thead> <tbody> <tr> <td>1</td> <td>N</td> <td>1</td> <td>f</td> <td>2.4022 GHz</td> <td>-4.158 dBm</td> <td></td> <td></td> <td></td> </tr> <tr> <td>2</td> <td>N</td> <td>1</td> <td>f</td> <td>4.8036 GHz</td> <td>-46.137 dBm</td> <td></td> <td></td> <td></td> </tr> <tr> <td>3</td> <td>N</td> <td>1</td> <td>f</td> <td>4.8036 GHz</td> <td>-46.137 dBm</td> <td></td> <td></td> <td></td> </tr> <tr> <td>4</td> <td>N</td> <td>1</td> <td>f</td> <td>7.3974 GHz</td> <td>-60.382 dBm</td> <td></td> <td></td> <td></td> </tr> <tr> <td>5</td> <td>N</td> <td>1</td> <td>f</td> <td>9.6122 GHz</td> <td>-58.102 dBm</td> <td></td> <td></td> <td></td> </tr> </tbody> </table>	MKR	MODE	TRC	SCL	X	Y	FUNCTION	FUNCTION WIDTH	FUNCTION VALUE	1	N	1	f	2.4022 GHz	-4.158 dBm				2	N	1	f	4.8036 GHz	-46.137 dBm				3	N	1	f	4.8036 GHz	-46.137 dBm				4	N	1	f	7.3974 GHz	-60.382 dBm				5	N	1	f	9.6122 GHz	-58.102 dBm				
MKR	MODE	TRC	SCL	X	Y	FUNCTION	FUNCTION WIDTH	FUNCTION VALUE																																																
1	N	1	f	2.4022 GHz	-4.158 dBm																																																			
2	N	1	f	4.8036 GHz	-46.137 dBm																																																			
3	N	1	f	4.8036 GHz	-46.137 dBm																																																			
4	N	1	f	7.3974 GHz	-60.382 dBm																																																			
5	N	1	f	9.6122 GHz	-58.102 dBm																																																			
<p>$\pi/4$DQPSK/MCH</p>	 <table border="1" data-bbox="590 1108 1292 1265"> <thead> <tr> <th>MKR</th> <th>MODE</th> <th>TRC</th> <th>SCL</th> <th>X</th> <th>Y</th> <th>FUNCTION</th> <th>FUNCTION WIDTH</th> <th>FUNCTION VALUE</th> </tr> </thead> <tbody> <tr> <td>1</td> <td>N</td> <td>1</td> <td>f</td> <td>2.4409 GHz</td> <td>-4.622 dBm</td> <td></td> <td></td> <td></td> </tr> <tr> <td>2</td> <td>N</td> <td>1</td> <td>f</td> <td>4.8817 GHz</td> <td>-44.997 dBm</td> <td></td> <td></td> <td></td> </tr> <tr> <td>3</td> <td>N</td> <td>1</td> <td>f</td> <td>4.8817 GHz</td> <td>-44.997 dBm</td> <td></td> <td></td> <td></td> </tr> <tr> <td>4</td> <td>N</td> <td>1</td> <td>f</td> <td>7.4604 GHz</td> <td>-60.486 dBm</td> <td></td> <td></td> <td></td> </tr> <tr> <td>5</td> <td>N</td> <td>1</td> <td>f</td> <td>9.7639 GHz</td> <td>-56.306 dBm</td> <td></td> <td></td> <td></td> </tr> </tbody> </table>	MKR	MODE	TRC	SCL	X	Y	FUNCTION	FUNCTION WIDTH	FUNCTION VALUE	1	N	1	f	2.4409 GHz	-4.622 dBm				2	N	1	f	4.8817 GHz	-44.997 dBm				3	N	1	f	4.8817 GHz	-44.997 dBm				4	N	1	f	7.4604 GHz	-60.486 dBm				5	N	1	f	9.7639 GHz	-56.306 dBm				
MKR	MODE	TRC	SCL	X	Y	FUNCTION	FUNCTION WIDTH	FUNCTION VALUE																																																
1	N	1	f	2.4409 GHz	-4.622 dBm																																																			
2	N	1	f	4.8817 GHz	-44.997 dBm																																																			
3	N	1	f	4.8817 GHz	-44.997 dBm																																																			
4	N	1	f	7.4604 GHz	-60.486 dBm																																																			
5	N	1	f	9.7639 GHz	-56.306 dBm																																																			
<p>$\pi/4$DQPSK/HCH</p>	 <table border="1" data-bbox="590 1635 1292 1780"> <thead> <tr> <th>MKR</th> <th>MODE</th> <th>TRC</th> <th>SCL</th> <th>X</th> <th>Y</th> <th>FUNCTION</th> <th>FUNCTION WIDTH</th> <th>FUNCTION VALUE</th> </tr> </thead> <tbody> <tr> <td>1</td> <td>N</td> <td>1</td> <td>f</td> <td>2.4802 GHz</td> <td>-9.477 dBm</td> <td></td> <td></td> <td></td> </tr> <tr> <td>2</td> <td>N</td> <td>1</td> <td>f</td> <td>1.7117 GHz</td> <td>-44.671 dBm</td> <td></td> <td></td> <td></td> </tr> <tr> <td>3</td> <td>N</td> <td>1</td> <td>f</td> <td>4.9697 GHz</td> <td>-60.092 dBm</td> <td></td> <td></td> <td></td> </tr> <tr> <td>4</td> <td>N</td> <td>1</td> <td>f</td> <td>7.3812 GHz</td> <td>-60.438 dBm</td> <td></td> <td></td> <td></td> </tr> <tr> <td>5</td> <td>N</td> <td>1</td> <td>f</td> <td>9.9200 GHz</td> <td>-57.778 dBm</td> <td></td> <td></td> <td></td> </tr> </tbody> </table>	MKR	MODE	TRC	SCL	X	Y	FUNCTION	FUNCTION WIDTH	FUNCTION VALUE	1	N	1	f	2.4802 GHz	-9.477 dBm				2	N	1	f	1.7117 GHz	-44.671 dBm				3	N	1	f	4.9697 GHz	-60.092 dBm				4	N	1	f	7.3812 GHz	-60.438 dBm				5	N	1	f	9.9200 GHz	-57.778 dBm				
MKR	MODE	TRC	SCL	X	Y	FUNCTION	FUNCTION WIDTH	FUNCTION VALUE																																																
1	N	1	f	2.4802 GHz	-9.477 dBm																																																			
2	N	1	f	1.7117 GHz	-44.671 dBm																																																			
3	N	1	f	4.9697 GHz	-60.092 dBm																																																			
4	N	1	f	7.3812 GHz	-60.438 dBm																																																			
5	N	1	f	9.9200 GHz	-57.778 dBm																																																			

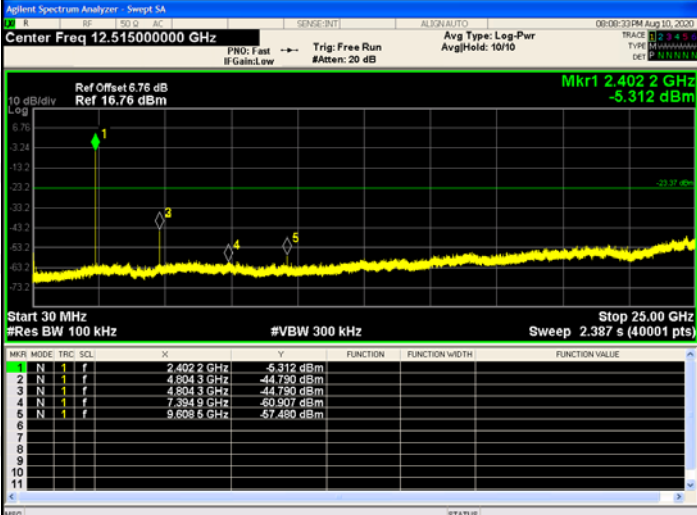
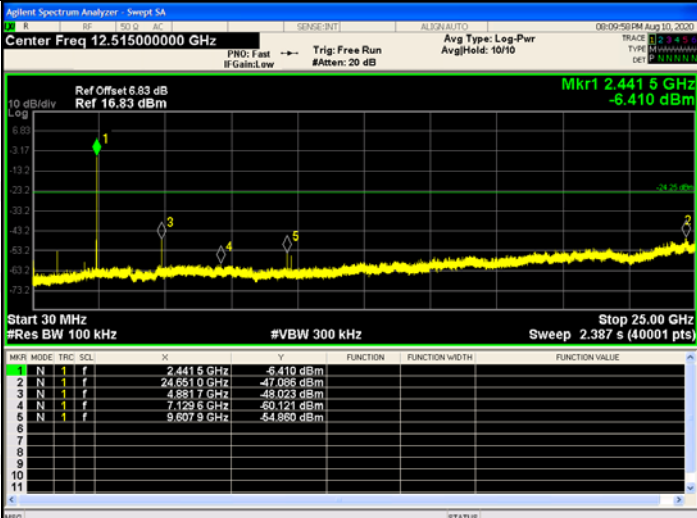
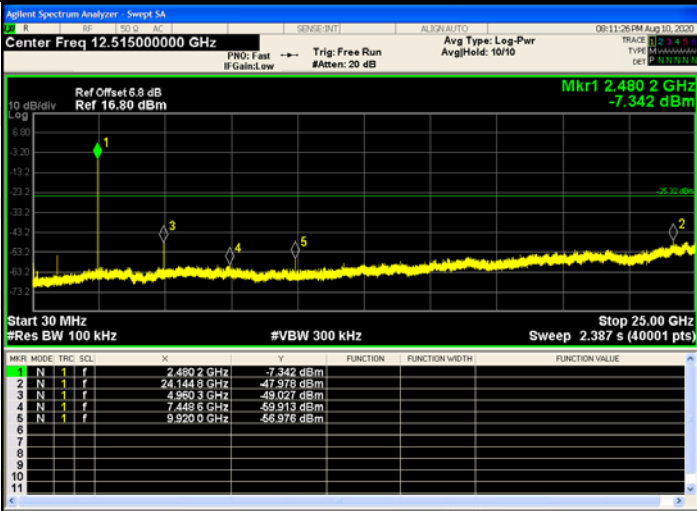
<p>8DPSK/LCH</p>	 <table border="1" data-bbox="592 577 1291 734"> <thead> <tr> <th>MKR</th> <th>MODE</th> <th>TRC</th> <th>SC1</th> <th>X</th> <th>Y</th> <th>FUNCTION</th> <th>FUNCTION WIDTH</th> <th>FUNCTION VALUE</th> </tr> </thead> <tbody> <tr> <td>1</td> <td>N</td> <td>1</td> <td>f</td> <td>2.402 2 GHz</td> <td>-5.312 dBm</td> <td></td> <td></td> <td></td> </tr> <tr> <td>2</td> <td>N</td> <td>1</td> <td>f</td> <td>4.804 3 GHz</td> <td>-41.720 dBm</td> <td></td> <td></td> <td></td> </tr> <tr> <td>3</td> <td>N</td> <td>1</td> <td>f</td> <td>4.804 3 GHz</td> <td>-41.720 dBm</td> <td></td> <td></td> <td></td> </tr> <tr> <td>4</td> <td>N</td> <td>1</td> <td>f</td> <td>7.394 9 GHz</td> <td>-60.907 dBm</td> <td></td> <td></td> <td></td> </tr> <tr> <td>5</td> <td>N</td> <td>1</td> <td>f</td> <td>9.608 5 GHz</td> <td>-57.480 dBm</td> <td></td> <td></td> <td></td> </tr> </tbody> </table>	MKR	MODE	TRC	SC1	X	Y	FUNCTION	FUNCTION WIDTH	FUNCTION VALUE	1	N	1	f	2.402 2 GHz	-5.312 dBm				2	N	1	f	4.804 3 GHz	-41.720 dBm				3	N	1	f	4.804 3 GHz	-41.720 dBm				4	N	1	f	7.394 9 GHz	-60.907 dBm				5	N	1	f	9.608 5 GHz	-57.480 dBm				
MKR	MODE	TRC	SC1	X	Y	FUNCTION	FUNCTION WIDTH	FUNCTION VALUE																																																
1	N	1	f	2.402 2 GHz	-5.312 dBm																																																			
2	N	1	f	4.804 3 GHz	-41.720 dBm																																																			
3	N	1	f	4.804 3 GHz	-41.720 dBm																																																			
4	N	1	f	7.394 9 GHz	-60.907 dBm																																																			
5	N	1	f	9.608 5 GHz	-57.480 dBm																																																			
<p>8DPSK/MCH</p>	 <table border="1" data-bbox="592 1106 1291 1263"> <thead> <tr> <th>MKR</th> <th>MODE</th> <th>TRC</th> <th>SC1</th> <th>X</th> <th>Y</th> <th>FUNCTION</th> <th>FUNCTION WIDTH</th> <th>FUNCTION VALUE</th> </tr> </thead> <tbody> <tr> <td>1</td> <td>N</td> <td>1</td> <td>f</td> <td>2.441 5 GHz</td> <td>-6.410 dBm</td> <td></td> <td></td> <td></td> </tr> <tr> <td>2</td> <td>N</td> <td>1</td> <td>f</td> <td>24.050 0 GHz</td> <td>-47.038 dBm</td> <td></td> <td></td> <td></td> </tr> <tr> <td>3</td> <td>N</td> <td>1</td> <td>f</td> <td>4.881 7 GHz</td> <td>-48.023 dBm</td> <td></td> <td></td> <td></td> </tr> <tr> <td>4</td> <td>N</td> <td>1</td> <td>f</td> <td>7.129 6 GHz</td> <td>-60.121 dBm</td> <td></td> <td></td> <td></td> </tr> <tr> <td>5</td> <td>N</td> <td>1</td> <td>f</td> <td>9.607 9 GHz</td> <td>-54.860 dBm</td> <td></td> <td></td> <td></td> </tr> </tbody> </table>	MKR	MODE	TRC	SC1	X	Y	FUNCTION	FUNCTION WIDTH	FUNCTION VALUE	1	N	1	f	2.441 5 GHz	-6.410 dBm				2	N	1	f	24.050 0 GHz	-47.038 dBm				3	N	1	f	4.881 7 GHz	-48.023 dBm				4	N	1	f	7.129 6 GHz	-60.121 dBm				5	N	1	f	9.607 9 GHz	-54.860 dBm				
MKR	MODE	TRC	SC1	X	Y	FUNCTION	FUNCTION WIDTH	FUNCTION VALUE																																																
1	N	1	f	2.441 5 GHz	-6.410 dBm																																																			
2	N	1	f	24.050 0 GHz	-47.038 dBm																																																			
3	N	1	f	4.881 7 GHz	-48.023 dBm																																																			
4	N	1	f	7.129 6 GHz	-60.121 dBm																																																			
5	N	1	f	9.607 9 GHz	-54.860 dBm																																																			
<p>8DPSK/HCH</p>	 <table border="1" data-bbox="592 1635 1291 1783"> <thead> <tr> <th>MKR</th> <th>MODE</th> <th>TRC</th> <th>SC1</th> <th>X</th> <th>Y</th> <th>FUNCTION</th> <th>FUNCTION WIDTH</th> <th>FUNCTION VALUE</th> </tr> </thead> <tbody> <tr> <td>1</td> <td>N</td> <td>1</td> <td>f</td> <td>2.480 2 GHz</td> <td>-7.342 dBm</td> <td></td> <td></td> <td></td> </tr> <tr> <td>2</td> <td>N</td> <td>1</td> <td>f</td> <td>24.144 8 GHz</td> <td>-47.978 dBm</td> <td></td> <td></td> <td></td> </tr> <tr> <td>3</td> <td>N</td> <td>1</td> <td>f</td> <td>4.980 3 GHz</td> <td>-49.077 dBm</td> <td></td> <td></td> <td></td> </tr> <tr> <td>4</td> <td>N</td> <td>1</td> <td>f</td> <td>7.448 6 GHz</td> <td>-59.913 dBm</td> <td></td> <td></td> <td></td> </tr> <tr> <td>5</td> <td>N</td> <td>1</td> <td>f</td> <td>9.920 0 GHz</td> <td>-56.976 dBm</td> <td></td> <td></td> <td></td> </tr> </tbody> </table>	MKR	MODE	TRC	SC1	X	Y	FUNCTION	FUNCTION WIDTH	FUNCTION VALUE	1	N	1	f	2.480 2 GHz	-7.342 dBm				2	N	1	f	24.144 8 GHz	-47.978 dBm				3	N	1	f	4.980 3 GHz	-49.077 dBm				4	N	1	f	7.448 6 GHz	-59.913 dBm				5	N	1	f	9.920 0 GHz	-56.976 dBm				
MKR	MODE	TRC	SC1	X	Y	FUNCTION	FUNCTION WIDTH	FUNCTION VALUE																																																
1	N	1	f	2.480 2 GHz	-7.342 dBm																																																			
2	N	1	f	24.144 8 GHz	-47.978 dBm																																																			
3	N	1	f	4.980 3 GHz	-49.077 dBm																																																			
4	N	1	f	7.448 6 GHz	-59.913 dBm																																																			
5	N	1	f	9.920 0 GHz	-56.976 dBm																																																			

9. COUDUCTED PEAK OUTPUT POWER

9.1 Block Diagram Of Test Setup

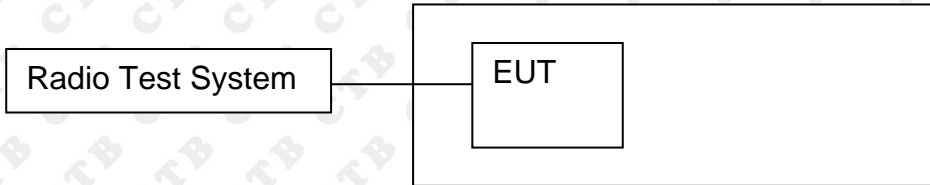

9.2 Limit

For frequency hopping systems operating in the 2400-2483.5 MHz band employing at least 75 non-overlapping hopping channels, and all frequency hopping systems in the 5725-5850 MHz band: 1 watt. For all other frequency hopping systems in the 2400-2483.5 MHz band: 0.125 watts.

9.3 Test procedure

1. Remove the antenna from the EUT and then connect a low RF cable from the antenna port to the spectrum.
2. Set the spectrum analyzer: RBW = 3MHz. VBW = 8MHz. Sweep = auto; Detector Function = Peak.
3. Keep the EUT in transmitting at lowest, middle and highest channel individually. Record the max value.

9.4 Test Result

Mode	Channel.	Maximum Peak Output Power [dBm]	Verdict
BDR mode (GFSK)	LCH	1.826	PASS
	MCH	0.399	PASS
	HCH	-1.019	PASS
EDR mode ($\pi/4$ DQPSK)	LCH	-0.326	PASS
	MCH	-1.134	PASS
	HCH	-2.450	PASS
EDR mode (8DPSK)	LCH	0.404	PASS
	MCH	-0.427	PASS
	HCH	-1.817	PASS

Test Graph:

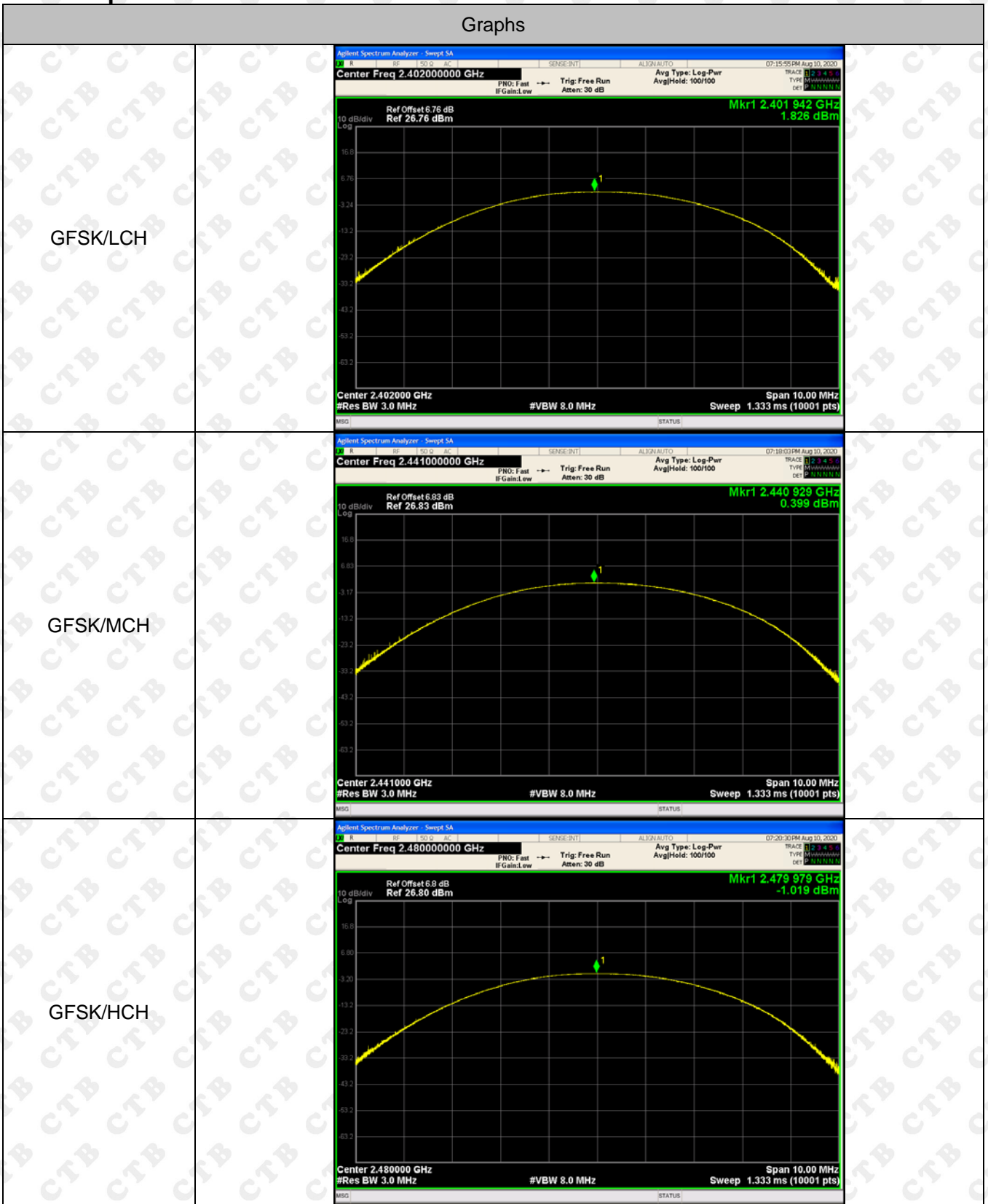

<p>$\pi/4$DQPSK/LCH</p>		
<p>$\pi/4$DQPSK/MCH</p>		
<p>$\pi/4$DQPSK/HCH</p>		

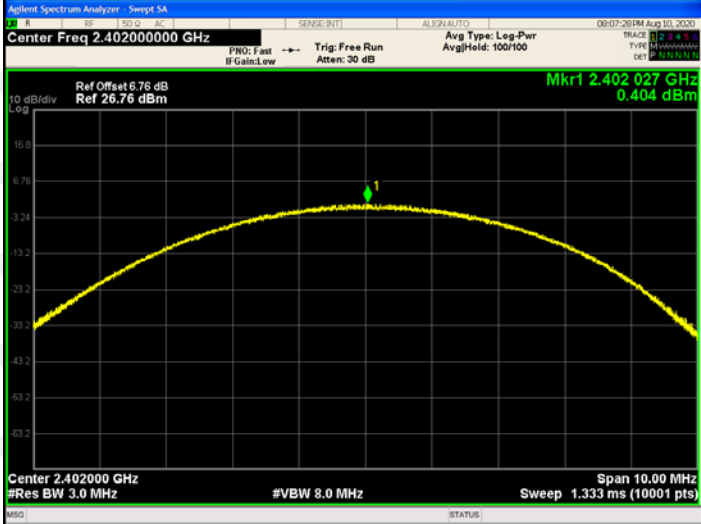
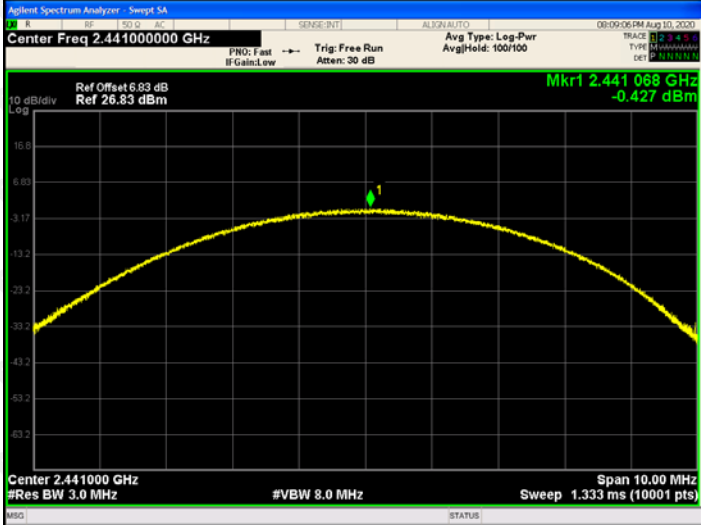
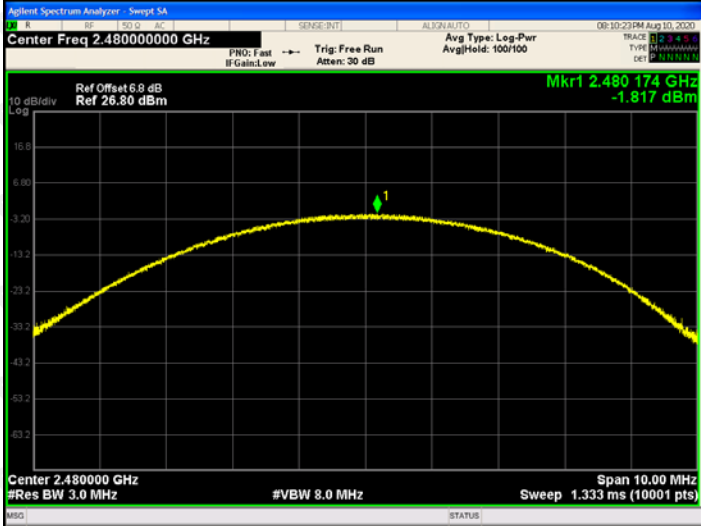
<p>8DPSK/LCH</p>		
<p>8DPSK/MCH</p>		
<p>8DPSK/HCH</p>		

10. 20DB OCCUPIED BANDWIDTH

10.1 Block Diagram Of Test Setup

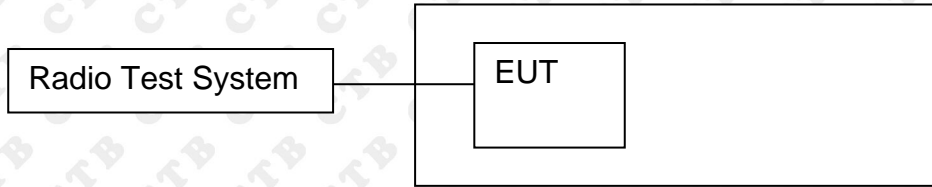

10.2 Limit

Alternatively, frequency hopping systems operating in the 2400-2483.5MHz band may have hopping channel carrier frequencies that are separated by 25kHz or two-thirds of the 20dB bandwidth of the hopping channel, whichever is greater, provided the systems operate with an output power no greater than 125mw.

10.3 Test procedure

1. Rem1. Set RBW = 30 kHz.
2. Set the video bandwidth (VBW) $\geq 3 \times$ RBW.
3. Detector = Peak.
4. Trace mode = max hold.
5. Sweep = auto couple.
6. Allow the trace to stabilize.
7. Measure the maximum width of the emission that is constrained by the frequencies associated with the two outermost amplitude points (upper and lower frequencies) that are attenuated by 6 dB relative to the maximum level measured in the fundamental emission.

10.4 Test Result

Test Mode	Frequency	20dB Bandwidth (MHz)	Result
GFSK	Low channel	0.9224	PASS
	Mid channel	0.9133	PASS
	High channel	0.9307	PASS
$\pi/4$ DQPSK	Low channel	1.3222	PASS
	Mid channel	1.316	PASS
	High channel	1.325	PASS
8DPSK	Low channel	1.2902	PASS
	Mid channel	1.2832	PASS
	High channel	1.3205	PASS

Note: All modes of operation were Pre-scan and the worst-case emissions are reported.

Test Graph:

<p>GFSK Low channel</p>	<p>Agilent Spectrum Analyzer - Occupied BW</p> <p>Center Freq: 2.40200000 GHz</p> <p>Center Freq: 2.402000000 GHz</p> <p>Trig: Free Run</p> <p>Avg/Hold: 100/100</p> <p>Radio Std: None</p> <p>Radio Device: BTS</p> <p>#IF Gain: Low</p> <p>#Atten: 10 dB</p> <p>10 dB/Div</p> <p>Log</p> <p>Ref 20.00 dBm</p> <p>Center 2.402 GHz</p> <p>#Res BW 30 kHz</p> <p>#VBW 100 kHz</p> <p>Span 2 MHz</p> <p>Sweep 2.667 ms</p> <p>Occupied Bandwidth 815.28 kHz</p> <p>Total Power 0.94 dBm</p> <p>Transmit Freq Error 61.349 kHz</p> <p>OBW Power 99.00 %</p> <p>x dB Bandwidth 922.4 kHz</p> <p>x dB -20.00 dB</p> <p>MSG STATUS</p>
<p>GFSK Mid channel</p>	<p>Agilent Spectrum Analyzer - Occupied BW</p> <p>Center Freq: 2.44100000 GHz</p> <p>Center Freq: 2.441000000 GHz</p> <p>Trig: Free Run</p> <p>Avg/Hold: 100/100</p> <p>Radio Std: None</p> <p>Radio Device: BTS</p> <p>#IF Gain: Low</p> <p>#Atten: 10 dB</p> <p>10 dB/Div</p> <p>Log</p> <p>Ref 20.00 dBm</p> <p>Center 2.441 GHz</p> <p>#Res BW 30 kHz</p> <p>#VBW 100 kHz</p> <p>Span 2 MHz</p> <p>Sweep 2.667 ms</p> <p>Occupied Bandwidth 818.60 kHz</p> <p>Total Power -0.58 dBm</p> <p>Transmit Freq Error 57.356 kHz</p> <p>OBW Power 99.00 %</p> <p>x dB Bandwidth 913.3 kHz</p> <p>x dB -20.00 dB</p> <p>MSG STATUS</p>
<p>GFSK High channel</p>	<p>Agilent Spectrum Analyzer - Occupied BW</p> <p>Center Freq: 2.48000000 GHz</p> <p>Center Freq: 2.480000000 GHz</p> <p>Trig: Free Run</p> <p>Avg/Hold: 100/100</p> <p>Radio Std: None</p> <p>Radio Device: BTS</p> <p>#IF Gain: Low</p> <p>#Atten: 10 dB</p> <p>10 dB/Div</p> <p>Log</p> <p>Ref 20.00 dBm</p> <p>Center 2.48 GHz</p> <p>#Res BW 30 kHz</p> <p>#VBW 100 kHz</p> <p>Span 2 MHz</p> <p>Sweep 2.667 ms</p> <p>Occupied Bandwidth 807.89 kHz</p> <p>Total Power -1.84 dBm</p> <p>Transmit Freq Error 57.699 kHz</p> <p>OBW Power 99.00 %</p> <p>x dB Bandwidth 930.7 kHz</p> <p>x dB -20.00 dB</p> <p>MSG STATUS</p>

<p>$\pi/4$-DQPSK Low channel</p>	<p>Agilent Spectrum Analyzer - Occupied BW Center Freq 2.402000000 GHz Center Freq: 2.402000000 GHz Trig: Free Run #Atten: 10 dB Avg/Hold: 100/100 Radio Std: None Radio Device: BTS</p> <p>10 dB/div Ref 20.00 dBm</p> <p>Center 2.402 GHz #Res BW 30 kHz #VBW 100 kHz Span 2 MHz Sweep 2.667 ms</p> <table border="1"> <tr> <td>Occupied Bandwidth</td> <td>Total Power</td> <td>-3.35 dBm</td> </tr> <tr> <td>1.1739 MHz</td> <td></td> <td></td> </tr> <tr> <td>Transmit Freq Error</td> <td>OBW Power</td> <td>99.00 %</td> </tr> <tr> <td>54.184 kHz</td> <td>x dB</td> <td>-20.00 dB</td> </tr> <tr> <td>x dB Bandwidth</td> <td></td> <td></td> </tr> <tr> <td>1.322 MHz</td> <td></td> <td></td> </tr> </table>	Occupied Bandwidth	Total Power	-3.35 dBm	1.1739 MHz			Transmit Freq Error	OBW Power	99.00 %	54.184 kHz	x dB	-20.00 dB	x dB Bandwidth			1.322 MHz			
Occupied Bandwidth	Total Power	-3.35 dBm																		
1.1739 MHz																				
Transmit Freq Error	OBW Power	99.00 %																		
54.184 kHz	x dB	-20.00 dB																		
x dB Bandwidth																				
1.322 MHz																				
<p>$\pi/4$-DQPSK Mid channel</p>	<p>Agilent Spectrum Analyzer - Occupied BW Center Freq 2.441000000 GHz Center Freq: 2.441000000 GHz Trig: Free Run #Atten: 10 dB Avg/Hold: 100/100 Radio Std: None Radio Device: BTS</p> <p>10 dB/div Ref 20.00 dBm</p> <p>Center 2.441 GHz #Res BW 30 kHz #VBW 100 kHz Span 2 MHz Sweep 2.667 ms</p> <table border="1"> <tr> <td>Occupied Bandwidth</td> <td>Total Power</td> <td>-3.97 dBm</td> </tr> <tr> <td>1.1764 MHz</td> <td></td> <td></td> </tr> <tr> <td>Transmit Freq Error</td> <td>OBW Power</td> <td>99.00 %</td> </tr> <tr> <td>54.512 kHz</td> <td>x dB</td> <td>-20.00 dB</td> </tr> <tr> <td>x dB Bandwidth</td> <td></td> <td></td> </tr> <tr> <td>1.316 MHz</td> <td></td> <td></td> </tr> </table>	Occupied Bandwidth	Total Power	-3.97 dBm	1.1764 MHz			Transmit Freq Error	OBW Power	99.00 %	54.512 kHz	x dB	-20.00 dB	x dB Bandwidth			1.316 MHz			
Occupied Bandwidth	Total Power	-3.97 dBm																		
1.1764 MHz																				
Transmit Freq Error	OBW Power	99.00 %																		
54.512 kHz	x dB	-20.00 dB																		
x dB Bandwidth																				
1.316 MHz																				
<p>$\pi/4$-DQPSK High channel</p>	<p>Agilent Spectrum Analyzer - Occupied BW Center Freq 2.480000000 GHz Center Freq: 2.480000000 GHz Trig: Free Run #Atten: 10 dB Avg/Hold: 100/100 Radio Std: None Radio Device: BTS</p> <p>10 dB/div Ref 20.00 dBm</p> <p>Center 2.48 GHz #Res BW 30 kHz #VBW 100 kHz Span 2 MHz Sweep 2.667 ms</p> <table border="1"> <tr> <td>Occupied Bandwidth</td> <td>Total Power</td> <td>-5.50 dBm</td> </tr> <tr> <td>1.1818 MHz</td> <td></td> <td></td> </tr> <tr> <td>Transmit Freq Error</td> <td>OBW Power</td> <td>99.00 %</td> </tr> <tr> <td>57.081 kHz</td> <td>x dB</td> <td>-20.00 dB</td> </tr> <tr> <td>x dB Bandwidth</td> <td></td> <td></td> </tr> <tr> <td>1.325 MHz</td> <td></td> <td></td> </tr> </table>	Occupied Bandwidth	Total Power	-5.50 dBm	1.1818 MHz			Transmit Freq Error	OBW Power	99.00 %	57.081 kHz	x dB	-20.00 dB	x dB Bandwidth			1.325 MHz			
Occupied Bandwidth	Total Power	-5.50 dBm																		
1.1818 MHz																				
Transmit Freq Error	OBW Power	99.00 %																		
57.081 kHz	x dB	-20.00 dB																		
x dB Bandwidth																				
1.325 MHz																				

<p>8DPSK Low channel</p>		<p>Agilent Spectrum Analyzer - Occupied BW Center Freq: 2.402000000 GHz Center Freq: 2.402000000 GHz Trig: Free Run #Atten: 10 dB Avg/Hold: 100/100 Radio Std: None Radio Device: BTS</p> <p>10 dB/div Ref 20.00 dBm Log Center 2.402 GHz #Res BW 30 kHz #VBW 100 kHz Span 2 MHz Sweep 2.667 ms</p> <p>Occupied Bandwidth 1.1738 MHz Total Power -3.20 dBm</p> <p>Transmit Freq Error 54.692 kHz OBW Power 99.00 % x dB Bandwidth 1.290 MHz x dB -20.00 dB</p>
<p>8DPSK Mid channel</p>		<p>Agilent Spectrum Analyzer - Occupied BW Center Freq: 2.441000000 GHz Center Freq: 2.441000000 GHz Trig: Free Run #Atten: 10 dB Avg/Hold: 100/100 Radio Std: None Radio Device: BTS</p> <p>10 dB/div Ref 20.00 dBm Log Center 2.441 GHz #Res BW 30 kHz #VBW 100 kHz Span 2 MHz Sweep 2.667 ms</p> <p>Occupied Bandwidth 1.1836 MHz Total Power -3.90 dBm</p> <p>Transmit Freq Error 53.078 kHz OBW Power 99.00 % x dB Bandwidth 1.283 MHz x dB -20.00 dB</p>
<p>8DPSK High channel</p>		<p>Agilent Spectrum Analyzer - Occupied BW Center Freq: 2.480000000 GHz Center Freq: 2.480000000 GHz Trig: Free Run #Atten: 10 dB Avg/Hold: 100/100 Radio Std: None Radio Device: BTS</p> <p>10 dB/div Ref 20.00 dBm Log Center 2.48 GHz #Res BW 30 kHz #VBW 100 kHz Span 2 MHz Sweep 2.667 ms</p> <p>Occupied Bandwidth 1.1861 MHz Total Power -5.41 dBm</p> <p>Transmit Freq Error 54.226 kHz OBW Power 99.00 % x dB Bandwidth 1.321 MHz x dB -20.00 dB</p>

11. CARRIER FREQUENCIES SEPARATION

11.1 Block Diagram Of Test Setup

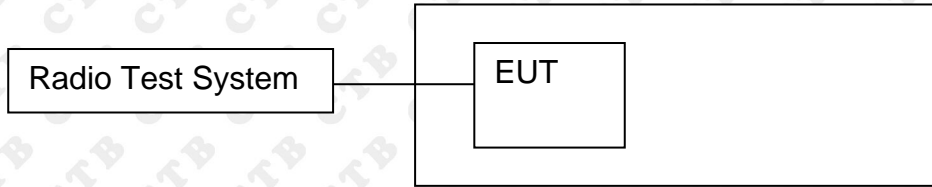

11.2 Limit

Frequency hopping systems shall have hopping channel carrier frequencies separated by a minimum of 25 kHz or the 20 dB bandwidth of the hopping channel, whichever is greater. Alternatively, frequency hopping systems operating in the 2400-2483.5 MHz band may have hopping channel carrier frequencies that are separated by 25 kHz or two-thirds of the 20 dB bandwidth of the hopping channel, whichever is greater, provided the systems operate with an output power no greater than 0.125W.

11.3 Test procedure

1. Remove the antenna from the EUT and then connect a low RF cable from the antenna port to the spectrum.
2. Set the spectrum analyzer: RBW = 100kHz. VBW = 300kHz , Span = 3.0MHz. Sweep = auto; Detector Function = Peak. Trace = Max hold.
3. Allow the trace to stabilize. Use the marker-delta function to determine the separation between the peaks of the adjacent channels. The limit is specified in one of the subparagraphs of this Section Submit this plot.

11.4 Test Result

Mode	Channel.	Carrier Frequency Separation [MHz]	Verdict
GFSK	LCH	1.020	PASS
GFSK	MCH	1.011	PASS
GFSK	HCH	0.999	PASS
$\pi/4$ DQPSK	LCH	1.029	PASS
$\pi/4$ DQPSK	MCH	1.014	PASS
$\pi/4$ DQPSK	HCH	0.999	PASS
8DPSK	LCH	0.945	PASS
8DPSK	MCH	0.999	PASS
8DPSK	HCH	1.005	PASS

Test Graph



<p>$\pi/4$DQPSK/LCH</p>	<p>Agilent Spectrum Analyzer - Sweep SA Marker 1 Δ 1.029000000 MHz Ref Offset: 6.76 dB Ref: 26.76 dBm ΔMkr1 1.029 MHz 0.250 dB Center 2.402500 GHz #Res BW 100 kHz #VBW 300 kHz Span 3.000 MHz Sweep 1.000 ms (1001 pts)</p> <table border="1"> <thead> <tr> <th>MKR</th> <th>MODE</th> <th>TRC</th> <th>SCL</th> <th>X</th> <th>Y</th> <th>FUNCTION</th> <th>FUNCTION WIDTH</th> <th>FUNCTION VALUE</th> </tr> </thead> <tbody> <tr> <td>1</td> <td>Δ2</td> <td>f</td> <td>(A)</td> <td>1.029 MHz (A)</td> <td>0.250 dB</td> <td></td> <td></td> <td></td> </tr> <tr> <td>2</td> <td>F</td> <td>f</td> <td></td> <td>2.402162 GHz</td> <td>-4.178 dBm</td> <td></td> <td></td> <td></td> </tr> </tbody> </table>	MKR	MODE	TRC	SCL	X	Y	FUNCTION	FUNCTION WIDTH	FUNCTION VALUE	1	Δ 2	f	(A)	1.029 MHz (A)	0.250 dB				2	F	f		2.402162 GHz	-4.178 dBm				
MKR	MODE	TRC	SCL	X	Y	FUNCTION	FUNCTION WIDTH	FUNCTION VALUE																					
1	Δ 2	f	(A)	1.029 MHz (A)	0.250 dB																								
2	F	f		2.402162 GHz	-4.178 dBm																								
<p>$\pi/4$DQPSK/MCH</p>	<p>Agilent Spectrum Analyzer - Sweep SA Marker 1 Δ 1.014000000 MHz Ref Offset: 6.83 dB Ref: 26.83 dBm ΔMkr1 1.014 MHz -0.575 dB Center 2.441500 GHz Res BW 27 kHz VBW 270 kHz Span 3.000 MHz Sweep 3.800 ms (1001 pts)</p> <table border="1"> <thead> <tr> <th>MKR</th> <th>MODE</th> <th>TRC</th> <th>SCL</th> <th>X</th> <th>Y</th> <th>FUNCTION</th> <th>FUNCTION WIDTH</th> <th>FUNCTION VALUE</th> </tr> </thead> <tbody> <tr> <td>1</td> <td>Δ2</td> <td>f</td> <td>(A)</td> <td>1.014 MHz (A)</td> <td>-0.575 dB</td> <td></td> <td></td> <td></td> </tr> <tr> <td>2</td> <td>F</td> <td>f</td> <td></td> <td>2.440879 GHz</td> <td>-5.213 dBm</td> <td></td> <td></td> <td></td> </tr> </tbody> </table>	MKR	MODE	TRC	SCL	X	Y	FUNCTION	FUNCTION WIDTH	FUNCTION VALUE	1	Δ 2	f	(A)	1.014 MHz (A)	-0.575 dB				2	F	f		2.440879 GHz	-5.213 dBm				
MKR	MODE	TRC	SCL	X	Y	FUNCTION	FUNCTION WIDTH	FUNCTION VALUE																					
1	Δ 2	f	(A)	1.014 MHz (A)	-0.575 dB																								
2	F	f		2.440879 GHz	-5.213 dBm																								
<p>$\pi/4$DQPSK/HCH</p>	<p>Agilent Spectrum Analyzer - Sweep SA Marker 1 Δ 999.000000 kHz Ref Offset: 6.8 dB Ref: 26.80 dBm ΔMkr1 999 kHz -0.117 dB Center 2.479500 GHz #Res BW 100 kHz #VBW 300 kHz Span 3.000 MHz Sweep 1.000 ms (1001 pts)</p> <table border="1"> <thead> <tr> <th>MKR</th> <th>MODE</th> <th>TRC</th> <th>SCL</th> <th>X</th> <th>Y</th> <th>FUNCTION</th> <th>FUNCTION WIDTH</th> <th>FUNCTION VALUE</th> </tr> </thead> <tbody> <tr> <td>1</td> <td>Δ2</td> <td>f</td> <td>(A)</td> <td>999 kHz (A)</td> <td>-0.117 dB</td> <td></td> <td></td> <td></td> </tr> <tr> <td>2</td> <td>F</td> <td>f</td> <td></td> <td>2.478924 GHz</td> <td>-5.668 dBm</td> <td></td> <td></td> <td></td> </tr> </tbody> </table>	MKR	MODE	TRC	SCL	X	Y	FUNCTION	FUNCTION WIDTH	FUNCTION VALUE	1	Δ 2	f	(A)	999 kHz (A)	-0.117 dB				2	F	f		2.478924 GHz	-5.668 dBm				
MKR	MODE	TRC	SCL	X	Y	FUNCTION	FUNCTION WIDTH	FUNCTION VALUE																					
1	Δ 2	f	(A)	999 kHz (A)	-0.117 dB																								
2	F	f		2.478924 GHz	-5.668 dBm																								

<p>8DPSK/LCH</p>	<p>Agilent Spectrum Analyzer - Sweep SA Marker 1 Δ 945.000000 kHz Ref Offset: 6.76 dB Ref: 26.76 dBm Center: 2.402500 GHz #Res BW: 100 kHz #VBW: 300 kHz Span: 3.000 MHz Sweep: 1.000 ms (1001 pts) ΔMkr1 945 kHz -0.125 dB</p> <table border="1"> <thead> <tr> <th>MKR</th> <th>MODE</th> <th>TRC</th> <th>SCL</th> <th>X</th> <th>Y</th> <th>FUNCTION</th> <th>FUNCTION WIDTH</th> <th>FUNCTION VALUE</th> </tr> </thead> <tbody> <tr> <td>1</td> <td>Δ2</td> <td>f</td> <td>(Δ)</td> <td>945 kHz (Δ)</td> <td>-0.125 dB</td> <td></td> <td></td> <td></td> </tr> <tr> <td>2</td> <td>F</td> <td>f</td> <td></td> <td>2.402 191 GHz</td> <td>-4.057 dBm</td> <td></td> <td></td> <td></td> </tr> </tbody> </table>	MKR	MODE	TRC	SCL	X	Y	FUNCTION	FUNCTION WIDTH	FUNCTION VALUE	1	Δ 2	f	(Δ)	945 kHz (Δ)	-0.125 dB				2	F	f		2.402 191 GHz	-4.057 dBm				
MKR	MODE	TRC	SCL	X	Y	FUNCTION	FUNCTION WIDTH	FUNCTION VALUE																					
1	Δ 2	f	(Δ)	945 kHz (Δ)	-0.125 dB																								
2	F	f		2.402 191 GHz	-4.057 dBm																								
<p>8DPSK/MCH</p>	<p>Agilent Spectrum Analyzer - Sweep SA Marker 1 Δ 999.000000 kHz Ref Offset: 6.83 dB Ref: 26.83 dBm Center: 2.441500 GHz #Res BW: 100 kHz #VBW: 300 kHz Span: 3.000 MHz Sweep: 1.000 ms (1001 pts) ΔMkr1 999 kHz -0.054 dB</p> <table border="1"> <thead> <tr> <th>MKR</th> <th>MODE</th> <th>TRC</th> <th>SCL</th> <th>X</th> <th>Y</th> <th>FUNCTION</th> <th>FUNCTION WIDTH</th> <th>FUNCTION VALUE</th> </tr> </thead> <tbody> <tr> <td>1</td> <td>Δ2</td> <td>f</td> <td>(Δ)</td> <td>999 kHz (Δ)</td> <td>-0.054 dB</td> <td></td> <td></td> <td></td> </tr> <tr> <td>2</td> <td>F</td> <td>f</td> <td></td> <td>2.441 056 GHz</td> <td>-3.899 dBm</td> <td></td> <td></td> <td></td> </tr> </tbody> </table>	MKR	MODE	TRC	SCL	X	Y	FUNCTION	FUNCTION WIDTH	FUNCTION VALUE	1	Δ 2	f	(Δ)	999 kHz (Δ)	-0.054 dB				2	F	f		2.441 056 GHz	-3.899 dBm				
MKR	MODE	TRC	SCL	X	Y	FUNCTION	FUNCTION WIDTH	FUNCTION VALUE																					
1	Δ 2	f	(Δ)	999 kHz (Δ)	-0.054 dB																								
2	F	f		2.441 056 GHz	-3.899 dBm																								
<p>8DPSK/HCH</p>	<p>Agilent Spectrum Analyzer - Sweep SA Marker 1 Δ 1.005000000 MHz Ref Offset: 6.8 dB Ref: 26.80 dBm Center: 2.479500 GHz #Res BW: 100 kHz #VBW: 300 kHz Span: 3.000 MHz Sweep: 1.000 ms (1001 pts) ΔMkr1 1.005 MHz 0.045 dB</p> <table border="1"> <thead> <tr> <th>MKR</th> <th>MODE</th> <th>TRC</th> <th>SCL</th> <th>X</th> <th>Y</th> <th>FUNCTION</th> <th>FUNCTION WIDTH</th> <th>FUNCTION VALUE</th> </tr> </thead> <tbody> <tr> <td>1</td> <td>Δ2</td> <td>f</td> <td>(Δ)</td> <td>1.005 MHz (Δ)</td> <td>0.045 dB</td> <td></td> <td></td> <td></td> </tr> <tr> <td>2</td> <td>F</td> <td>f</td> <td></td> <td>2.479 044 GHz</td> <td>-5.464 dBm</td> <td></td> <td></td> <td></td> </tr> </tbody> </table>	MKR	MODE	TRC	SCL	X	Y	FUNCTION	FUNCTION WIDTH	FUNCTION VALUE	1	Δ 2	f	(Δ)	1.005 MHz (Δ)	0.045 dB				2	F	f		2.479 044 GHz	-5.464 dBm				
MKR	MODE	TRC	SCL	X	Y	FUNCTION	FUNCTION WIDTH	FUNCTION VALUE																					
1	Δ 2	f	(Δ)	1.005 MHz (Δ)	0.045 dB																								
2	F	f		2.479 044 GHz	-5.464 dBm																								

12. HOPPING CHANNEL NUMBER

12.1 Block Diagram Of Test Setup

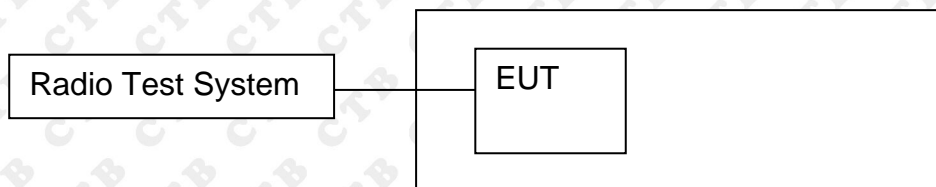

12.2 Limit

Frequency hopping systems in the 2400-2483.5 MHz band shall use at least 15 channels.

12.3 Test procedure

1. Remove the antenna from the EUT and then connect a low RF cable from the antenna port to the spectrum.
2. Set the spectrum analyzer: RBW = 100kHz. VBW = 300kHz. Sweep = auto; Detector Function = Peak. Trace = Max hold.
3. Allow the trace to stabilize. It may prove necessary to break the span up to sections. in order to clearly show all of the hopping frequencies. The limit is specified in one of the subparagraphs of this Section.
4. Set the spectrum analyzer: Start Frequency = 2.4GHz, Stop Frequency = 2.4835GHz. Sweep=auto;

12.4 Test Result

Mode	Channel.	Number of Hopping Channel	Verdict
GFSK	Hop	79	PASS
$\pi/4$ DQPSK	Hop	79	PASS
8DPSK	Hop	79	PASS

Test Graph

Graphs

GFSK/Hop

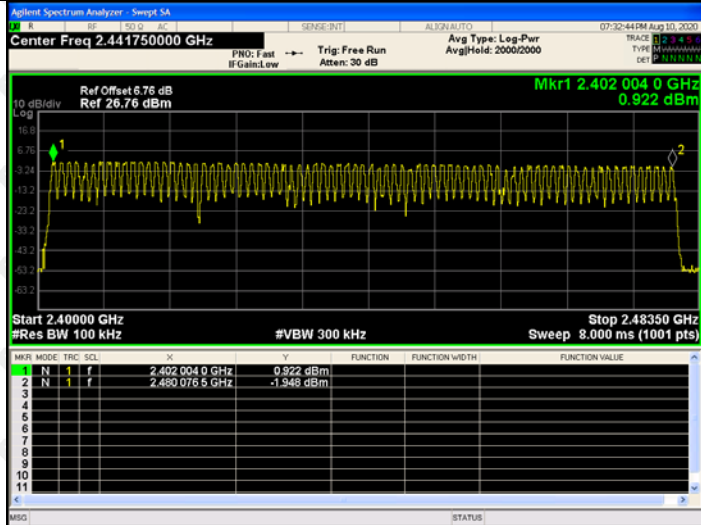

$\pi/4$ DQPSK/Hop

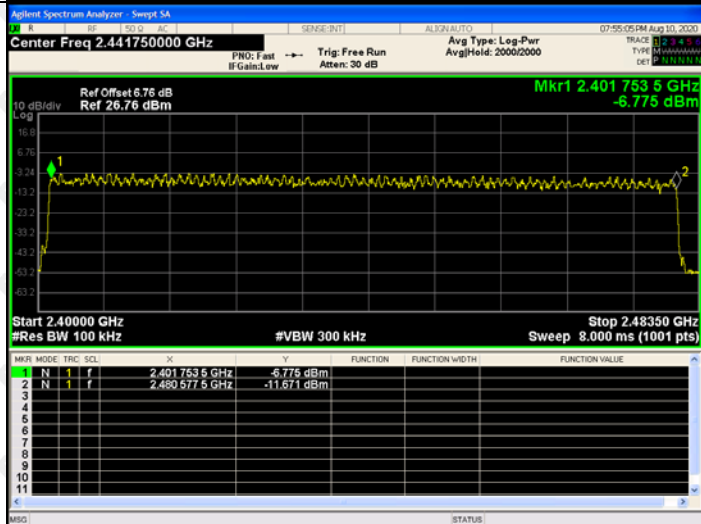

8DPSK/Hop

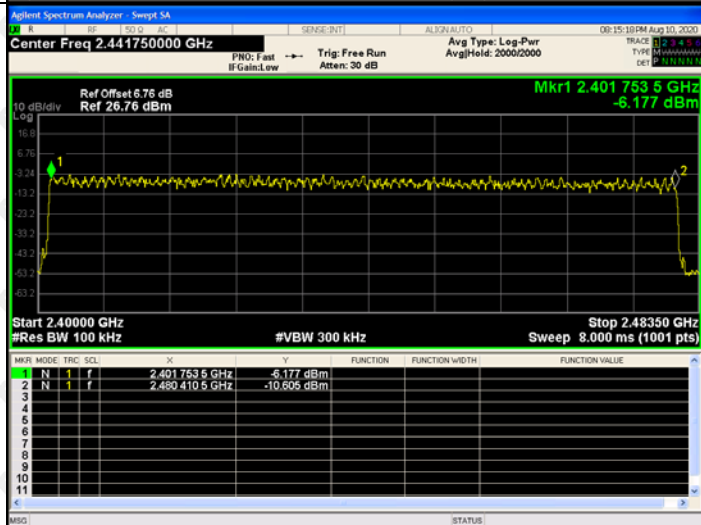

13. DWELL TIME

13.1 Block Diagram Of Test Setup

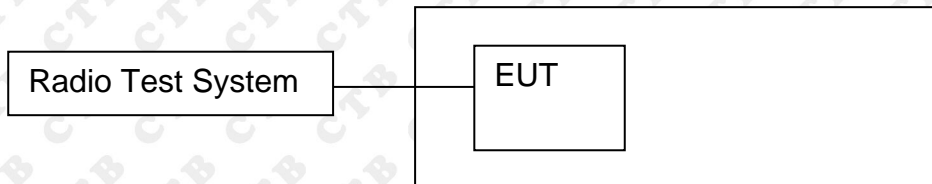

13.2 Limit

Frequency hopping systems in the 2400-2483.5 MHz band shall use at least 15 channels. The average time of occupancy on any channel shall not be greater than 0.4 seconds within a period of 0.4 seconds multiplied by the number of hopping channels employed. Frequency hopping systems may avoid or suppress transmissions on a particular hopping frequency provided that a minimum of 15 channels are used.

13.3 Test procedure

1. Remove the antenna from the EUT and then connect a low RF cable from the antenna port to the spectrum.
2. Set spectrum analyzer span = 0. Centred on a hopping channel;
3. Set RBW = 1MHz and VBW = 3MHz. Sweep = as necessary to capture the entire dwell time per hopping channel. Set the EUT for DH5, DH3 and DH1 packet transmitting.
4. Use the marker-delta function to determine the dwell time. If this value varies with different modes of operation (e.g.. data rate. modulation format. etc.). repeat this test for each variation. The limit is specified in one of the subparagraphs of this Section. Submit this plot(s).

13.4 Test Result

Mode	Packet	Channel	Pulse Time (ms)	Total Dwell Time (ms)	Limit (ms)	Verdict
GFSK	DH1	LCH	0.385	121.723	400	PASS
	DH1	MCH	0.385	121.723	400	PASS
	DH1	HCH	0.385	121.628	400	PASS
	DH3	LCH	1.645	259.942	400	PASS
	DH3	MCH	1.646	259.989	400	PASS
	DH3	HCH	1.645	259.989	400	PASS
	DH5	LCH	2.896	274.493	400	PASS
	DH5	MCH	2.896	274.541	400	PASS
	DH5	HCH	2.896	274.541	400	PASS

Remark: DH5 Packet permit maximum 1600 / 79 / 6 hops per second in each channel (5 time slots RX, 1 time slot TX).

DH3 Packet permit maximum 1600 / 79 / 4 hops per second in each channel (3 time slots RX, 1 time slot TX).

DH1 Packet permit maximum 1600 / 79 / 2 hops per second in each channel (1 time slot RX, 1 time slot TX). So, the Dwell Time can be calculated as follows:

DH5: $1600/79/6*0.4*79*(MkrDelta)/1000$

DH3: $1600/79/4*0.4*79*(MkrDelta)/1000$

DH1: $1600/79/2*0.4*79*(MkrDelta)/1000$

Remark: Mkr Delta is once pulse time.

Test Graph

Graphs

GFSK_DH1/LCH

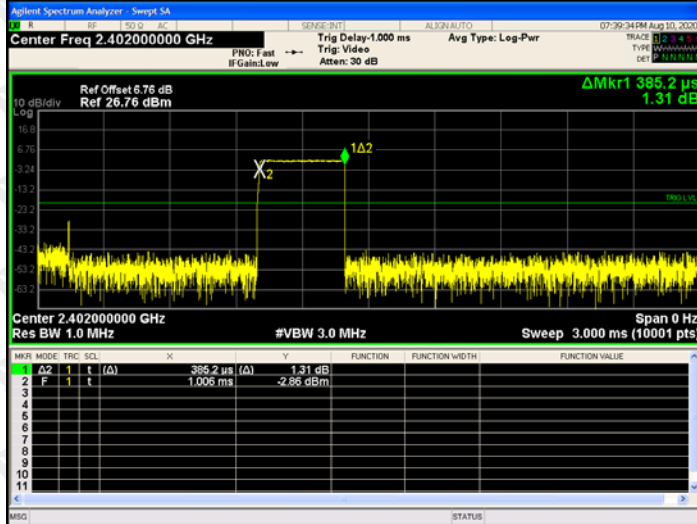

GFSK_DH1/MCH

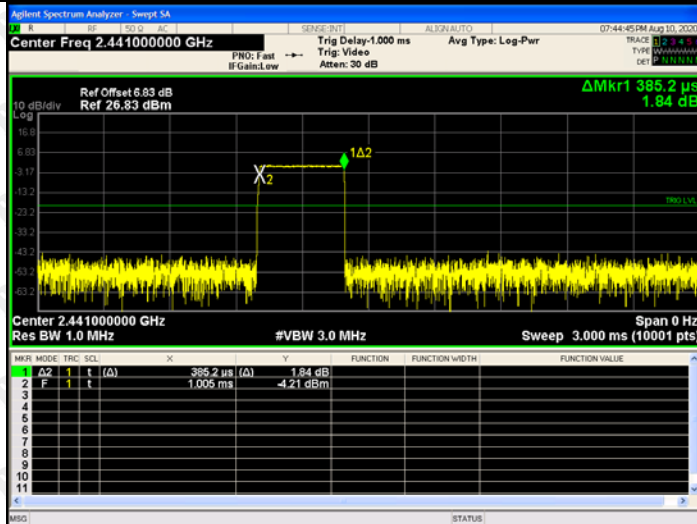

GFSK_DH1/HCH

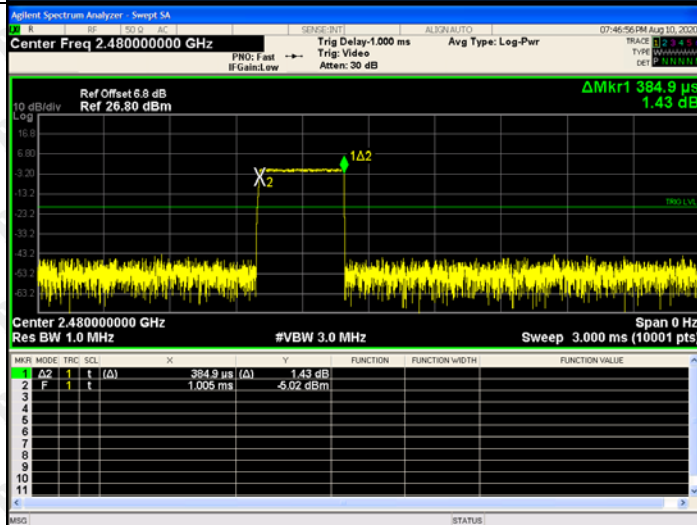

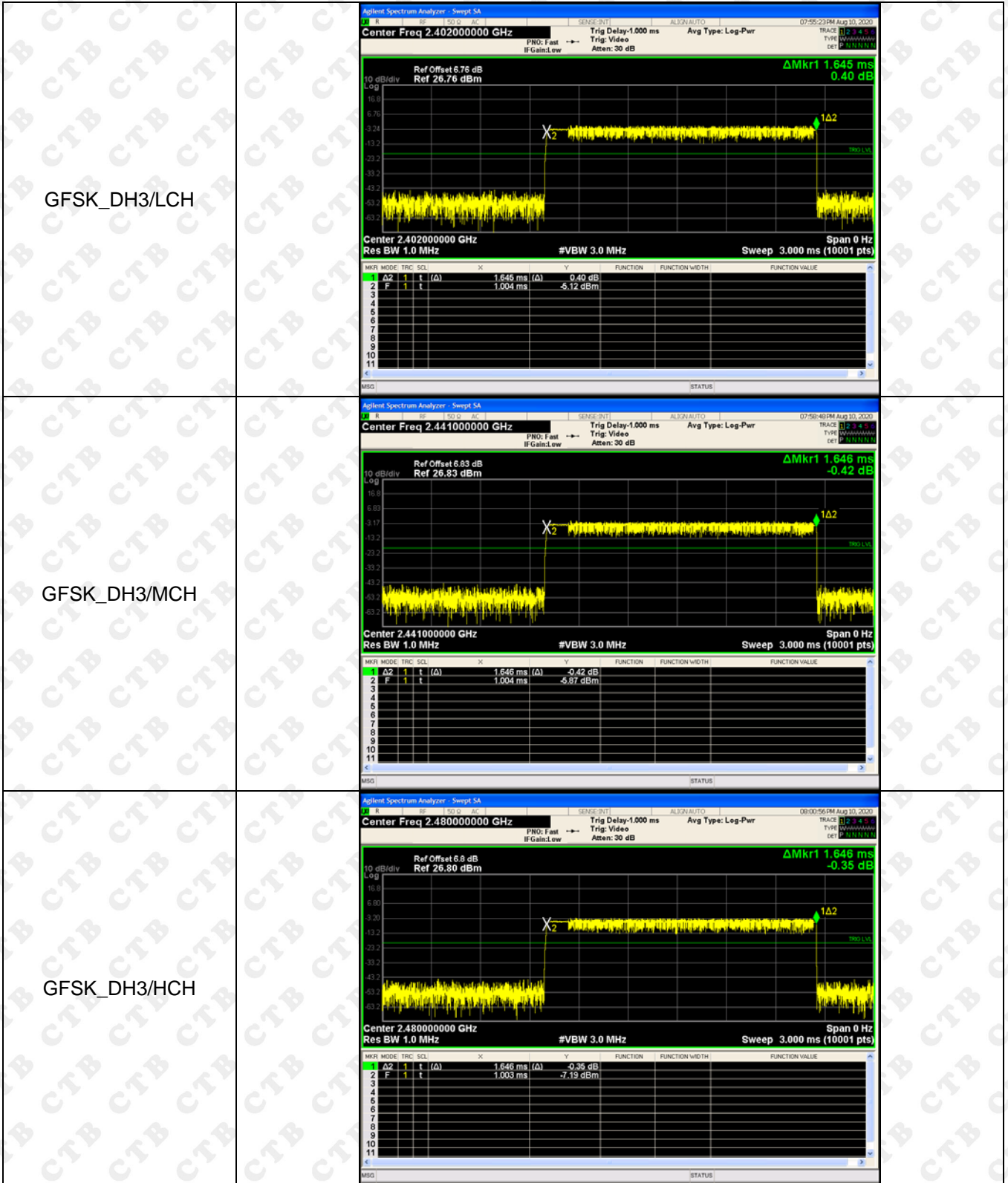

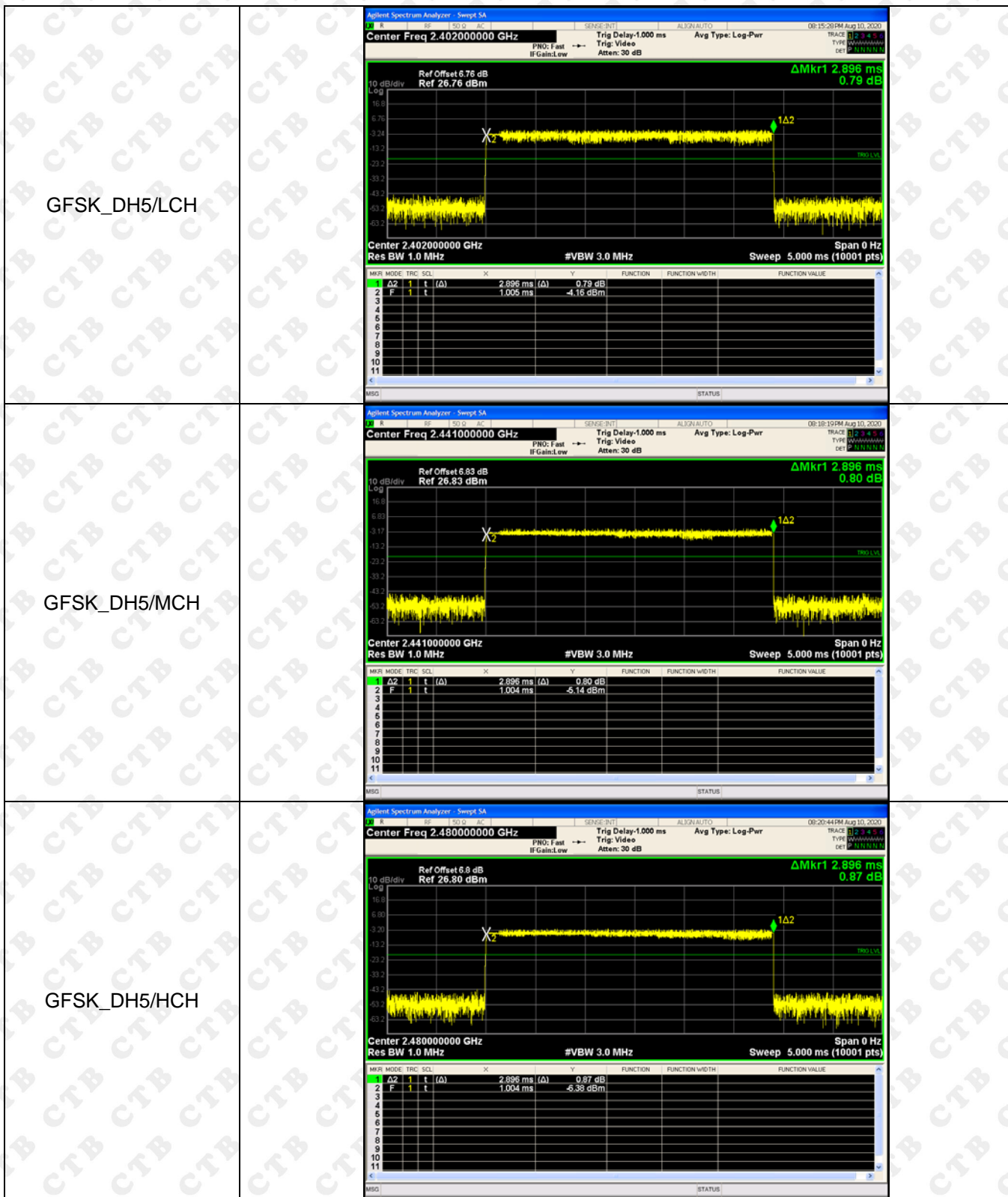

14. PSEUDORANDOM FREQUENCY

14.1 Limit

Frequency hopping systems shall have hopping channel carrier frequencies separated by a minimum of 25 kHz or the 20 dB bandwidth of the hopping channel, whichever is greater. Alternatively, Frequency hopping systems operating in the 2400-2483.5 MHz band may have hopping channel carrier frequencies that are separated by 25 kHz or two-thirds of the 20 dB bandwidth of the hopping channel, whichever is greater, provided the systems operate with an output power no greater than 125 mW. The system shall hop to channel frequencies that are selected at the system hopping rate from a Pseudorandom ordered list of hopping frequencies. Each frequency must be used equally on the average by each transmitter. The system receivers shall have input bandwidths that match the hopping channel bandwidths of their corresponding transmitters and shall shift frequencies in synchronization with the transmitted signals.

14.2 Test procedure

The pseudorandom sequence may be generated in a nine-stage shift register whose 5th and 9th stage outputs are added in a modulo-two addition stage. And the result is fed back to the input of the first stage. The sequence begins with the first ONE of 9 consecutive ONES; i.e. the shift register is initialized with nine ones.

- Number of shift register stages: 9
- Length of pseudo-random sequence: $2^9 - 1 = 511$ bits
- Longest sequence of zeros: 8 (non-inverted signal)

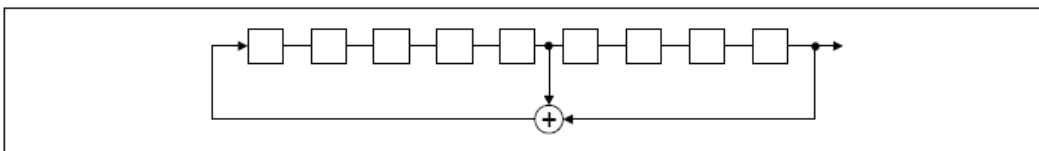

An example of Pseudorandom Frequency Hopping Sequence as follow:

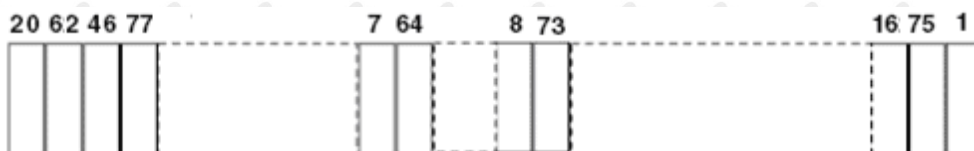

Each frequency used equally on the average by each transmitter. The system receivers have input bandwidths that match the hopping channel bandwidths of their Corresponding transmitters and shift frequencies in synchronization with the transmitted signals.

14.3 Test Result

The device does not have the ability to be coordinated with other FHSS systems in an effort to avoid the simultaneous occupancy of individual hopping frequencies by multiple transmitters.

15. ANTENNA REQUIREMENT

15.203 requirement:

An intentional radiator shall be designed to ensure that no antenna other than that furnished by the responsible party shall be used with the device. The use of a permanently attached antenna or of an antenna that uses a unique coupling to the intentional radiator, the manufacturer may design the unit so that a broken antenna can be replaced by the user, but the use of a standard antenna jack or electrical connector is prohibited.

15.247(b) (4) requirement:

The conducted output power limit specified in paragraph (b) of this section is based on the use of antennas with directional gains that do not exceed 6 dBi. Except as shown in paragraph (c) of this section, if transmitting antennas of directional gain greater than 6 dBi are used, the conducted output power from the intentional radiator shall be reduced below the stated values in paragraphs (b)(1), (b)(2), and (b)(3) of this section, as appropriate, by the amount in dB that the directional gain of the antenna exceeds 6 dBi.

EUT Antenna:

The antenna is PCB antenna. The best case gain of the antenna is 0.5dBi.

16. EUT PHOTOGRAPHS

EUT Photo 1



EUT Photo 2



17. EUT TEST SETUP PHOTOGRAPHS

Radiated Emission

Below 1G

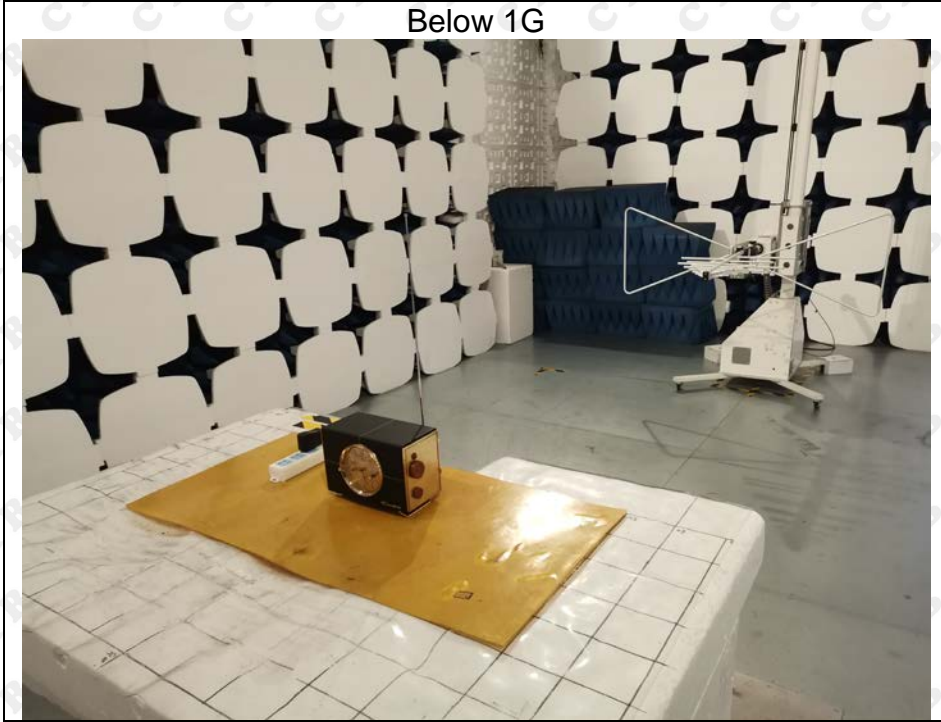

Above 1G



Conducted Emission



***** END OF REPORT *****