

FCC Test Report

Report No.: AGC02728190302FE03

FCC ID : AUSCR3037A
APPLICATION PURPOSE : Original Equipment
PRODUCT DESIGNATION : Multifunctional FM Radio Speaker
BRAND NAME : CROSLEY
MODEL NAME : CR3037A, CS-2026
CLIENT : Modern Marketing Concepts, Inc.
DATE OF ISSUE : Mar. 26, 2019
STANDARD(S) : FCC Part 15 Subpart C Section 15.247
REPORT VERSION : V1.0

Attestation of Global Compliance (Shenzhen) Co., Ltd

CAUTION:

This report shall not be reproduced except in full without the written permission of the test laboratory and shall not be quoted out of context.



The results shown in this test report refer only to the sample(s) tested unless otherwise stated and the sample(s) are retained for 30 days only. The document is issued by AGC, this document cannot be reproduced except in full with our prior written permission. The more details and the authenticity of the report will be confirmed at <http://www.agc-cert.com>.

Report Revise Record

Report Version	Revise Time	Issued Date	Valid Version	Notes
V1.0	/	Mar. 26, 2019	Valid	Initial release

The results shown in this test report refer only to the sample(s) tested unless otherwise stated and the sample(s) are retained for 30 days only. The document is issued by AGC, this document cannot be reproduced except in full with our prior written permission. The more details and the authenticity of the report will be confirmed at <http://www.agc-cert.com>.

TABLE OF CONTENTS

1. VERIFICATION OF CONFORMITY 5

2. GENERAL INFORMATION..... 6

 2.1. PRODUCT DESCRIPTION 6

 2.2. TABLE OF CARRIER FREQUENCIES 6

 2.3. RECEIVER INPUT BANDWIDTH 7

 2.4. EXAMPLE OF A HOPPING SEQUENCY IN DATA MODE..... 7

 2.5. EQUALLY AVERAGE USE OF FREQUENCIES AND BEHAVIOUR 7

 2.6. TEST METHOD..... 8

 2.7. EQUIPMENT MODIFICATIONS..... 8

3. MEASUREMENT UNCERTAINTY..... 8

4. DESCRIPTION OF TEST MODES..... 9

5. SYSTEM TEST CONFIGURATION 10

 5.1. CONFIGURATION OF EUT SYSTEM..... 10

 5.2. EQUIPMENT USED IN EUT SYSTEM..... 10

 5.3. SUMMARY OF TEST RESULTS 11

6. TEST FACILITY 12

7. TEST EQUIPMENT LIST 13

8. PEAK OUTPUT POWER 14

 8.1. MEASUREMENT PROCEDURE 14

 8.2. TEST SET-UP (BLOCK DIAGRAM OF CONFIGURATION) 14

 8.3. LIMITS AND MEASUREMENT RESULT 15

9. BANDWIDTH 21

 9.1. MEASUREMENT PROCEDURE 21

 9.2. TEST SET-UP (BLOCK DIAGRAM OF CONFIGURATION) 21

 9.3. LIMITS AND MEASUREMENT RESULTS 21

10. CONDUCTED SPURIOUS EMISSION 28

 10.1. MEASUREMENT PROCEDURE 28

 10.2. TEST SET-UP (BLOCK DIAGRAM OF CONFIGURATION) 28

 10.3. LIMITS AND MEASUREMENT RESULT 28

11. RADIATED EMISSION 32

 11.1. TEST LIMIT 32

 11.2. MEASUREMENT PROCEDURE 32

The results shown in this test report refer only to the sample(s) tested unless otherwise stated and the sample(s) are retained for 30 days only. The document is issued by AGC, this document cannot be reproduced except in full with our prior written permission. The more details and the authenticity of the report will be confirmed at <http://www.agc-cert.com>.

11.3. TEST SETUP	34
11.4. TEST RESULT	36
12. BAND EDGE EMISSION	41
12.1. MEASUREMENT PROCEDURE	41
12.2. TEST	41
12.3. TEST RESULT	42
13. NUMBER OF HOPPING FREQUENCY	46
13.1. MEASUREMENT PROCEDURE	46
13.2. TEST SETUP (BLOCK DIAGRAM OF CONFIGURATION)	46
13.3. LIMITS AND MEASUREMENT RESULT	46
14. TIME OF OCCUPANCY (DWELL TIME)	47
14.1. MEASUREMENT PROCEDURE	47
14.2. TEST SETUP (BLOCK DIAGRAM OF CONFIGURATION)	47
14.3. LIMITS AND MEASUREMENT RESULT	47
15. FREQUENCY SEPARATION	50
15.1. MEASUREMENT PROCEDURE	50
15.2. TEST SETUP (BLOCK DIAGRAM OF CONFIGURATION)	50
15.3. LIMITS AND MEASUREMENT RESULT	51
16. LINE CONDUCTED EMISSION TEST	52
16.1. LIMITS OF LINE CONDUCTED EMISSION TEST	52
16.2. BLOCK DIAGRAM OF LINE CONDUCTED EMISSION TEST	52
16.3. PRELIMINARY PROCEDURE OF LINE CONDUCTED EMISSION TEST	53
16.4. FINAL PROCEDURE OF LINE CONDUCTED EMISSION TEST	53
16.5. TEST RESULT OF LINE CONDUCTED EMISSION TEST	54
APPENDIX A: PHOTOGRAPHS OF TEST SETUP	56
APPENDIX B: PHOTOGRAPHS OF EUT	58

The results shown in this test report refer only to the sample(s) tested unless otherwise stated and the sample(s) are retained for 30 days only. The document is issued by AGC, this document cannot be reproduced except in full with our prior written permission. The more details and the authenticity of the report will be confirmed at <http://www.agc-cert.com>.

1. VERIFICATION OF CONFORMITY

Applicant	Modern Marketing Concepts, Inc.
Address	1220 E Oak St , Louisville, Kentucky,United States, 40204
Manufacturer	SHENZHEN GXTSONIC TECHNOLOGY CO., LTD
Address	1F,Building 3,Tianxin Shuichan Industrial Park,Gushu Village,Xixiang Town,Bao`an District,Shenzhen,CHINA
Factory	SHENZHEN GXTSONIC TECHNOLOGY CO., LTD
Address	1F,Building 3,Tianxin Shuichan Industrial Park,Gushu Village,Xixiang Town,Bao`an District,Shenzhen,CHINA
Product Designation	Multifunctional FM Radio Speaker
Brand Name	CROSLEY
Test Model	CR3037A
Series Model	CS-2026
Difference description	Same PCBA, Different appearance.
Date of test	Mar. 18, 2019 to Mar. 26, 2019
Deviation	None
Condition of Test Sample	Normal
Report Template	AGCRT-US-BR/RF (2013-03-01)

We hereby certify that:

The above equipment was tested by Attestation of Global Compliance (Shenzhen) Co., Ltd. The test data, the energy emitted by the sample tested as described in this report is in compliance with the requirements of FCC Rules Part 15.247. The test results of this report relate only to the tested sample identified in this report.

Tested By

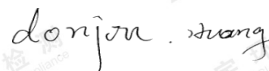

Donjon Huang(Huang
dongyang)

Mar. 26, 2019

Reviewed By



Bart Xie(Xie Xiaobin)

Mar. 26, 2019

Approved By



Forrest Lei(Lei Yonggang)
Authorized Officer

Mar. 26, 2019

The results shown in this test report refer only to the sample(s) tested unless otherwise stated and the sample(s) are retained for 30 days only. The document is issued by AGC, this document cannot be reproduced except in full with our prior written permission. The more details and the authenticity of the report will be confirmed at <http://www.agc-cert.com>.

2. GENERAL INFORMATION

2.1. PRODUCT DESCRIPTION

The EUT is "Multifunctional FM Radio Speaker" designed as a "Communication Device". It is designed by way of utilizing the FHSS technology to achieve the system operation.

A major technical description of EUT is described as following

Operation Frequency	2.402 GHz to 2.480GHz
RF Output Power	-8.413dBm(Max)
Bluetooth Version	V2.1+EDR
Modulation	<input checked="" type="checkbox"/> Basic Rate(GFSK) <input checked="" type="checkbox"/> EDR (PI/4-DQPSK) <input checked="" type="checkbox"/> EDR(8-DPSK) <input type="checkbox"/> BLE(GFSK)
Number of channels	79 for BR/EDR
Hardware Version	1.0
Software Version	1.0
Antenna Designation	PCB Antenna
Antenna Gain	0dBi
Power Supply	AC 120V/60Hz
Note: The EUT doesn't support BLE.	

2.2. TABLE OF CARRIER FREQUENCIES

Frequency Band	Channel Number	Frequency
2402~2480MHz	00	2402MHz
	01	2403MHz
	:	:
	38	2440 MHz
	39	2441 MHz
	40	2442 MHz
	:	:
	77	2479 MHz
	78	2480 MHz

The results shown in this test report refer only to the sample(s) tested unless otherwise stated and the sample(s) are retained for 30 days only. The document is issued by AGC, this document cannot be reproduced except in full with our prior written permission. The more details and the authenticity of the report will be confirmed at <http://www.agc-cert.com>.

2.3. RECEIVER INPUT BANDWIDTH

The input bandwidth of the receiver is 1.3MHZ, In every connection one Bluetooth device is the master and the other one is slave. The master determines the hopping sequence. The slave follows this sequence. Both devices shift between RX and TX time slot according to the clock of the master. Additionally the type of connection(e.g. single of multislotted packet) is set up at the beginning of the connection. The master adapts its hopping frequency and its TX/RX timing according to the packet type of the connection. Also the slave of the connection will use these settings.

Repeating of a packet has no influence on the hopping sequence. The hopping sequence generated by the master of the connection will be followed in any case. That means, a repeated packet will not be sent on the same frequency, it is sent on the next frequency of the hopping sequence.

2.4. EXAMPLE OF A HOPPING SEQUENCE IN DATA MODE

Example of a 79 hopping sequence in data mode:

40,21,44,23,42,53,46,55,48,33,52,35,50,65,54,67
56,37,60,39,58,69,62,71,64,25,68,27,66,57,70,59
72,29,76,31,74,61,78,63,01,41,05,43,03,73,07,75
09,45,13,47,11,77,15,00,64,49,66,53,68,02,70,06
01, 51, 03, 55, 05, 04

2.5. EQUALLY AVERAGE USE OF FREQUENCIES AND BEHAVIOUR

The generation of the hopping sequence in connection mode depends essentially on two input values:

1. LAP/UAP of the master of the connection.
2. Internal master clock

The LAP(lower address part) are the 24 LSB's of the 48 BD_ADDRESS. The BD_ADDRESS is an unambiguous number of every Bluetooth unit. The UAP(upper address part) are the 24MSB's of the 48BD_ADDRESS

The internal clock of a Bluetooth unit is derived from a free running clock which is never adjusted and is never turned off. For synchronization with other units only offset are used. It has no relation to the time of the day. Its resolution is at least half the RX/TX slot length of 312.5us. The clock has a cycle of about one day(23h30). In most cases it is implemented as 28 bit counter. For the deriving of the hopping sequence the entire LAP(24 bits), 4LSB's(4bits)(Input 1) and the 27MSB's of the clock(Input 2) are used. With these input values different mathematical procedures(permutations, additions, XOR-operations) are performed to generate the Sequence.

This will be done at the beginning of every new transmission.

Regarding short transmissions the Bluetooth system has the following behavior:

The first connection between the two devices is established, a hopping sequence was generated. For transmitting the wanted data the complete hopping sequence was not used. The connection ended.

The second connection will be established. A new hopping sequence is generated. Due to the fact the Bluetooth clock has a different value, because the period between the two transmissions is longer (and it cannot be shorter) than the minimum resolution of the clock(312.5us). The hopping sequence will always differ from the first one.

2.6. TEST METHOD

All measurements contained in this report were conducted with ANSI C63.10-2013.

2.7. EQUIPMENT MODIFICATIONS

Not available for this EUT intended for grant.

3. MEASUREMENT UNCERTAINTY

The reported uncertainty of measurement $y \pm U$, where expanded uncertainty U is based on a standard uncertainty multiplied by a coverage factor of $k=2$, providing a level of confidence of approximately 95 %

- Uncertainty of Conducted Emission, $U_c = \pm 3.2$ dB
- Uncertainty of Radiated Emission below 1GHz, $U_c = \pm 3.9$ dB
- Uncertainty of Radiated Emission above 1GHz, $U_c = \pm 4.8$ dB

The results shown in this test report refer only to the sample(s) tested unless otherwise stated and the sample(s) are retained for 30 days only. The document is issued by AGC, this document cannot be reproduced except in full with our prior written permission. The more details and the authenticity of the report will be confirmed at <http://www.agc-cert.com>.

4. DESCRIPTION OF TEST MODES

NO.	TEST MODE DESCRIPTION
1	Low channel GFSK
2	Middle channel GFSK
3	High channel GFSK
4	Low channel $\pi/4$ -DQPSK
5	Middle channel $\pi/4$ -DQPSK
6	High channel $\pi/4$ -DQPSK
7	Low channel 8DPSK
8	Middle channel 8DPSK
9	High channel 8DPSK
10	BT Link with charging

Note: 1. Only the result of the worst case was recorded in the report, if no other cases.
 2. For Radiated Emission, 3axis were chosen for testing for each applicable mode.
 3. The EUT used fully-charged battery when tested.
 4. For Conducted Test method, a temporary antenna connector is provided by the manufacture.

The results shown in this test report refer only to the sample(s) tested unless otherwise stated and the sample(s) are retained for 30 days only. The document is issued by AGC, this document cannot be reproduced except in full with our prior written permission. The more details and the authenticity of the report will be confirmed at <http://www.agc-cert.com>.

5. SYSTEM TEST CONFIGURATION

5.1. CONFIGURATION OF EUT SYSTEM

Configure 1: (Normal hopping)

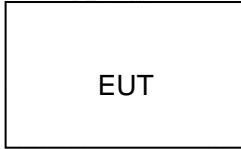

Configure 2: (Control continuous TX)

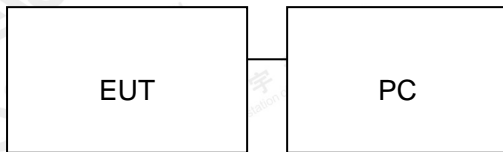

5.2. EQUIPMENT USED IN EUT SYSTEM

Item	Equipment	Model No.	ID or Specification	Remark
1	Multifunctional FM Radio Speaker	CR3037A	AUSCR3037A	EUT
2	Adapter	BSY012U100100U	DC 10V 1A	Accessory

The results shown in this test report refer only to the sample(s) tested unless otherwise stated and the sample(s) are retained for 30 days only. The document is issued by AGC, this document cannot be reproduced except in full with our prior written permission. The more details and the authenticity of the report will be confirmed at <http://www.agc-cert.com>.

5.3. SUMMARY OF TEST RESULTS

FCC RULES	DESCRIPTION OF TEST	RESULT
§15.247 b(1)	Peak Output Power	Compliant
§15.247 a(1)	20 dB Bandwidth	Compliant
§15.247 d	Conducted Spurious Emission	Compliant
§15.247 d §15.209	Radiated Emission	Compliant
§15.247 d	Band Edges	Compliant
§15.247 a(1)(iii)	Number of hopping frequency	Compliant
§15.247 a(1)(iii)	Time of Occupancy	Compliant
§15.247 a(1)	Frequency Separation	Compliant
§15.207	Line conduction Emission	Compliant

The results shown in this test report refer only to the sample(s) tested unless otherwise stated and the sample(s) are retained for 30 days only. The document is issued by AGC, this document cannot be reproduced except in full with our prior written permission. The more details and the authenticity of the report will be confirmed at <http://www.agc-cert.com>.

6. TEST FACILITY

Test Site	Attestation of Global Compliance (Shenzhen) Co., Ltd
Location	1-2/F, Building 19, Junfeng Industrial Park, Chongqing Road, Heping Community, Fuhai Street, Bao'an District, Shenzhen, Guangdong, China
Designation Number	CN1259
FCC Test Firm Registration Number	975832
A2LA Cert. No.	5054.02
Description	Attestation of Global Compliance(Shenzhen) Co., Ltd is accredited by A2LA

The results shown in this test report refer only to the sample(s) tested unless otherwise stated and the sample(s) are retained for 30 days only. The document is issued by AGC, this document cannot be reproduced except in full with our prior written permission. The more details and the authenticity of the report will be confirmed at <http://www.agc-cert.com>.

7. TEST EQUIPMENT LIST

TEST EQUIPMENT OF RADIATED EMISSION TEST

Equipment	Manufacturer	Model	S/N	Cal. Date	Cal. Due
TEST RECEIVER	R&S	ESCI	10096	Jun. 12, 2018	Jun. 11, 2019
EXA Signal Analyzer	Aglient	N9010A	MY53470504	Dec. 20, 2018	Dec. 19, 2019
2.4GHz Fliter	Micro-tronics	087	N/A	Jun. 12, 2018	Jun. 11, 2019
Attenuator	Weinachel Corp	58-30-33	N/A	Jun. 12, 2018	Jun. 11, 2019
Horn antenna	SCHWARZBECK	BBHA 9170	#768	Sep. 21, 2017	Sep. 20, 2020
Active loop antenna (9K-30MHz)	ZHINAN	ZN30900C	18051	Jun. 14, 2018	Jun. 13, 2020
Double-Ridged Waveguide Horn	ETS LINDGREN	3117	00034609	May. 26, 2018	May. 25, 2020
Broadband Preamplifier	ETS LINDGREN	3117PA	00225134	Oct. 25, 2018	Oct. 24, 2019
ANTENNA	SCHWARZBECK	VULB9168	D69250	Sep. 28, 2017	Sep. 27, 2019

The results shown in this test report refer only to the sample(s) tested unless otherwise stated and the sample(s) are retained for 30 days only. The document is issued by AGC, this document cannot be reproduced except in full with our prior written permission. The more details and the authenticity of the report will be confirmed at <http://www.agc-cert.com>.

8. PEAK OUTPUT POWER

8.1. MEASUREMENT PROCEDURE

For peak power test:

1. Connect EUT RF output port to the Spectrum Analyzer through an RF attenuator
2. Set the EUT Work on the top, middle and the bottom operation frequency individually.
3. $RBW >$ the 20 dB bandwidth of the emission being measured, $VBW \geq RBW$.
4. Record the maximum power from the Spectrum Analyzer.
5. The maximum peak power shall be less 30dBm.

8.2. TEST SET-UP (BLOCK DIAGRAM OF CONFIGURATION)

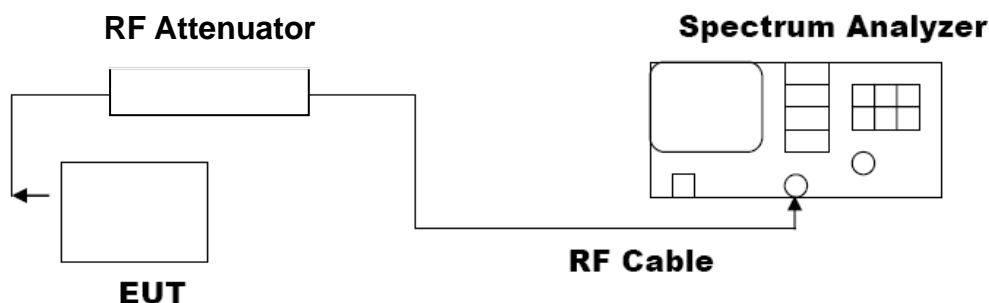

The results shown in this test report refer only to the sample(s) tested unless otherwise stated and the sample(s) are retained for 30 days only. The document is issued by AGC, this document cannot be reproduced except in full with our prior written permission. The more details and the authenticity of the report will be confirmed at <http://www.agc-cert.com>.

8.3. LIMITS AND MEASUREMENT RESULT

Mode	Frequency (GHz)	Peak Power (dBm)	Applicable Limits (dBm)	Pass or Fail
GFSK	2.402	-8.413	30	Pass
	2.441	-8.625	30	Pass
	2.480	-9.007	30	Pass

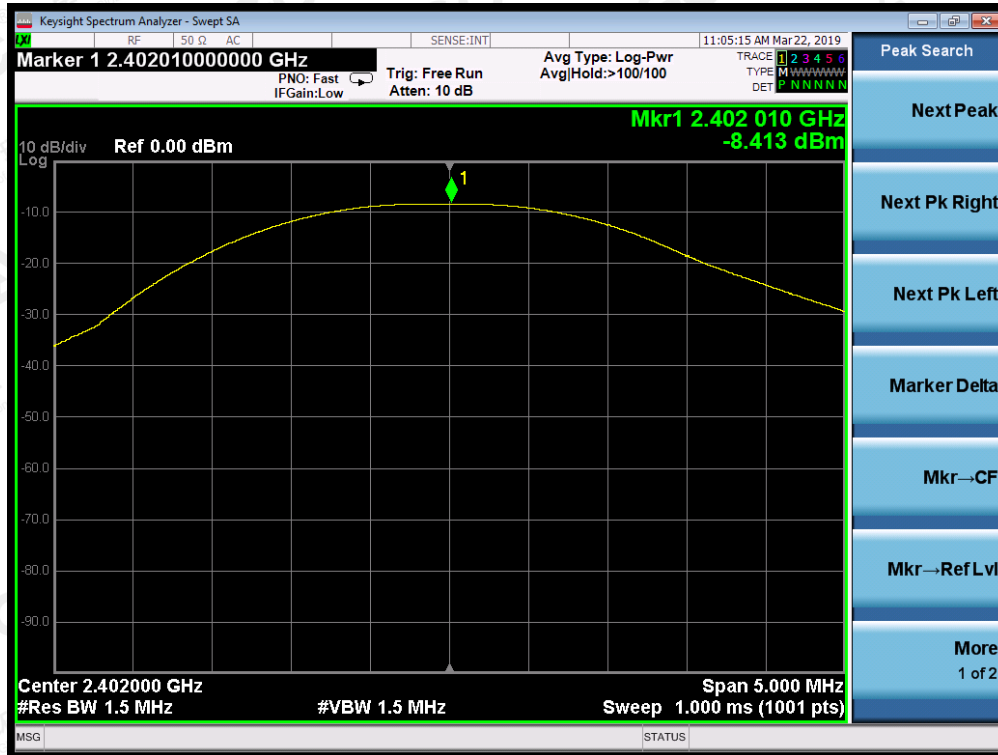

The results shown in this test report refer only to the sample(s) tested unless otherwise stated and the sample(s) are retained for 30 days only. The document is issued by AGC, this document cannot be reproduced except in full with our prior written permission. The more details and the authenticity of the report will be confirmed at <http://www.agc-cert.com>.

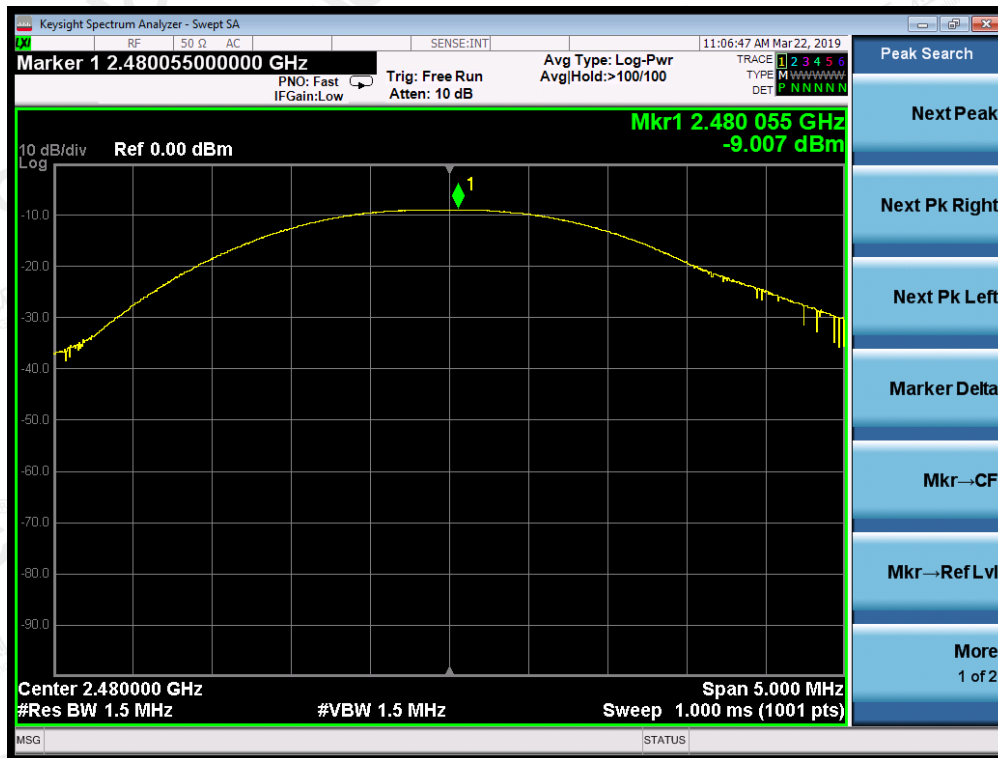
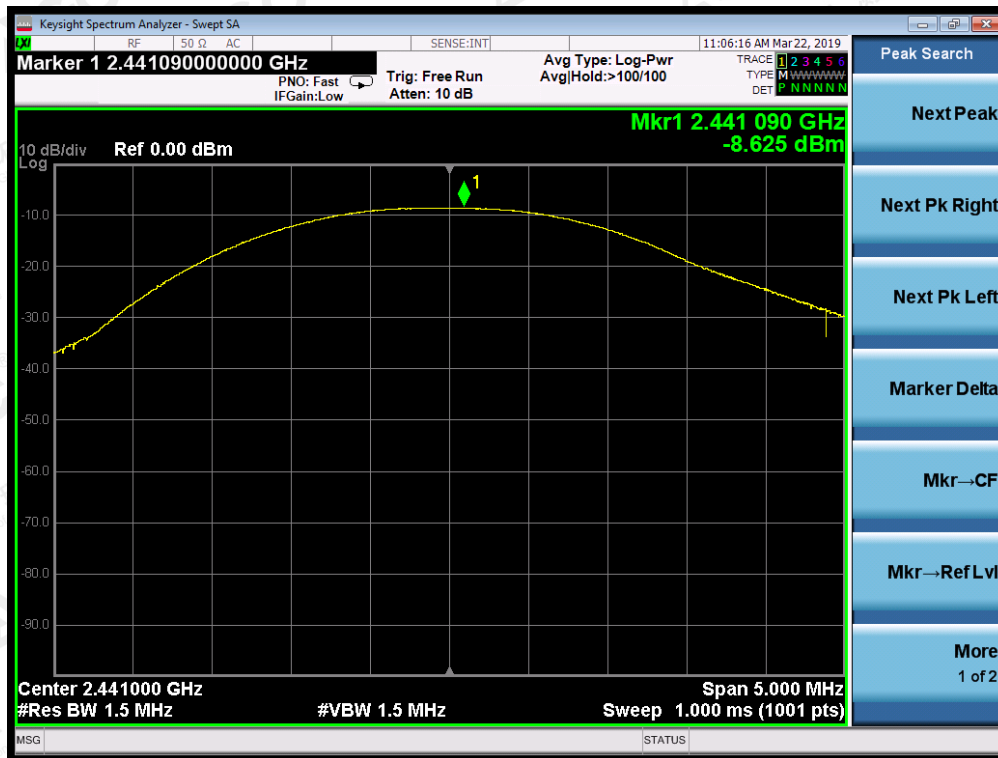

The results shown in this test report refer only to the sample(s) tested unless otherwise stated and the sample(s) are retained for 30 days only. The document is issued by AGC, this document cannot be reproduced except in full with our prior written permission. The more details and the authenticity of the report will be confirmed at <http://www.agc-cert.com>.

Mode	Frequency (GHz)	Peak Power (dBm)	Applicable Limits (dBm)	Pass or Fail
π /4-DQPSK	2.402	-10.169	30	Pass
	2.441	-10.307	30	Pass
	2.480	-11.545	30	Pass

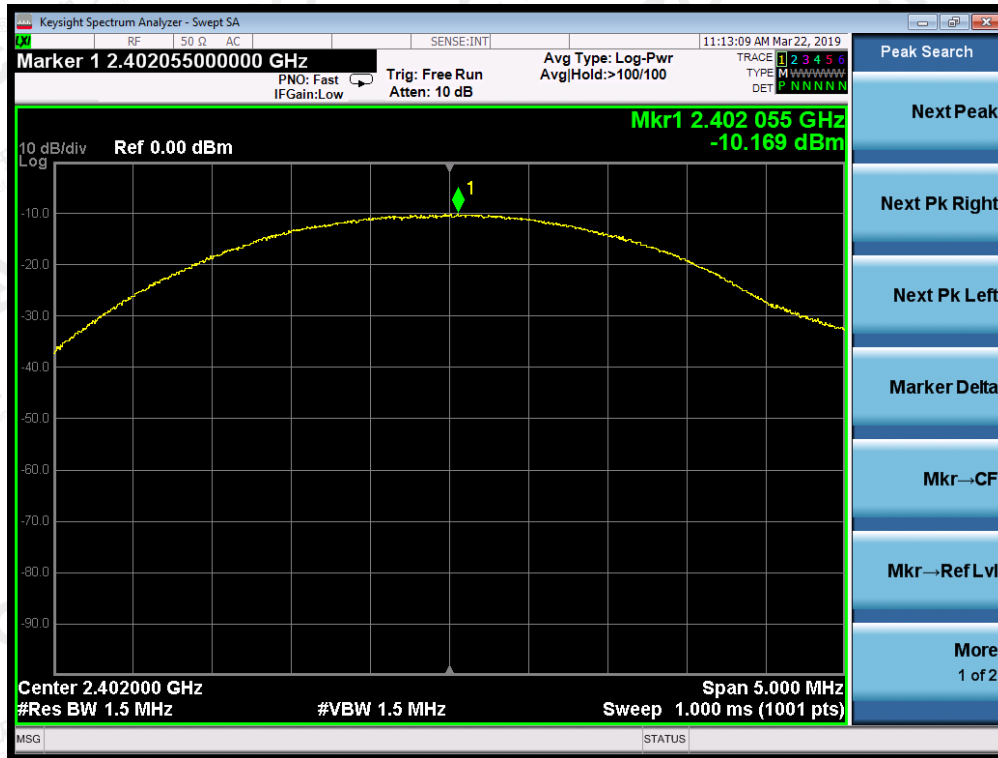

The results shown in this test report refer only to the sample(s) tested unless otherwise stated and the sample(s) are retained for 30 days only. The document is issued by AGC, this document cannot be reproduced except in full with our prior written permission. The more details and the authenticity of the report will be confirmed at <http://www.agc-cert.com>.

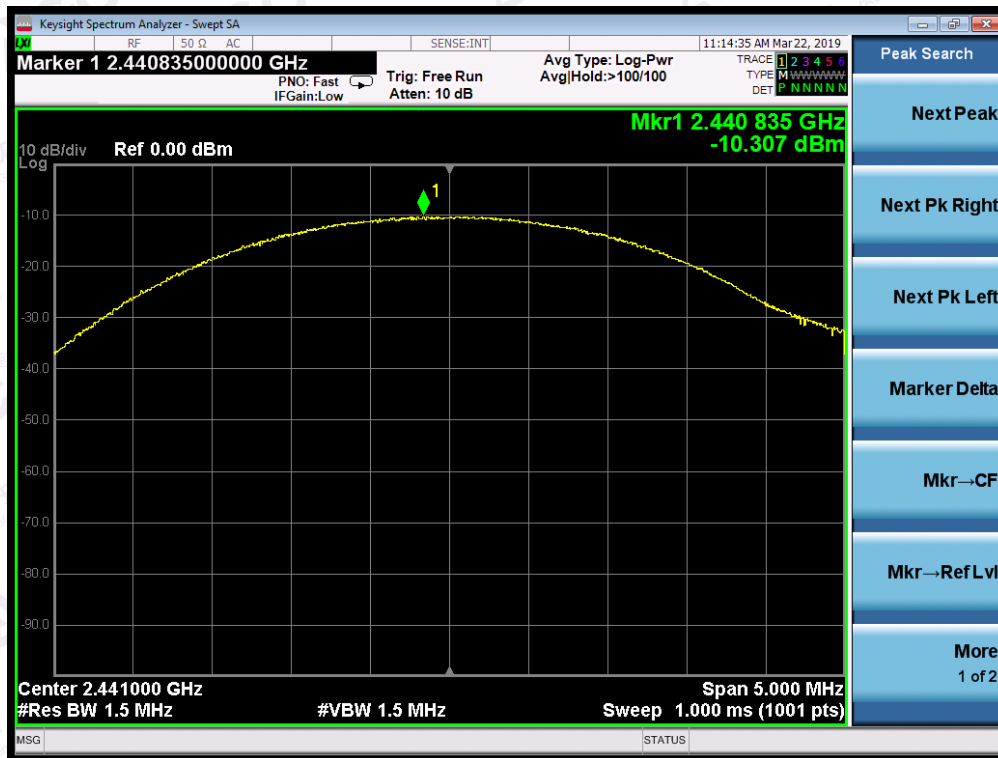

The results shown in this test report refer only to the sample(s) tested unless otherwise stated and the sample(s) are retained for 30 days only. The document is issued by AGC, this document cannot be reproduced except in full with our prior written permission. The more details and the authenticity of the report will be confirmed at <http://www.agc-cert.com>.

Mode	Frequency (GHz)	Peak Power (dBm)	Applicable Limits (dBm)	Pass or Fail
8DQPSK	2.402	-10.661	30	Pass
	2.441	-10.848	30	Pass
	2.480	-11.427	30	Pass



The results shown in this test report refer only to the sample(s) tested unless otherwise stated and the sample(s) are retained for 30 days only. The document is issued by AGC, this document cannot be reproduced except in full with our prior written permission. The more details and the authenticity of the report will be confirmed at <http://www.agc-cert.com>.



The results shown in this test report refer only to the sample(s) tested unless otherwise stated and the sample(s) are retained for 30 days only. The document is issued by AGC, this document cannot be reproduced except in full with our prior written permission. The more details and the authenticity of the report will be confirmed at <http://www.agc-cert.com>.

9. BANDWIDTH

9.1. MEASUREMENT PROCEDURE

1. Connect EUT RF output port to the Spectrum Analyzer through an RF attenuator
2. Set the EUT Work on the top, the middle and the bottom operation frequency individually.
3. Set Span = approximately 2 to 3 times the 20 dB bandwidth, centered on a hoping channel
RBW \geq 1% of the 20 dB bandwidth, VBW \geq 3RBW; Sweep = auto; Detector function = peak
4. Set SPA Trace 1 Max hold, then View.

9.2. TEST SET-UP (BLOCK DIAGRAM OF CONFIGURATION)

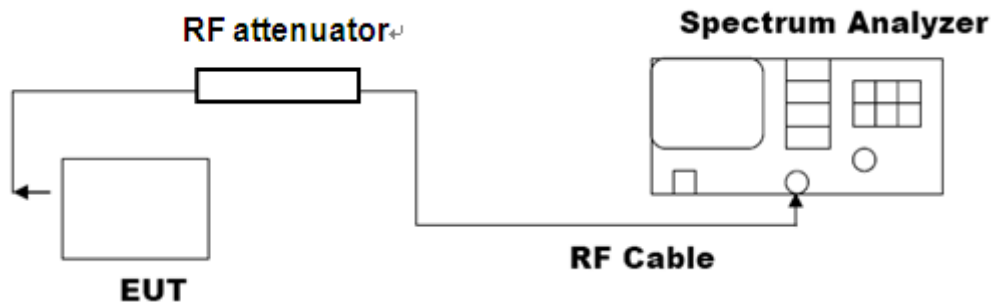

Note: The EUT has been used temporary antenna connector for testing.

9.3. LIMITS AND MEASUREMENT RESULTS

BLUETOOTH 1MBPS LIMITS AND MEASUREMENT RESULT				
Applicable Limits	Measurement Result			
		Test Data (MHz)		Result
		99%OBW (MHz)	-20dB BW(MHz)	
N/A	Low Channel	0.980	1.036	PASS
	Middle Channel	0.981	1.036	PASS
	High Channel	0.983	1.036	PASS

The results shown in this test report refer only to the sample(s) tested unless otherwise stated and the sample(s) are retained for 30 days only. The document is issued by AGC, this document cannot be reproduced except in full with our prior written permission. The more details and the authenticity of the report will be confirmed at <http://www.agc-cert.com>.

TEST PLOT OF BANDWIDTH FOR LOW CHANNEL

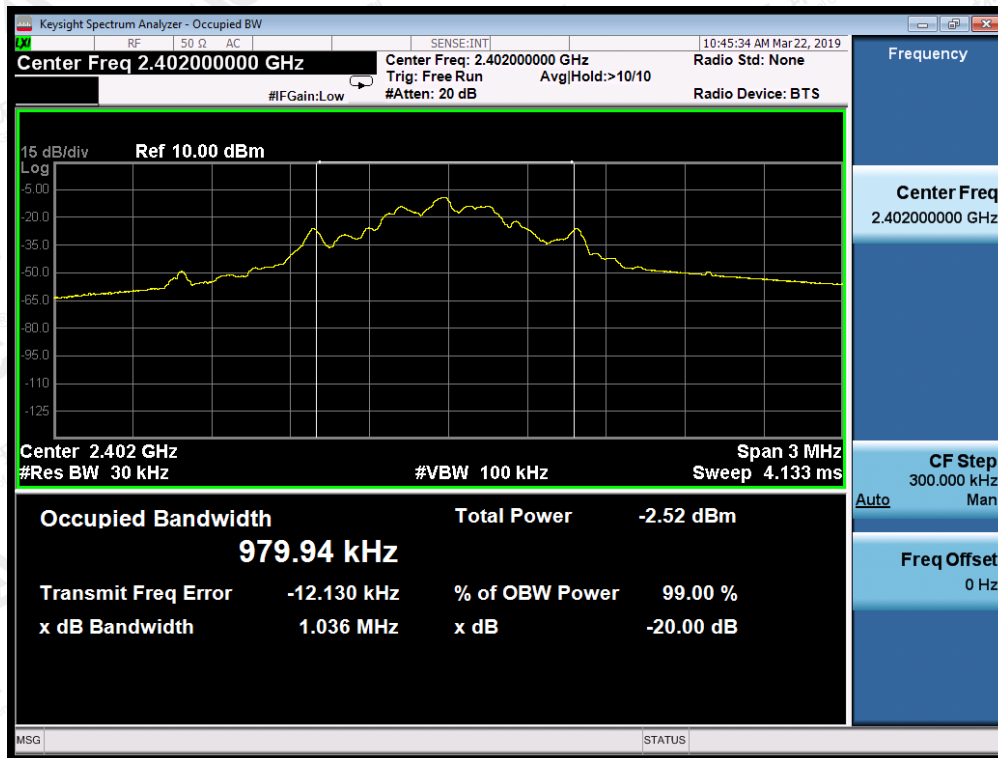

TEST PLOT OF BANDWIDTH FOR MIDDLE CHANNEL

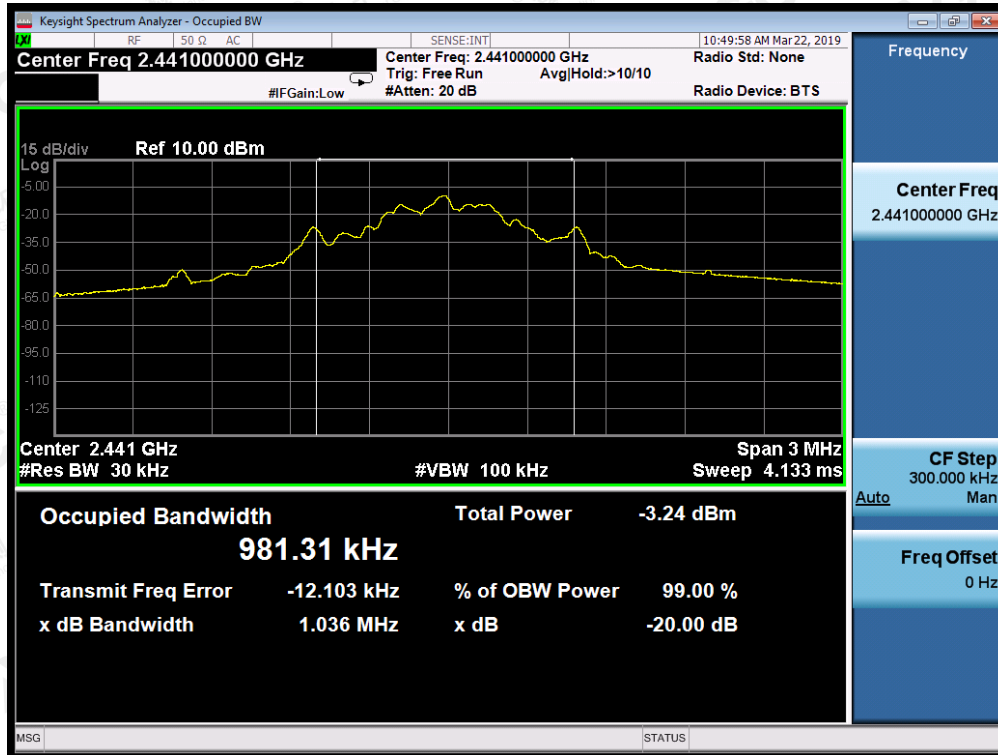

The results shown in this test report refer only to the sample(s) tested unless otherwise stated and the sample(s) are retained for 30 days only. The document is issued by AGC, this document cannot be reproduced except in full with our prior written permission. The more details and the authenticity of the report will be confirmed at <http://www.agc-cert.com>.

TEST PLOT OF BANDWIDTH FOR HIGH CHANNEL

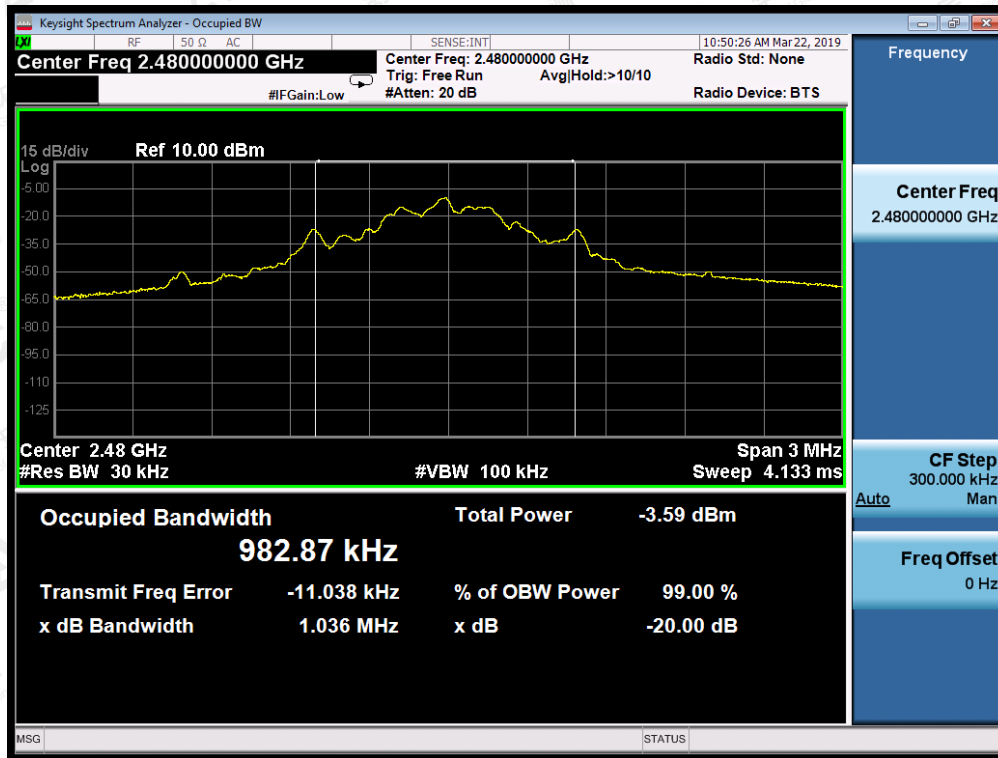

The results shown in this test report refer only to the sample(s) tested unless otherwise stated and the sample(s) are retained for 30 days only. The document is issued by AGC, this document cannot be reproduced except in full with our prior written permission. The more details and the authenticity of the report will be confirmed at <http://www.agc-cert.com>.

BLUETOOTH 2MBPS LIMITS AND MEASUREMENT RESULT				
Applicable Limits	Measurement Result			
	Test Data (MHz)			Result
		99%OBW (MHz)	-20dB BW(MHz)	
N/A	Low Channel	1.0694	1.130	PASS
	Middle Channel	1.0712	1.126	PASS
	High Channel	1.0666	1.124	PASS

TEST PLOT OF BANDWIDTH FOR LOW CHANNEL

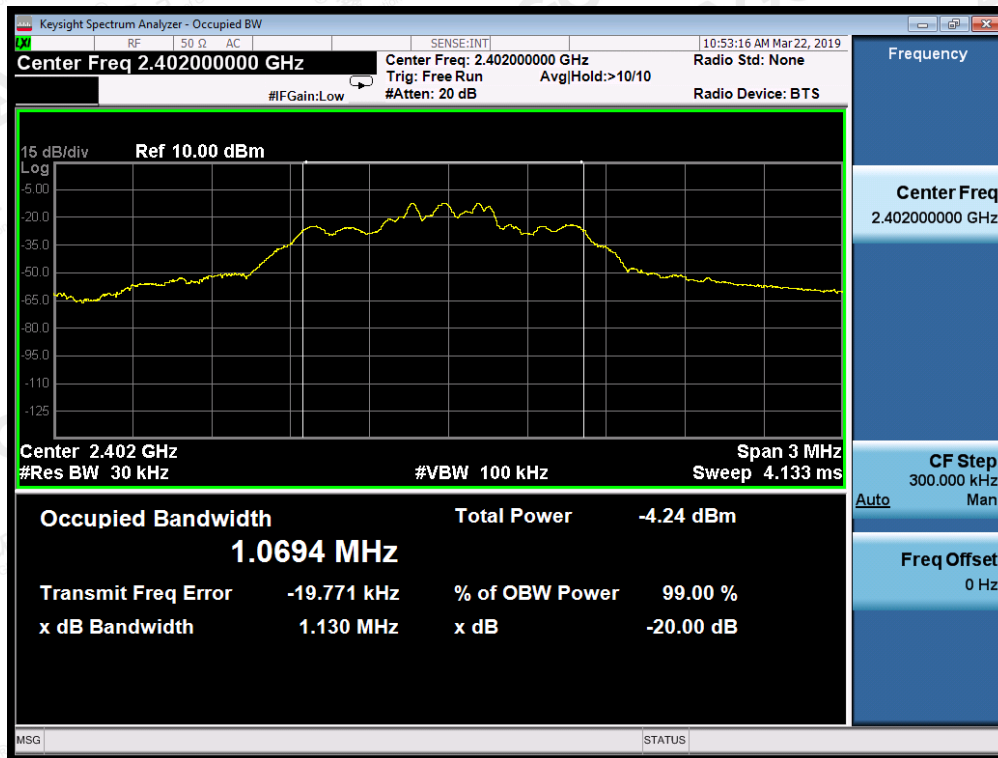

The results shown in this test report refer only to the sample(s) tested unless otherwise stated and the sample(s) are retained for 30 days only. The document is issued by AGC, this document cannot be reproduced except in full with our prior written permission. The more details and the authenticity of the report will be confirmed at <http://www.agc-cert.com>.

TEST PLOT OF BANDWIDTH FOR MIDDLE CHANNEL

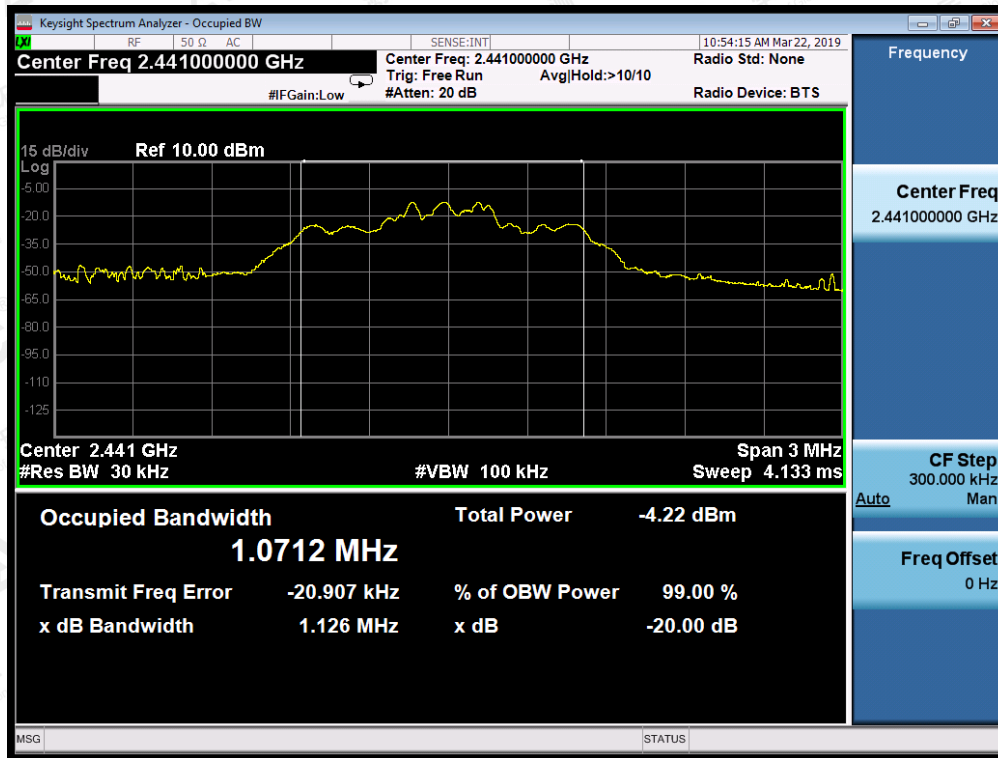

TEST PLOT OF BANDWIDTH FOR HIGH CHANNEL

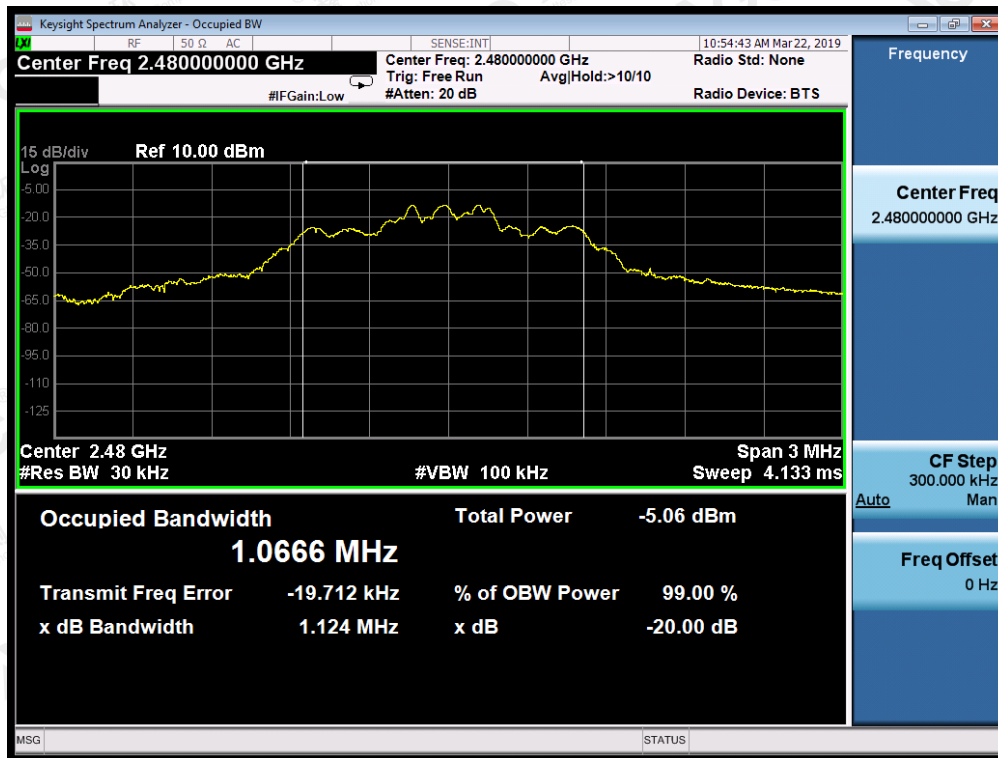

The results shown in this test report refer only to the sample(s) tested unless otherwise stated and the sample(s) are retained for 30 days only. The document is issued by AGC, this document cannot be reproduced except in full with our prior written permission. The more details and the authenticity of the report will be confirmed at <http://www.agc-cert.com>.

BLUETOOTH 3MBPS LIMITS AND MEASUREMENT RESULT				
Applicable Limits	Measurement Result			
	Test Data (MHz)			Result
		99%OBW (MHz)	-20dB BW(MHz)	
N/A	Low Channel	1.1158	1.167	PASS
	Middle Channel	1.1211	1.173	PASS
	High Channel	1.1164	1.172	PASS

TEST PLOT OF BANDWIDTH FOR LOW CHANNEL

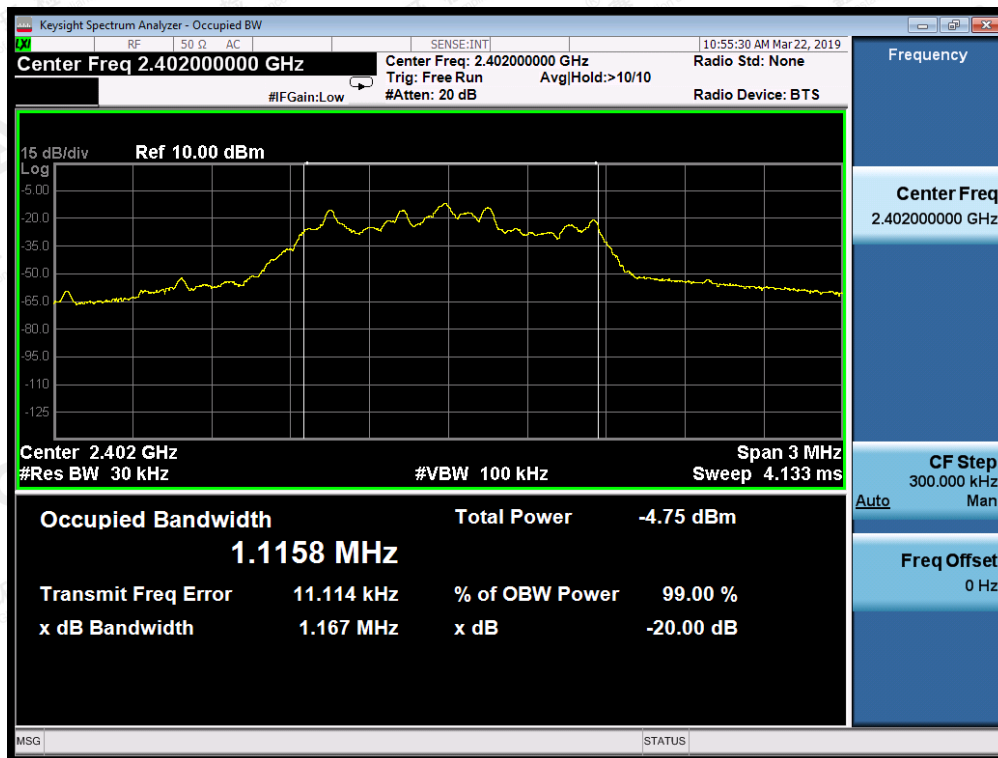

The results shown in this test report refer only to the sample(s) tested unless otherwise stated and the sample(s) are retained for 30 days only. The document is issued by AGC, this document cannot be reproduced except in full with our prior written permission. The more details and the authenticity of the report will be confirmed at <http://www.agc-cert.com>.

TEST PLOT OF BANDWIDTH FOR MIDDLE CHANNEL

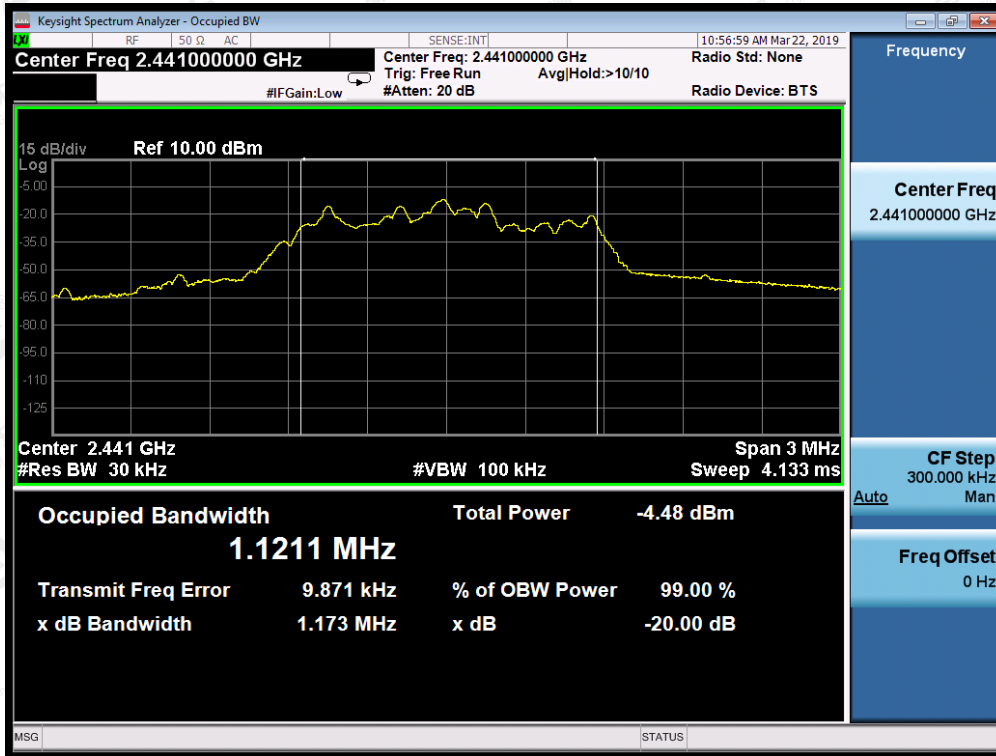

TEST PLOT OF BANDWIDTH FOR HIGH CHANNEL

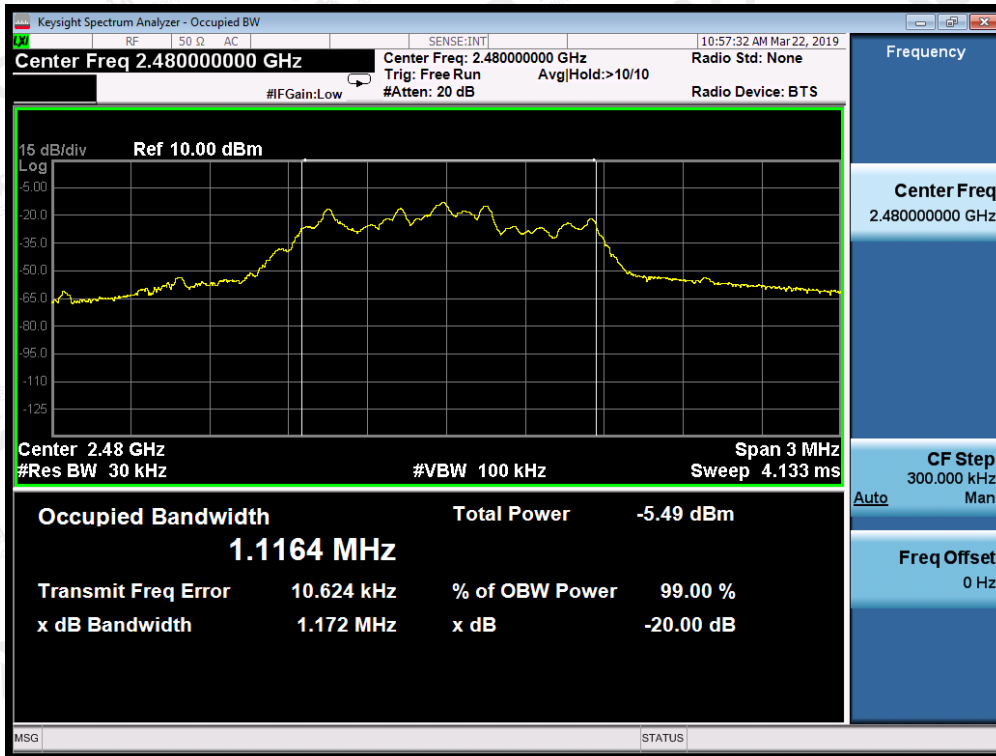

The results shown in this test report refer only to the sample(s) tested unless otherwise stated and the sample(s) are retained for 30 days only. The document is issued by AGC, this document cannot be reproduced except in full with our prior written permission. The more details and the authenticity of the report will be confirmed at <http://www.agc-cert.com>.

10. CONDUCTED SPURIOUS EMISSION

10.1. MEASUREMENT PROCEDURE

1. Connect EUT RF output port to the Spectrum Analyzer through an RF attenuator
2. Set the EUT Work on the top, the Middle and the bottom operation frequency individually.
3. Set the Span = wide enough to capture the peak level of the in-band emission and all spurious emissions from the lowest frequency generated in the EUT up through the 10th harmonic.
RBW = 100 kHz; VBW = 300kHz; Sweep = auto; Detector function = peak.
4. Set SPA Trace 1 Max hold, then View.

10.2. TEST SET-UP (BLOCK DIAGRAM OF CONFIGURATION)

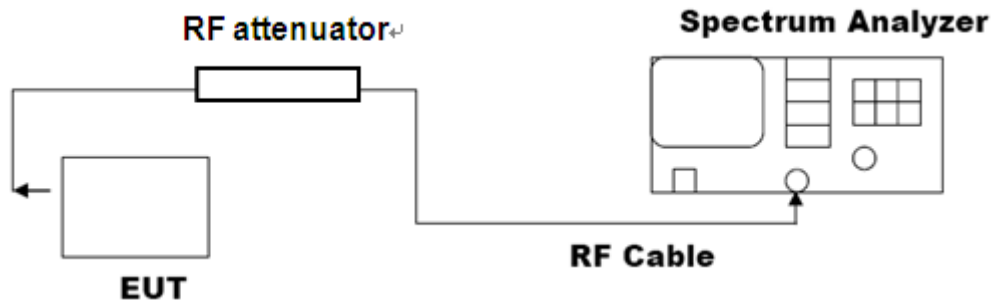

10.3. LIMITS AND MEASUREMENT RESULT

LIMITS AND MEASUREMENT RESULT		
Applicable Limits	Measurement Result	
	Test Data	Result
In any 100 KHz Bandwidth Outside the frequency band in which the spread spectrum intentional radiator is operating, the radio frequency power that is produce by the intentional radiator shall be at least 20 dB below that in 100KHz bandwidth within the band that contains the highest level of the desired power. In addition, radiation emissions which fall in the restricted bands, as defined in §15.205(a), must also comply with the radiated emission limits specified in§15.209(a)	At least -20dBc than the limit Specified on the BOTTOM Channel	PASS
	At least -20dBc than the limit Specified on the TOP Channel	PASS

The results shown in this test report refer only to the sample(s) tested unless otherwise stated and the sample(s) are retained for 30 days only. The document is issued by AGC, this document cannot be reproduced except in full with our prior written permission. The more details and the authenticity of the report will be confirmed at <http://www.agc-cert.com>.

TEST PLOT OF OUT OF BAND EMISSIONS WITH THE WORST CASE
OF $\pi/4$ -DQPSK MODULATION IN LOW CHANNEL

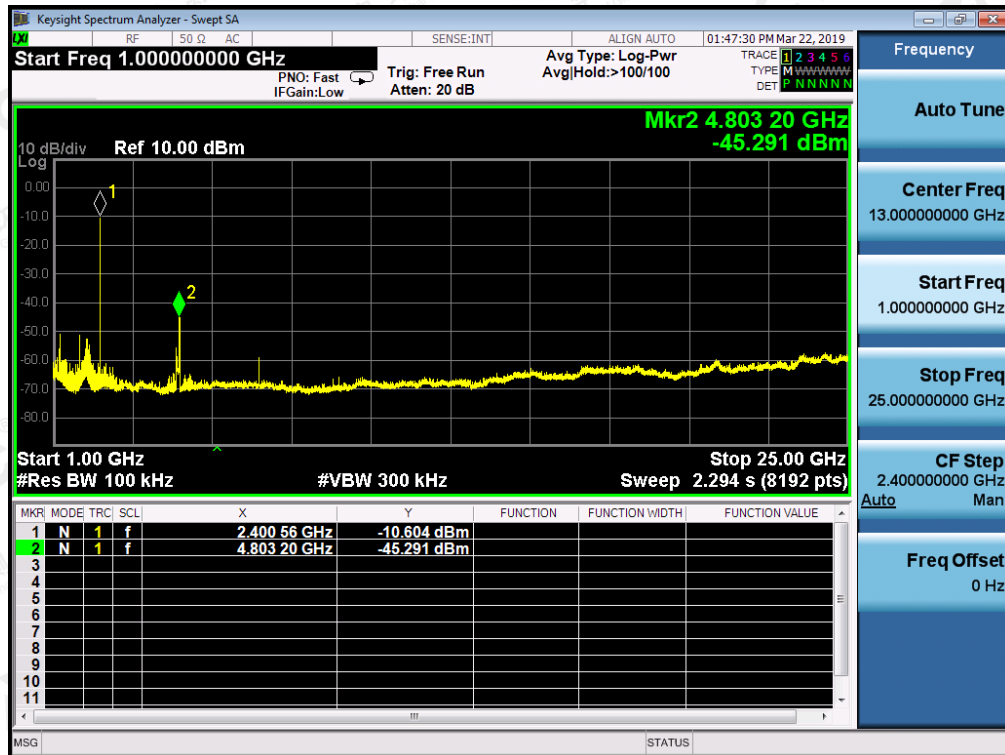
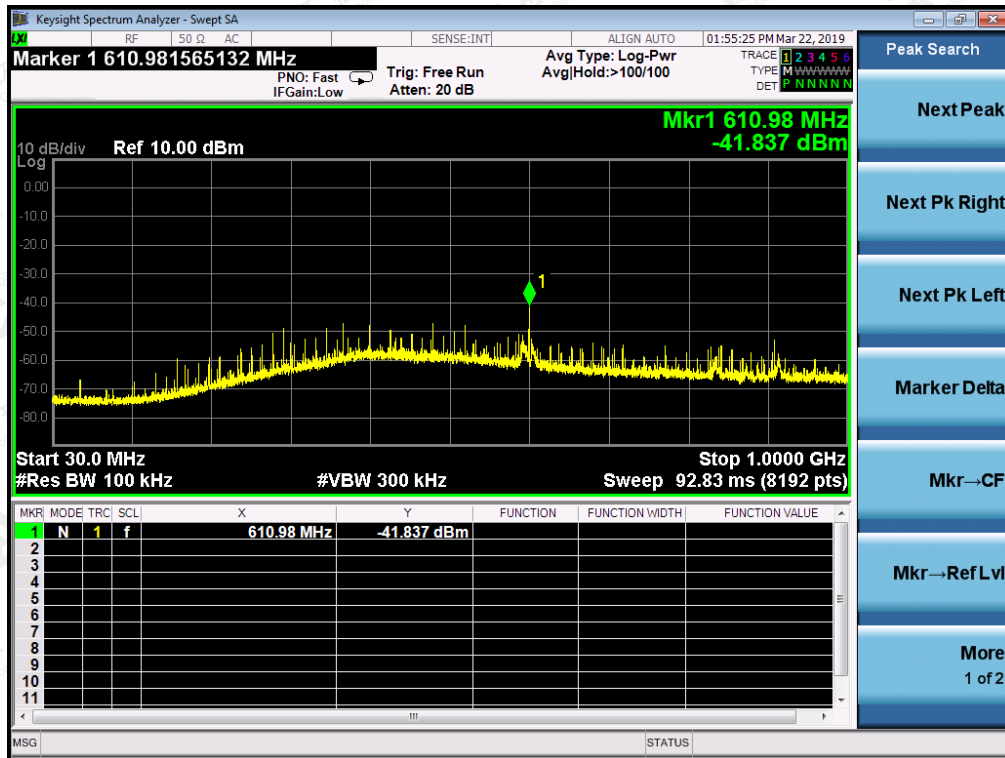

The results shown in this test report refer only to the sample(s) tested unless otherwise stated and the sample(s) are retained for 30 days only. The document is issued by AGC, this document cannot be reproduced except in full with our prior written permission. The more details and the authenticity of the report will be confirmed at <http://www.agc-cert.com>.

TEST PLOT OF OUT OF BAND EMISSIONS
OF $\pi/4$ -DQPSK MODULATION IN MIDDLE CHANNEL

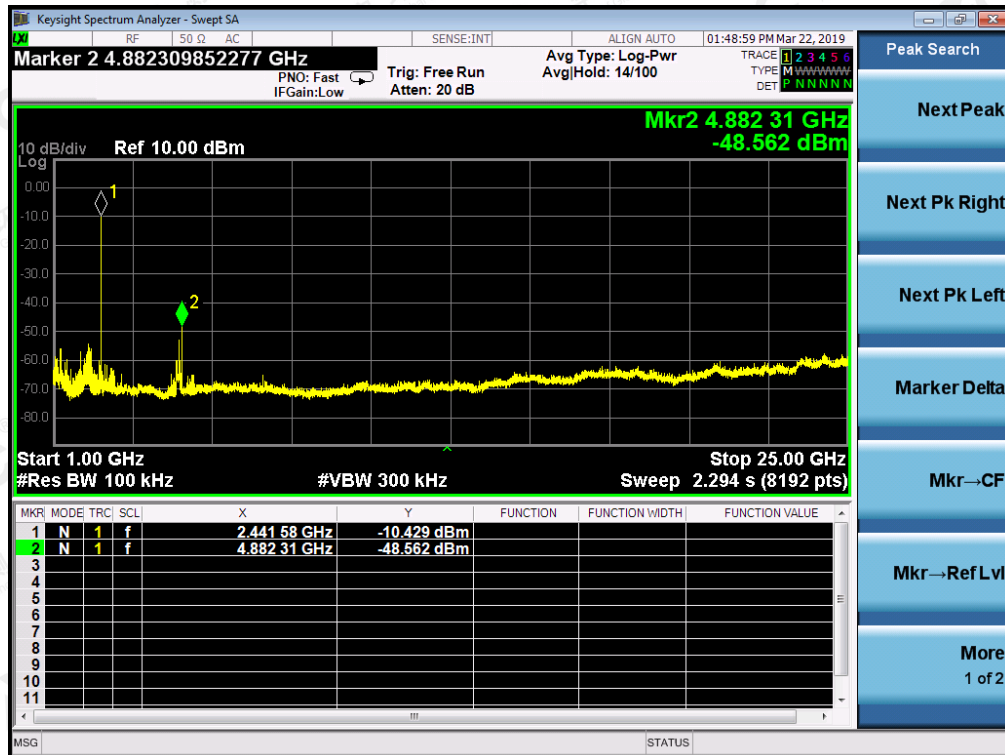
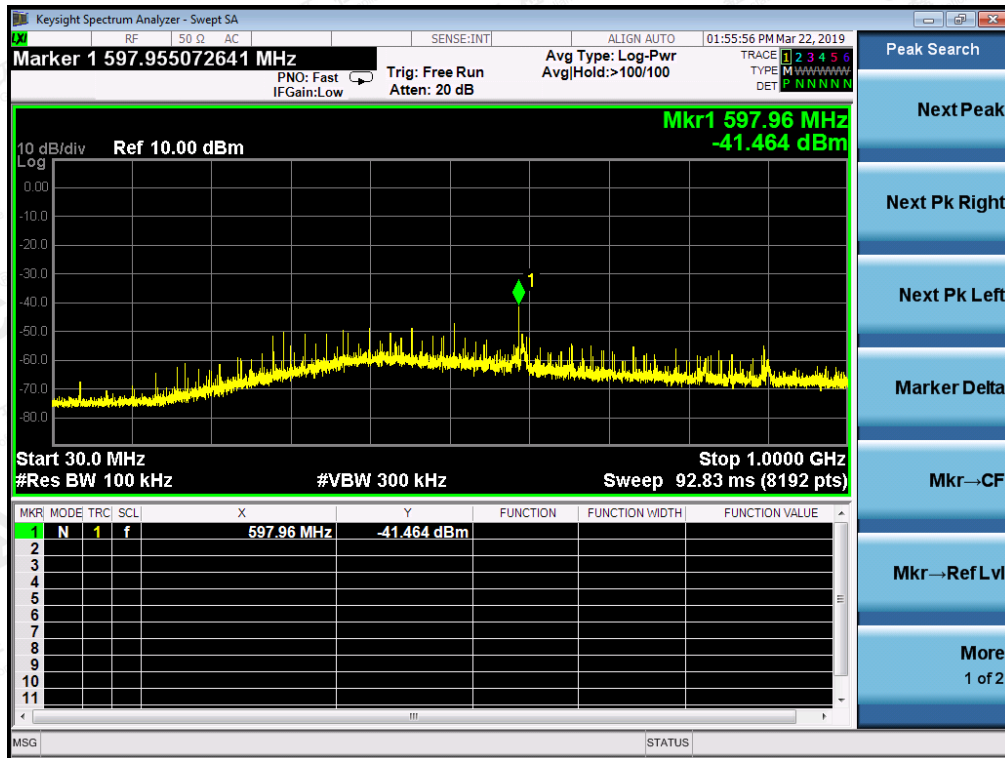

The results shown in this test report refer only to the sample(s) tested unless otherwise stated and the sample(s) are retained for 30 days only. The document is issued by AGC, this document cannot be reproduced except in full with our prior written permission. The more details and the authenticity of the report will be confirmed at <http://www.agc-cert.com>.

TEST PLOT OF OUT OF BAND EMISSIONS
OF $\pi/4$ -DQPSK MODULATION IN HIGH CHANNEL

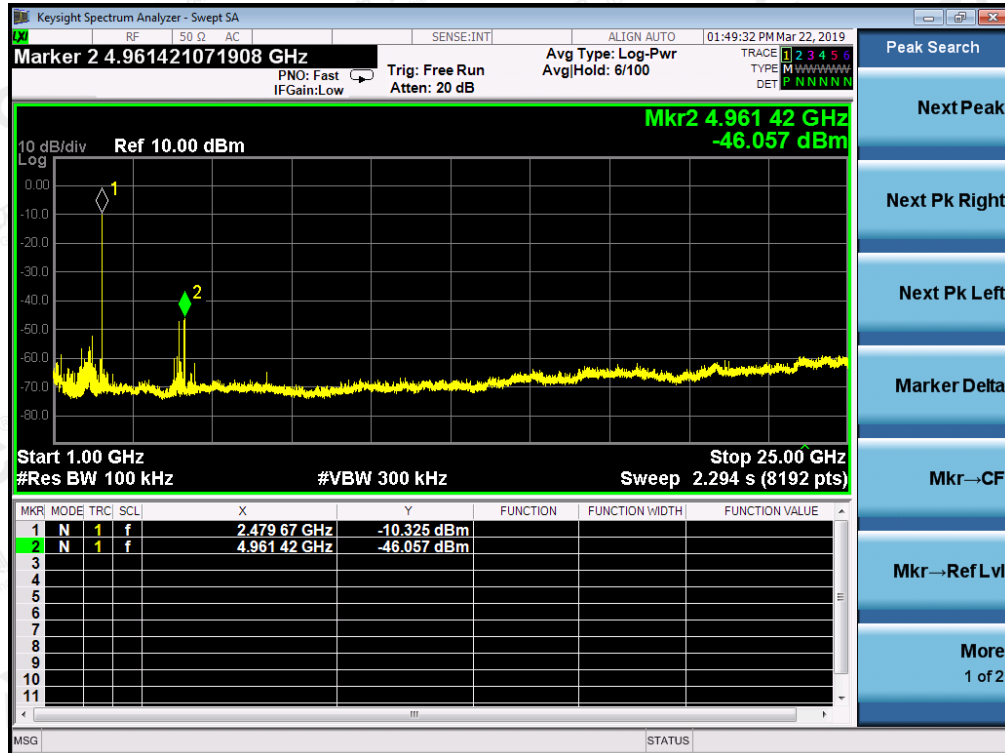
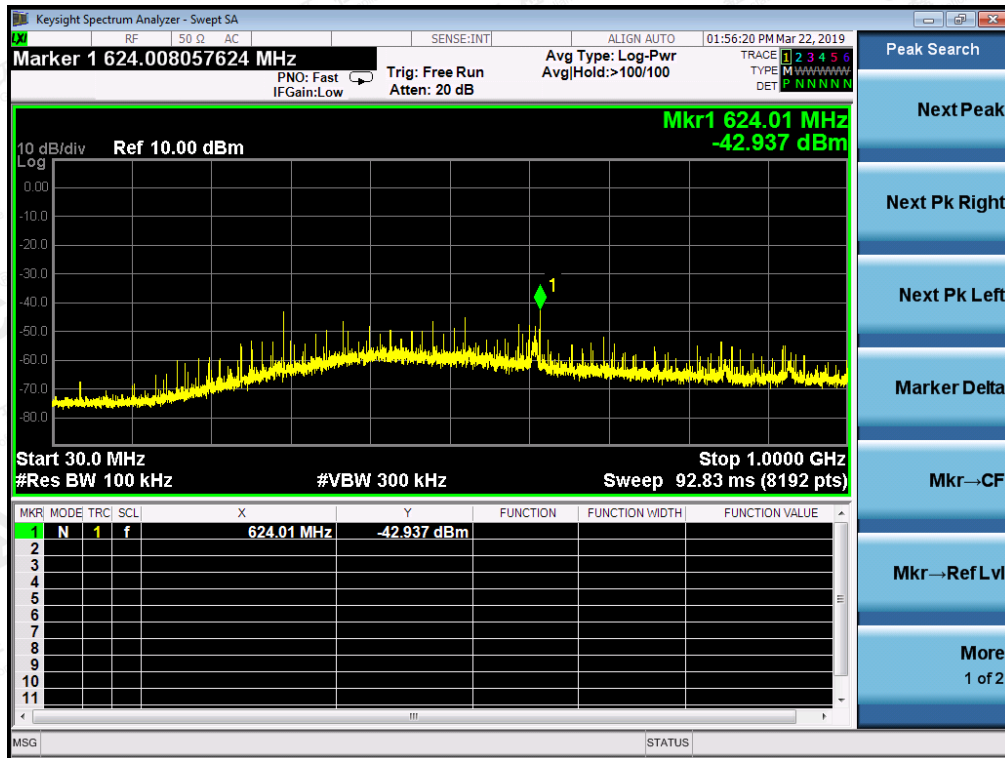

The results shown in this test report refer only to the sample(s) tested unless otherwise stated and the sample(s) are retained for 30 days only. The document is issued by AGC, this document cannot be reproduced except in full with our prior written permission. The more details and the authenticity of the report will be confirmed at <http://www.agc-cert.com>.

11. RADIATED EMISSION

11.1. TEST LIMIT

Frequency (MHz)	Distance Meters	Field Strengths Limit	
		μ V/m	dB(μ V)/m
0.009 ~ 0.490	300	2400/F(kHz)	---
0.490 ~ 1.705	30	24000/F(kHz)	---
1.705 ~ 30	30	30	---
30 ~ 88	3	100	40.0
88 ~ 216	3	150	43.5
216 ~ 960	3	200	46.0
960 ~ 1000	3	500	54.0
Above 1000	3	Other:74.0 dB(μ V)/m (Peak) 54.0 dB(μ V)/m (Average)	

Remark: (1) Emission level dB μ V = 20 log Emission level μ V/m.
 (2) The smaller limit shall apply at the cross point between two frequency bands.
 (3) Distance is the distance in meters between the measuring instrument, antenna and the closest point of any part of the device or system.

11.2. MEASUREMENT PROCEDURE

- The measuring distance of 3m shall be used for measurements. The EUT was placed on the top of a rotating table 0.8 meter above the ground at a 3 meter semi-anechoic chamber. The table was rotated 360 degrees to determine the position of the highest radiation(Below 1GHz)
- The measuring distance of 3m shall used for measurements. The EUT was placed on the top of a rotating table 1.5 meter above the ground at a 3 meter semi-anechoic chamber. The table was rotated 360 degrees to determine the position of the highest radiation(Above 1GHz)
- The height of the test antenna shall vary between 1m to 4m.Both horizontal and vertical polarization Of the antenna are set to make the measurement.
- The initial step in collecting radiated emission data is a receive peak detector mode. Pre-scanning the measurement frequency range. Significant peaks are then marked and then Quasi Peak detector mode re-measured.
- All readings are peak unless otherwise stated QP in column of Note. Peak denoted that the Peak reading compliance with the QP limits and then QP Mode measurement didn't perform(Below 1GHz)
- All readings are Peak mode value unless otherwise stated AVG in column of Note. If the Peak mode measured value compliance with the Peak limits and lower than AVG Limits, the EUT shall be deemed to meet Peak&AVG limits and then only Peak mode was measured, but AVG mode didn't perform.(Above 1GHz)

The results shown in this test report refer only to the sample(s) tested unless otherwise stated and the sample(s) are retained for 30 days only. The document is issued by AGC, this document cannot be reproduced except in full with our prior written permission. The more details and the authenticity of the report will be confirmed at <http://www.agc-cert.com>.

The following table is the setting of spectrum analyzer and receiver.

Spectrum Parameter	Setting
Start ~Stop Frequency	9KHz~150KHz/RB 200Hz for QP
Start ~Stop Frequency	150KHz~30MHz/RB 9KHz for QP
Start ~Stop Frequency	30MHz~1000MHz/RB 120KHz for QP
Start ~Stop Frequency	1GHz~26.5GHz RBW 1MHz/ VBW 3MHz for Peak, RBW 1MHz/ VBW 10Hz for Average

Receiver Parameter	Setting
Start ~Stop Frequency	9KHz~150KHz/RB 200Hz for QP
Start ~Stop Frequency	150KHz~30MHz/RB 9KHz for QP
Start ~Stop Frequency	30MHz~1000MHz/RB 120KHz for QP

The results shown in this test report refer only to the sample(s) tested unless otherwise stated and the sample(s) are retained for 30 days only. The document is issued by AGC, this document cannot be reproduced except in full with our prior written permission. The more details and the authenticity of the report will be confirmed at <http://www.agc-cert.com>.

11.3. TEST SETUP

RADIATED EMISSION TEST SETUP BELOW 30MHz

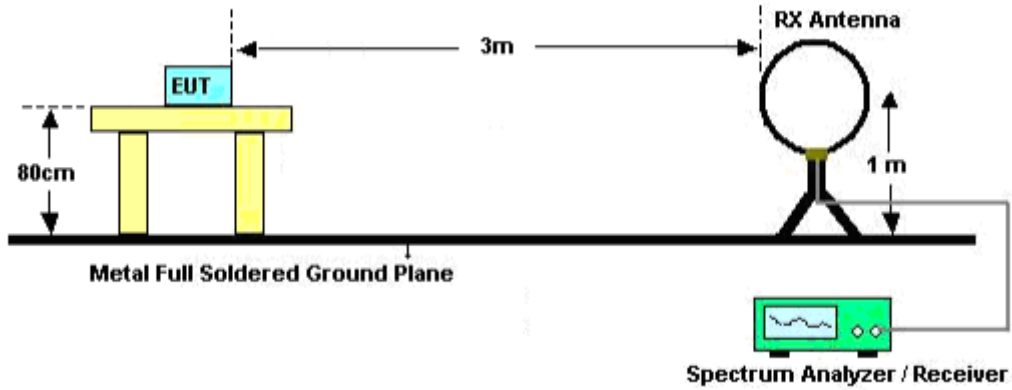

RADIATED EMISSION TEST SETUP 30MHz-1000MHz

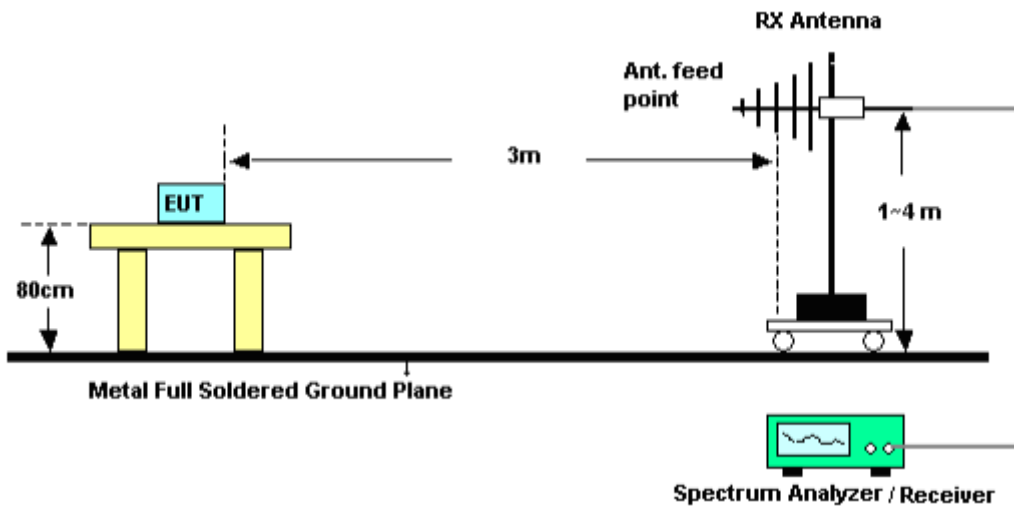

The results shown in this test report refer only to the sample(s) tested unless otherwise stated and the sample(s) are retained for 30 days only. The document is issued by AGC, this document cannot be reproduced except in full with our prior written permission. The more details and the authenticity of the report will be confirmed at <http://www.agc-cert.com>.

RADIATED EMISSION TEST SETUP ABOVE 1000MHz

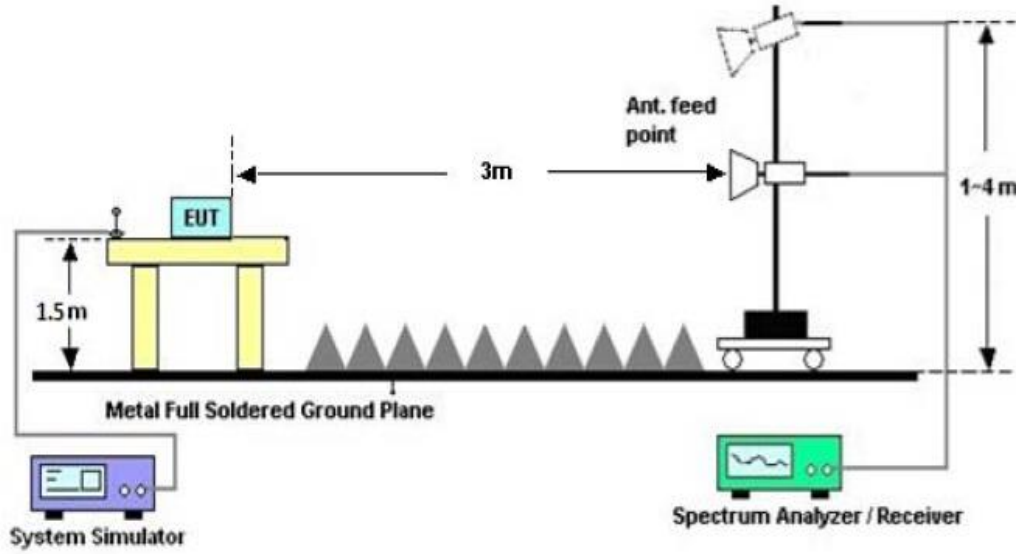

The results shown in this test report refer only to the sample(s) tested unless otherwise stated and the sample(s) are retained for 30 days only. The document is issued by AGC, this document cannot be reproduced except in full with our prior written permission. The more details and the authenticity of the report will be confirmed at <http://www.agc-cert.com>.

11.4. TEST RESULT

(Worst Modulation: $\pi/4$ -DQPSK)

RADIATED EMISSION BR/EDR OW 30MHz

No emission found between lowest internal used/generated frequencies to 30MHz.

RADIATED EMISSION BR/EDR OW 1GHz

RADIATED EMISSION TEST- (30MHz-1GHz)-LOW CHANNEL-HORIZONTAL

66.9 dBuV/m

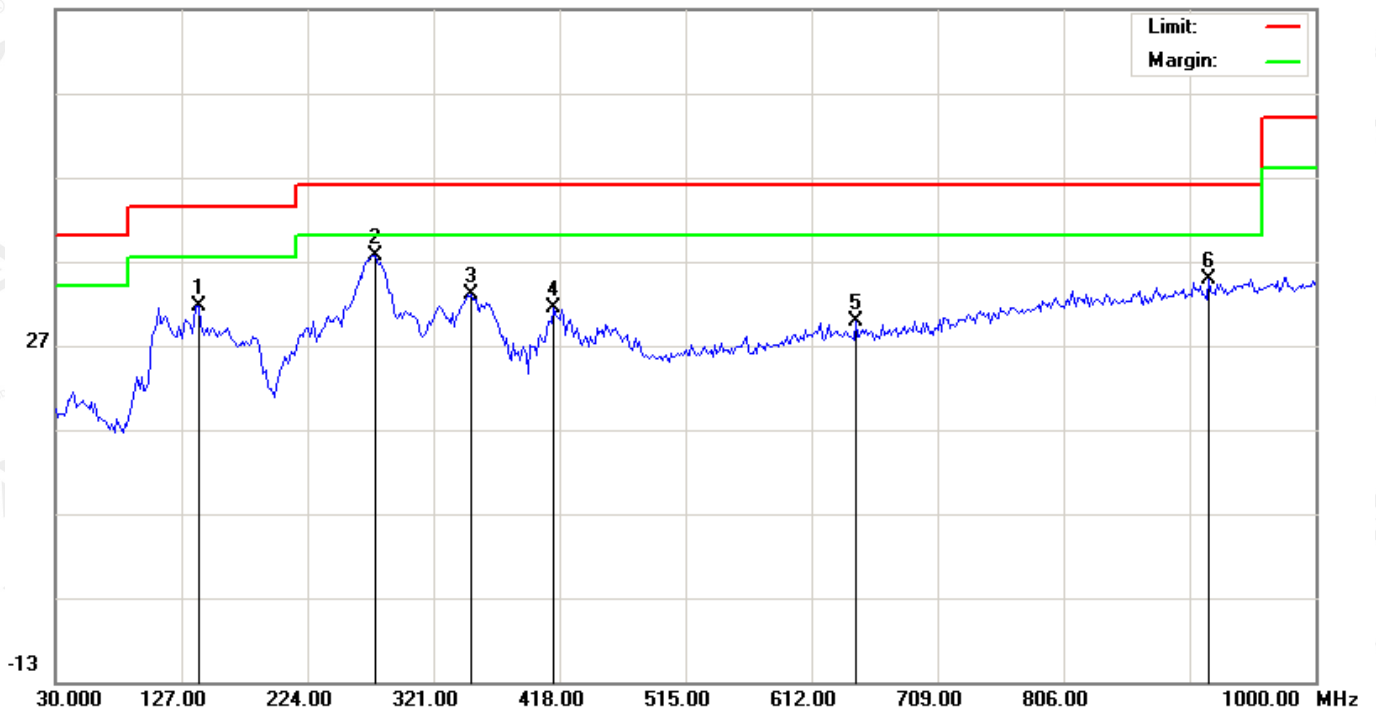

No.	Mk	Freq.	Reading	Factor	Measurement	Limit	Over	Detector	Antenna	Table	Comment
		MHz	dBuV	dB/m	dBuV/m	dBuV/m	dB		Height	Degree	
									cm	degree	
1		139.9333	12.35	19.23	31.58	43.50	-11.92	peak			
2	*	275.7333	18.05	19.59	37.64	46.00	-8.36	peak			
3		350.1000	11.85	21.23	33.08	46.00	-12.92	peak			
4		413.1500	8.20	23.24	31.44	46.00	-14.56	peak			
5		645.9500	2.21	27.50	29.71	46.00	-16.29	peak			
6		917.5500	2.99	31.85	34.84	46.00	-11.16	peak			

RESULT: PASS

The results shown in this test report refer only to the sample(s) tested unless otherwise stated and the sample(s) are retained for 30 days only. The document is issued by AGC, this document cannot be reproduced except in full with our prior written permission. The more details and the authenticity of the report will be confirmed at <http://www.agc-cert.com>.

RADIATED EMISSION TEST- (30MHz-1GHz)-LOW CHANNEL -VERTICAL

66.9 dBuV/m

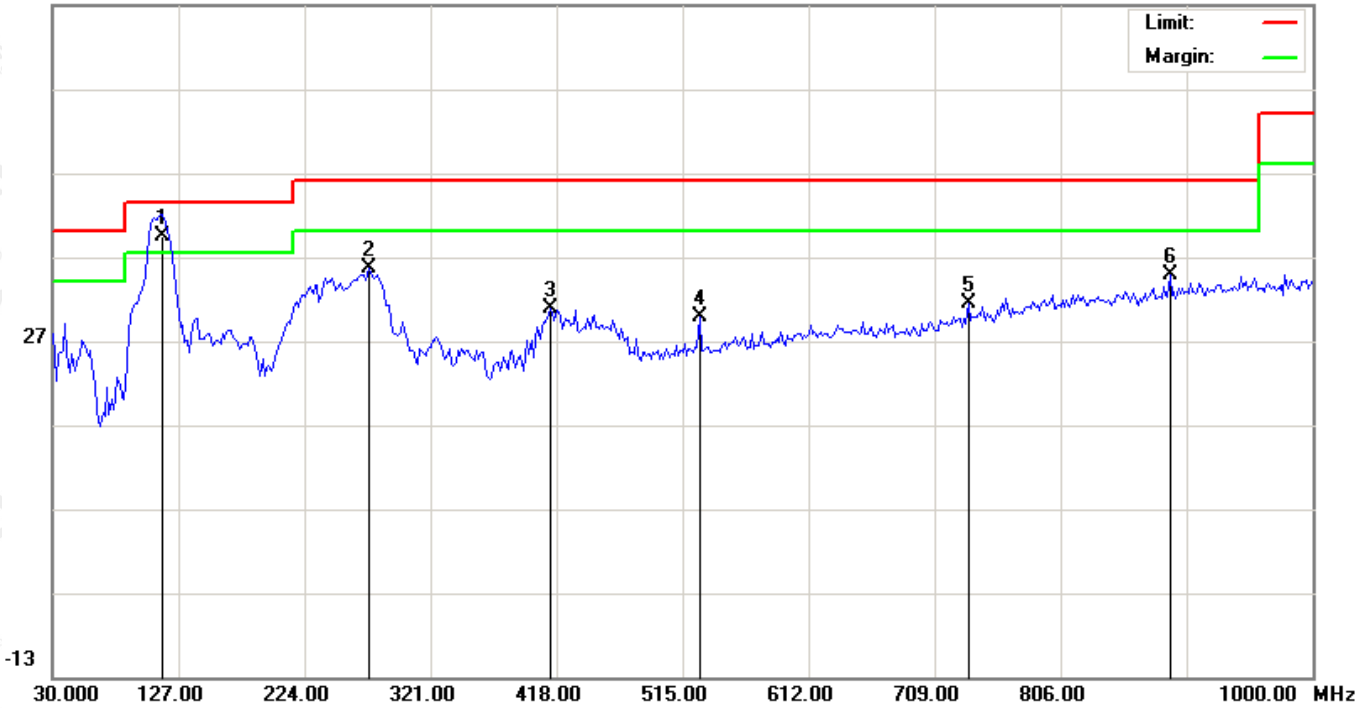

No.	Mk	Freq.	Reading	Factor	Measurement	Limit	Over	Detector	Antenna Height	Table Degree	Comment
		MHz	dBuV	dB/m	dBuV/m	dBuV/m	dB		cm	degree	
1	*	114.0667	22.10	17.39	39.49	43.50	-4.01	QP			
2		274.1167	16.10	19.46	35.56	46.00	-10.44	peak			
3		413.1500	7.50	23.24	30.74	46.00	-15.26	peak			
4		527.9333	4.18	25.54	29.72	46.00	-16.28	peak			
5		734.8667	2.44	28.94	31.38	46.00	-14.62	peak			
6		890.0667	3.15	31.57	34.72	46.00	-11.28	peak			

RESULT: PASS

Note: 1. Factor=Antenna Factor + Cable loss, Margin=Measurement-Limit.

2. The "Factor" value can be calculated automatically by software of measurement system.

3. All modes were tested, and only the data of worst case mode 4 was recorded in this report.

The results shown in this test report refer only to the sample(s) tested unless otherwise stated and the sample(s) are retained for 30 days only. The document is issued by AGC, this document cannot be reproduced except in full with our prior written permission. The more details and the authenticity of the report will be confirmed at <http://www.agc-cert.com>.

RADIATED EMISSION ABOVE 1GHZ FOR BR/EDR

EUT :	Multifunctional FM Radio Speaker	Model Name. :	CR3037A
Temperature :	20 °C	Relative Humidity :	48%
Pressure :	1010 hPa	Test Voltage :	AC 120V/60 Hz
Test Mode :	Mode 4	Polarization :	Horizontal

Frequency (MHz)	Meter Reading (dBμV)	Factor (dB)	Emission Level (dBμV/m)	Limits (dBμV/m)	Margin (dB)	Value Type
4804.026	54.34	7.12	61.46	74	-12.54	peak
4804.026	34.82	7.12	41.94	54	-12.06	AVG
7206.039	40.07	9.84	49.91	74	-24.09	peak
7206.039	30.12	9.84	39.96	54	-14.04	AVG

Remark:

Factor = Antenna Factor + Cable Loss – Pre-amplifier.

EUT :	Multifunctional FM Radio Speaker	Model Name. :	CR3037A
Temperature :	20 °C	Relative Humidity :	48%
Pressure :	1010 hPa	Test Voltage :	AC 120V/60 Hz
Test Mode :	Mode 4	Polarization :	Vertical

Frequency (MHz)	Meter Reading (dBμV)	Factor (dB)	Emission Level (dBμV/m)	Limits (dBμV/m)	Margin (dB)	Value Type
4804.026	53.63	7.12	60.75	74	-13.25	peak
4804.026	34.26	7.12	41.38	54	-12.62	AVG
7206.039	39.03	9.84	48.87	74	-25.13	peak
7206.039	29.89	9.84	39.73	54	-14.27	AVG

Remark:

Factor = Antenna Factor + Cable Loss – Pre-amplifier.

The results shown in this test report refer only to the sample(s) tested unless otherwise stated and the sample(s) are retained for 30 days only. The document is issued by AGC, this document cannot be reproduced except in full with our prior written permission. The more details and the authenticity of the report will be confirmed at <http://www.agc-cert.com>.

EUT :	Multifunctional FM Radio Speaker	Model Name. :	CR3037A
Temperature :	20 °C	Relative Humidity :	48%
Pressure :	1010 hPa	Test Voltage :	AC 120V/60 Hz
Test Mode :	Mode 5	Polarization :	Horizontal

Frequency (MHz)	Meter Reading (dBμV)	Factor (dB)	Emission Level (dBμV/m)	Limits (dBμV/m)	Margin (dB)	Value Type
4882.032	55.17	7.12	62.29	74	-11.71	peak
4882.032	35.39	7.12	42.51	54	-11.49	AVG
7323.048	41.2	9.84	51.04	74	-22.96	peak
7323.048	30.76	9.84	40.60	54	-13.40	AVG

Remark:

Factor = Antenna Factor + Cable Loss – Pre-amplifier.

EUT :	Multifunctional FM Radio Speaker	Model Name. :	CR3037A
Temperature :	20 °C	Relative Humidity :	48%
Pressure :	1010 hPa	Test Voltage :	AC 120V/60 Hz
Test Mode :	Mode 5	Polarization :	Vertical

Frequency (MHz)	Meter Reading (dBμV)	Factor (dB)	Emission Level (dBμV/m)	Limits (dBμV/m)	Margin (dB)	Value Type
4882.032	54.99	7.12	62.11	74	-11.89	peak
4882.032	34.55	7.12	41.67	54	-12.33	AVG
7323.048	39.95	9.84	49.79	74	-24.21	peak
7323.048	29.88	9.84	39.72	54	-14.28	AVG

Remark:

Factor = Antenna Factor + Cable Loss – Pre-amplifier.

The results shown in this test report refer only to the sample(s) tested unless otherwise stated and the sample(s) are retained for 30 days only. The document is issued by AGC, this document cannot be reproduced except in full with our prior written permission. The more details and the authenticity of the report will be confirmed at <http://www.agc-cert.com>.

EUT :	Multifunctional FM Radio Speaker	Model Name. :	CR3037A
Temperature :	20 °C	Relative Humidity :	48%
Pressure :	1010 hPa	Test Voltage :	AC 120V/60 Hz
Test Mode :	Mode 6	Polarization :	Horizontal

Frequency (MHz)	Meter Reading (dBμV)	Factor (dB)	Emission Level (dBμV/m)	Limits (dBμV/m)	Margin (dB)	Value Type
4960.042	54.73	7.12	61.85	74	-12.15	peak
4960.042	34.82	7.12	41.94	54	-12.06	AVG
7440.063	40.32	9.84	50.16	74	-23.84	peak
7440.063	30.86	9.84	40.70	54	-13.3	AVG

Remark:

Factor = Antenna Factor + Cable Loss – Pre-amplifier.

EUT :	Multifunctional FM Radio Speaker	Model Name. :	CR3037A
Temperature :	20 °C	Relative Humidity :	48%
Pressure :	1010 hPa	Test Voltage :	AC 120V/60 Hz
Test Mode :	Mode 6	Polarization :	Vertical

Frequency (MHz)	Meter Reading (dBμV)	Factor (dB)	Emission Level (dBμV/m)	Limits (dBμV/m)	Margin (dB)	Value Type
4960.042	52.74	7.12	59.86	74	-14.14	peak
4960.042	33.56	7.12	40.68	54	-13.32	AVG
7440.063	39.68	9.84	49.52	74	-24.48	peak
7440.063	30.18	9.84	40.02	54	-13.98	AVG

Remark:

Factor = Antenna Factor + Cable Loss – Pre-amplifier.

Note: Other emissions from 8G to 25 GHz are considered as ambient noise. No recording in the test report.
 Factor=Antenna Factor + Cable loss - Amplifier gain, Margin=Measurement-Limit.
 The "Factor" value can be calculated automatically by software of measurement system.
 The π/4-DQPSK modulation was the worst case and only the data of worst recorded in this report.

The results shown in this test report refer only to the sample(s) tested unless otherwise stated and the sample(s) are retained for 30 days only. The document is issued by AGC, this document cannot be reproduced except in full with our prior written permission. The more details and the authenticity of the report will be confirmed at <http://www.agc-cert.com>.