

V1
FINAL
FOR PRINT

NS-BBTCD01_13-0025_MAN_V1_ENG.fm Page 1 Monday, February 18, 2013 9:37 AM

User Guide
CD Boombox with Bluetooth

NS-BBTCD01

INSIGNIA™

Before using your new product, please read these instructions to prevent any damage.



Insignia NS-BBTCD01 CD Boombox with Bluetooth

Contents

Introduction	3
Important Safety Instructions.....	3
Features	5
Top.....	5
Back.....	7
LCD	8
Package contents.....	9
Setting up your boombox.....	9
Connecting the AC power adapter.....	9
Installing batteries	10
Connecting headphones.....	11
Using a Bluetooth device	12
Turning your boombox on or off.....	11
Selecting the audio source	12
Selecting the sound mode	12
Using a Bluetooth device	12
Pairing with a Bluetooth device.....	12
Playing audio from a Bluetooth device.....	13
Using the radio	14
Playing the radio.....	14
Setting radio station presets.....	14
Using the CD player	15
Playable CDs.....	15
Playing a CD	15
Repeating a track or CD	16
Playing tracks in random order	17
Playing audio from a connected audio device.....	17
Troubleshooting	18
General.....	18
Radio	18
CD player.....	18
Bluetooth device.....	19
Maintaining.....	20
Specifications	21
Legal notices.....	21
90-day limited warranty - Insignia	22

Introduction

Congratulations on your purchase of a high-quality Insignia product. Your NS-BBTCD01 represents the state of the art in CD boombox and Bluetooth design and is designed for reliable and trouble-free performance.

Important Safety Instructions



This symbol indicates that dangerous voltage constituting a risk of electric shock is present within your boombox.



This symbol indicates that there are important operating and maintenance instructions in the literature accompanying your boombox.

WARNING

Warning

Your boombox employs a laser system.

Use of controls, adjustments, or the performance of procedures other than those specified may result in hazardous radiation exposure.

Visible laser radiation is present when open and interlocks defeated. **Do not stare into the beam.**



- 1 Read these instructions.
- 2 Keep these instructions.
- 3 Heed all warnings.
- 4 Follow all instructions.
- 5 Do not use this apparatus near water.
- 6 Clean only with dry cloth.
- 7 Do not block any ventilation openings. Install in accordance with the manufacturer's instructions.

INSIGNIA™

Insignia NS-BBTCD01 CD Boombox with Bluetooth

- 8 Do not install near any heat sources such as radiators, heat registers, stoves, or other apparatus (including amplifiers) that produce heat.
- 9 Do not defeat the safety purpose of the polarized or grounding-type plug. A polarized plug has two blades with one wider than the other. A grounding type plug has two blades and a third grounding prong. The wide blade or the third prong are provided for your safety. If the provided plug does not fit into your outlet, consult an electrician for replacement of the obsolete outlet.
- 10 Protect the power cord from being walked on or pinched particularly at plugs, convenience receptacles, and the point where they exit from the apparatus.
- 11 Only use attachments/accessories specified by the manufacturer.
- 12 Use only with the cart, stand, tripod, bracket, or table specified by the manufacturer, or sold with the apparatus. When a cart is used, use caution when moving the cart/apparatus combination to avoid injury from tip-over.
- 13 Unplug this apparatus during lightning storms or when unused for long periods of time.
- 14 Refer all servicing to qualified service personnel. Servicing is required when the apparatus has been damaged in any way, such as power-supply cord or plug is damaged, liquid has been spilled or objects have fallen into the apparatus, the apparatus has been exposed to rain or moisture, does not operate normally, or has been dropped.
- 15 To reduce the risk of fire or electric shock, do not expose this device to rain, moisture, dripping, or splashing, and no objects filled with liquids, The wall plug is the disconnecting device. The plug must remain readily operable.
- 16 Batteries should not be exposed to excessive heat such as sunshine, fire, or the like.

**Caution**

Danger of explosion if battery is incorrectly replaced. Replace only with the same or equivalent type.

Surge protectors

We recommend that you use a surge protector when you use the AC adapter with your boombox. Lightning and power surges are not covered under the warranty for your boombox.

Features

Top

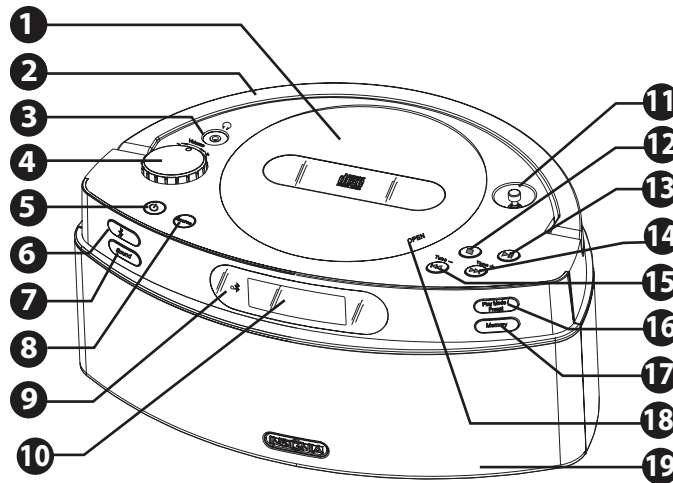

#	Item	Description
1	CD compartment door	Place a CD in this compartment.
2	Handle	Hold to lift and carry your boombox.
3	🎧 (headphone jack)	Plug headphones into this jack. When headphone are plugged in, your boombox speaker is muted.
4	Volume +/- knob	Rotate to increase or decrease the volume.
5	⏻ (power button)	Press turn your boombox on or off.
6	📶 (Bluetooth pairing) button	Press to starting pairing your boombox with a Bluetooth device. See "Pairing with a Bluetooth device" on page 12.
7	Sound button	Press to select the sound mode. See "Selecting the sound mode" on page 12.
8	Source button	Press to select the audio source. See "Selecting the audio source" on page 12.
9	📶 Bluetooth LED	Lights when your boombox is pairing with a Bluetooth device. See "Pairing with a Bluetooth device" on page 12.
10	LCD	Displays status information. See "LCD" on page 8.
11	FM antenna	Extend the antenna to improve FM reception. You may need to move the antenna to get the best reception.
12	■ (stop) button	In CD mode, press to stop playback.
13	▶ (play/pause) button	In CD or Bluetooth mode, press to start or pause playback. When you press this button again, playback resumes where it stopped.

INSIGNIA™

Insignia NS-BBTCD01 CD Boombox with Bluetooth

#	Item	Description
14	Tune +/▶▶ (skip forward) button	In radio mode, press to tune to next higher radio frequency. Press and hold for two seconds to automatically tune to the next higher radio station. In CD or Bluetooth mode, press to go to the next track or song. Press and hold fast forward.
15	Tune – ◀◀ (skip backward) button	In radio mode, press to tune to next lower radio frequency. Press and hold for two seconds to automatically tune to the next lower radio station. In CD mode: <ul style="list-style-type: none"> • If the current track has played for less than two seconds, press to go to the previous track. • If the current track has played for more than two seconds, press to go to beginning of the current track. • Press and hold to fast reverse. In Bluetooth mode, the Bluetooth device may determine how this button works.
16	Play Mode/Preset button	In CD mode, press to select the play mode. You can select: <ul style="list-style-type: none"> • Rep 1—Repeats the current track. See “Repeating a track or CD” on page 16. • Rep ALL—Repeats all the tracks on the CD. See “Repeating a track or CD” on page 16. • RND—Plays CD tracks in random order. See “Playing tracks in random order” on page 17. In radio mode, press to select a radio station preset. See “Setting radio station presets” on page 14.
17	Memory button	When setting radio station presets, press to save a preset. See “Setting radio station presets” on page 14.
18	OPEN	Press to open or close the CD compartment door.
19	Speaker grill	Covers your boombox speakers.

Insignia NS-BBTCD01 CD Boombox with Bluetooth



Back

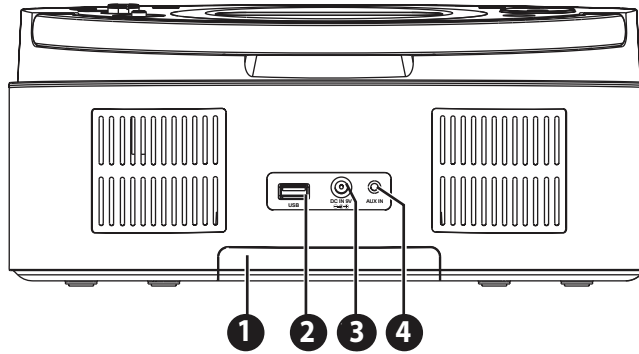



#	Item	Description
1	Battery compartment	Open to insert or replace batteries. See "Installing batteries" on page 10.
2	USB jack	Connect a USB device to this jack to charge the USB device's battery. The USB cable is not included.
3	DC In jack	Connect the AC power adapter to the jack. See "Connecting the AC power adapter" on page 9.
4	AUX In jack	Connect an audio device to this jack to play audio files stored on the device. See "Playing audio from a connected audio device" on page 17.

INSIGNIA™

Insignia NS-BBTCD01 CD Boombox with Bluetooth

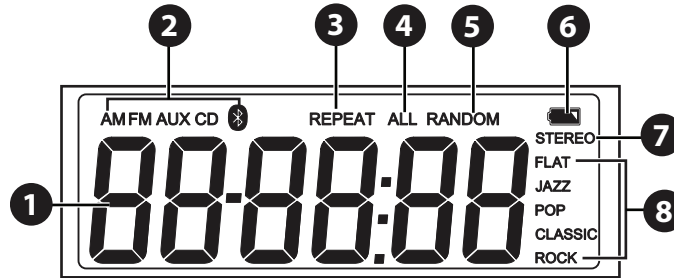
LCD



#	Item	Description
1	Status display	Displays the current function, for example: <ul style="list-style-type: none"> In radio mode, displays the current radio frequency or when scanning for a station shows the frequencies as they are scanned. In preset mode, displays the current preset number. In auxiliary (AUX) mode, displays "AU." In CD mode, displays the current track number or "NO DISC" if there is no CD in the disc tray. The information displayed varies depending on what function the radio is performing.
2	Audio source	Indicates the selected audio source. AM —AM radio FM —FM radio AUX —A device connected to the AUX In jack CD —CD player  —Paired Bluetooth device See "Selecting the audio source" on page 12.
3	REPEAT	Indicates your player is repeating the current track or song. See "Repeating a track or CD" on page 16.
4	ALL	Indicates your player is repeating the entire CD. See "Repeating a track or CD" on page 16.
5	RANDOM	Indicates your player is playing tracks or songs in random order. See "Playing tracks in random order" on page 17.
6	Battery level	Lights when your battery level is low.
7	STEREO	When you are tuning to a radio station, STEREO appears when your boombox detects a strong signal.
8	Sound mode	Indicates the selected sound mode. See "Selecting the sound mode" on page 12.

Package contents

- CD Boombox with Bluetooth
- AC power adapter
- *Quick Setup Guide*
- *User Guide*

Setting up your boombox

Connecting the AC power adapter

To connect the AC power adapter:

- 1 Insert the small connector on the end of the AC power adapter into the **DC IN** jack on the back of your boombox.

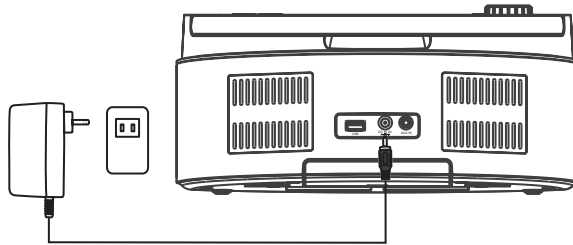

- 2 Plug the other end of the AC power adapter into a power outlet.

Cautions

- To protect your boombox during thunderstorms, unplug the AC power adapter from the AC power outlet.
- Only use the supplied AC power adapter. Using a different adapter could damage your boombox.

Notes

- The batteries are automatically bypassed when the AC power adapter is used.
- Unplug the AC power adapter when not in use.

INSIGNIA™

Insignia NS-BBTCD01 CD Boombox with Bluetooth

Installing batteries

Note

- The batteries are automatically bypassed when the AC power adapter is used.
- When the  appears on the LCD, you need to change the batteries.

To install batteries:

- 1 Turn your boombox over so the bottom is facing up, then press down on the **OPEN ▼** and slide the battery compartment cover off the battery compartment.
- 2 Insert six type C batteries (no included) into the battery compartment. Make sure that the + and – symbols on the batteries align with the + and – symbols inside the battery compartment.

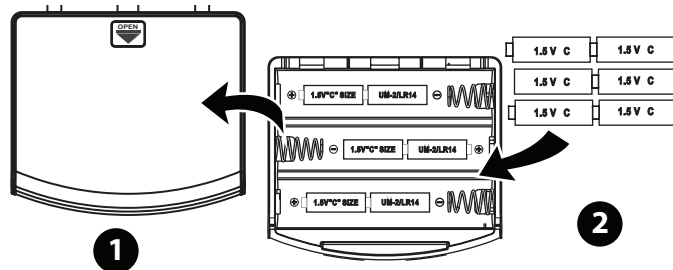

- 3 Insert the tabs on the battery compartment cover into the slots on the battery compartment, then slide the cover into place. Set your boombox upright.

Cautions

- Use only type C batteries.
- Make sure that you insert the batteries correctly. If you insert the batteries incorrectly, your boombox may be damaged.
- Do not heat, open, or short-circuit batteries.
- Do not throw batteries into a fire.
- Do not mix different types of batteries together (for example, alkaline, rechargeable, or carbon zinc).
- Do not mix old and new batteries.
- Do not try to recharge batteries not intended to be recharged because they can overheat and rupture.

Connecting headphones

Warning

Listening to music with the volume too loud can damage your hearing. Before you connect headphones, turn down the volume. After you put on the headphones, gradually increase the volume to a comfortable level.

To connect headphones:

- Plug the headphones into the headphone jack on the top of your boombox.

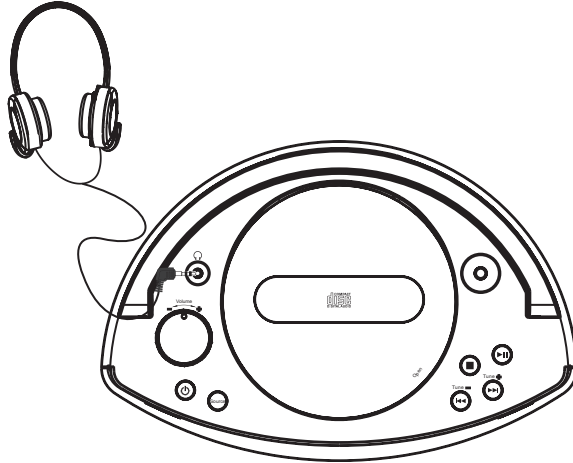

Using your boombox

Turning your boombox on or off

To turn your boombox on or off:

- Press the  (power) button.

INSIGNIA™

Insignia NS-BBTCD01 CD Boombox with Bluetooth

Selecting the audio source

To select the audio source:

- Press the **Source** button one or more times until the audio source you want appears on the LCD. You can select:
 - **AM**—AM radio band
 - **FM**—FM radio band
 - **CD**—CD player
 - —Paired Bluetooth device
 - **AUX**—Device connected to the AUX jack.

Selecting the sound mode

You can select a sound (equalizer) mode to automatically adjust the sound for the type music you are playing.



To select the sound mode:

- Press the **Sound** button one or more times until the sound mode you want appears on the LCD. You can select **JAZZ**, **POP**, **CLASSIC**, **ROCK**, or **FLAT**.

Using a Bluetooth device

Pairing with a Bluetooth device

To pair with a Bluetooth device:

- 1 On your boombox, press the **Source** button one or more times until the  indicator appears on the LCD.
- 2 Make sure that your Bluetooth device is turned on and within 33 feet (10 meters) of your boombox.
- 3 On your boombox, press the  (Bluetooth pairing) button. Your boombox enters pairing mode, and the Bluetooth icon blinks rapidly on the LCD. Your boombox remains in pairing mode for 30 minutes or until it pairs with a Bluetooth device.
- 4 On the Bluetooth device, start pairing mode, then select **NS-BBTCD01**. See the instructions that came with the device for information pairing.
- 5 If you are asked for a password, enter **0000**. When pairing is complete, the Bluetooth icon on your boombox's LCD lights solid.
- 6 To disconnect from the paired Bluetooth device, press and hold the  (Bluetooth pairing) button on your boombox for three seconds. Your boombox disconnects from the Bluetooth device and enters pairing mode again.

- 7 To reconnect your boombox to a paired device, on the Bluetooth device search for and select **NS-BBTCD01** while the boombox is in pairing mode.

Note

Your boombox can store pairing information for eight devices. When your boombox is in Bluetooth mode, it automatically reconnects to the last paired device when the device is turned on, in Bluetooth mode, and within 33 feet (10 meters) of your boombox.

If you want to reconnect with another previously paired device, make sure the device is within range, turn it on, and put it in pairing mode. Then press the  (Bluetooth pairing) button. Your boombox searches for the pairing information and pairs with the device.

Playing audio from a Bluetooth device

To play audio from a Bluetooth device:

- 1 On your boombox, press the **Source** button one or more times until the  indicator appears on the LCD.
- 2 Make sure that the Bluetooth device has been paired to your boombox. See "Pairing with a Bluetooth device" on page 12.
- 3 To control playback from the Bluetooth device, on your boombox:
 - Press the **▶||** (play/pause) button to start or pause playback. Your boombox plays the audio files on the Bluetooth device.
 - Rotate the volume control knob to increase or decrease the volume.
 - Press the **Tune +/▶▶** (skip forward) button to go to the next song.
 - If the current song has played less than two seconds, press the **Tune -/◀◀** (skip back) button to go to the previous song. If the song has played more than two seconds, press this button to go the beginning of the song. Press and hold this button to fast reverse.

Note

The Bluetooth device may determine how the **Tune -/◀◀** works.

INSIGNIA™

Insignia NS-BBTCD01 CD Boombox with Bluetooth

Using the radio

Playing the radio

To play the radio:

- 1 Press the **⏻** (power) button to turn on your boombox.
- 2 Press the **Source** button one or more times until **AM** or **FM** appears on the LCD.
- 3 Press the **Tune +/▶▶** (skip forward) or **Tune -/◀◀** (skip back) button to go to the next higher or lower radio frequency. When your boombox detects a strong FM signal, **STEREO** appears on the LCD.
OR
Press and hold the **Tune +/▶▶** (skip forward) or **Tune -/◀◀** (skip back) button for two second to automatically tune to the next higher or lower radio station.
- 4 Rotate the volume control knob to increase or decrease the volume.
- 5 Press the **⏻** (power) button to turn off your boombox.

Note

To improve reception:

- For FM reception, raise and extended the FM antenna. You may have to reposition the antenna for best reception.
- For AM reception, turn your boombox slightly until reception improves.
- If the power AC adapter is connected to your boombox and a power outlet, move the boombox away from the power outlet.

Setting radio station presets

Your boombox can store 10 AM and 10 FM radio station presets.

To set up radio station presets?

- 1 Press the **⏻** (power) button to turn on your boombox.
- 2 Press the **Source** button one or more times until **AM** or **FM** appears on the LCD.
- 3 Press the **Tune +/▶▶** (skip forward) or **Tune -/◀◀** (skip back) button to go to select the radio station you want to preset.
- 4 Press the **Memory** button. **P 01** blinks on the LCD. If P 01 has already be assigned to a radio station, the next available preset number appears.
- 5 Press the **Play Mode/Preset** button one or more times to select the preset number (**P 01** through **P 10**) you want to assign to the station.
- 6 Press the **Memory** button to save the radio station preset.



To select a radio station preset:

- Press the **Play Mode/Preset** button one or more times until the preset number you wants appears on the LCD.

Using the CD player

Playable CDs

Your boombox can play:

CD type	Logo	File formats
Audio CD		CDDA
CD-R		CDDA
CD-RW		CDDA

Caution

Do not try to play HCFCs, Vex, or data CDs. You may damage your boombox.

Playing a CD

Cautions

- To prevent damage to the CD, never open the CD door while the CD is rotating.
- Do not use the carrying handle when playing a CD. The CD player should only be used on a flat, steady surface.

Note

"NO DISC" appears on the LCD if:

- There is no CD in the CD compartment
- A CD is inserted incorrectly
- An inserted CD is dirty or damaged.

INSIGNIA™

Insignia NS-BBTCD01 CD Boombox with Bluetooth





To play a CD:

- 1 Press the  (power) button to turn on your boombox.
- 2 Press **OPEN** on the CD door to open the CD compartment.
- 3 Insert a CD into the CD tray with the label facing up, then press **OPEN** again to close the CD compartment. The total number of tracks appears on the LCD and playback starts automatically.



The currently playing track number appears on the LCD. When your boombox has played all the tracks on the CD, playback stops.

Your boombox can play standard and 3" CDs.

4 To control CD playback:

- Press the  (play/pause) button to pause playback. Playback stops, but the CD continues to spin and the playback time blinks on the LCD. Press this button again to resume playback.
- Press the **Tune +**/ (skip forward) button to go to the next track on the CD. Press and hold this button to fast forward on the CD.
- If the current track has played more than two seconds, press the **Tune -**/ (skip back) button to go to the beginning of the currently playing track. Press this button again to go to the previous track. If the current track has played for less than two seconds, press this button to go to the previous track. Press and hold for two seconds to fast reverse on the CD.
- Press  (stop) to stop playback before the CD has finished playing.

Repeating a track or CD**To repeat a single track:**

- 1 While CD is playing, press the **Play Mode/Presets** button once. **REPEAT** appears on the LCD, and your boombox repeats the currently selected track.
- 2 To repeat another track, press the **Tune +**/ (skip forward) or **Tune -**/ (skip back) button to select the track you want to repeat.
- 3 To cancel repeat mode, press the **Play Mode/Presets** one or more times until the repeat indicator disappears from the LCD.

To repeat an entire CD:

- 1 While CD is playing, press the **Play Mode/Presets** button twice. **ALL** appears on the LCD, and your boombox repeats all the track on the CD.
- 2 To cancel repeat mode, press the **Play Mode/Presets** button one or more times until the repeat indicator disappears from the LCD.

Playing tracks in random order

To play tracks in random order:

- 1 While CD is playing, press the **Play Mode/Preset** button three times. **RANDOM** appears on the LCD, and your boombox plays the CD's tracks in random order.
- 2 To cancel random mode, press the **Play Mode/Preset** button one or more times until **RANDOM** disappears from the LCD.

Playing audio from a connected audio device

To play audio from a connected audio device:

- 1 Make sure that your boombox is turned off.
- 2 Plug one end of a 3.5mm audio cable (not provided) into the **AUX In** jack on the back of your boombox and to the audio out or line out jack on the audio device.

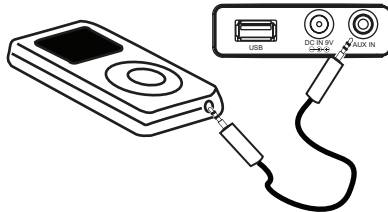

- 3 Press the **⏻** (power) button to turn on your boombox, then press the **Source** button one or more times until **AUX** appears on the LCD.
- 4 Adjust the volume using the volume knob on your boombox.

Note

You can also use the volume controls on the device to adjust the volume, but the volume knob on the boombox provides the best control.

- 5 Use the controls on the audio device to control playback.

INSIGNIA™

Insignia NS-BBTCD01 CD Boombox with Bluetooth

Troubleshooting

Caution

Do not try to repair your boombox yourself. Doing so invalidates the warranty.

General

Problem	Possible cause	Possible solution
No sound	The volume control may be set too low.	Rotate the volume control knob to increase the volume.
	The wrong audio source may be selected.	Press the Source button until you see the correct indicator on the LCD. See "Selecting the audio source" on page 12.
	The boombox may not be turned on.	Press the ⏻ (power) button to turn on your boombox.
	The AC power adapter may not be connected or may be connected incorrectly.	Make sure that the AC power adapter is connected securely and correctly to your boombox and the power outlet. See "Connecting the AC power adapter" on page 9.
	The batteries may be dead.	Replace the batteries. See "Installing batteries" on page 10.

Radio

Problem	Possible cause	Possible solution
There is noise or static when playing the radio	The FM antenna is not fully extended or needs to be repositioned.	Fully extend the FM antenna and adjust its position to get the best reception.
	Your boombox is not positioned correctly for AM band reception.	Move your boombox around to get the best reception.
	The station signal may be weak.	Try another station.

CD player

Problem	Possible cause	Possible solution
CD will not play	The CD may be inserted incorrectly.	Insert the CD with the label facing up.
	The CD may be dirty.	Clean the CD. See "Cleaning CDs" on page 20.
	The CD may be damaged.	Try another CD.

Problem	Possible cause	Possible solution
CD skips while playing	You are moving your boombox.	Do not move your boombox while a CD is playing. The CD player should only be used on a flat, steady surface.
	The CD may be dirty.	Clean the CD. See "Cleaning CDs" on page 20.
	The CD may be damaged.	Try another CD.

Bluetooth device

The boombox can stream music from paired Bluetooth devices like smartness, notebooks, and audio devices.

Problem	Possible cause	Possible solution
Boombox will not start pairing mode	Bluetooth is not selected as the audio source.	Press the Source button one or more times until BT appears on the LCD, then press the  (Bluetooth pairing) button.
Boombox is in pairing mode, but does not pair with the Bluetooth device	The Bluetooth device may not be turned on.	Make sure that the Bluetooth device is turned on.
	You have not selected your boombox on the Bluetooth device.	Make sure that the Bluetooth device is in pairing mode, then select NS-BBTCD01 on the Bluetooth device. See the instructions that came with the Bluetooth device.
	The Bluetooth device is too far away from your boombox.	Move the Bluetooth device within 33 feet (10 m) of your boombox.
Boombox was paired to the Bluetooth device, but will not re-pair	The Bluetooth device does not use a supported Bluetooth protocol.	Your boombox supports the A2DP and AVRCP Bluetooth protocols. Make sure that the Bluetooth device you are trying to connect uses one of these protocols.
	You have not selected your boombox on the Bluetooth device.	When a Bluetooth device disconnects from your boombox, you have to re-select your boombox to re-pair to the Bluetooth device. Make sure that the Bluetooth device is in pairing mode, then select NS-BBTCD01 on the Bluetooth device. See the instructions that came with the Bluetooth device.
	The Bluetooth device is too far away from your boombox.	Move the Bluetooth device within 33 feet (10 m) of your boombox.

INSIGNIA™

Insignia NS-BBTCD01 CD Boombox with Bluetooth

Maintaining

Handling CDs

- To keep a CD clean, do not touch the play side (non-label side) of the CD.
- Do not attach paper or tape to the CD.



Cleaning CDs

- Before playback, wipe the CD outwards from the center (not in a circle) with a clean cloth.



- If you cannot clean the CD with a dry cloth, wipe the CD with a slightly moistened, soft cloth, then dry it with a soft cloth.
- Do not use any solvents, such as paint thinner, benzene, commercially available cleaners, or anti-static spray designed for vinyl records.

Cleaning your boombox

- To prevent fire or shock hazard, disconnect your CD boombox from the AC power source when cleaning.
- The finish on your CD boombox may be cleaned with a dust cloth and cared for as other furniture. Use caution when cleaning and wiping the plastic parts.
- Mild soap and a damp cloth may be used on the front panel.

Specifications

CD supported types	CD, CD-R/RW
AM frequency	530 – 1710 KHz
FM frequency	87.5 – 107.9 MHz
Preset stations	10 (per band)
External connection	3.5mm headphone 3.5mm AUX in USB 2.0 (charging)
Bluetooth profile Version	2.1, A2DP, AVRCP
Speaker	3" ferrite × 2 pcs.
Output power	3W × 2 RMS
Power source	DC9V 1.8A adapter or C size batteries
Dimensions (W × D × H)	12.2 × 8.2 × 5.7 inches (31 × 20.8 × 14.5 cm)
Weight	5.0 lbs (2.3 kg)

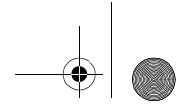

Legal notices

FCC Statement

This device complies with Part 15 of the FCC Rules. Operation is subject to the following two conditions: (1) this device may not cause harmful interference, and (2) this device must accept any interference received, including interference that may cause undesired operation.

This equipment has been tested and found to comply within the limits for a class B digital device, pursuant to Part 15 of the FCC Rules. These limits are designed to provide reasonable protection against harmful interference in a residential installation. This equipment generates, uses, and can radiate radio frequency energy and, if not installed and used in accordance with the instructions, may cause harmful interference to radio communications. However, there is no guarantee that interference will not occur in a particular installation. If this equipment does cause harmful interference to radio or television reception, which can be determined by turning the equipment off and on, the user is encouraged to try to correct the interference by one or more of the following measures:

- Reorient or relocate the receiving antenna.
- Increase the separation between the equipment and receiver.
- Connect the equipment into an outlet on a circuit different from that to which the receiver is connected.
- Consult the dealer or an experienced technician for help.

FCC Caution

Changes or modifications not expressly approved by the party responsible for compliance could void the user's authority to operate the equipment.

RSS-Gen & RSS-210 Statement

This device complies with Industry Canada licence-exempt RSS standard(s).

Operation is subject to the following two conditions: (1) this device may not cause interference, and (2) this device must accept any interference, including interference that may cause undesired operation of the device.

Le présent appareil est conforme aux CNR d'Industrie Canada applicables aux appareils radio exempts de licence. L'exploitation est autorisée aux deux conditions suivantes : (1) l'appareil ne doit pas produire de brouillage, et (2) l'utilisateur de l'appareil doit accepter tout brouillage radioélectrique subi, même si le brouillage est susceptible d'en compromettre le fonctionnement.

RSS-102 Statement

This equipment complies with Industry Canada radiation exposure limits set forth for an uncontrolled environment.

Cet équipement est conforme à l'exposition aux rayonnements Industry Canada limites établies pour un environnement non contrôlé.

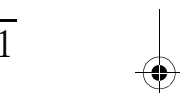
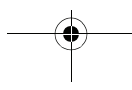
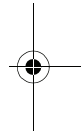
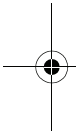

INSIGNIA™

Insignia NS-BBTCD01 CD Boombox with Bluetooth

90-day limited warranty - Insignia

Definitions:

Insignia Products ("Insignia") warrants to you, the original purchaser of this new Insignia-branded product ("Product"), that the Product shall be free of defects in the original manufacturer of the material or workmanship for a period of ninety (90) days from the date of your purchase of the Product ("Warranty Period"). For this warranty to apply, your Product must be purchased in the United States or Canada from a Best Buy or Future Shop authorized dealer of Insignia brand products only that are packaged with this warranty statement.

How long does the coverage last?

The Warranty Period lasts for ninety (90) days from the date you purchased the Product. Your purchase date is printed on the receipt you received with the Product.

What does this warranty cover?

During the Warranty Period, if the original manufacture of the material or workmanship of the Product is determined to be defective by an authorized Insignia repair center or store personnel, Insignia will (at its sole option): (1) repair the Product with new or rebuilt parts; or (2) replace the Product at no charge with new or rebuilt comparable products or parts. Products and parts replaced under this warranty become the property of Insignia and are not returned to you. If service of Products or parts are required after the Warranty Period expires, you must pay all labor and parts charges. This warranty lasts as long as you own your Insignia Product during the Warranty Period. Warranty coverage terminates if you sell or otherwise transfer the Product.

How to obtain warranty service?

If you purchased the Product at a Best Buy or Future Shop retail store location, please take your original receipt and the Product to any Best Buy or Future Shop store. Make sure that you place the Product in its original packaging or packaging that provides the same amount of protection as the original packaging. If you purchased the Product from a Best Buy or Future Shop online web site, mail your original receipt and the Product to the address listed on the web site. Make sure that you put the Product in its original packaging or packaging that provides the same amount of protection as the original packaging. To obtain warranty service, in the United States call 1-888-BESTBUY, Canada call 1-866-BESTBUY for Future Shop call 1-800-663-2275. Call agents may diagnose and correct the issue over the phone.

Where is the warranty valid?

This warranty is valid only in the United States and Canada at Best Buy or Future Shop branded retail stores or websites to the original purchaser of the product in the county where the original purchase was made.

What does the warranty not cover?

This warranty does not cover:

- Customer instruction/education
- Installation
- Set up adjustments
- Cosmetic damage
- Damage due to acts of God, such as power surges
- Accident(s)
- Misuse



- Abuse
- Negligence
- Commercial purposes/use, including but not limited to use in a place of business or in communal areas of a multiple dwelling condominium or apartment complex, or otherwise used in a place of other than a private home.
- Modification of any part of the Product, including the antenna
- Display panel damaged by static (non-moving) images applied for lengthy periods (burn-in).
- Damage due to incorrect operation or maintenance
- Connection to an incorrect voltage or power supply
- Attempted repair by any person not authorized by Insignia to service the Product
- Products sold "as is" or "with all faults"
- Consumables, including but not limited to batteries (i.e. AA, AAA, C etc.)
- Products where the factory applied serial number has been altered or removed
- Loss or Theft of this product or any part of the product
- Up to three (3) pixel failures (dots that are dark or incorrectly illuminated) grouped in an area smaller than one tenth (1/10) of the display size or up to five (5) pixel failures throughout the display. (Pixel based displays may contain a limited number of pixels that may not function normally.)
- Failures or Damage caused by any contact including but not limited to liquids, gels or pastes.

REPAIR REPLACEMENT AS PROVIDED UNDER THIS WARRANTY IS YOUR EXCLUSIVE REMEDY FOR BREACH OF WARRANTY. INSIGNIA SHALL NOT BE LIABLE FOR ANY INCIDENTAL OR CONSEQUENTIAL DAMAGES FOR THE BREACH OF ANY EXPRESS OR IMPLIED WARRANTY ON THIS PRODUCT, INCLUDING, BUT NOT LIMITED TO, LOST DATA, LOSS OF USE OF YOUR PRODUCT, LOST BUSINESS OR LOST PROFITS. INSIGNIA PRODUCTS MAKES NO OTHER EXPRESS WARRANTIES WITH RESPECT TO THE PRODUCT, ALL EXPRESS AND IMPLIED WARRANTIES FOR THE PRODUCT, INCLUDING, BUT NOT LIMITED TO, ANY IMPLIED WARRANTIES OF AND CONDITIONS OF MERCHANTABILITY AND FITNESS FOR A PARTICULAR PURPOSE, ARE LIMITED IN DURATION TO THE WARRANTY PERIOD SET FORTH ABOVE AND NO WARRANTIES, WHETHER EXPRESS OR IMPLIED, WILL APPLY AFTER THE WARRANTY PERIOD. SOME STATES, PROVINCES AND JURISDICTIONS DO NOT ALLOW LIMITATIONS ON HOW LONG AN IMPLIED WARRANTY LASTS, SO THE ABOVE LIMITATION MAY NOT APPLY TO YOU. THIS WARRANTY GIVES YOU SPECIFIC LEGAL RIGHTS, AND YOU MAY ALSO HAVE OTHER RIGHTS, WHICH VARY FROM STATE TO STATE OR PROVINCE TO PROVINCE.

Contact Insignia:

For customer service please call 1-877-467-4289

www.insigniaproducts.com

Distributed by Best Buy Purchasing, LLC

7601 Penn Avenue South, Richfield, Minnesota, U.S.A. 55423-3645

© 2013 BBY Solutions, Inc.

All rights reserved. INSIGNIA is a trademark of BBY Solutions, Inc. Registered in some countries. All other products and brand names are trademarks of their respective owners.

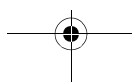
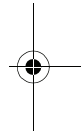
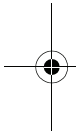

INSIGNIA

INSIGNIA is a registered trademark of BBY Solutions, Inc.
Registered in some countries.
Distributed by Best Buy Purchasing, LLC, 7601 Penn Ave South, Richfield, MN 55423 U.S.A.
©2013 BBY Solutions, Inc.
All Rights Reserved
1-877-467-4289
www.insigniaproducts.com

V1 ENGLISH
13-0025