

FCC 47 CFR PART 27 SUBPART L

Product Type : 2G/3G Module
Applicant : Telit Communications S.p.A.
Address : Via Stazione di Prosecco, 5/B, Sgonico, TS 34010, Italy
Trade name : Telit
Model No. : HE910
Test : ANSI/TIA-603-C-2004
Specification : RSS-Gen Issue 3, December 2010
RSS-139 Issue 2, February 2009
Issue Date : Feb. 03, 2012

Issue by

A Test Lab Techno Corp.
No. 140-1, Changan Street, Bade City,
Taoyuan County 334, Taiwan R.O.C.
Tel : +86-3-2710188 / Fax : +86-3-2710190



Taiwan Accreditation Foundation accreditation number: 1330

Note: This report shall not be reproduced except in full, without the written approval of A Test Lab Techno Corp. This document may be altered or revised by A Test Lab Techno Corp. personnel only, and shall be noted in the revision section of the document. The client should not use it to claim product endorsement by TAF, or any government agencies. The test results in the report only apply to the tested sample.

Revision History

Rev.	Issue Date	Revisions	Revised By
00	Jan. 11, 2012	Initial Issue	
01	Jan. 30, 2012	Delete IC ID	Nico Peng
02	Feb. 03, 2012	Add IC standard and RX of radiated emission test data	Nico Peng

Verification of Compliance

Issued Date: 2012/02/03

Product Type : 2G/3G Module
Applicant : Telit Communications S.p.A.
Address : Via Stazione di Prosecco, 5/B, Sgonico, TS 34010, Italy
Trade Name : Telit
Model No. : HE910
FCC ID : RI7HE910
IC ID : 5131A-HE910
EUT Rated Voltage : DC 3.8V
Test Voltage : DC 3.8V
Applicable Standard : FCC 47 CFR PART 27 SUBPART L: Oct. 2010
ANSI/TIA-603-C-2004
RSS-Gen Issue 3, December 2010
RSS-139 Issue 2, February 2009
Test Result : Complied
Performing Lab. : A Test Lab Techno Corp.

No. 140-1, Changan Street, Bade City,
Taoyuan County 334, Taiwan R.O.C.

Tel : +886-3-2710188 / Fax : +886-3-2710190

Taiwan Accreditation Foundation accreditation number:
1330



<http://www.atl-lab.com.tw/e-index.htm>

The above equipment was tested by A Test Lab Techno Corp. The test data, data evaluation, test procedures, and equipment configurations shown in this report were made in accordance with the procedures given in ANSI C63.4: 2009 and the energy emitted by the sample tested as described in this report is in compliance with the requirements of FCC Rules Part 27L.

The test results of this report relate only to the tested sample identified in this report



Approved By :  Reviewed By : 
(Manager) (Murphy Wang) (Testing Engineer) (Charlie Chang)

TABLE OF CONTENTS

1	General Information.....	6
1.1.	EUT Description.....	6
1.2.	Mode of Operation.....	6
1.3.	EUT Exercise Software.....	7
1.4.	Configuration of Test System Details.....	7
1.5.	Test Site Environment.....	7
1.6.	Summary of Test Result.....	8
2	RF Output Power Test.....	9
2.1.	Limit.....	9
2.2.	Test Instruments.....	9
2.3.	Test Setup.....	9
2.4.	Test Procedure.....	10
2.5.	Uncertainty.....	10
2.6.	Test Result.....	10
3	Effective Radiated Power / Equivalent Isotropic Radiated Power Test.....	11
3.1.	Limit.....	11
3.2.	Test Instruments.....	11
3.3.	Test Setup.....	12
3.4.	Test Procedure.....	13
3.5.	Uncertainty.....	13
3.6.	Test Result.....	14
4	Occupied Bandwidth Test.....	15
4.1.	Limit.....	15
4.2.	Test Instruments.....	15
4.3.	Setup.....	15
4.4.	Test Procedure.....	16
4.5.	Uncertainty.....	16
4.6.	Test Result.....	16
5	Conducted Emission Test.....	19
5.1.	Limit.....	19
5.2.	Test Instruments.....	19
5.3.	Setup.....	19
5.4.	Test Procedure.....	20
5.5.	Uncertainty.....	20
5.6.	Test Result.....	20

6	Field Strength of Spurious Radiation Test	36
6.1.	Limit	36
6.2.	Test Instruments.....	36
6.3.	Setup.....	36
6.4.	Test Procedure.....	37
6.5.	Uncertainty.....	37
6.6.	Test Result	38
7	Frequency Stability (Temperature Variation) Test	41
7.1.	Limit	41
7.2.	Test Instruments.....	41
7.3.	Setup.....	41
7.4.	Test Procedure.....	41
7.5.	Uncertainty.....	42
7.6.	Test Result	42
8	Frequency Stability (Voltage Variation) Test	43
8.1.	Limit	43
8.2.	Test Instruments.....	43
8.3.	Setup.....	43
8.4.	Test Procedure.....	43
8.5.	Uncertainty.....	43
8.6.	Test Result	44

1 General Information

1.1. EUT Description

Applicant		Telit Communications S.p.A.			
Applicant Address		Via Stazione di Prosecco, 5/B, Sgonico, TS 34010, Italy			
Manufacturer		Telit Communications S.p.A.			
Manufacturer Address		Via Stazione di Prosecco, 5/B, Sgonico, TS 34010, Italy			
Product Type		2G/3G Module			
Trade Name		Telit			
Model Number		HE910			
FCC ID		R17HE910			
IC ID		5131A-HE910			
Hardware Version		0			
Software Version		12.00.002			
Mode	WCDMA	Band	UL Frequency (MHz)	DL Frequency (MHz)	Modulation
		IV	1712.4 ~ 1752.6	2112.4 ~ 2152.6	QPSK
Max. RF Output Power		26.40 dBm / 0.437 W			
Max. EIRP		22.75 dBm / 0.188 W			
Emission Designator		4M06F9W			

1.2. Mode of Operation

ATL has verified the construction and function in typical operation. All the test modes were carried out with the EUT in normal operation, which was shown in this test report and defined as:

Test Mode
Mode 1: WCDMA Band IV Link (Transmit)
Mode 2: WCDMA Band IV Link (Receive)

Note: Regards to the frequency band operation: the lowest, middle and highest frequency of channel were selected to perform the test, then shown on this report.

Tested System Details

The types for all equipments, plus descriptions of all cables used in the tested system (including inserted cards) are:

	Product	Manufacturer	Model No.	Serial No.	Power Cord
1.	Universal Radio Communication Tester	R&S	CMU200	109369	N/A

1.3. EUT Exercise Software

1.	Setup the EUT and Base Station (CMU200) as shown on 1.4.
2.	Turn on the power of all equipment.
3.	The EUT will start to operate function.

1.4. Configuration of Test System Details

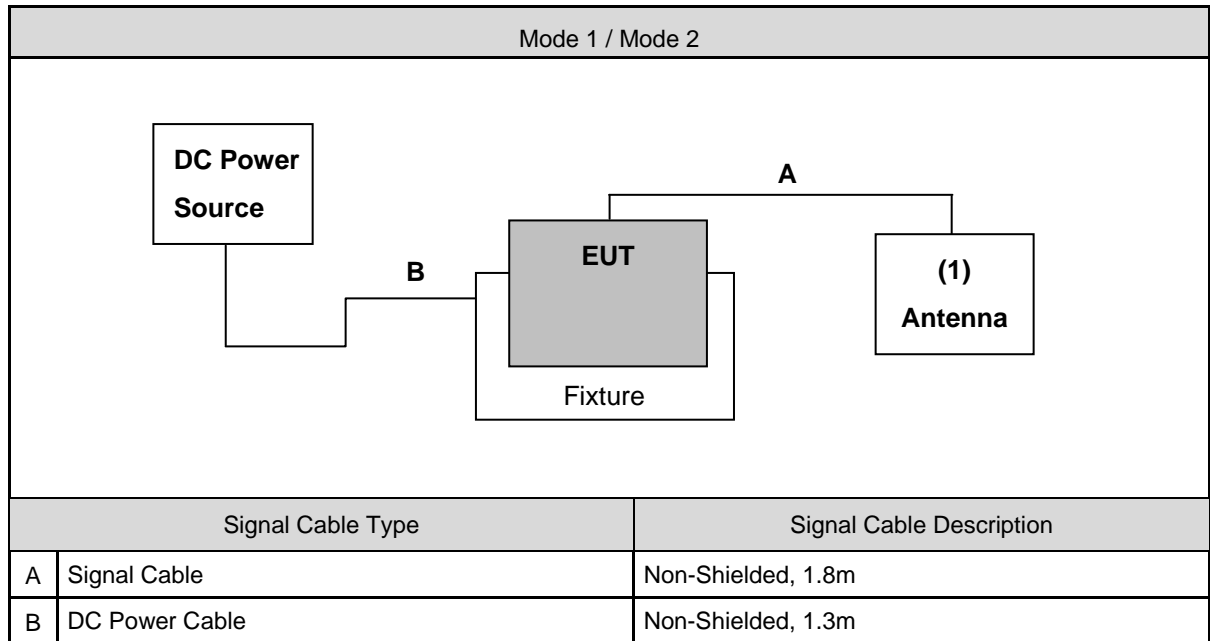

1.5. Test Site Environment

Items	Required (IEC 68-1)	Actual
Temperature (°C)	15-35	26
Humidity (%RH)	25-75	60
Barometric pressure (mbar)	860-1060	950

1.6. Summary of Test Result

Description	FCC Rule	IC Rule	Limit	Result
Conducted Output Power	§2.1046	N/A	N/A	Pass
Equivalent Isotropic Radiated Power	§27.50(d)(2)	RSS-139 (6.4) SRSP-513(5.1.2)	< 1 Watts	Pass
Occupied Bandwidth	§2.1049 §27.53(g)	RSS-GEN(4.6.1)	N/A	Pass
Band Edge Measurement	§2.1051 §27.53(g)	RSS-139 (6.5)	$< 43 + 10 \log_{10}(P[\text{Watts}])$	Pass
Conducted Emission	§2.1051 §27.53(g)	RSS-139 (6.5)	$< 43 + 10 \log_{10}(P[\text{Watts}])$	Pass
Field Strength of Spurious Radiation	§2.1053 §27.53(g)	RSS-139 (6.5) RSS-GEN(4.10)	$< 43 + 10 \log_{10}(P[\text{Watts}])$	Pass
Frequency Stability for Temperature & Voltage	§2.1055 §27.54	RSS-139(6.3)	< 2.5 ppm	Pass

2 RF Output Power Test

2.1. Limit

N/A

2.2. Test Instruments

Describe	Manufacturer	Model No.	Serial No.	Cal. Date	Remark
Universal Radio Communication Tester	ROHDE & SCHWARZ	CMU200	109369	08/10/2010	(2)
Single Channel PK Power Sensor	Agilent	N1911A	MY45101619	12/15/2011	(1)
Wideband Power Meter	Agilent	N1921A	MY45241957	12/15/2011	(1)
Test Site	ATL	TE02	TE02	N.C.R.	-----

Remark: ⁽¹⁾ Calibration period 1 year. ⁽²⁾ Calibration period 2 years.

NOTE: N.C.R. = No Calibration Request.

2.3. Test Setup

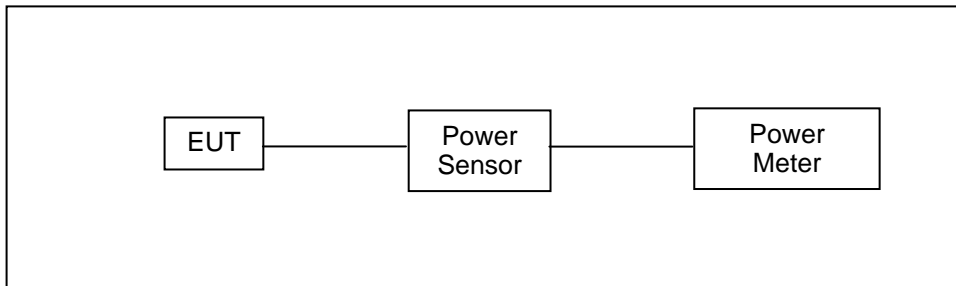

2.4. Test Procedure

The measurement is made according to ANSI/TIA-603-C-2004 as follows:

1. The transmitter output was connected to power meter and base station through power divider.
2. Set base station for EUT at WCDMA Band IV, power level was set to maximum.
3. Select lowest, middle, and highest channels for each band.

2.5. Uncertainty

The measurement uncertainty is defined as for RF output power measurement is 1.2 dB.

2.6. Test Result

Product	2G/3G Module					
Test Item	RF Output Power					
Date of Test	12/06/2011			Test Site	TE02	
Bands	Sub-Test	Frequency (MHz)	Average Power		Peak Power	
			(dBm)	(W)	(dBm)	(W)
WCDMA IV (RMC 12.2K)	-----	1712.4	23.54	0.226	26.40	0.437
		1740.0	23.48	0.223	26.30	0.427
		1752.6	23.46	0.222	26.32	0.429

Note: The testing result was used peak detector.

3 Effective Radiated Power / Equivalent Isotropic Radiated Power Test

3.1. Limit

For FCC Part 27.50(d)(2): The EIRP of mobile transmitters are limited to 1 watt for 1710~1755 MHz.

3.2. Test Instruments

3 Meter Chamber (966-A)					
Equipment	Manufacturer	Model Number	Serial Number	Cal. Date	Remark
RF Pre-selector	Agilent	N9039A	MY46520256	05/23/2011	(2)
Spectrum Analyzer	Agilent	E4446A	MY46180578	01/18/2011	(1)
Pre Amplifier	Agilent	8449B	3008A02237	02/23/2011	(1)
Pre Amplifier	Agilent	8447D	2944A10961	02/23/2011	(1)
Broadband Antenna (30MHz~1GHz)	SCHWARZBECK MESS-ELEKTRONIK	VULB9163	9163-270	07/29/2011	(1)
Horn Antenna (1~18GHz)	SCHWARZBECK MESS-ELEKTRONIK	BBHA9120D	9120D-550	06/29/2011	(1)
Horn Antenna (18~40GHz)	SCHWARZBECK MESS-ELEKTRONIK	BBHA9170	9170-320	06/28/2011	(1)
Test Site	ATL	TE01	888001	12/20/2011	(1)

Remark: ⁽¹⁾ Calibration period 1 year. ⁽²⁾ Calibration period 2 years.

NOTE: N.C.R. = No Calibration Request.

3.3. Test Setup

Below 1 GHz

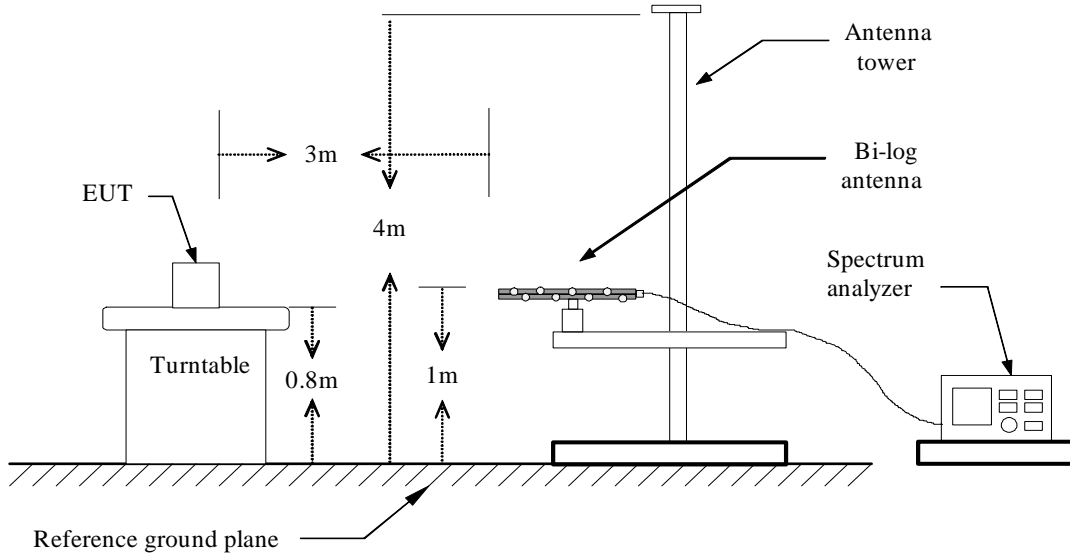

Above 1 GHz

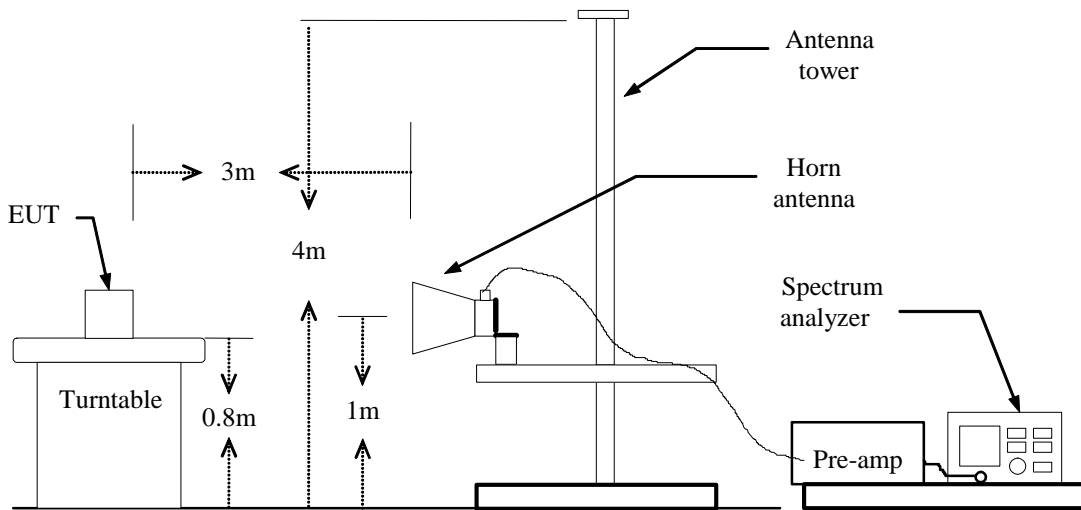

For Substituted Method Test Set-UP

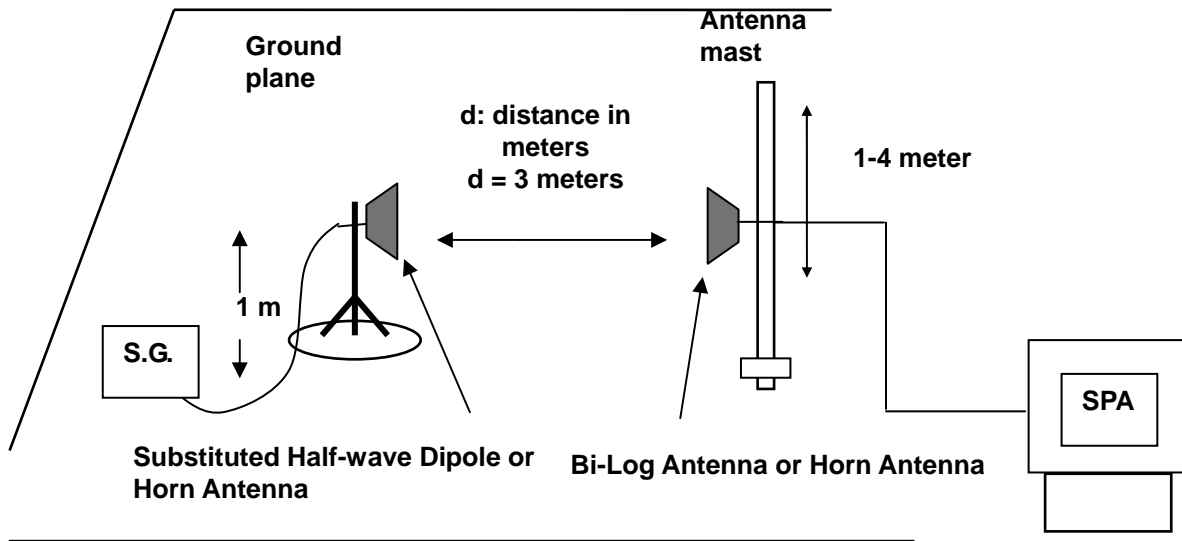

3.4. Test Procedure

The measurement is made according to ANSI/TIA-603-C-2004 as follows:

The EUT was placed on a non-conductive turntable using a non-conductive support. The radiated emission at the fundamental frequency was measured at 3 m with a test antenna and EMI spectrum analyzer.

During the measurement of the EUT, the resolution bandwidth was set to 3MHz and the average bandwidth was set to 3MHz. The highest emission was recorded with the rotation of the turntable and the lowering of the test antenna. The reading was recorded and the field strength (E in dBuV/m) was calculated.

ERP in frequency band 824-849MHz, and EIRP in frequency band 1851.25 –1910MHz were measured using a substitution method. The EUT was replaced by half-wave dipole (824-849MHz) or horn antenna (1851.25-1910MHz) connected to a signal generator. The spectrum analyzer reading was recorded and ERP/EIRP was calculated as follows:

$$\text{ERP} = \text{S.G. output (dBm)} + \text{Antenna Gain (dBd)} - \text{Cable (dB)}$$

$$\text{EIRP} = \text{S.G. output (dBm)} + \text{Antenna Gain (dBi)} - \text{Cable (dB)}$$

3.5. Uncertainty

The measurement uncertainty is defined as for Field Strength of Spurious Radiation measurement is ± 3.072 dB.

3.6. Test Result

Model Number	HE910						
Test Item	E.IR.P.						
Test Mode	Mode 1: WCDMA Band IV Link						
Date of Test	01/06/2012				Test Site	TE01	
Bands	Frequency (MHz)	Ant. Polar.	Read Level (dBm)	Correction factor (dBm)	E.IR.P.		Limit (W)
					(dBm)	(W)	
WCDMA IV (RMC 12.2K)	1712.4	H	10.14	10.45	20.59	0.115	< 1
		V	15.51	7.24	22.75	0.188	< 1
	1740.0	H	8.30	10.45	18.75	0.075	< 1
		V	14.94	7.39	22.33	0.171	< 1
	1752.6	H	10.18	10.45	20.63	0.116	< 1
		V	14.54	7.55	22.09	0.162	< 1

Note: 1. ERP/EIRP = Read Level + Correction factor.

2. For WCDMA signals, a peak detector is used with RBW = VBW = 5MHz.

3. For AMPS, GSM, and NADC TDMA signals, a peak detector is used, with RBW = VBW= 1 MHz.

4 Occupied Bandwidth Test

4.1. Limit

The Occupied Bandwidth Limit:

N/A.

The Band Edge Limit:

The power of any emission outside of the authorized operating frequency ranges must be attenuated below the transmitting power (P) by a factor of at least $43 + 10\log(P)$ dB.

4.2. Test Instruments

Describe	Manufacturer	Model No.	Serial No.	Cal. Date	Remark
Spectrum Analyzer	Agilent	E4445A	MY46181986	05/16/2011	(2)
Universal Radio Communication Tester	ROHDE & SCHWARZ	CMU200	109369	08/10/2010	(2)
Attenuator	RADIALL	R41572000	0603033073	N.C.R.	-----
Power divider	Agilent	87302C	3239A00760	N.C.R.	-----
Test Site	ATL	TE05	TE05	N.C.R.	-----

Remark: ⁽¹⁾ Calibration period 1 year. ⁽²⁾ Calibration period 2 years.

NOTE: N.C.R. = No Calibration Request.

4.3. Setup

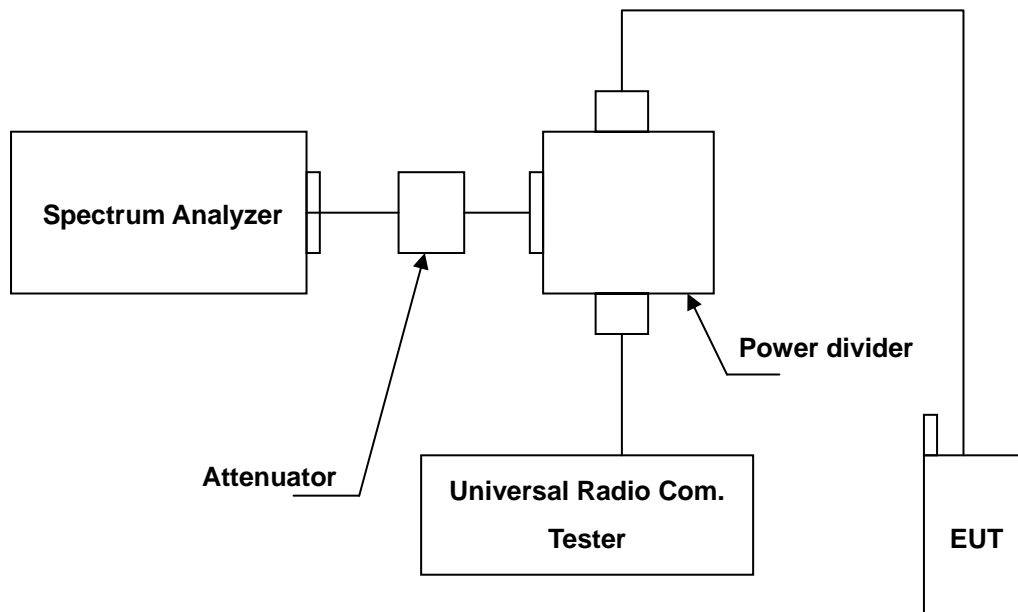

4.4. Test Procedure

The measurement is made according to FCC rules part 27:

1. The EUT was connected to Spectrum Analyzer and Base Station via power divider.
2. The occupied bandwidth of middle channel for the highest and lowest RF powers was measured.
3. The band edge of low and high channels for the highest RF powers within the transmitting frequency band were measured. Setting RBW as roughly BW/100.
4. The band edge setting:RB=51 kHz; VB=160 kHz for WCDMA Band IV.

4.5. Uncertainty

The measurement uncertainty is defined as $\pm 10\text{Hz}$

4.6. Test Result

Product	2G/3G Module			
Test Item	Occupied Bandwidth			
Test Mode	Mode 1: WCDMA Band IV Link			
Date of Test	01/06/2012	Test Site	TE05	
Channel No.	Frequency (MHz)	99 % Bandwidth (MHz)	Limit	Note
1312	1712.4	4.0633	N/A	RBW:100 kHz , VBW:300kHz
1450	1740.0	4.0610	N/A	RBW:100 kHz , VBW:300kHz
1513	1752.6	4.0661	N/A	RBW:100 kHz , VBW:300kHz

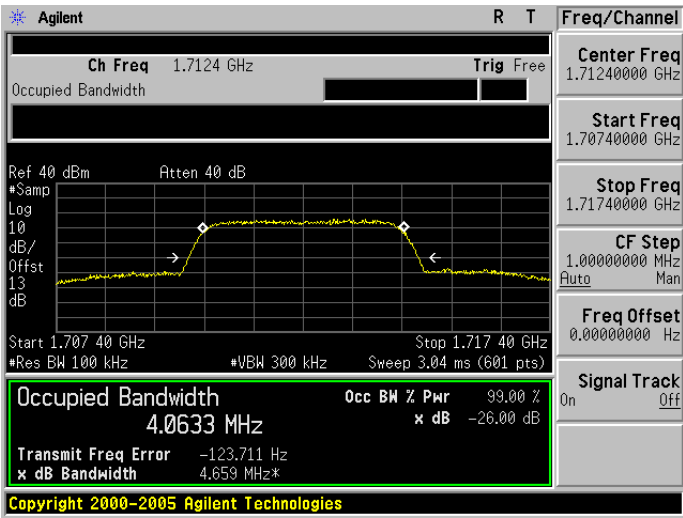
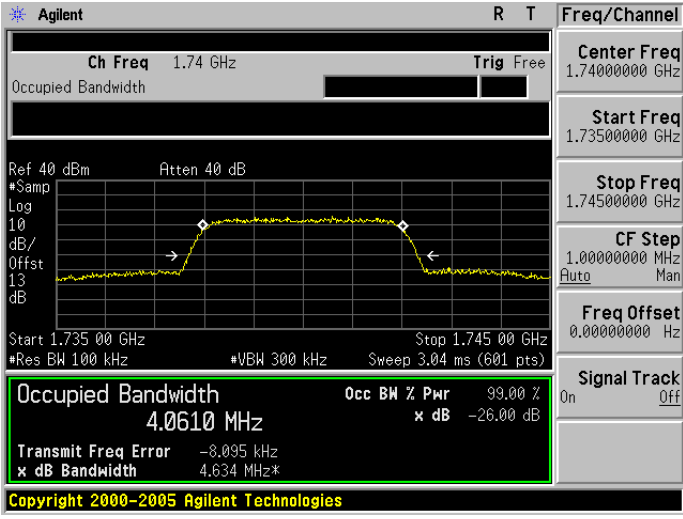
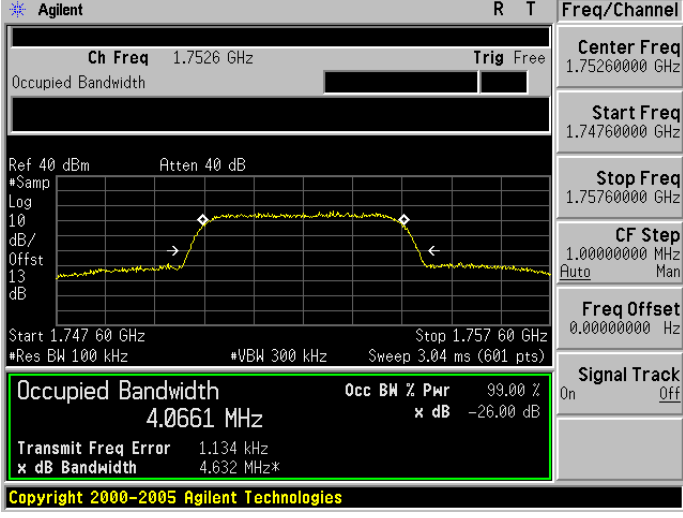
Mode 1: WCDMA Band IV Link	
CH 1312	 <p>Agilent R T Freq/Channel</p> <p>Ch Freq 1.7124 GHz Trig Free</p> <p>Center Freq 1.71240000 GHz</p> <p>Start Freq 1.70740000 GHz</p> <p>Stop Freq 1.71740000 GHz</p> <p>CF Step 1.00000000 MHz Auto Man</p> <p>Freq Offset 0.00000000 Hz</p> <p>Signal Track On Off</p> <p>Ref 40 dBm Atten 40 dB</p> <p>#Samp 10</p> <p>Log dB/Offst 13 dB</p> <p>Start 1.707 40 GHz Stop 1.717 40 GHz</p> <p>#Res BW 100 kHz #VBW 300 kHz Sweep 3.04 ms (601 pts)</p> <p>Occupied Bandwidth 4.0633 MHz Occ BW % Pwr 99.00 % x dB -26.00 dB</p> <p>Transmit Freq Error -123.711 Hz</p> <p>x dB Bandwidth 4.659 MHz*</p> <p>Copyright 2000-2005 Agilent Technologies</p>
CH1450	 <p>Agilent R T Freq/Channel</p> <p>Ch Freq 1.74 GHz Trig Free</p> <p>Center Freq 1.74000000 GHz</p> <p>Start Freq 1.73500000 GHz</p> <p>Stop Freq 1.74500000 GHz</p> <p>CF Step 1.00000000 MHz Auto Man</p> <p>Freq Offset 0.00000000 Hz</p> <p>Signal Track On Off</p> <p>Ref 40 dBm Atten 40 dB</p> <p>#Samp 10</p> <p>Log dB/Offst 13 dB</p> <p>Start 1.735 00 GHz Stop 1.745 00 GHz</p> <p>#Res BW 100 kHz #VBW 300 kHz Sweep 3.04 ms (601 pts)</p> <p>Occupied Bandwidth 4.0610 MHz Occ BW % Pwr 99.00 % x dB -26.00 dB</p> <p>Transmit Freq Error -8.095 kHz</p> <p>x dB Bandwidth 4.634 MHz*</p> <p>Copyright 2000-2005 Agilent Technologies</p>
CH1513	 <p>Agilent R T Freq/Channel</p> <p>Ch Freq 1.7526 GHz Trig Free</p> <p>Center Freq 1.75260000 GHz</p> <p>Start Freq 1.74760000 GHz</p> <p>Stop Freq 1.75760000 GHz</p> <p>CF Step 1.00000000 MHz Auto Man</p> <p>Freq Offset 0.00000000 Hz</p> <p>Signal Track On Off</p> <p>Ref 40 dBm Atten 40 dB</p> <p>#Samp 10</p> <p>Log dB/Offst 13 dB</p> <p>Start 1.747 60 GHz Stop 1.757 60 GHz</p> <p>#Res BW 100 kHz #VBW 300 kHz Sweep 3.04 ms (601 pts)</p> <p>Occupied Bandwidth 4.0661 MHz Occ BW % Pwr 99.00 % x dB -26.00 dB</p> <p>Transmit Freq Error 1.134 kHz</p> <p>x dB Bandwidth 4.632 MHz*</p> <p>Copyright 2000-2005 Agilent Technologies</p>

Band Edge

Product	2G/3G Module				
Test Item	Band Edge				
Test Mode	Mode 1: WCDMA Band IV Link				
Date of Test	01/06/2012		Test Site	TE05	
Band	Channel	Frequency (MHz)	Band Edge (dBm)	Limit (dBm)	Result
Lower	1312	1710.00	-27.99	-13	Pass
Higher	1513	1755.00	-28.54	-13	Pass

Lower Band

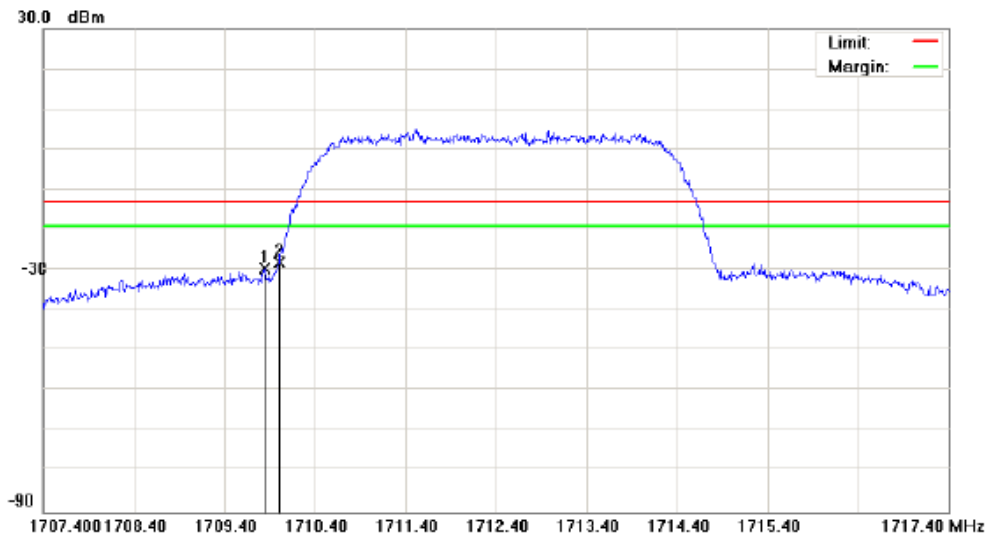

Higher Band

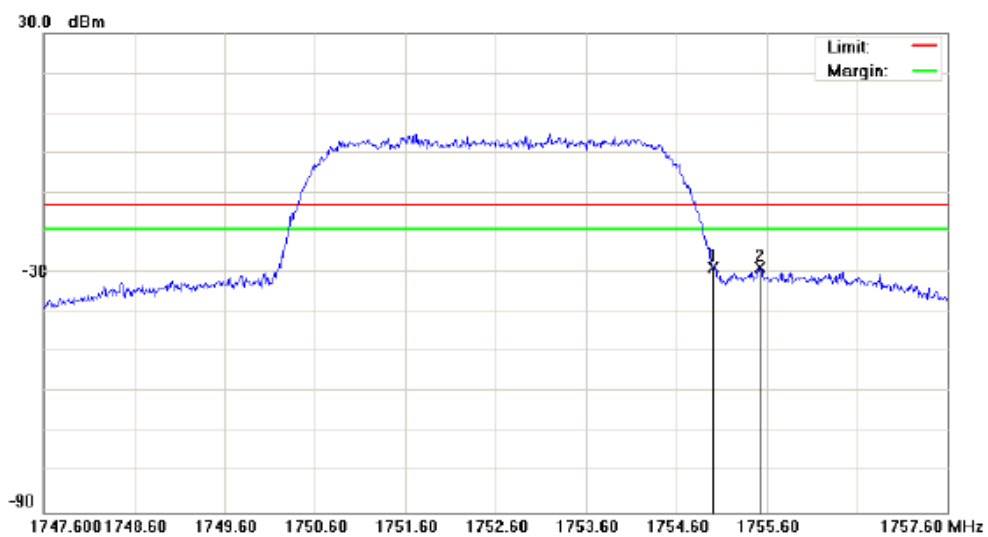

5 Conducted Emission Test

5.1. Limit

The power of any emission outside of the authorized operating frequency ranges must be attenuated below the transmitting power (P) by a factor of at least $43 + 10\log(P)$ dB.

5.2. Test Instruments

Describe	Manufacturer	Model No.	Serial No.	Cal. Date	Remark
Spectrum Analyzer	Agilent	E4445A	MY46181986	05/16/2011	(2)
Universal Radio Communication Tester	ROHDE & SCHWARZ	CMU200	109369	08/10/2010	(2)
Attenuator	RADIALL	R41572000	0603033073	N.C.R.	-----
Power divider	Agilent	87302C	3239A00760	N.C.R.	-----
Test Site	ATL	TE05	TE05	N.C.R.	-----

Remark: ⁽¹⁾ Calibration period 1 year. ⁽²⁾ Calibration period 2 years.

NOTE: N.C.R. = No Calibration Request.

5.3. Setup

Below 2.8GHz

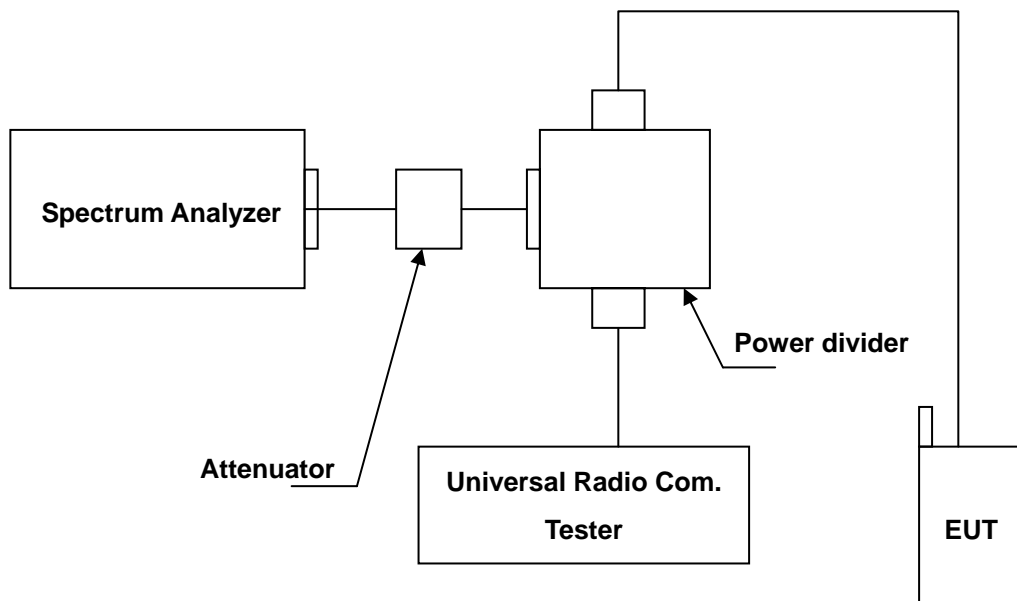

Above 2.8GHz

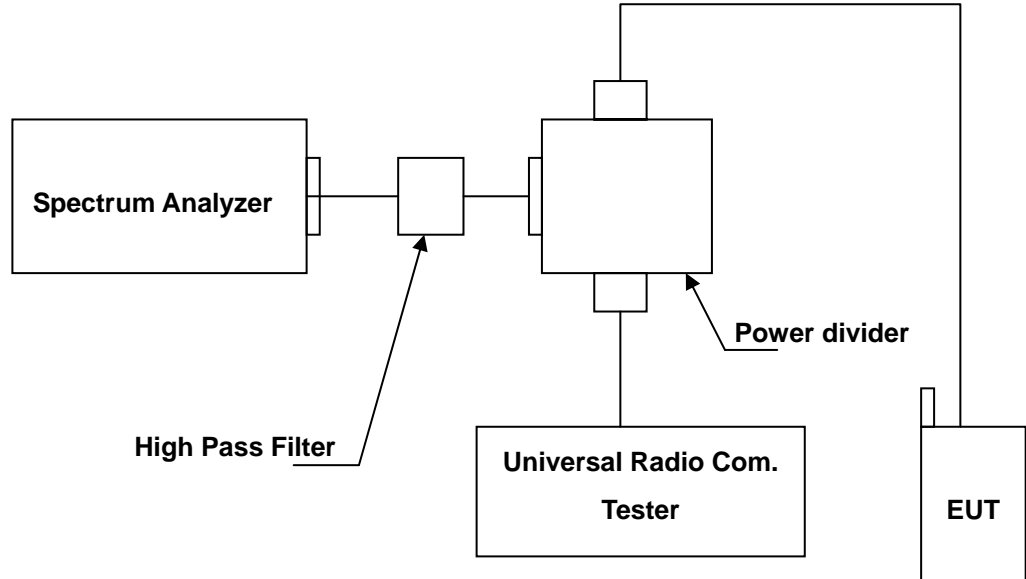

5.4. Test Procedure

1. The EUT was connected to Spectrum Analyzer and Base Station via power divider.
2. The middle channel for the highest RF power within the transmitting frequency was measured.
3. The conducted spurious emission for the whole frequency range was taken.
4. Test setting at WCDMA Band IV RB=1MHz, VB=1MHz.

5.5. Uncertainty

The measurement uncertainty is evaluated as ± 2.24 dB.

5.6. Test Result

Product	2G/3G Module		
Test Item	Conducted Emission		
Mode	Mode 1: WCDMA Band IV Link		
Date of Test	01/09/2012	Test Site	TE05
Note: The test results see next page.			

File: HE910(CH1312) Data: #1 Date: 2012/1/9 Time: 上午 09:40:41

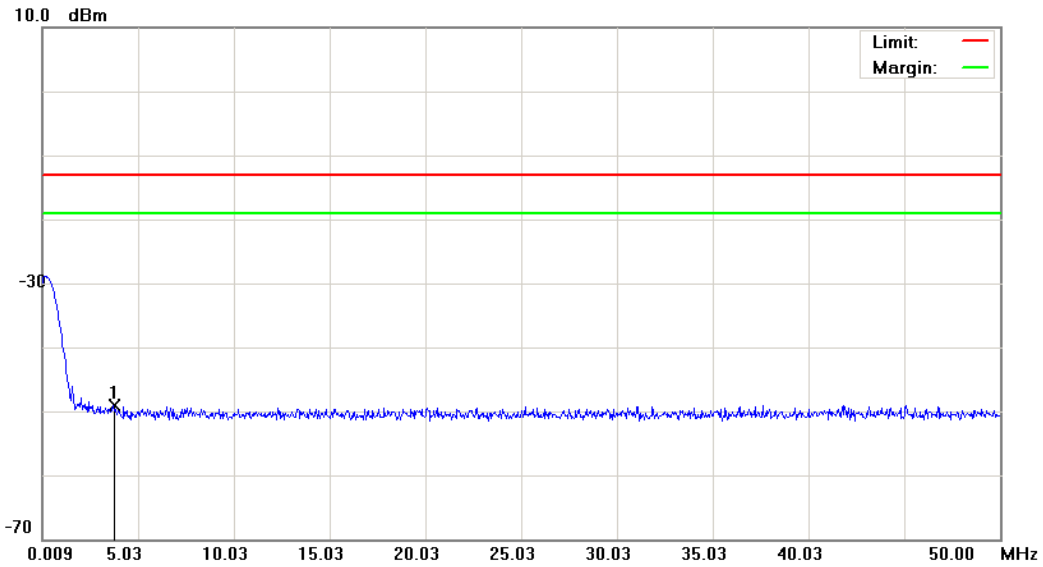

Site: : RF Conducted	Polarization: Conducted po	Temperature: 23 °C
Limit: FCC Part 27 conducted(9k-12.75G)	Power: AC 120V/60Hz	Humidity: 55.2 %
EUT: 2G/3G Module	Distance:	RBW: 1000 KHz VBW: 1000 KHz
M/N: HE910		
Mode: WCDMA Band IV		
Note:		

No.	Mk.	Freq.	Reading Level	Correct Factor	Measurement	Limit	Over	Antenna Height	Table Degree	Comment
		MHz	dBm	dB	dBm	dBm	dB	Detector	cm	degree
1	*	3.7332	-62.24	13.18	-49.06	-13.00	-36.06	peak		

*:Maximum data x:Over limit !:over margin

File: HE910(CH1312)

Data: #2

Date: 2012/1/9

Time: 上午 09:41:06

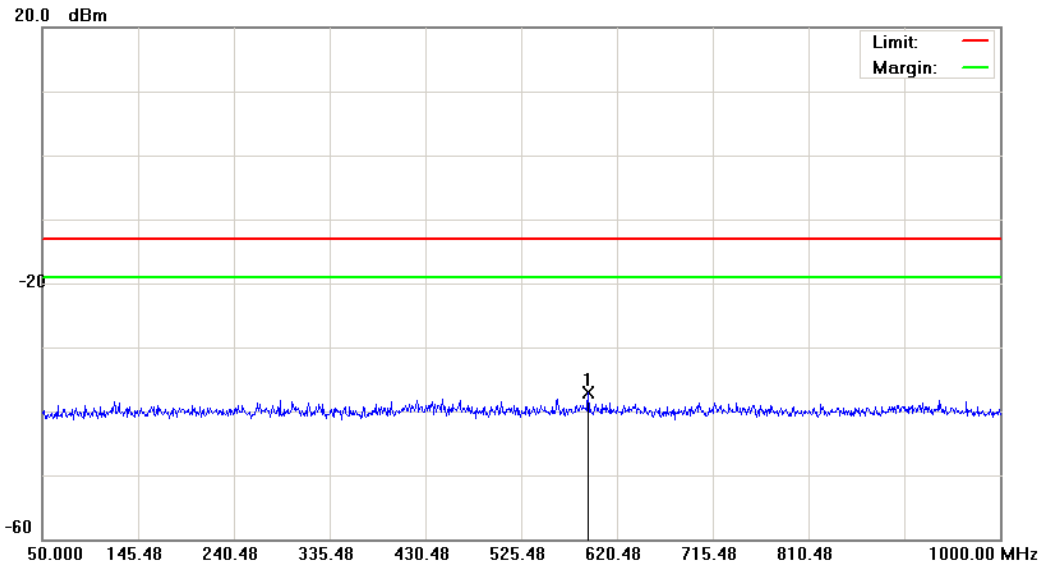

Site: : RF Conducted	Polarization: Conducted po	Temperature: 23 °C
Limit: FCC Part 27 conducted(9k-12.75G)	Power: AC 120V/60Hz	Humidity: 55.2 %
EUT: 2G/3G Module	Distance:	RBW: 1000 KHz VBW: 1000 KHz
M/N: HE910		
Mode: WCDMA Band IV		
Note:		

No.	Mk.	Freq.	Reading Level	Correct Factor	Measurement	Limit	Over	Antenna Height	Table Degree	
		MHz	dBm	dB	dBm	dBm	dB	Detector	cm	degree
1	*	591.5000	-50.32	13.20	-37.12	-13.00	-24.12	peak		Comment

*:Maximum data x:Over limit !:over margin

File: HE910(CH1312)

Data: #3

Date: 2012/1/9

Time: 上午 09:50:34

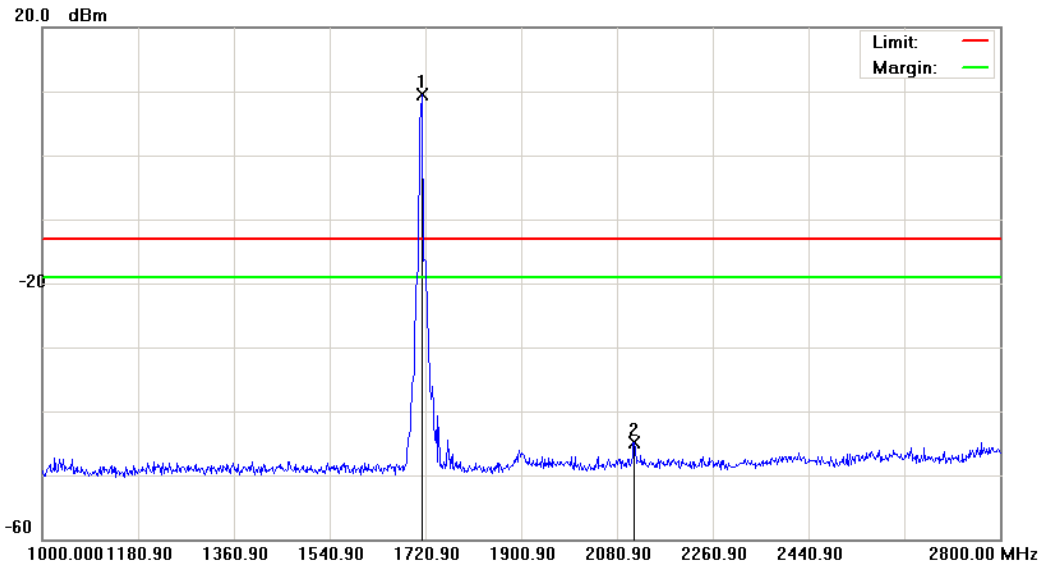

Site: RF Conducted

 Polarization: **Conducted po**

Temperature: 23 °C

Limit: FCC Part 27 conducted(9k-12.75G)

Power: AC 120V/60Hz

Humidity: 55.2 %

EUT: 2G/3G Module

Distance:

RBW: 1000 KHz VBW: 1000 KHz

M/N: HE910

Mode: WCDMA Band IV

Note:

No.	Mk.	Freq. MHz	Reading Level dBm	Correct Factor dB	Measure- ment dBm	Limit dBm	Over dB	Detector	Antenna Height cm	Table Degree degree	Comment
1	*	1713.700	5.06	4.36	9.42	-13.00	22.42	peak			Tx
2		2111.500	-49.58	4.71	-44.87	-13.00	-31.87	peak			

*:Maximum data x:Over limit !:over margin

File: HE910(CH1312)

Data: #4

Date: 2012/1/9

Time: 上午 09:59:59

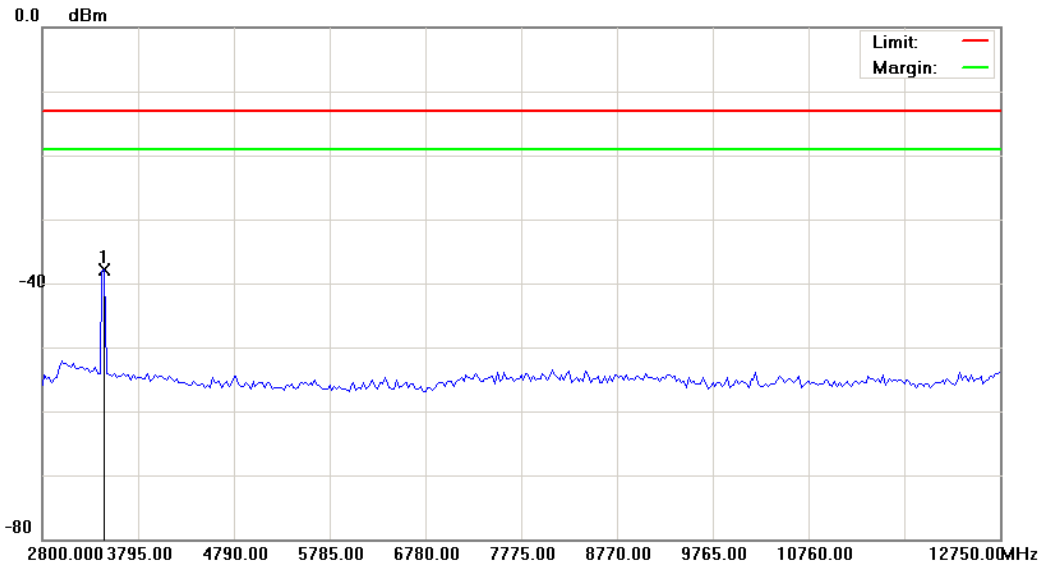

Site: : RF Conducted	Polarization: Conducted po	Temperature: 23 °C
Limit: FCC Part 27 conducted(9k-12.75G)	Power: AC 120V/60Hz	Humidity: 55.2 %
EUT: 2G/3G Module	Distance:	RBW: 1000 KHz VBW: 1000 KHz
M/N: HE910		
Mode: WCDMA Band IV		
Note:		

No.	Mk.	Freq.	Reading Level	Correct Factor	Measurement	Limit	Over	Antenna Height	Table Degree	Comment
		MHz	dBm	dB	dBm	dBm	dB	Detector	cm	degree
1	*	3446.750	-42.98	5.08	-37.90	-13.00	-24.90	peak		

*:Maximum data x:Over limit !:over margin

File: HE910(CH1312)

Data: #5

Date: 2012/1/9

Time: 上午 10:00:20

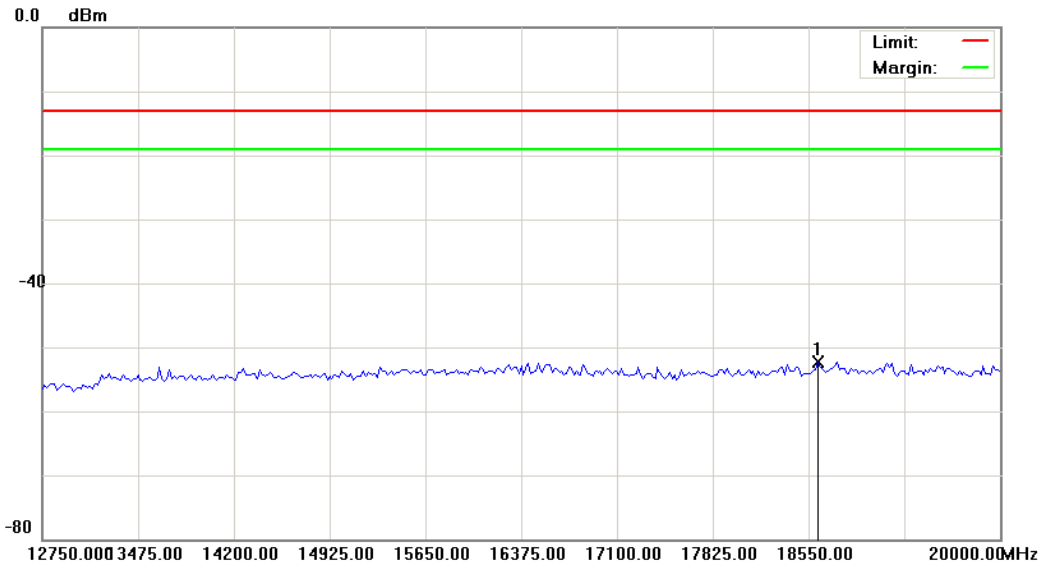

Site: : RF Conducted	Polarization: Conducted po	Temperature: 23 °C
Limit: FCC Part 27 conducted(9k-12.75G)	Power: AC 120V/60Hz	Humidity: 55.2 %
EUT: 2G/3G Module	Distance:	RBW: 1000 KHz VBW: 1000 KHz
M/N: HE910		
Mode: WCDMA Band IV		
Note:		

No.	Mk.	Freq.	Reading Level	Correct Factor	Measurement	Limit	Over	Antenna Height	Table Degree	
		MHz	dBm	dB	dBm	dBm	dB	Detector	cm	degree
1	*	18622.500	-59.36	7.05	-52.31	-13.00	-39.31	peak		Comment

*:Maximum data x:Over limit !:over margin

File: HE910(CH1450)

Data: #1

Date: 2012/1/9

Time: 上午 09:42:23

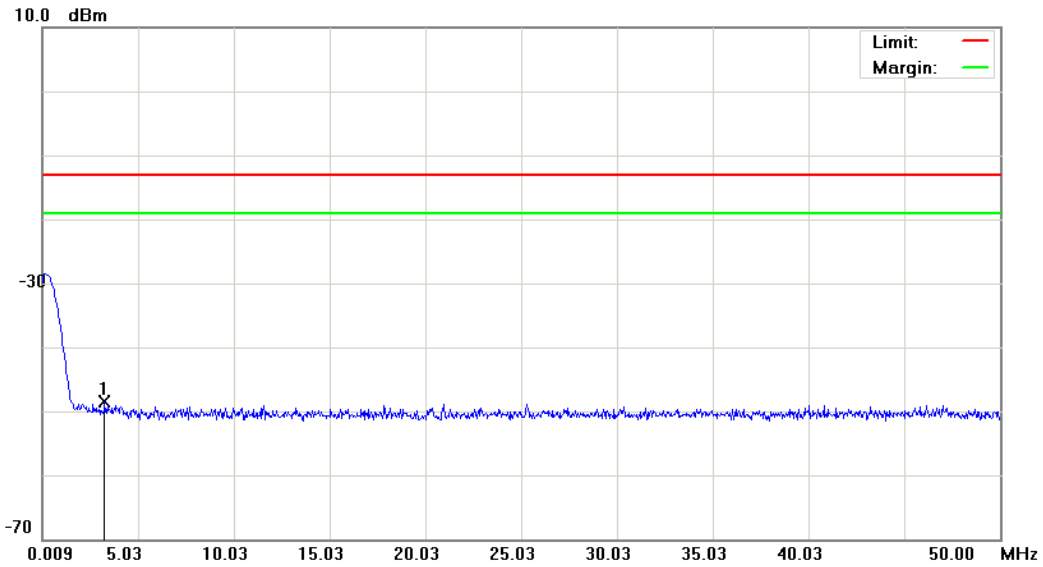

Site: : RF Conducted	Polarization: Conducted po	Temperature: 23 °C
Limit: FCC Part 27 conducted(9k-12.75G)	Power: AC 120V/60Hz	Humidity: 55.2 %
EUT: 2G/3G Module	Distance:	RBW: 1000 KHz VBW: 1000 KHz
M/N: HE910		
Mode: WCDMA Band IV		
Note:		

No.	Mk.	Freq.	Reading Level	Correct Factor	Measurement	Limit	Over	Antenna Height	Table Degree	Comment
		MHz	dBm	dB	dBm	dBm	dB	Detector	cm	degree
1	*	3.2583	-61.49	13.08	-48.41	-13.00	-35.41	peak		

*:Maximum data x:Over limit !:over margin

File: HE910(CH1450)

Data: #2

Date: 2012/1/9

Time: 上午 09:42:48

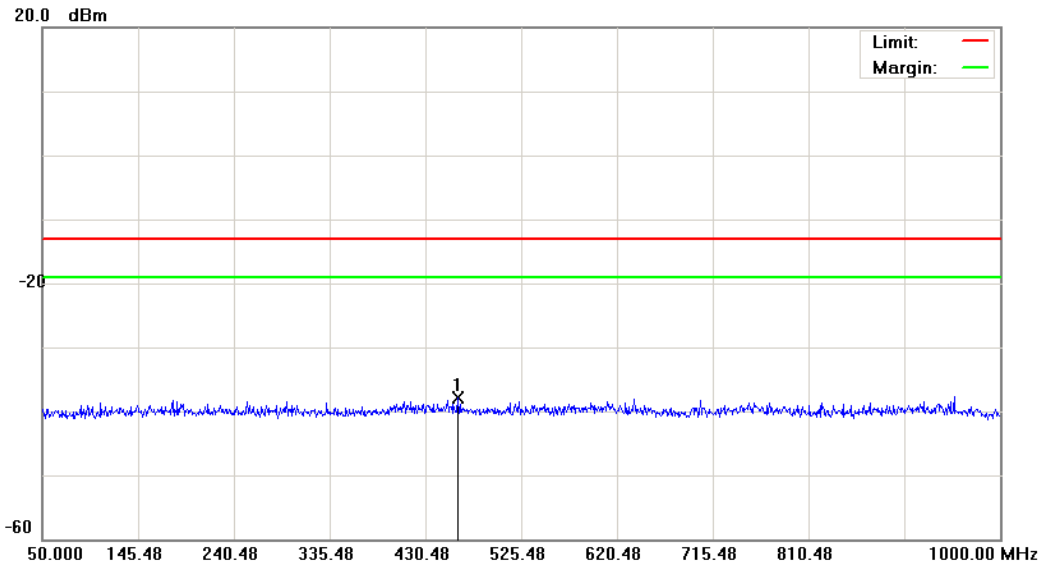

Site: : RF Conducted

 Polarization: **Conducted po**

Temperature: 23 °C

Limit: FCC Part 27 conducted(9k-12.75G)

Power: AC 120V/60Hz

Humidity: 55.2 %

EUT: 2G/3G Module

Distance:

RBW: 1000 KHz VBW: 1000 KHz

M/N: HE910

Mode: WCDMA Band IV

Note:

No.	Mk.	Freq.	Reading Level	Correct Factor	Measurement	Limit	Over	Antenna Height	Table Degree	Detector	Comment
		MHz	dBm	dB	dBm	dBm	dB	cm	degree		
1	*	462.3000	-51.10	13.20	-37.90	-13.00	-24.90			peak	

*:Maximum data x:Over limit !:over margin

File: HE910(CH1450)

Data: #3

Date: 2012/1/9

Time: 上午 09:48:18

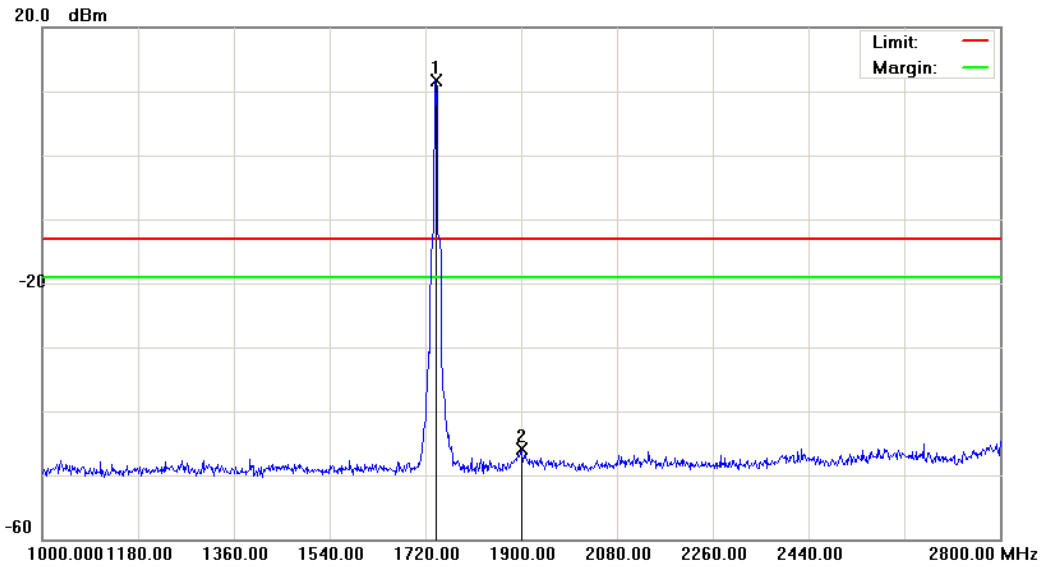

Site: RF Conducted	Polarization: Conducted po	Temperature: 23 °C
Limit: FCC Part 27 conducted(9k-12.75G)	Power: AC 120V/60Hz	Humidity: 55.2 %
EUT: 2G/3G Module	Distance:	RBW: 1000 KHz VBW: 1000 KHz
M/N: HE910		
Mode: WCDMA Band IV		
Note:		

No.	Mk.	Freq. MHz	Reading Level dBm	Correct Factor dB	Measure- ment dBm	Limit dBm	Over dB	Detector	Antenna Height cm	Table Degree degree	Comment
1	*	1738.900	7.09	4.66	11.75	-13.00	24.75	peak			Tx
2		1900.000	-52.51	6.63	-45.88	-13.00	-32.88	peak			

*:Maximum data x:Over limit !:over margin

File: HE910(CH1450)

Data: #4

Date: 2012/1/9

Time: 上午 10:01:10

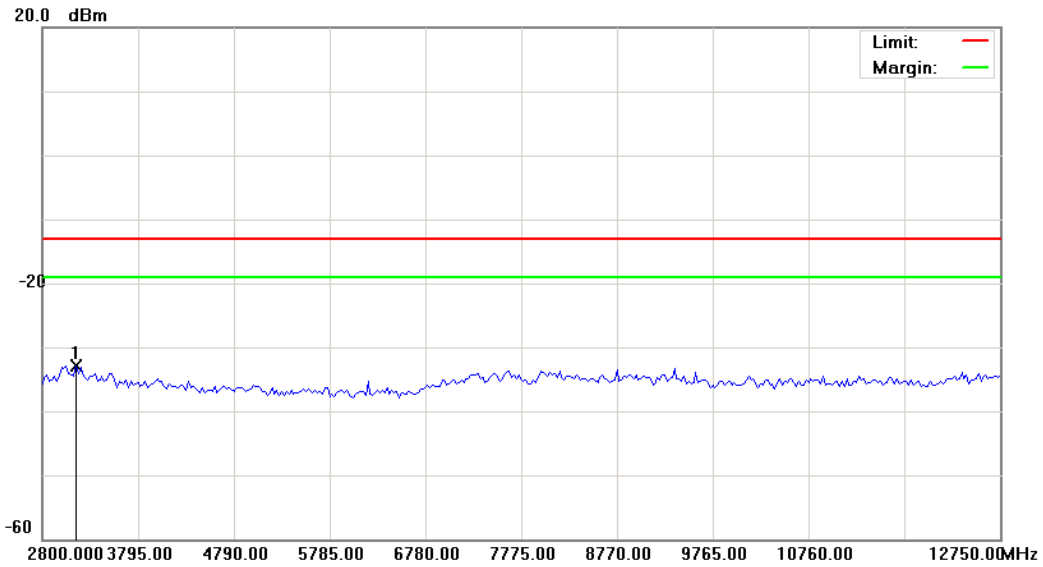

Site: : RF Conducted

 Polarization: **Conducted po**

Temperature: 23 °C

Limit: FCC Part 27 conducted(9k-12.75G)

Power: AC 120V/60Hz

Humidity: 55.2 %

EUT: 2G/3G Module

Distance:

RBW: 1000 KHz VBW: 1000 KHz

M/N: HE910

Mode: WCDMA Band IV

Note:

No.	Mk.	Freq.	Reading Level	Correct Factor	Measurement	Limit	Over	Antenna Height	Table Degree	Detector	Comment
		MHz	dBm	dB	dBm	dBm	dB	cm	degree		
1	*	3148.250	-38.24	5.27	-32.97	-13.00	-19.97			peak	

*:Maximum data x:Over limit !:over margin

File: HE910(CH1450)

Data: #5

Date: 2012/1/9

Time: 上午 10:01:32

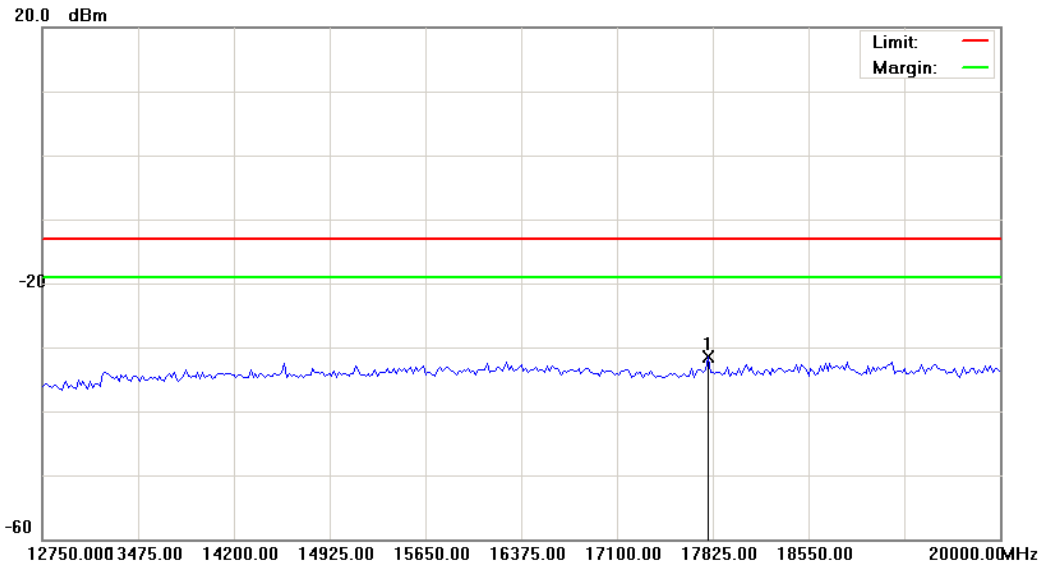

Site: : RF Conducted	Polarization: Conducted po	Temperature: 23 °C
Limit: FCC Part 27 conducted(9k-12.75G)	Power: AC 120V/60Hz	Humidity: 55.2 %
EUT: 2G/3G Module	Distance:	RBW: 1000 KHz VBW: 1000 KHz
M/N: HE910		
Mode: WCDMA Band IV		
Note:		

No.	Mk.	Freq.	Reading Level	Correct Factor	Measurement	Limit	Over	Antenna Height	Table Degree	Comment
		MHz	dBm	dB	dBm	dBm	dB	cm	degree	
1	*	17788.750	-38.38	6.81	-31.57	-13.00	-18.57	peak		

*:Maximum data x:Over limit !:over margin

File: HE910(CH1513)

Data: #1

Date: 2012/1/9

Time: 上午 09:43:44

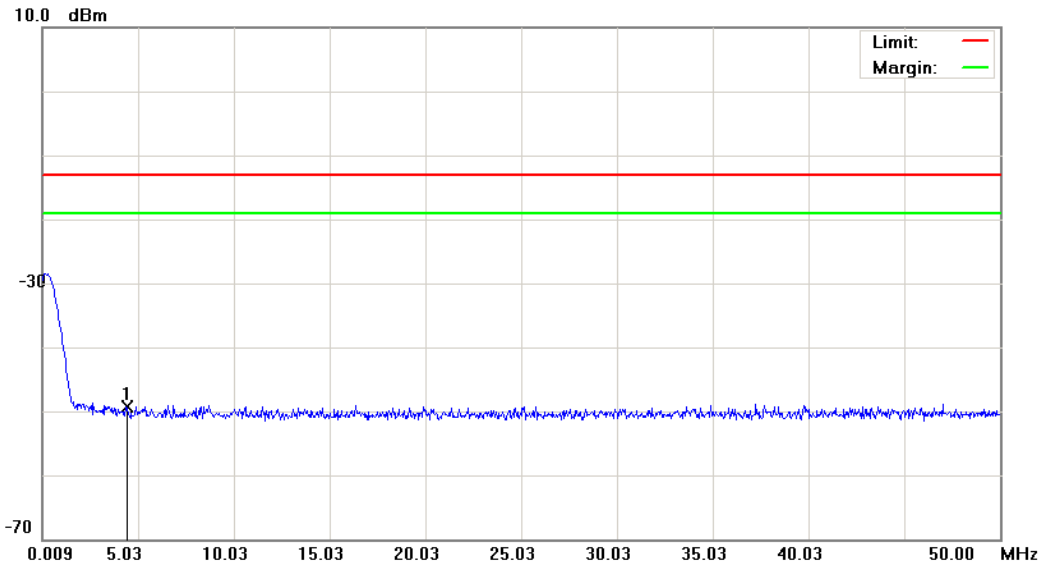

Site: : RF Conducted

 Polarization: **Conducted po**

Temperature: 23 °C

Limit: FCC Part 27 conducted(9k-12.75G)

Power: AC 120V/60Hz

Humidity: 55.2 %

EUT: 2G/3G Module

Distance:

RBW: 1000 KHz VBW: 1000 KHz

M/N: HE910

Mode: WCDMA Band IV

Note:

No.	Mk.	Freq.	Reading Level	Correct Factor	Measurement	Limit	Over	Antenna Height	Table Degree	Detector	Comment
		MHz	dBm	dB	dBm	dBm	dB	cm	degree		
1	*	4.3832	-62.44	13.22	-49.22	-13.00	-36.22			peak	

*:Maximum data x:Over limit !:over margin

File: HE910(CH1513)

Data: #2

Date: 2012/1/9

Time: 上午 09:44:09

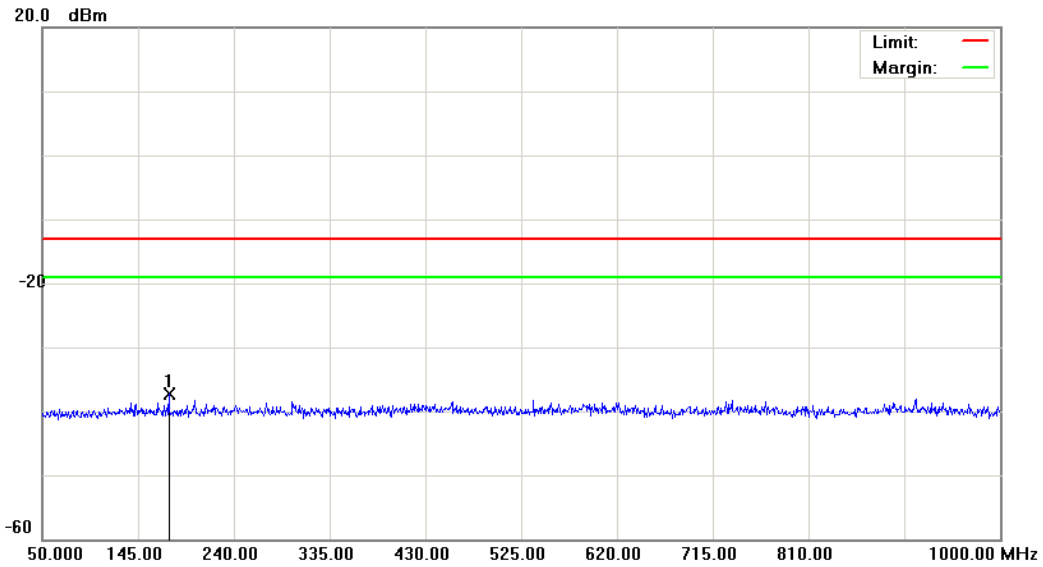

Site: : RF Conducted	Polarization: Conducted po	Temperature: 23 °C
Limit: FCC Part 27 conducted(9k-12.75G)	Power: AC 120V/60Hz	Humidity: 55.2 %
EUT: 2G/3G Module	Distance:	RBW: 1000 KHz VBW: 1000 KHz
M/N: HE910		
Mode: WCDMA Band IV		
Note:		

No.	Mk.	Freq.	Reading Level	Correct Factor	Measurement	Limit	Over	Antenna Height	Table Degree	
		MHz	dBm	dB	dBm	dBm	dB	Detector	cm	degree
1	*	175.4000	-50.61	13.29	-37.32	-13.00	-24.32	peak		Comment

*:Maximum data x:Over limit !:over margin

File: HE910(CH1513)

Data: #3

Date: 2012/1/9

Time: 上午 09:46:13

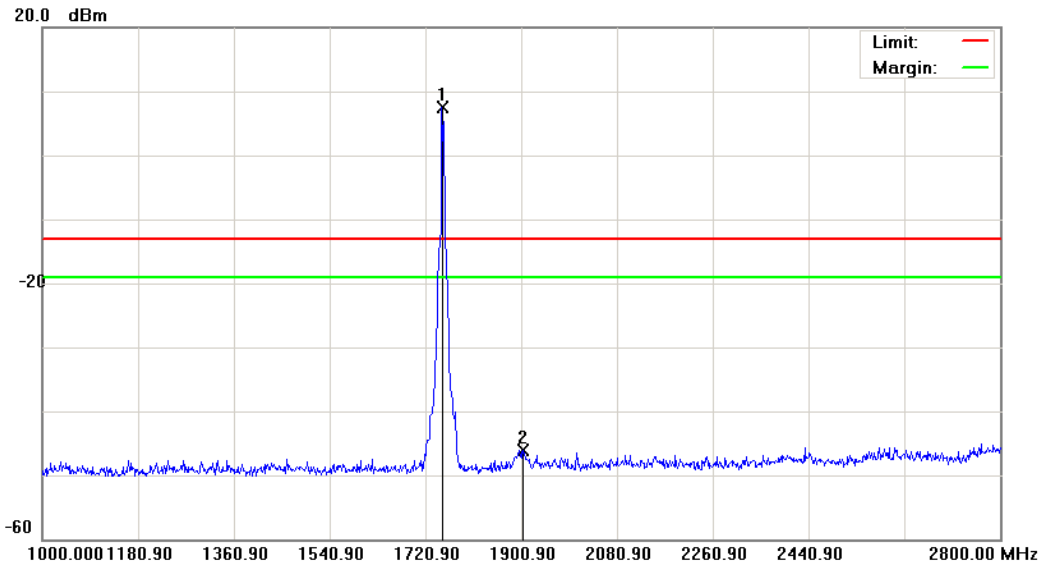

Site: RF Conducted

 Polarization: **Conducted po**

Temperature: 23 °C

Limit: FCC Part 27 conducted(9k-12.75G)

Power: AC 120V/60Hz

Humidity: 55.2 %

EUT: 2G/3G Module

Distance:

RBW: 1000 KHz VBW: 1000 KHz

M/N: HE910

Mode: WCDMA Band IV

Note:

No.	Mk.	Freq. MHz	Reading Level dBm	Correct Factor dB	Measure- ment dBm	Limit dBm	Over dB	Detector	Antenna Height cm	Table Degree degree	Comment
1	*	1751.500	2.86	4.63	7.49	-13.00	20.49	peak			Tx
2		1903.600	-52.33	6.30	-46.03	-13.00	-33.03	peak			

*:Maximum data x:Over limit !:over margin

File: HE910(CH1513)

Data: #4

Date: 2012/1/9

Time: 上午 10:02:27

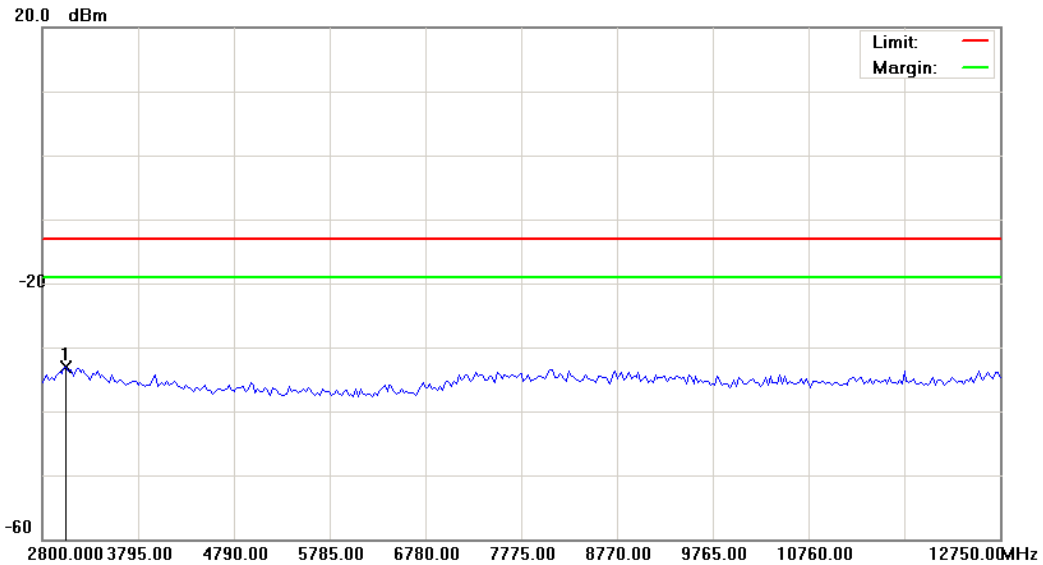

Site: : RF Conducted

 Polarization: **Conducted po**

Temperature: 23 °C

Limit: FCC Part 27 conducted(9k-12.75G)

Power: AC 120V/60Hz

Humidity: 55.2 %

EUT: 2G/3G Module

Distance:

RBW: 1000 KHz VBW: 1000 KHz

M/N: HE910

Mode: WCDMA Band IV

Note:

No.	Mk.	Freq.	Reading Level	Correct Factor	Measurement	Limit	Over	Antenna Height	Table Degree	Comment
		MHz	dBm	dB	dBm	dBm	dB	Detector	cm	degree
1	*	3048.750	-38.63	5.47	-33.16	-13.00	-20.16	peak		

*:Maximum data x:Over limit !:over margin

File: HE910(CH1513)

Data: #5

Date: 2012/1/9

Time: 上午 10:02:49

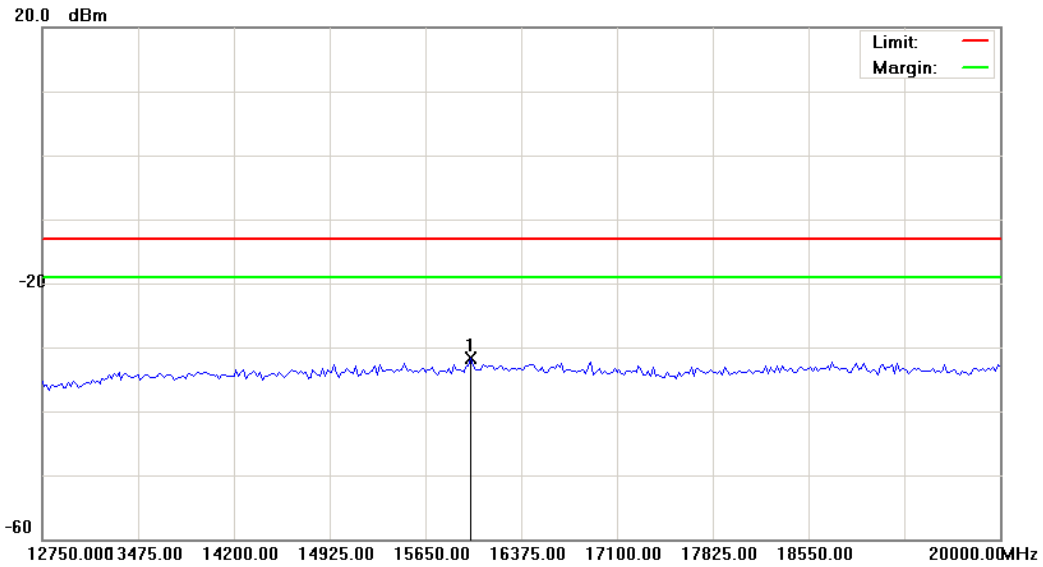

Site: : RF Conducted	Polarization: Conducted po	Temperature: 23 °C
Limit: FCC Part 27 conducted(9k-12.75G)	Power: AC 120V/60Hz	Humidity: 55.2 %
EUT: 2G/3G Module	Distance:	RBW: 1000 KHz VBW: 1000 KHz
M/N: HE910		
Mode: WCDMA Band IV		
Note:		

No.	Mk.	Freq.	Reading Level	Correct Factor	Measurement	Limit	Over	Antenna Height	Table Degree	Comment
		MHz	dBm	dB	dBm	dBm	dB	Detector	cm	degree
1	*	15994.375	-38.03	6.30	-31.73	-13.00	-18.73	peak		

*:Maximum data x:Over limit !:over margin

6 Field Strength of Spurious Radiation Test

6.1. Limit

The power of any emission outside of the authorized operating frequency ranges must be attenuated below the transmitting power (P) by a factor of at least $43 + 10\log(P)$ dB.

It is measured by means of a calibrated spectrum analyzer and scanned from 30 MHz up to a frequency including its 10th harmonic.

6.2. Test Instruments

3 Meter Chamber					
Equipment	Manufacturer	Model No.	Serial No.	Cal. Date	Remark
RF Pre-selector	Agilent	N9039A	MY46520256	05/23/2011	(2)
Spectrum Analyzer	Agilent	E4446A	MY46180578	01/18/2011	(1)
Pre Amplifier	Agilent	8449B	3008A02237	02/23/2011	(1)
Pre Amplifier	Agilent	8447D	2944A10961	02/23/2011	(1)
Broadband Antenna (30MHz~1GHz)	SCHWARZBECK MESS-ELEKTRONIK	VULB9163	9163-270	07/29/2011	(1)
Horn Antenna (1~18GHz)	SCHWARZBECK MESS-ELEKTRONIK	BBHA9120D	9120D-550	06/29/2011	(1)
Horn Antenna (18~40GHz)	SCHWARZBECK MESS-ELEKTRONIK	BBHA9170	9170-320	06/28/2011	(1)
Test Site	ATL	TE01	888001	12/20/2011	(1)

Remark: ⁽¹⁾ Calibration period 1 year. ⁽²⁾ Calibration period 2 years.

NOTE: N.C.R. = No Calibration Request.

6.3. Setup

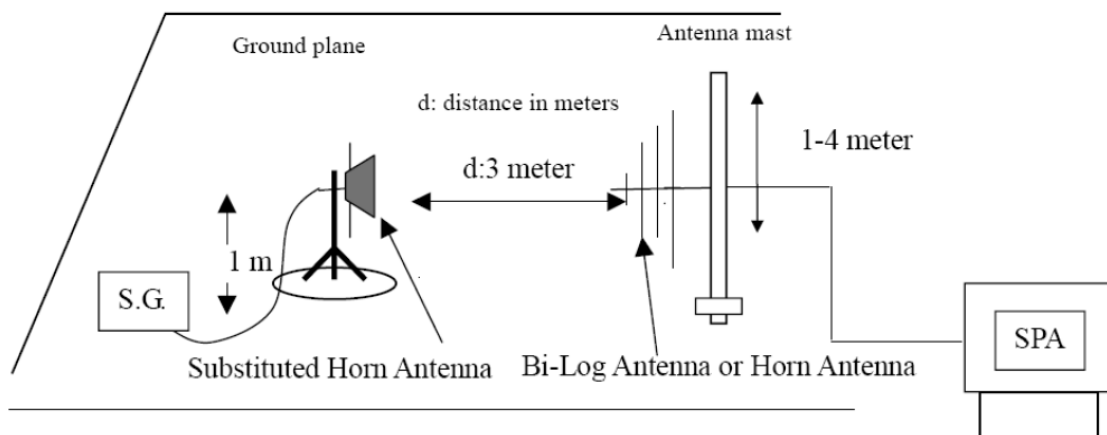

6.4. Test Procedure

The measurement is made according to ANSI/TIA-603-C-2004 as follows:

The equipment under test is placed inside the semi-anechoic chamber on a wooden table at the turntable center. For each spurious frequency, the antenna mast is raised and lowered from 1 to 4 meters and the turntable is rotated 360 degrees to obtain a maximum reading on the spectrum analyzer. This is repeated for both horizontal and vertical polarizations of the receive antenna.

The equipment under test is then replaced with a substitution antenna fed by a signal generator. With the signal generator tuned to a particular spurious frequency, the antenna mast is raised and lowered from 1 to 4 meters to obtain a maximum reading at the spectrum analyzer. The output of the signal generator is then adjusted until a reading identical to that obtained with the actual transmitter is achieved.

The power in dBm of each spurious emission is calculated by correcting the signal generator level for cable loss and gain of the substitution antenna referenced to a dipole. A fully charged battery was used for the supply voltage.

The settings of the receiver were as follows:

Units	dBm
Resolution Bandwidth	1 MHz
Video Bandwidth	Auto
Sweep Time	Auto

6.5. Uncertainty

The measurement uncertainty is defined as for Field Strength of Spurious Radiation measurement is ± 3.072 dB.

6.6. Test Result

Standard:	FCC Part 27	Test Distance:	3m
Test item:	Radiated Emission	Power:	AC 120V/60Hz
Model:	HE910	Temp.(°C)/Hum.(%RH):	26(°C)/60%RH
Mode:	Mode 1	Date:	12/06/2011
Frequency:	1712.4 MHz	Test By:	Charlie Chang

No.	Frequency (MHz)	Reading (dBm)	Correct Factor(dB)	Result (dBm)	Limit (dBm)	Margin (dB)	Remark	Ant.Polar. H / V
1	198.5000	-72.64	1.56	-71.08	-13.00	-58.08	peak	H
2	474.0000	-79.47	5.40	-74.07	-13.00	-61.07	peak	H
3	538.0000	-79.41	8.19	-71.22	-13.00	-58.22	peak	H
4	683.0000	-79.40	7.01	-72.39	-13.00	-59.39	peak	H
5	780.0000	-74.33	10.19	-64.14	-13.00	-51.14	peak	H
6	902.0000	-80.14	14.14	-66.00	-13.00	-53.00	peak	H
7	3952.000	-68.83	16.36	-52.47	-13.00	-39.47	peak	H
8	7744.000	-70.78	29.40	-41.38	-13.00	-28.38	peak	H
9	11068.000	-73.46	36.49	-36.97	-13.00	-23.97	peak	H
1	131.5000	-78.73	13.57	-65.16	-13.00	-52.16	peak	V
2	161.0000	-79.36	11.75	-67.61	-13.00	-54.61	peak	V
3	215.0000	-80.31	7.11	-73.20	-13.00	-60.20	peak	V
4	409.5000	-78.91	1.33	-77.58	-13.00	-64.58	peak	V
5	667.5000	-80.11	9.45	-70.66	-13.00	-57.66	peak	V
6	957.5000	-80.79	12.42	-68.37	-13.00	-55.37	peak	V
7	3424.000	-60.68	19.05	-41.63	-13.00	-28.63	peak	V
8	7216.000	-70.24	25.93	-44.31	-13.00	-31.31	peak	V
9	9868.000	-71.62	29.98	-41.64	-13.00	-28.64	peak	V

Standard:	FCC Part 27	Test Distance:	3m
Test item:	Radiated Emission	Power:	AC 120V/60Hz
Model:	HE910	Temp.(°C)/Hum.(%RH):	26(°C)/60%RH
Mode:	Mode 1	Date:	12/06/2011
Frequency:	1740.0 MHz	Test By:	Charlie Chang

No.	Frequency (MHz)	Reading (dBm)	Correct Factor(dB)	Result (dBm)	Limit (dBm)	Margin (dB)	Remark	Ant.Polar. H / V
1	37.5000	-76.18	8.89	-67.29	-13.00	-54.29	peak	H
2	198.0000	-72.03	1.11	-70.92	-13.00	-57.92	peak	H
3	451.5000	-78.50	4.31	-74.19	-13.00	-61.19	peak	H
4	552.5000	-80.01	7.97	-72.04	-13.00	-59.04	peak	H
5	745.0000	-79.98	8.42	-71.56	-13.00	-58.56	peak	H
6	859.5000	-81.44	13.00	-68.44	-13.00	-55.44	peak	H
7	5152.000	-70.49	20.58	-49.91	-13.00	-36.91	peak	H
8	7636.000	-71.76	29.31	-42.45	-13.00	-29.45	peak	H
9	10660.000	-72.64	34.84	-37.80	-13.00	-24.80	peak	H
1	140.0000	-73.73	8.94	-64.79	-13.00	-51.79	peak	V
2	283.5000	-77.63	1.23	-76.40	-13.00	-63.40	peak	V
3	493.0000	-79.84	2.62	-77.22	-13.00	-64.22	peak	V
4	530.0000	-79.58	3.68	-75.90	-13.00	-62.90	peak	V
5	741.0000	-80.07	10.51	-69.56	-13.00	-56.56	peak	V
6	863.5000	-80.50	11.48	-69.02	-13.00	-56.02	peak	V
7	3460.000	-63.93	19.26	-44.67	-13.00	-31.67	peak	V
8	6244.000	-71.94	23.80	-48.14	-13.00	-35.14	peak	V
9	7648.000	-70.87	26.46	-44.41	-13.00	-31.41	peak	V

Standard:	FCC Part 27	Test Distance:	3m
Test item:	Radiated Emission	Power:	AC 120V/60Hz
Model:	HE910	Temp.(°C)/Hum.(%RH):	26(°C)/60%RH
Mode:	Mode 1	Date:	12/06/2011
Frequency:	1752.6 MHz	Test By:	Charlie Chang

No.	Frequency (MHz)	Reading (dBm)	Correct Factor(dB)	Result (dBm)	Limit (dBm)	Margin (dB)	Remark	Ant.Polar. H / V
1	37.5000	-75.87	8.89	-66.98	-13.00	-53.98	peak	H
2	101.0000	-66.41	-2.10	-68.51	-13.00	-55.51	peak	H
3	336.5000	-80.96	-0.62	-81.58	-13.00	-68.58	peak	H
4	675.5000	-79.91	7.04	-72.87	-13.00	-59.87	peak	H
5	780.0000	-72.84	10.19	-62.65	-13.00	-49.65	peak	H
6	901.5000	-79.88	14.11	-65.77	-13.00	-52.77	peak	H
7	3508.000	-63.68	15.50	-48.18	-13.00	-35.18	peak	H
8	6952.000	-71.40	27.44	-43.96	-13.00	-30.96	peak	H
9	10756.000	-72.18	35.29	-36.89	-13.00	-23.89	peak	H
1	133.5000	-65.34	12.47	-52.87	-13.00	-39.87	peak	V
2	199.5000	-79.60	9.69	-69.91	-13.00	-56.91	peak	V
3	297.5000	-78.46	2.49	-75.97	-13.00	-62.97	peak	V
4	493.0000	-79.59	2.62	-76.97	-13.00	-63.97	peak	V
5	633.0000	-79.67	8.72	-70.95	-13.00	-57.95	peak	V
6	892.5000	-79.86	10.71	-69.15	-13.00	-56.15	peak	V
7	3508.000	-62.60	19.52	-43.08	-13.00	-30.08	peak	V
8	6172.000	-71.63	23.49	-48.14	-13.00	-35.14	peak	V
9	10708.000	-72.92	34.67	-38.25	-13.00	-25.25	peak	V

Standard:	FCC Part 27	Test Distance:	3m
Test item:	Radiated Emission	Power:	AC 120V/60Hz
Model:	HE910	Temp.(°C)/Hum.(%RH):	26(°C)/60%RH
Mode:	Mode 2	Date:	12/06/2011
		Test By:	Charlie Chang

No.	Frequency (MHz)	Reading (dBm)	Correct Factor(dB)	Result (dBm)	Peak Limit (dBm)	AVG. Limit (dBm)	Margin (dB)	Remark	Ant.Polar. H / V
1	3569.000	38.03	3.67	41.70	74.00	54.00	-32.30	peak	H
2	5473.000	35.05	9.91	44.96	74.00	54.00	-29.04	peak	H
3	6425.000	35.93	12.58	48.51	74.00	54.00	-25.49	peak	H
1	2862.000	37.09	1.73	38.82	74.00	54.00	-35.18	peak	V
2	4199.000	36.35	5.93	42.28	74.00	54.00	-31.72	peak	V
3	5557.000	35.05	10.08	45.13	74.00	54.00	-28.87	peak	V

7 Frequency Stability (Temperature Variation) Test

7.1. Limit

The frequency stability shall be measured by variation of ambient temperature and variation of primary supply voltage to ensure that the fundamental emission stays within the authorized frequency block. The frequency stability of the transmitter shall be maintained within $\pm 0.00025\%$ ($\pm 2.5\text{ppm}$) of the center frequency.

7.2. Test Instruments

Describe	Manufacturer	Model No.	Serial No.	Cal. Date	Remark
Universal Radio Communication Tester	ROHDE & SCHWARZ	CMU200	109369	08/10/2010	(2)
Temperature & Humidity Chamber	TAICHY	MHU-225LA	980729	08/24/2011	(1)
Test Site	ATL	TE05	TE05	N.C.R.	-----

Remark: ⁽¹⁾ Calibration period 1 year. ⁽²⁾ Calibration period 2 years.

NOTE: N.C.R. = No Calibration Request.

7.3. Setup

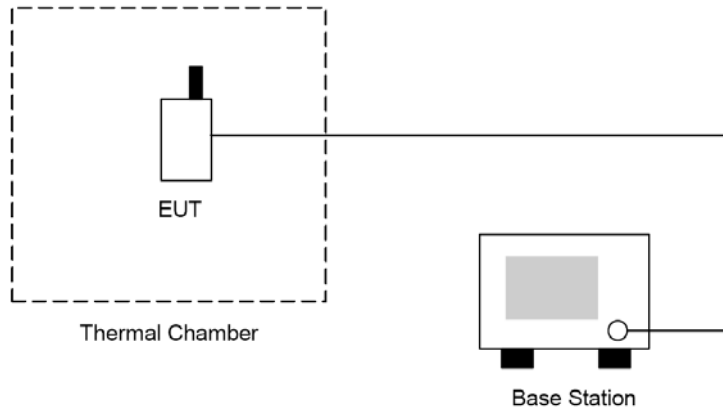

7.4. Test Procedure

The measurement is made according to FCC rules part 27:

1. The EUT and test equipment were set up as shown on the following section.
2. With all power removed, the temperature was decreased to -30°C and permitted to stabilize for three hours. Power was applied and the maximum change in frequency was noted within one minute.
3. With power OFF, the temperature was raised in 10°C steps. The sample was permitted to stabilize at each step for at least one-half hour. Power was applied and the maximum frequency change was noted within one minute.
4. The temperature tests were performed for the worst case.
5. Test data was recorded.

7.5. Uncertainty

The measurement uncertainty is defined as for Frequency Stability (Temperature Variation) measurement is $\pm 10\text{Hz}$.

7.6. Test Result

Product	2G/3G Module			
Test Item	Frequency Stability (Temperature Variation)			
Test Mode	Mode 1: WCDMA Band IV Link			
Date of Test	01/06/2012	Test Site		TE05
Temperature (°C)	Deviation (Hz)	Deviation (ppm)	Limit (ppm)	Result
-30	-6.00	-0.003	± 2.5	Pass
-20	-9.00	-0.005	± 2.5	Pass
-10	-7.00	-0.004	± 2.5	Pass
0	-10.00	-0.006	± 2.5	Pass
10	-11.00	-0.006	± 2.5	Pass
20	-11.00	-0.006	± 2.5	Pass
30	-6.00	-0.003	± 2.5	Pass
40	-9.00	-0.005	± 2.5	Pass
50	-10.00	-0.006	± 2.5	Pass

8 Frequency Stability (Voltage Variation) Test

8.1. Limit

The frequency stability shall be measured by variation of ambient temperature and variation of primary supply voltage to ensure that the fundamental emission stays within the authorized frequency block. The frequency stability of the transmitter shall be maintained within $\pm 0.00025\%$ ($\pm 2.5\text{ppm}$) of the center frequency.

8.2. Test Instruments

Describe	Manufacturer	Model No.	Serial No.	Cal. Date	Remark
Universal Radio Communication Tester	ROHDE & SCHWARZ	CMU200	109369	08/10/2010	(2)
Temperature & Humidity Chamber	TAICHY	MHU-225LA	980729	08/24/2011	(1)
Test Site	ATL	TE05	TE05	N.C.R.	-----

Remark: ⁽¹⁾ Calibration period 1 year. ⁽²⁾ Calibration period 2 years.

NOTE: N.C.R. = No Calibration Request.

8.3. Setup

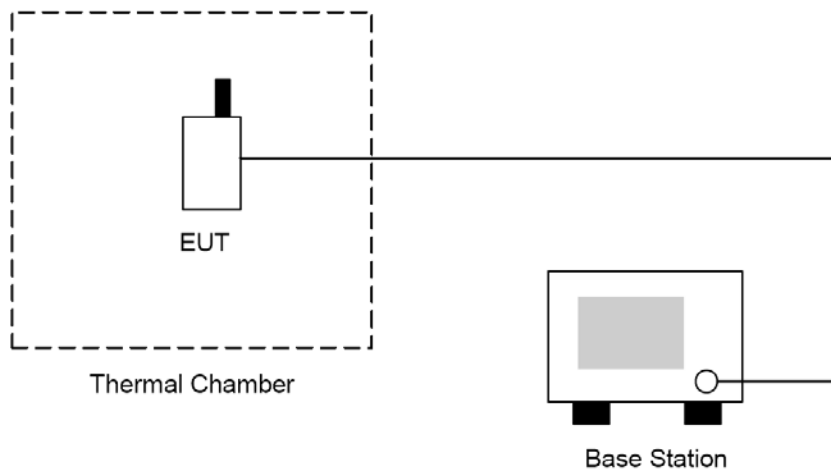

8.4. Test Procedure

1. The EUT was placed in a temperature chamber at $25 \pm 5^\circ\text{C}$ and connected as the following section.
2. The power supply voltage to the EUT was varied from BEP to 115% of the nominal value measured at the input to the EUT.
3. The variation in frequency was measured for the worst case.

8.5. Uncertainty

The measurement uncertainty is defined as for Frequency Stability (Voltage Variation) measurement is $\pm 10\text{Hz}$.

8.6. Test Result

Product	2G/3G Module				
Test Item	Frequency Stability (Voltage Variation)				
Test Mode	Mode 1: WCDMA Band IV Link				
Date of Test	01/06/2012		Test Site	TE05	
Level	Voltage (V)	Deviation (Hz)	Deviation (ppm)	Limit (ppm)	Result
High voltage	4.20	-13.00	-0.007	±2.5	Pass
Normal	3.80	-11.00	-0.006	±2.5	Pass
Low voltage	3.40	-8.00	-0.005	±2.5	Pass