

# Test report

**345868-2TRFWL**

Date of issue: February 9, 2018

Applicant:

**Edgewater Wireless Systems Inc**

Product:

**802.11a, miniPCI, 3-channel WiFi Radio Card**

Model:

**EWC5XGWFR1**

FCC ID:

**ATX-EWC5XGWFR1**

ISED Registration number:

**10165A-EWC5XGWFR1**

Specifications:

- ◆ **FCC 47 CFR Part 15 Subpart E, §15.407**  
Unlicensed National Information Infrastructure Devices
- ◆ **RSS-247, Issue 2, Section 6, February 2017**  
Digital Transmission Systems (DTSS), Frequency Hopping Systems (FHSs) and Licence-Exempt Local Area Network (LE-LAN) Devices

Test location

---

Company name	Nemko Canada Inc.
Address	303 River Road
City	Ottawa
Province	Ontario
Postal code	K1V 1H2
Country	Canada
Telephone	+1 613 737 9680
Facsimile	+1 613 737 9691
Toll free	+1 800 563 6336
Website	www.nemko.com
Site number	FCC: CA2040; ISED: 2040A-4 (3 m semi anechoic chamber)

Tested by	Andrey Adelberg, Senior Wireless/EMC Specialist
Reviewed by	Kevin Rose, Wireless/EMC Specialist
Review date	February 9, 2018
Reviewer signature	

Limits of responsibility

---

Note that the results contained in this report relate only to the items tested and were obtained in the period between the date of initial receipt of samples and the date of issue of the report.

This test report has been completed in accordance with the requirements of ISO/IEC 17025. All results contain in this report are within Nemko Canada's ISO/IEC 17025 accreditation.

Copyright notification

---

Nemko Canada Inc. authorizes the applicant to reproduce this report provided it is reproduced in its entirety and for use by the company's employees only. Any use which a third party makes of this report, or any reliance on or decisions to be made based on it, are the responsibility of such third parties. Nemko Canada Inc. accepts no responsibility for damages, if any, suffered by any third party as a result of decisions made or actions based on this report.  
© Nemko Canada Inc.

## Table of contents

<b>Table of contents</b> .....	<b>3</b>
<b>Section 1. Report summary</b> .....	<b>4</b>
1.1 Applicant and manufacturer .....	4
1.2 Test specifications .....	4
1.3 Test methods .....	4
1.4 Statement of compliance .....	4
1.5 Exclusions .....	4
1.6 Test report revision history .....	4
<b>Section 2. Summary of test results</b> .....	<b>5</b>
2.1 FCC Part 15 Subpart C, general requirements test results .....	5
2.2 FCC Part 15 Subpart E, test results .....	5
2.3 IC RSS-GEN, Issue 4, test results .....	5
2.4 IC RSS-247, Issue 2, test results .....	6
<b>Section 3. Equipment under test (EUT) details</b> .....	<b>7</b>
3.1 Sample information .....	7
3.2 EUT information .....	7
3.3 Technical information .....	7
3.4 Product description and theory of operation .....	7
3.5 EUT exercise details .....	8
3.6 EUT setup diagram .....	8
3.7 EUT sub assemblies .....	8
<b>Section 4. Engineering considerations</b> .....	<b>9</b>
4.1 Modifications incorporated in the EUT .....	9
4.2 Technical judgment .....	9
4.3 Deviations from laboratory tests procedures .....	9
<b>Section 5. Test conditions</b> .....	<b>10</b>
5.1 Atmospheric conditions .....	10
5.2 Power supply range .....	10
<b>Section 6. Measurement uncertainty</b> .....	<b>11</b>
6.1 Uncertainty of measurement .....	11
<b>Section 7. Test equipment</b> .....	<b>12</b>
7.1 Test equipment list .....	12
<b>Section 8. Testing data</b> .....	<b>13</b>
8.1 FCC 15.407(e) and RSS-247 6.2.4 (1) Minimum 6 dB bandwidth .....	13
8.2 RSS-Gen 6.6 Occupied bandwidth .....	16
8.3 FCC 15.407(a)(3) and RSS-247 6.2.4.1 - 5.725–5.85 GHz band output power and spectral density limits .....	19
8.4 FCC 15.407(b) and RSS-247 6.2.4.2 Undesirable (unwanted) emissions .....	27
8.5 FCC 15.207(a) and RSS-Gen 8.8 AC power line conducted emissions limits .....	41
8.6 FCC 15.407(g) and RSS-Gen 8.11 Frequency stability .....	45
<b>Section 9. Block diagrams of test set-ups</b> .....	<b>46</b>
9.1 Radiated emissions set-up for frequencies below 1 GHz .....	46
9.2 Radiated emissions set-up for frequencies above 1 GHz .....	47
9.3 Conducted emissions set-up .....	47
9.4 Antenna-port measurements set-up .....	48

## Section 1. Report summary

---

### 1.1 Applicant and manufacturer

---

Company name	Edgewater Wireless Systems Inc
Address	408 Churchill Ave, N
City	Ottawa
Province/State	Ontario
Postal/Zip code	K1Z 5C6
Country	Canada

### 1.2 Test specifications

---

FCC 47 CFR Part 15, Subpart E, Clause 15.407	Unlicensed National Information Infrastructure Devices
RSS-247, Issue 2, February 2017	Digital Transmission Systems (DTSS), Frequency Hopping Systems (FHSs) and Licence-Exempt Local Area Network (LE-LAN) Devices

### 1.3 Test methods

---

789033 D02 General U-NII Test Procedures New Rules v01r04	Guidelines for Compliance Testing of Unlicensed National Information Infrastructure (U-NII) Devices Part 15, Subpart E
ANSI C63.10 v2013	American National Standard of Procedures for Compliance Testing of Unlicensed Wireless Devices

### 1.4 Statement of compliance

---

In the configuration tested, the EUT was found compliant.

Testing was completed against all relevant requirements of the test standard. Results obtained indicate that the product under test complies in full with the requirements tested. The test results relate only to the items tested.

See "Summary of test results" for full details.

### 1.5 Exclusions

---

None

### 1.6 Test report revision history

---

Revision #	Details of changes made to test report
TRF	Original report issued

## Section 2. Summary of test results

### 2.1 FCC Part 15 Subpart C, general requirements test results

Part	Test description	Verdict
§15.31(e)	Variation of power source	Pass <sup>1</sup>
§15.203	Antenna requirement	Pass <sup>2</sup>

Notes: <sup>1</sup>Measurements of the variation of the input power or the radiated signal level of the fundamental frequency component of the emission, as appropriate, was performed with the supply voltage varied between 85 % and 115 % of the nominal rated supply voltage. No noticeable output power variation was observed

<sup>2</sup>The Antennas ports have unique RF connections: u-FL located on the EUT board.

### 2.2 FCC Part 15 Subpart E, test results

Part	Test description	Verdict
§15.403(i)	Emission bandwidth	Pass
§15.407(a)(1)	Power and density limits within 5.15–5.25 GHz band	Not applicable
§15.407(a)(2)	Power and density limits within 5.25–5.35 GHz and 5.47–5.725 GHz bands	Not applicable
§15.407(a)(3)	Power and density limits within 5.725–5.85 GHz band	Pass
§15.407(b)(1)	Undesirable emission limits for 5.15–5.25 GHz band	Not applicable
§15.407(b)(2)	Undesirable emission limits for 5.25–5.35 GHz band	Not applicable
§15.407(b)(3)	Undesirable emission limits for 5.47–5.725 GHz bands	Not applicable
§15.407(b)(4)	Undesirable emission limits for 5.725–5.85 GHz band	Pass
§15.407(b)(6)	Conducted limits for U-NII devices using an AC power line	Pass
§15.407(e)	Minimum 6 dB bandwidth of U-NII devices within the 5.725–5.85 GHz band	Pass
§15.407(g)	Frequency stability	Pass
§15.407(h)(1) <sup>1</sup>	Transmit power control (TPC)	Not applicable
§15.407(h)(2) <sup>1</sup>	Dynamic Frequency Selection (DFS)	Not applicable

Note: <sup>1</sup>DFS and TPC requirements are only applicable to 5.25–5.35 GHz and 5.47–5.725 GHz bands

### 2.3 IC RSS-GEN, Issue 4, test results

Part	Test description	Verdict
6.6	Occupied Bandwidth	Pass
7.1.2 <sup>1</sup>	Receiver radiated emission limits	Not applicable
7.1.3 <sup>1</sup>	Receiver conducted emission limits	Not applicable
8.8	Power Line Conducted Emissions Limits for Licence-Exempt Radio Apparatus	Pass
8.11 <sup>2</sup>	Frequency stability	Pass

Notes: <sup>1</sup>According to sections 5.2 and 5.3 of RSS-Gen, Issue 4: if EUT does not have a stand-alone receiver neither scanner receiver, then it exempt from receiver requirements.

<sup>2</sup>According to section 8.11 of RSS-Gen, Issue 4: if the frequency stability of the licence-exempt radio apparatus is not specified in the applicable standard (RSS), measurement of the frequency stability is not required

## 2.4 IC RSS-247, Issue 2, test results

Section	Test description	Verdict
6.1 <sup>1</sup>	Types of Modulation	Pass
6.2.1.1	Power limits for 5150–5250 MHz band	Not applicable
6.2.2.1	Power limits for 5250–5350 MHz band	Not applicable
6.2.3.1	Power limits for 5470–5600 MHz and 5650–5725 MHz bands	Not applicable
6.2.4.1	Power limits for 5725–5850 MHz band	Pass
6.2.4.1	Minimum 6 dB bandwidth	Pass
6.2.1.2	Unwanted emission limits for 5150–5250 MHz band	Not applicable
6.2.2.2	Unwanted emission limits for 5250–5350 MHz band	Not applicable
6.2.2.2	TPC requirements for devices with a maximum e.i.r.p. greater than 500 mW	Not applicable
6.2.2.3	e.i.r.p. at different elevations restrictions for 5250–5350 MHz band	Not applicable
6.2.3.2	Unwanted emission limits for 5470–5600 MHz and 5650–5725 MHz bands	Not applicable
6.2.4.2	Unwanted emission limits for 5725–5850 MHz band	Pass
6.3	Dynamic Frequency Selection (DFS) for devices operating in the bands 5250–5350 MHz, 5470–5600 MHz and 5650–5725 MHz	Not applicable

Notes: <sup>1</sup> The EUT employs digital modulation: 802.11a

## Section 3. Equipment under test (EUT) details

### 3.1 Sample information

Receipt date	January 15, 2018
Nemko sample ID number	1

### 3.2 EUT information

Product name	802.11a, miniPCI, 3-channel WiFi Radio Card
Model	EWCSXGWFR1
Serial number	EWP161215A00159

### 3.3 Technical information

Applicant IC company number	10165A
IC UPN number	EWCSXGWFR1
All used IC test site(s) Reg. number	2040A-4
RSS number and Issue number	RSS-247 Issue 2, Section 6, February 2017
Frequency band	5725–5850 MHz
Frequency Min (MHz)	5745
Frequency Max (MHz)	5805
RF power Min (W)	N/A
RF power Max (W), Conducted	0.238 (23.77 dBm)
Field strength, Units @ distance	N/A
Measured BW (kHz) (6 dB)	16538 (per channel of operation)
Measured BW (kHz) (99%)	16410 (per channel of operation)
Calculated BW (kHz), as per TRC-43	N/A
Type of modulation	802.11a
Emission classification (F1D, G1D, D1D)	W7D
Transmitter spurious (dBμV/m) @ 3 m	53.96 (average at 5.025 GHz)
Power requirements	48 V <sub>DC</sub> from PoE power supply (120 V <sub>AC</sub> , 60 Hz)
Antenna information	L-Com. Triple Element Dual Polarized Flat Panel Antenna, M/N: HG2458-14DP-3NF, Gain 14 dBi Laird Tech. Tri-band whip omnidirectional antenna, M/N: RD2458-5, Gain 5 dBi For Canada, only 5 dBi antenna is used. The EUT uses a unique antenna coupling/ non-detachable antenna to the intentional radiator.

### 3.4 Product description and theory of operation

The EWCSXGWFR1 is a wide-band, multi-channel, wireless LAN Mini-PCI module utilizing the Edgewater EWC3000 chip set. The EWCSXGWFR1 Module is compliant with IEEE802.11a (Wi-Fi) operating at 5150–5250 MHz U-NII-1 band and 5725–5850 MHz U-NII-3 band. Based on Edgewater's proprietary silicon technology the EWCSXGWFR1 simultaneously supports 3 autonomous IEEE 802.11a MAC protocols in a highly integrated chipset.

### 3.5 EUT exercise details

---

Low, mid and high channels of the EUT as well as power level were controlled from laptop using PuTTY session.

2-carrier operation is a simultaneous transmission from two adjacent non-overlapping channels.

- Tested at the bottom of the band and at the top of the band.

3-carrier operation is a simultaneous transmission from three adjacent non-overlapping channels.

- Tested at the bottom of the band and at the top of the band.

### 3.6 EUT setup diagram

---

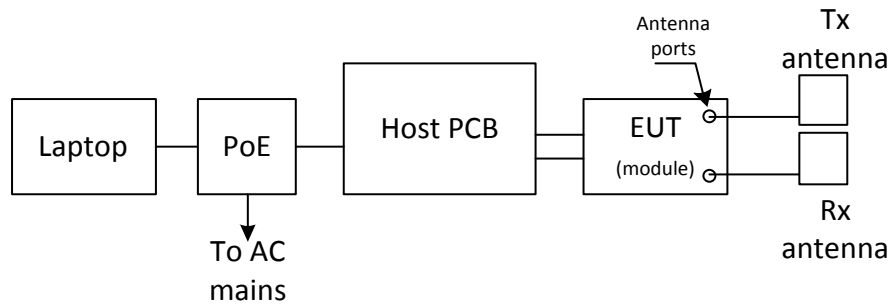

*Figure 3.6-1: Setup diagram*

### 3.7 EUT sub assemblies

---

*Table 3.7-1: EUT sub assemblies*

Description	Brand name	Model/Part number	Serial number
Laptop	Lenovo	x220i	4286CTO
PoE	Ubiquity	GP-C500-120G	1645-0003257
Host PCB	Gateworks	GW2388-4	694622



## Section 4. Engineering considerations

---

---

### 4.1 Modifications incorporated in the EUT

---

There were no modifications performed to the EUT during this assessment.

### 4.2 Technical judgment

---

None

### 4.3 Deviations from laboratory tests procedures

---

No deviations were made from laboratory procedures.

## Section 5. Test conditions

---

### 5.1 Atmospheric conditions

---

Temperature	15–30 °C
Relative humidity	20–75 %
Air pressure	860–1060 mbar

---

When it is impracticable to carry out tests under these conditions, a note to this effect stating the ambient temperature and relative humidity during the tests shall be recorded and stated.

### 5.2 Power supply range

---

The normal test voltage for equipment to be connected to the mains shall be the nominal mains voltage. For the purpose of the present document, the nominal voltage shall be the declared voltage, or any of the declared voltages  $\pm 5\%$ , for which the equipment was designed.

## Section 6. Measurement uncertainty

---

---

### 6.1 Uncertainty of measurement

---

Measurement uncertainty budgets for the tests are detailed below. Measurement uncertainty calculations assume a coverage factor of  $K = 2$  with 95% certainty.

Test name	Measurement uncertainty, dB
All antenna port measurements	0.55
Conducted spurious emissions	1.13
Radiated spurious emissions	3.78
AC power line conducted emissions	3.55

## Section 7. Test equipment

### 7.1 Test equipment list

*Table 7.1-1: Equipment list*

Equipment	Manufacturer	Model no.	Asset no.	Cal cycle	Next cal.
3 m EMI test chamber	TDK	SAC-3	FA002047	1 year	Dec. 09/18
Flush mount turntable	Sunol	FM2022	FA002082	—	NCR
Controller	Sunol	SC104V	FA002060	—	NCR
Antenna mast	Sunol	TLT2	FA002061	—	NCR
AC Power source	Chenwa	2700M-10k	FA002716	—	VOU
Receiver/spectrum analyzer	Rohde & Schwarz	ESU 26	FA002043	1 year	Jan. 31/18
Spectrum analyzer	Rohde & Schwarz	FSU	FA001877	1 year	July 18/18
Horn antenna (1–18 GHz)	EMCO	3115	FA000825	1 year	June 21/18
Preamp (1–18 GHz)	ETS-Lindgren	124334	FA002877	1 year	Nov. 14/18
Horn antenna (18–40 GHz)	EMCO	3116	FA001847	1 year	June 27/18
Pre-amplifier (18–26 GHz)	Narda	BBS-1826N612	FA001550	—	VOU
Pre-amplifier (26–40 GHz)	Narda	DBL-2640N610	FA001556	—	VOU
LISN	Rohde & Schwarz	ENV216	FA002023	1 year	May 19/18
Temperature chamber	Thermotron	SM-16C	FA001030	1 year	NCR

Note: NCR - no calibration required, VOU - verify on use

## Section 8. Testing data

### 8.1 FCC 15.407(e) and RSS-247 6.2.4 (1) Minimum 6 dB bandwidth

#### 8.1.1 Definitions and limits

For equipment operating in the band 5725–5850 MHz, the minimum 6 dB bandwidth shall be at least 500 kHz.

#### 8.1.2 Test summary

Test date	January 15, 2018
Test engineer	Andrey Adelberg

#### 8.1.3 Observations, settings and special notes

Spectrum analyser settings:

Resolution bandwidth	approximately 1% of the emission bandwidth
Video bandwidth	> RBW
Detector mode	Peak
Trace mode	Max Hold

#### 8.1.4 Test data

**Table 8.1-1: 6 dB bandwidth results**

Application	Central frequency, MHz	6 dB bandwidth, MHz	Minimum limit, MHz	Margin, MHz
1-carrier	5745	16.538	0.500	16.038
	5785	16.346	0.500	15.846
	5805	16.487	0.500	15.987
2-carrier	5755	36.538	0.500	36.038
	5795	36.138	0.500	35.638
3-carrier	5765	56.090	0.500	55.590
	5785	56.410	0.500	55.910

8.1.4 Test data, continued

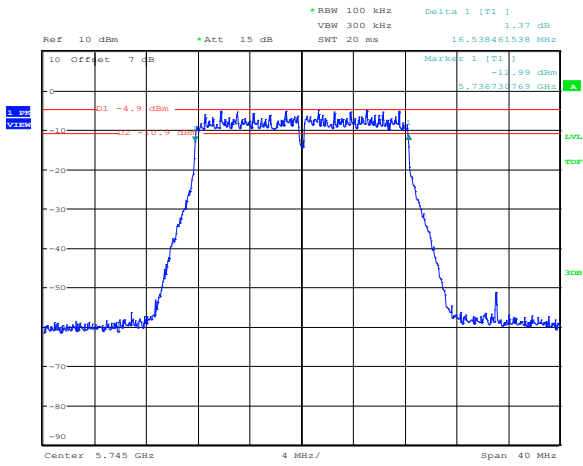

Date: 15.JAN.2018 13:31:44

Figure 8.1-1: 6 dB bandwidth at low channel, 1-carrier operation

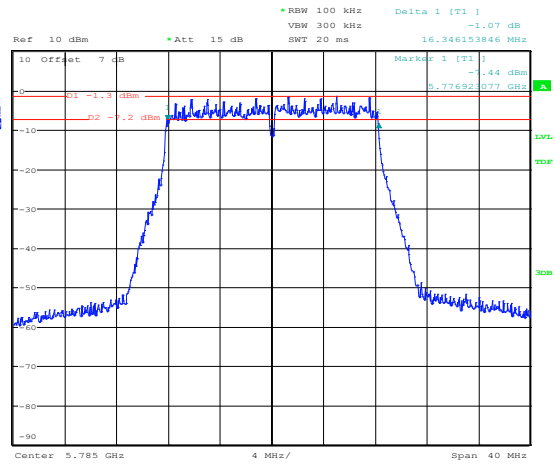

Date: 15.JAN.2018 13:34:40

Figure 8.1-2: 6 dB bandwidth at mid channel, 1-carrier operation

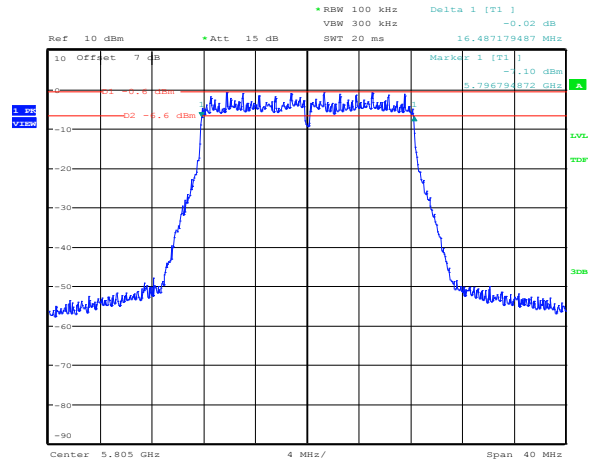

Date: 15.JAN.2018 13:36:30

Figure 8.1-3: 6 dB bandwidth at high channel, 1-carrier operation

**Section 8**  
**Test name**  
**Specification**

Testing data  
 FCC 15.407(e) and RSS-247 6.2.4.1 Minimum 6 dB bandwidth  
 FCC 15 Subpart E, RSS-247, Issue 2

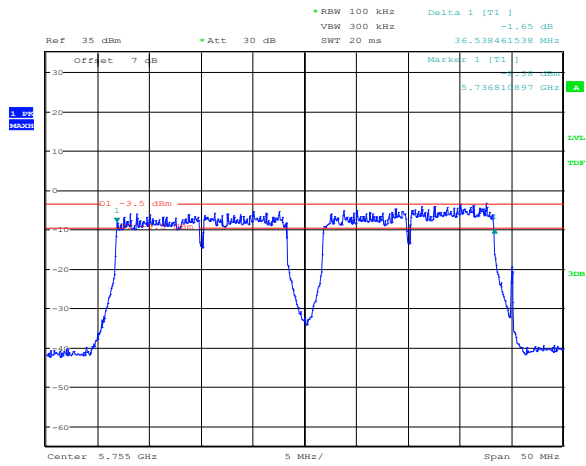

Date: 17.JAN.2018 12:33:27

**Figure 8.1-4:** 6 dB bandwidth at bottom of the band, 2-carrier operation

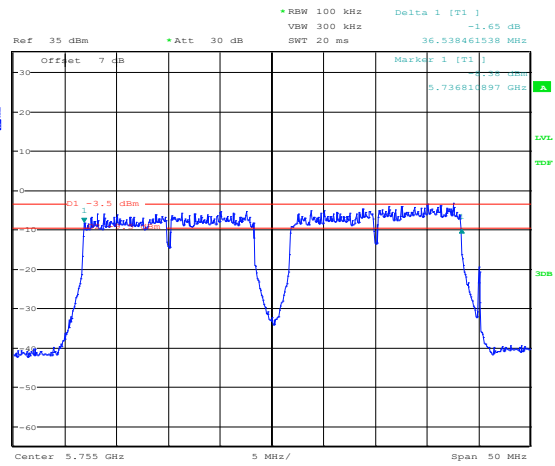

Date: 17.JAN.2018 12:33:27

**Figure 8.1-5:** 6 dB bandwidth at top of the band, 2-carrier operation

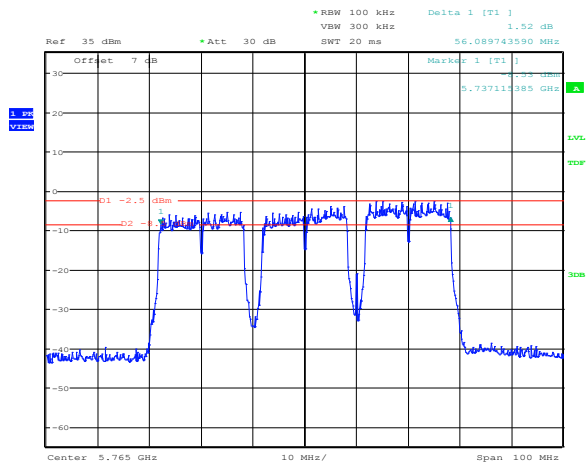

Date: 17.JAN.2018 13:06:35

**Figure 8.1-6:** 6 dB bandwidth at bottom of the band, 3-carrier operation

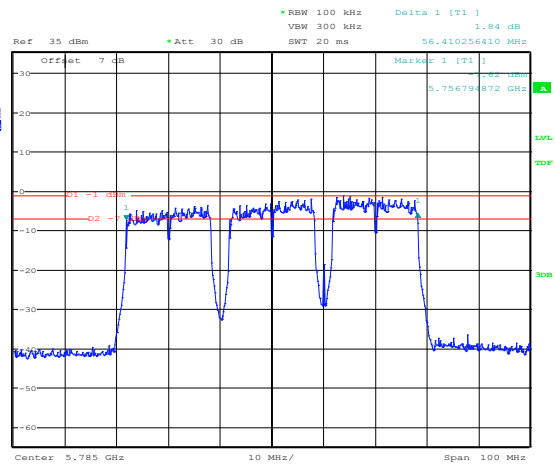

Date: 17.JAN.2018 13:00:06

**Figure 8.1-7:** 6 dB bandwidth at top of the band, 3-carrier operation

## 8.2 RSS-Gen 6.6 Occupied bandwidth

---

### 8.2.1 Definitions and limits

---

The emission bandwidth (×dB) is defined as the frequency range between two points, one above and one below the carrier frequency, at which the spectral density of the emission is attenuated × dB below the maximum in-band spectral density of the modulated signal. Spectral density (power per unit bandwidth) is to be measured with a detector of resolution bandwidth in the range of 1% to 5% of the anticipated emission bandwidth, and a video bandwidth at least 3× the resolution bandwidth.

When the occupied bandwidth limit is not stated in the applicable RSS or reference measurement method, the transmitted signal bandwidth shall be reported as the 99% emission bandwidth, as calculated or measured.

### 8.2.2 Test summary

---

Test date:	January 15, 2018
Test engineer:	Andrey Adelberg

### 8.2.3 Observations, settings and special notes

---

Spectrum analyser settings:

Resolution bandwidth:	≥ 1 % of OBW
Video bandwidth:	≥3 × RBW
Detector mode:	Peak
Trace mode:	Max Hold

### 8.2.4 Test data

---

**Table 8.2-1: 99 % bandwidth results**

Application	Central frequency, MHz	99 % occupied bandwidth, MHz
1-carrier	5745	16.346
	5785	16.346
	5805	16.410
2-carrier	5755	36.538
	5795	36.298
3-carrier	5765	56.250
	5785	56.250



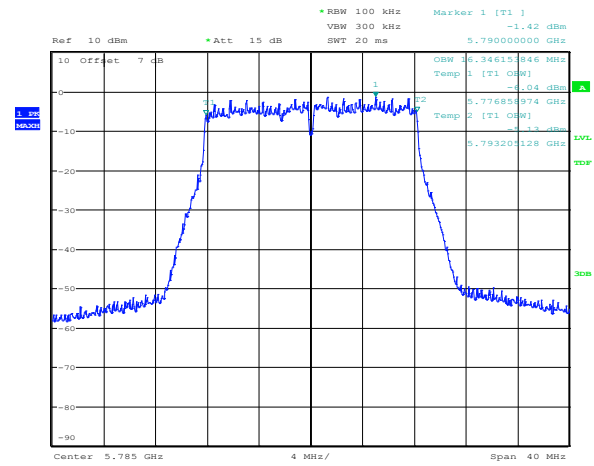
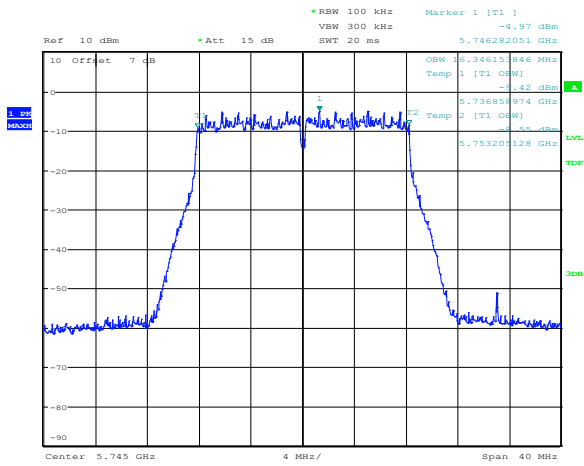

Date: 15.JAN.2018 13:32:43

Date: 15.JAN.2018 13:33:51

Figure 8.2-1: 99 % bandwidth at low channel, 1-carrier operation

Figure 8.2-2: 99 % bandwidth at mid channel, 1-carrier operation

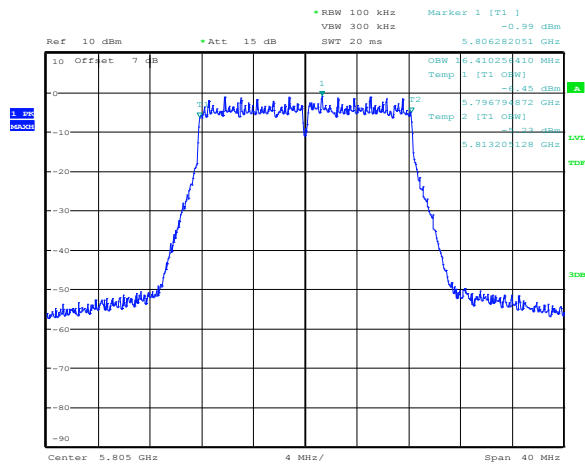

Date: 15.JAN.2018 13:37:01

Figure 8.2-3: 99 % bandwidth at high channel, 1-carrier operation

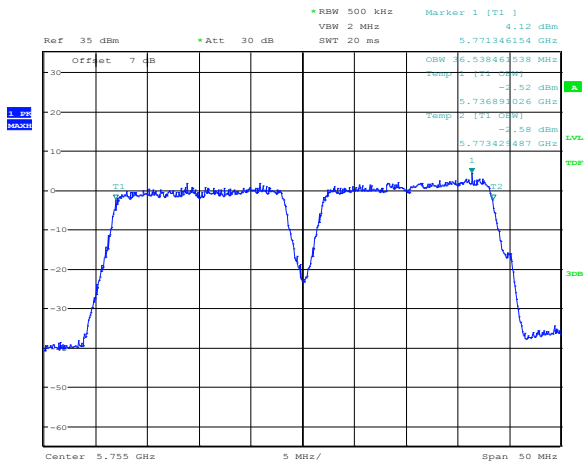

Date: 17.JAN.2018 12:31:59

Figure 8.2-4: 99 % bandwidth at bottom of the band, 2-carrier operation

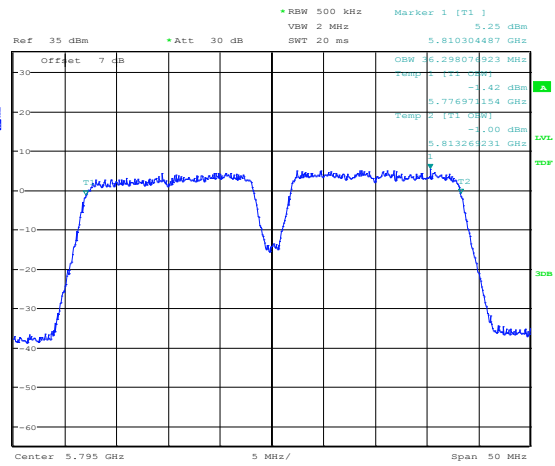

Date: 17.JAN.2018 12:39:58

Figure 8.2-5: 99 % bandwidth at top of the band, 2-carrier operation

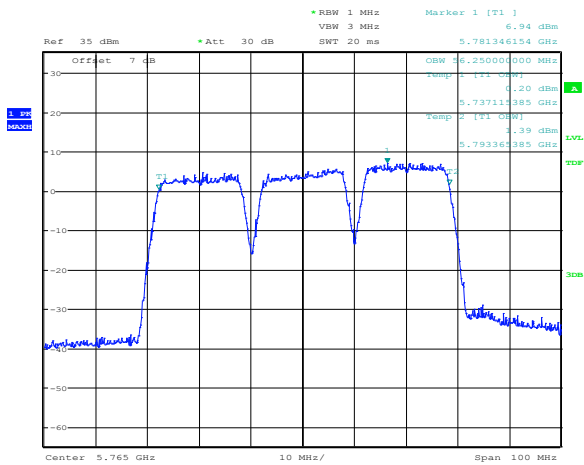

Date: 17.JAN.2018 13:05:43

Figure 8.2-6: 99 % bandwidth at bottom of the band, 3-carrier operation

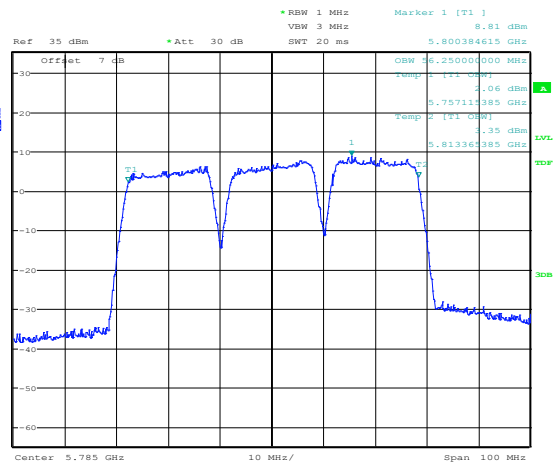

Date: 17.JAN.2018 12:59:27

Figure 8.2-7: 99 % bandwidth at top of the band, 3-carrier operation

## 8.3 FCC 15.407(a)(3) and RSS-247 6.2.4.1 - 5.725–5.85 GHz band output power and spectral density limits

---

### 8.3.1 Definitions and limits

---

**FCC:**

For the band 5.725–5.85 GHz, the maximum conducted output power over the frequency band of operation shall not exceed 1 W. In addition, the maximum power spectral density shall not exceed 30 dBm in any 500-kHz band. If transmitting antennas of directional gain greater than 6 dBi are used, both the maximum conducted output power and the maximum power spectral density shall be reduced by the amount in dB that the directional gain of the antenna exceeds 6 dBi. However, fixed point-to-point U-NII devices operating in this band may employ transmitting antennas with directional gain greater than 6 dBi without any corresponding reduction in transmitter conducted power. Fixed, point-to-point operations exclude the use of point-to-multipoint systems, omnidirectional applications, and multiple collocated transmitters transmitting the same information. The operator of the U-NII device, or if the equipment is professionally installed, the installer, is responsible for ensuring that systems employing high gain directional antennas are used exclusively for fixed, point-to-point operations.

**ISED:**

The maximum conducted output power shall not exceed 1 W. The power spectral density shall not exceed 30 dBm in any 500 kHz band. If transmitting antennas of directional gain greater than 6 dBi are used, both the maximum conducted output power and the power spectral density shall be reduced by the amount in dB that the directional gain of the antenna exceeds 6 dBi. However, fixed point-to-point devices operating in this band may employ transmitting antennas with directional gain greater than 6 dBi without any corresponding reduction in transmitter conducted power. Fixed point-to-point operations exclude the use of point-to-multipoint systems, omnidirectional applications and multiple collocated transmitters transmitting the same information.

### 8.3.2 Test summary

---

Test date:	January 15, 2018
Test engineer:	Andrey Adelberg

### 8.3.3 Observations, settings and special notes

---

For antennas with the directional gain greater than 6 dBi, the maximum output power limit was calculated as follows:

$$30 \text{ dBm} - (\text{Maximum antenna gain} - 6 \text{ dBi})$$

Limit for 14 dBi antenna:  $30 \text{ dBm} - (12.5 \text{ dBi} - 6 \text{ dBi}) = 23.5 \text{ dBm}$

Minimum declared cable loss of 1.5 dB was reduced from the maximum antenna gain.

For antennas with the directional gain greater than 6 dBi, the maximum power spectral density limit was calculated as follows:

$$30 \text{ dBm}/500 \text{ kHz} - (\text{Maximum antenna gain} - 6 \text{ dBi})$$

Limit for 14 dBi antenna:  $30 \text{ dBm}/500 \text{ kHz} - (12.5 \text{ dBi} - 6 \text{ dBi}) = 23.5 \text{ dBm}/500 \text{ kHz}$

Minimum declared cable loss of 1.5 dB was reduced from the maximum antenna gain.

**Section 8**

Testing data

**Test name**

FCC 15.407(a)(3) and RSS-247 6.2.4.1 - 5.725–5.85 GHz band output power and spectral density limits

**Specification**

FCC Part 15 Subpart E and RSS-247, Issue 2



8.3.4 Test data

**Table 8.3-1: Output power measurements results for 14 dBi antenna (USA)**

Application	Central frequency, MHz	Conducted output power, dBm	Power limit, dBm	Margin, dB
1-carrier	5745	18.75	23.50	4.75
	5785	21.28	23.50	2.22
	5805	21.98	23.50	1.52
2-carrier	5755	19.01	23.50	4.49
	5795	21.45	23.50	2.05
3-carrier	5765	19.71	23.50	3.79
	5785	18.97	23.50	4.53

**Table 8.3-2: Output power measurements results for 5 dBi antenna (USA)**

Application	Central frequency, MHz	Conducted output power, dBm	Power limit, dBm	Margin, dB
1-carrier	5745	18.75	30.00	11.25
	5785	21.28	30.00	8.72
	5805	21.98	30.00	8.02
2-carrier	5755	19.01	30.00	10.99
	5795	21.45	30.00	8.55
3-carrier	5765	19.71	30.00	10.29
	5785	18.97	30.00	11.03

**Table 8.3-3: Output power measurements results for 5 dBi antenna (Canada)**

Application	Central frequency, MHz	Conducted output power, dBm	Power limit, dBm	Margin, dB
1-carrier	5745	20.54	30.00	9.46
	5785	21.28	30.00	8.72
	5805	21.98	30.00	8.02
2-carrier	5755	21.81	30.00	8.19
	5795	23.77	30.00	6.23
3-carrier	5765	21.47	30.00	8.53
	5785	21.57	30.00	8.43

**Table 8.3-4: PPSD measurements results for 14 dBi antenna (USA)**

Application	Central frequency, MHz	PPSD, dBm/500 kHz	PPSD limit, dBm/500 kHz	Margin, dB
1-carrier	5745	4.76	23.50	18.74
	5785	7.87	23.50	15.63
	5805	8.01	23.50	15.49
2-carrier	5755	3.37	23.50	20.13
	5795	5.04	23.50	18.46
3-carrier	5765	2.10	23.50	21.40
	5785	-0.09	23.50	23.59

**Table 8.3-5: PPSD measurements results for 5 dBi antenna (USA)**

Application	Central frequency, MHz	PPSD, dBm/500 kHz	PPSD limit, dBm/500 kHz	Margin, dB
1-carrier	5745	4.76	30.00	25.24
	5785	7.87	30.00	22.13
	5805	8.01	30.00	21.99
2-carrier	5755	3.37	30.00	26.63
	5795	5.04	30.00	24.96
3-carrier	5765	2.10	30.00	27.90
	5785	1.36	30.00	28.64

Section 8

Testing data

Test name

FCC 15.407(a)(3) and RSS-247 6.2.4.1 - 5.725–5.85 GHz band output power and spectral density limits

Specification

FCC Part 15 Subpart E and RSS-247, Issue 2



Table 8.3-6: PPSD measurements results for 5 dBi antenna (Canada)

Application	Central frequency, MHz	PPSD, dBm/500 kHz	PPSD limit, dBm/500 kHz	Margin, dB
1-carrier	5745	6.49	30.00	23.51
	5785	7.87	30.00	22.13
	5805	8.01	30.00	21.99
2-carrier	5755	6.12	30.00	23.88
	5795	7.38	30.00	22.62
3-carrier	5765	3.66	30.00	26.34
	5785	3.92	30.00	26.08

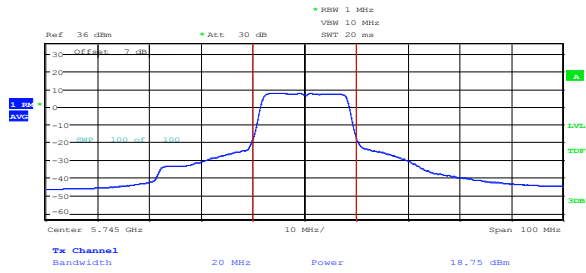

Date: 15.JAN.2018 15:50:38

Figure 8.3-1: Conducted output power at low channel, 1-carrier operation, 14 dBi antenna

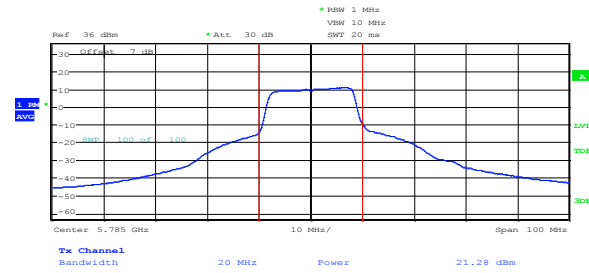

Date: 15.JAN.2018 15:46:32

Figure 8.3-2: Conducted output power at mid channel, 1-carrier operation, 14 dBi antenna

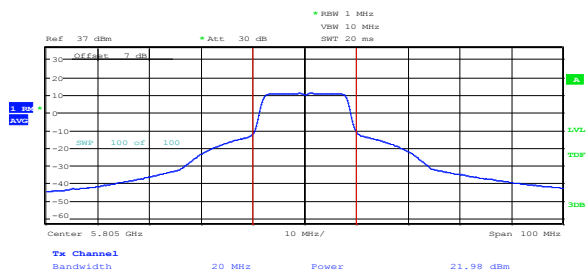

Date: 15.JAN.2018 15:59:12

Figure 8.3-3: Conducted output power at high channel, 1-carrier operation, 14 dBi antenna

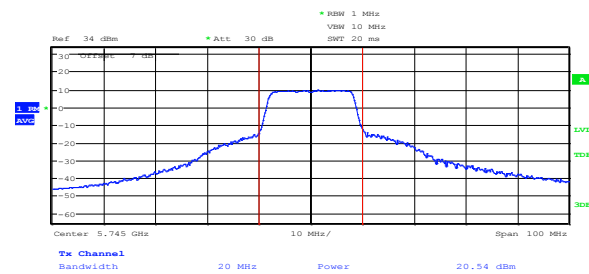

Date: 16.JAN.2018 16:25:09

Figure 8.3-4: Conducted output power at low channel, 1-carrier operation, 5 dBi antenna Canada

Note: for mid and high channels for Canada 5 dBi antenna power settings are the same as for FCC 14 dBi antenna.

Section 8

Test name

Specification

Testing data

FCC 15.407(a)(3) and RSS-247 6.2.4.1 - 5.725–5.85 GHz band output power and spectral density limits

FCC Part 15 Subpart E and RSS-247, Issue 2

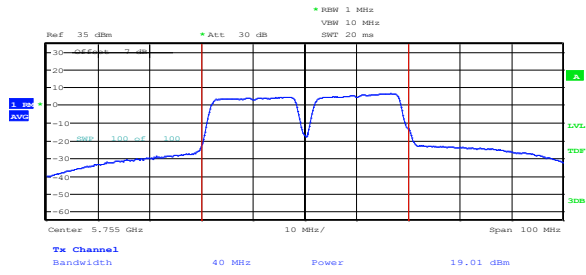

Date: 17.JAN.2018 10:37:04

Figure 8.3-5: Conducted output power at the bottom of the band, 2-carrier operation, USA

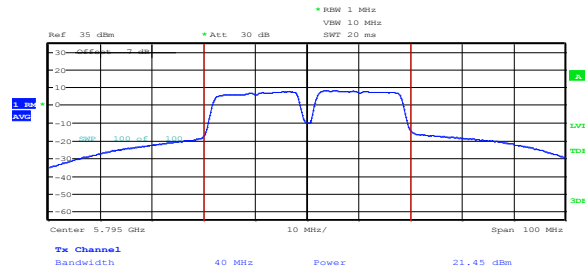

Date: 17.JAN.2018 10:46:13

Figure 8.3-6: Conducted output power at the top of the band, 2-carrier operation, USA

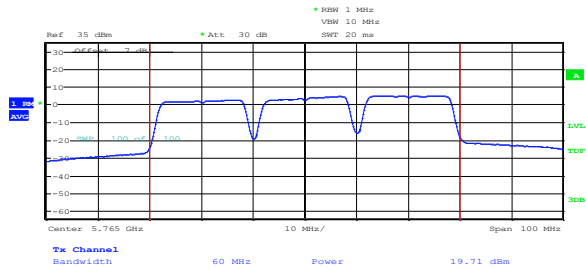

Date: 17.JAN.2018 11:24:00

Figure 8.3-7: Conducted output power at the bottom of the band, 3-carrier operation, USA

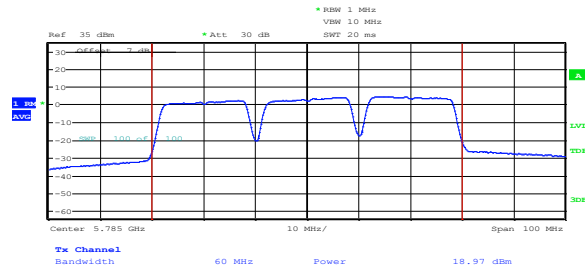

Date: 17.JAN.2018 11:32:07

Figure 8.3-8: Conducted output power at the top of the band, 3-carrier operation, USA

Section 8

Test name

Specification

Testing data  
 FCC 15.407(a)(3) and RSS-247 6.2.4.1 - 5.725–5.85 GHz band output power and spectral density limits  
 FCC Part 15 Subpart E and RSS-247, Issue 2

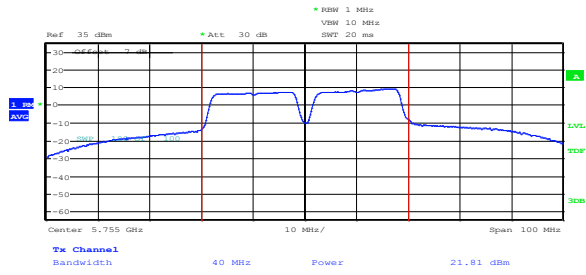

Date: 17.JAN.2018 11:56:18

Figure 8.3-9: Conducted output power at the bottom of the band, 2-carrier operation, Canada

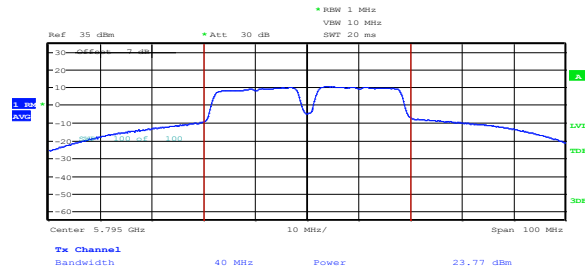

Date: 17.JAN.2018 11:59:53

Figure 8.3-10: Conducted output power at the top of the band, 2-carrier operation, Canada

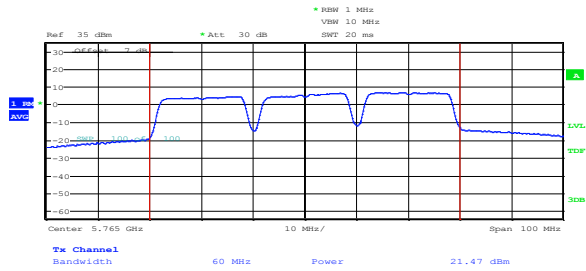

Date: 17.JAN.2018 10:59:11

Figure 8.3-11: Conducted output power at the bottom of the band, 3-carrier operation, Canada

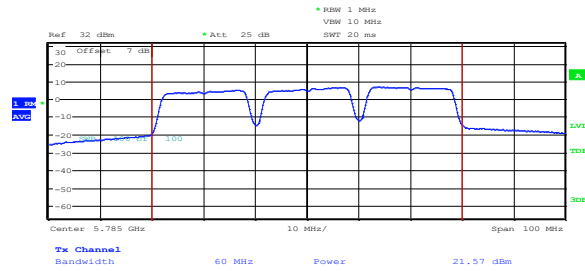

Date: 17.JAN.2018 11:09:38

Figure 8.3-12: Conducted output power at the top of the band, 3-carrier operation, Canada

Section 8

Test name

Specification

Testing data  
 FCC 15.407(a)(3) and RSS-247 6.2.4.1 - 5.725–5.85 GHz band output power and spectral density limits  
 FCC Part 15 Subpart E and RSS-247, Issue 2

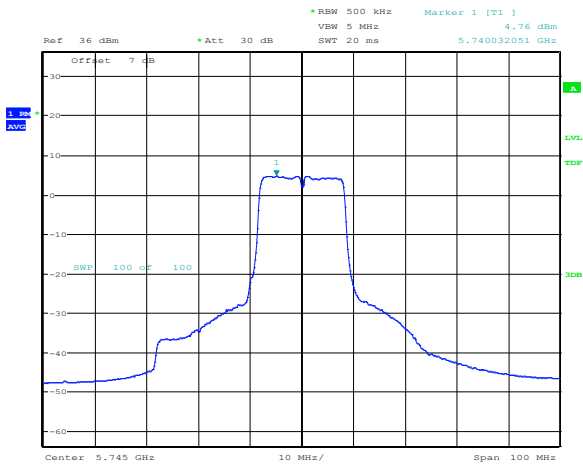

Date: 15.JAN.2018 15:50:10

Figure 8.3-13: Conducted PPSD at mid channel, 1-carrier operation, 14 dBi antenna

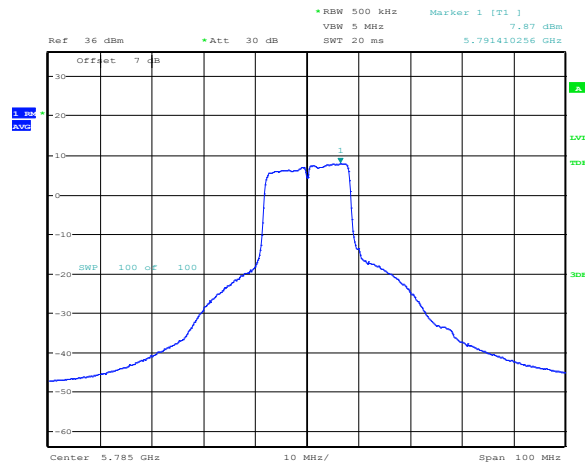

Date: 15.JAN.2018 15:48:22

Figure 8.3-14: Conducted PPSD at mid channel, 1-carrier operation, 14 dBi antenna

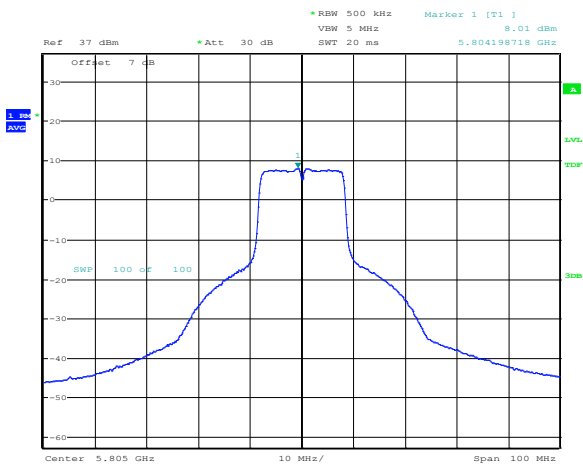

Date: 15.JAN.2018 15:59:49

Figure 8.3-15: Conducted PPSD at high channel, 1-carrier operation, 14 dBi antenna

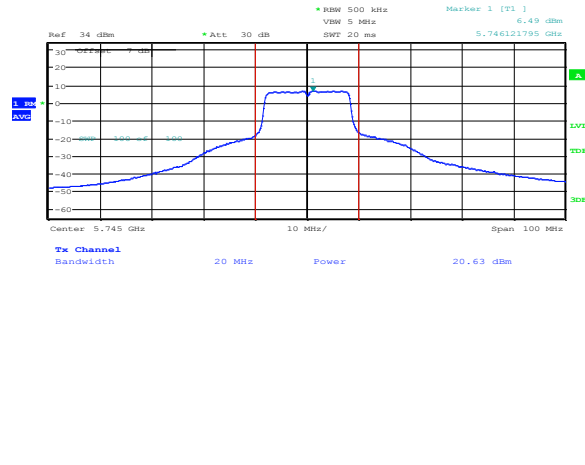

Date: 16.JAN.2018 16:26:03

Figure 8.3-16: Conducted PPSD at low channel, 1-carrier operation, 5 dBi antenna

Note: for mid and high channels for Canada 5 dBi antenna power settings are the same as for FCC 14 dBi antenna.



Section 8

Testing data

Test name

FCC 15.407(a)(3) and RSS-247 6.2.4.1 - 5.725–5.85 GHz band output power and spectral density limits

Specification

FCC Part 15 Subpart E and RSS-247, Issue 2

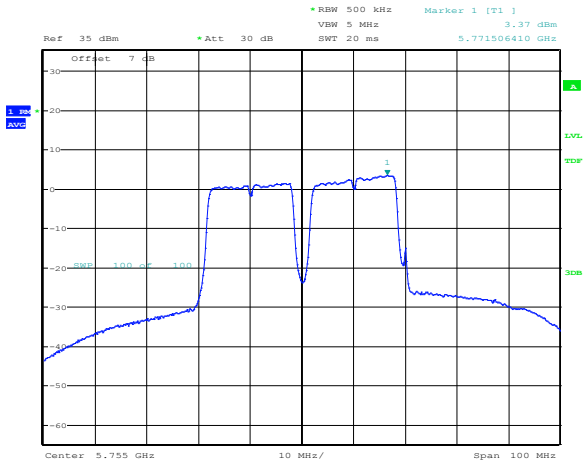

Date: 17.JAN.2018 10:40:29

Figure 8.3-17: Conducted PPSD at the bottom of the band, 2-carrier operation, USA

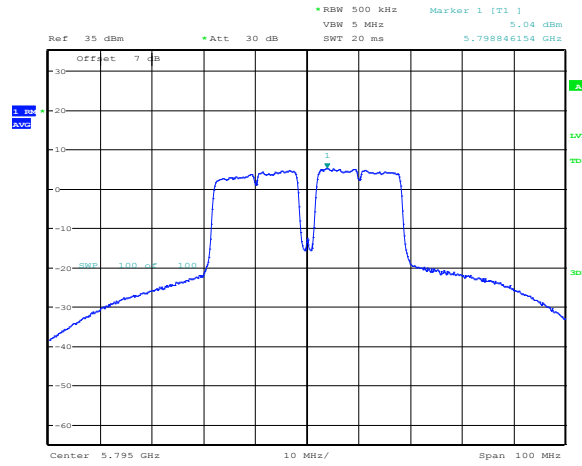

Date: 17.JAN.2018 10:48:00

Figure 8.3-18: Conducted PPSD at the top of the band, 2-carrier operation, USA

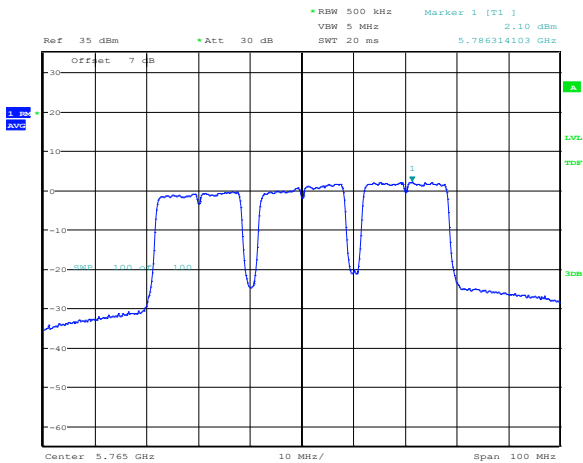

Date: 17.JAN.2018 11:24:35

Figure 8.3-19: Conducted PPSD at the bottom of the band, 3-carrier operation, USA

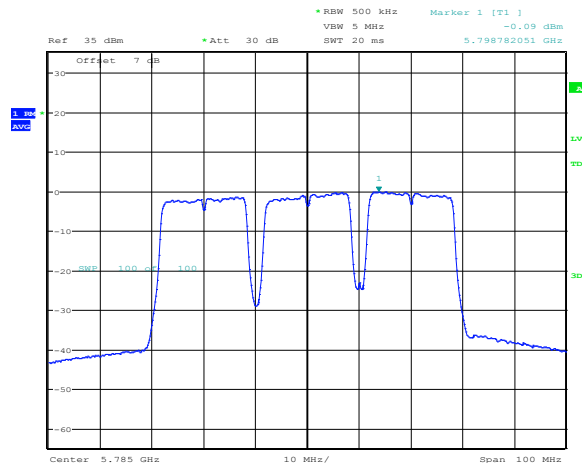

Date: 23.JAN.2018 11:04:45

Figure 8.3-20: Conducted PPSD at the top of the band, 3-carrier operation, USA

Section 8

Testing data

Test name

FCC 15.407(a)(3) and RSS-247 6.2.4.1 - 5.725–5.85 GHz band output power and spectral density limits

Specification

FCC Part 15 Subpart E and RSS-247, Issue 2

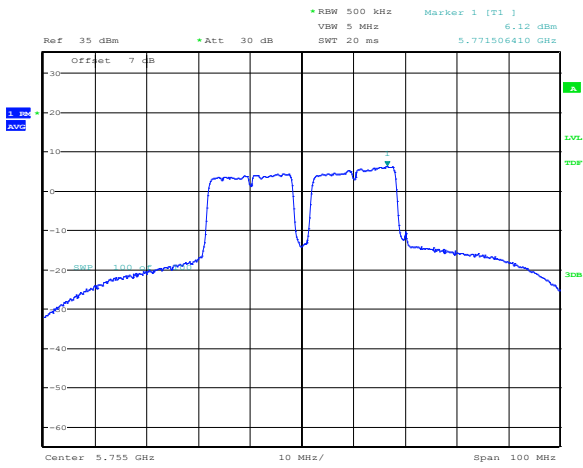

Date: 17.JAN.2018 11:56:58

Figure 8.3-21: Conducted PPSD at the bottom of the band, 2-carrier operation, Canada

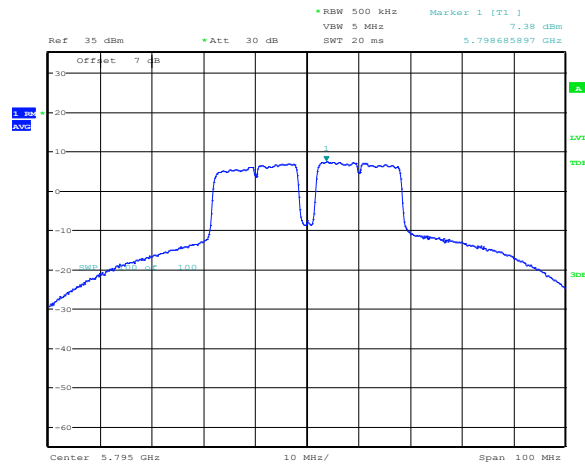

Date: 17.JAN.2018 12:00:31

Figure 8.3-22: Conducted PPSD at the top of the band, 2-carrier operation, Canada

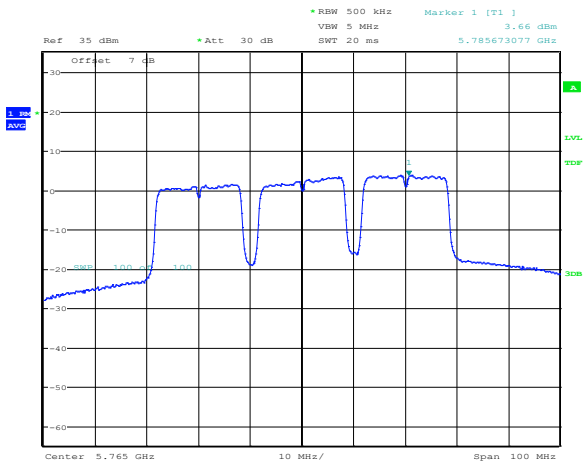

Date: 17.JAN.2018 11:00:25

Figure 8.3-23: Conducted PPSD at the bottom of the band, 3-carrier operation, Canada

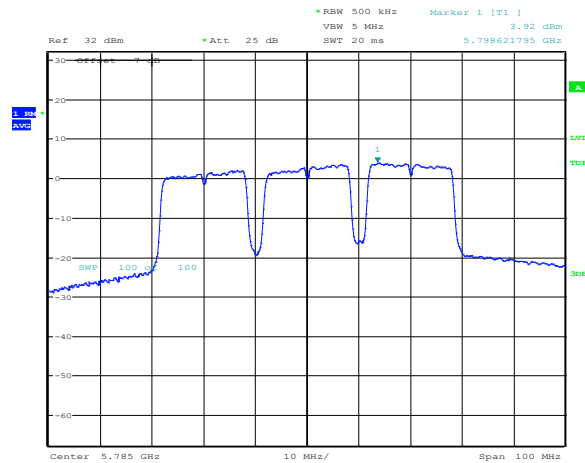

Date: 17.JAN.2018 11:10:19

Figure 8.3-24: Conducted PPSD at the top of the band, 3-carrier operation, Canada

## 8.4 FCC 15.407(b) and RSS-247 6.2.4.2 Undesirable (unwanted) emissions

### 8.4.1 Definitions and limits

#### FCC:

(1) For transmitters operating in the 5.725–5.85 GHz band: All emissions within the frequency range from the band edge to 10 MHz above or below the band edge shall not exceed an e.i.r.p. of –17 dBm/MHz; for frequencies 10 MHz or greater above or below the band edge, emissions shall not exceed an e.i.r.p. of –27 dBm/MHz.

(5) The emission measurements shall be performed using a minimum resolution bandwidth of 1 MHz. A lower resolution bandwidth may be employed near the band edge, when necessary, provided the measured energy is integrated to show the total power over 1 MHz.

(6) Unwanted emissions below 1 GHz must comply with the general field strength limits set forth in § 15.209.

(7) The provisions of § 15.205 apply to intentional radiators operating under this section.

(8) When measuring the emission limits, the nominal carrier frequency shall be adjusted as close to the upper and lower frequency block edges as the design of the equipment permits.

#### ISED:

Devices operating in the band 5725–5850 MHz shall have e.i.r.p. of unwanted emissions comply with the following:

- 27 dBm/MHz at frequencies from the band edges decreasing linearly to 15.6 dBm/MHz at 5 MHz above or below the band edges;
- 15.6 dBm/MHz at 5 MHz above or below the band edges decreasing linearly to 10 dBm/MHz at 25 MHz above or below the band edges;
- 10 dBm/MHz at 25 MHz above or below the band edges decreasing linearly to –27 dBm/MHz at 75 MHz above or below the band edges; and
- 27 dBm/MHz at frequencies more than 75 MHz above or below the band edges.

#### RSS-Gen 8.10 Emissions falling within restricted frequency bands

Restricted bands, identified in Table 8.4-2, are designated primarily for safety-of-life services (distress calling and certain aeronautical bands), certain satellite downlinks, radio astronomy and some government uses. Except where otherwise indicated, the following restrictions apply:

- fundamental components of modulation of licence-exempt radio apparatus shall not fall within the restricted bands of below;
- unwanted emissions falling into restricted bands of below shall comply with the limits specified in RSS-Gen;
- unwanted emissions not falling within restricted frequency bands shall either comply with the limits specified in the applicable RSS, or with those specified in RSS-Gen.

**Table 8.4-1: FCC §15.209 and RSS-Gen – Radiated emission limits**

Frequency, MHz	Field strength of emissions		Measurement distance, m
	µV/m	dBµV/m	
0.009–0.490	2400/F ( <i>F in kHz</i> )	67.6 – 20 × log <sub>10</sub> (F) ( <i>F in kHz</i> )	300
0.490–1.705	24000/F ( <i>F in kHz</i> )	87.6 – 20 × log <sub>10</sub> (F) ( <i>F in kHz</i> )	30
1.705–30.0	30	29.5	30
30–88	100	40.0	3
88–216	150	43.5	3
216–960	200	46.0	3
above 960	500	54.0	3

Notes: In the emission table above, the tighter limit applies at the band edges.

For frequencies above 1 GHz the limit on peak RF emissions is 20 dB above the maximum permitted average emission limit applicable to the equipment under test

### 8.4.1 Definitions and limits, continued

**Table 8.4-2: ISED restricted frequency bands**

MHz	MHz	MHz	GHz
0.090–0.110	12.51975–12.52025	399.9–410	5.35–5.46
2.1735–2.1905	12.57675–12.57725	608–614	7.25–7.75
3.020–3.026	13.36–13.41	960–1427	8.025–8.5
4.125–4.128	16.42–16.423	1435–1626.5	9.0–9.2
4.17725–4.17775	16.69475–16.69525	1645.5–1646.5	9.3–9.5
4.20725–4.20775	16.80425–16.80475	1660–1710	10.6–12.7
5.677–5.683	25.5–25.67	1718.8–1722.2	13.25–13.4
6.215–6.218	37.5–38.25	2200–2300	14.47–14.5
6.26775–6.26825	73–74.6	2310–2390	15.35–16.2
6.31175–6.31225	74.8–75.2	2655–2900	17.7–21.4
8.291–8.294	108–138	3260–3267	22.01–23.12
8.362–8.366	156.52475–156.52525	3332–3339	23.6–24.0
8.37625–8.38675	156.7–156.9	3345.8–3358	31.2–31.8
8.41425–8.41475	240–285	3500–4400	36.43–36.5
12.29–12.293	322–335.4	4500–5150	Above 38.6

Note: Certain frequency bands listed in Table 8.4-2 and above 38.6 GHz are designated for low-power license-exempt applications. These frequency bands and the requirements that apply to the devices are set out in this Standard

**Table 8.4-3: FCC restricted frequency bands**

MHz	MHz	MHz	GHz
0.090–0.110	16.42–16.423	399.9–410	4.5–5.15
0.495–0.505	16.69475–16.69525	608–614	5.35–5.46
2.1735–2.1905	16.80425–16.80475	960–1240	7.25–7.75
4.125–4.128	25.5–25.67	1300–1427	8.025–8.5
4.17725–4.17775	37.5–38.25	1435–1626.5	9.0–9.2
4.20725–4.20775	73–74.6	1645.5–1646.5	9.3–9.5
6.215–6.218	74.8–75.2	1660–1710	10.6–12.7
6.26775–6.26825	108–121.94	1718.8–1722.2	13.25–13.4
6.31175–6.31225	123–138	2200–2300	14.47–14.5
8.291–8.294	149.9–150.05	2310–2390	15.35–16.2
8.362–8.366	156.52475–156.52525	2483.5–2500	17.7–21.4
8.37625–8.38675	156.7–156.9	2690–2900	22.01–23.12
8.41425–8.41475	162.0125–167.17	3260–3267	23.6–24.0
12.29–12.293	167.72–173.2	3332–3339	31.2–31.8
12.51975–12.52025	240–285	3345.8–3358	36.43–36.5
12.57675–12.57725	322–335.4	3600–4400	Above 38.6
13.36–13.41			

### 8.4.2 Test summary

Test date:	January 16, 2018
Test engineer:	Andrey Adelberg

### 8.4.3 Observations, settings and special notes

---

The spectrum was searched from 30 MHz to 40 GHz.

EUT was set to transmit with 100 % duty cycle.

Radiated measurements were performed at a distance of 3 m up to 18 GHz. Above 18 GHz measurements were performed at a distance of 1 m.

Spectrum analyser for peak conducted measurements within restricted bands below 1 GHz:

Resolution bandwidth:	100 kHz
Video bandwidth:	300 kHz
Detector mode:	Peak
Trace mode:	Max Hold

Spectrum analyser for peak radiated measurements within restricted bands above 1 GHz:

Resolution bandwidth:	1 MHz
Video bandwidth:	3 MHz
Detector mode:	Peak
Trace mode:	Max Hold

Spectrum analyser for average radiated measurements within restricted bands above 1 GHz:

Resolution bandwidth:	1 MHz
Video bandwidth:	3 MHz
Detector mode:	RMS
Trace mode:	Averaging

Spectrum analyser for peak conducted measurements outside restricted bands:

Resolution bandwidth:	1 MHz
Video bandwidth:	3 MHz
Detector mode:	Peak
Trace mode:	Max Hold

8.4.4 Test data

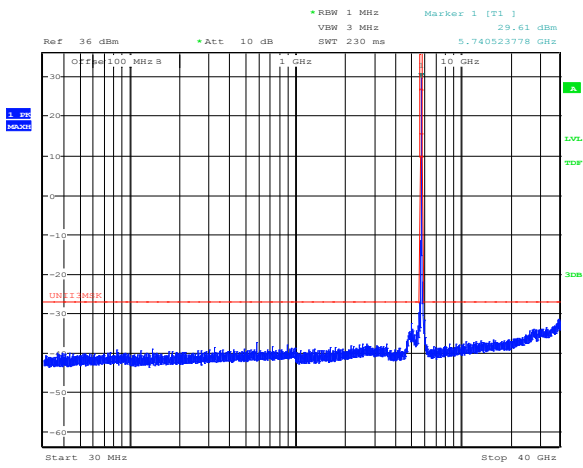

Date: 15.JAN.2018 16:14:52

**Figure 8.4-1:** Peak conducted spurious emissions outside restricted bands at low channel, 1-carrier operation

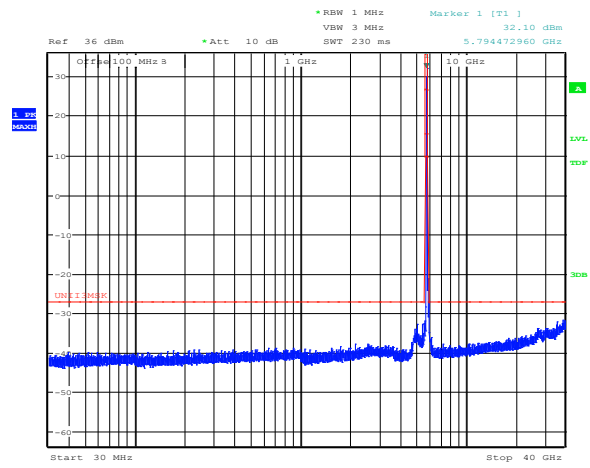

Date: 15.JAN.2018 16:09:44

**Figure 8.4-2:** Peak conducted spurious emissions outside restricted bands at mid channel, 1-carrier operation

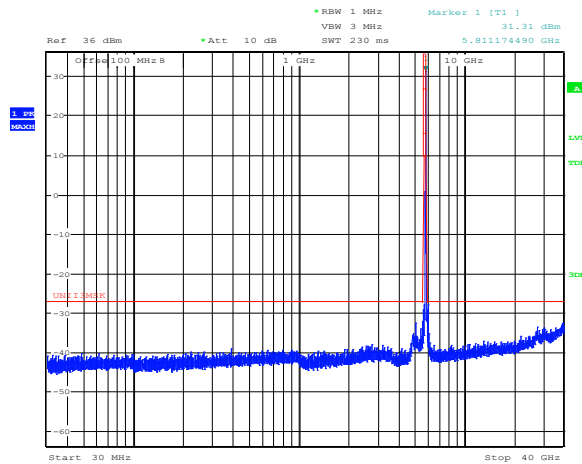

Date: 15.JAN.2018 16:16:36

**Figure 8.4-3:** Peak conducted spurious emissions outside restricted bands at high channel, 1-carrier operation

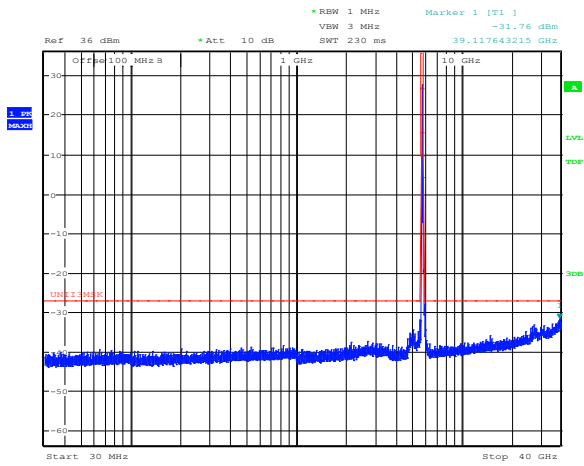

Date: 17.JAN.2018 13:27:48

**Figure 8.4-4:** Peak conducted spurious emissions outside restricted bands at the bottom of the band, 2-carrier operation

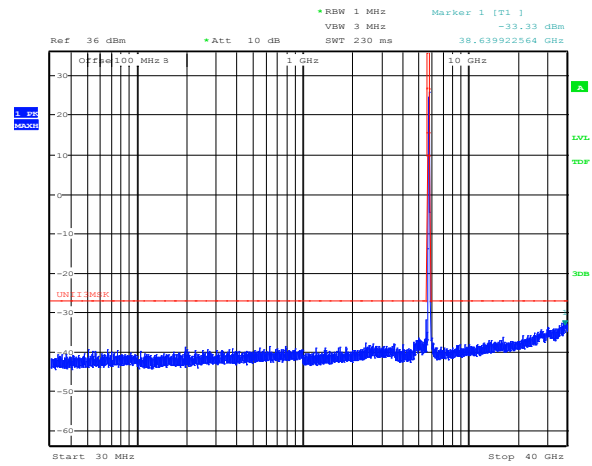

Date: 17.JAN.2018 11:33:26

**Figure 8.4-5:** Peak conducted spurious emissions outside restricted bands at the top of the band, 2-carrier operation

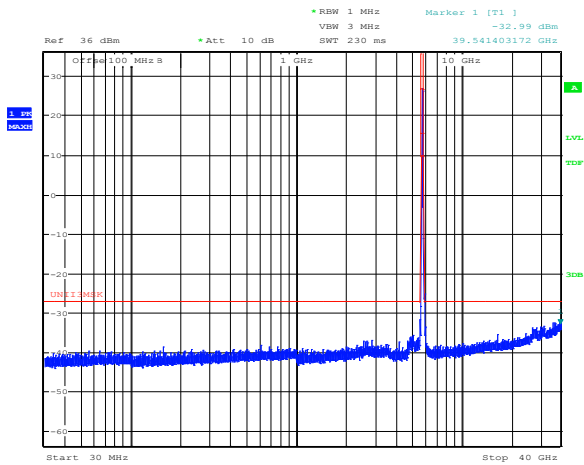

Date: 17.JAN.2018 11:25:41

**Figure 8.4-6:** Peak conducted spurious emissions outside restricted bands at the bottom of the band, 3-carrier operation

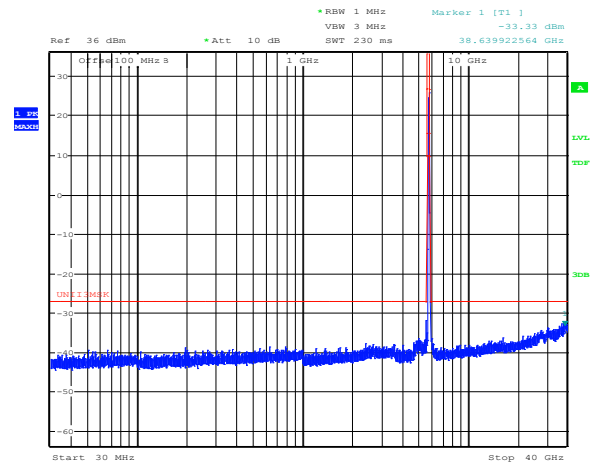

Date: 17.JAN.2018 11:33:26

**Figure 8.4-7:** Peak conducted spurious emissions outside restricted bands at the top of the band, 3-carrier operation

Note: in the plots below, EIRP limit line was adjusted to include antenna gain.

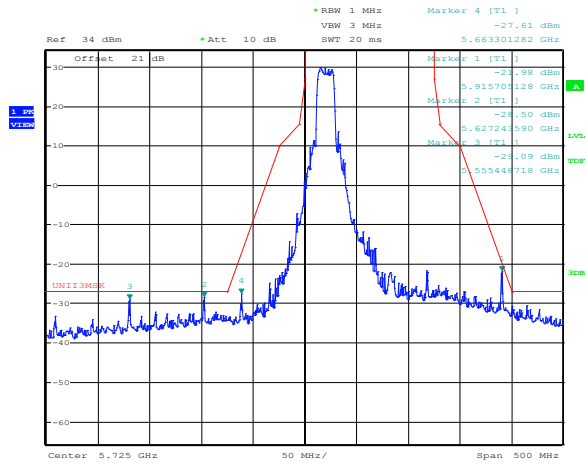

Date: 15.JAN.2018 15:41:18

**Figure 8.4-8:** Emission mask for 14 dBi antenna, low channel, 1-carrier operation

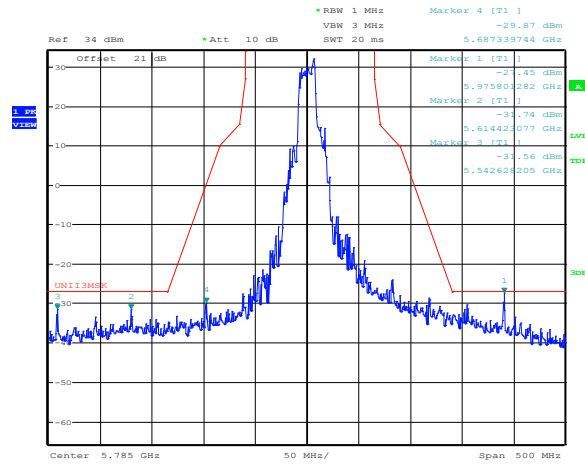

Date: 15.JAN.2018 15:44:36

**Figure 8.4-9:** Emission mask for 14 dBi antenna, mid channel, 1-carrier operation

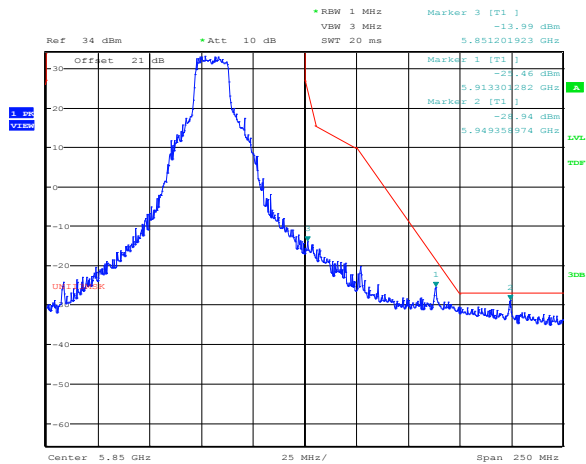

Date: 15.JAN.2018 15:31:44

**Figure 8.4-10:** Emission mask for 14 dBi antenna, high channel, 1-carrier operation

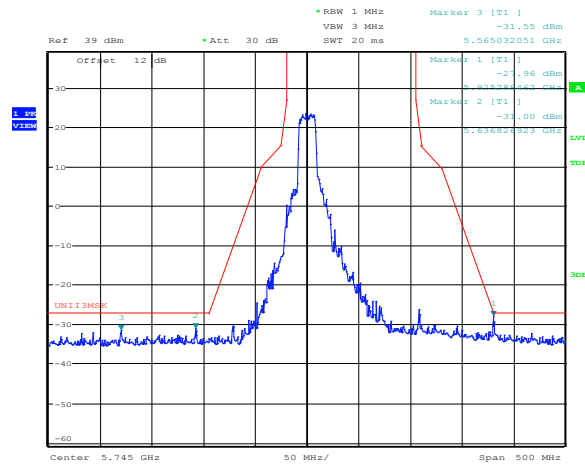

Date: 16.JAN.2018 16:28:03

**Figure 8.4-11:** Emission mask for 5 dBi antenna, low channel, 1-carrier operation



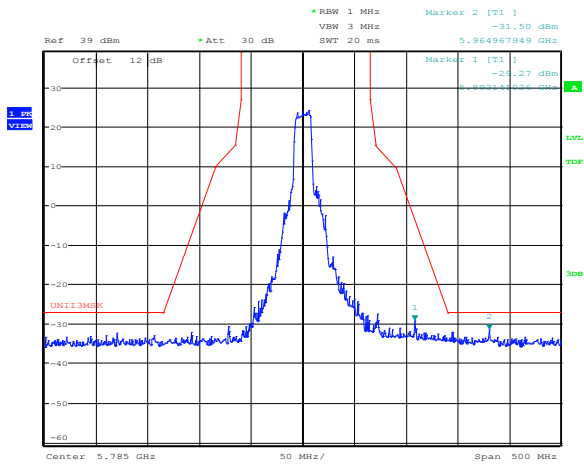

Date: 16.JAN.2018 16:13:23

Figure 8.4-12: Emission mask for 5 dBi antenna, mid channel, 1-carrier operation

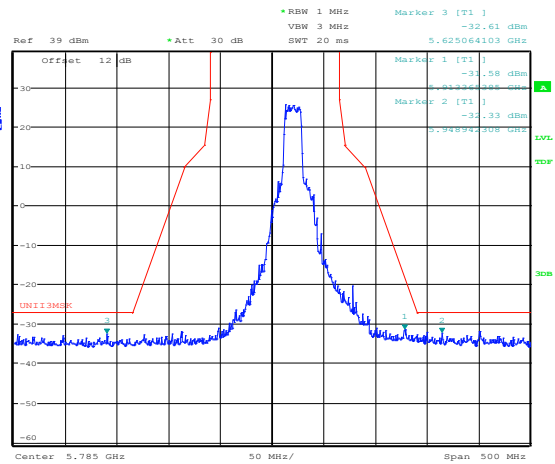

Date: 16.JAN.2018 16:16:10

Figure 8.4-13: Emission mask for 5 dBi antenna, high channel, 1-carrier operation

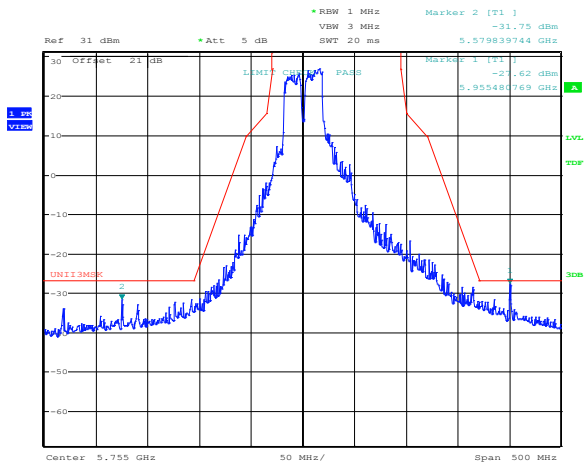

Date: 17.JAN.2018 10:36:15

Figure 8.4-14: Emission mask for 14 dBi antenna, bottom of the band, 2-carrier operation

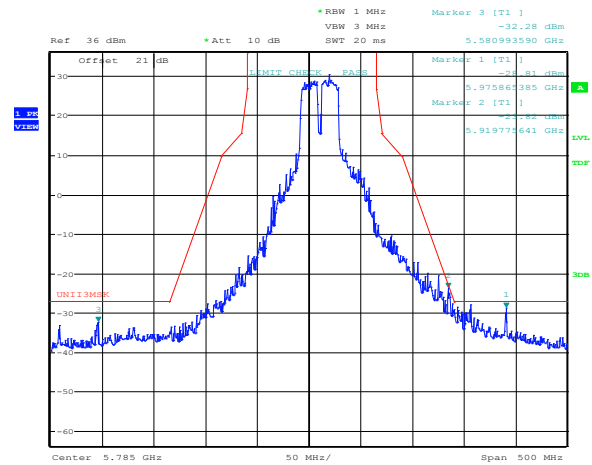

Date: 17.JAN.2018 10:49:49

Figure 8.4-15: Emission mask for 14 dBi antenna, top of the band, 2-carrier operation

**Section 8**  
**Test name**  
**Specification**

Testing data  
 FCC 15.407(b) and RSS-247 6.2.1.2 Undesirable (unwanted) emissions  
 FCC Part 15 Subpart E and RSS-247, Issue 2

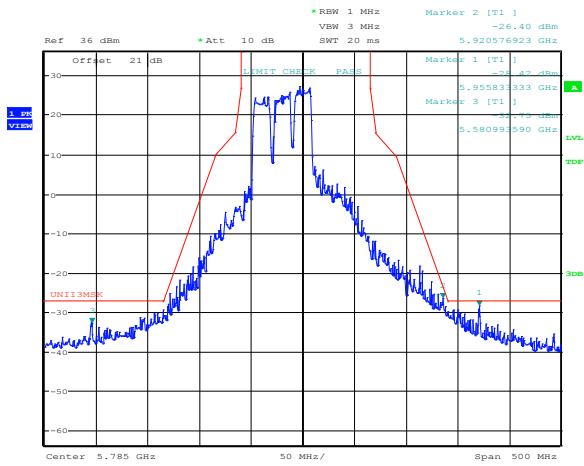

Date: 17.JAN.2018 11:23:05

**Figure 8.4-16:** Emission mask for 14 dBi antenna, bottom of the band, 3-carrier operation

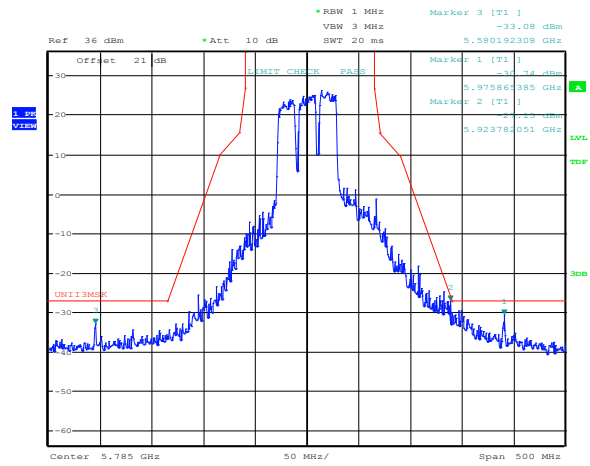

Date: 17.JAN.2018 11:30:45

**Figure 8.4-17:** Emission mask for 14 dBi antenna, top of the band, 3-carrier operation

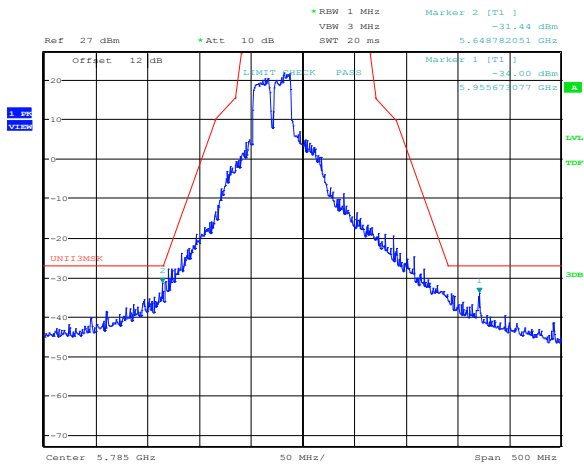

Date: 17.JAN.2018 11:55:24

**Figure 8.4-18:** Emission mask for 5 dBi antenna, bottom of the band, 2-carrier operation

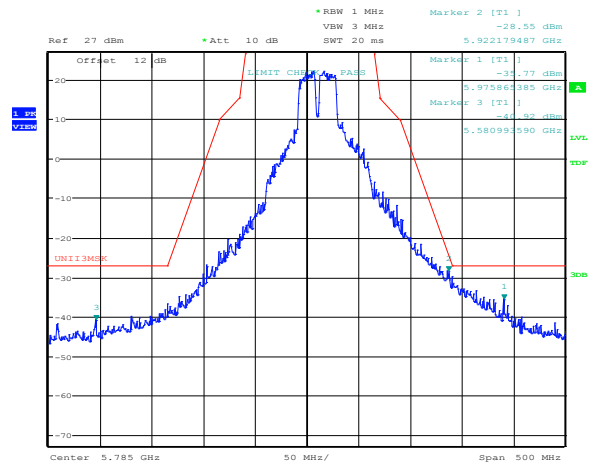

Date: 17.JAN.2018 11:58:20

**Figure 8.4-19:** Emission mask for 5 dBi antenna, top of the band, 2-carrier operation

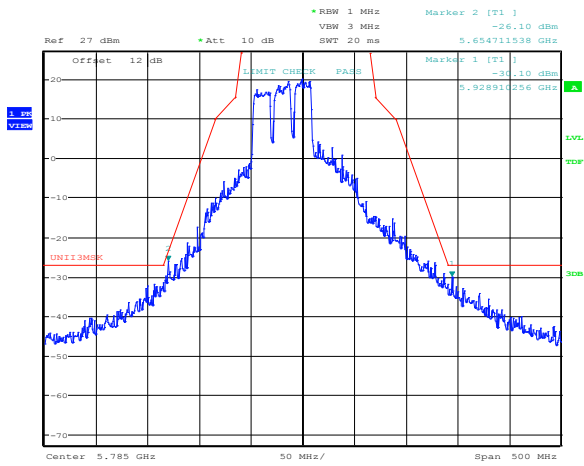

Date: 17.JAN.2018 10:57:38

**Figure 8.4-20:** Emission mask for 5 dBi antenna, bottom of the band, 3-carrier operation

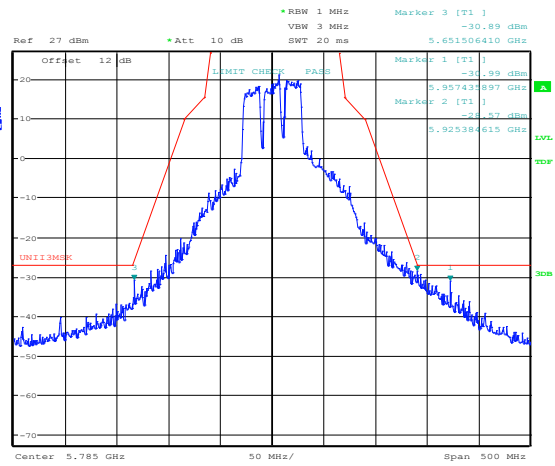

Date: 17.JAN.2018 11:11:46

**Figure 8.4-21:** Emission mask for 5 dBi antenna, top of the band, 3-carrier operation

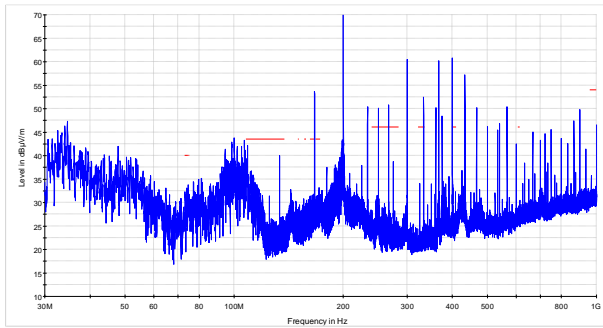

Radiated spurious emissions  
 FCC 15.205 and RSS-Gen Restricted bands limits  
 Peak max-hold

**Figure 8.4-22:** Peak radiated spurious emissions within 30–1000 MHz within restricted bands, 1-carrier operation

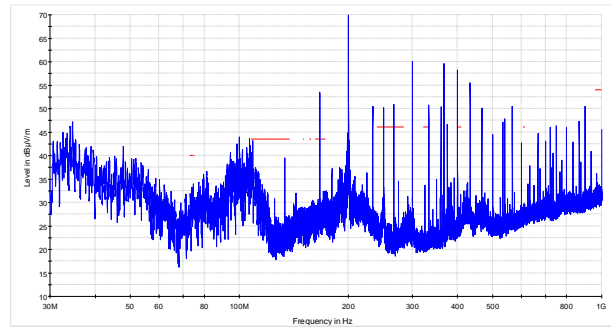

Radiated spurious emissions  
 FCC 15.205 and RSS-Gen Restricted bands limits  
 Peak max-hold

**Figure 8.4-23:** Peak radiated spurious emissions within 30–1000 MHz within restricted bands, 2-carrier operation

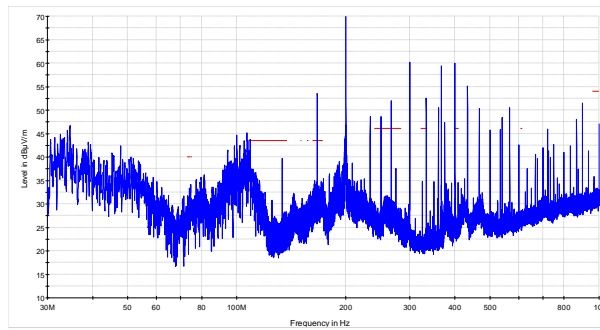

Radiated spurious emissions  
 FCC 15.205 and RSS-Gen Restricted bands limits  
 Peak max-hold

**Figure 8.4-24:** Peak radiated spurious emissions within 30–1000 MHz within restricted bands, 3-carrier operation

Note: on the plots above emissions exceeding the limit line were investigated and it was verified that they are originating from the digital circuitry of the supporting equipment.

No EUT spurious emissions from the RF components were detected near the limit lines.

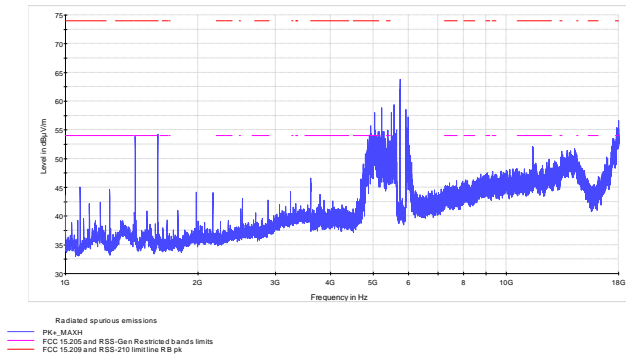

**Figure 8.4-25:** Peak radiated spurious emissions within 1–18 GHz within restricted bands, low channel, 1-carrier operation

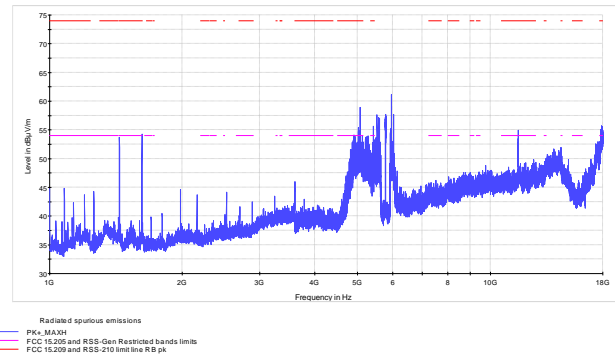

**Figure 8.4-26:** Peak radiated spurious emissions within 1–18 GHz within restricted bands, mid channel, 1-carrier operation

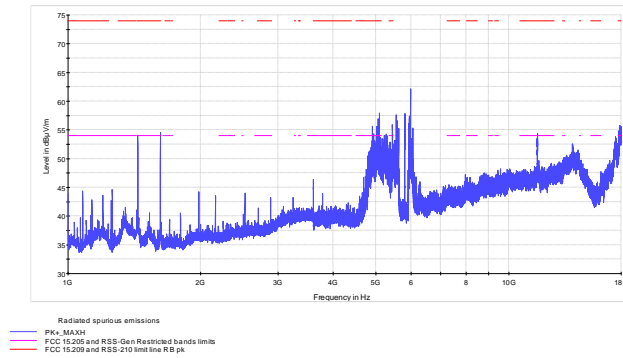

**Figure 8.4-27:** Peak radiated spurious emissions within 1–18 GHz within restricted bands, high channel, 1-carrier operation

**Table 8.4-4:** Radiated field strength measurement results

Notes	Frequency, GHz	Peak Field strength, dBµV/m	Peak limit, dBµV/m	Peak margin, dB	Average Field strength, dBµV/m	Average limit, dBµV/m	Average margin, dB
Worst case	1.440	55.90	74.00	18.10	52.65	54.00	1.35
Worst case	1.620	56.00	74.00	18.00	53.35	54.00	0.65
Worst case	5.025	59.50	74.00	14.50	53.96	54.00	0.04
Worst case	5.385	58.50	74.00	15.50	52.92	54.00	1.08
Low channel, 1C	11.490	63.58	74.00	10.42	42.15	54.00	11.85
Mid channel, 1C	11.570	49.32	74.00	24.68	41.00	54.00	13.00
High channel, 1C	11.610	61.34	74.00	12.66	40.47	54.00	13.53

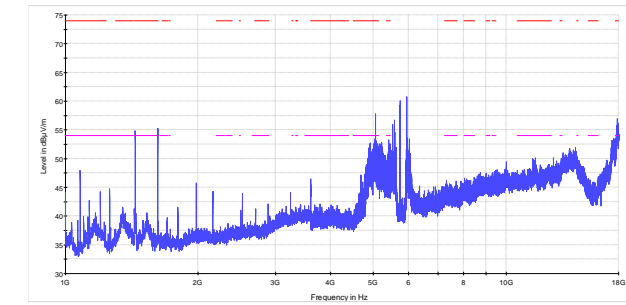

Legend:  
 Radiated spurious emissions  
 PK<sub>e</sub>, MAXH  
 FCC 15.205 and RSS-Gen Restricted bands limits  
 FCC 15.209 and RSS-210 limitline RB pk

**Figure 8.4-28:** Peak radiated spurious emissions within 1–18 GHz within restricted bands, bottom of the band, 2-carrier operation

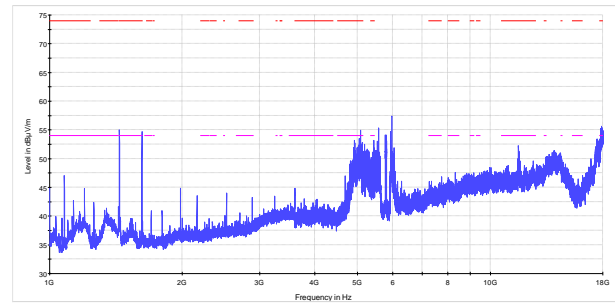

Legend:  
 Radiated spurious emissions  
 PK<sub>e</sub>, MAXH  
 FCC 15.205 and RSS-Gen Restricted bands limits  
 FCC 15.209 and RSS-210 limitline RB pk

**Figure 8.4-29:** Peak radiated spurious emissions within 1–18 GHz within restricted bands, top of the band, 2-carrier operation

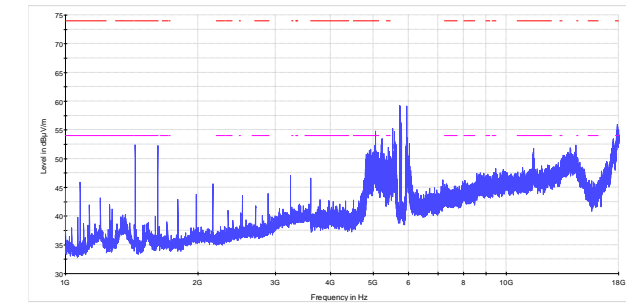

Legend:  
 Radiated spurious emissions  
 PK<sub>e</sub>, MAXH  
 FCC 15.205 and RSS-Gen Restricted bands limits  
 FCC 15.209 and RSS-210 limitline RB pk

**Figure 8.4-30:** Peak radiated spurious emissions within 1–18 GHz within restricted bands, bottom of the band, 3-carrier operation

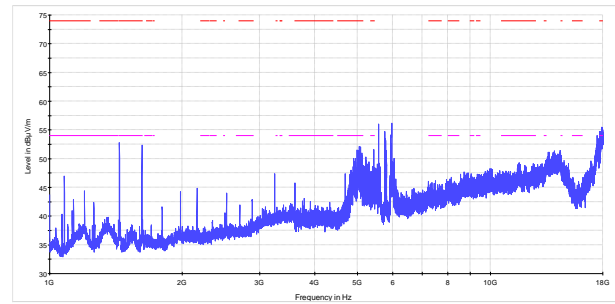

Legend:  
 Radiated spurious emissions  
 PK<sub>e</sub>, MAXH  
 FCC 15.205 and RSS-Gen Restricted bands limits  
 FCC 15.209 and RSS-210 limitline RB pk

**Figure 8.4-31:** Peak radiated spurious emissions within 1–18 GHz within restricted bands, top of the band, 3-carrier operation

**Table 8.4-5:** Radiated field strength measurement results

Notes	Frequency, GHz	Peak Field strength, dBµV/m	Peak limit, dBµV/m	Peak margin, dB	Average Field strength, dBµV/m	Average limit, dBµV/m	Average margin, dB
Worst case	1.440	55.90	74.00	18.10	52.65	54.00	1.35
Worst case	1.620	56.00	74.00	18.00	53.35	54.00	0.65
Worst case	5.025	59.50	74.00	14.50	53.96	54.00	0.04
Worst case	5.385	58.50	74.00	15.50	52.92	54.00	1.08
Bottom of the band, 2C	11.510	59.74	74.00	14.26	38.99	54.00	15.01
Top of the band, 2C	11.590	51.57	74.00	22.43	39.44	54.00	14.56
Bottom of the band, 3C	11.530	55.81	74.00	18.19	37.46	54.00	16.54
Top of the band, 3C	11.570	55.01	74.00	18.99	36.10	54.00	17.90

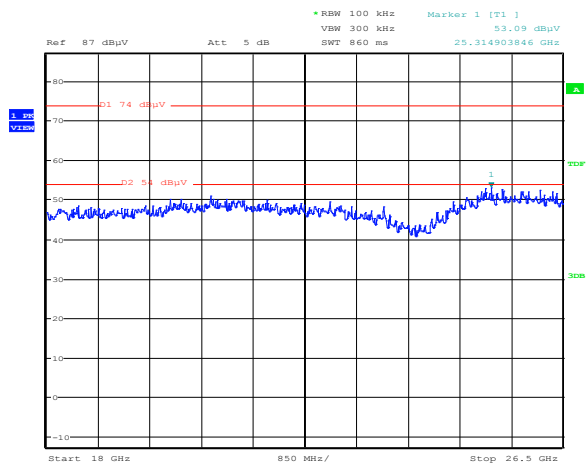

Date: 19.JAN.2018 19:14:49

**Figure 8.4-32:** Peak radiated spurious emissions within 18–26.5 GHz within restricted bands, 1-carrier operation

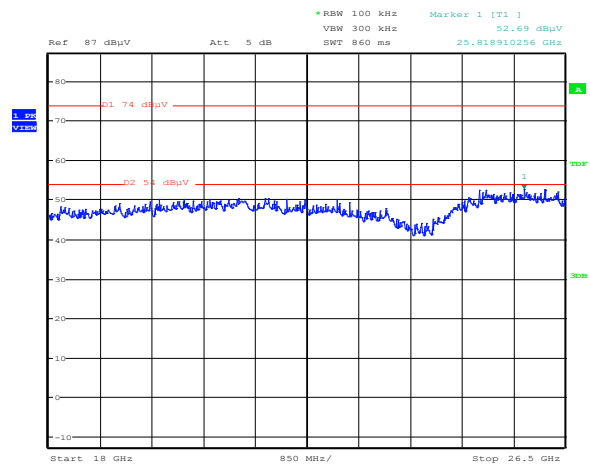

Date: 19.JAN.2018 19:12:32

**Figure 8.4-33:** Peak radiated spurious emissions within 18–26.5 GHz within restricted bands, 2-carrier operation

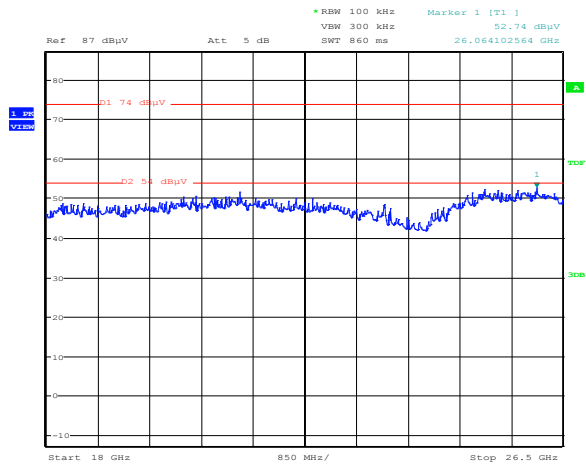

Date: 19.JAN.2018 19:11:57

**Figure 8.4-34:** Peak radiated spurious emissions within 18–26.5 GHz within restricted bands, 3-carrier operation

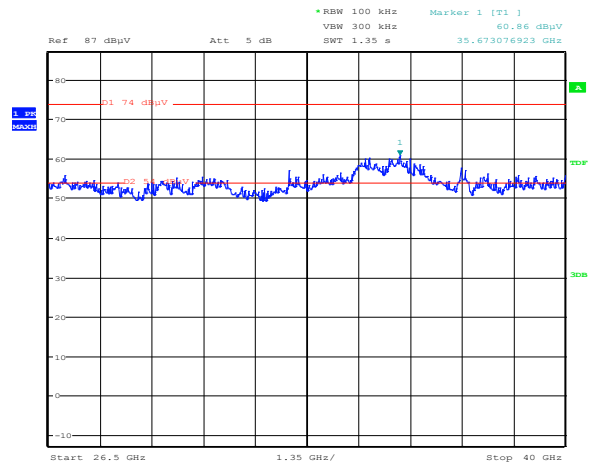

Date: 19.JAN.2018 19:18:19

**Figure 8.4-35:** Peak radiated spurious emissions within 26.5–40 GHz within restricted bands, 1-carrier operation

Note: At frequencies above 26.5 GHz average level was verified where peak emissions exceeded average limit, no emissions radiated from the EUT were detected.

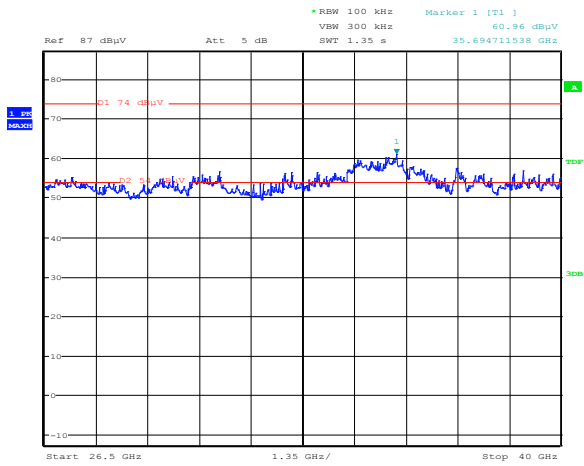

Date: 19.JAN.2018 19:20:03

**Figure 8.4-36:** Peak radiated spurious emissions within 26.5–40 GHz within restricted bands, 2-carrier operation

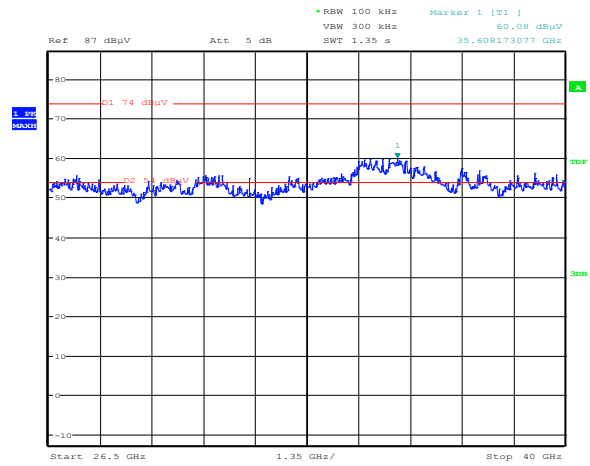

Date: 19.JAN.2018 19:21:54

**Figure 8.4-37:** Peak radiated spurious emissions within 26.5–40 GHz within restricted bands, 3-carrier operation





## 8.5 FCC 15.207(a) and RSS-Gen 8.8 AC power line conducted emissions limits

### 8.5.1 Definitions and limits

#### FCC §15.407(6)(b):

Any U-NII devices using an AC power line are required to comply also with the conducted limits set forth in §15.207

#### FCC §15.207(a):

Except as shown in paragraphs (b) and (c) of this section, for an intentional radiator that is designed to be connected to the public utility (AC) power line, the radio frequency voltage that is conducted back onto the AC power line on any frequency or frequencies, within the band 150 kHz to 30 MHz, shall not exceed the limits in the following table, as measured using a 50 μH/50 Ω line impedance stabilization network (LISN). Compliance with the provisions of this paragraph shall be based on the measurement of the radio frequency voltage between each power line and ground at the power terminal. The lower limit applies at the boundary between the frequency ranges.

#### ISED:

A radio apparatus that is designed to be connected to the public utility (AC) power line shall ensure that the radio frequency voltage, which is conducted back onto the AC power line on any frequency or frequencies within the band 150 kHz to 30 MHz, shall not exceed the limits in table below.

Unless the requirements applicable to a given device state otherwise, for any radio apparatus equipped to operate from the public utility AC power supply either directly or indirectly (such as with a battery charger), the radio frequency voltage of emissions conducted back onto the AC power lines in the frequency range of 0.15 MHz to 30 MHz shall not exceed the limits shown in table below. The more stringent limit applies at the frequency range boundaries.

*Table 8.5-1: Conducted emissions limit*

Frequency of emission (MHz)	Conducted limit (dBμV)	
	Quasi-peak	Average**
0.15–0.5	66 to 56*	56 to 46*
0.5–5	56	46
5–30	60	50

Note: \* - The level decreases linearly with the logarithm of the frequency.

\*\* - A linear average detector is required.

### 8.5.2 Test summary

Test date	January 19, 2018
Test engineer	Andrey Adelberg

### 8.5.3 Observations, settings and special notes

---

The EUT was set up as tabletop configuration.

The spectral scan has been corrected with transducer factors (i.e. cable loss, LISN factors, and attenuators) for determination of compliance.

A preview measurement was generated with the receiver in continuous scan mode. Emissions detected within 6 dB or above limit were re-measured with the appropriate detector against the correlating limit and recorded as the final measurement.

Receiver settings for preview measurements:

Resolution bandwidth	9 kHz
Video bandwidth	30 kHz
Detector mode	Peak and Average
Trace mode	Max Hold
Measurement time	100 ms

Receiver settings for final measurements:

Resolution bandwidth	9 kHz
Video bandwidth	30 kHz
Detector mode	Quasi-Peak and Average
Trace mode	Max Hold
Measurement time	100 ms

8.5.4 Test data

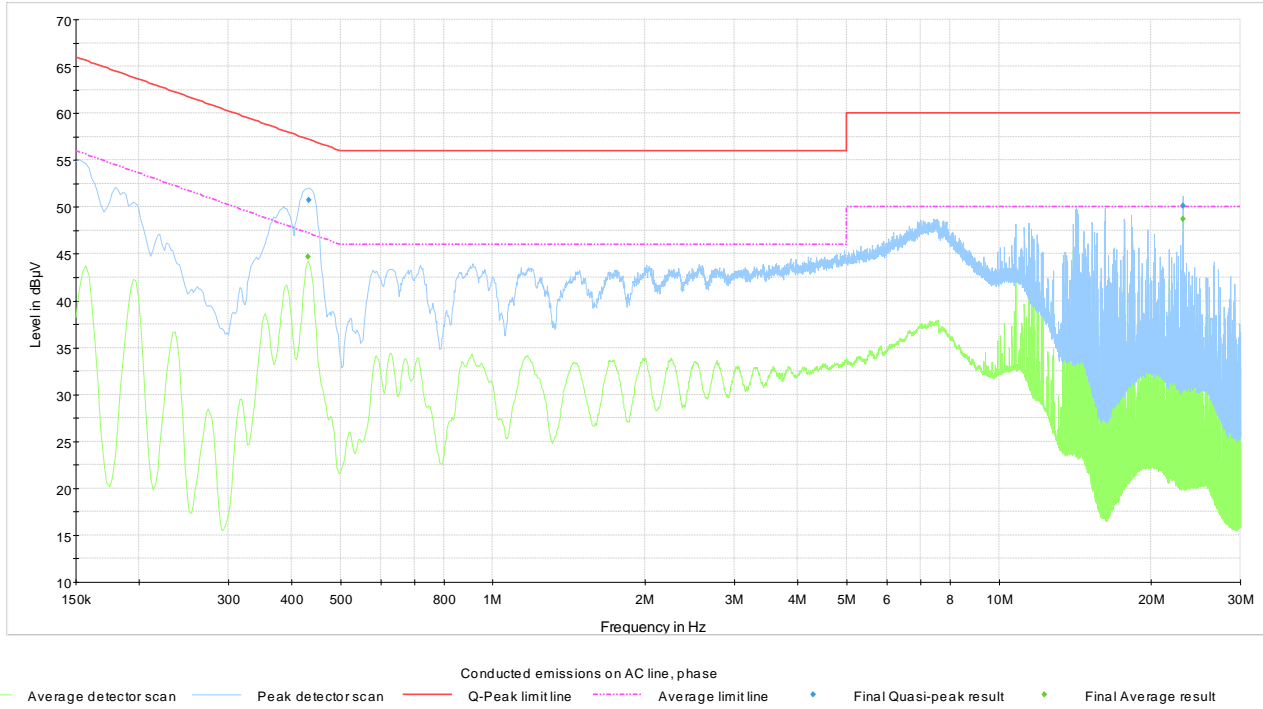

Plot 8.5-1: Conducted emissions on phase line

Table 8.5-2: Quasi-Peak conducted emissions results on phase line

Frequency, MHz	Q-Peak result, dBµV	Limit, dBµV	Margin, dB	Meas. Time, ms	Bandwidth, kHz	Line	Filter	Correction, dB
0.434	50.76	57.19	6.43	100	9	L1	ON	9.4
23.129	50.16	60.00	9.84	100	9	L1	ON	10.5

Table 8.5-3: Average conducted emissions results on phase line

Frequency, MHz	Average result, dBµV	Limit, dBµV	Margin, dB	Meas. Time, ms	Bandwidth, kHz	Line	Filter	Correction, dB
0.431	44.69	47.23	2.54	100	9	L1	ON	9.4
23.129	48.70	50.00	1.30	100	9	L1	ON	10.5

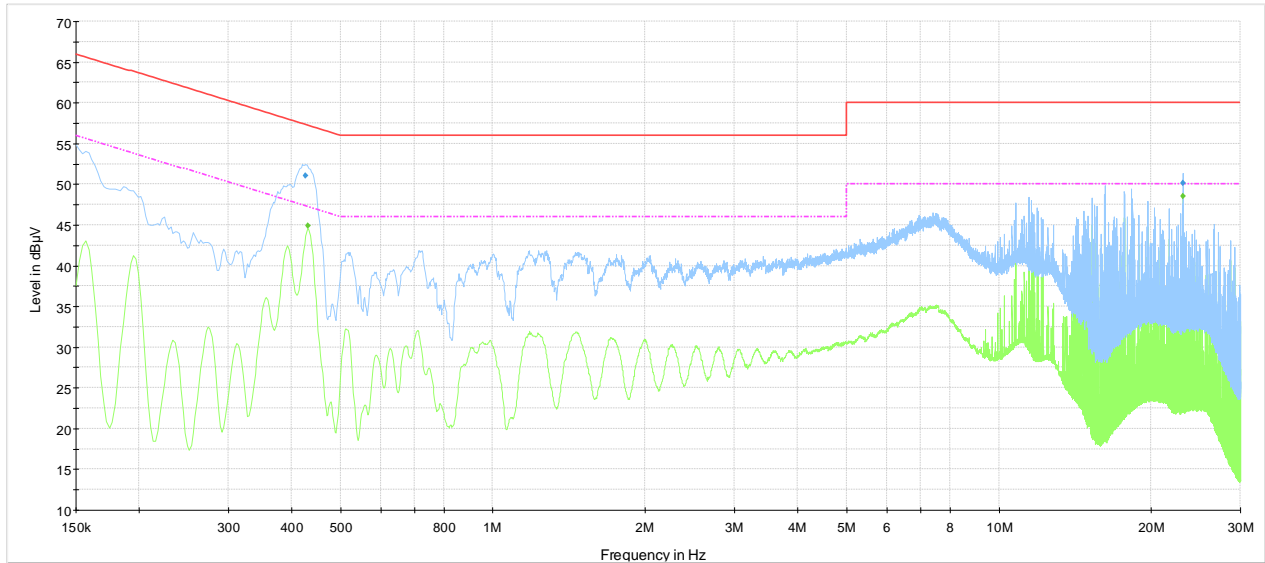

Conducted emissions on AC line, neutral

- Average detector scan
- Peak detector scan
- Q-Peak limit line
- Average limit line
- ◆ Final Quasi-peak result
- ◆ Final Average result

**Plot 8.5-2:** Conducted emissions on neutral line

**Table 8.5-4:** Quasi-Peak conducted emissions results on neutral line

Frequency, MHz	Q-Peak result, dBµV	Limit, dBµV	Margin, dB	Meas. Time, ms	Bandwidth, kHz	Line	Filter	Correction, dB
0.427	51.03	57.32	6.29	100	9	N	ON	9.4
23.129	50.16	60.00	9.84	100	9	N	ON	10.6

**Table 8.5-5:** Average conducted emissions results on neutral line

Frequency, MHz	Average result, dBµV	Limit, dBµV	Margin, dB	Meas. Time, ms	Bandwidth, kHz	Line	Filter	Correction, dB
0.431	44.92	47.23	2.31	100	9	N	ON	9.4
23.129	48.57	50.00	1.43	100	9	N	ON	10.6

## 8.6 FCC 15.407(g) and RSS-Gen 8.11 Frequency stability

### 8.6.1 Definitions and limits

Manufacturers of U-NII devices are responsible for ensuring frequency stability such that an emission is maintained within the band of operation under all conditions of normal operation as specified in the user's manual.

### 8.6.2 Test summary

Test date:	January 18, 2018
Test engineer:	Andrey Adelberg

### 8.6.3 Observations, settings and special notes

Spectrum analyser settings:

Resolution bandwidth:	500 Hz
Video bandwidth:	2 kHz
Detector mode:	Peak
Trace mode:	Max Hold

### 8.6.4 Test data

**Table 8.6-1: Frequency drift measurement**

Test conditions	Frequency, GHz	Drift, Hz
+50 °C, Nominal	5.765003365	-8013
+40 °C, Nominal	5.764999840	-11538
+30 °C, Nominal	5.765003365	-8013
+20 °C, +15 %	5.765012660	1282
+20 °C, Nominal	5.765011378	<i>Reference</i>
+20 °C, -15 %	5.765012019	641
+10 °C, Nominal	5.765028686	17308
0 °C, Nominal	5.765048558	37180
-10 °C, Nominal	5.765060256	48878
-20 °C, Nominal	5.765063462	52084
-30 °C, Nominal	5.765056891	45513

Maximum negative drift measured is 11.54 kHz. Maximum positive drift measured is 52.08 kHz

26 dBc emission bandwidth for the lowermost and uppermost channels was checked and verified to be around 10 MHz from the band edge for the bottom of the band as well as from the top of the band.

Emission is maintained within the band of operation during normal and extreme conditions.

## Section 9. Block diagrams of test set-ups

### 9.1 Radiated emissions set-up for frequencies below 1 GHz

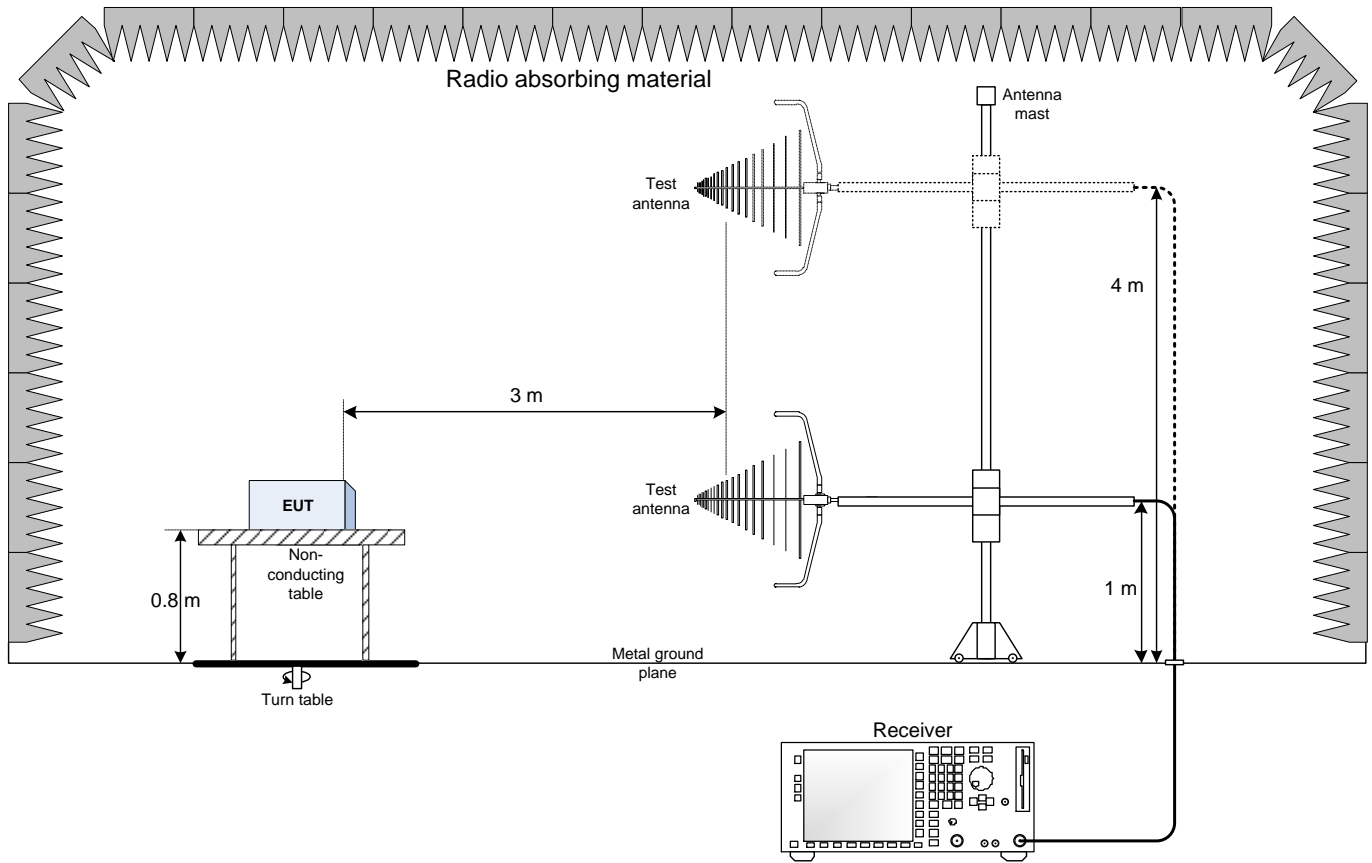

### 9.2 Radiated emissions set-up for frequencies above 1 GHz

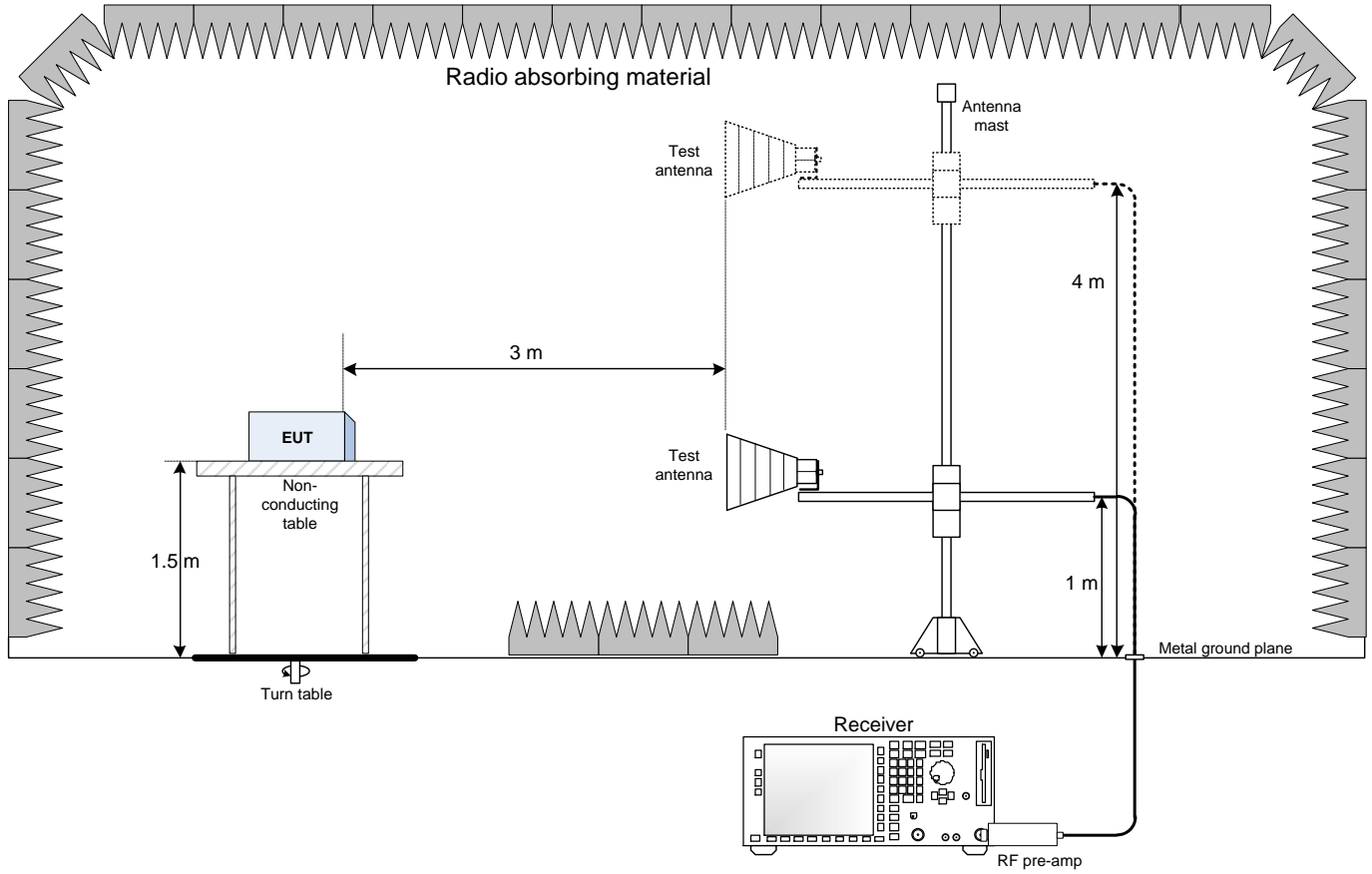

### 9.3 Conducted emissions set-up

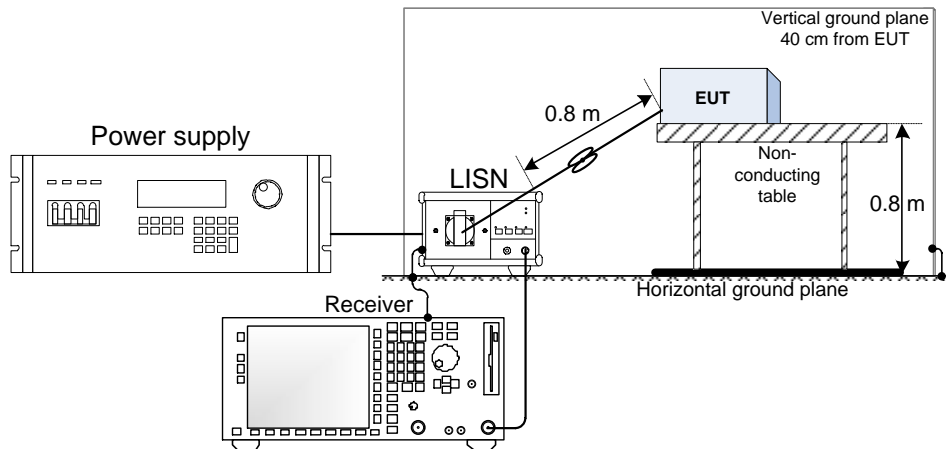

9.4 Antenna-port measurements set-up

---

