FCC Test Report

Report No.: AGC00252200801FE03

FCC ID : ATL-TB200
APPLICATION PURPOSE : Original Equipment
PRODUCT DESIGNATION : TWS Bluetooth Headset
BRAND NAME : iLuv
MODEL NAME : TB200
APPLICANT : iLuv Creative Technology
DATE OF ISSUE : Sep. 04, 2020
STANDARD(S) : FCC Part 15.247
REPORT VERSION : V1.0

Attestation of **Global Compliance (Shenzhen) Co., Ltd**



Any report having not been signed by authorized approver, or having been altered without authorization, or having not been stamped by the "Dedicated Testing/Inspection Stamp" is deemed to be invalid. Copying or excerpting portion of, or altering the content of the report is not permitted without the written authorization of AGC. The test results presented in the report apply only to the tested sample. Any objections to report issued by AGC should be submitted to AGC within 15 days after the issuance of the test report. Further enquiry of validity or verification of the test report should be addressed to AGC by agc@agc-cert.com.

Attestation of Global Compliance(Shenzhen)Co., Ltd
Attestation of Global Compliance(Shenzhen)Std & Tech Co., Ltd
Tel: +86-755 2523 4088 E-mail: agc@agc-cert.com Web: <http://cn.agc-cert.com/>



REPORT REVISE RECORD

| Report Version | Revise Time | Issued Date | Valid Version | Notes |
|----------------|-------------|---------------|---------------|-----------------|
| V1.0 | / | Sep. 04, 2020 | Valid | Initial Release |

Any report having not been signed by authorized approver, or having been altered without authorization, or having not been stamped by the "Dedicated Testing/Inspection Stamp" is deemed to be invalid. Copying or excerpting portion of, or altering the content of the report is not permitted without the written authorization of AGC. The test results presented in the report apply only to the tested sample. Any objections to report issued by AGC should be submitted to AGC within 15days after the issuance of the test report. Further enquiry of validity or verification of the test report should be addressed to AGC by agc@agc-cert.com.

Attestation of Global Compliance(Shenzhen)Co., Ltd
Attestation of Global Compliance(Shenzhen)Std & Tech Co., Ltd
Tel: +86-755 2523 4088 E-mail: agc@agc-cert.com Web: <http://cn.agc-cert.com/>



TABLE OF CONTENTS

| | |
|---|-----------|
| 1. VERIFICATION OF CONFORMITY | 5 |
| 2. GENERAL INFORMATION | 6 |
| 2.1. PRODUCT DESCRIPTION | 6 |
| 2.2. TABLE OF CARRIER FREQUENCIES | 6 |
| 2.3. RECEIVER INPUT BANDWIDTH | 7 |
| 2.4. EXAMPLE OF A HOPPING SEQUENCY IN DATA MODE | 7 |
| 2.5. EQUALLY AVERAGE USE OF FREQUENCIES AND BEHAVIOUR | 7 |
| 2.6. RELATED SUBMITTAL(S) / GRANT (S) | 8 |
| 2.7. TEST METHODOLOGY | 8 |
| 2.8. SPECIAL ACCESSORIES | 8 |
| 2.9. EQUIPMENT MODIFICATIONS..... | 8 |
| 2.10. ANTENNA REQUIREMENT..... | 8 |
| 3. MEASUREMENT UNCERTAINTY | 9 |
| 4. DESCRIPTION OF TEST MODES | 10 |
| 5. SYSTEM TEST CONFIGURATION | 11 |
| 5.1. CONFIGURATION OF EUT SYSTEM..... | 11 |
| 5.2. EQUIPMENT USED IN TESTED SYSTEM..... | 11 |
| 5.3. SUMMARY OF TEST RESULTS | 11 |
| 6. TEST FACILITY | 12 |
| 7. PEAK OUTPUT POWER | 13 |
| 7.1. MEASUREMENT PROCEDURE | 13 |
| 7.2. TEST SET-UP (BLOCK DIAGRAM OF CONFIGURATION) | 13 |
| 7.3. LIMITS AND MEASUREMENT RESULT | 14 |
| 8. 20DB BANDWIDTH | 20 |
| 8.1. MEASUREMENT PROCEDURE | 20 |
| 8.2. TEST SET-UP (BLOCK DIAGRAM OF CONFIGURATION) | 20 |
| 8.3. LIMITS AND MEASUREMENT RESULTS | 21 |
| 9. CONDUCTED SPURIOUS EMISSION | 27 |
| 9.1. MEASUREMENT PROCEDURE | 27 |

Any report having not been signed by authorized approver, or having been altered without authorization, or having not been stamped by the "Dedicated Testing/Inspection Stamp" is deemed to be invalid. Copying or excerpting portion of, or altering the content of the report is not permitted without the written authorization of AGC. The test results presented in the report apply only to the tested sample. Any objections to report issued by AGC should be submitted to AGC within 15days after the issuance of the test report. Further enquiry of validity or verification of the test report should be addressed to AGC by agc@agc-cert.com.



9.2. TEST SET-UP (BLOCK DIAGRAM OF CONFIGURATION) 27

9.3. MEASUREMENT EQUIPMENT USED 27

9.4. LIMITS AND MEASUREMENT RESULT 27

10. RADIATED EMISSION 40

10.1. MEASUREMENT PROCEDURE 40

10.2. TEST SETUP 42

10.3. LIMITS AND MEASUREMENT RESULT 43

10.4. TEST RESULT..... 43

11. NUMBER OF HOPPING FREQUENCY 53

11.1. MEASUREMENT PROCEDURE..... 53

11.2. TEST SETUP (BLOCK DIAGRAM OF CONFIGURATION) 53

11.3. MEASUREMENT EQUIPMENT USED 53

11.4. LIMITS AND MEASUREMENT RESULT 53

12. TIME OF OCCUPANCY (DWELL TIME)..... 54

12.1. MEASUREMENT PROCEDURE 54

12.2. TEST SETUP (BLOCK DIAGRAM OF CONFIGURATION) 54

12.3. MEASUREMENT EQUIPMENT USED 54

12.4. LIMITS AND MEASUREMENT RESULT 54

13. FREQUENCY SEPARATION 58

13.1. MEASUREMENT PROCEDURE 58

13.2. TEST SETUP (BLOCK DIAGRAM OF CONFIGURATION) 58

13.3. MEASUREMENT EQUIPMENT USED 58

13.4. LIMITS AND MEASUREMENT RESULT 58

14. FCC LINE CONDUCTED EMISSION TEST 59

14.1. LIMITS OF LINE CONDUCTED EMISSION TEST 59

14.2. BLOCK DIAGRAM OF LINE CONDUCTED EMISSION TEST 59

14.3. PRELIMINARY PROCEDURE OF LINE CONDUCTED EMISSION TEST 60

14.4. FINAL PROCEDURE OF LINE CONDUCTED EMISSION TEST..... 60

14.5. TEST RESULT OF LINE CONDUCTED EMISSION TEST 60

APPENDIX A: PHOTOGRAPHS OF TEST SETUP 61

APPENDIX B: PHOTOGRAPHS OF EUT 63

Any report having not been signed by authorized approver, or having been altered without authorization, or having not been stamped by the "Dedicated Testing/Inspection Stamp" is deemed to be invalid. Copying or excerpting portion of, or altering the content of the report is not permitted without the written authorization of AGC. The test results presented in the report apply only to the tested sample. Any objections to report issued by AGC should be submitted to AGC within 15days after the issuance of the test report. Further enquiry of validity or verification of the test report should be addressed to AGC by agc@agc-cert.com.



1. VERIFICATION OF CONFORMITY

| | |
|---------------------------------|---|
| Applicant | iLuv Creative Technology |
| Address | 2 Harbour Park Drive, Port Washington NY11050 USA |
| Manufacturer | Cirque Audio Technology Co., Ltd |
| Address | No. 2, Road BeiYiHeng, HuangJiaBao Industrial Park, ShiPai Town, DongGuan City, GuangDong Province, China |
| Factory | Cirque Audio Technology Co., Ltd |
| Address | No. 2, Road BeiYiHeng, HuangJiaBao Industrial Park, ShiPai Town, DongGuan City, GuangDong Province, China |
| Product Designation | TWS Bluetooth Headset |
| Brand Name | iLuv |
| Test Model | TB200 |
| Date of test | Aug. 19, 2020 to Sep. 03, 2020 and Sep. 30, 2020 |
| Deviation | No any deviation from the test method |
| Condition of Test Sample | Normal |
| Test Result | Pass |
| Report Template | AGCRT-US-BR/RF |

We hereby certify that:

The above equipment was tested by Attestation of Global Compliance (Shenzhen) Co., Ltd. The test data, data evaluation, test procedures, and equipment configurations shown in this report were made in accordance with the procedures given in ANSI C63.10 (2013) and the energy emitted by the sample EUT tested as described in this report is in compliance with radiated emission limits of FCC PART 15.247.

Prepared By

Eddy Liu

Eddy Liu
(Project Engineer)

Sep. 03, 2020

Reviewed By

Max Zhang

Max Zhang
(Reviewer)

Sep. 04, 2020

Approved By

Forrest Lei

Forrest Lei
(Authorized Officer)

Sep. 04, 2020

Any report having not been signed by authorized approver, or having been altered without authorization, or having not been stamped by the "Dedicated Testing/Inspection Stamp" is deemed to be invalid. Copying or excerpting portion of, or altering the content of the report is not permitted without the written authorization of AGC. The test results presented in the report apply only to the tested sample. Any objections to report issued by AGC should be submitted to AGC within 15 days after the issuance of the test report. Further enquiry of validity or verification of the test report should be addressed to AGC by agc@agc-cert.com.



2. GENERAL INFORMATION

2.1. PRODUCT DESCRIPTION

The EUT is designed as “TWS Bluetooth Headset”. It is designed by way of utilizing the GFSK, Pi/4 DQPSK and 8DPSK technology to achieve the system operation.

A major technical description of EUT is described as following

| | |
|---|---|
| Operation Frequency | 2.402 GHz to 2.480 GHz |
| RF Output Power | 2.288dBm (Max) |
| Bluetooth Version | V5.0 |
| Modulation | BR <input checked="" type="checkbox"/> GFSK, EDR <input checked="" type="checkbox"/> π /4-DQPSK, <input checked="" type="checkbox"/> 8DPSK BLE <input type="checkbox"/> GFSK 1Mbps <input type="checkbox"/> GFSK 2Mbps |
| Number of channels | 79 |
| Hardware Version | 1.0 |
| Software Version | 1.0 |
| Antenna Designation | FPC Antenna (Comply with requirements of the FCC part 15.203) |
| Antenna Gain | 0dBi |
| Power Supply | DC 3.7V by battery |
| Note: 1. The EUT doesn't support BLE. 2. The EUT comprises left and right channel headsets, both are the same, the left headset had been tested and recorded in this report as the worst case. | |

2.2. TABLE OF CARRIER FREQUENCIES

| Frequency Band | Channel Number | Frequency |
|----------------|----------------|-----------|
| 2402~2480MHz | 0 | 2402 MHz |
| | 1 | 2403 MHz |
| | : | : |
| | 38 | 2440 MHz |
| | 39 | 2441 MHz |
| | 40 | 2442 MHz |
| | : | : |
| | 77 | 2479 MHz |
| | 78 | 2480 MHz |

Any report having not been signed by authorized approver, or having been altered without authorization, or having not been stamped by the “Dedicated Testing/Inspection Stamp” is deemed to be invalid. Copying or excerpting portion of, or altering the content of the report is not permitted without the written authorization of AGC. The test results presented in the report apply only to the tested sample. Any objections to report issued by AGC should be submitted to AGC within 15days after the issuance of the test report. Further enquiry of validity or verification of the test report should be addressed to AGC by agc@agc-cert.com.

Attestation of Global Compliance(Shenzhen)Co., Ltd
Attestation of Global Compliance(Shenzhen)Std & Tech Co., Ltd
Tel: +86-755 2523 4088 E-mail: agc@agc-cert.com Web: http://cn.agc-cert.com/



2.3. RECEIVER INPUT BANDWIDTH

The input bandwidth of the receiver is 1.3MHz, in every connection one Bluetooth device is the master and the other one is slave. The master determines the hopping sequence. The slave follows this sequence. Both devices shift between RX and TX time slot according to the clock of the master. Additionally, the type of connection (e.g. single or multi slot packet) is set up at the beginning of the connection. The master adapts its hopping frequency and its TX/RX timing according to the packet type of the connection. Also, the slave of the connection will use these settings. Repeating of a packet has no influence on the hopping sequence. The hopping sequence generated by the master of the connection will be followed in any case. That means, a repeated packet will not be send on the same frequency, it is send on the next frequency of the hopping sequence.

2.4. EXAMPLE OF A HOPPING SEQUENCY IN DATA MODE

Example of a hopping sequence in data mode:

40,21,44,23,42,53,46,55,48,33,52,35,50,65,54,67
56,37,60,39,58,69,62,71,64,25,68,27,66,57,70,59
72,29,76,31,74,61,78,63,01,41,05,43,03,73,07,75
09,45,13,47,11,77,15,00,64,49,66,53,68,02,70,06
01, 51, 03, 55, 05, 04

2.5. EQUALLY AVERAGE USE OF FREQUENCIES AND BEHAVIOUR

The generation of the hopping sequence in connection mode depends essentially on two input values:

1. LAP/UAP of the master of the connection.
2. Internal master clock.

The LAP (lower address part) are the 24 LSB's of the 48 BD_ADDRESS. The BD_ADDRESS is an unambiguous number of every Bluetooth unit. The UAP (upper address part) are the 24MSB's of the 48BD_ADDRESS

The internal clock of a Bluetooth unit is derived from a free running clock which is never adjusted and is never turned off. For behavior action with other units only offset is used. It has no relation to the time of the day. Its resolution is at least half the RX/TX slot length of 312.5us. The clock has a cycle of about one day(23h30). In most case it is implemented as 28 bits counter. For the deriving of the hopping sequence the entire. LAP (24 bits),4LSB's(4bits) (Input 1) and the 27MSB's of the clock (Input 2) are used. With this input values different mathematical procedures (permutations, additions, XOR-operations) are performed to generate the Sequence. This will be done at the beginning of every new transmission.

Regarding short transmissions the Bluetooth system has the following behavior:

The first connection between the two devices is established, a hopping sequence was generated. For Transmitting the wanted data the complete hopping sequence was not used. The connection ended.

The second connection will be established. A new hopping sequence is generated. Due to the fact the



Bluetooth clock has a different value, because the period between the two transmission is longer (and it cannot be shorter) than the minimum resolution of the clock(312.5us). The hopping sequence will always differ from the first one.

2.6. RELATED SUBMITTAL(S) / GRANT (S)

This submittal(s) (test report) is intended for **FCC ID: ATL-TB200** filing to comply with the FCC PART 15.247 requirements.

2.7. TEST METHODOLOGY

Both conducted and radiated testing was performed according to the procedures in ANSI C63.10 (2013). Radiated testing was performed at an antenna to EUT distance 3 meters.

2.8. SPECIAL ACCESSORIES

Refer to section 5.2.

2.9. EQUIPMENT MODIFICATIONS

Not available for this EUT intended for grant.

2.10. ANTENNA REQUIREMENT

This intentional radiator is designed with a permanently attached antenna of an antenna to ensure that no antenna other than that furnished by the responsible party shall be used with the device.

For more information of the antenna, please refer to the APPENDIX B: PHOTOGRAPHS OF EUT.

Any report having not been signed by authorized approver, or having been altered without authorization, or having not been stamped by the "Dedicated Testing/Inspection Stamp" is deemed to be invalid. Copying or excerpting portion of, or altering the content of the report is not permitted without the written authorization of AGC. The test results presented in the report apply only to the tested sample. Any objections to report issued by AGC should be submitted to AGC within 15 days after the issuance of the test report. Further enquiry of validity or verification of the test report should be addressed to AGC by agc@agc-cert.com.

Attestation of Global Compliance(Shenzhen)Co., Ltd
Attestation of Global Compliance(Shenzhen)Std & Tech Co., Ltd
Tel: +86-755 2523 4088 E-mail: agc@agc-cert.com Web: <http://cn.agc-cert.com/>



3. MEASUREMENT UNCERTAINTY

The reported uncertainty of measurement $y \pm U$, where expanded uncertainty U is based on a standard uncertainty multiplied by a coverage factor of $k=2$, providing a level of confidence of approximately 95%.

- Uncertainty of Conducted Emission, $U_c = \pm 3.1$ dB
- Uncertainty of Radiated Emission below 1GHz, $U_c = \pm 4.0$ dB
- Uncertainty of Radiated Emission above 1GHz, $U_c = \pm 4.8$ dB
- Uncertainty of total RF power, conducted, $U_c = \pm 0.8$ dB
- Uncertainty of spurious emissions, conducted, $U_c = \pm 2.7$ dB
- Uncertainty of Occupied Channel Bandwidth: $U_c = \pm 2$ %
- Uncertainty of Dwell Time: $U_c = \pm 2$ %
- Uncertainty of Frequency: $U_c = \pm 2$ %

Any report having not been signed by authorized approver, or having been altered without authorization, or having not been stamped by the "Dedicated Testing/Inspection Stamp" is deemed to be invalid. Copying or excerpting portion of, or altering the content of the report is not permitted without the written authorization of AGC. The test results presented in the report apply only to the tested sample. Any objections to report issued by AGC should be submitted to AGC within 15 days after the issuance of the test report. Further enquiry of validity or verification of the test report should be addressed to AGC by agc@agc-cert.com.



4. DESCRIPTION OF TEST MODES

| NO. | TEST MODE DESCRIPTION |
|-----|-------------------------------|
| 1 | Low channel GFSK |
| 2 | Middle channel GFSK |
| 3 | High channel GFSK |
| 4 | Low channel $\pi/4$ -DQPSK |
| 5 | Middle channel $\pi/4$ -DQPSK |
| 6 | High channel $\pi/4$ -DQPSK |
| 7 | Low channel 8DPSK |
| 8 | Middle channel 8DPSK |
| 9 | High channel 8DPSK |
| 10 | Hopping mode GFSK |
| 11 | Hopping mode $\pi/4$ -DQPSK |
| 12 | Hopping mode 8DPSK |

Note:

1. Only the result of the worst case was recorded in the report, if no other cases.
2. For Radiated Emission, 3axis were chosen for testing for each applicable mode.
3. For Conducted Test method, a temporary antenna connector is provided by the manufacture.

Software Setting

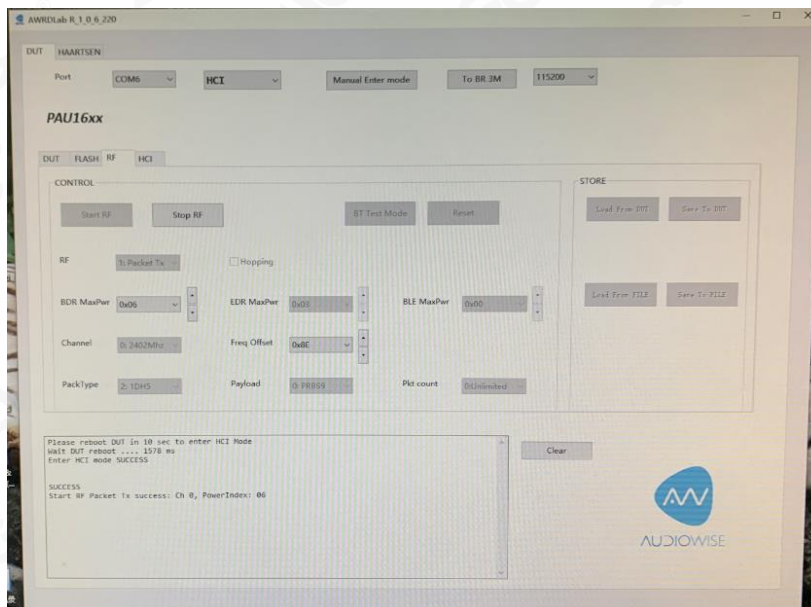

Any report having not been signed by authorized approver, or having been altered without authorization, or having not been stamped by the "Dedicated Testing/Inspection Stamp" is deemed to be invalid. Copying or excerpting portion of, or altering the content of the report is not permitted without the written authorization of AGC. The test results presented in the report apply only to the tested sample. Any objections to report issued by AGC should be submitted to AGC within 15days after the issuance of the test report. Further enquiry of validity or verification of the test report should be addressed to AGC by agc@agc-cert.com.

Attestation of Global Compliance(Shenzhen)Co., Ltd
Attestation of Global Compliance(Shenzhen)Std & Tech Co., Ltd
Tel: +86-755 2523 4088 E-mail: agc@agc-cert.com Web: http://cn.agc-cert.com/



5. SYSTEM TEST CONFIGURATION

5.1. CONFIGURATION OF EUT SYSTEM

Radiated Emission Configure:

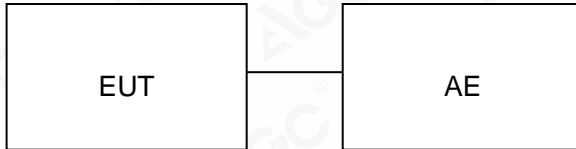

Conducted Emission Configure:

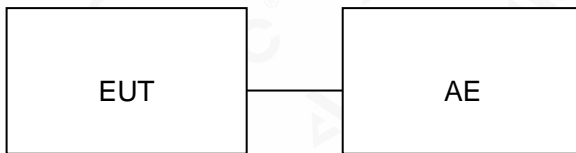

5.2. EQUIPMENT USED IN TESTED SYSTEM

| Item | Equipment | Model No. | ID or Specification | Remark |
|------|-----------------------|-----------|---------------------|--------|
| 1 | TWS Bluetooth Headset | TB200 | ATL-TB200 | EUT |
| 2 | Control Box | N/A | USB-TTL | AE |

5.3. SUMMARY OF TEST RESULTS

| FCC RULES | DESCRIPTION OF TEST | RESULT |
|--------------------|-----------------------------|----------------|
| 15.247 (b)(1) | Peak Output Power | Compliant |
| 15.247 (a)(1) | 20 dB Bandwidth | Compliant |
| 15.247 (d) | Conducted Spurious Emission | Compliant |
| 15.209 | Radiated Emission | Compliant |
| 15.247 (a)(1)(iii) | Number of Hopping Frequency | Compliant |
| 15.247 (a)(1)(iii) | Time of Occupancy | Compliant |
| 15.247 (a)(1) | Frequency Separation | Compliant |
| 15.207 | Conducted Emission | Not applicable |

Note: The conducted emission tests at AC port are not required for devices which only employ battery power for operation.

Any report having not been signed by authorized approver, or having been altered without authorization, or having not been stamped by the "Dedicated Testing/Inspection Stamp" is deemed to be invalid. Copying or excerpting portion of, or altering the content of the report is not permitted without the written authorization of AGC. The test results presented in the report apply only to the tested sample. Any objections to report issued by AGC should be submitted to AGC within 15 days after the issuance of the test report. Further enquiry of validity or verification of the test report should be addressed to AGC by agc@agc-cert.com.

Attestation of Global Compliance(Shenzhen)Co., Ltd
Attestation of Global Compliance(Shenzhen)Std & Tech Co., Ltd
Tel: +86-755 2523 4088 E-mail: agc@agc-cert.com Web: http://cn.agc-cert.com/



6. TEST FACILITY

| | |
|--|--|
| Test Site | Attestation of Global Compliance (Shenzhen) Co., Ltd |
| Location | 1-2/F, Building 19, Junfeng Industrial Park, Chongqing Road, Heping Community, Fuhai Street, Bao'an District, Shenzhen, Guangdong, China |
| Designation Number | CN1259 |
| FCC Test Firm Registration Number | 975832 |
| A2LA Cert. No. | 5054.02 |
| Description | Attestation of Global Compliance (Shenzhen) Co., Ltd is accredited by A2LA |

TEST EQUIPMENT OF RADIATED EMISSION TEST (Aug. 19, 2020 to Sep. 03, 2020)

| Equipment | Manufacturer | Model | S/N | Cal. Date | Cal. Due |
|--------------------------------|----------------|-------------------|------------|---------------|---------------|
| TEST RECEIVER | R&S | ESCI | 10096 | May 15, 2020 | May 14, 2021 |
| EXA Signal Analyzer | Aglient | N9010A | MY53470504 | Dec. 12, 2019 | Dec. 11, 2020 |
| 2.4GHz Filter | EM Electronics | 2400-2500MHz | N/A | Mar. 23, 2020 | Mar. 22, 2022 |
| Attenuator | ZHINAN | E-002 | N/A | Sep. 09, 2019 | Sep. 08, 2020 |
| Horn antenna | SCHWARZBECK | BBHA 9170 | #768 | Sep. 09, 2019 | Sep. 08, 2021 |
| Active loop antenna (9K-30MHz) | ZHINAN | ZN30900C | 18051 | May 22, 2020 | May 21, 2022 |
| Double-Ridged Waveguide Horn | ETS LINDGREN | 3117 | 00034609 | May 17, 2019 | May 16, 2021 |
| Broadband Preamplifier | ETS LINDGREN | 3117PA | 00225134 | Oct. 15, 2019 | Oct. 16, 2020 |
| ANTENNA | SCHWARZBECK | VULB9168 | 494 | Sep. 20, 2019 | Sep. 19, 2021 |
| Test software | Tonscend | JS32-RE (Ver.2.5) | N/A | N/A | N/A |

TEST EQUIPMENT OF RADIATED EMISSION TEST (Sep. 30, 2020)

| Equipment | Manufacturer | Model | S/N | Cal. Date | Cal. Due |
|---------------------|--------------|--------|------------|---------------|---------------|
| EXA Signal Analyzer | Aglient | N9020A | MY49100060 | Aug. 21, 2020 | Aug. 20, 2021 |

Any report having not been signed by authorized approver, or having been altered without authorization, or having not been stamped by the "Dedicated Testing/Inspection Stamp" is deemed to be invalid. Copying or excerpting portion of, or altering the content of the report is not permitted without the written authorization of AGC. The test results presented in the report apply only to the tested sample. Any objections to report issued by AGC should be submitted to AGC within 15 days after the issuance of the test report. Further enquiry of validity or verification of the test report should be addressed to AGC by agc@agc-cert.com.



7. PEAK OUTPUT POWER

7.1. MEASUREMENT PROCEDURE

For peak power test:

1. Connect EUT RF output port to the Spectrum Analyzer through an RF attenuator
2. Span: Approximately five times the 20 dB bandwidth, centered on a hopping channel.
3. RBW > 20 dB bandwidth of the emission being measured.
4. VBW \geq RBW.
5. Sweep: Auto.
6. Detector function: Peak.
7. Trace: Max hold.

Allow trace to stabilize. Use the marker-to-peak function to set the marker to the peak of the emission. The indicated level is the peak output power, after any corrections for external attenuators and cables.

7.2. TEST SET-UP (BLOCK DIAGRAM OF CONFIGURATION)

PEAK POWER TEST SETUP

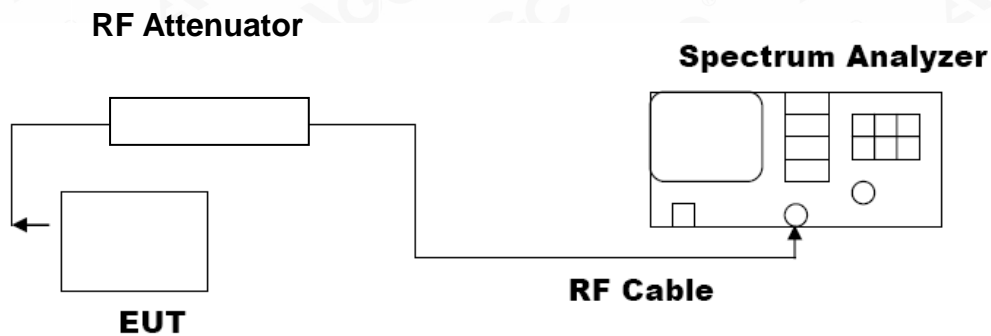

Any report having not been signed by authorized approver, or having been altered without authorization, or having not been stamped by the "Dedicated Testing/Inspection Stamp" is deemed to be invalid. Copying or excerpting portion of, or altering the content of the report is not permitted without the written authorization of AGC. The test results presented in the report apply only to the tested sample. Any objections to report issued by AGC should be submitted to AGC within 15 days after the issuance of the test report. Further enquiry of validity or verification of the test report should be addressed to AGC by agc@agc-cert.com.

7.3. LIMITS AND MEASUREMENT RESULT

| PEAK OUTPUT POWER MEASUREMENT RESULT FOR GFSK MOUDULATION | | | |
|--|------------------|-------------------------|--------------|
| Frequency (GHz) | Peak Power (dBm) | Applicable Limits (dBm) | Pass or Fail |
| 2.402 | -3.102 | 21 | Pass |
| 2.441 | -3.301 | 21 | Pass |
| 2.480 | -3.373 | 21 | Pass |

CH0

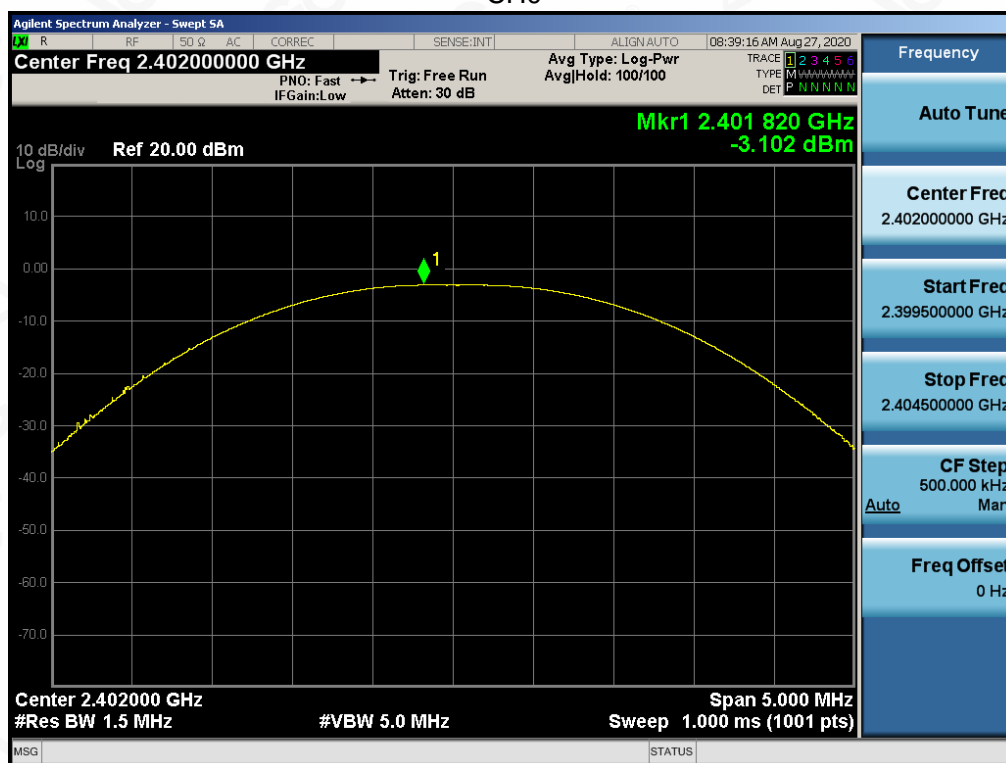

Any report having not been signed by authorized approver, or having been altered without authorization, or having not been stamped by the "Dedicated Testing/Inspection Stamp" is deemed to be invalid. Copying or excerpting portion of, or altering the content of the report is not permitted without the written authorization of AGC. The test results presented in the report apply only to the tested sample. Any objections to report issued by AGC should be submitted to AGC within 15 days after the issuance of the test report. Further enquiry of validity or verification of the test report should be addressed to AGC by agc@agc-cert.com.

Attestation of Global Compliance(Shenzhen)Co., Ltd
Attestation of Global Compliance(Shenzhen)Std & Tech Co., Ltd
Tel: +86-755 2523 4088 E-mail: agc@agc-cert.com Web: http://cn.agc-cert.com/



CH39

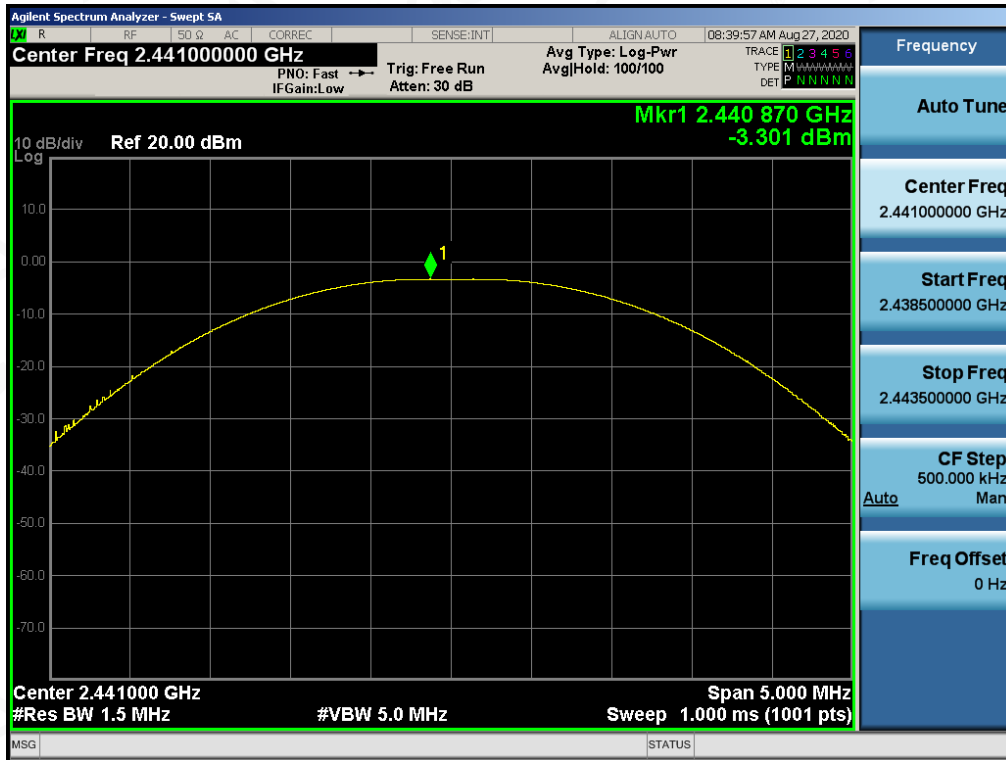

CH78

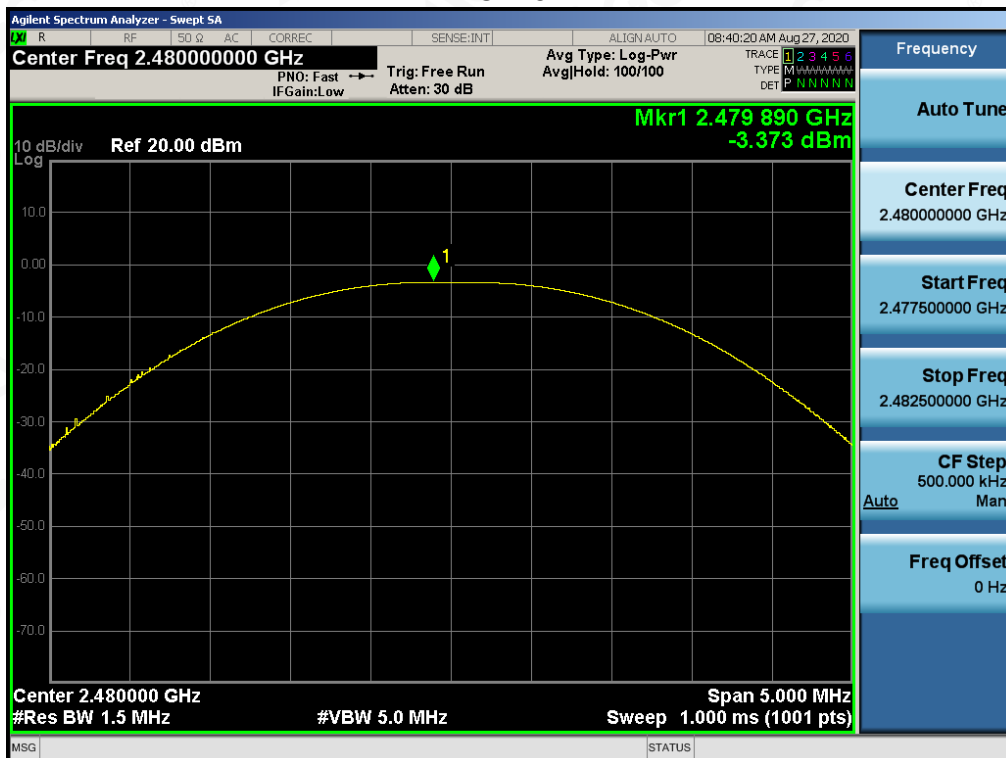

Any report having not been signed by authorized approver, or having been altered without authorization, or having not been stamped by the "Dedicated Testing/Inspection Stamp" is deemed to be invalid. Copying or excerpting portion of, or altering the content of the report is not permitted without the written authorization of AGC. The test results presented in the report apply only to the tested sample. Any objections to report issued by AGC should be submitted to AGC within 15 days after the issuance of the test report. Further enquiry of validity or verification of the test report should be addressed to AGC by agc@agc-cert.com.

Attestation of Global Compliance(Shenzhen)Co., Ltd
Attestation of Global Compliance(Shenzhen)Std & Tech Co., Ltd
Tel: +86-755 2523 4088 E-mail: agc@agc-cert.com Web: http://cn.agc-cert.com/



| PEAK OUTPUT POWER MEASUREMENT RESULT FOR $\pi/4$ -DQPSK MODULATION | | | |
|---|------------------|-------------------------|--------------|
| Frequency (GHz) | Peak Power (dBm) | Applicable Limits (dBm) | Pass or Fail |
| 2.402 | 1.718 | 21 | Pass |
| 2.441 | 1.774 | 21 | Pass |
| 2.480 | 2.041 | 21 | Pass |

CH0

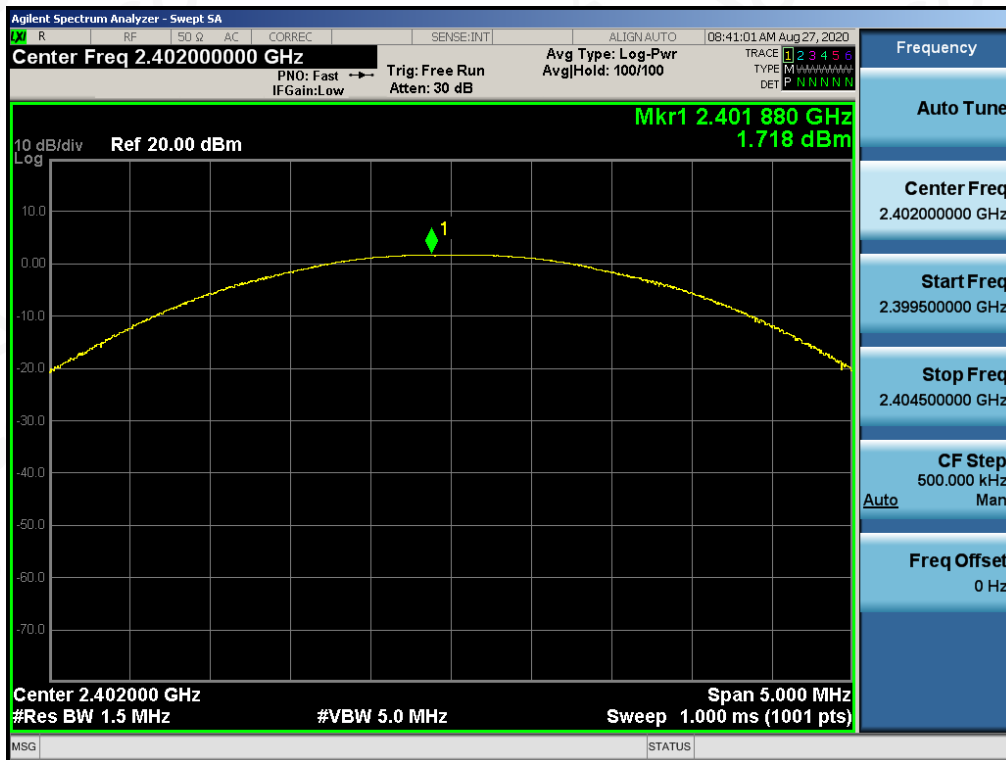

Any report having not been signed by authorized approver, or having been altered without authorization, or having not been stamped by the "Dedicated Testing/Inspection Stamp" is deemed to be invalid. Copying or excerpting portion of, or altering the content of the report is not permitted without the written authorization of AGC. The test results presented in the report apply only to the tested sample. Any objections to report issued by AGC should be submitted to AGC within 15 days after the issuance of the test report. Further enquiry of validity or verification of the test report should be addressed to AGC by agc@agc-cert.com.

Attestation of Global Compliance(Shenzhen)Co., Ltd
Attestation of Global Compliance(Shenzhen)Std & Tech Co., Ltd
Tel: +86-755 2523 4088 E-mail: agc@agc-cert.com Web: http://cn.agc-cert.com/



CH39

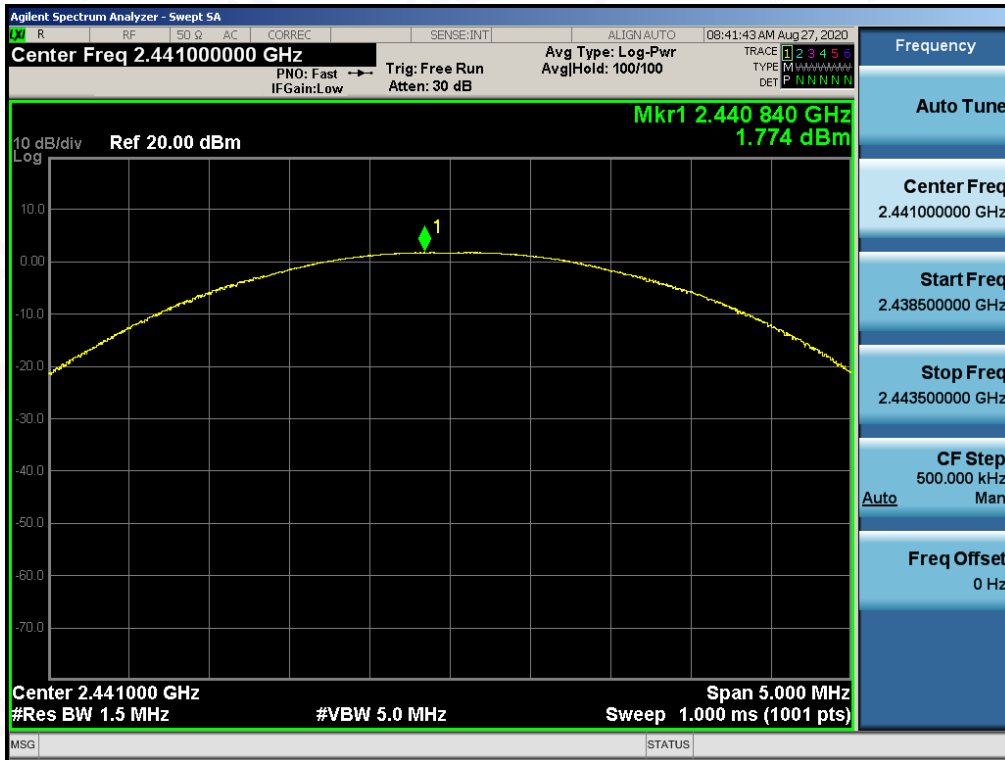

CH78

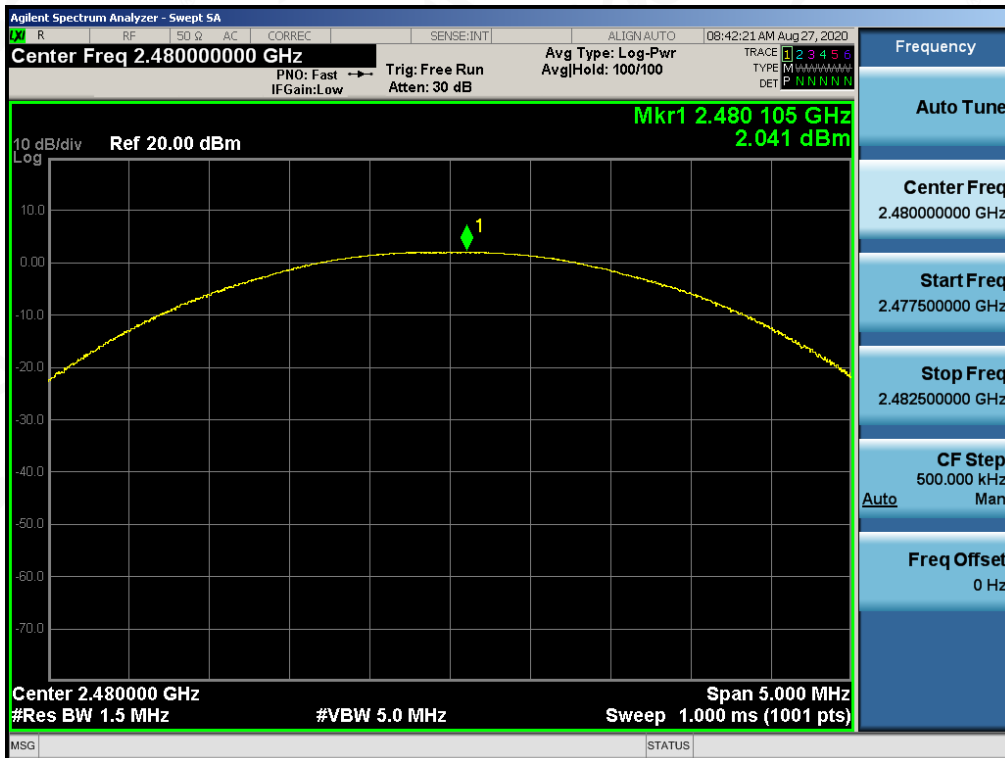

Any report having not been signed by authorized approver, or having been altered without authorization, or having not been stamped by the "Dedicated Testing/Inspection Stamp" is deemed to be invalid. Copying or excerpting portion of, or altering the content of the report is not permitted without the written authorization of AGC. The test results presented in the report apply only to the tested sample. Any objections to report issued by AGC should be submitted to AGC within 15 days after the issuance of the test report. Further enquiry of validity or verification of the test report should be addressed to AGC by agc@agc-cert.com.

Attestation of Global Compliance(Shenzhen)Co., Ltd
Attestation of Global Compliance(Shenzhen)Std & Tech Co., Ltd
Tel: +86-755 2523 4088 E-mail: agc@agc-cert.com Web: http://cn.agc-cert.com/



| PEAK OUTPUT POWER MEASUREMENT RESULT FOR 8-DPSK MODULATION | | | |
|---|------------------|-------------------------|--------------|
| Frequency (GHz) | Peak Power (dBm) | Applicable Limits (dBm) | Pass or Fail |
| 2.402 | 1.899 | 21 | Pass |
| 2.441 | 1.984 | 21 | Pass |
| 2.480 | 2.288 | 21 | Pass |

CH0

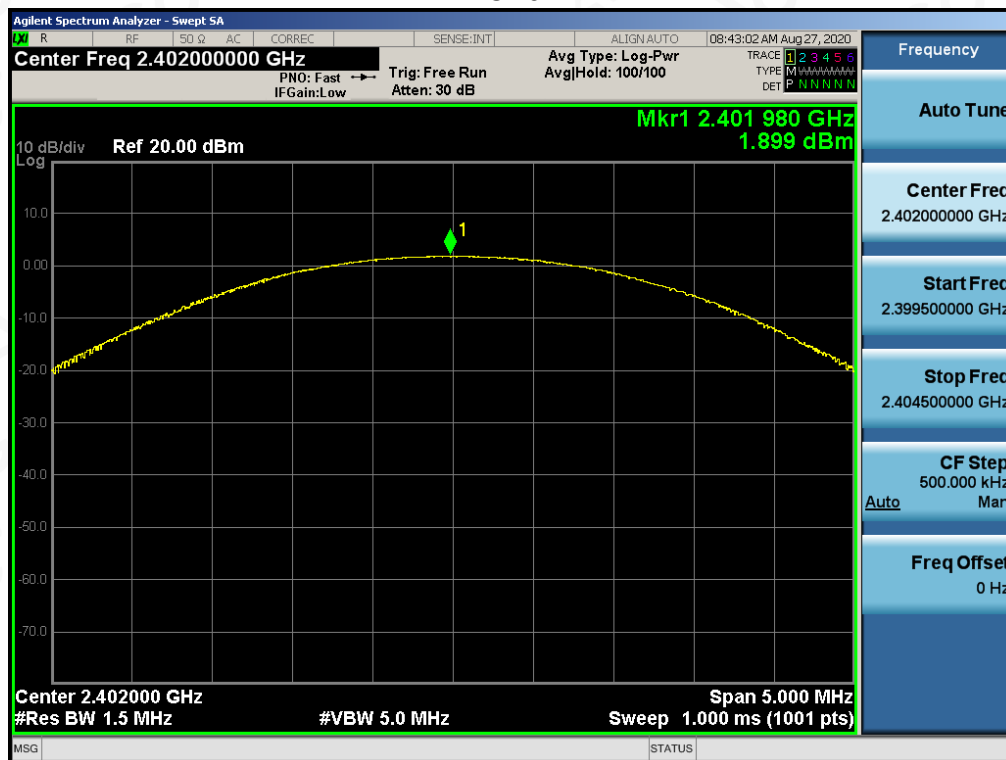

Any report having not been signed by authorized approver, or having been altered without authorization, or having not been stamped by the "Dedicated Testing/Inspection Stamp" is deemed to be invalid. Copying or excerpting portion of, or altering the content of the report is not permitted without the written authorization of AGC. The test results presented in the report apply only to the tested sample. Any objections to report issued by AGC should be submitted to AGC within 15 days after the issuance of the test report. Further enquiry of validity or verification of the test report should be addressed to AGC by agc@agc-cert.com.

Attestation of Global Compliance(Shenzhen)Co., Ltd
Attestation of Global Compliance(Shenzhen)Std & Tech Co., Ltd
Tel: +86-755 2523 4088 E-mail: agc@agc-cert.com Web: http://cn.agc-cert.com/



CH39

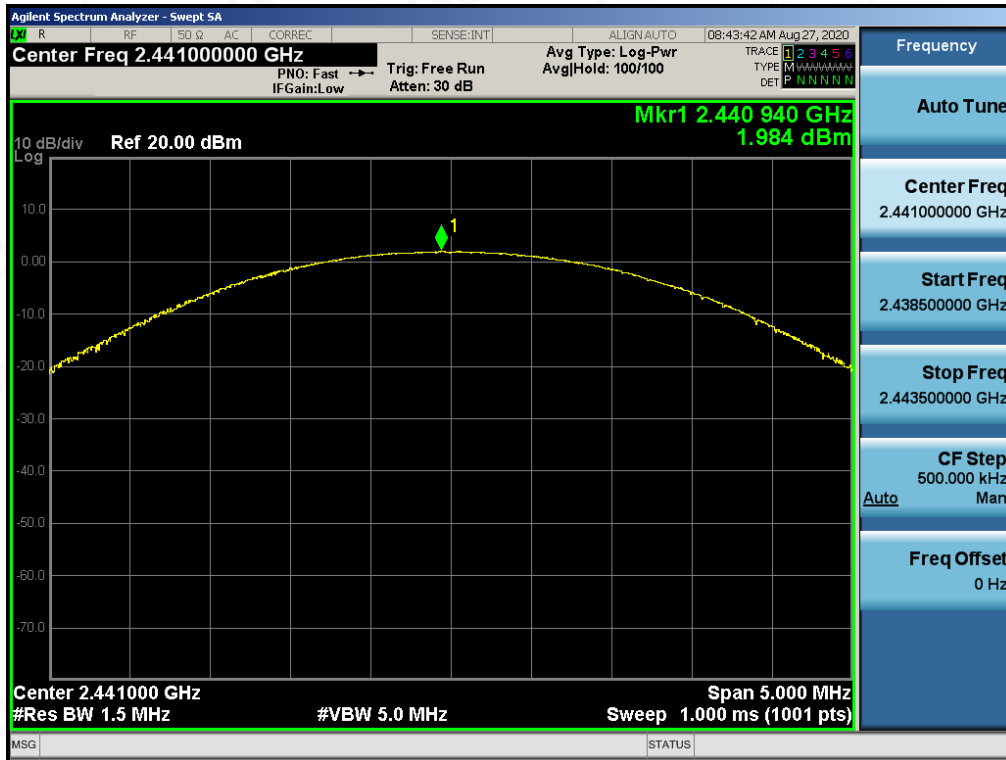

CH78

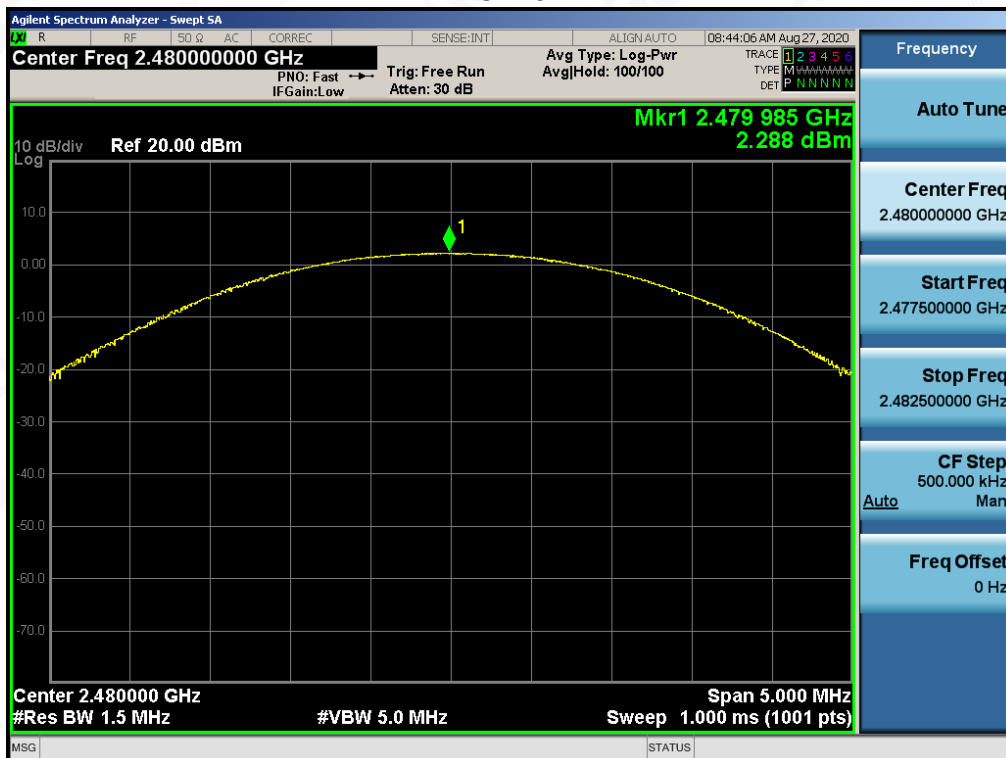

Any report having not been signed by authorized approver, or having been altered without authorization, or having not been stamped by the "Dedicated Testing/Inspection Stamp" is deemed to be invalid. Copying or excerpting portion of, or altering the content of the report is not permitted without the written authorization of AGC. The test results presented in the report apply only to the tested sample. Any objections to report issued by AGC should be submitted to AGC within 15 days after the issuance of the test report. Further enquiry of validity or verification of the test report should be addressed to AGC by agc@agc-cert.com.

Attestation of Global Compliance(Shenzhen)Co., Ltd
Attestation of Global Compliance(Shenzhen)Std & Tech Co., Ltd
Tel: +86-755 2523 4088 E-mail: agc@agc-cert.com Web: http://cn.agc-cert.com/



8. 20DB BANDWIDTH

8.1. MEASUREMENT PROCEDURE

1. Connect EUT RF output port to the Spectrum Analyzer through an RF attenuator
2. Set the EUT Work on the top, the middle and the bottom operation frequency individually.
3. Set Span = approximately 2 to 5 times the 20 dB bandwidth, centered on a hoping channel
The nominal IF filter bandwidth (3 dB RBW) shall be in the range of 1% to 5% of the OBW and video bandwidth (VBW) shall be approximately three times RBW; Sweep = auto; Detector function = peak
4. Set SPA Trace 1 Max hold, then View.

8.2. TEST SET-UP (BLOCK DIAGRAM OF CONFIGURATION)

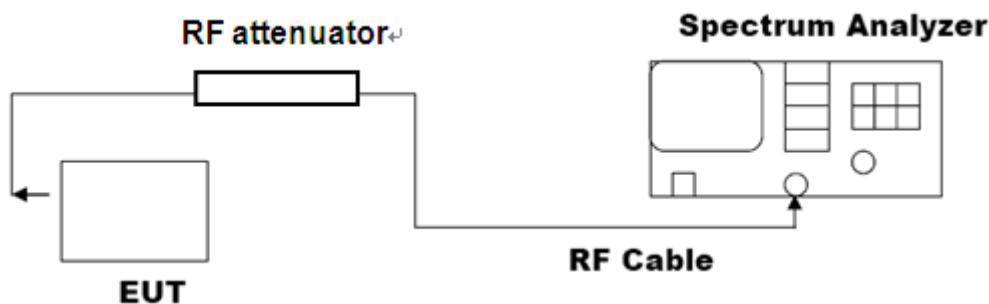

Any report having not been signed by authorized approver, or having been altered without authorization, or having not been stamped by the "Dedicated Testing/Inspection Stamp" is deemed to be invalid. Copying or excerpting portion of, or altering the content of the report is not permitted without the written authorization of AGC. The test results presented in the report apply only to the tested sample. Any objections to report issued by AGC should be submitted to AGC within 15 days after the issuance of the test report. Further enquiry of validity or verification of the test report should be addressed to AGC by agc@agc-cert.com.



8.3. LIMITS AND MEASUREMENT RESULTS

| MEASUREMENT RESULT FOR GFSK MODULATION | | | |
|--|--------------------|-------|----------|
| Applicable Limits | Measurement Result | | |
| | Test Data (MHz) | | Criteria |
| N/A | Low Channel | 0.959 | PASS |
| | Middle Channel | 0.957 | PASS |
| | High Channel | 0.962 | PASS |

TEST PLOT OF BANDWIDTH FOR LOW CHANNEL

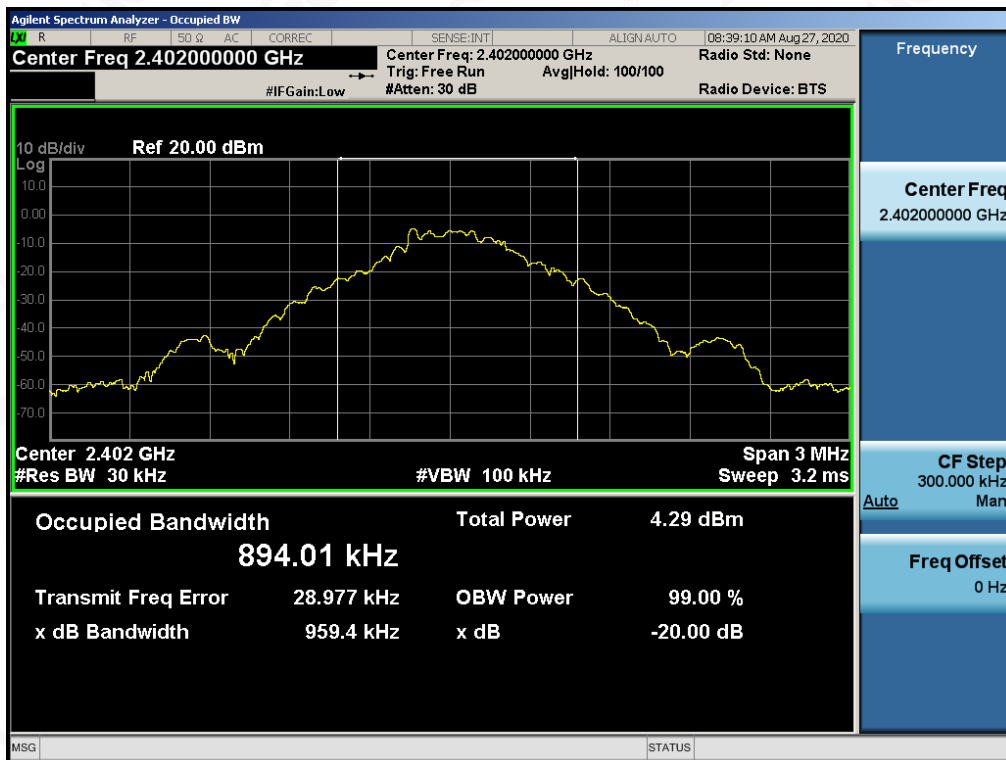

Any report having not been signed by authorized approver, or having been altered without authorization, or having not been stamped by the "Dedicated Testing/Inspection Stamp" is deemed to be invalid. Copying or excerpting portion of, or altering the content of the report is not permitted without the written authorization of AGC. The test results presented in the report apply only to the tested sample. Any objections to report issued by AGC should be submitted to AGC within 15 days after the issuance of the test report. Further enquiry of validity or verification of the test report should be addressed to AGC by agc@agc-cert.com.

Attestation of Global Compliance(Shenzhen)Co., Ltd
Attestation of Global Compliance(Shenzhen)Std & Tech Co., Ltd
Tel: +86-755 2523 4088 E-mail: agc@agc-cert.com Web: http://cn.agc-cert.com/



TEST PLOT OF BANDWIDTH FOR MIDDLE CHANNEL

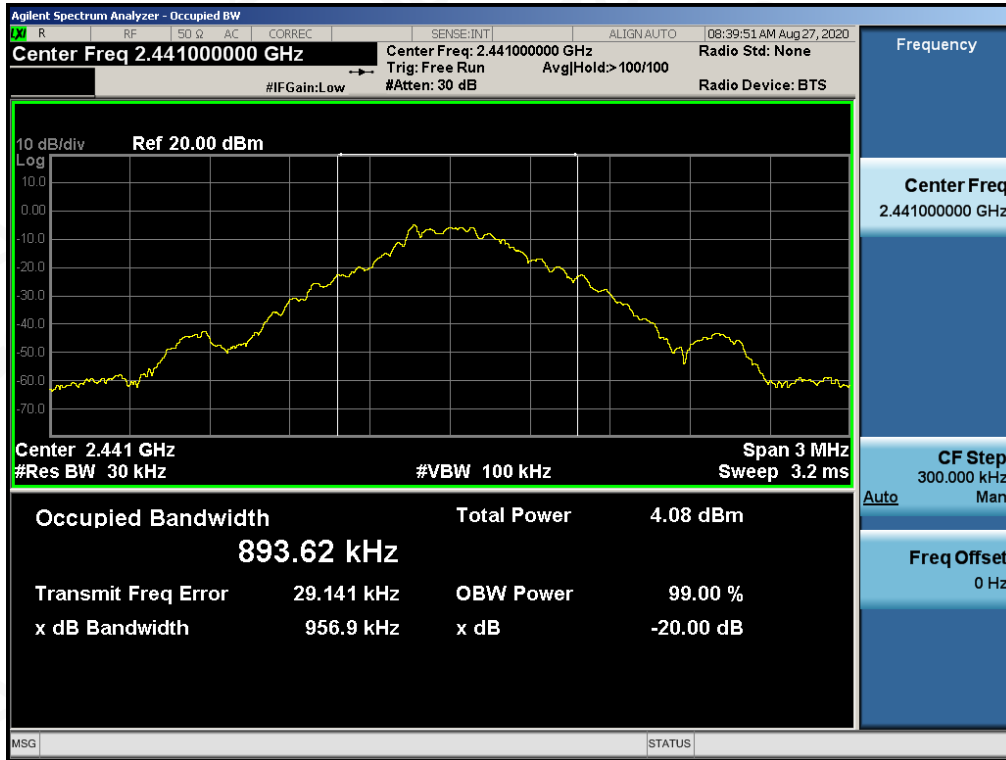

TEST PLOT OF BANDWIDTH FOR HIGH CHANNEL

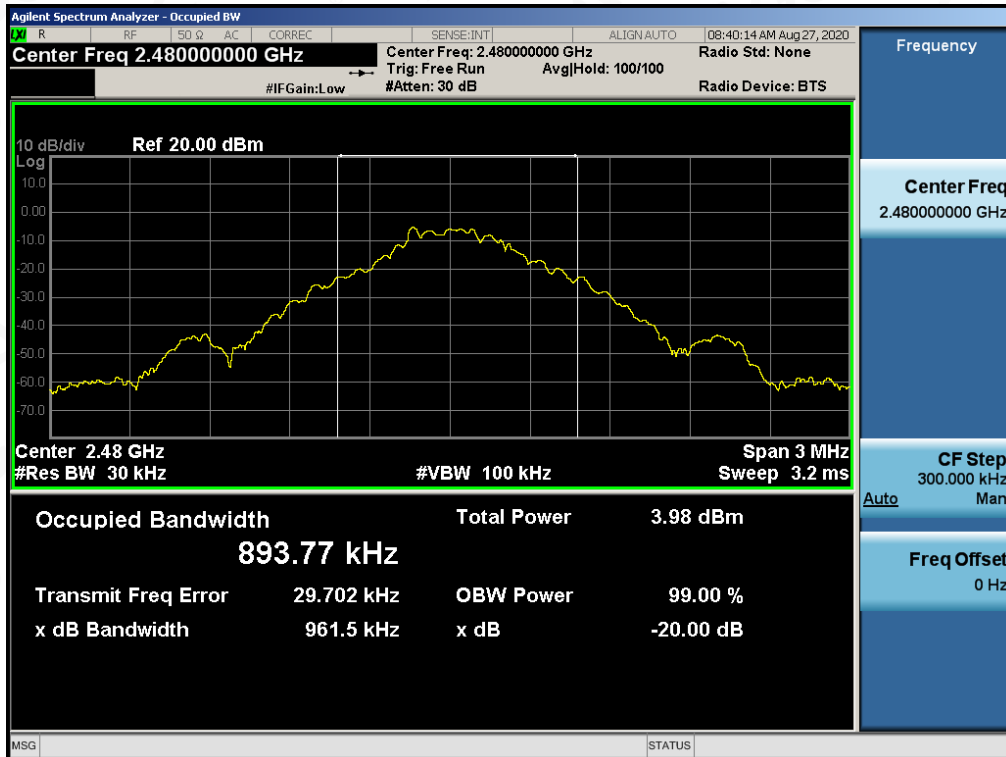

Any report having not been signed by authorized approver, or having been altered without authorization, or having not been stamped by the "Dedicated Testing/Inspection Stamp" is deemed to be invalid. Copying or excerpting portion of, or altering the content of the report is not permitted without the written authorization of AGC. The test results presented in the report apply only to the tested sample. Any objections to report issued by AGC should be submitted to AGC within 15 days after the issuance of the test report. Further enquiry of validity or verification of the test report should be addressed to AGC by agc@agc-cert.com.



| MEASUREMENT RESULT FOR Π /4-DQPSK MODULATION | | | |
|--|--------------------|-------|----------|
| Applicable Limits | Measurement Result | | |
| | Test Data (MHz) | | Criteria |
| N/A | Low Channel | 1.296 | PASS |
| | Middle Channel | 1.294 | PASS |
| | High Channel | 1.334 | PASS |

TEST PLOT OF BANDWIDTH FOR LOW CHANNEL

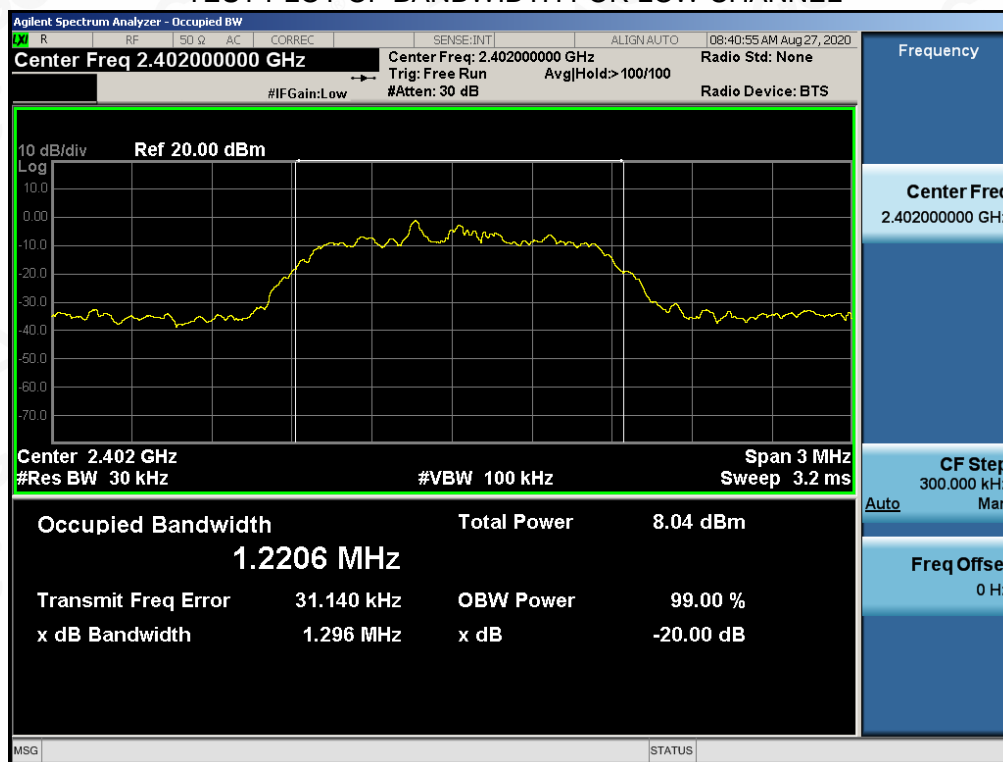

Any report having not been signed by authorized approver, or having been altered without authorization, or having not been stamped by the "Dedicated Testing/Inspection Stamp" is deemed to be invalid. Copying or excerpting portion of, or altering the content of the report is not permitted without the written authorization of AGC. The test results presented in the report apply only to the tested sample. Any objections to report issued by AGC should be submitted to AGC within 15 days after the issuance of the test report. Further enquiry of validity or verification of the test report should be addressed to AGC by agc@agc-cert.com.

Attestation of Global Compliance(Shenzhen)Co., Ltd
Attestation of Global Compliance(Shenzhen)Std & Tech Co., Ltd
Tel: +86-755 2523 4088 E-mail: agc@agc-cert.com Web: http://cn.agc-cert.com/



TEST PLOT OF BANDWIDTH FOR MIDDLE CHANNEL

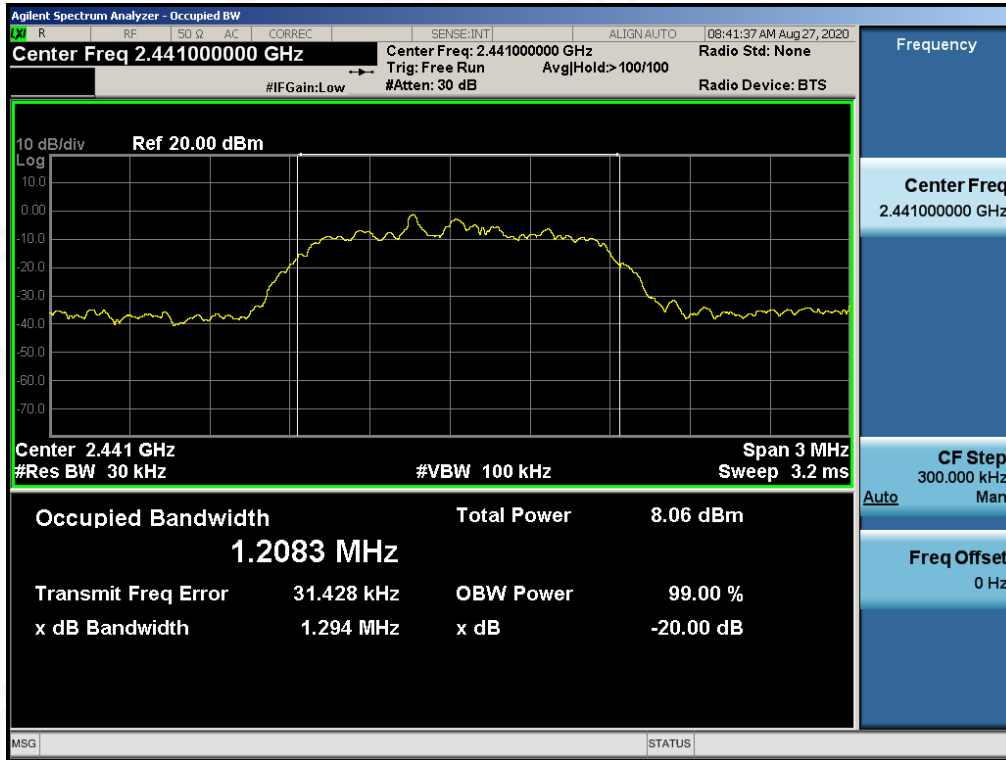

TEST PLOT OF BANDWIDTH FOR HIGH CHANNEL

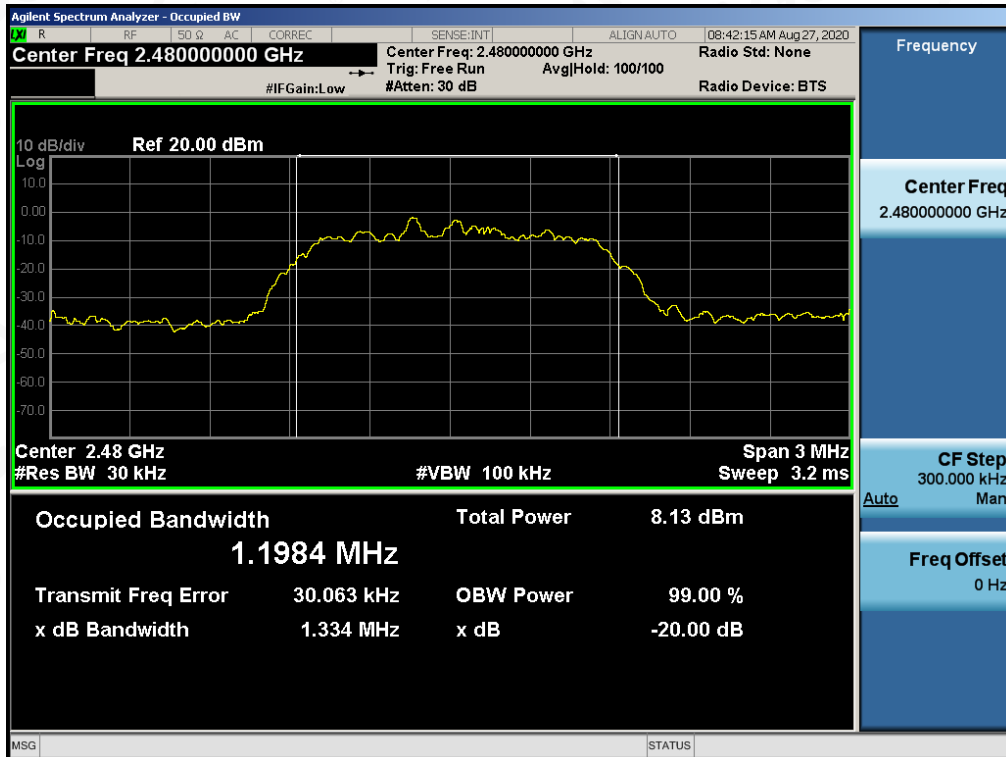

Any report having not been signed by authorized approver, or having been altered without authorization, or having not been stamped by the "Dedicated Testing/Inspection Stamp" is deemed to be invalid. Copying or excerpting portion of, or altering the content of the report is not permitted without the written authorization of AGC. The test results presented in the report apply only to the tested sample. Any objections to report issued by AGC should be submitted to AGC within 15 days after the issuance of the test report. Further enquiry of validity or verification of the test report should be addressed to AGC by agc@agc-cert.com.



| MEASUREMENT RESULT FOR 8-DPSK MODULATION | | | |
|--|--------------------|-------|----------|
| Applicable Limits | Measurement Result | | |
| | Test Data (MHz) | | Criteria |
| N/A | Low Channel | 1.307 | PASS |
| | Middle Channel | 1.310 | PASS |
| | High Channel | 1.308 | PASS |

TEST PLOT OF BANDWIDTH FOR LOW CHANNEL

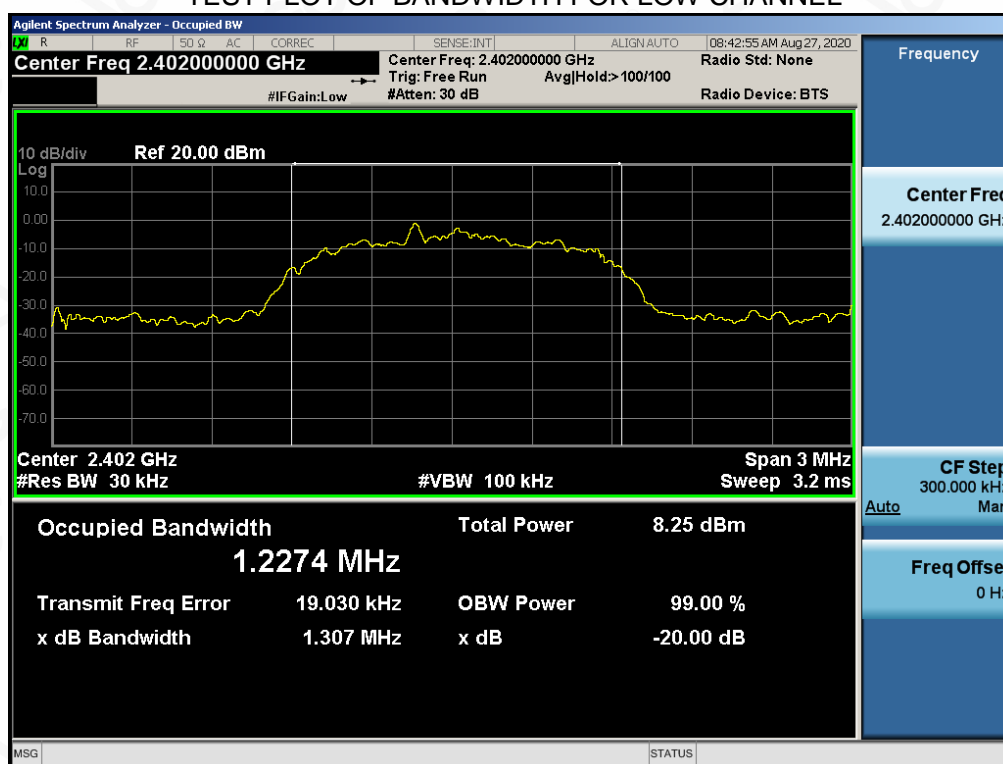

Any report having not been signed by authorized approver, or having been altered without authorization, or having not been stamped by the "Dedicated Testing/Inspection Stamp" is deemed to be invalid. Copying or excerpting portion of, or altering the content of the report is not permitted without the written authorization of AGC. The test results presented in the report apply only to the tested sample. Any objections to report issued by AGC should be submitted to AGC within 15 days after the issuance of the test report. Further enquiry of validity or verification of the test report should be addressed to AGC by agc@agc-cert.com.

Attestation of Global Compliance(Shenzhen)Co., Ltd
Attestation of Global Compliance(Shenzhen)Std & Tech Co., Ltd
Tel: +86-755 2523 4088 E-mail: agc@agc-cert.com Web: http://cn.agc-cert.com/



TEST PLOT OF BANDWIDTH FOR MIDDLE CHANNEL

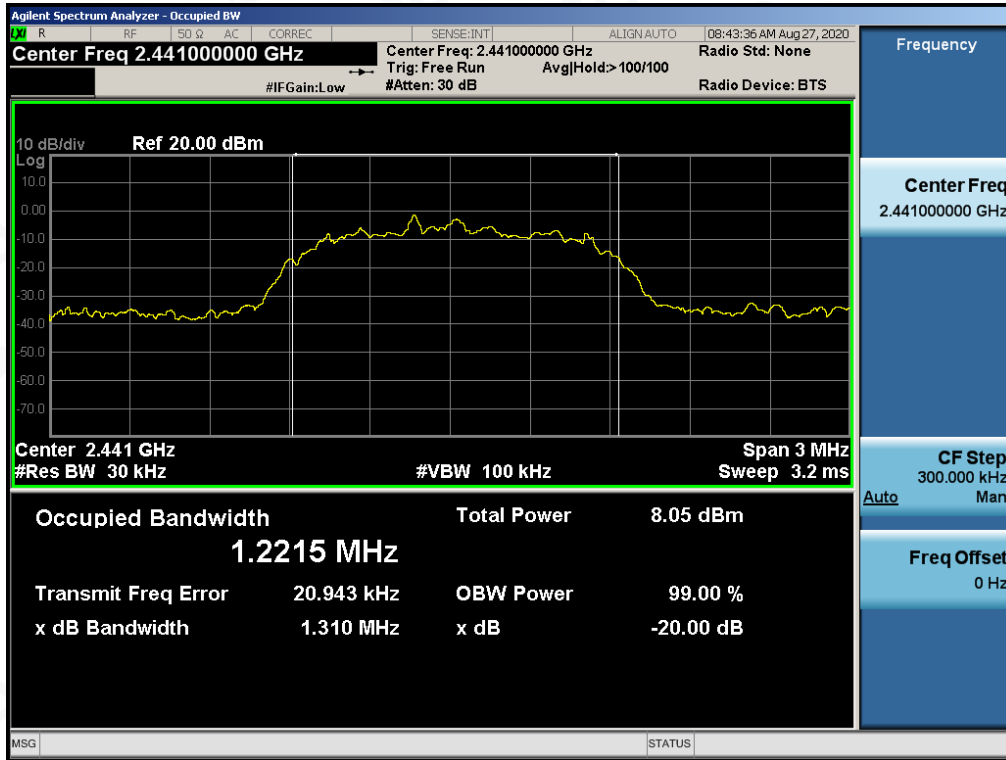

TEST PLOT OF BANDWIDTH FOR HIGH CHANNEL

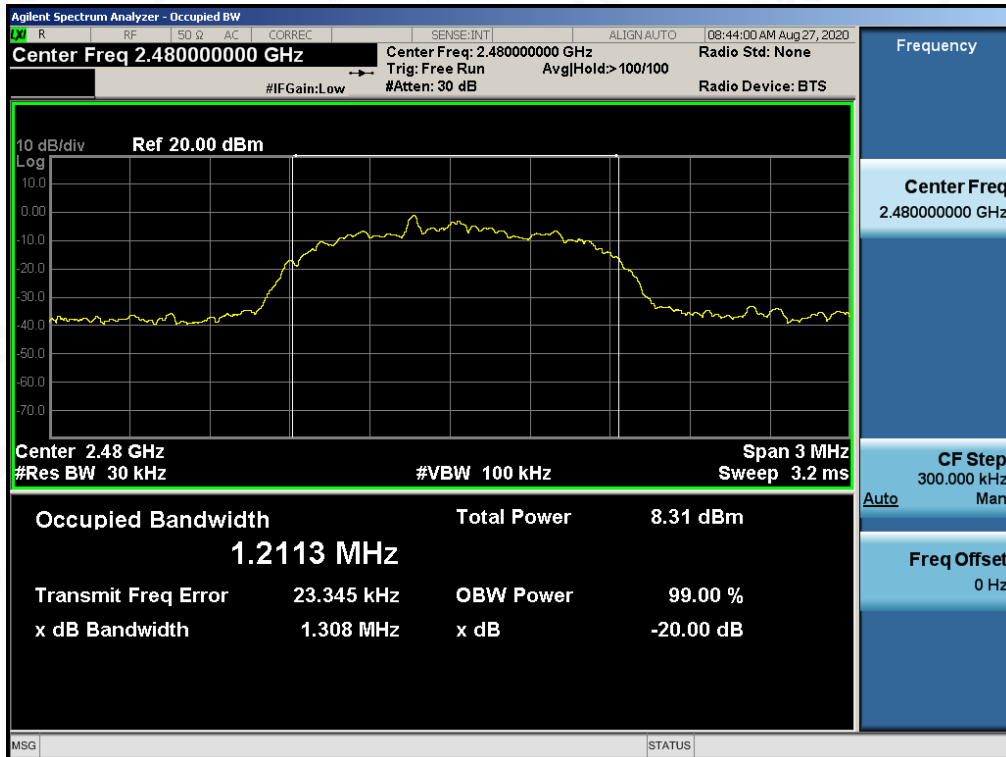

Any report having not been signed by authorized approver, or having been altered without authorization, or having not been stamped by the "Dedicated Testing/Inspection Stamp" is deemed to be invalid. Copying or excerpting portion of, or altering the content of the report is not permitted without the written authorization of AGC. The test results presented in the report apply only to the tested sample. Any objections to report issued by AGC should be submitted to AGC within 15 days after the issuance of the test report. Further enquiry of validity or verification of the test report should be addressed to AGC by agc@agc-cert.com.



9. CONDUCTED SPURIOUS EMISSION

9.1. MEASUREMENT PROCEDURE

1. Connect EUT RF output port to the Spectrum Analyzer through an RF attenuator
2. Set the EUT Work on the top, the Middle and the bottom operation frequency individually.
3. Set the Span = wide enough to capture the peak level of the in-band emission and all spurious emissions from the lowest frequency generated in the EUT up through the 10th harmonic.
RBW = 100 kHz; VBW= 300 kHz; Sweep = auto; Detector function = peak.
4. Set SPA Trace 1 Max hold, then View.

9.2. TEST SET-UP (BLOCK DIAGRAM OF CONFIGURATION)

The same as described in section 8.2

9.3. MEASUREMENT EQUIPMENT USED

The same as described in section 6

9.4. LIMITS AND MEASUREMENT RESULT

| LIMITS AND MEASUREMENT RESULT | | |
|--|--|----------|
| Applicable Limits | Measurement Result | |
| | Test Data | Criteria |
| In any 100 kHz Bandwidth Outside the frequency band in which the spread spectrum intentional radiator is operating, the radio frequency power that is produce by the intentional radiator shall be at least 20 dB below that in 100KHz bandwidth within the band that contains the highest level of the desired power. In addition, radiation emissions which fall in the restricted bands, as defined in §15.205(a), must also comply with the radiated emission limits specified in§15.209(a) | At least -20dBc than the limit Specified on the BOTTOM Channel | PASS |
| | At least -20dBc than the limit Specified on the TOP Channel | PASS |

Any report having not been signed by authorized approver, or having been altered without authorization, or having not been stamped by the "Dedicated Testing/Inspection Stamp" is deemed to be invalid. Copying or excerpting portion of, or altering the content of the report is not permitted without the written authorization of AGC. The test results presented in the report apply only to the tested sample. Any objections to report issued by AGC should be submitted to AGC within 15days after the issuance of the test report. Further enquiry of validity or verification of the test report should be addressed to AGC by agc@agc-cert.com.



TEST RESULT FOR ENTIRE FREQUENCY RANGE
TEST PLOT OF OUT OF BAND EMISSIONS WITH THE WORST CASE
OF 8DPSK MODULATION IN LOW CHANNEL

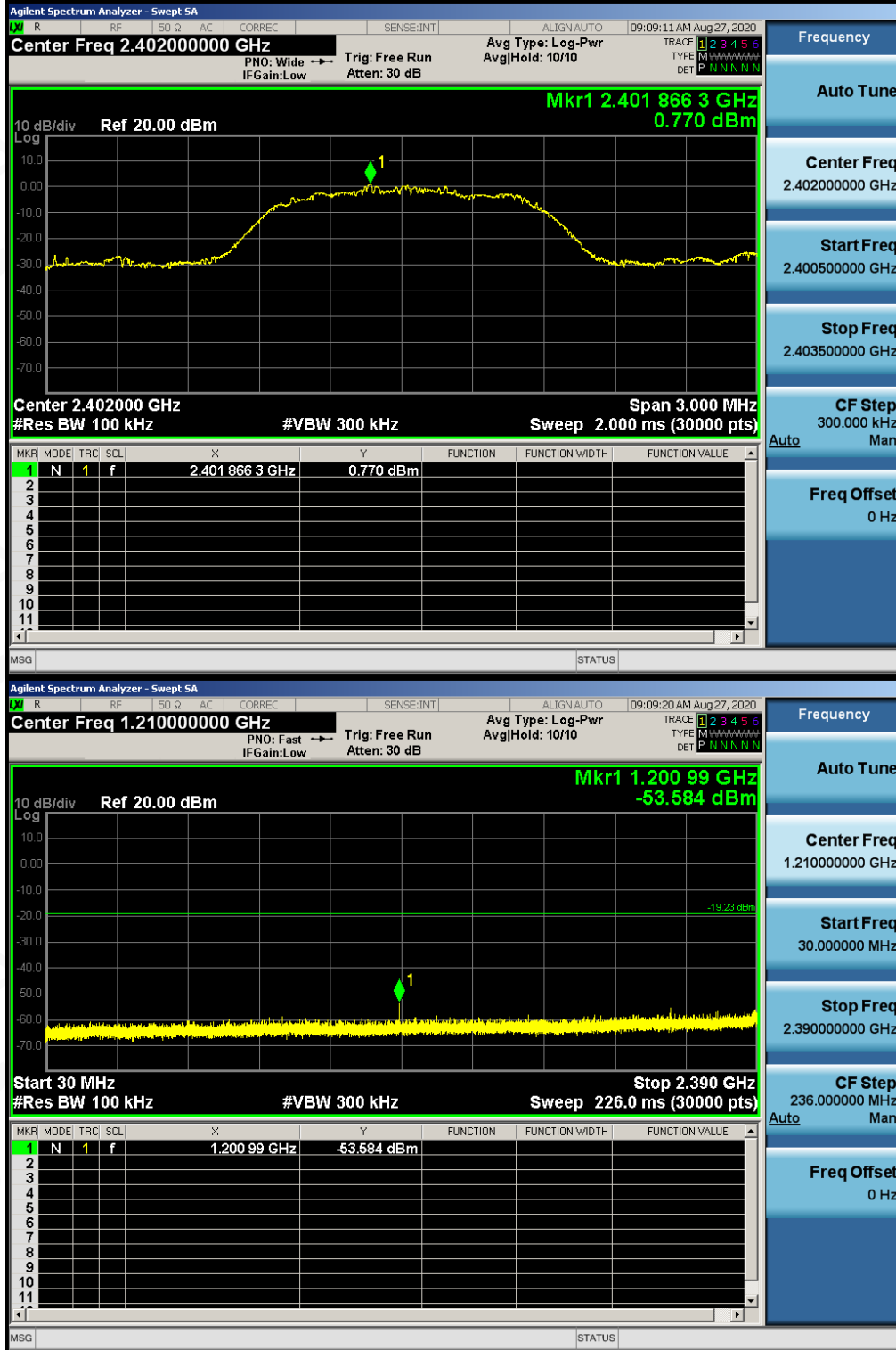

Any report having not been signed by authorized approver, or having been altered without authorization, or having not been stamped by the "Dedicated Testing/Inspection Stamp" is deemed to be invalid. Copying or excerpting portion of, or altering the content of the report is not permitted without the written authorization of AGC. The test results presented in the report apply only to the tested sample. Any objections to report issued by AGC should be submitted to AGC within 15 days after the issuance of the test report. Further enquiry of validity or verification of the test report should be addressed to AGC by agc@agc-cert.com.

Attestation of Global Compliance(Shenzhen)Co., Ltd
Attestation of Global Compliance(Shenzhen)Std & Tech Co., Ltd
Tel: +86-755 2523 4088 E-mail: agc@agc-cert.com Web: http://cn.agc-cert.com/



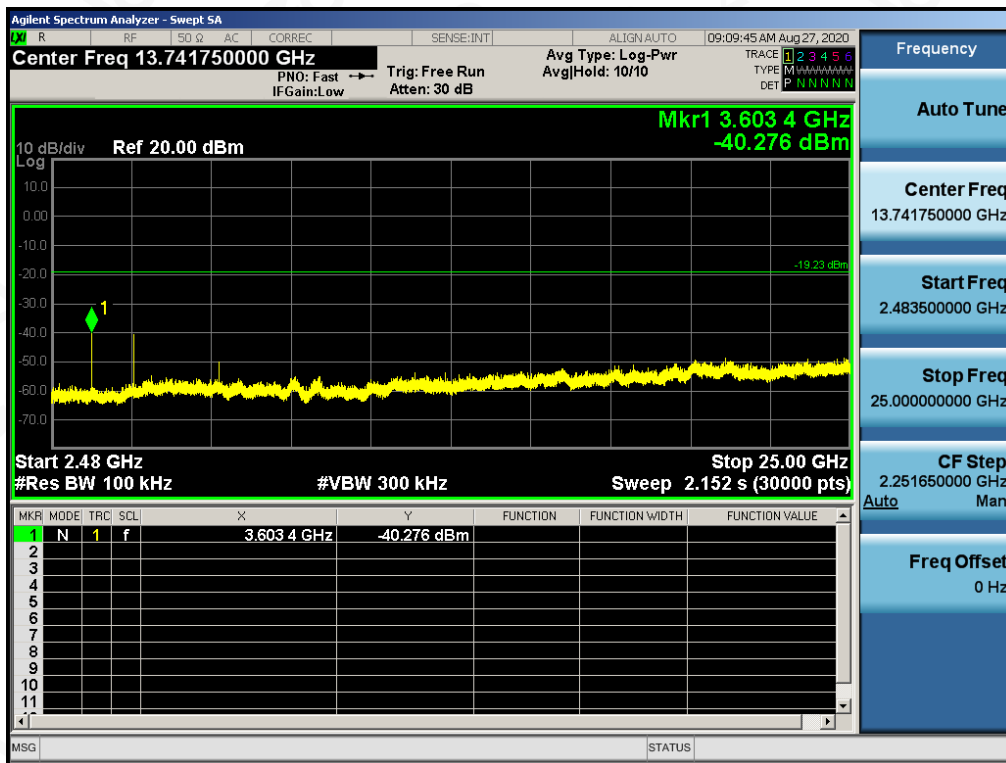

Any report having not been signed by authorized approver, or having been altered without authorization, or having not been stamped by the "Dedicated Testing/Inspection Stamp" is deemed to be invalid. Copying or excerpting portion of, or altering the content of the report is not permitted without the written authorization of AGC. The test results presented in the report apply only to the tested sample. Any objections to report issued by AGC should be submitted to AGC within 15 days after the issuance of the test report. Further enquiry of validity or verification of the test report should be addressed to AGC by agc@agc-cert.com.

Attestation of Global Compliance(Shenzhen)Co., Ltd
Attestation of Global Compliance(Shenzhen)Std & Tech Co., Ltd
Tel: +86-755 2523 4088 E-mail: agc@agc-cert.com Web: http://cn.agc-cert.com/



TEST PLOT OF OUT OF BAND EMISSIONS
OF 8DPSK MODULATION IN MIDDLE CHANNEL

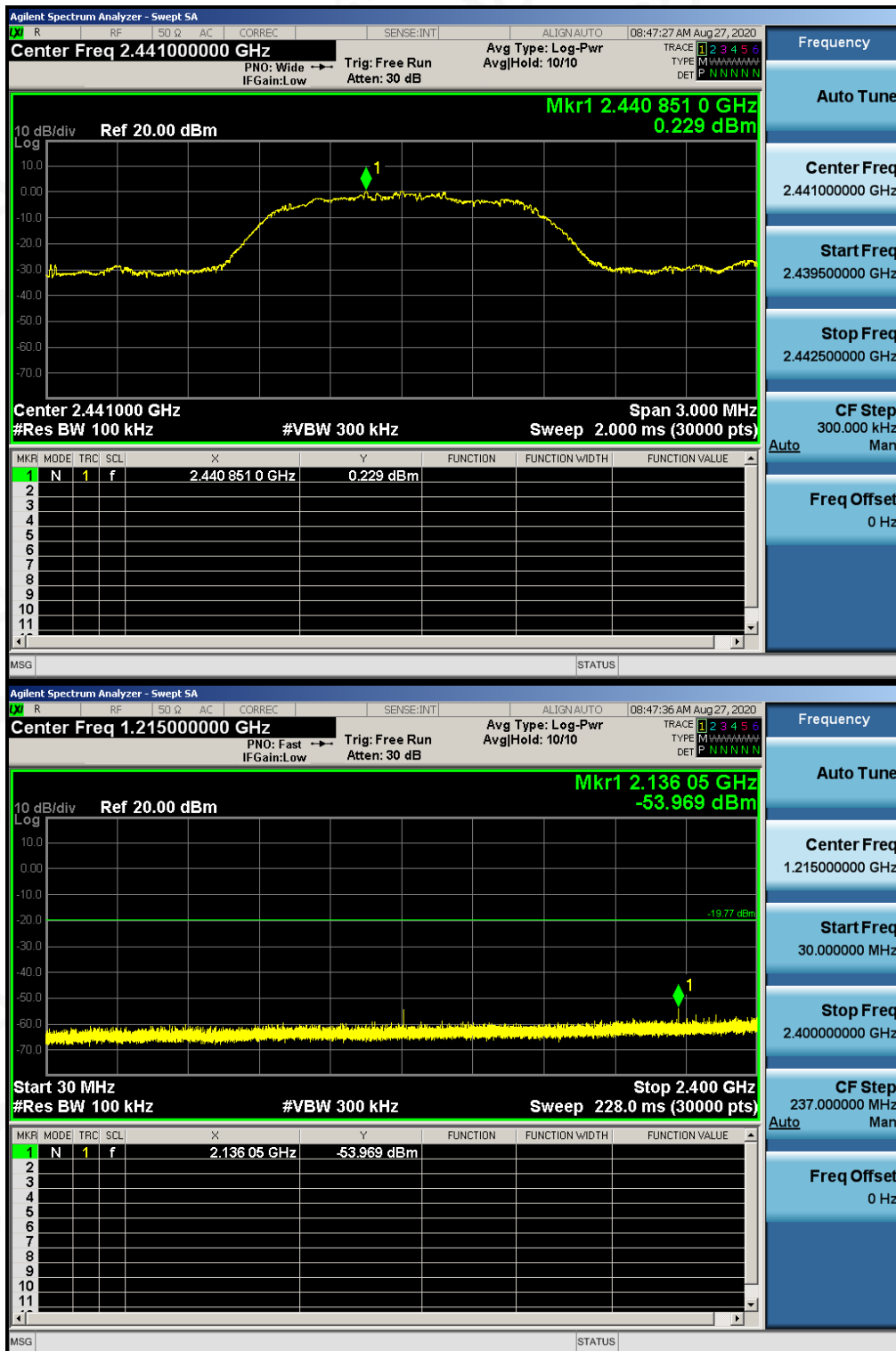

Any report having not been signed by authorized approver, or having been altered without authorization, or having not been stamped by the "Dedicated Testing/Inspection Stamp" is deemed to be invalid. Copying or excerpting portion of, or altering the content of the report is not permitted without the written authorization of AGC. The test results presented in the report apply only to the tested sample. Any objections to report issued by AGC should be submitted to AGC within 15 days after the issuance of the test report. Further enquiry of validity or verification of the test report should be addressed to AGC by agc@agc-cert.com.

Attestation of Global Compliance(Shenzhen)Co., Ltd
Attestation of Global Compliance(Shenzhen)Std & Tech Co., Ltd
Tel: +86-755 2523 4088 E-mail: agc@agc-cert.com Web: http://cn.agc-cert.com/



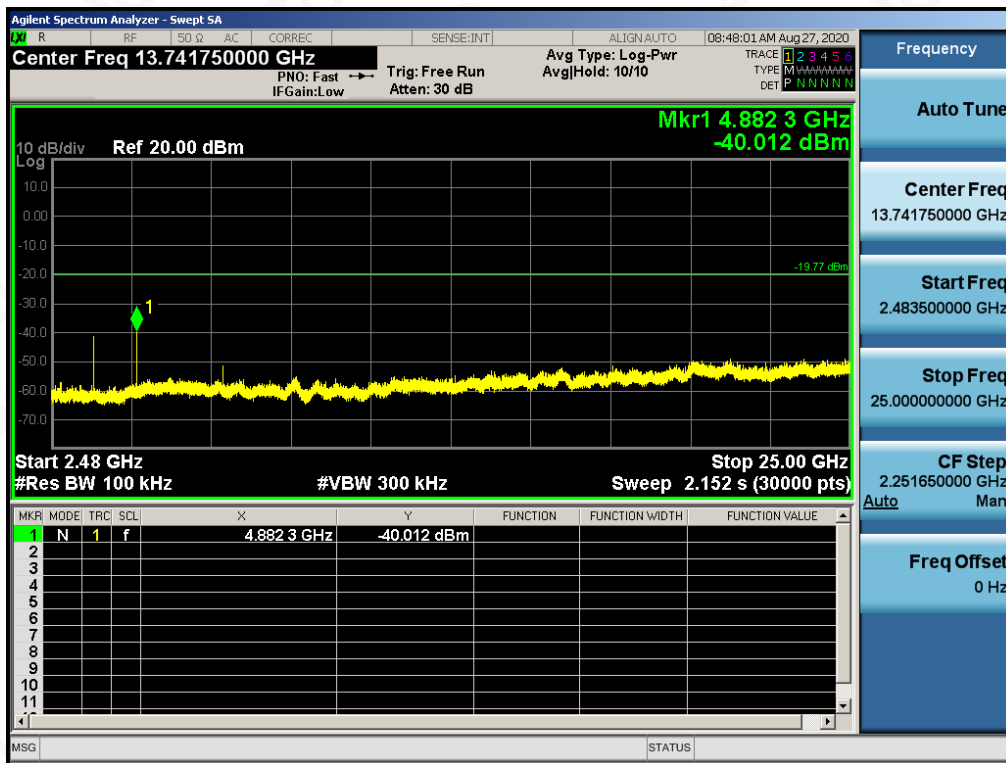

Any report having not been signed by authorized approver, or having been altered without authorization, or having not been stamped by the "Dedicated Testing/Inspection Stamp" is deemed to be invalid. Copying or excerpting portion of, or altering the content of the report is not permitted without the written authorization of AGC. The test results presented in the report apply only to the tested sample. Any objections to report issued by AGC should be submitted to AGC within 15 days after the issuance of the test report. Further enquiry of validity or verification of the test report should be addressed to AGC by agc@agc-cert.com.

Attestation of Global Compliance(Shenzhen)Co., Ltd
 Attestation of Global Compliance(Shenzhen)Std & Tech Co., Ltd
 Tel: +86-755 2523 4088 E-mail: agc@agc-cert.com Web: http://cn.agc-cert.com/



TEST PLOT OF OUT OF BAND EMISSIONS OF 8DPSK MODULATION IN HIGH CHANNEL

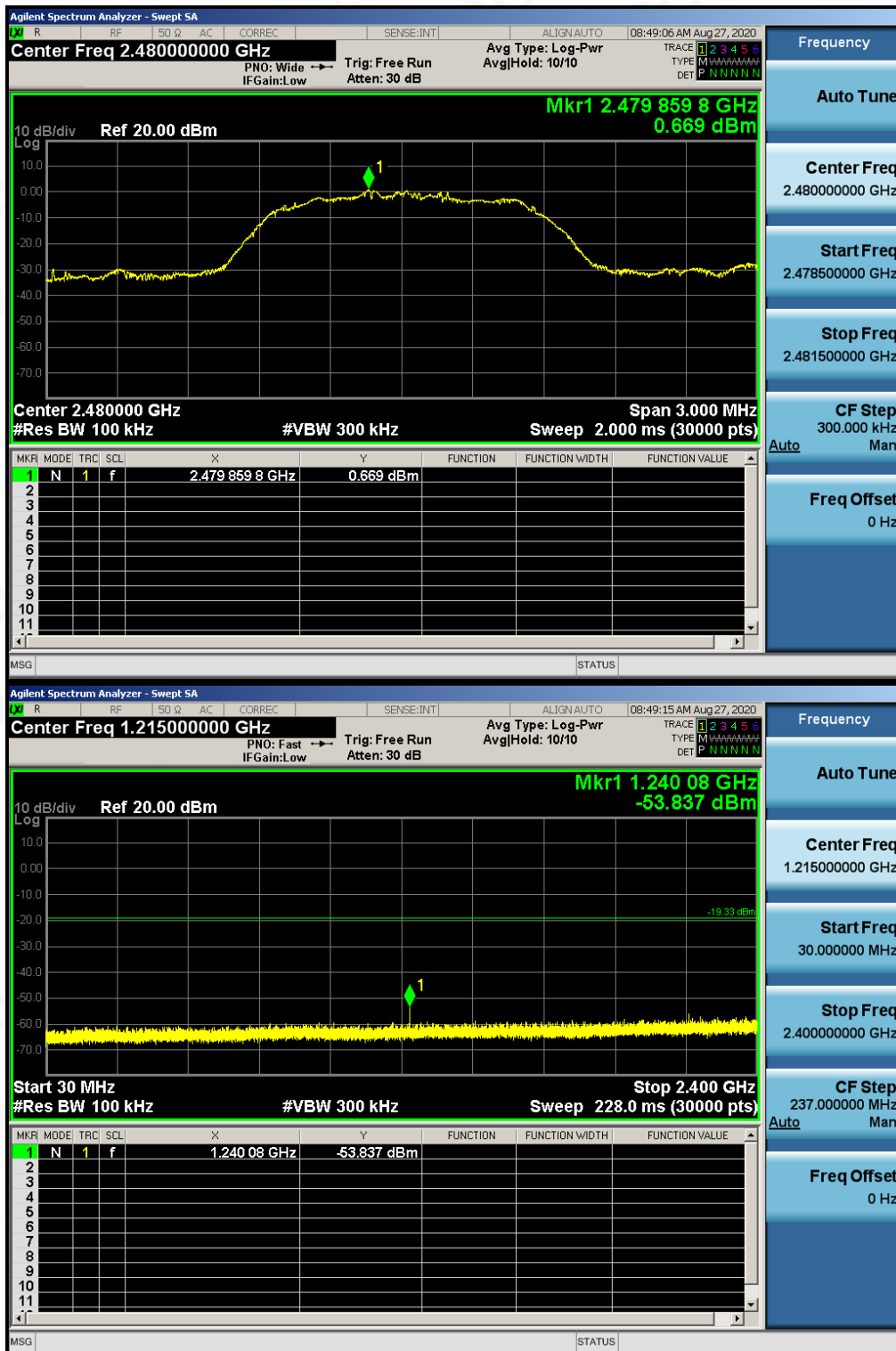

Any report having not been signed by authorized approver, or having been altered without authorization, or having not been stamped by the "Dedicated Testing/Inspection Stamp" is deemed to be invalid. Copying or excerpting portion of, or altering the content of the report is not permitted without the written authorization of AGC. The test results presented in the report apply only to the tested sample. Any objections to report issued by AGC should be submitted to AGC within 15 days after the issuance of the test report. Further enquiry of validity or verification of the test report should be addressed to AGC by agc@agc-cert.com.

Attestation of Global Compliance(Shenzhen)Co., Ltd
Attestation of Global Compliance(Shenzhen)Std & Tech Co., Ltd
Tel: +86-755 2523 4088 E-mail: agc@agc-cert.com Web: http://cn.agc-cert.com/



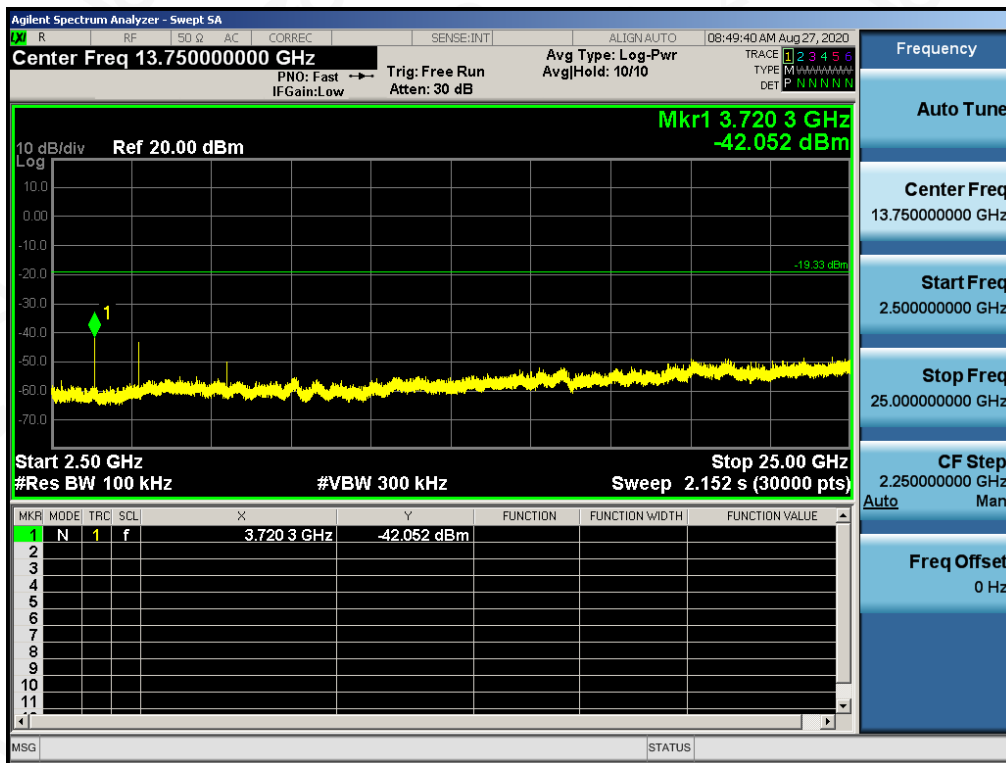

Note: The 8DPSK modulation is the worst case and only those data recorded in the report.

Any report having not been signed by authorized approver, or having been altered without authorization, or having not been stamped by the "Dedicated Testing/Inspection Stamp" is deemed to be invalid. Copying or excerpting portion of, or altering the content of the report is not permitted without the written authorization of AGC. The test results presented in the report apply only to the tested sample. Any objections to report issued by AGC should be submitted to AGC within 15 days after the issuance of the test report. Further enquiry of validity or verification of the test report should be addressed to AGC by agc@agc-cert.com.

Attestation of Global Compliance(Shenzhen)Co., Ltd
Attestation of Global Compliance(Shenzhen)Std & Tech Co., Ltd
Tel: +86-755 2523 4088 E-mail: agc@agc-cert.com Web: http://cn.agc-cert.com/



TEST RESULT FOR BAND EDGE

GFSK MODULATION IN LOW CHANNEL

Hopping off

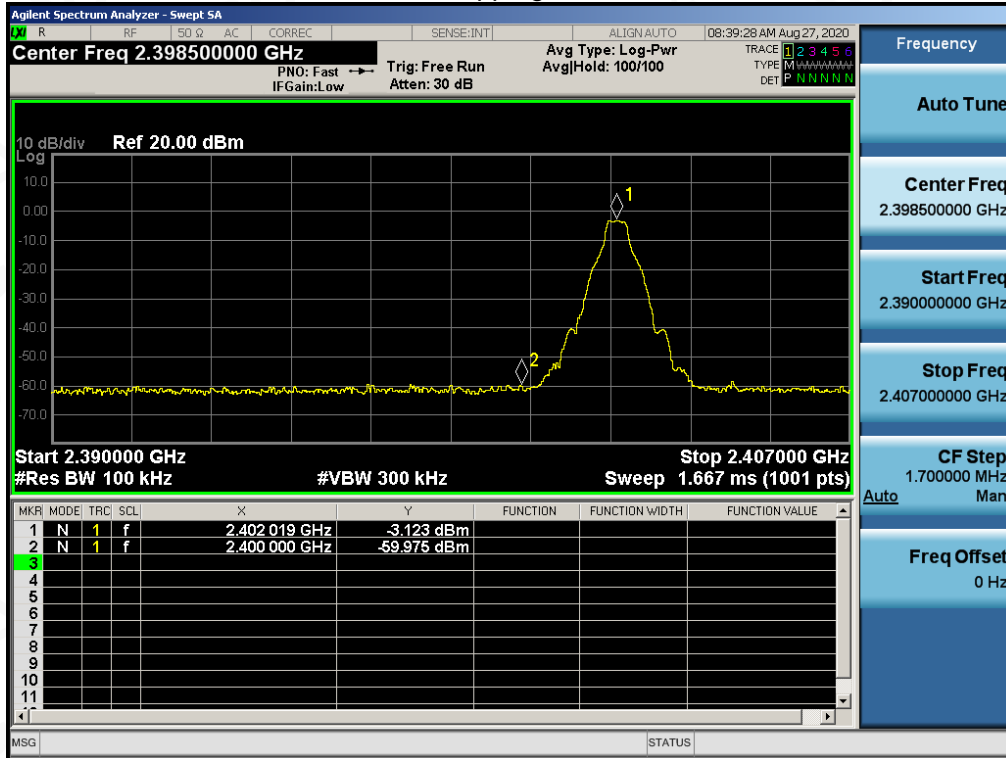

Hopping on

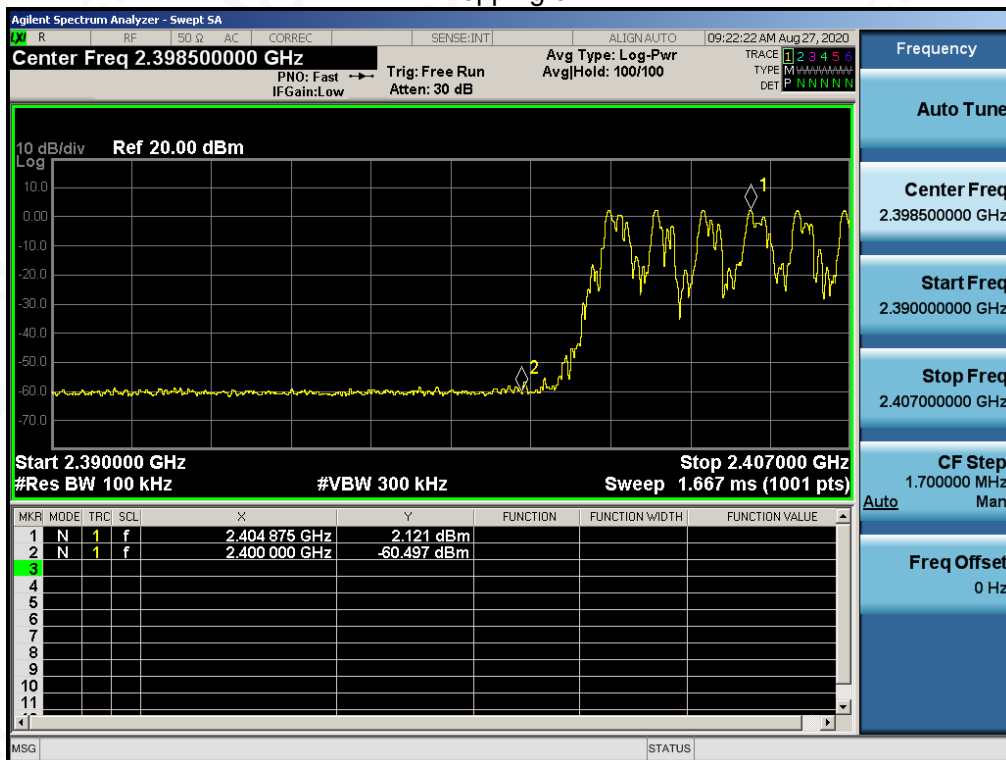

Any report having not been signed by authorized approver, or having been altered without authorization, or having not been stamped by the "Dedicated Testing/Inspection Stamp" is deemed to be invalid. Copying or excerpting portion of, or altering the content of the report is not permitted without the written authorization of AGC. The test results presented in the report apply only to the tested sample. Any objections to report issued by AGC should be submitted to AGC within 15 days after the issuance of the test report. Further enquiry of validity or verification of the test report should be addressed to AGC by agc@agc-cert.com.



GFSK MODULATION IN HIGH CHANNEL Hopping off

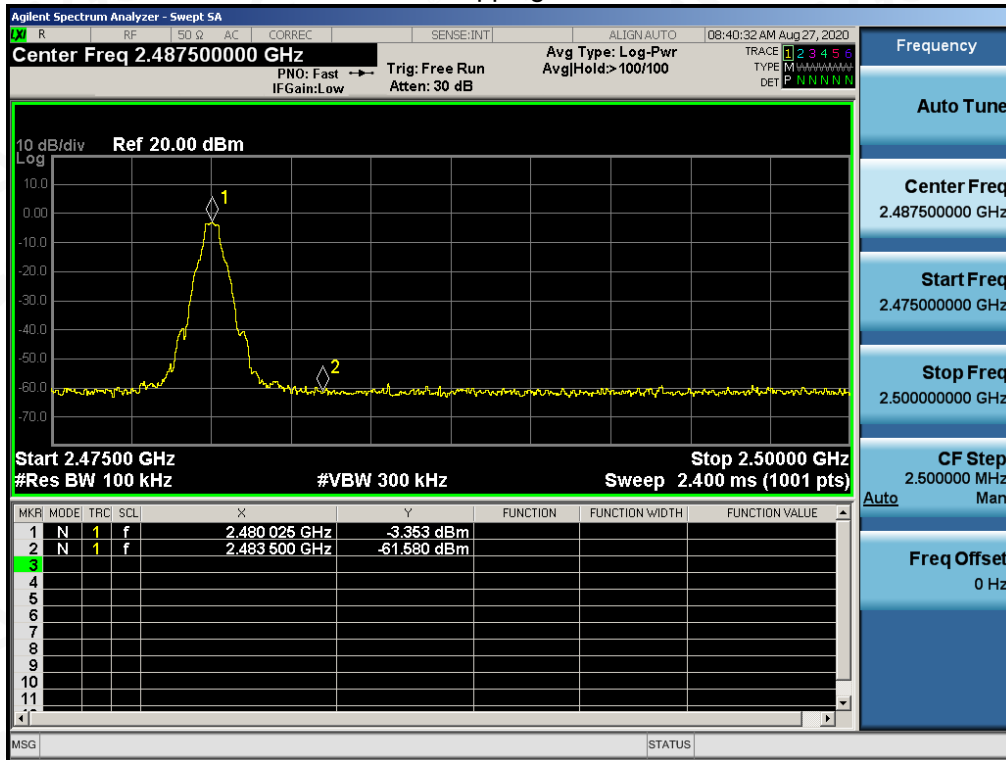

Hopping on

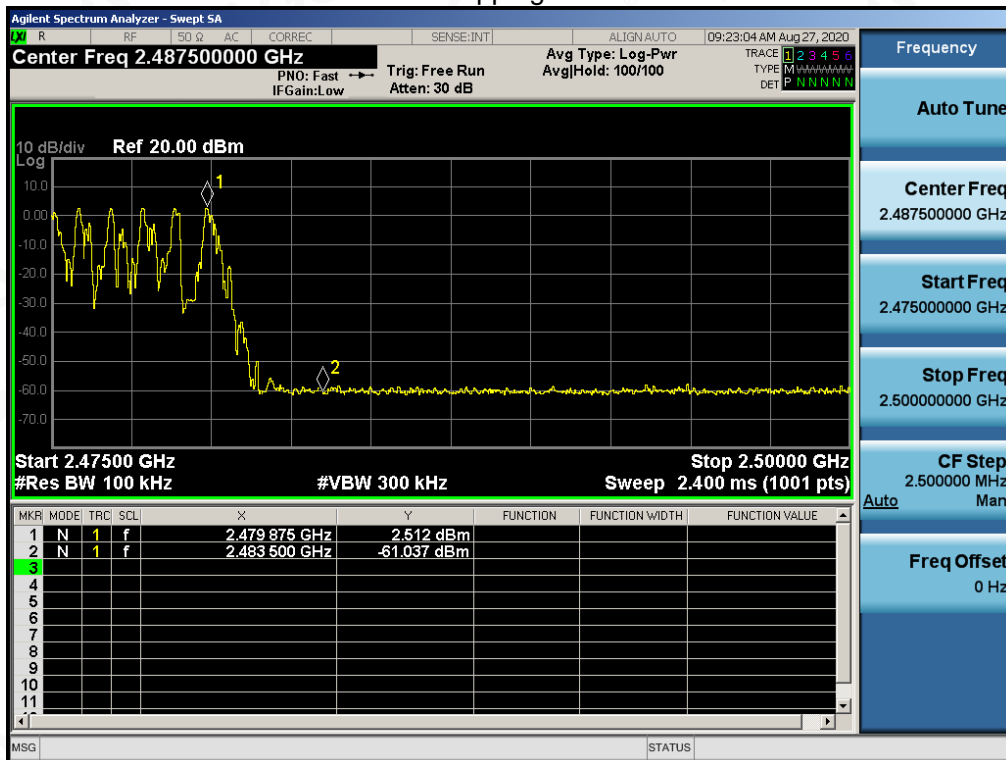

Any report having not been signed by authorized approver, or having been altered without authorization, or having not been stamped by the "Dedicated Testing/Inspection Stamp" is deemed to be invalid. Copying or excerpting portion of, or altering the content of the report is not permitted without the written authorization of AGC. The test results presented in the report apply only to the tested sample. Any objections to report issued by AGC should be submitted to AGC within 15 days after the issuance of the test report. Further enquiry of validity or verification of the test report should be addressed to AGC by agc@agc-cert.com.

Attestation of Global Compliance(Shenzhen)Co., Ltd
Attestation of Global Compliance(Shenzhen)Std & Tech Co., Ltd
Tel: +86-755 2523 4088 E-mail: agc@agc-cert.com Web: http://cn.agc-cert.com/



π /4-DQPSK MODULATION IN LOW CHANNEL
Hopping off

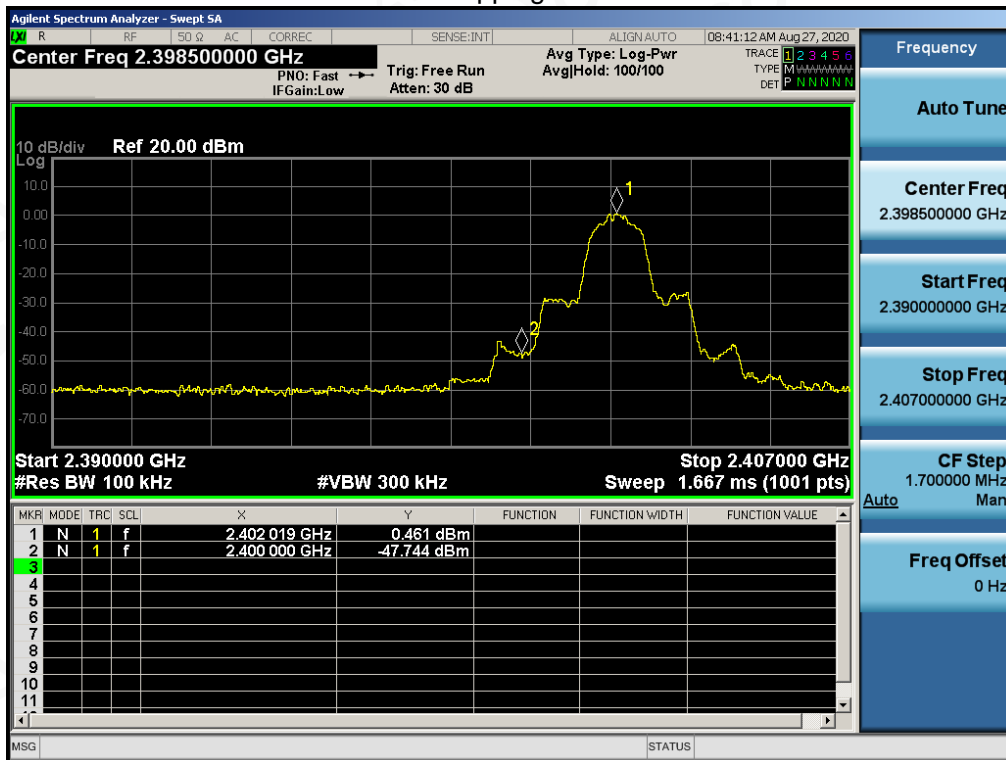

Hopping on

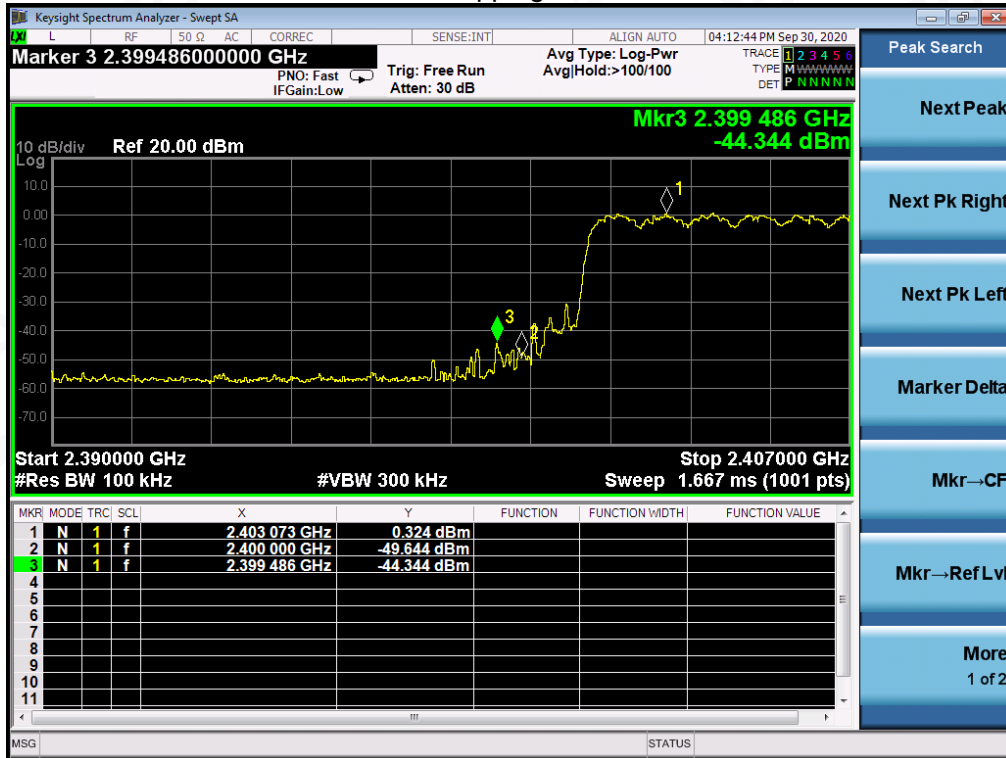

Any report having not been signed by authorized approver, or having been altered without authorization, or having not been stamped by the "Dedicated Testing/Inspection Stamp" is deemed to be invalid. Copying or excerpting portion of, or altering the content of the report is not permitted without the written authorization of AGC. The test results presented in the report apply only to the tested sample. Any objections to report issued by AGC should be submitted to AGC within 15days after the issuance of the test report. Further enquiry of validity or verification of the test report should be addressed to AGC by agc@agc-cert.com.

Attestation of Global Compliance(Shenzhen)Co., Ltd
Attestation of Global Compliance(Shenzhen)Std & Tech Co., Ltd
Tel: +86-755 2523 4088 E-mail: agc@agc-cert.com Web: http://cn.agc-cert.com/



π /4-DQPSK MODULATION IN HIGH CHANNEL
Hopping off

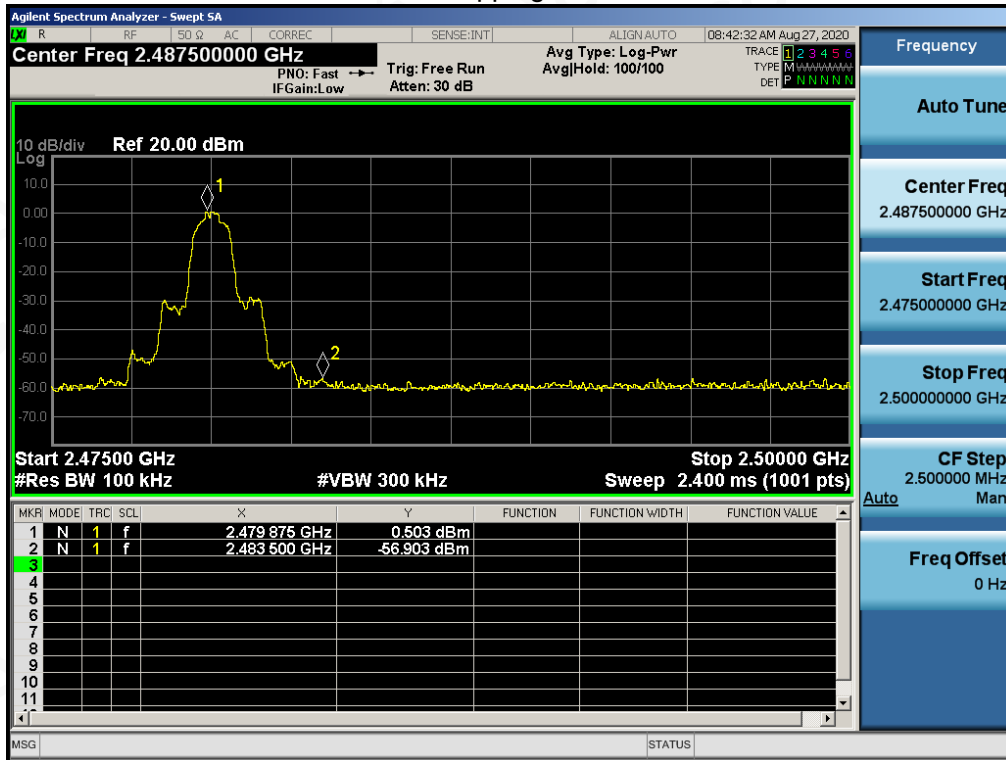

Hopping on

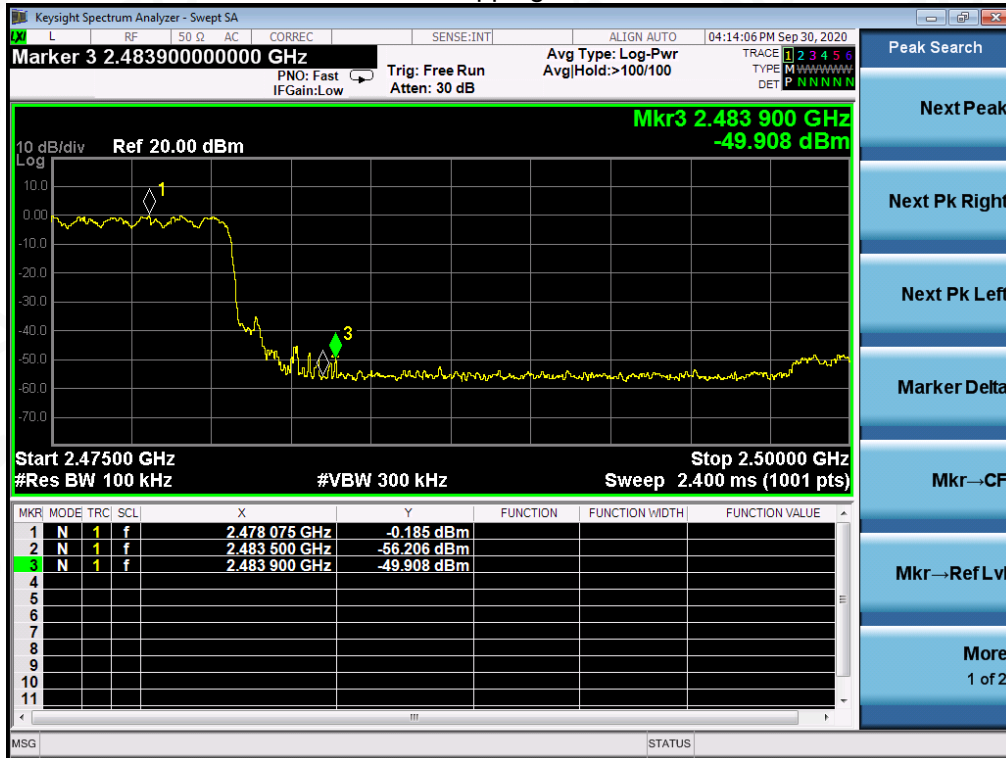

Any report having not been signed by authorized approver, or having been altered without authorization, or having not been stamped by the "Dedicated Testing/Inspection Stamp" is deemed to be invalid. Copying or excerpting portion of, or altering the content of the report is not permitted without the written authorization of AGC. The test results presented in the report apply only to the tested sample. Any objections to report issued by AGC should be submitted to AGC within 15 days after the issuance of the test report. Further enquiry of validity or verification of the test report should be addressed to AGC by agc@agc-cert.com.

Attestation of Global Compliance(Shenzhen)Co., Ltd
Attestation of Global Compliance(Shenzhen)Std & Tech Co., Ltd
Tel: +86-755 2523 4088 E-mail: agc@agc-cert.com Web: http://cn.agc-cert.com/



8-DPSK MODULATION IN LOW CHANNEL Hopping off

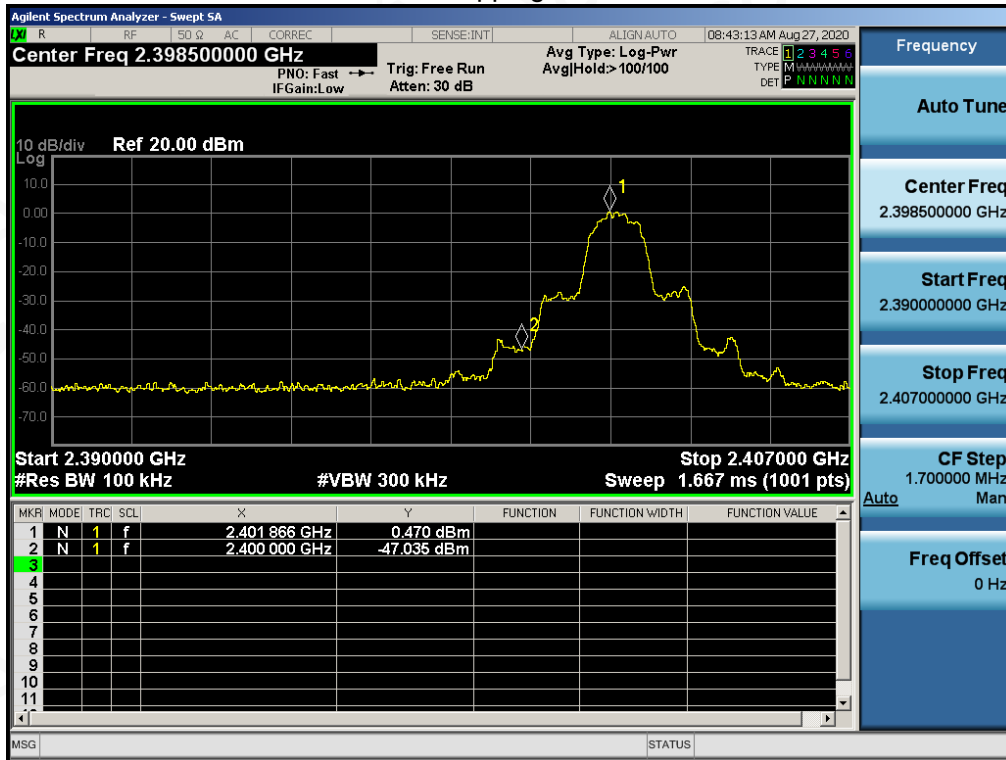

Hopping on

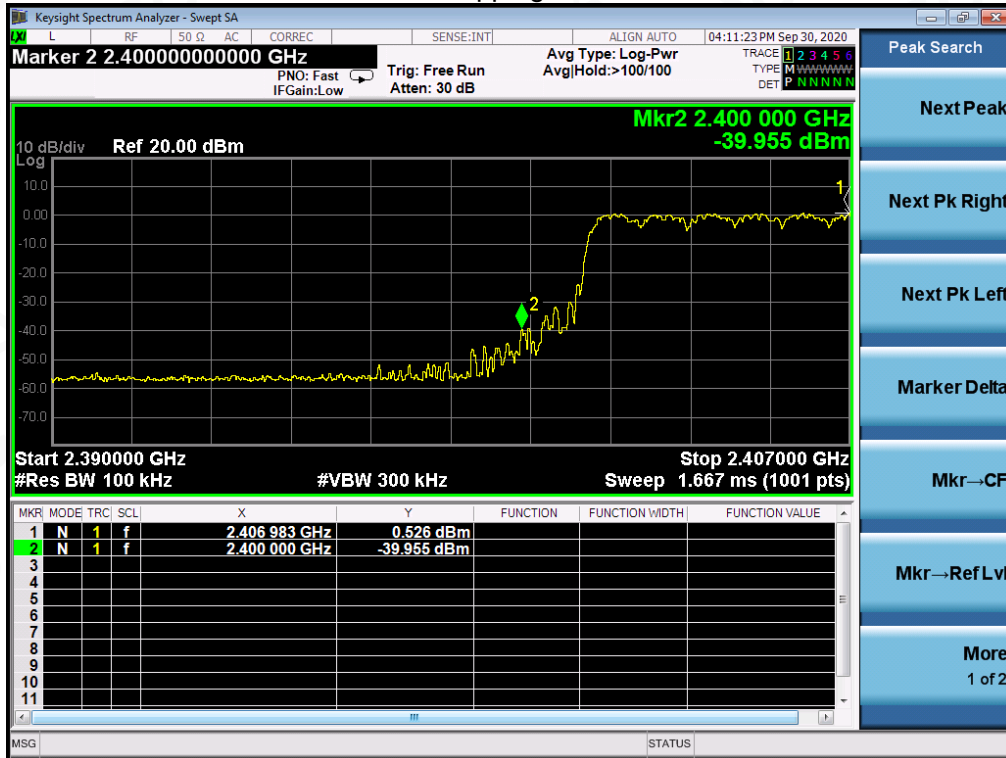

Any report having not been signed by authorized approver, or having been altered without authorization, or having not been stamped by the "Dedicated Testing/Inspection Stamp" is deemed to be invalid. Copying or excerpting portion of, or altering the content of the report is not permitted without the written authorization of AGC. The test results presented in the report apply only to the tested sample. Any objections to report issued by AGC should be submitted to AGC within 15 days after the issuance of the test report. Further enquiry of validity or verification of the test report should be addressed to AGC by agc@agc-cert.com.

Attestation of Global Compliance(Shenzhen)Co., Ltd
Attestation of Global Compliance(Shenzhen)Std & Tech Co., Ltd
Tel: +86-755 2523 4088 E-mail: agc@agc-cert.com Web: http://cn.agc-cert.com/



8-DPSK MODULATION IN HIGH CHANNEL Hopping off

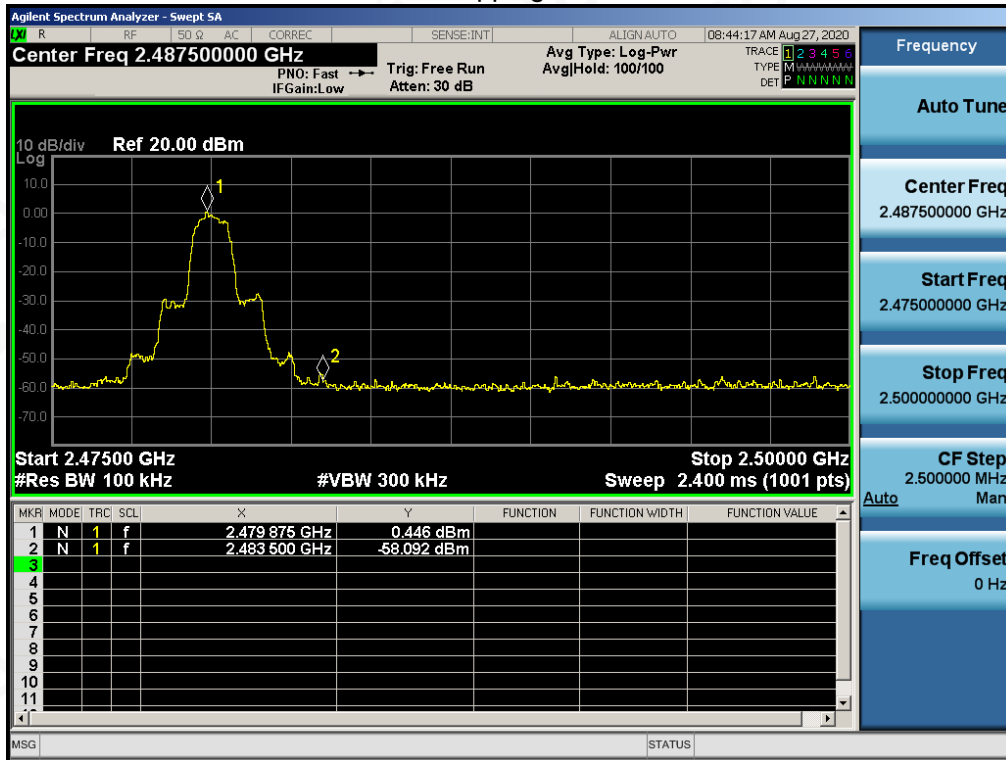

Hopping on

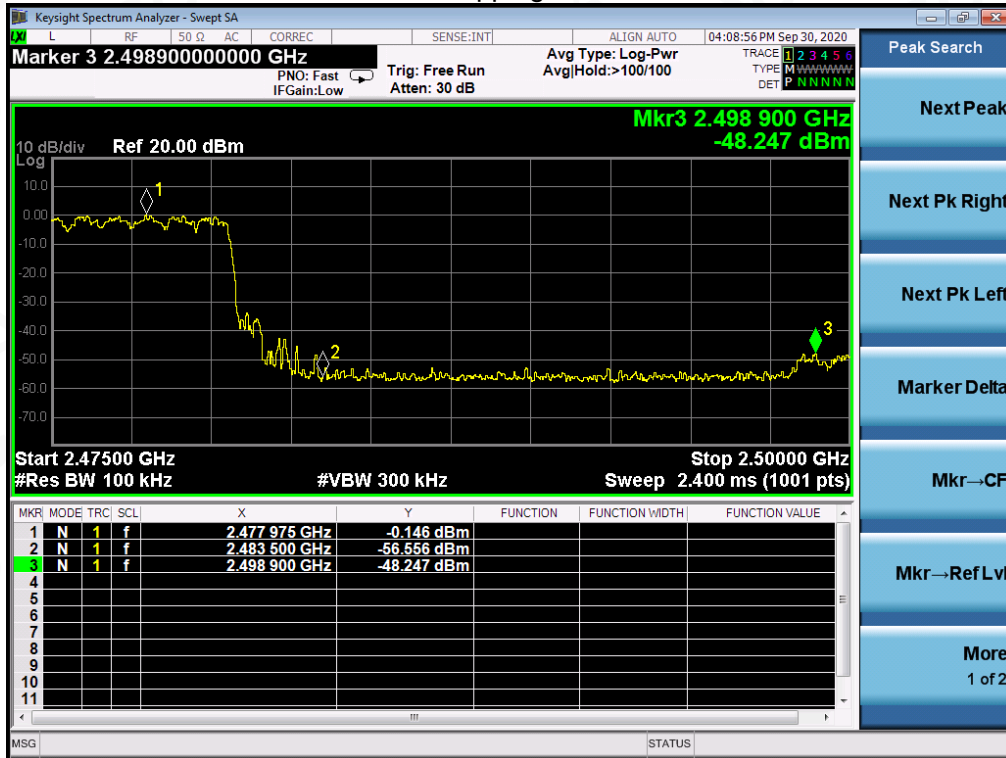

Any report having not been signed by authorized approver, or having been altered without authorization, or having not been stamped by the "Dedicated Testing/Inspection Stamp" is deemed to be invalid. Copying or excerpting portion of, or altering the content of the report is not permitted without the written authorization of AGC. The test results presented in the report apply only to the tested sample. Any objections to report issued by AGC should be submitted to AGC within 15 days after the issuance of the test report. Further enquiry of validity or verification of the test report should be addressed to AGC by agc@agc-cert.com.

Attestation of Global Compliance(Shenzhen)Co., Ltd
Attestation of Global Compliance(Shenzhen)Std & Tech Co., Ltd
Tel: +86-755 2523 4088 E-mail: agc@agc-cert.com Web: http://cn.agc-cert.com/



10. RADIATED EMISSION

10.1. MEASUREMENT PROCEDURE

1. The EUT was placed on the top of the turntable 0.8 or 1.5 meter above ground. The phase center of the receiving antenna mounted on the top of a height-variable antenna tower was placed 3 meters far away from the turntable.
2. Power on the EUT and all the supporting units. The turntable was rotated by 360 degrees to determine the position of the highest radiation.
3. The height of the broadband receiving antenna was varied between one meter and four meters above ground to find the maximum emissions field strength of both horizontal and vertical polarization.
4. For each suspected emission, the antenna tower was scan (from 1 M to 4 M) and then the turntable was rotated (from 0 degree to 360 degrees) to find the maximum reading.
5. Set the test-receiver system to Peak or CISPR quasi-peak Detect Function with specified bandwidth under Maximum Hold Mode.
6. For emissions above 1GHz, use 1MHz RBW and 3MHz VBW for peak reading. Place the measurement antenna away from each area of the EUT determined to be a source of emissions at the specified measurement distance, while keeping the measurement antenna aimed at the source of emissions at each frequency of significant emissions, with polarization oriented for maximum response. The measurement antenna may have to be higher or lower than the EUT, depending on the radiation pattern of the emission and staying aimed at the emission source for receiving the maximum signal. The final measurement antenna elevation shall be that which maximizes the emissions. The measurement antenna elevation for maximum emissions shall be restricted to a range of heights of from 1 m to 4 m above the ground or reference ground plane.
7. When the radiated emissions limits are expressed in terms of the average value of the emissions, and pulsed operation is employed, the measurement field strength shall be determined by averaging over one complete pulse train, including blanking intervals, as long as the pulse train does not exceed 0.1 seconds. As an alternative (provided the transmitter operates for longer than 0.1 seconds) or in cases where the pulse train exceeds 0.1 seconds, the measured field strength shall be determined from the average absolute voltage during a 0.1 second interval during which the field strength is at its maximum values.
8. If the emissions level of the EUT in peak mode was 3 dB lower than the average limit specified, then testing will be stopped and peak values of EUT will be reported, otherwise, the emissions which do not have 3 dB margin will be repeated one by one using the quasi-peak method for below 1GHz.
9. For testing above 1GHz, the emissions level of the EUT in peak mode was lower than average limit (that means the emissions level in peak mode also complies with the limit in average mode), then testing will be stopped and peak values of EUT will be reported, otherwise, the emissions will be measured in average mode again and reported.
10. In case the emission is lower than 30MHz, loop antenna has to be used for measurement and the recorded data should be QP measured by receiver. High - Low scan is not required in this case.

Any report having not been signed by authorized approver, or having been altered without authorization, or having not been stamped by the "Dedicated Testing/Inspection Stamp" is deemed to be invalid. Copying or excerpting portion of, or altering the content of the report is not permitted without the written authorization of AGC. The test results presented in the report apply only to the tested sample. Any objections to report issued by AGC should be submitted to AGC within 15 days after the issuance of the test report. Further enquiry of validity or verification of the test report should be addressed to AGC by agc@agc-cert.com.



The following table is the setting of spectrum analyzer and receiver.

| Spectrum Parameter | Setting |
|-----------------------|---|
| Start ~Stop Frequency | 9KHz~150KHz/RB 200Hz for QP |
| Start ~Stop Frequency | 150KHz~30MHz/RB 9KHz for QP |
| Start ~Stop Frequency | 30MHz~1000MHz/RB 120KHz for QP |
| Start ~Stop Frequency | 1GHz~26.5GHz 1MHz/3MHz for Peak, 1MHz/3MHz for Average |

| Receiver Parameter | Setting |
|-----------------------|--------------------------------|
| Start ~Stop Frequency | 9KHz~150KHz/RB 200Hz for QP |
| Start ~Stop Frequency | 150KHz~30MHz/RB 9KHz for QP |
| Start ~Stop Frequency | 30MHz~1000MHz/RB 120KHz for QP |

Any report having not been signed by authorized approver, or having been altered without authorization, or having not been stamped by the "Dedicated Testing/Inspection Stamp" is deemed to be invalid. Copying or excerpting portion of, or altering the content of the report is not permitted without the written authorization of AGC. The test results presented in the report apply only to the tested sample. Any objections to report issued by AGC should be submitted to AGC within 15days after the issuance of the test report. Further enquiry of validity or verification of the test report should be addressed to AGC by agc@agc-cert.com.



10.2. TEST SETUP

Radiated Emission Test-Setup Frequency Below 30MHz

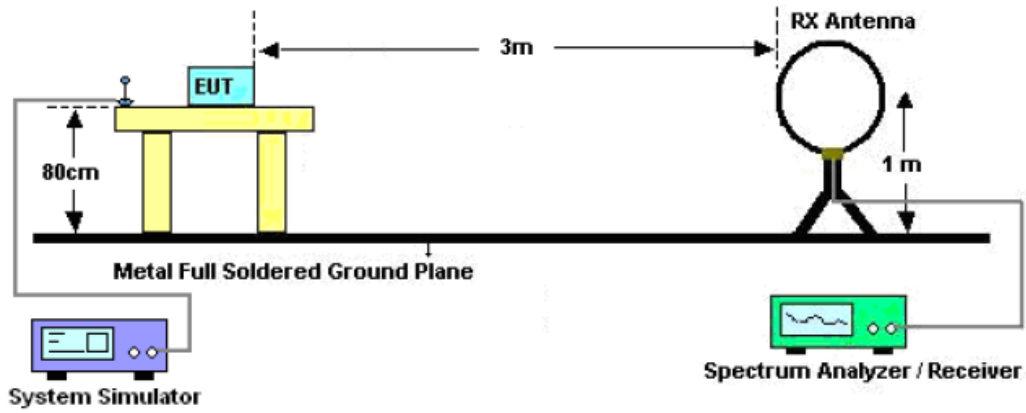

RADIATED EMISSION TEST SETUP 30MHz-1000MHz

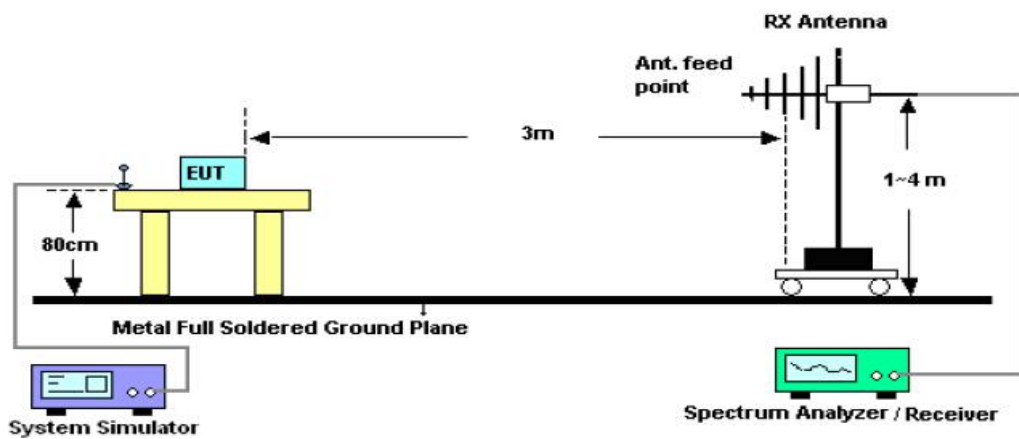

RADIATED EMISSION TEST SETUP ABOVE 1000MHz

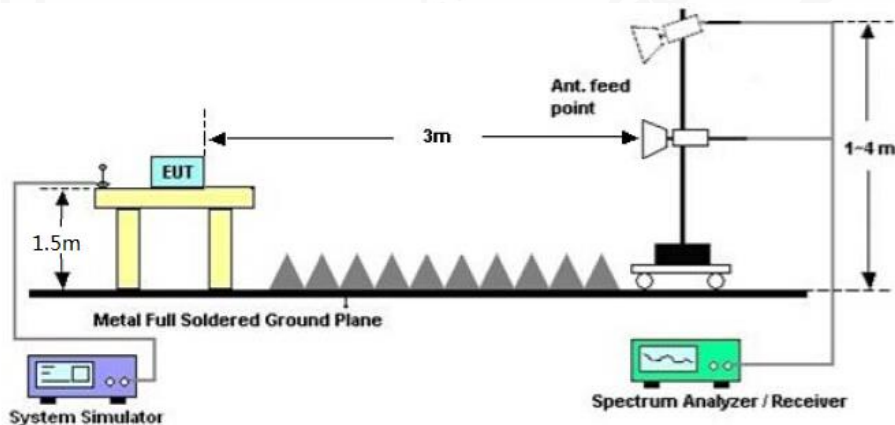

Any report having not been signed by authorized approver, or having been altered without authorization, or having not been stamped by the "Dedicated Testing/Inspection Stamp" is deemed to be invalid. Copying or excerpting portion of, or altering the content of the report is not permitted without the written authorization of AGC. The test results presented in the report apply only to the tested sample. Any objections to report issued by AGC should be submitted to AGC within 15 days after the issuance of the test report. Further enquiry of validity or verification of the test report should be addressed to AGC by agc@agc-cert.com.



10.3. LIMITS AND MEASUREMENT RESULT

15.209 Limit in the below table has to be followed

| Frequencies (MHz) | Field Strength (microvolts/meter) | Measurement Distance (meters) |
|-------------------|-----------------------------------|-------------------------------|
| 0.009~0.490 | 2400/F(kHz) | 300 |
| 0.490~1.705 | 24000/F(kHz) | 30 |
| 1.705~30.0 | 30 | 30 |
| 30~88 | 100 | 3 |
| 88~216 | 150 | 3 |
| 216~960 | 200 | 3 |
| Above 960 | 500 | 3 |

Note: All modes were tested for restricted band radiated emission, the test records reported below are the worst result compared to other modes.

10.4. TEST RESULT

RADIATED EMISSION BELOW 30MHz

The amplitude of spurious emissions from 9kHz to 30MHz which are attenuated more than 20 dB below the permissible value need not be reported.

Any report having not been signed by authorized approver, or having been altered without authorization, or having not been stamped by the "Dedicated Testing/Inspection Stamp" is deemed to be invalid. Copying or excerpting portion of, or altering the content of the report is not permitted without the written authorization of AGC. The test results presented in the report apply only to the tested sample. Any objections to report issued by AGC should be submitted to AGC within 15days after the issuance of the test report. Further enquiry of validity or verification of the test report should be addressed to AGC by agc@agc-cert.com.

Attestation of Global Compliance(Shenzhen)Co., Ltd
Attestation of Global Compliance(Shenzhen)Std & Tech Co., Ltd
Tel: +86-755 2523 4088 E-mail: agc@agc-cert.com Web: http://cn.agc-cert.com/



RADIATED EMISSION BELOW 1GHz

| | | | |
|--------------------|-----------------------|--------------------------|----------------|
| EUT | TWS Bluetooth Headset | Model Name | TB200 |
| Temperature | 25°C | Relative Humidity | 55.4% |
| Pressure | 960hPa | Test Voltage | Normal Voltage |
| Test Mode | Mode 7 | Antenna | Horizontal |

66.9 dBuV/m

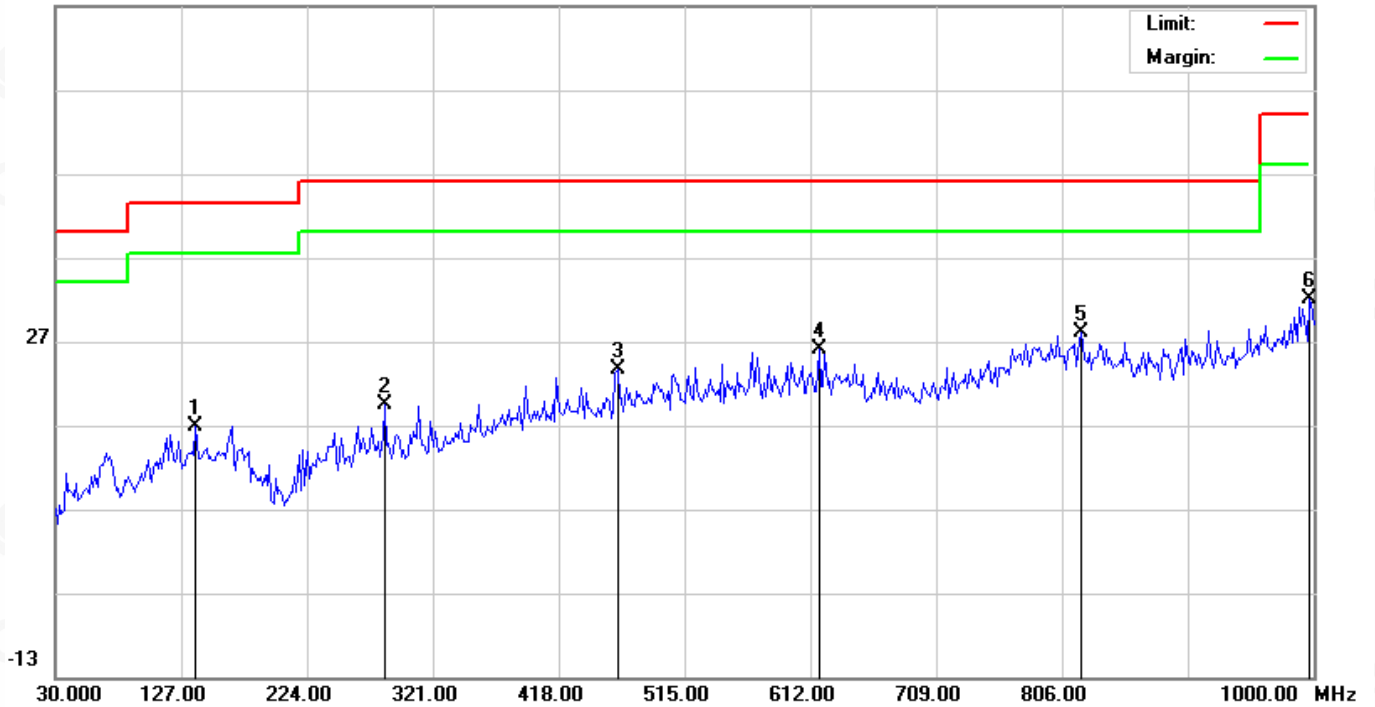

| No. | Mk. | Freq. MHz | Reading Level dBuV | Correct Factor dB | Measure- ment dBuV/m | Limit dBuV/m | Over dB | Detector |
|-----|-----|--------------|--------------------------|-------------------------|----------------------------|-----------------|------------|----------|
| 1 | | 138.3167 | -2.34 | 19.12 | 16.78 | 43.50 | -26.72 | peak |
| 2 | | 283.8167 | -0.47 | 19.85 | 19.38 | 46.00 | -26.62 | peak |
| 3 | | 463.2667 | -0.64 | 24.25 | 23.61 | 46.00 | -22.39 | peak |
| 4 | | 618.4667 | -0.61 | 26.62 | 26.01 | 46.00 | -19.99 | peak |
| 5 | * | 820.5500 | -1.87 | 29.85 | 27.98 | 46.00 | -18.02 | peak |
| 6 | | 996.7667 | -0.42 | 32.40 | 31.98 | 54.00 | -22.02 | peak |

RESULT: PASS

Any report having not been signed by authorized approver, or having been altered without authorization, or having not been stamped by the "Dedicated Testing/Inspection Stamp" is deemed to be invalid. Copying or excerpting portion of, or altering the content of the report is not permitted without the written authorization of AGC. The test results presented in the report apply only to the tested sample. Any objections to report issued by AGC should be submitted to AGC within 15 days after the issuance of the test report. Further enquiry of validity or verification of the test report should be addressed to AGC by agc@agc-cert.com.

Attestation of Global Compliance(Shenzhen)Co., Ltd
Attestation of Global Compliance(Shenzhen)Std & Tech Co., Ltd
Tel: +86-755 2523 4088 E-mail: agc@agc-cert.com Web: http://cn.agc-cert.com/



| | | | |
|-------------|-----------------------|-------------------|----------------|
| EUT | TWS Bluetooth Headset | Model Name | TB200 |
| Temperature | 25°C | Relative Humidity | 55.4% |
| Pressure | 960hPa | Test Voltage | Normal Voltage |
| Test Mode | Mode 7 | Antenna | Vertical |

66.9 dBuV/m

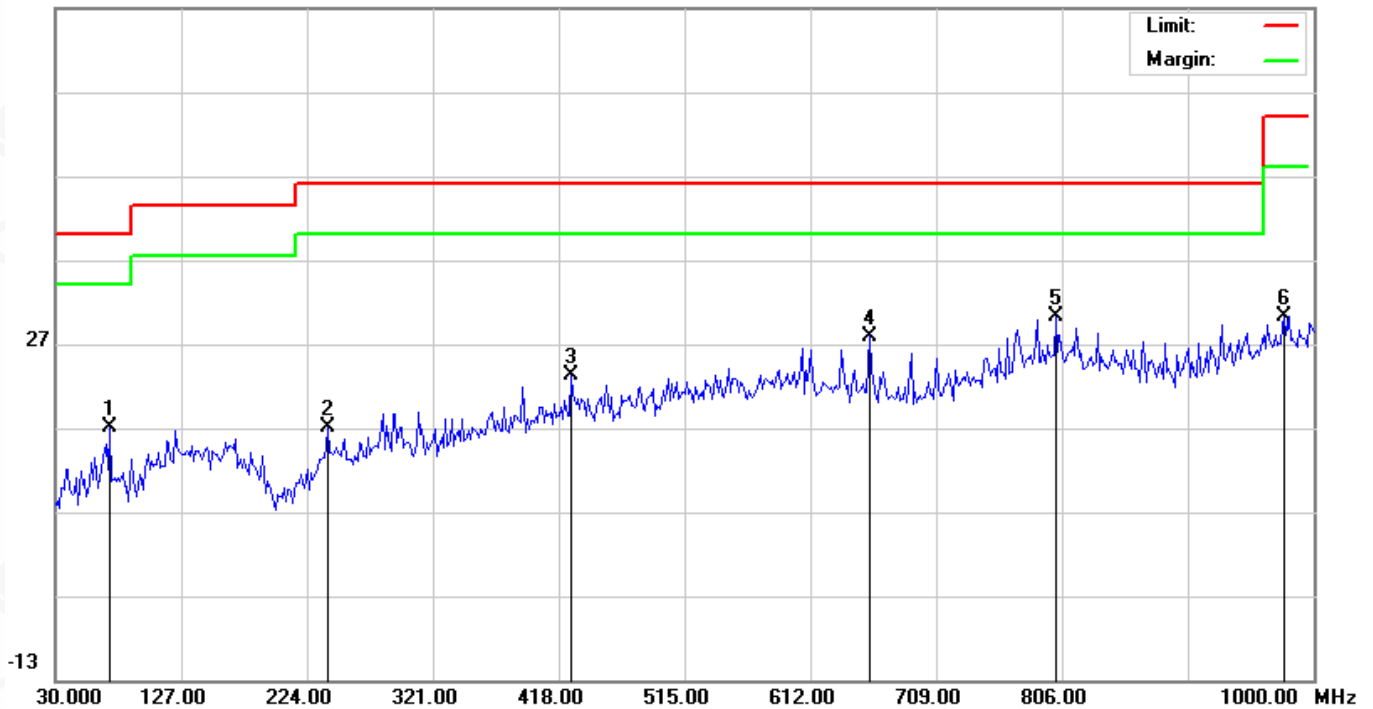

| No. | Mk. | Freq. MHz | Reading Level dBuV | Correct Factor dB | Measure- ment dBuV/m | Limit dBuV/m | Over dB | Detector |
|-----|-----|--------------|--------------------------|-------------------------|----------------------------|-----------------|------------|----------|
| 1 | | 72.0333 | 0.42 | 16.67 | 17.09 | 40.00 | -22.91 | peak |
| 2 | | 240.1667 | -1.66 | 18.66 | 17.00 | 46.00 | -29.00 | peak |
| 3 | | 427.7000 | -0.43 | 23.54 | 23.11 | 46.00 | -22.89 | peak |
| 4 | | 657.2667 | 1.98 | 25.92 | 27.90 | 46.00 | -18.10 | peak |
| 5 | * | 801.1500 | -0.22 | 30.38 | 30.16 | 46.00 | -15.84 | peak |
| 6 | | 977.3667 | -1.28 | 31.46 | 30.18 | 54.00 | -23.82 | peak |

RESULT: PASS

Note: 1. Factor=Antenna Factor + Cable loss, Margin=Measurement-Limit.

2. All test modes had been pre-tested. The mode 7 is the worst case and recorded in the report.

Any report having not been signed by authorized approver, or having been altered without authorization, or having not been stamped by the "Dedicated Testing/Inspection Stamp" is deemed to be invalid. Copying or excerpting portion of, or altering the content of the report is not permitted without the written authorization of AGC. The test results presented in the report apply only to the tested sample. Any objections to report issued by AGC should be submitted to AGC within 15days after the issuance of the test report. Further enquiry of validity or verification of the test report should be addressed to AGC by agc@agc-cert.com.

Attestation of Global Compliance(Shenzhen)Co., Ltd
Attestation of Global Compliance(Shenzhen)Std & Tech Co., Ltd
Tel: +86-755 2523 4088 E-mail: agc@agc-cert.com Web: http://cn.agc-cert.com/



RADIATED EMISSION ABOVE 1GHz

| | | | |
|--------------------|-----------------------|--------------------------|----------------|
| EUT | TWS Bluetooth Headset | Model Name | TB200 |
| Temperature | 25°C | Relative Humidity | 55.4% |
| Pressure | 960hPa | Test Voltage | Normal Voltage |
| Test Mode | Mode 7 | Antenna | Horizontal |

| Frequency (MHz) | Meter Reading (dBμV) | Factor (dB) | Emission Level (dBμV/m) | Limits (dBμV/m) | Margin (dB) | Value Type |
|--------------------|-------------------------|----------------|----------------------------|--------------------|----------------|------------|
| 4804.000 | 44.88 | 0.08 | 44.96 | 74 | -29.04 | peak |
| 4804.000 | 37.11 | 0.08 | 37.19 | 54 | -16.81 | AVG |
| 7206.000 | 41.23 | 2.21 | 43.44 | 74 | -30.56 | peak |
| 7206.000 | 34.12 | 2.21 | 36.33 | 54 | -17.67 | AVG |
| | | | | | | |
| | | | | | | |

Remark:
Factor = Antenna Factor + Cable Loss – Pre-amplifier.

| | | | |
|--------------------|-----------------------|--------------------------|----------------|
| EUT | TWS Bluetooth Headset | Model Name | TB200 |
| Temperature | 25°C | Relative Humidity | 55.4% |
| Pressure | 960hPa | Test Voltage | Normal Voltage |
| Test Mode | Mode 7 | Antenna | Vertical |

| Frequency (MHz) | Meter Reading (dBμV) | Factor (dB) | Emission Level (dBμV/m) | Limits (dBμV/m) | Margin (dB) | Value Type |
|--------------------|-------------------------|----------------|----------------------------|--------------------|----------------|------------|
| 4804.000 | 44.12 | 0.08 | 44.2 | 74 | -29.8 | peak |
| 4804.000 | 36.98 | 0.08 | 37.06 | 54 | -16.94 | AVG |
| 7206.000 | 38.13 | 2.21 | 40.34 | 74 | -33.66 | peak |
| 7206.000 | 34.25 | 2.21 | 36.46 | 54 | -17.54 | AVG |
| | | | | | | |
| | | | | | | |

Remark:
Factor = Antenna Factor + Cable Loss – Pre-amplifier.

Any report having not been signed by authorized approver, or having been altered without authorization, or having not been stamped by the "Dedicated Testing/Inspection Stamp" is deemed to be invalid. Copying or excerpting portion of, or altering the content of the report is not permitted without the written authorization of AGC. The test results presented in the report apply only to the tested sample. Any objections to report issued by AGC should be submitted to AGC within 15days after the issuance of the test report. Further enquiry of validity or verification of the test report should be addressed to AGC by agc@agc-cert.com.



| | | | |
|--------------------|-----------------------|--------------------------|----------------|
| EUT | TWS Bluetooth Headset | Model Name | TB200 |
| Temperature | 25°C | Relative Humidity | 55.4% |
| Pressure | 960hPa | Test Voltage | Normal Voltage |
| Test Mode | Mode 8 | Antenna | Horizontal |

| Frequency (MHz) | Meter Reading (dBμV) | Factor (dB) | Emission Level (dBμV/m) | Limits (dBμV/m) | Margin (dB) | Value Type |
|--------------------|-------------------------|----------------|----------------------------|--------------------|----------------|------------|
| 4882.000 | 45.98 | 0.14 | 46.12 | 74 | -27.88 | peak |
| 4882.000 | 39.25 | 0.14 | 39.39 | 54 | -14.61 | AVG |
| 7323.000 | 42.14 | 2.36 | 44.5 | 74 | -29.5 | peak |
| 7323.000 | 34.06 | 2.36 | 36.42 | 54 | -17.58 | AVG |
| | | | | | | |
| | | | | | | |

Remark:
Factor = Antenna Factor + Cable Loss – Pre-amplifier.

| | | | |
|--------------------|-----------------------|--------------------------|----------------|
| EUT | TWS Bluetooth Headset | Model Name | TB200 |
| Temperature | 25°C | Relative Humidity | 55.4% |
| Pressure | 960hPa | Test Voltage | Normal Voltage |
| Test Mode | Mode 8 | Antenna | Vertical |

| Frequency (MHz) | Meter Reading (dBμV) | Factor (dB) | Emission Level (dBμV/m) | Limits (dBμV/m) | Margin (dB) | Value Type |
|--------------------|-------------------------|----------------|----------------------------|--------------------|----------------|------------|
| 4882.000 | 45.15 | 0.14 | 45.29 | 74 | -28.71 | peak |
| 4882.000 | 36.13 | 0.14 | 36.27 | 54 | -17.73 | AVG |
| 7323.000 | 40.98 | 2.36 | 43.34 | 74 | -30.66 | peak |
| 7323.000 | 32.13 | 2.36 | 34.49 | 54 | -19.51 | AVG |
| | | | | | | |
| | | | | | | |

Remark:
Factor = Antenna Factor + Cable Loss – Pre-amplifier.

Any report having not been signed by authorized approver, or having been altered without authorization, or having not been stamped by the "Dedicated Testing/Inspection Stamp" is deemed to be invalid. Copying or excerpting portion of, or altering the content of the report is not permitted without the written authorization of AGC. The test results presented in the report apply only to the tested sample. Any objections to report issued by AGC should be submitted to AGC within 15days after the issuance of the test report. Further enquiry of validity or verification of the test report should be addressed to AGC by agc@agc-cert.com.



| | | | |
|--------------------|-----------------------|--------------------------|----------------|
| EUT | TWS Bluetooth Headset | Model Name | TB200 |
| Temperature | 25°C | Relative Humidity | 55.4% |
| Pressure | 960hPa | Test Voltage | Normal Voltage |
| Test Mode | Mode 9 | Antenna | Horizontal |

| Frequency (MHz) | Meter Reading (dBμV) | Factor (dB) | Emission Level (dBμV/m) | Limits (dBμV/m) | Margin (dB) | Value Type |
|--------------------|-------------------------|----------------|----------------------------|--------------------|----------------|------------|
| 4960.000 | 46.93 | 0.22 | 47.15 | 74 | -26.85 | peak |
| 4960.000 | 38.86 | 0.22 | 39.08 | 54 | -14.92 | AVG |
| 7440.000 | 41.97 | 2.64 | 44.61 | 74 | -29.39 | peak |
| 7440.000 | 31.76 | 2.64 | 34.4 | 54 | -19.6 | AVG |
| | | | | | | |
| | | | | | | |

Remark:
Factor = Antenna Factor + Cable Loss – Pre-amplifier.

| | | | |
|--------------------|-----------------------|--------------------------|----------------|
| EUT | TWS Bluetooth Headset | Model Name | TB200 |
| Temperature | 25°C | Relative Humidity | 55.4% |
| Pressure | 960hPa | Test Voltage | Normal Voltage |
| Test Mode | Mode 9 | Antenna | Vertical |

| Frequency (MHz) | Meter Reading (dBμV) | Factor (dB) | Emission Level (dBμV/m) | Limits (dBμV/m) | Margin (dB) | Value Type |
|--------------------|-------------------------|----------------|----------------------------|--------------------|----------------|------------|
| 4960.000 | 45.63 | 0.22 | 45.85 | 74 | -28.15 | peak |
| 4960.000 | 38.99 | 0.22 | 39.21 | 54 | -14.79 | AVG |
| 7440.000 | 41.89 | 2.64 | 44.53 | 74 | -29.47 | peak |
| 7440.000 | 32.56 | 2.64 | 35.2 | 54 | -18.8 | AVG |
| | | | | | | |
| | | | | | | |

Remark:
Factor = Antenna Factor + Cable Loss – Pre-amplifier.

RESULT: PASS

Note:

The amplitude of other spurious emissions from 1G to 25 GHz which are attenuated more than 20 dB below the permissible value need not be reported.

Factor = Antenna Factor + Cable loss - Amplifier gain, Over=Limit-Measure.

The “Factor” value can be calculated automatically by software of measurement system.

All test modes had been tested. The 8DPK modulation is the worst case and recorded in the report.

Any report having not been signed by authorized approver, or having been altered without authorization, or having not been stamped by the “Dedicated Testing/Inspection Stamp” is deemed to be invalid. Copying or excerpting portion of, or altering the content of the report is not permitted without the written authorization of AGC. The test results presented in the report apply only to the tested sample. Any objections to report issued by AGC should be submitted to AGC within 15days after the issuance of the test report. Further enquiry of validity or verification of the test report should be addressed to AGC by agc@agc-cert.com.



TEST RESULT FOR RESTRICTED BANDS REQUIREMENTS

| | | | |
|--------------------|-----------------------|--------------------------|----------------|
| EUT | TWS Bluetooth Headset | Model Name | TB200 |
| Temperature | 25°C | Relative Humidity | 55.4% |
| Pressure | 960hPa | Test Voltage | Normal Voltage |
| Test Mode | Mode 7 | Antenna | Horizontal |

PK

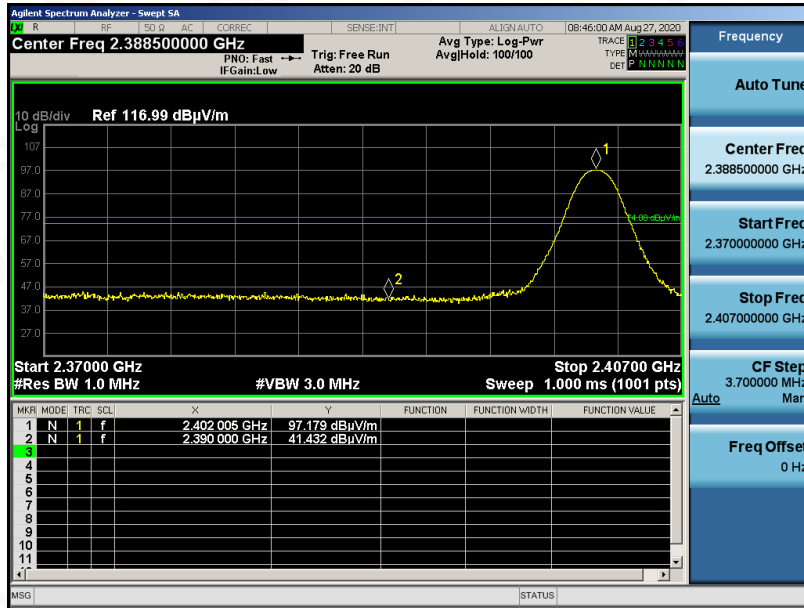

AV

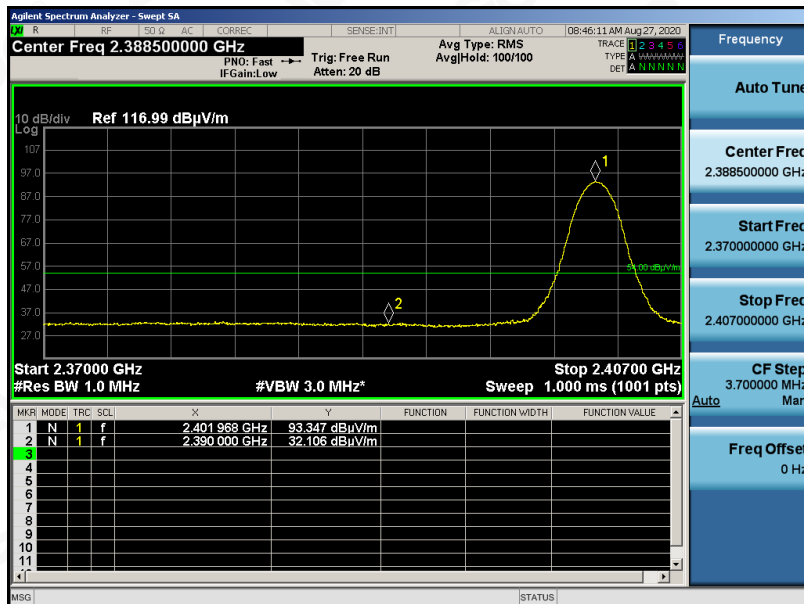

RESULT: PASS

Any report having not been signed by authorized approver, or having been altered without authorization, or having not been stamped by the "Dedicated Testing/Inspection Stamp" is deemed to be invalid. Copying or excerpting portion of, or altering the content of the report is not permitted without the written authorization of AGC. The test results presented in the report apply only to the tested sample. Any objections to report issued by AGC should be submitted to AGC within 15 days after the issuance of the test report. Further enquiry of validity or verification of the test report should be addressed to AGC by agc@agc-cert.com.

Attestation of Global Compliance(Shenzhen)Co., Ltd
Attestation of Global Compliance(Shenzhen)Std & Tech Co., Ltd
Tel: +86-755 2523 4088 E-mail: agc@agc-cert.com Web: http://cn.agc-cert.com/



| | | | |
|-------------|-----------------------|-------------------|----------------|
| EUT | TWS Bluetooth Headset | Model Name | TB200 |
| Temperature | 25°C | Relative Humidity | 55.4% |
| Pressure | 960hPa | Test Voltage | Normal Voltage |
| Test Mode | Mode 7 | Antenna | Vertical |

PK

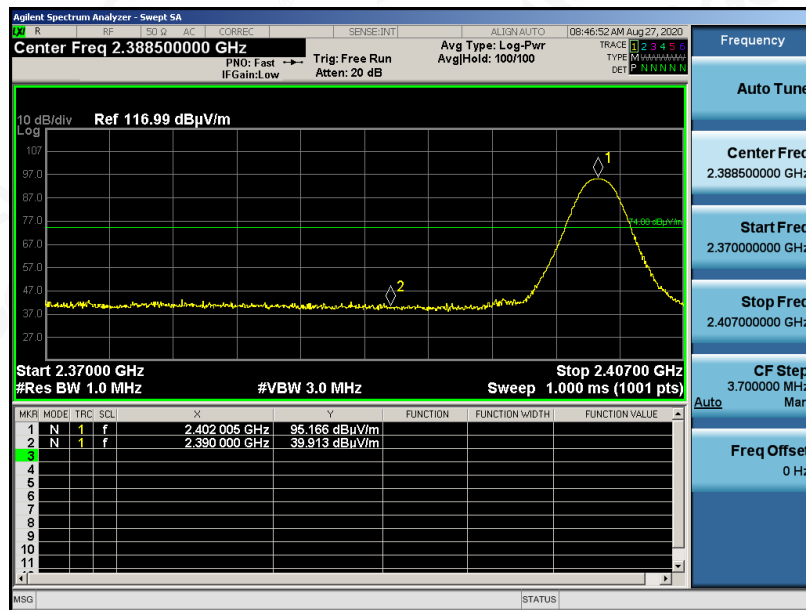

AV

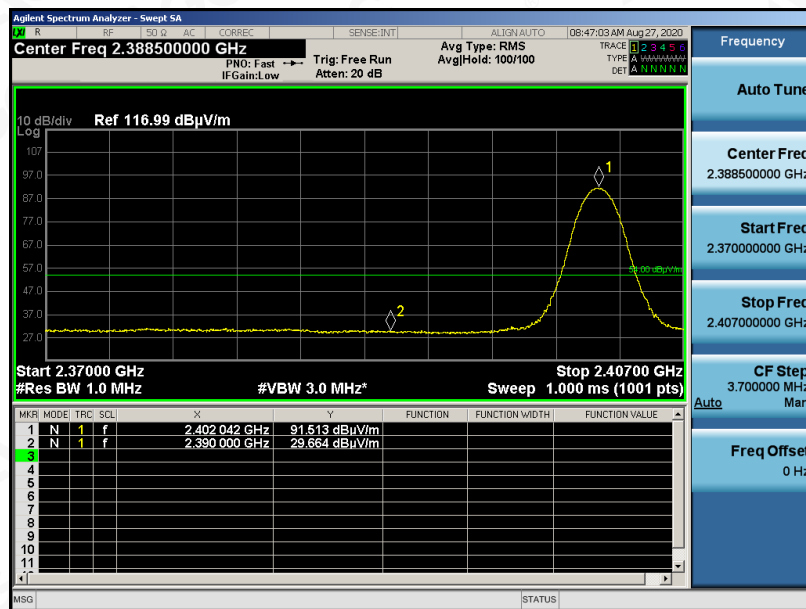

RESULT: PASS

Any report having not been signed by authorized approver, or having been altered without authorization, or having not been stamped by the "Dedicated Testing/Inspection Stamp" is deemed to be invalid. Copying or excerpting portion of, or altering the content of the report is not permitted without the written authorization of AGC. The test results presented in the report apply only to the tested sample. Any objections to report issued by AGC should be submitted to AGC within 15 days after the issuance of the test report. Further enquiry of validity or verification of the test report should be addressed to AGC by agc@agc-cert.com.

Attestation of Global Compliance(Shenzhen)Co., Ltd
Attestation of Global Compliance(Shenzhen)Std & Tech Co., Ltd
Tel: +86-755 2523 4088 E-mail: agc@agc-cert.com Web: http://cn.agc-cert.com/



| | | | |
|-------------|-----------------------|-------------------|----------------|
| EUT | TWS Bluetooth Headset | Model Name | TB200 |
| Temperature | 25°C | Relative Humidity | 55.4% |
| Pressure | 960hPa | Test Voltage | Normal Voltage |
| Test Mode | Mode 9 | Antenna | Horizontal |

PK

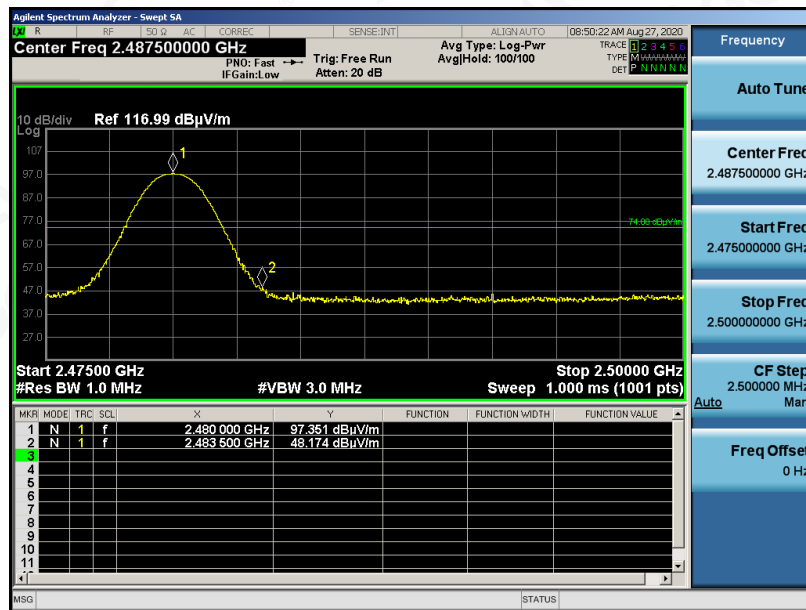

AV

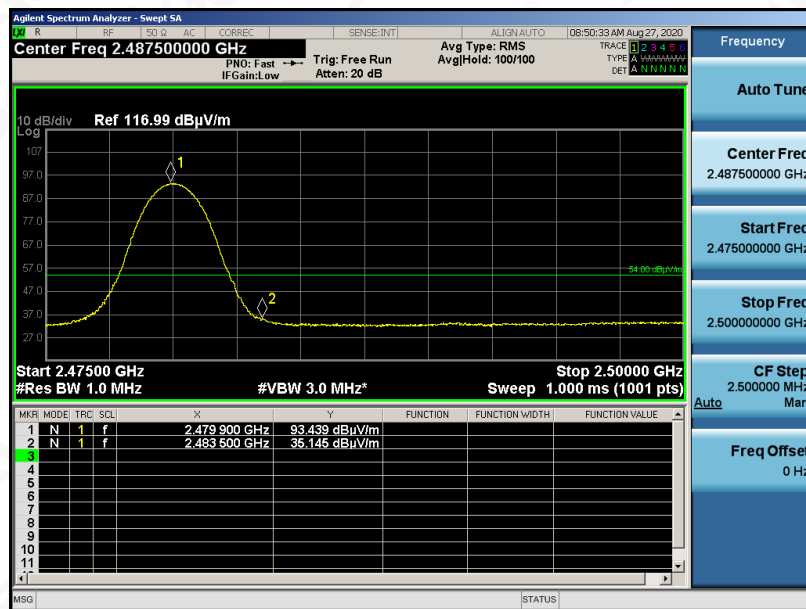

RESULT: PASS

Any report having not been signed by authorized approver, or having been altered without authorization, or having not been stamped by the "Dedicated Testing/Inspection Stamp" is deemed to be invalid. Copying or excerpting portion of, or altering the content of the report is not permitted without the written authorization of AGC. The test results presented in the report apply only to the tested sample. Any objections to report issued by AGC should be submitted to AGC within 15days after the issuance of the test report. Further enquiry of validity or verification of the test report should be addressed to AGC by agc@agc-cert.com.

Attestation of Global Compliance(Shenzhen)Co., Ltd
Attestation of Global Compliance(Shenzhen)Std & Tech Co., Ltd
Tel: +86-755 2523 4088 E-mail: agc@agc-cert.com Web: http://cn.agc-cert.com/



| | | | |
|-------------|-----------------------|-------------------|----------------|
| EUT | TWS Bluetooth Headset | Model Name | TB200 |
| Temperature | 25°C | Relative Humidity | 55.4% |
| Pressure | 960hPa | Test Voltage | Normal Voltage |
| Test Mode | Mode 9 | Antenna | Vertical |

PK

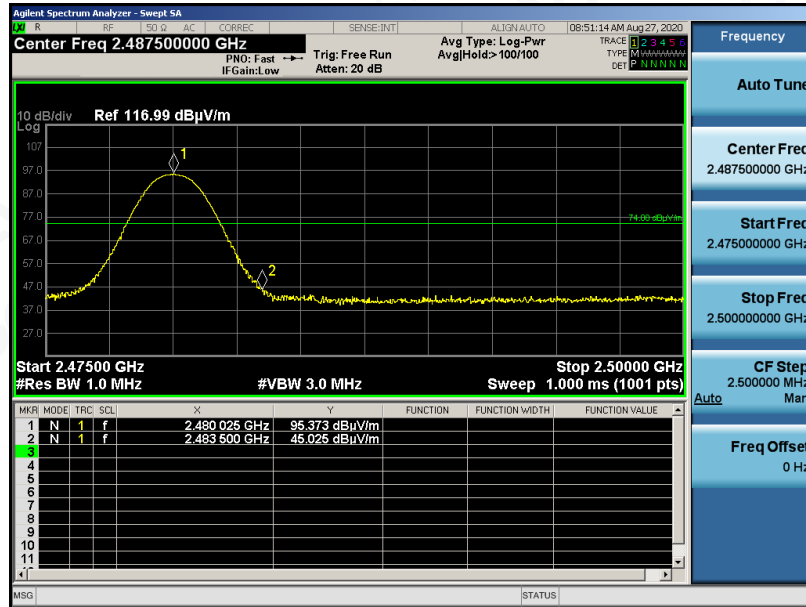

AV

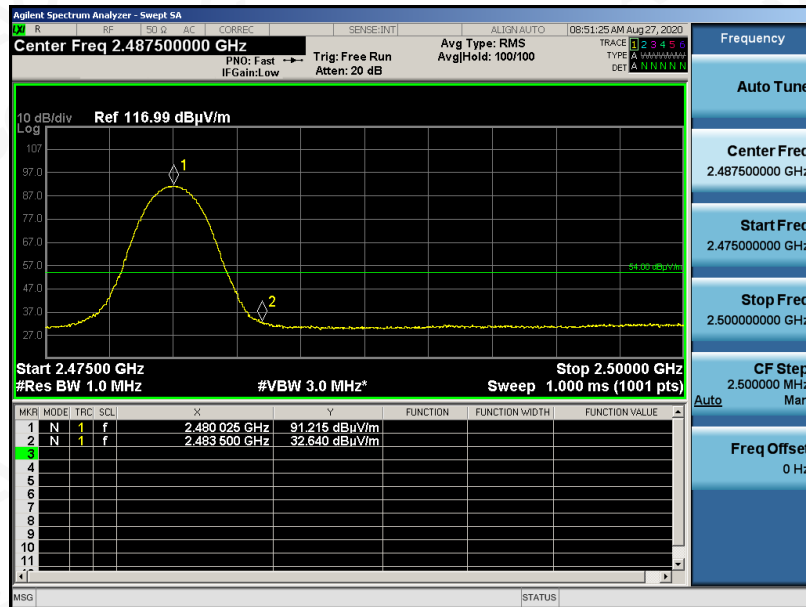

RESULT: PASS

Note: The factor had been edited in the “Input Correction” of the Spectrum Analyzer. The 8DPSK modulation is the worst case and recorded in the report.

Any report having not been signed by authorized approver, or having been altered without authorization, or having not been stamped by the “Dedicated Testing/Inspection Stamp” is deemed to be invalid. Copying or excerpting portion of, or altering the content of the report is not permitted without the written authorization of AGC. The test results presented in the report apply only to the tested sample. Any objections to report issued by AGC should be submitted to AGC within 15days after the issuance of the test report. Further enquiry of validity or verification of the test report should be addressed to AGC by agc@agc-cert.com.

Attestation of Global Compliance(Shenzhen)Co., Ltd
Attestation of Global Compliance(Shenzhen)Std & Tech Co., Ltd
Tel: +86-755 2523 4088 E-mail: agc@agc-cert.com Web: http://cn.agc-cert.com/



11. NUMBER OF HOPPING FREQUENCY

11.1. MEASUREMENT PROCEDURE

The EUT shall have its hopping function enabled. Use the following spectrum analyzer settings:

1. Span: The frequency band of operation. Depending on the number of channels the device supports, it may be necessary to divide the frequency range of operation across multiple spans, to allow the individual channels to be clearly seen.
2. RBW: To identify clearly the individual channels, set the RBW to less than 30% of the channel spacing or the 20 dB bandwidth, whichever is smaller.
3. VBW \geq RBW. Sweep: Auto. Detector function: Peak. Trace: Max hold.
4. Allow the trace to stabilize.

11.2. TEST SETUP (BLOCK DIAGRAM OF CONFIGURATION)

Same as described in section 8.2

11.3. MEASUREMENT EQUIPMENT USED

The same as described in section 6

11.4. LIMITS AND MEASUREMENT RESULT

| TOTAL NO. OF HOPPING CHANNEL | LIMIT (NO. OF CH) | MEASUREMENT (NO. OF CH) | RESULT |
|------------------------------|-------------------|-------------------------|--------|
| | ≥ 15 | 79 | PASS |

TEST PLOT FOR NO. OF TOTAL CHANNELS

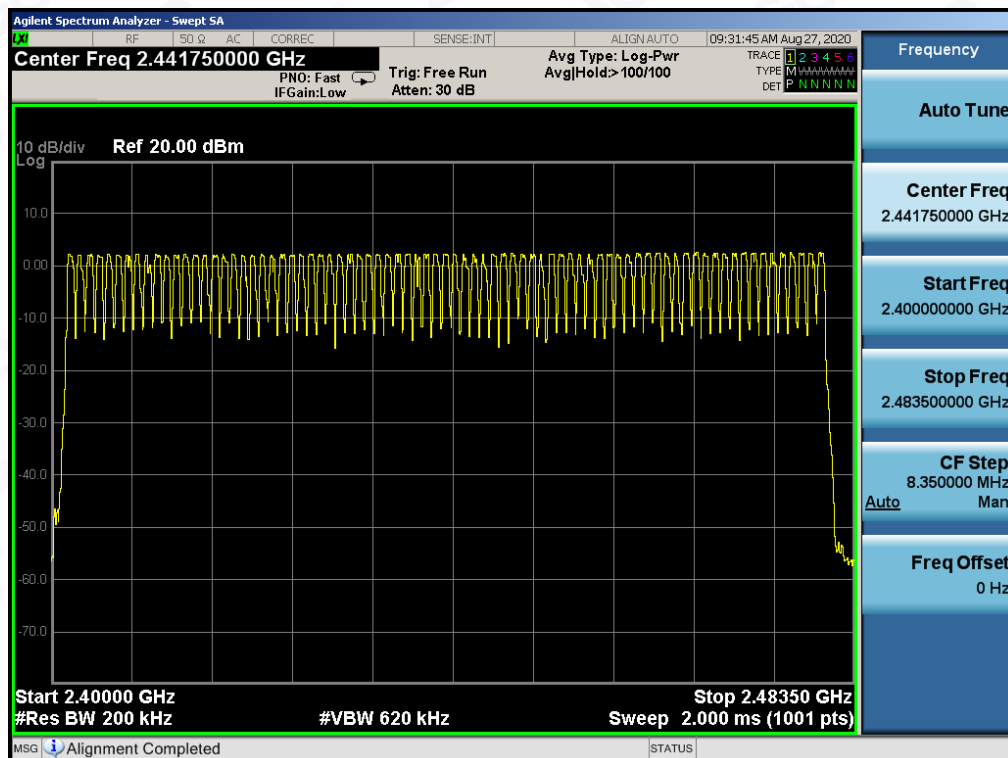

Note: The GFSK modulation is the worst case and recorded in the report.

Any report having not been signed by authorized approver, or having been altered without authorization, or having not been stamped by the "Dedicated Testing/Inspection Stamp" is deemed to be invalid. Copying or excerpting portion of, or altering the content of the report is not permitted without the written authorization of AGC. The test results presented in the report apply only to the tested sample. Any objections to report issued by AGC should be submitted to AGC within 15 days after the issuance of the test report. Further enquiry of validity or verification of the test report should be addressed to AGC by agc@agc-cert.com.

Attestation of Global Compliance(Shenzhen)Co., Ltd
Attestation of Global Compliance(Shenzhen)Std & Tech Co., Ltd
Tel: +86-755 2523 4088 E-mail: agc@agc-cert.com Web: http://cn.agc-cert.com/



12. TIME OF OCCUPANCY (DWELL TIME)

12.1. MEASUREMENT PROCEDURE

The EUT shall have its hopping function enabled. Use the following spectrum analyzer settings:

1. Span: Zero span, centered on a hopping channel.
2. RBW shall be \leq channel spacing and where possible RBW should be set $\gg 1/T$, where T is the expected dwell time per channel.
3. Sweep: As necessary to capture the entire dwell time per hopping channel; where possible use a video trigger and trigger delay so that the transmitted signal starts a little to the right of the start of the plot. The trigger level might need slight adjustment to prevent triggering when the system hops on an adjacent channel; a second plot might be needed with a longer sweep time to show two successive hops on a channel.
4. Detector function: Peak. Trace: Max hold.
5. Use the marker-delta function to determine the transmit time per hop.
6. Repeat the measurement using a longer sweep time to determine the number of hops over the period specified in the requirements. The sweep time shall be equal to, or less than, the period specified in the requirements. Determine the number of hops over the sweep time and calculate the total number of hops in the period specified in the requirements, using the following equation:

$$(\text{Number of hops in the period specified in the requirements}) = (\text{number of hops on spectrum analyzer}) \times (\text{period specified in the requirements} / \text{analyzer sweep time})$$

7. The average time of occupancy is calculated from the transmit time per hop multiplied by the number of hops in the period specified in the requirements.

12.2. TEST SETUP (BLOCK DIAGRAM OF CONFIGURATION)

Same as described in section 8.2

12.3. MEASUREMENT EQUIPMENT USED

The same as described in section 6

12.4. LIMITS AND MEASUREMENT RESULT

| Channel | Time of Pulse for DH5 (ms) | Number of hops in the period specified in the requirements | Sweep Time (ms) | Limit (ms) |
|---------|----------------------------|--|-----------------|------------|
| Low | 2.884 | 27*4 | 311.468 | 400 |
| Middle | 2.884 | 27*4 | 311.468 | 400 |
| High | 2.884 | 27*4 | 311.460 | 400 |

Note: The 8DPSK modulation is the worst case and recorded in the report.

Any report having not been signed by authorized approver, or having been altered without authorization, or having not been stamped by the "Dedicated Testing/Inspection Stamp" is deemed to be invalid. Copying or excerpting portion of, or altering the content of the report is not permitted without the written authorization of AGC. The test results presented in the report apply only to the tested sample. Any objections to report issued by AGC should be submitted to AGC within 15 days after the issuance of the test report. Further enquiry of validity or verification of the test report should be addressed to AGC by agc@agc-cert.com.

Attestation of Global Compliance(Shenzhen)Co., Ltd
Attestation of Global Compliance(Shenzhen)Std & Tech Co., Ltd
Tel: +86-755 2523 4088 E-mail: agc@agc-cert.com Web: http://cn.agc-cert.com/



TEST PLOT OF LOW CHANNEL

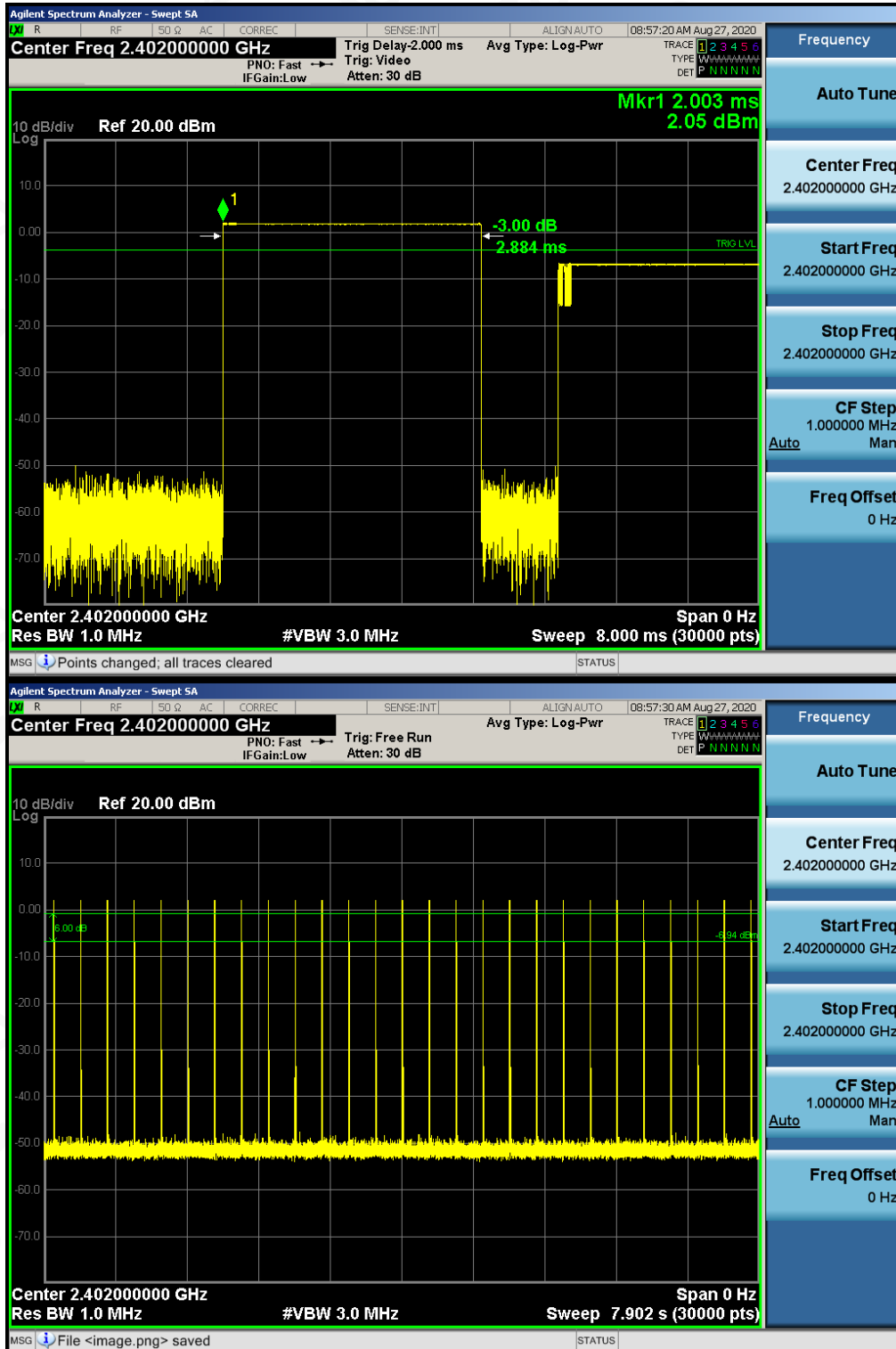

Any report having not been signed by authorized approver, or having been altered without authorization, or having not been stamped by the "Dedicated Testing/Inspection Stamp" is deemed to be invalid. Copying or excerpting portion of, or altering the content of the report is not permitted without the written authorization of AGC. The test results presented in the report apply only to the tested sample. Any objections to report issued by AGC should be submitted to AGC within 15 days after the issuance of the test report. Further enquiry of validity or verification of the test report should be addressed to AGC by agc@agc-cert.com.

Attestation of Global Compliance(Shenzhen)Co., Ltd
Attestation of Global Compliance(Shenzhen)Std & Tech Co., Ltd
Tel: +86-755 2523 4088 E-mail: agc@agc-cert.com Web: http://cn.agc-cert.com/



TEST PLOT OF MIDDLE CHANNEL

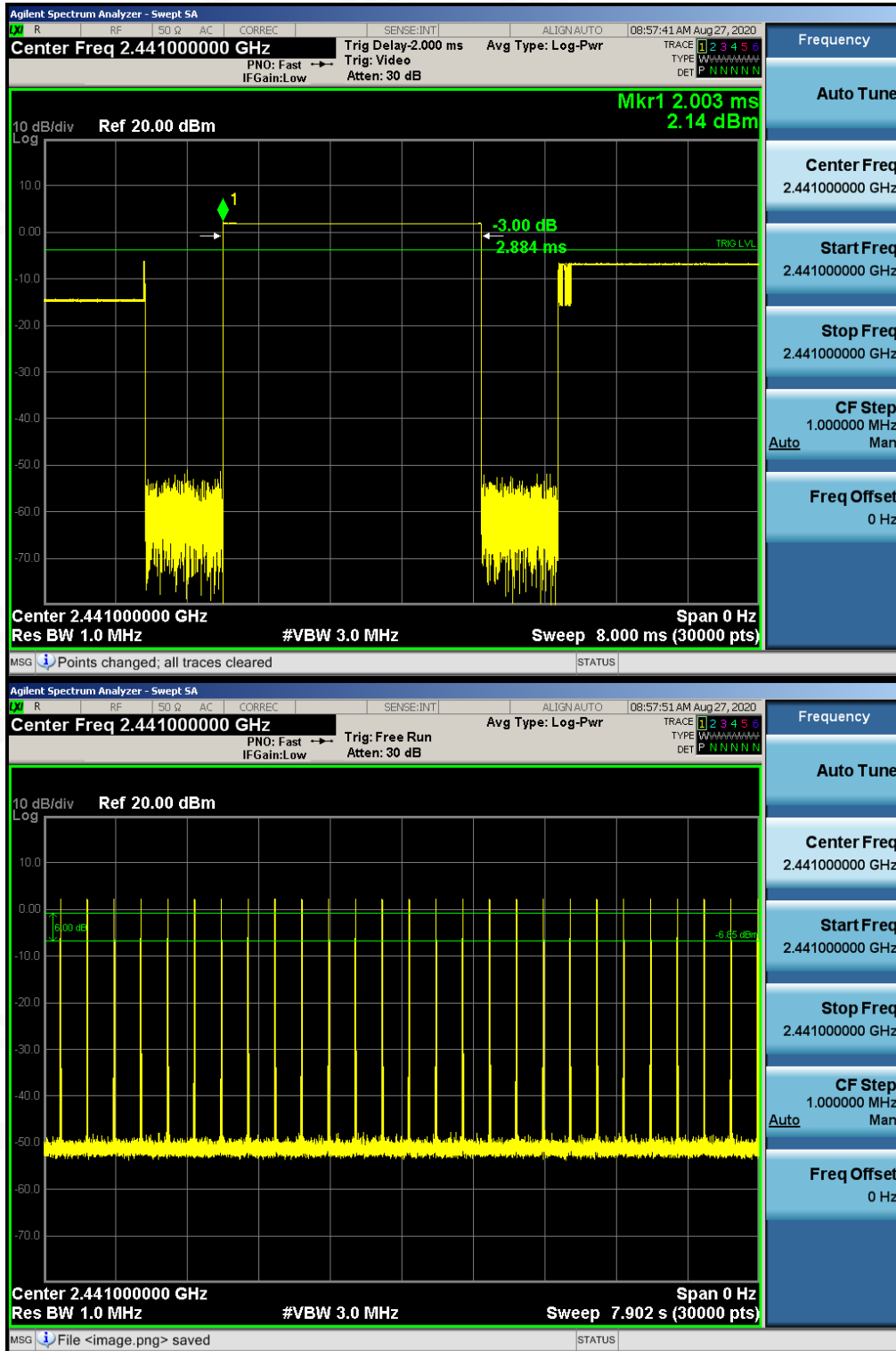

Any report having not been signed by authorized approver, or having been altered without authorization, or having not been stamped by the "Dedicated Testing/Inspection Stamp" is deemed to be invalid. Copying or excerpting portion of, or altering the content of the report is not permitted without the written authorization of AGC. The test results presented in the report apply only to the tested sample. Any objections to report issued by AGC should be submitted to AGC within 15 days after the issuance of the test report. Further enquiry of validity or verification of the test report should be addressed to AGC by agc@agc-cert.com.

Attestation of Global Compliance(Shenzhen)Co., Ltd
Attestation of Global Compliance(Shenzhen)Std & Tech Co., Ltd
Tel: +86-755 2523 4088 E-mail: agc@agc-cert.com Web: http://cn.agc-cert.com/



TEST PLOT OF HIGH CHANNEL

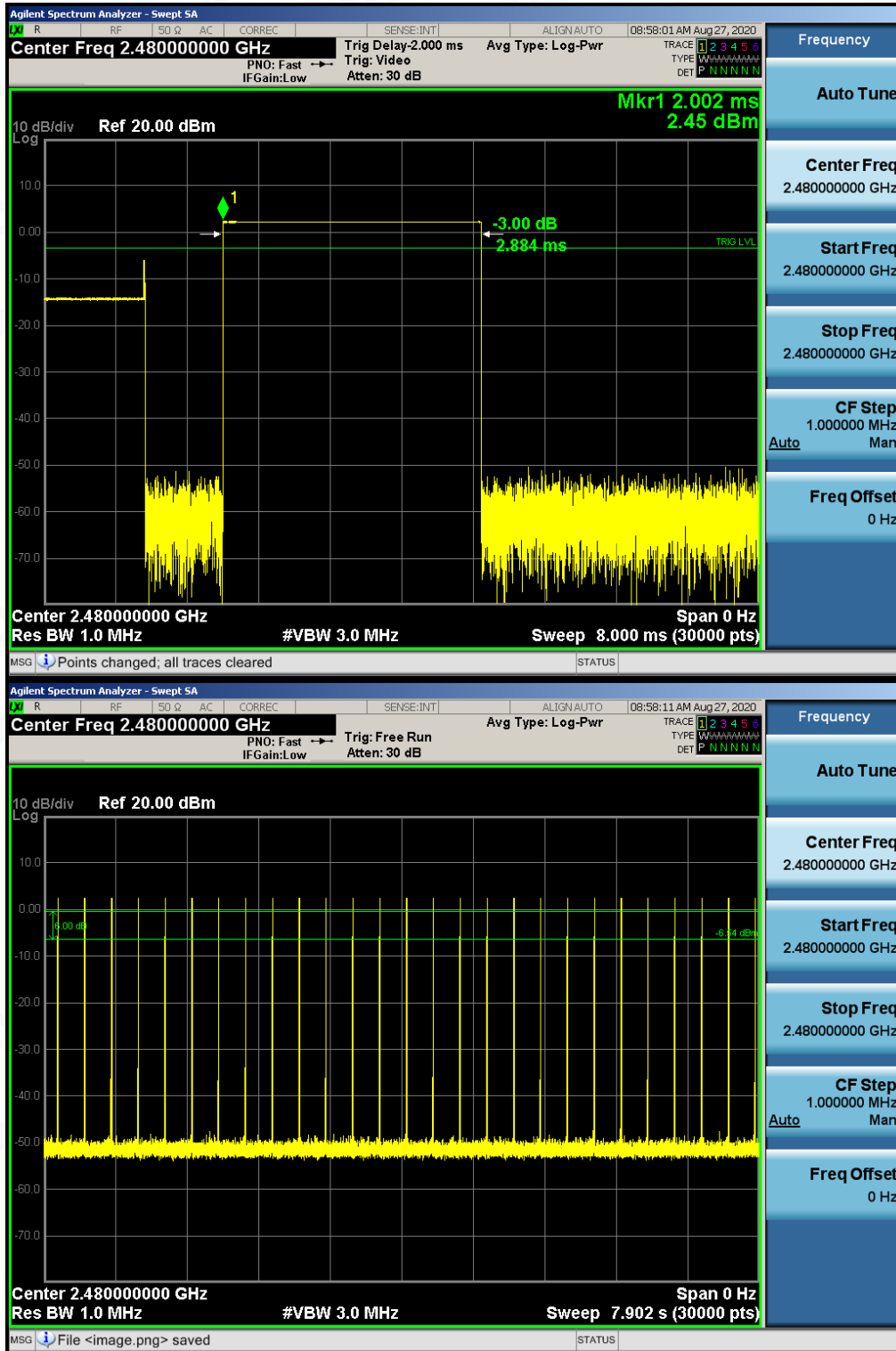

Any report having not been signed by authorized approver, or having been altered without authorization, or having not been stamped by the "Dedicated Testing/Inspection Stamp" is deemed to be invalid. Copying or excerpting portion of, or altering the content of the report is not permitted without the written authorization of AGC. The test results presented in the report apply only to the tested sample. Any objections to report issued by AGC should be submitted to AGC within 15 days after the issuance of the test report. Further enquiry of validity or verification of the test report should be addressed to AGC by agc@agc-cert.com.

Attestation of Global Compliance(Shenzhen)Co., Ltd
Attestation of Global Compliance(Shenzhen)Std & Tech Co., Ltd
Tel: +86-755 2523 4088 E-mail: agc@agc-cert.com Web: http://cn.agc-cert.com/



13. FREQUENCY SEPARATION

13.1. MEASUREMENT PROCEDURE

The EUT shall have its hopping function enabled. Use the following spectrum analyzer settings:

1. Span: Wide enough to capture the peaks of two adjacent channels.
 2. RBW: Start with the RBW set to approximately 30% of the channel spacing; adjust as necessary to best identify the center of each individual channel.
 3. Video (or average) bandwidth (VBW) \geq RBW.
 4. Sweep: Auto. e) Detector function: Peak. f) Trace: Max hold. g) Allow the trace to stabilize.
- Use the marker-delta function to determine the separation between the peaks of the adjacent channels.

13.2. TEST SETUP (BLOCK DIAGRAM OF CONFIGURATION)

Same as described in section 6.2

13.3. MEASUREMENT EQUIPMENT USED

The same as described in section 6.3

13.4. LIMITS AND MEASUREMENT RESULT

| CHANNEL | CHANNEL SEPARATION | LIMIT | RESULT |
|-----------|--------------------|---------------------|--------|
| | MHz | | |
| CH39-CH40 | 1.001 | $\geq 2/3$ 20 dB BW | Pass |

TEST PLOT FOR FREQUENCY SEPARATION

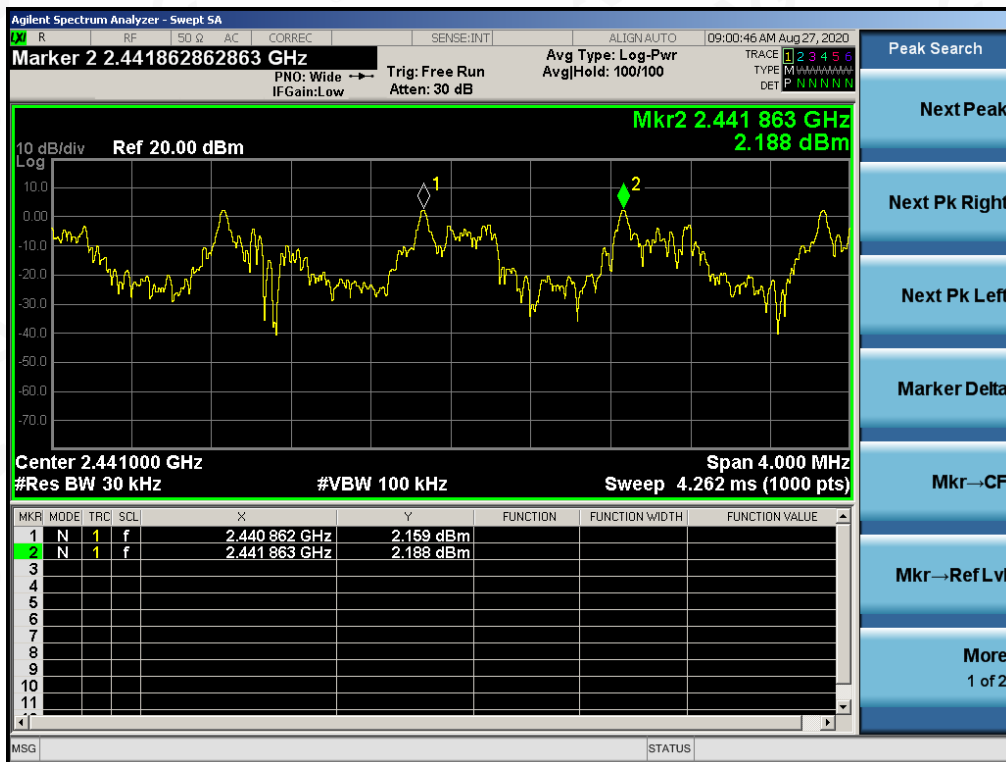

Note: The GFSK modulation is the worst case and recorded in the report.

Any report having not been signed by authorized approver, or having been altered without authorization, or having not been stamped by the "Dedicated Testing/Inspection Stamp" is deemed to be invalid. Copying or excerpting portion of, or altering the content of the report is not permitted without the written authorization of AGC. The test results presented in the report apply only to the tested sample. Any objections to report issued by AGC should be submitted to AGC within 15 days after the issuance of the test report. Further enquiry of validity or verification of the test report should be addressed to AGC by agc@agc-cert.com.



14. FCC LINE CONDUCTED EMISSION TEST

14.1. LIMITS OF LINE CONDUCTED EMISSION TEST

| Frequency | Maximum RF Line Voltage | |
|---------------|-------------------------|----------------------|
| | Q.P. (dB μ V) | Average (dB μ V) |
| 150kHz~500kHz | 66-56 | 56-46 |
| 500kHz~5MHz | 56 | 46 |
| 5MHz~30MHz | 60 | 50 |

Note:

1. The lower limit shall apply at the transition frequency.
2. The limit decreases linearly with the logarithm of the frequency in the range 0.15 MHz to 0.50 MHz.

14.2. BLOCK DIAGRAM OF LINE CONDUCTED EMISSION TEST

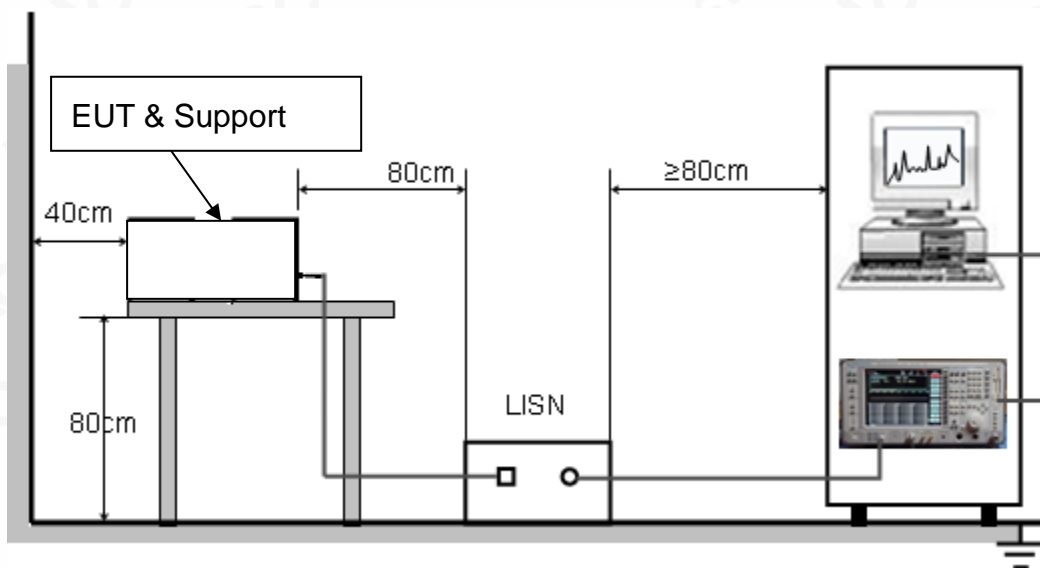

Any report having not been signed by authorized approver, or having been altered without authorization, or having not been stamped by the "Dedicated Testing/Inspection Stamp" is deemed to be invalid. Copying or excerpting portion of, or altering the content of the report is not permitted without the written authorization of AGC. The test results presented in the report apply only to the tested sample. Any objections to report issued by AGC should be submitted to AGC within 15 days after the issuance of the test report. Further enquiry of validity or verification of the test report should be addressed to AGC by agc@agc-cert.com.

14.3. PRELIMINARY PROCEDURE OF LINE CONDUCTED EMISSION TEST

1. The equipment was set up as per the test configuration to simulate typical actual usage per the user's manual. When the EUT is a tabletop system, a wooden table with a height of 0.8 meters is used and is placed on the ground plane as per ANSI C63.10 (see Test Facility for the dimensions of the ground plane used). When the EUT is a floor-standing equipment, it is placed on the ground plane which has a 3-12 mm non-conductive covering to insulate the EUT from the ground plane.
2. Support equipment, if needed, was placed as per ANSI C63.10.
3. All I/O cables were positioned to simulate typical actual usage as per ANSI C63.10.
4. All support equipment received AC120V/60Hz power from a LISN, if any.
5. The EUT received DC 3.3V power from control board which received AC120V/60Hz power from a LISN.
6. The test program was started. Emissions were measured on each current carrying line of the EUT using a spectrum Analyzer / Receiver connected to the LISN powering the EUT. The LISN has two monitoring points: Line 1 (Hot Side) and Line 2 (Neutral Side). Two scans were taken: one with Line 1 connected to Analyzer / Receiver and Line 2 connected to a 50 ohm load; the second scan had Line 1 connected to a 50 ohm load and Line 2 connected to the Analyzer / Receiver.
7. Analyzer / Receiver scanned from 150 kHz to 30MHz for emissions in each of the test modes.
8. During the above scans, the emissions were maximized by cable manipulation.
9. The test mode(s) were scanned during the preliminary test.

Then, the EUT configuration and cable configuration of the above highest emission level were recorded for reference of final testing.

14.4. FINAL PROCEDURE OF LINE CONDUCTED EMISSION TEST

1. EUT and support equipment was set up on the test bench as per step 2 of the preliminary test.
2. A scan was taken on both power lines, Line 1 and Line 2, recording at least the six highest emissions. Emission frequency and amplitude were recorded into a computer in which correction factors were used to calculate the emission level and compare reading to the applicable limit. If EUT emission level was less – 2dB to the A.V. limit in Peak mode, then the emission signal was re-checked using Q.P and Average detector.
3. The test data of the worst case condition(s) was reported on the Summary Data page.

14.5. TEST RESULT OF LINE CONDUCTED EMISSION TEST

Note: The conducted emission tests at AC port are not required for devices which only employ battery power for operation.

Any report having not been signed by authorized approver, or having been altered without authorization, or having not been stamped by the "Dedicated Testing/Inspection Stamp" is deemed to be invalid. Copying or excerpting portion of, or altering the content of the report is not permitted without the written authorization of AGC. The test results presented in the report apply only to the tested sample. Any objections to report issued by AGC should be submitted to AGC within 15days after the issuance of the test report. Further enquiry of validity or verification of the test report should be addressed to AGC by agc@agc-cert.com.

Attestation of Global Compliance(Shenzhen)Co., Ltd
Attestation of Global Compliance(Shenzhen)Std & Tech Co., Ltd
Tel: +86-755 2523 4088 E-mail: agc@agc-cert.com Web: http://cn.agc-cert.com/



APPENDIX A: PHOTOGRAPHS OF TEST SETUP

RADIATED EMISSION TEST SETUP BELOW 1GHZ

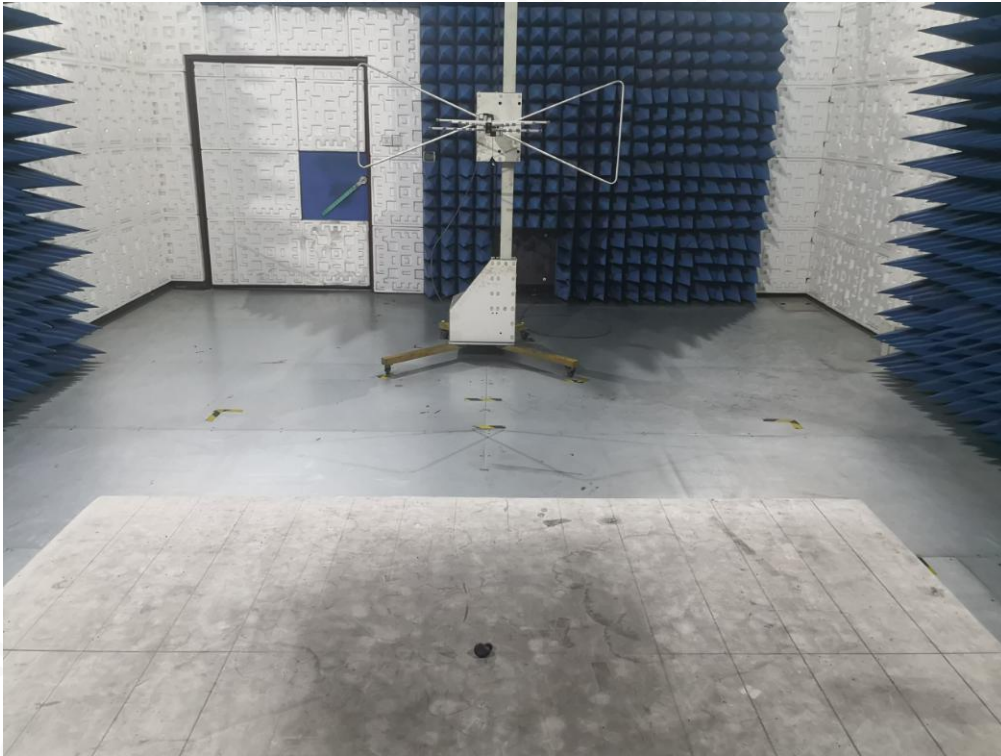

RADIATED EMISSION TEST SETUP ABOVE 1GHZ



Any report having not been signed by authorized approver, or having been altered without authorization, or having not been stamped by the "Dedicated Testing/Inspection Stamp" is deemed to be invalid. Copying or excerpting portion of, or altering the content of the report is not permitted without the written authorization of AGC. The test results presented in the report apply only to the tested sample. Any objections to report issued by AGC should be submitted to AGC within 15 days after the issuance of the test report. Further enquiry of validity or verification of the test report should be addressed to AGC by agc@agc-cert.com.

Attestation of Global Compliance(Shenzhen)Co., Ltd
Attestation of Global Compliance(Shenzhen)Std & Tech Co., Ltd
Tel: +86-755 2523 4088 E-mail: agc@agc-cert.com Web: <http://cn.agc-cert.com/>



CONDUCTED EMISSION TEST SETUP

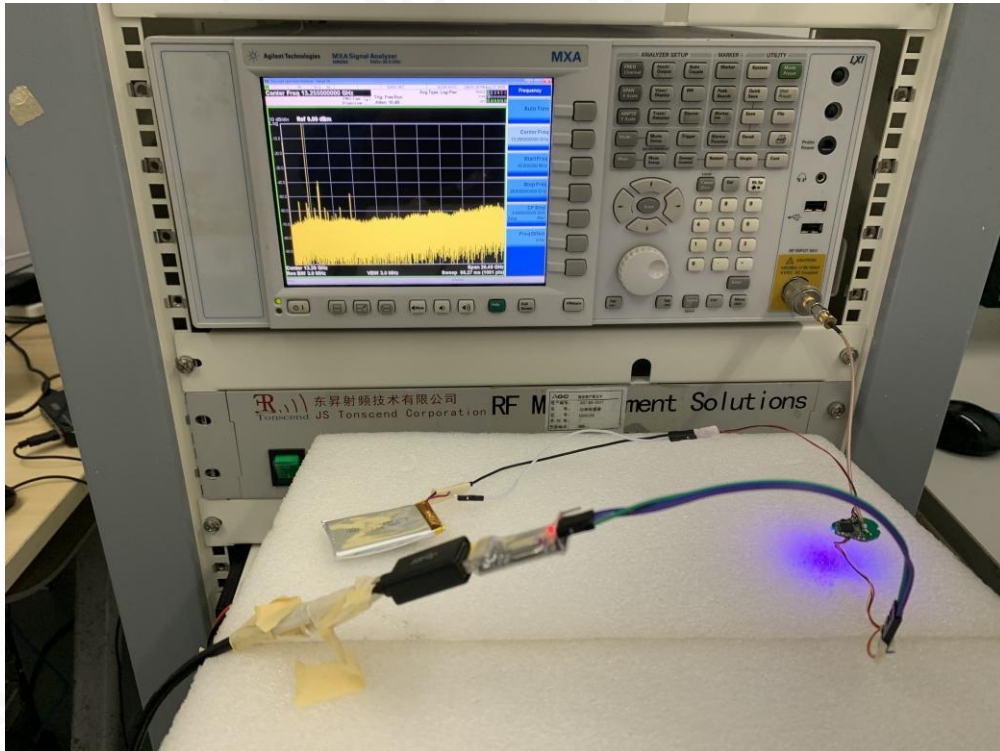

Any report having not been signed by authorized approver, or having been altered without authorization, or having not been stamped by the "Dedicated Testing/Inspection Stamp" is deemed to be invalid. Copying or excerpting portion of, or altering the content of the report is not permitted without the written authorization of AGC. The test results presented in the report apply only to the tested sample. Any objections to report issued by AGC should be submitted to AGC within 15 days after the issuance of the test report. Further enquiry of validity or verification of the test report should be addressed to AGC by agc@agc-cert.com.

Attestation of Global Compliance(Shenzhen)Co., Ltd
Attestation of Global Compliance(Shenzhen)Std & Tech Co., Ltd
Tel: +86-755 2523 4088 E-mail: agc@agc-cert.com Web: <http://cn.agc-cert.com/>



APPENDIX B: PHOTOGRAPHS OF EUT

Refer to the Report No.: AGC00252200801AP01

----END OF REPORT----

Any report having not been signed by authorized approver, or having been altered without authorization, or having not been stamped by the "Dedicated Testing/Inspection Stamp" is deemed to be invalid. Copying or excerpting portion of, or altering the content of the report is not permitted without the written authorization of AGC. The test results presented in the report apply only to the tested sample. Any objections to report issued by AGC should be submitted to AGC within 15 days after the issuance of the test report. Further enquiry of validity or verification of the test report should be addressed to AGC by agc@agc-cert.com.

Attestation of Global Compliance(Shenzhen)Co., Ltd
Attestation of Global Compliance(Shenzhen)Std & Tech Co., Ltd
Tel: +86-755 2523 4088 E-mail: agc@agc-cert.com Web: <http://cn.agc-cert.com/>





Conditions of Issuance of Test Reports

1. All samples and goods are accepted by the Attestation of Global Compliance (Shenzhen) Co., Ltd (the “Company”) solely for testing and reporting in accordance with the following terms and conditions. The company provides its services on the basis that such terms and conditions constitute express agreement between the company and any person, firm or company requesting its services (the “Clients”).
2. Any report issued by Company as a result of this application for testing services (the “Report”) shall be issued in confidence to the Clients and the Report will be strictly treated as such by the Company. It may not be reproduced either in its entirety or in part and it may not be used for advertising or other unauthorized purposes without the written consent of the Company. The Clients to whom the Report is issued may, however, show or send it, or a certified copy thereof prepared by the Company to its customer, supplier or other persons directly concerned. The Company will not, without the consent of the Clients, enter into any discussion or correspondence with any third party concerning the contents of the Report, unless required by the relevant governmental authorities, laws or court orders.
3. The Company shall not be called or be liable to be called to give evidence or testimony on the Report in a court of law without its prior written consent, unless required by the relevant governmental authorities, laws or court orders.
4. The non-CMA report issued by AGC is only permitted to be used by the client as internal reference use and shall not be used for public demonstration purpose.
5. In the event of the improper use of the report as determined by the Company, the Company reserves the right to withdraw it, and to adopt any other additional remedies which may be appropriate.
6. Samples submitted for testing are accepted on the understanding that the Report issued cannot form the basis of, or be the instrument for, any legal action against the Company.
7. The Company will not be liable for or accept responsibility for any loss or damage however arising from the use of information contained in any of its Reports or in any communication whatsoever about its said tests or investigations.
8. Clients wishing to use the Report in court proceedings or arbitration shall inform the Company to that effect prior to submitting the sample for testing.
9. The Company is not responsible for recalling the electronic version of the original report when any revision is made to them. The Client assumes the responsibility to providing the revised version to any interested party who uses them.
10. Subject to the variable length of retention time for test data and report stored hereinto as otherwise specifically required by individual accreditation authorities, the Company will only keep the supporting test data and information of the test report for a period of six years. The data and information will be disposed of after the aforementioned retention period has elapsed. Under no circumstances shall we provide any data and information which has been disposed of after retention period. Under no circumstances shall we be liable for damage of any kind, including (but not limited to) compensatory damages, lost profits, lost data, or any form of special, incidental, indirect, consequential or punitive damages of any kind, whether based on breach of contract of warranty, tort (including negligence), product liability or otherwise, even if we are informed in advance of the possibility of such damages.

Any report having not been signed by authorized approver, or having been altered without authorization, or having not been stamped by the “Dedicated Testing/Inspection Stamp” is deemed to be invalid. Copying or excerpting portion of, or altering the content of the report is not permitted without the written authorization of AGC. The test results presented in the report apply only to the tested sample. Any objections to report issued by AGC should be submitted to AGC within 15 days after the issuance of the test report. Further enquiry of validity or verification of the test report should be addressed to AGC by agc@agc-cert.com.

