



TEST REPORT

For

Applicant : iLUV Creative Technology

Address : 2 Harbor Park Drive, Port Washington, NY11050, USA

Product Name : SmartShaker 2

Model Name : SmartShaker 2, DS-1582S

Brand Name : N/A

FCC ID : ATL-SMARTSHAKER2

Report No. : MTE/DYY/S16040666

Date of Issue : Apr. 22, 2016

Issued by : Most Technology Service Co., Ltd.

**Address : No.5, 2nd Langshan Road, North District, Hi-tech Industrial
Park, Nanshan, Shenzhen, Guangdong, China**

Tel : 86-755-8602 6850

Fax : 86-755-2601 3350

The report consists 38 pages in total. It may be duplicated completely for legal use with the approval of the applicant. It should not be reproduced except in full, without the written approval of our laboratory. The client should not use it to claim product endorsement by MOST. The test results in the report only apply to the tested sample. The test report shall be invalid without all the signatures of testing engineers, reviewer and approver.

TABLE OF CONTENTS

1. VERIFICATION OF CONFORMITY	4
2. GENERAL INFORMATION.....	5
2.1 Product Information	5
2.2 Objective	5
2.3 Test Standards and Results.....	6
2.4 Environmental Conditions.....	6
3. TEST METHODOLOGY	7
3.1 TEST FACILITY.....	7
3.2 GENERAL TEST PROCEDURES	7
4. SETUP OF EQUIPMENT UNDER TEST	8
4.1 SETUP CONFIGURATION OF EUT.....	8
4.2 SUPPORT EQUIPMENT	8
4.3 TEST EQUIPMENT LIST.....	9
5. 47 CFR Part 15 C Requirements	10
5.1 RF EXPOSURE.....	10
5.1.1 Applicable Standard.....	10
5.1.2 Measurement Result	10
5.2 ANTENNA REQUIREMENT	11
5.2.1 Applicable Standard.....	11
5.2.2 Evaluation Criteria	11
5.2.3 Result: Compliance.....	11
5.3 AC Power Line Conducted Emission.....	12
5.3.1 Requirement.....	12
5.3.2 Block Diagram of Test Setup	12
5.3.3 Test procedure.....	12
5.3.4 Test Result.....	12
5.4 Radiated Emission	13
5.4.1 Requirement.....	15
5.4.2 Test Configuration.....	15
5.4.3 Test Procedure:	16
5.4.4 Test Result.....	17
5.5 Conducted Peak Output Power	18
5.5.1 Requirement.....	24
5.5.2 Block Diagram of Test Setup	24
5.5.3 Test Procedure	24
5.5.4 Test Result.....	24
5.6 6dB Emission Bandwidth.....	26
5.6.1 Test Requirement	26
5.6.2 Block Diagram of Test Setup	26
5.6.3 Test Procedure	26
5.6.4 Test Result.....	26
5.7 POWER SPECTRAL DENSITY.....	28
5.7.1 Applicable Standard.....	28
5.7.2 Test Procedure	28
5.7.3 Test Result.....	28
5.8 Band Edge and Conducted Spurious Emissions	30
5.8.1 Test Requirement	30
5.8.2 Test Procedure	30
5.8.3 Test Result.....	30
5.9 Restricted Frequency Bands	34

5.9.1 Test Requirement	34
5.9.2 Test Configuration.....	34
5.9.3 Test Procedure:	34
5.9.4 Test Result.....	34

1. VERIFICATION OF CONFORMITY

Equipment Under Test:	SmartShaker 2
Brand Name:	N/A
Model Number:	SmartShaker 2, DS-1582S
FCC ID:	ATL-SMARTSHAKER2
Applicant:	iLUV Creative Technology 2 Harbor Park Drive, Port Washington, NY11050, USA
Manufacturer:	Wonders Technology Co., Ltd DOSS Industrial Zone, Qiping Kengdu Industrial Area Guihua Village, Guanlan Town Baoan District, ShenZhen, China
Technical Standards:	47 CFR Part 15 Subpart C
File Number:	MTE/DYY/S16040666
Date of test:	Apr. 18-22, 2016
Deviation:	None
Condition of Test Sample:	Normal
Test Result:	PASS

The above equipment was tested by Most Technology Service Co., Ltd. for compliance with the requirements set forth in FCC rules and the Technical Standards mentioned above. This said equipment in the configuration described in this report shows the maximum emission levels emanating from equipment and the level of the immunity endurance of the equipment are within the compliance requirements.

The test results of this report relate only to the tested sample identified in this report.

Tested by (+ signature): Daisy
Daisy Yu Apr. 18-22, 2016

Review by (+ signature): Henry
Henry Chen Apr. 22, 2016

Approved by (+ signature): [Signature]
Yvette Zhou (Manager) Apr. 22, 2016



2. GENERAL INFORMATION

2.1 Product Information

Product	SmartShaker 2
Brand Name	N/A
Model Number	SmartShaker 2
Series Model Name:	DS-1582S
Series Model Difference description:	Only difference in the model name.
Power Supply	DC 5.0 V by USB port DC 3.7V by Battery
Frequency Range	2402MHz -2480MHz
Modulation Type:	GFSK
Channel Number	40
Antenna Type	Internal PCB Antenna, 0 dBi
Temperature Range	0°C ~ +40°C

NOTE:

1. For a more detailed features description about the EUT, please refer to User's Manual.

2.2 Objective

The objective of the report is to perform tests according to FCC Part 15 Subpart C for the EUT FCC ID Certification:

No.	Identity	Document Title
1	47 CFR Part 15	Radio Frequency Devices
2	KDB 558074	Guidance for Performing Compliance Measurements on Digital Transmission Systems (DTS) Operating Under §15.247

2.3 Test Standards and Results

No.	Section	Test Items	Result	Date of Test
1	FCC 15.247 (i)	RF EXPOSURE	PASS	2016-04-20
2	FCC 15.203	Antenna Requirement	PASS	2016-04-20
3	FCC15.209, 15.247(d)	Radiated Emission	PASS	2016-04-21
4	FCC15.247(b)(3)	Conducted Peak Output Power	PASS	2016-04-21
5	FCC15.247(a)(2)	6dB Emission Bandwidth	PASS	2016-04-21
6	FCC15.247(e)	Power Spectral Density	PASS	2016-04-20
7	FCC15.247(d)	Band Edge and Conducted Spurious Emissions	PASS	2016-04-20
8	FCC15.247(d)	Restricted Frequency Bands	PASS	2016-04-18

Note: 1. The test result judgment is decided by the limit of measurement standard
 2. The information of measurement uncertainty is available upon the customer's request.

2.4 Environmental Conditions

During the measurement the environmental conditions were within the listed ranges:

- Temperature: 15-35°C
- Humidity: 30-60 %
- Atmospheric pressure: 86-106 kPa

3. TEST METHODOLOGY

3.1 TEST FACILITY

Test Site:	Most Technology Service Co., Ltd
Location:	No.5, Langshan 2nd Rd., North Hi-Tech Industrial park, Nanshan, Shenzhen, Guangdong, China
Description:	There is one 3m semi-anechoic an area test sites and two line conducted labs for final test. The Open Area Test Sites and the Line Conducted labs are constructed and calibrated to meet the FCC requirements in documents ANSI C63.10:2013 and CISPR 16 requirements. The FCC Registration Number is 490827 . The IC Registration Number is 7103A-1 .
Site Filing:	The site description is on file with the Federal Communications Commission, 7435 Oakland Mills Road, Columbia, MD 21046.
Instrument	All measuring equipment is in accord with ANSI C63.10:2013 and CISPR 16
Tolerance:	requirements that meet industry regulatory agency and accreditation agency requirement.
Ground Plane:	Two conductive reference ground planes were used during the Line Conducted Emission, one in vertical and the other in horizontal. The dimensions of these ground planes are as below. The vertical ground plane was placed distancing 40 cm to the rear of the wooden test table on where the EUT and the support equipment were placed during test. The horizontal ground plane projected 50 cm beyond the footprint of the EUT system and distanced 80 cm to the wooden test table. For Radiated Emission Test, one horizontal conductive ground plane extended at least 1m beyond the periphery of the EUT and the largest measuring antenna, and covered the entire area between the EUT and the antenna.

3.2 GENERAL TEST PROCEDURES

Radiated Emissions

The EUT is placed on a turn table, which is 1.5 m above ground plane. The turntable shall rotate 360 degrees to determine the position of maximum emission level. EUT is set 3m away from the receiving antenna, which varied from 1m to 4m to find out the highest emission. And also, each emission was to be maximized by changing the polarization of receiving antenna both horizontal and vertical. In order to find out the maximum emissions, exploratory radiated emission measurements were made according to the requirements in Section 6.5 of ANSI C63.10:2013.

Conducted Emissions

The EUT is placed on the turntable, which is 0.8 m above ground plane. According to the requirements in Section 6.2 of ANSI C63.10:2013, Conducted emissions from the EUT measured in the frequency range between 0.15 MHz and 30MHz using CISPR Quasi-peak and average detector modes.

4. SETUP OF EQUIPMENT UNDER TEST

4.1 SETUP CONFIGURATION OF EUT

See test photographs attached in Appendix 1 for the actual connections between EUT and support equipment.

4.2 SUPPORT EQUIPMENT

Device Type	Manufacturer	Model Name	Serial No.	Input	Output
---	---	---	---	---	---

Remark:

All the equipment/cables were placed in the worst-case configuration to maximize the emission during the test. Grounding was established in accordance with the manufacturer's requirements and conditions for the intended use.

4.3 TEST EQUIPMENT LIST

Instrumentation: The following list contains equipment used at Most for testing. The equipment conforms to the CISPR 16-1 / ANSI C63.2 Specifications for Electromagnetic Interference and Field Strength Instrumentation from 10 kHz to 1.0 GHz or above.

No.	Equipment	Manufacturer	Model No.	S/N	Calibration date	Calibration Interval
1	Test Receiver	Rohde & Schwarz	ESCI	100492	2016/03/10	1 Year
2	Spectrum Analyzer	Agilent	E7405A	US44210471	2016/03/14	1 Year
3	L.I.S.N.	Rohde & Schwarz	ENV216	100093	2016/03/10	1 Year
4	Coaxial Switch	Anritsu Corp	MP59B	6200283933	2016/03/07	1 Year
5	Terminator	Hubersuhner	50Ω	No.1	2016/03/07	1 Year
6	RF Cable	SchwarzBeck	N/A	No.1	2016/03/07	1 Year
7	Test Receiver	Rohde & Schwarz	ESPI	101202	2016/03/10	1 Year
8	Bilog Antenna	Sunol	JB3	A121206	2016/03/14	1 Year
9	Horn Antenna	SCHWARZBECK	BBHA9120D	756	2016/03/14	1 Year
10	Horn Antenna	Penn Engineering	9034	8376	2016/03/14	1 Year
11	Cable	Resenberger	N/A	NO.1	2016/03/07	1 Year
12	Cable	SchwarzBeck	N/A	NO.2	2016/03/07	1 Year
13	Cable	SchwarzBeck	N/A	NO.3	2016/03/07	1 Year
14	Single Phase Power Line Filter	DuoJi	FNF 202B30	N/A	2016/03/07	1 Year
15	Test Receiver	Rohde & Schwarz	ESCI	100492	2016/03/10	1 Year
16	Loop antenna	ARA	PLA-1030/B	1039	2016/03/14	1 Year

NOTE: Equipments listed above have been calibrated and are in the period of validation.

5. 47 CFR Part 15 C Requirements

5.1 RF EXPOSURE

5.1.1 Applicable Standard

According to §15.247(i) and §1.1310, systems operating under the provisions of this section shall be operated in a manner that ensure that the public is not exposed to radio frequency energy level in excess of the Commission's guideline.

According to KDB447498 D01 General RF Exposure Guidance v05r02:

The 1-g and 10-g SAR test exclusion thresholds for 100 MHz to 6 GHz at test separation distances ≤ 50 mm are determined by:

$$\left[\frac{\text{(max. power of channel, including tune-up tolerance, mW)}}{\text{(min. test separation distance, mm)}} \cdot \sqrt{f(\text{GHz})} \right] \leq 3.0 \text{ for 1-g SAR and } \leq 7.5 \text{ for 10-g extremity SAR, where}$$

$$f(\text{GHz}) \text{ is the RF channel transmit frequency in GHz}$$

Power and distance are rounded to the nearest mW and mm before calculation

The result is rounded to one decimal place for comparison

3.0 and 7.5 are referred to as the numeric thresholds in the step 2 below

The test exclusions are applicable only when the minimum test separation distance is ≤ 50 mm and for transmission frequencies between 100 MHz and 6 GHz. When the minimum test separation distance is < 5 mm, a distance of 5 mm according to 5) in section 4.1 is applied to determine SAR test exclusion.

5.1.2 Measurement Result

The maximum conducted output power = 0.733 dBm (1.1838 mW) at 2402 MHz $\left[\frac{\text{(max. power of channel, mW)}}{\text{(min. test separation distance, mm)}} \right] \sqrt{f(\text{GHz})}$

$$= 1.1838/5 \cdot (\sqrt{2.402}) = 0.3669 < 3.0$$

So the stand-alone SAR evaluation is not necessary.

5.2 ANTENNA REQUIREMENT

5.2.1 Applicable Standard

According to FCC § 15.203 , An intentional radiator shall be designed to ensure that no antenna other than that furnished by the responsible party shall be used with the device. The use of a permanently attached antenna or of an antenna that uses a unique coupling to the intentional radiator shall be considered sufficient to comply with the provisions of this section. The manufacturer may design the unit so that a broken antenna can be replaced by the user, but the use of a standard antenna jack or electrical connector is prohibited. This requirement does not apply to carrier current devices or to devices operated under the provisions of §15.211, §15.213, §15.217, §15.219, or §15.221. Further, this requirement does not apply to intentional radiators that must be professionally installed, such as perimeter protection systems and some field disturbance sensors, or to other intentional radiators which, in accordance with §15.31(d), must be measured at the installation site. However, the installer shall be responsible for ensuring that the proper antenna is employed so that the limits in this part are not exceeded.

5.2.2 Evaluation Criteria

(a) Antenna must be permanently attached to the unit.

(b) Antenna must use a unique type of connector to attach to the EUT.

Unit must be professionally installed, Installer shall be responsible for verifying that the correct antenna is employed with the unit.

5.2.3 Result: Compliance.

The EUT has one integral antenna arrangement, which was permanently attached and the antenna gain is 0 dBi, fulfill the requirement of this section.

5.3 AC Power Line Conducted Emission

5.3.1 Requirement

A radio apparatus that is designed to be connected to the public utility (AC) power line shall ensure that the radio frequency voltage, which is conducted back onto the AC power line on any frequency or frequencies within the and 150 kHz-30 MHz, shall not exceed the limits in the following table:

Frequency	Maximum RF Line Voltage	
	Q.P.(dBuV)	Average(dBuV)
150kHz-500kHz	66-56	56-46
500kHz-5MHz	56	46
5MHz-30MHz	60	50

****Note:** 1. the lower limit shall apply at the band edges.
2. The limit decreases linearly with the logarithm of the frequency in the range 0.15 MHz to 0.50 MHz

5.3.2 Block Diagram of Test Setup

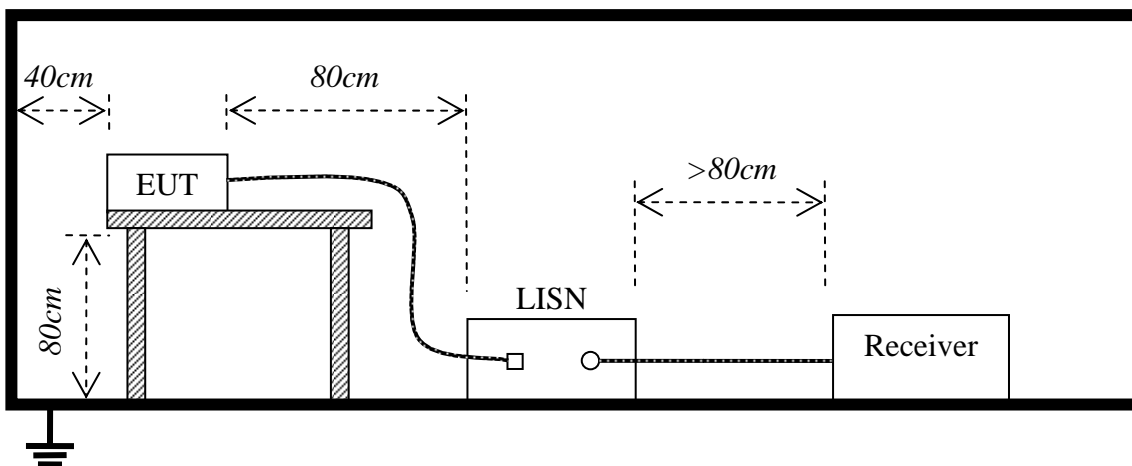

5.3.3 Test procedure

1. The E.U.T and simulators are connected to the main power through a line impedance stabilization network (L.I.S.N.). This provides a 50ohm/50uH coupling impedance for the measuring equipment.
2. Exploratory measurements were made to identify the frequency of the emission that has the highest amplitude relative to the limit;
3. The peripheral devices are also connected to the main power through a LISN that provides a 50ohm/50uH coupling impedance with 50ohm termination. (Please refer to the block diagram of the test setup and photographs).
4. Both sides of A.C. line are checked for maximum conducted interference. In order to find the maximum emission, the relative positions of equipment and all of the interface cables must be changed according to ANSI C63.10:2013 on conducted measurement.
5. The bandwidth of test receiver (ESCI) set at 9 KHz.
6. All data was recorded in the Quasi-peak and average detection mode.

5.3.4 Test Result

Pass

Note: All test modes are performed, only the worst case is recorded in this report.

Please refer the following pages.

EUT:	SmartShaker 2	M/N:	SmartShaker 2
Mode:	Charging	Phase:	N
Test by:	John	Power:	DC 5V by USB Port
Temperature: / Humidity	24.4°C / 50.8%	Test date:	2016-04-21

80.0 dBuV

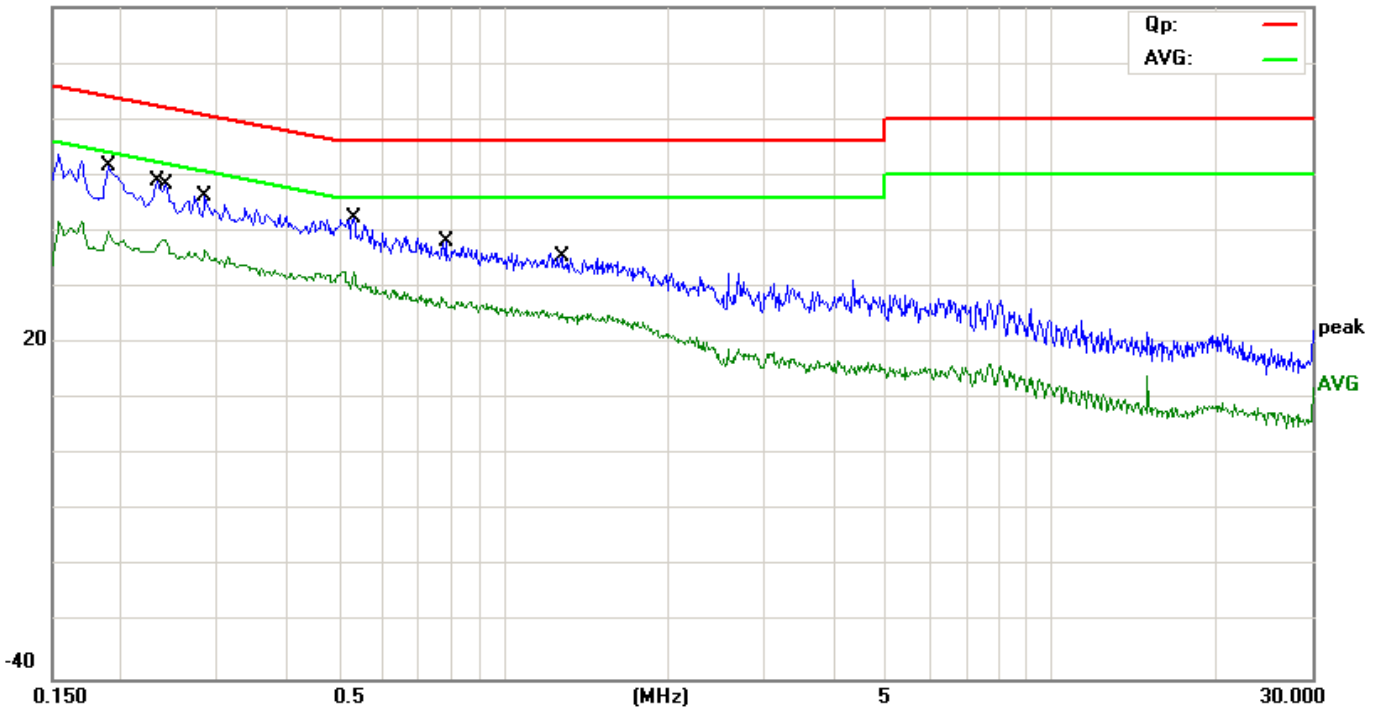

No.	Mk.	Freq. MHz	Reading Level dBuV	Correct Factor dB	Measure- ment dBuV	Limit dBuV	Over dB	Detector	Comment
1	*	0.1900	42.06	9.60	51.66	64.04	-12.38	QP	
2		0.1900	30.46	9.60	40.06	54.04	-13.98	AVG	
3		0.2340	39.31	9.60	48.91	62.31	-13.40	QP	
4		0.2380	28.85	9.60	38.45	52.17	-13.72	AVG	
5		0.2860	36.52	9.59	46.11	60.64	-14.53	QP	
6		0.2860	26.99	9.59	36.58	50.64	-14.06	AVG	
7		0.5340	32.85	9.59	42.44	56.00	-13.56	QP	
8		0.5340	23.10	9.59	32.69	46.00	-13.31	AVG	
9		0.7740	18.59	9.60	28.19	46.00	-17.81	AVG	
10		0.7860	28.48	9.60	38.08	56.00	-17.92	QP	
11		1.2820	25.93	9.60	35.53	56.00	-20.47	QP	
12		1.2820	15.54	9.60	25.14	46.00	-20.86	AVG	

*:Maximum data x:Over limit !:over margin

EUT:	SmartShaker 2	M/N:	SmartShaker 2
Mode:	Charging	Phase:	L
Test by:	John	Power:	DC 5V by USB Port
Temperature: / Humidity	24.4°C / 50.8%	Test date:	2016-04-21

80.0 dBuV

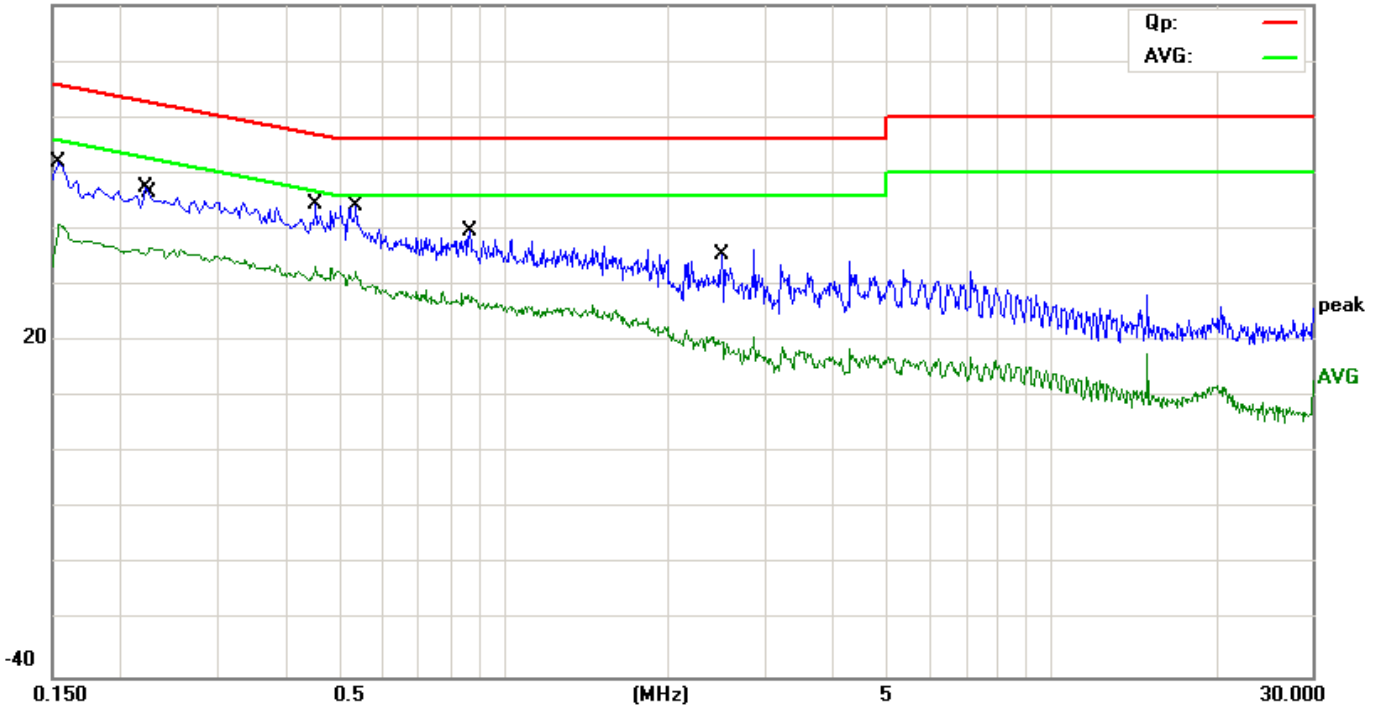

No.	Mk.	Freq. MHz	Reading Level dBuV	Correct Factor dB	Measure- ment dBuV	Limit dBuV	Over dB	Detector	Comment
1		0.1540	42.21	9.60	51.81	65.78	-13.97	QP	
2		0.1540	31.23	9.60	40.83	55.78	-14.95	AVG	
3		0.2220	37.84	9.60	47.44	62.74	-15.30	QP	
4		0.2260	27.00	9.60	36.60	52.60	-16.00	AVG	
5		0.4540	34.94	9.59	44.53	56.80	-12.27	QP	
6		0.4540	23.82	9.59	33.41	46.80	-13.39	AVG	
7	*	0.5380	34.63	9.59	44.22	56.00	-11.78	QP	
8		0.5380	22.90	9.59	32.49	46.00	-13.51	AVG	
9		0.8660	18.54	9.60	28.14	46.00	-17.86	AVG	
10		0.8700	30.02	9.60	39.62	56.00	-16.38	QP	
11		2.4700	10.52	9.61	20.13	46.00	-25.87	AVG	
12		2.5100	25.72	9.61	35.33	56.00	-20.67	QP	

*:Maximum data x:Over limit !:over margin

5.4 Radiated Emission

5.4.1 Requirement

According to FCC section 15.247(d), In addition, radiated emissions which fall in the restricted bands, as defined in §15.205(a), must also comply with the radiated emission limits specified in §15.209(a) (see §15.205(c)).

According to FCC section 15.209(a), Except as provided elsewhere in this subpart, the emissions from an intentional radiator shall not exceed the field strength levels specified in the following table:

Frequency (MHz)	Field Strength ($\mu\text{V}/\text{m}$ at 3-meter)	Test Distance (m)	Field Strength ($\text{dB}\mu\text{V}/\text{m}$ at 3-meter)
0.009 - 0.490	2400/F(kHz)	300	
0.490 - 1.705	24000/F(kHz)	30	
1.705-30	30	30	
30-88	100	3	40
88-216	150	3	43.5
216-960	200	3	46
Above 960	500	3	54

Note:

1. For Above 1000MHz, the emission limit in this paragraph is based on measurement instrumentation employing an average detector, measurement using instrumentation with a peak detector function, corresponding to 20dB above the maximum permitted average limit.
2. For above 1000MHz, limit field strength of harmonics: 54dBuV/m@3m (AV) and 74dBuV/m@3m (PK)

In addition, radiated emissions which fall in the restricted bands, as defined in §15.205(a), must also comply with the radiated emission limits specified in §15.209(a) (see §15.205(c)).

5.4.2 Test Configuration

Test Setup:

- 1) For radiated emissions from 9kHz to 30MHz

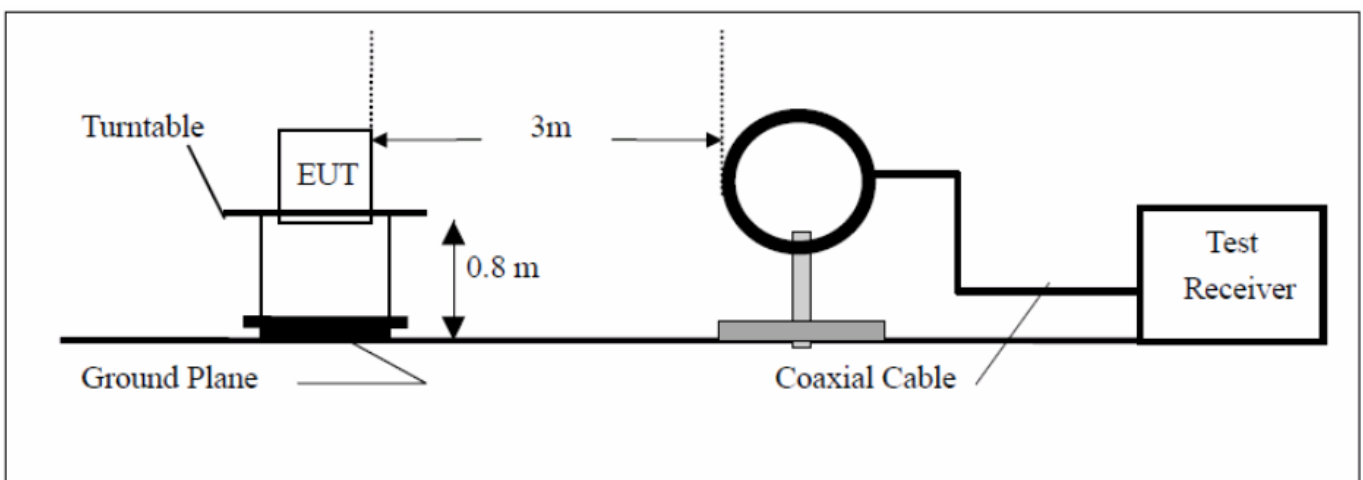

2) For radiated emissions from 30MHz to1GHz

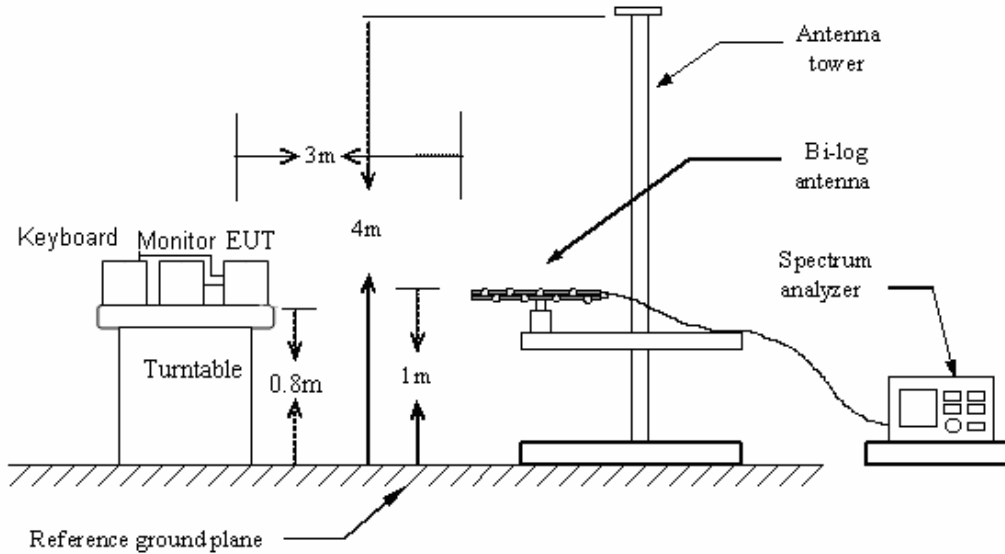

3) For radiated emissions above 1GHz

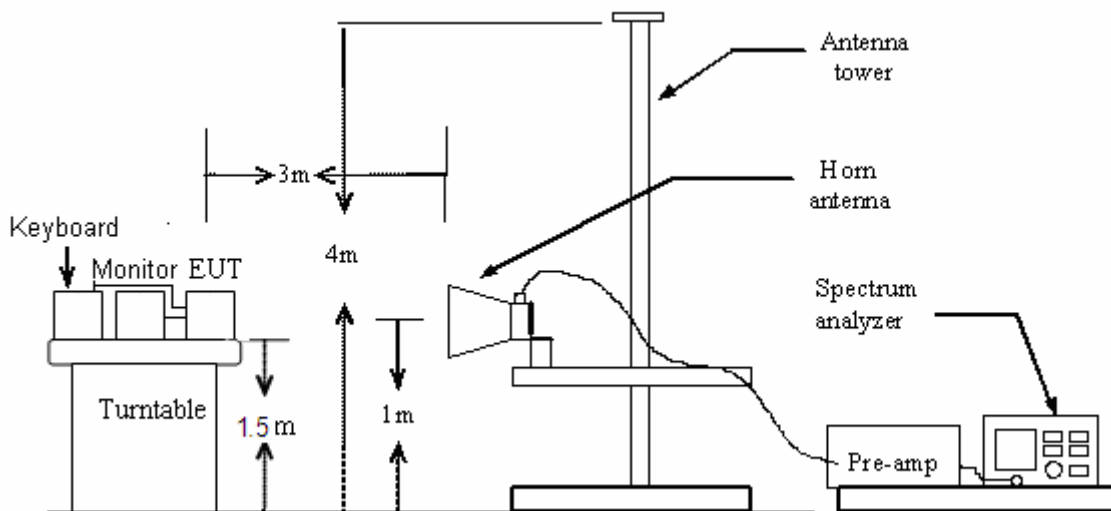
**5.4.3 Test Procedure:**

1. For frequencies above 1GHz, the frequencies of maximum emission was recorded by manually positioning the antenna close to the EUT and by moving the antenna over all sides of the EUT while observing a spectral display.
2. The EUT was placed on the top of a rotating table 1.5 meters above the ground at a 3 meter chamber. The table was rotated 360 degrees to determine the position of the highest radiation.
3. The EUT was set 3 meters away from the interference-receiving antenna, which was mounted on the top of a variable-height antenna tower.
4. The antenna height is varied from one meter to four meters above the ground to determine the maximum value of the field strength. Both horizontal and vertical polarizations of the antenna are set to make the measurement.
5. For each suspected emission, the EUT was arranged to its worst case and then the antenna was tuned to heights from 1 meter to 4 meters and the rote table was turned from 0 degrees to 360 degrees to find the maximum reading.

6. For frequencies above 1GHz, horn antenna mouth should face to the EUT all the time when rise or fall.
7. Set the spectrum analyzer in the following setting as:

Below 1GHz: PEAK: RBW=100 kHz / VBW=300 kHz / Sweep=AUTO QP: RBW=120 kHz / Sweep=AUTO

Above 1GHz: (a)PEAK: RBW=VBW=1MHz / Sweep=AUTO

(b)AVERAGE: RBW=1MHz / VBW=10Hz / Sweep=AUTO

The test-receiver system was set to Peak Detect Function and Specified Bandwidth with Maximum Hold Mode.

8. If the emission level of the EUT in peak mode was 10dB lower than the limit specified, then testing could be stopped and the peak values of the EUT would be reported. Otherwise the emissions that did not have 10dB margin would be re-tested one by one using peak, quasi-peak or average method as specified and then reported in a data sheet.

5.4.4 Test Result

Pass

Remark:

1. Pre-scan all kind of the place mode (X-axis, Y-axis, Z-axis), and found the Y-axis which it is worse case.

Please refer the following pages.

Below 1GHz

EUT:	SmartShaker 2	M/N:	SmartShaker 2
Mode:	GFSK mode	Polarization:	Horizontal
Test by:	John	Power:	DC 3.7V by Battery
Temperature: / Humidity	23.9°C/ 51.1%	Test date:	2016-04-21

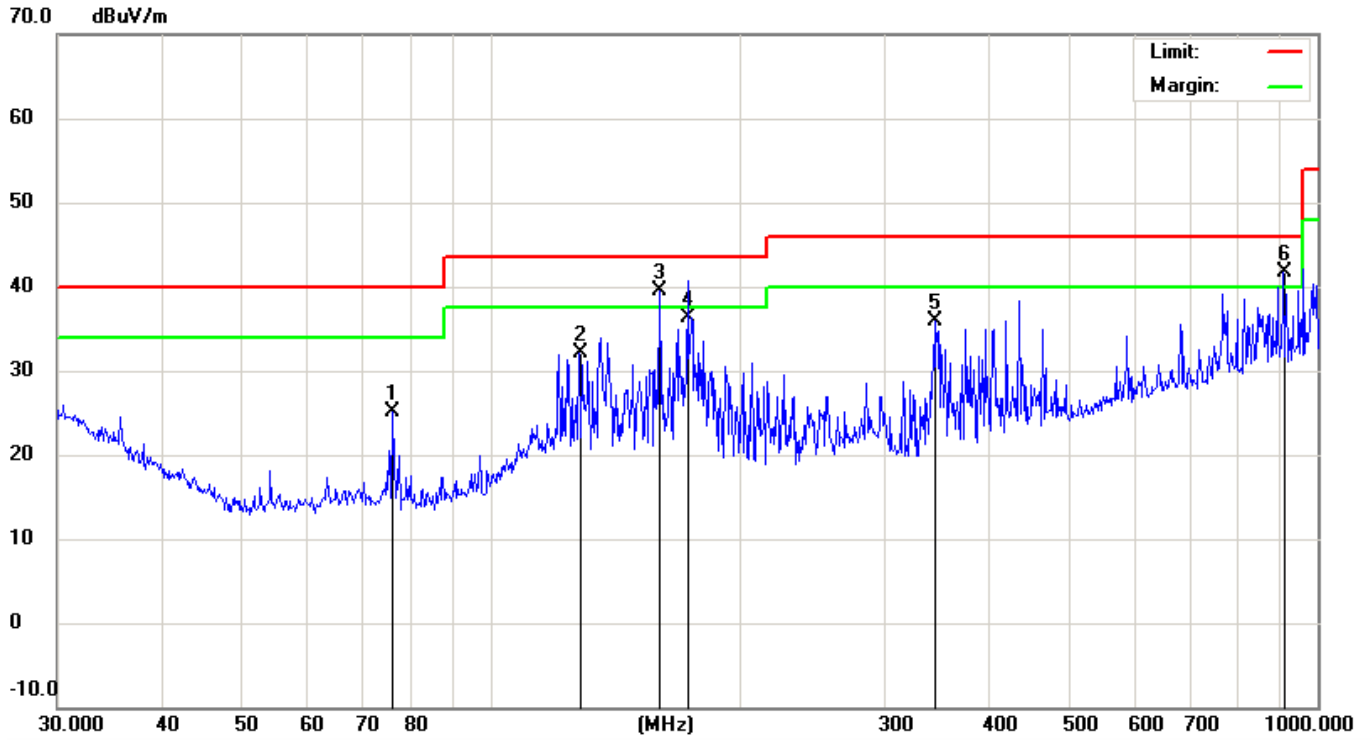

No.	Mk.	Freq.	Reading Level	Correct Factor	Measurement	Limit	Over	Antenna Height	Table Degree	
		MHz	dBuV	dB	dBuV/m	dBuV/m	dB	cm	degree	Comment
1		76.2442	13.51	11.51	25.02	40.00	-14.98	QP		
2		128.1130	14.42	17.66	32.08	43.50	-11.42	QP		
3	*	160.3456	22.14	17.30	39.44	43.50	-4.06	QP		
4		173.2051	19.30	17.04	36.34	43.50	-7.16	QP		
5		345.5952	18.33	17.49	35.82	46.00	-10.18	QP		
6	!	909.6667	14.15	27.59	41.74	46.00	-4.26	QP		

*:Maximum data x:Over limit !:over margin

EUT:	SmartShaker 2	M/N:	SmartShaker 2
Mode:	GFSK mode	Polarization:	Vertical
Test by:	John	Power:	DC 3.7V by Battery
Temperature: / Humidity	23.9°C / 51.1%	Test date:	2016-04-21

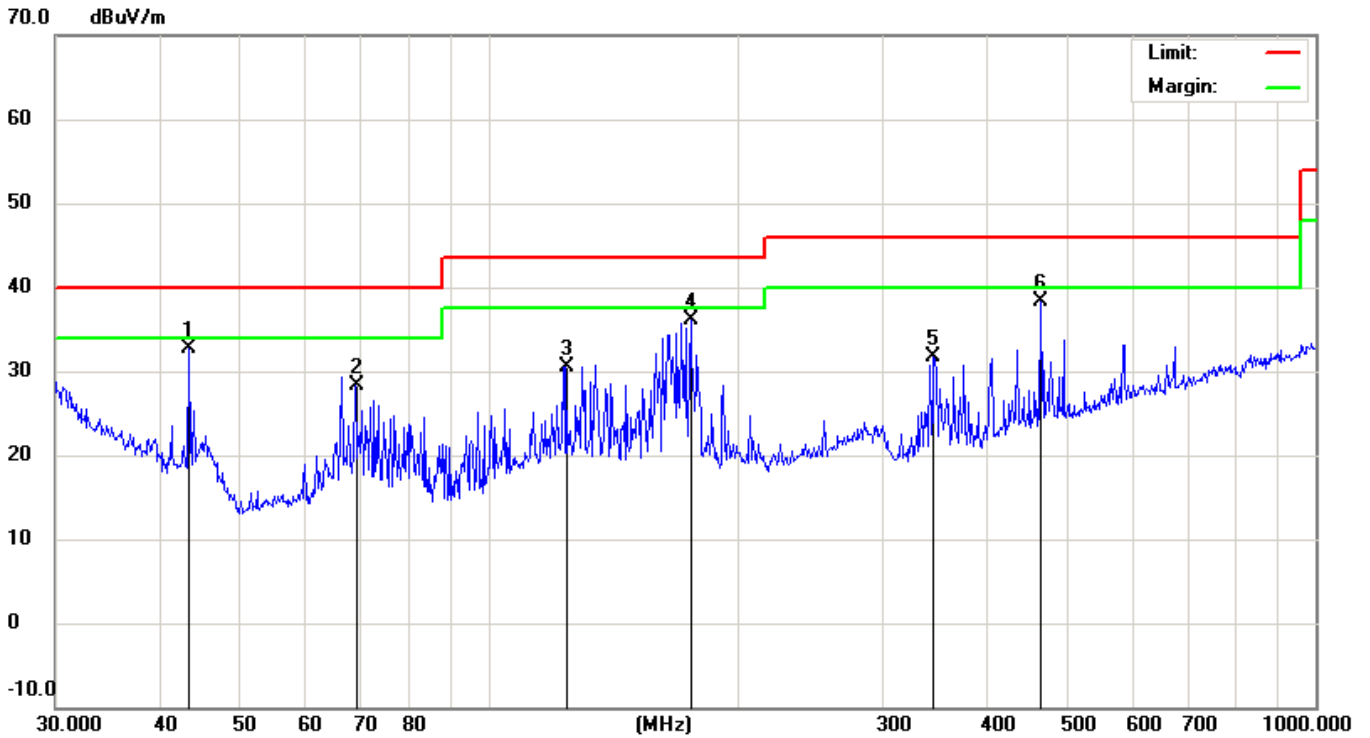

No.	Mk.	Freq. MHz	Reading Level dBuV	Correct Factor dB	Measure- ment dBuV/m	Limit dBuV/m	Over dB	Antenna Height cm	Table Degree degree	Comment
1	*	43.5057	18.75	14.00	32.75	40.00	-7.25	QP		
2		69.1141	16.64	11.62	28.26	40.00	-11.74	QP		
3		124.1330	12.92	17.58	30.50	43.50	-13.00	QP		
4		175.6516	19.18	16.91	36.09	43.50	-7.41	QP		
5		345.5952	14.15	17.49	31.64	46.00	-14.36	QP		
6		465.5994	17.40	20.85	38.25	46.00	-7.75	QP		

*:Maximum data x:Over limit !:over margin

Above 1GHz

EUT:	SmartShaker 2	M/N:	SmartShaker 2
Mode:	GFSK-CH0	Polarization:	Horizontal
Test by:	John	Power:	DC 3.7V by Battery
Temperature: / Humidity	23.7°C / 51.6%	Test date:	2016-04-21

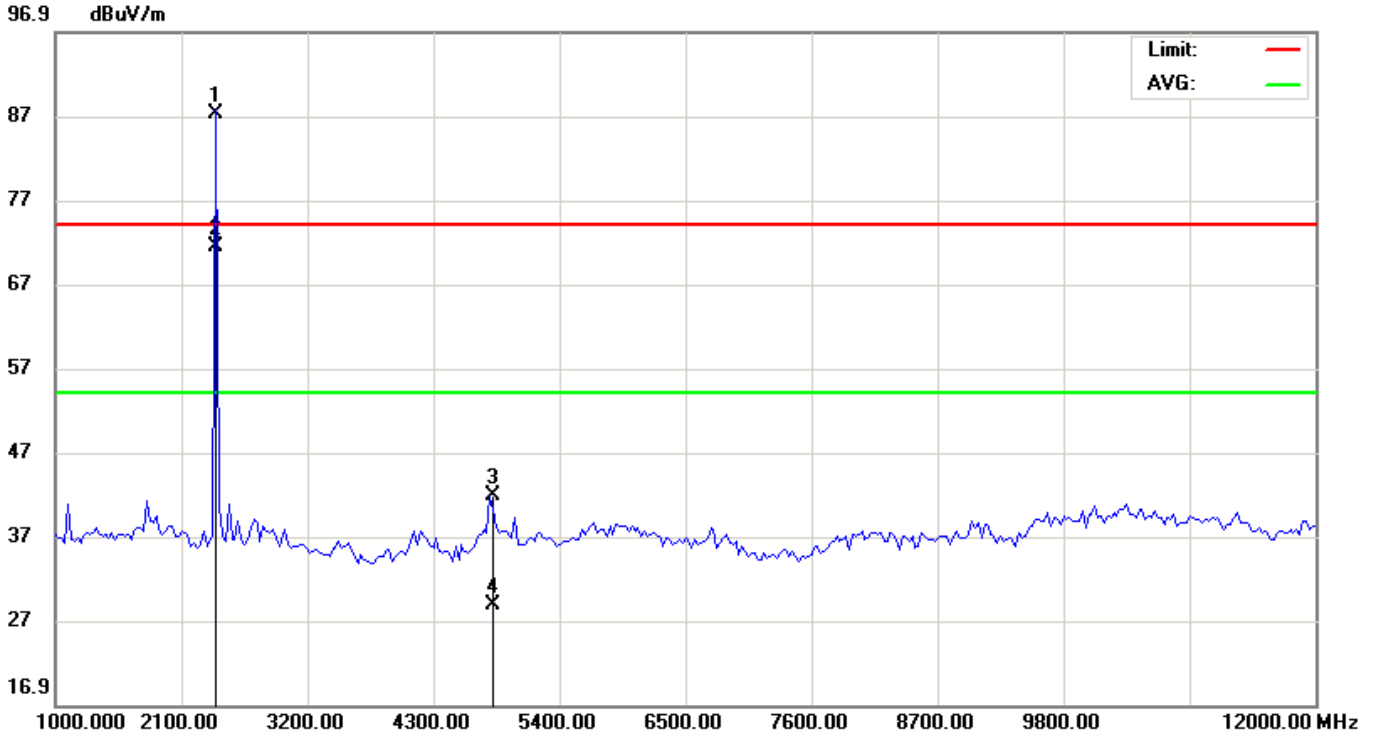

No.	Mk.	Freq.	Reading	Correct	Measure-	Limit	Over	Antenna	Table
		MHz	Level	Factor	ment			Height	Degree
			dBuV	dB	dBuV/m	dBuV/m	dB	cm	degree
1	X	2402.000	95.59	-8.43	87.16	74.00	13.16	peak	
2	*	2402.000	79.86	-8.43	71.43	54.00	17.43	AVG	
3		4804.000	48.01	-6.15	41.86	74.00	-32.14	peak	
4		4804.000	34.97	-6.15	28.82	54.00	-25.18	AVG	

*:Maximum data x:Over limit !:over margin

EUT:	SmartShaker 2	M/N:	SmartShaker 2
Mode:	GFSK-CH0	Polarization:	Horizontal
Test by:	John	Power:	DC 3.7V by Battery
Temperature: / Humidity	23.7°C / 51.6%	Test date:	2016-04-21

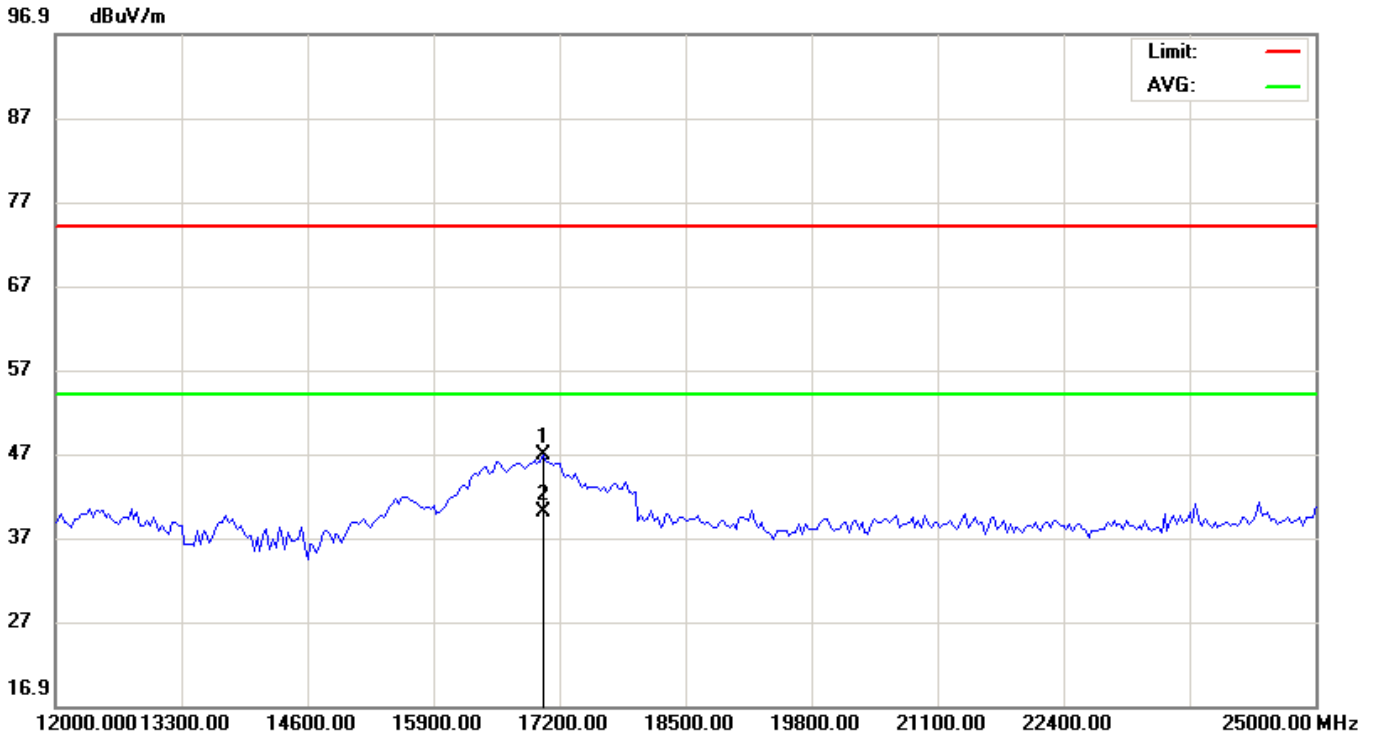

No.	Mk.	Freq. MHz	Reading Level dBuV	Correct Factor dB	Measure- ment dBuV/m	Limit dBuV/m	Over dB	Antenna Height cm	Table Degree	Comment
1		17037.50	40.03	6.73	46.76	74.00	-27.24	peak		
2	*	17037.50	33.24	6.73	39.97	54.00	-14.03	AVG		

*:Maximum data x:Over limit !:over margin

EUT:	SmartShaker 2	M/N:	SmartShaker 2
Mode:	GFSK-CH0	Polarization:	Vertical
Test by:	John	Power:	DC 3.7V by Battery
Temperature: / Humidity	23.7°C / 51.6%	Test date:	2016-04-21

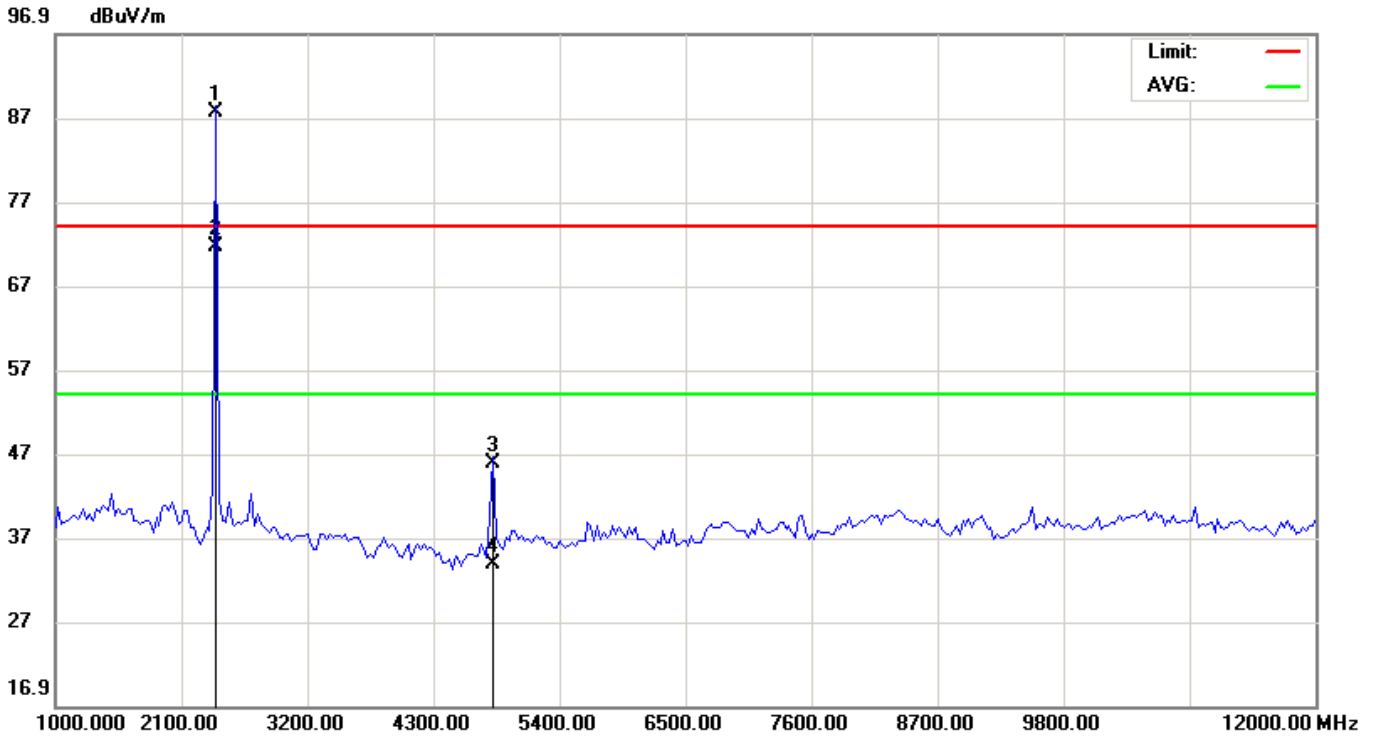

No.	Mk.	Freq. MHz	Reading Level dBuV	Correct Factor dB	Measure- ment dBuV/m	Limit dBuV/m	Over dB	Detector	Antenna Height cm	Table Degree degree	Comment
1	X	2402.000	95.96	-8.43	87.53	74.00	13.53	peak			
2	*	2402.000	79.94	-8.43	71.51	54.00	17.51	AVG			
3		4804.000	52.01	-6.15	45.86	74.00	-28.14	peak			
4		4804.000	39.87	-6.15	33.72	54.00	-20.28	AVG			

*:Maximum data x:Over limit !:over margin

EUT:	SmartShaker 2	M/N:	SmartShaker 2
Mode:	GFSK-CH0	Polarization:	Vertical
Test by:	John	Power:	DC 3.7V by Battery
Temperature: / Humidity	23.7°C / 51.6%	Test date:	2016-04-21

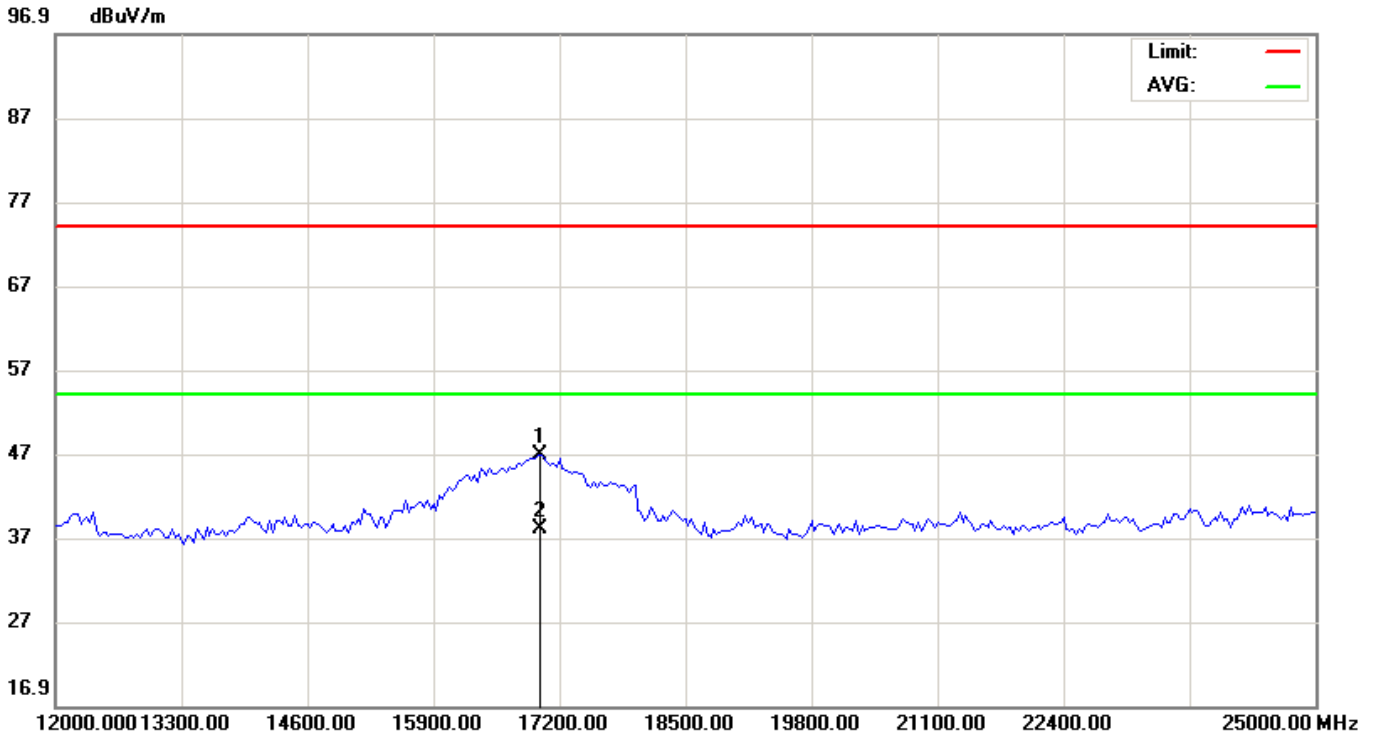

No.	Mk.	Freq. MHz	Reading Level dBuV	Correct Factor dB	Measure- ment dBuV/m	Limit dBuV/m	Over dB	Antenna Height cm	Table Degree degree	Comment
1		17005.00	39.87	6.90	46.77	74.00	-27.23	peak		
2	*	17005.00	31.04	6.90	37.94	54.00	-16.06	AVG		

*:Maximum data x:Over limit !:over margin

5.5 Conducted Peak Output Power

5.5.1 Requirement

According to FCC section 15.247(b)(3), for frequency hopping systems operating in the 2400–2483.5 MHz band employing at least 75 non-overlapping hopping channels, and all frequency hopping systems in the 5725- 5850 MHz band: 1 watt. For all other frequency hopping systems in the 2400–2483.5 MHz band: 0.125 watts

5.5.2 Block Diagram of Test Setup



5.5.3 Test Procedure

1. Place the EUT on a bench and set in transmitting mode.
2. Remove the antenna from the EUT and then connect a low loss RF cable from the antenna port to an EMI test receiver.
3. Add a correction factor to the display.

5.5.4 Test Result

Test Item:	Peak Output Power	Temperature :	21°C
Test Engineer:	Kang	Relative Humidity :	57%

Mode	Channel	Frequency (MHz)	Peak Output Power(dBm)	Limit		Pass/Fail
				(mW)	(dBm)	
GFSK	Low	2402	0.733	1000	30	Pass
	Middle	2440	-0.096	1000	30	Pass
	High	2480	0.189	1000	30	Pass

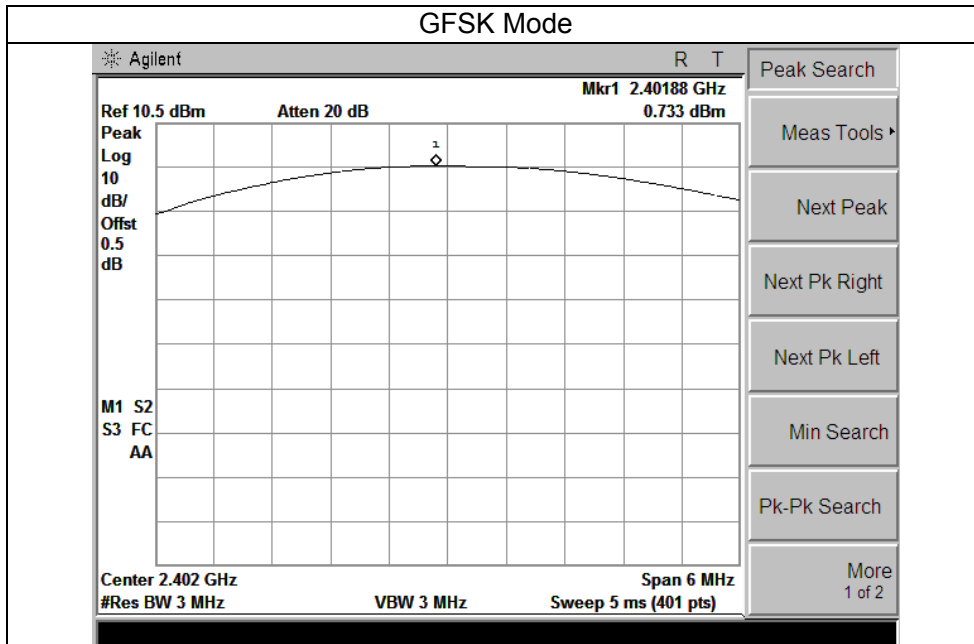

Ch 0

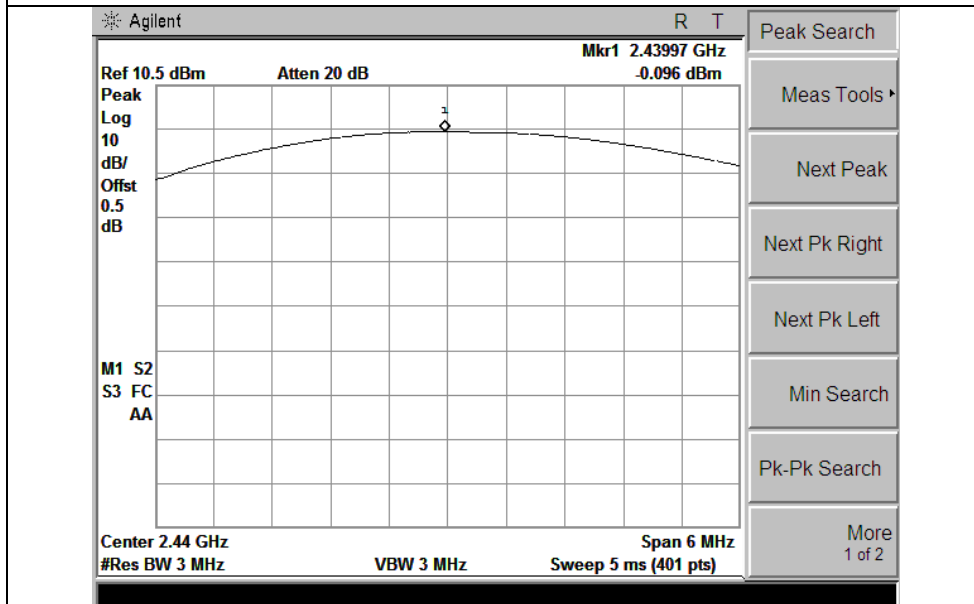

Ch 19

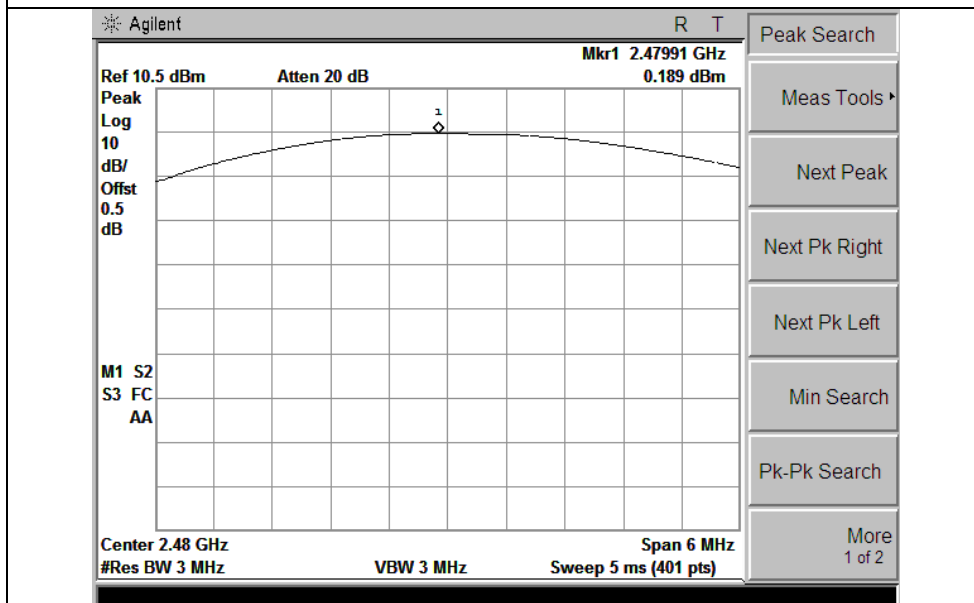

Ch 39

5.6 6dB Emission Bandwidth

5.6.1 Test Requirement

Systems using digital modulation techniques may operate in the 902–928 MHz, 2400–2483.5 MHz, and 5725–5850 MHz bands. The minimum 6 dB bandwidth shall be at least 500 kHz.

5.6.2 Block Diagram of Test Setup



5.6.3 Test Procedure

According to KDB 558074 D01 DTS Meas Guidance v03r02 clause 8.1 Option 1:

- a) Set RBW = 100 kHz.
- b) Set the video bandwidth (VBW) $\geq 3 \times$ RBW.
- c) Detector = Peak.
- d) Trace mode = max hold.
- e) Sweep = auto couple.
- f) Allow the trace to stabilize.
- g) Measure the maximum width of the emission that is constrained by the frequencies associated with the two outermost amplitude points (upper and lower frequencies) that are attenuated by 6 dB relative to the maximum level measured in the fundamental emission.

5.6.4 Test Result

Test Item:	6dB Emission Bandwidth	Temperature :	21°C
Test Engineer:	Kang	Relative Humidity :	57%

Mode	Channel	Frequency (MHz)	6dB Bandwidth(KHz)	Limit(KHz)
GFSK	Low	2402	561.340	≥ 500
	Middle	2440	565.790	≥ 500
	High	2480	561.289	≥ 500

GFSK Mode

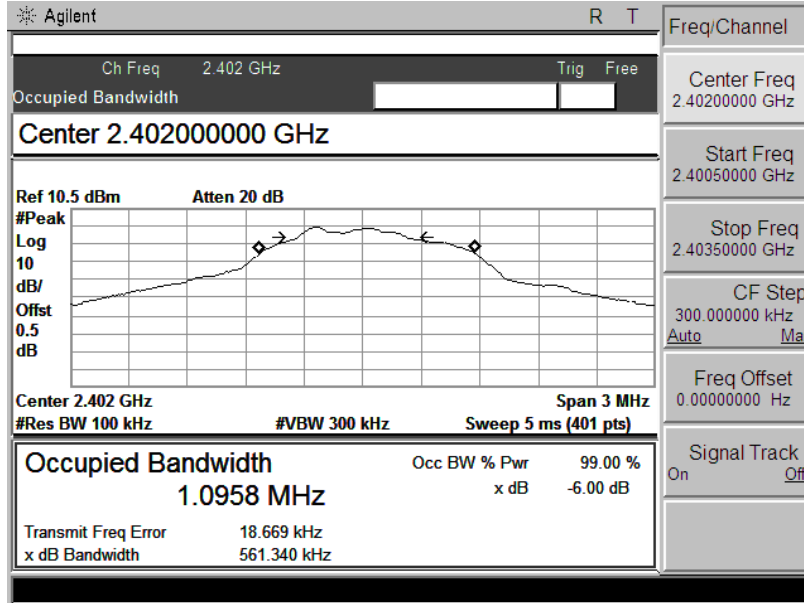

Ch 0

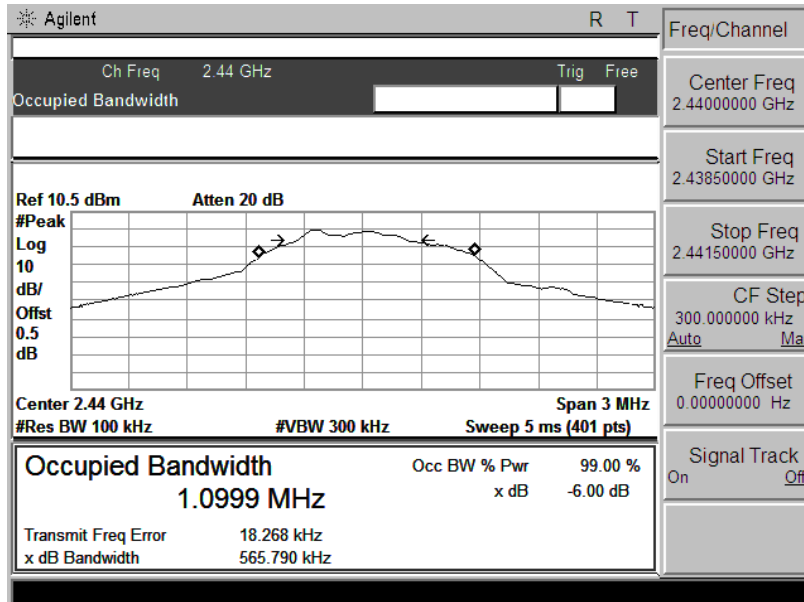

Ch 19

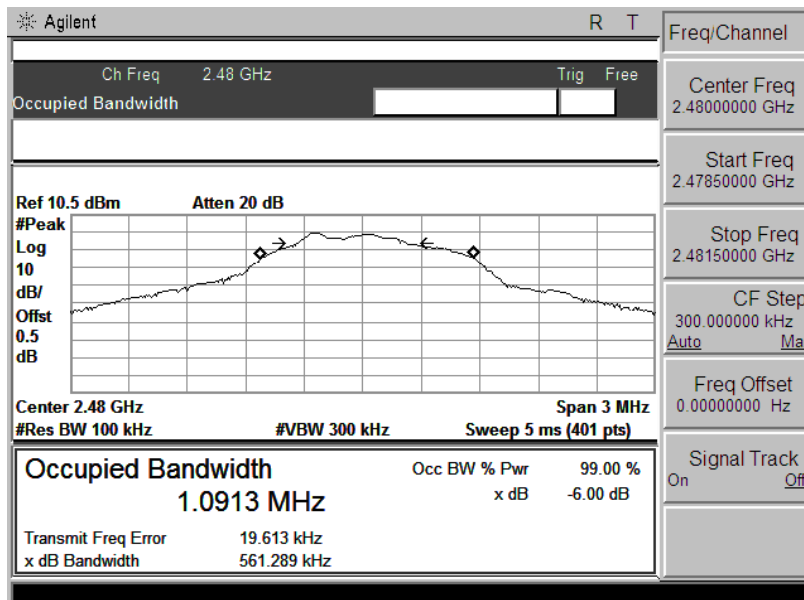

Ch 39

5.7 POWER SPECTRAL DENSITY

5.7.1 Applicable Standard

For digitally modulated systems, the power spectral density conducted from the intentional radiator to the antenna shall not be greater than 8 dBm in any 3 kHz band during any time interval of continuous transmission. This power spectral density shall be determined in accordance with the provisions of paragraph (b) of this section. The same method of determining the conducted output power shall be used to determine the power spectral density.

5.7.2 Test Procedure

According to KDB 558074 D01 DTS Meas Guidance v03r01clause10.2:

- a) Set analyzer center frequency to DTS channel center frequency.
- b) Set the span to 1.5 times the DTS bandwidth.
- c) Set the RBW to: $3 \text{ kHz} \leq \text{RBW} \leq 100 \text{ kHz}$.
- d) Set the VBW $\geq 3 \times \text{RBW}$.
- e) Detector = peak.
- f) Sweep time = auto couple.
- g) Trace mode = max hold.
- h) Allow trace to fully stabilize.
- i) Use the peak marker function to determine the maximum amplitude level within the RBW.
- j) If measured value exceeds limit, reduce RBW (no less than 3 kHz) and repeat.

5.7.3 Test Result

Test Item:	POWER SPECTRAL DENSITY	Temperature :	21°C
Test Engineer:	Kang	Relative Humidity :	57%

Mode	Channel	Frequency (MHz)	PSD (dBm/3kHz)	Limit (dBm/3kHz)	Result
GFSK	Low	2402	-17.03	≤ 8	Pass
	Middle	2440	-17.26	≤ 8	Pass
	High	2480	-17.06	≤ 8	Pass

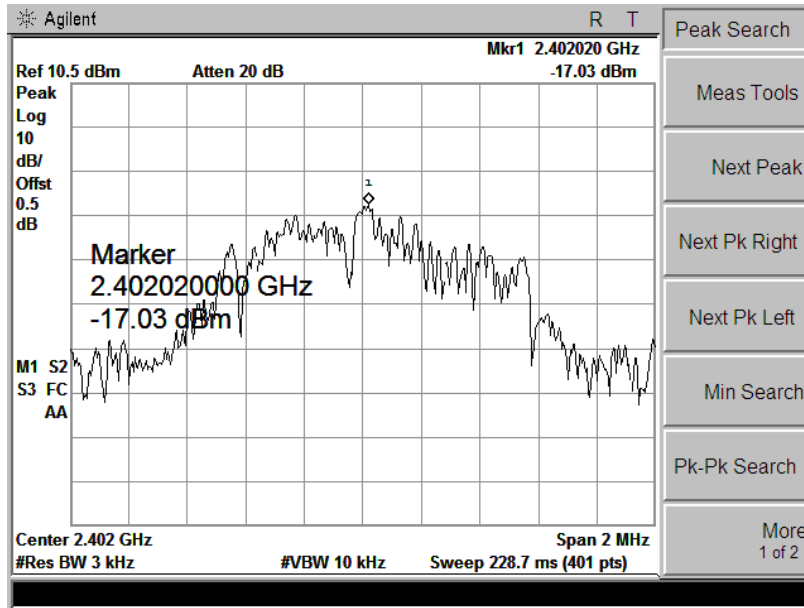

Ch 0

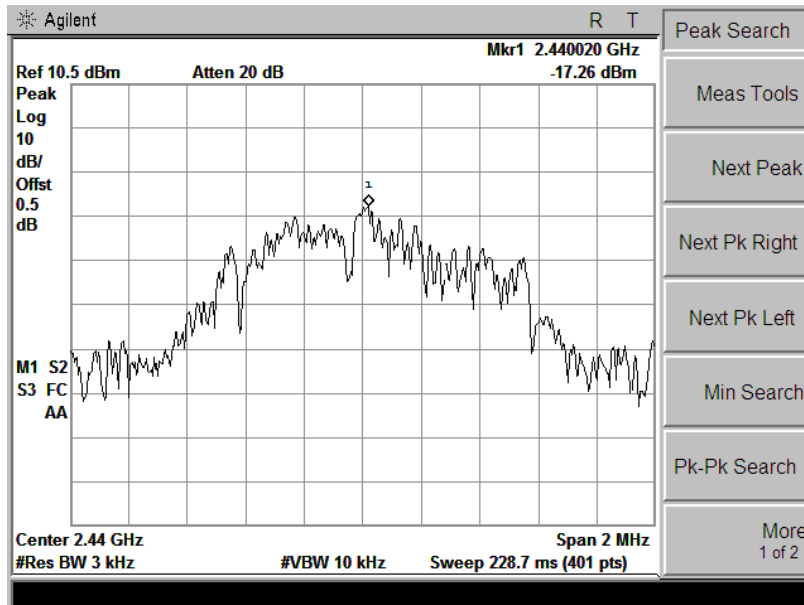

Ch 19

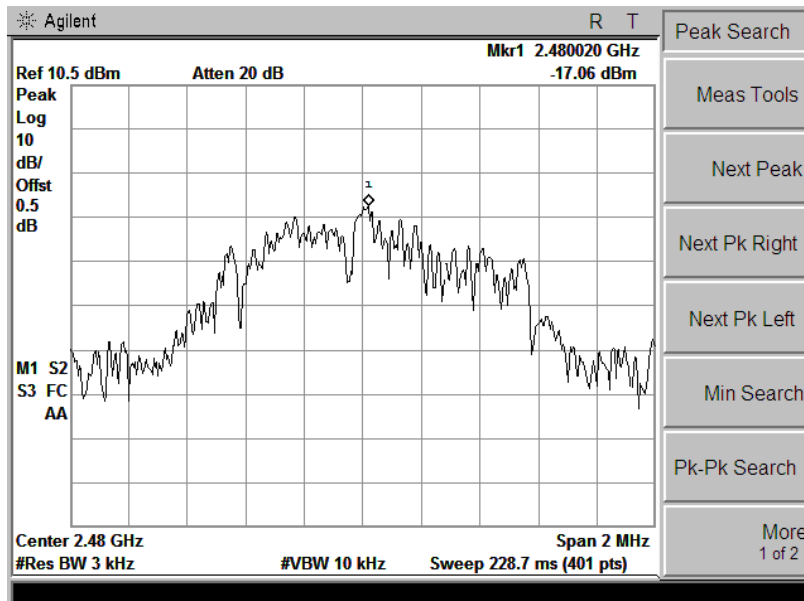

5.8 Band Edge and Conducted Spurious Emissions

5.8.1 Test Requirement

In any 100 kHz bandwidth outside the frequency band in which the spread spectrum or digitally modulated intentional radiator is operating, the radio frequency power that is produced by the intentional radiator shall be at least 20 dB below that in the 100 kHz bandwidth within the band that contains the highest level of the desired power, based on either an RF conducted or a radiated measurement, provided the transmitter demonstrates compliance with the peak conducted power limits. If the transmitter complies with the conducted power limits based on the use of RMS averaging over a time interval, as permitted under paragraph (b)(3) of this section, the attenuation required under this paragraph shall be 30 dB instead of 20 dB. Attenuation below the general limits specified in §15.209(a) is not required.

5.8.2 Test Procedure

1. Check the calibration of the measuring instrument using either an internal calibrator or a known signal from an external generator.
2. Remove the antenna from the EUT and then connect to a low loss RF cable from the antenna port to a EMI test receiver, then turn on the EUT and make it operate in transmitting mode. Then set it to Low Channel and High Channel within its operating range, and make sure the instrument is operated in its linear range.
3. Set both RBW and VBW of spectrum analyzer to 100 kHz with a convenient frequency span including 100 kHz bandwidth from band edge.
4. Measure the highest amplitude appearing on spectral display and set it as a reference level. Plot the graph with marking the highest point and edge frequency.
5. Repeat above procedures until all measured frequencies were complete.

5.8.3 Test Result

Pass

Remark:

Test Item:	Band Edge	Temperature :	21°C
Test Engineer:	Kang	Relative Humidity :	57%

GFSK Mode

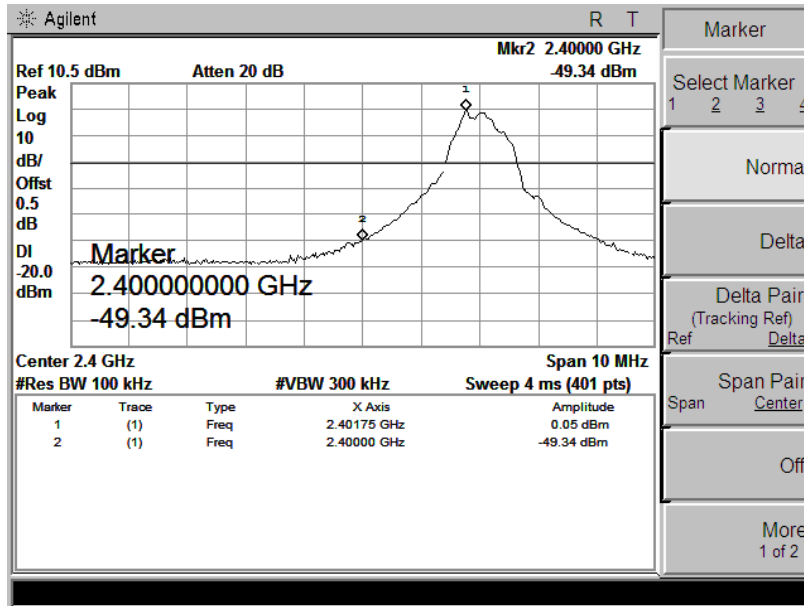

Band Edge, Left Side

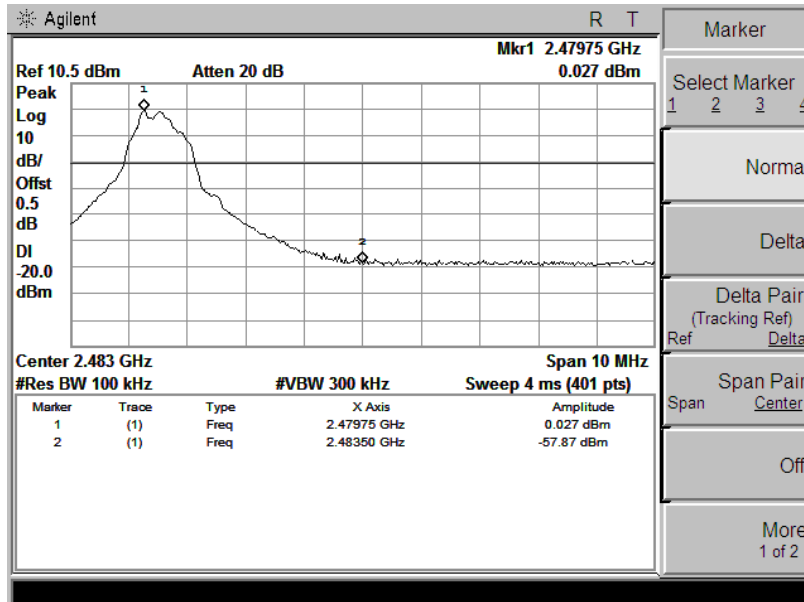

Band Edge, Right Side

Conducted Spurious Emissions

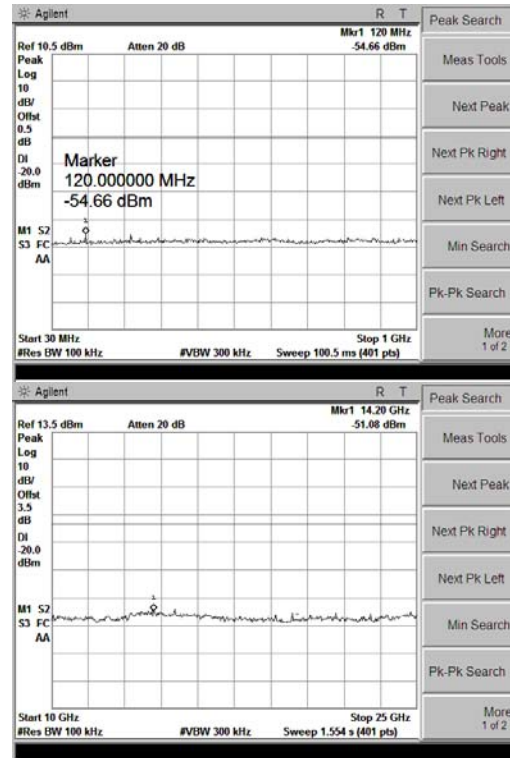
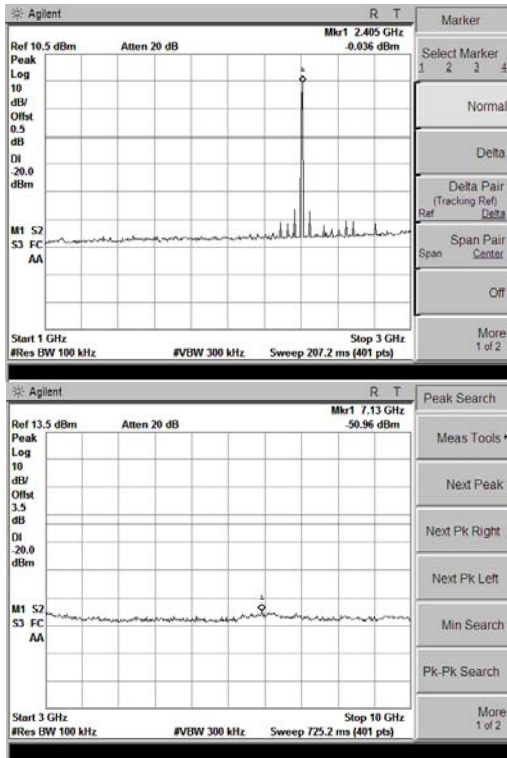

GFSK Mode, Ch0

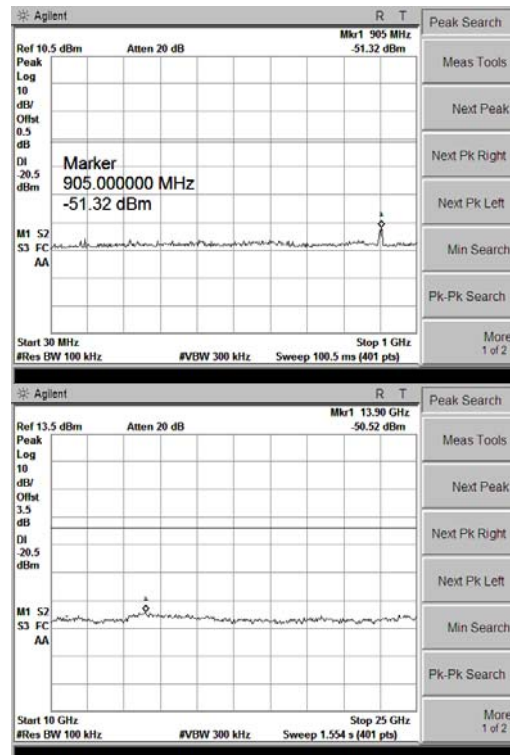
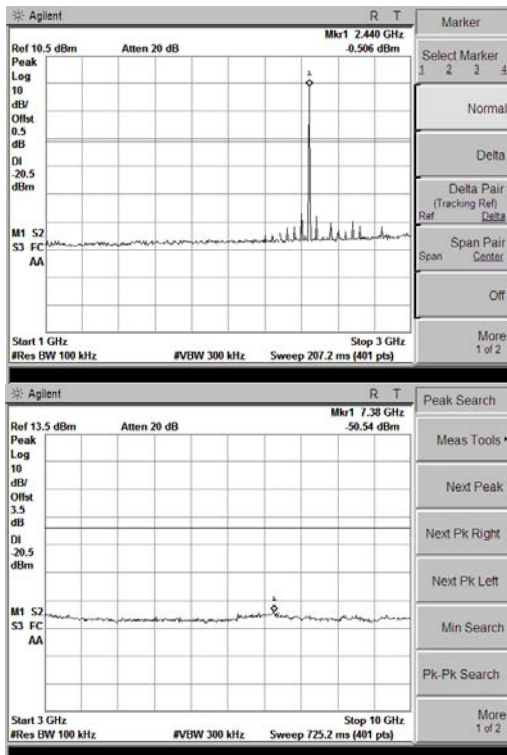

GFSK Mode, Ch19

Conducted Spurious Emissions

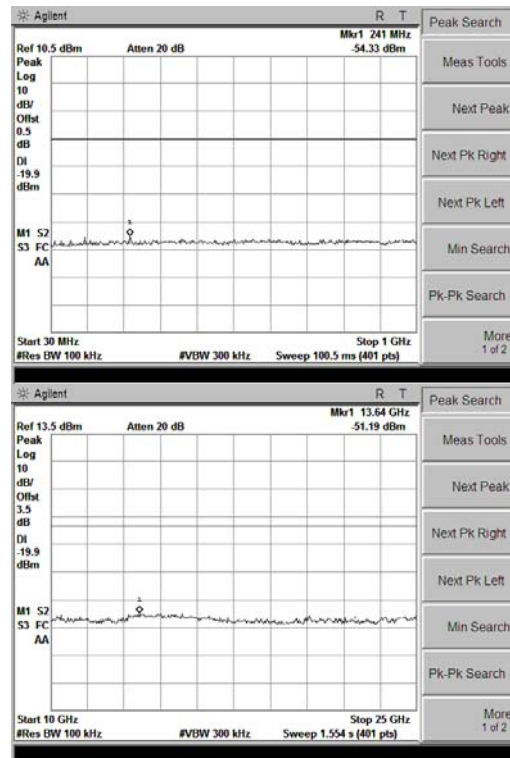
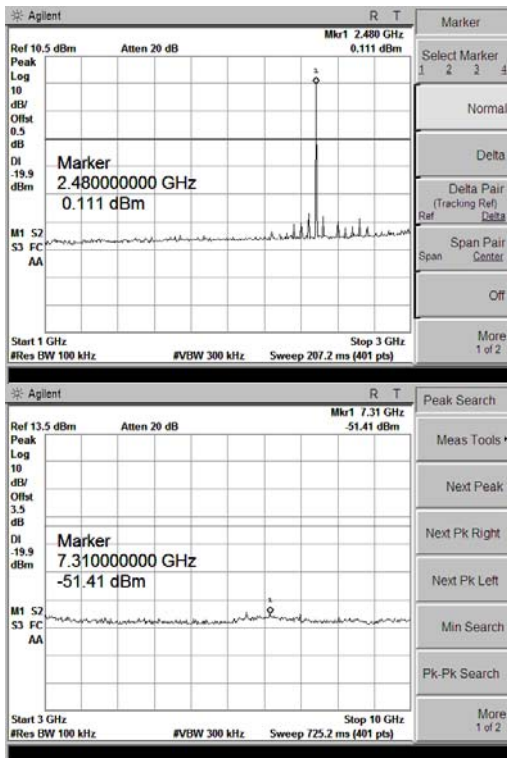

GFSK Mode, Ch39
 $\pi/4$ -DQPSK Mode, Hopping

5.9 Restricted Frequency Bands

5.9.1 Test Requirement

In any 100 kHz bandwidth outside the frequency band in which the spread spectrum or digitally modulated intentional radiator is operating, the radio frequency power that is produced by the intentional radiator shall be at least 20 dB below that in the 100 kHz bandwidth within the band that contains the highest level of the desired power. In addition, radiated emissions which fall in the restricted bands, as defined in §15.205(a), must also comply with the radiated emission limits specified in §15.209(a) (see §15.205(c)).

5.9.2 Test Configuration

Test Setup:

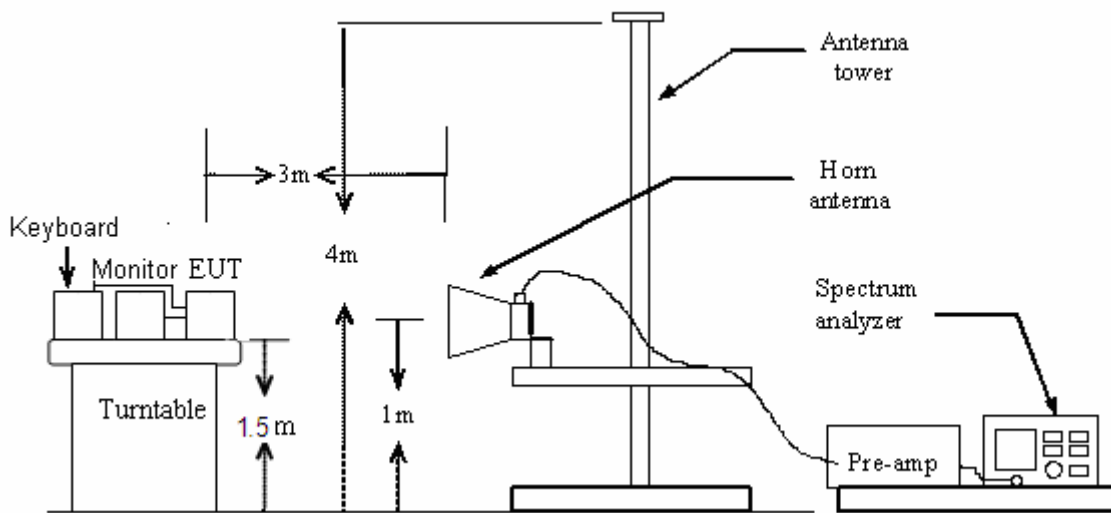

5.9.3 Test Procedure:

1. The EUT was placed on the top of a rotating table 0.8 meters above the ground at a 3 meter chamber. The table was rotated 360 degrees to determine the position of the highest radiation.
2. The EUT was set 3 meters away from the interference-receiving antenna, which was mounted on the top of a variable-height antenna tower.
3. The antenna height is varied from one meter to four meters above the ground to determine the maximum value of the field strength. Both horizontal and vertical polarizations of the antenna are set to make the measurement.
4. For each suspected emission, the EUT was arranged to its worst case and then the antenna was tuned to heights from 1 meter to 4 meters and the table was turned from 0 degrees to 360 degrees to find the maximum reading.

5.9.4 Test Result

Pass

Note: All test modes are performed, only the worst case is recorded in this report.

Please refer the following plots.

EUT:	SmartShaker 2	M/N:	SmartShaker 2
Mode:	GFSK-CH0	Phase:	Vertical
Test by:	John	Power:	DC 3.7V by Battery
Temperature: / Humidity	23.7°C / 51.6%	Test date:	2016-04-18

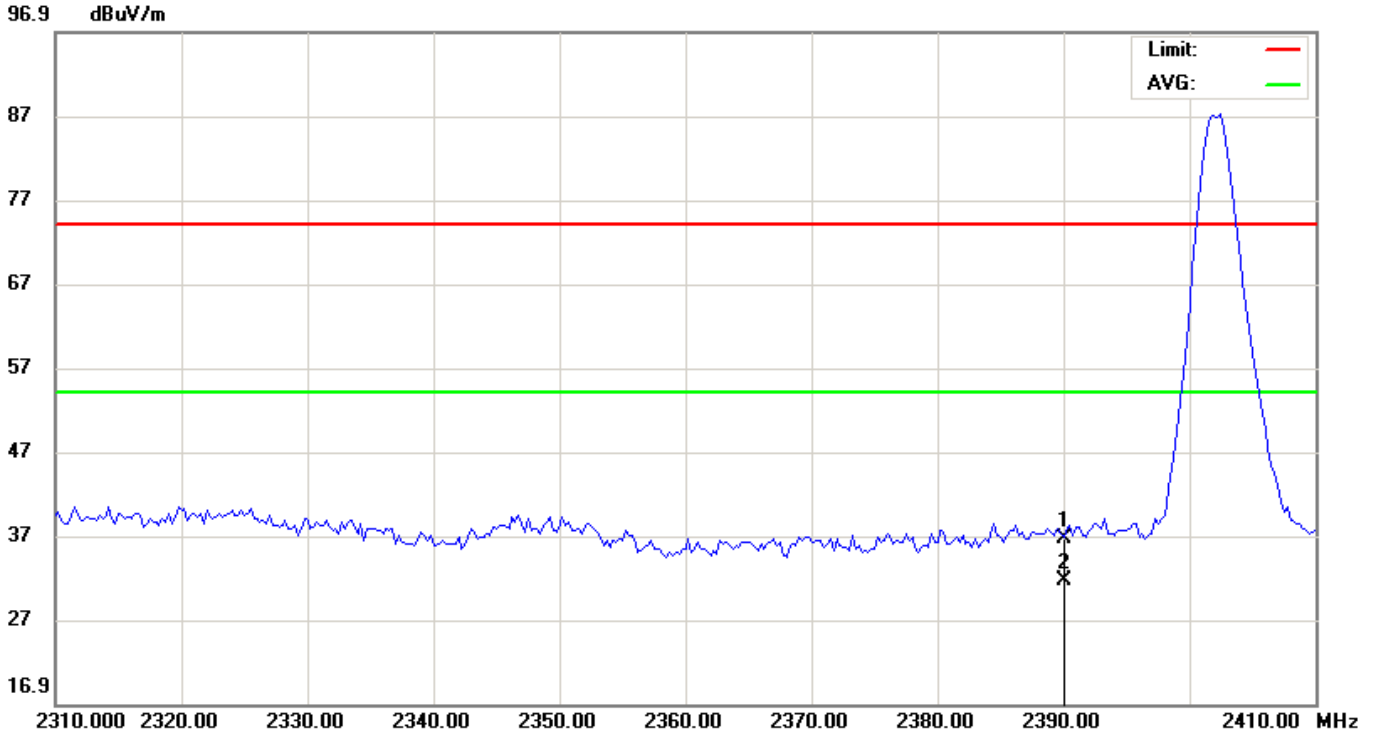

No.	Mk.	Freq. MHz	Reading Level dBuV	Correct Factor dB	Measure- ment dBuV/m	Limit dBuV/m	Over dB	Detector	Antenna Height cm	Table Degree	Comment
1		2390.000	45.02	-8.43	36.59	74.00	-37.41	peak			
2	*	2390.000	40.03	-8.43	31.60	54.00	-22.40	AVG			

*:Maximum data x:Over limit !:over margin

EUT:	SmartShaker 2	M/N:	SmartShaker 2
Mode:	GFSK-CH0	Phase:	Horizontal
Test by:	John	Power:	DC 3.7V by Battery
Temperature: / Humidity	23.7°C / 51.6%	Test date:	2016-04-18

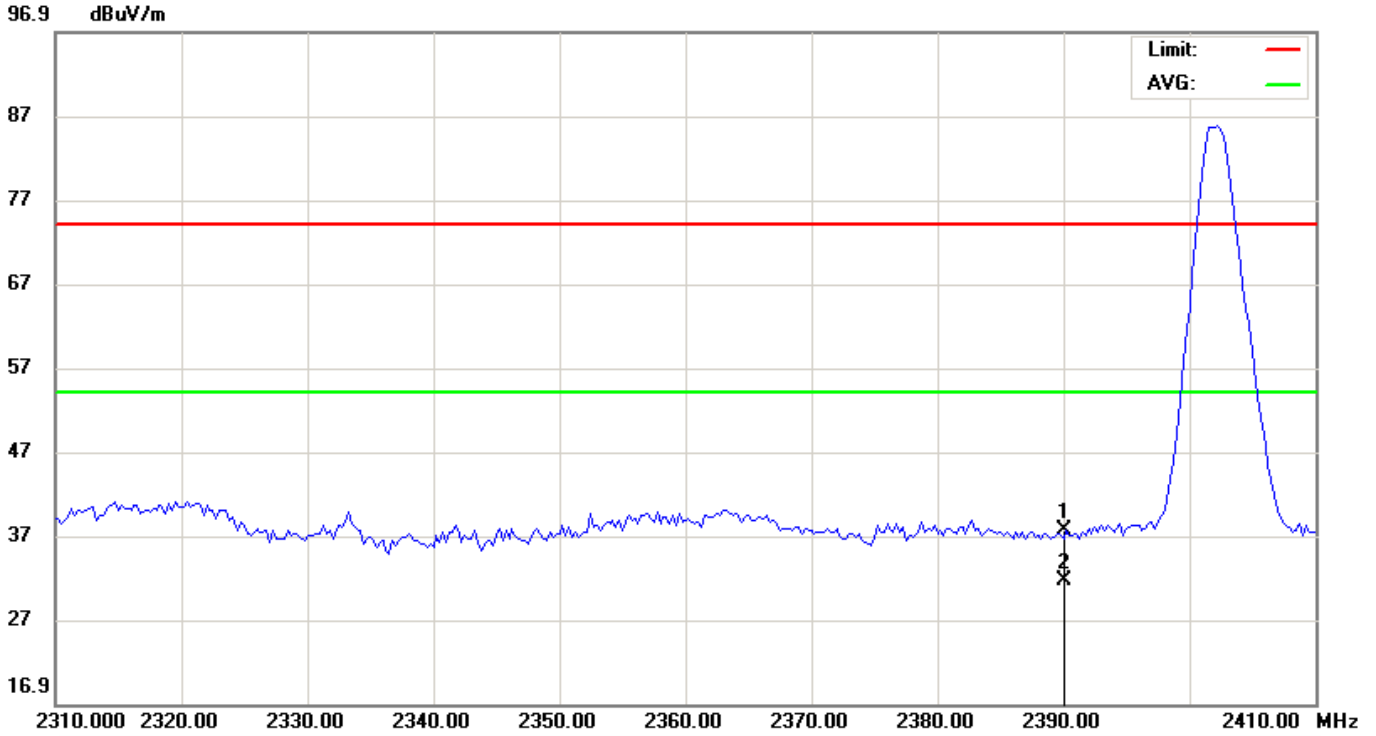

No.	Mk.	Freq.	Reading Level	Correct Factor	Measurement	Limit	Over	Antenna Height	Table Degree
		MHz	dBuV	dB	dBuV/m	dBuV/m	dB	cm	degree
1		2390.000	46.06	-8.43	37.63	74.00	-36.37	peak	
2	*	2390.000	40.01	-8.43	31.58	54.00	-22.42	AVG	

*:Maximum data x:Over limit !:over margin

EUT:	SmartShaker 2	M/N:	SmartShaker 2
Mode:	GFSK-CH78	Phase:	Vertical
Test by:	John	Power:	DC 3.7V by Battery
Temperature: / Humidity	23.7°C / 51.6%	Test date:	2016-04-18

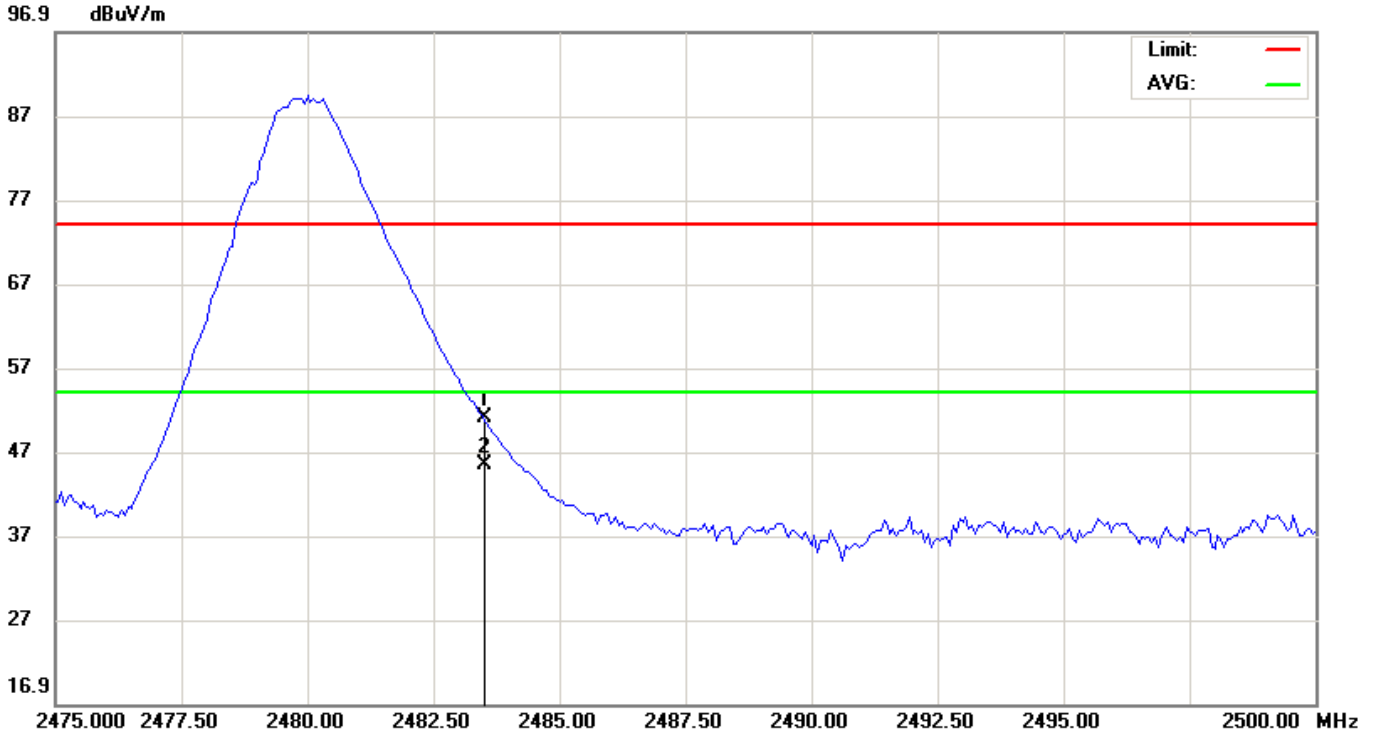

No.	Mk.	Freq. MHz	Reading Level dBuV	Correct Factor dB	Measure- ment dBuV/m	Limit dBuV/m	Over dB	Antenna Height cm	Table Degree degree	Comment
1		2483.500	59.31	-8.29	51.02	74.00	-22.98	peak		
2	*	2483.500	53.68	-8.29	45.39	54.00	-8.61	AVG		

*:Maximum data x:Over limit !:over margin

EUT:	SmartShaker 2	M/N:	SmartShaker 2
Mode:	GFSK-CH78	Phase:	Horizontal
Test by:	John	Power:	DC 3.7V by Battery
Temperature: / Humidity	23.7°C / 51.6%	Test date:	2016-04-18

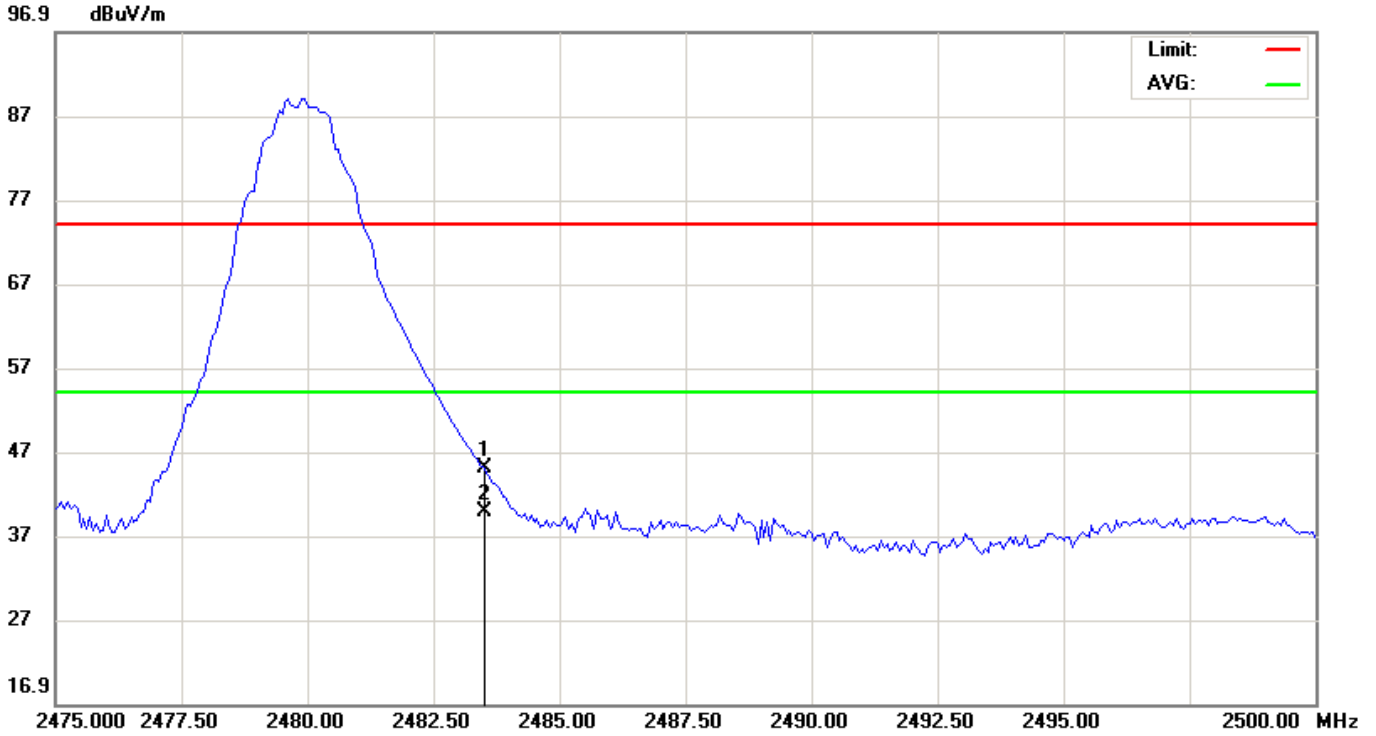

No.	Mk.	Freq.	Reading	Correct	Measure-	Limit	Over	Antenna	Table		
		MHz	Level	Factor	ment			Height	Degree		
			dBuV	dB	dBuV/m	dBuV/m	dB	Detector	cm	degree	Comment
1		2483.500	53.25	-8.29	44.96	74.00	-29.04	peak			
2	*	2483.500	48.13	-8.29	39.84	54.00	-14.16	AVG			

*:Maximum data x:Over limit !:over margin

End of Report