

---

# FCC Test Report

---

Report No.: AGC02582161002FE03

**FCC ID** : ATL-METALFORGEAIR  
**APPLICATION PURPOSE** : Original Equipment  
**PRODUCT DESIGNATION** : Bluetooth Earphone  
**BRAND NAME** : iLuv  
**MODEL NAME** : MetalForgeAir, MFAIRSG, MFAIRSI, MFAIRRG, BS152RL  
**CLIENT** : iLuv Creative Technology  
**DATE OF ISSUE** : Oct.28, 2016  
**STANDARD(S)** : FCC Part 15 Rules  
**TEST PROCEDURE(S)**  
**REPORT VERSION** : V1.0



Attestation of Global Compliance (Shenzhen) Co., Ltd

**CAUTION:**

This report shall not be reproduced except in full without the written permission of the test laboratory and shall not be quoted out of context.



**Report Revise Record**

| <b>Report Version</b> | <b>Revise Time</b> | <b>Issued Date</b> | <b>Valid Version</b> | <b>Notes</b>    |
|-----------------------|--------------------|--------------------|----------------------|-----------------|
| V1.0                  | /                  | Oct.28, 2016       | Valid                | Original Report |

## TABLE OF CONTENTS

|   |           |
|---|-----------|
| <b>1. VERIFICATION OF CONFORMITY .....</b>                        | <b>4</b>  |
| <b>2. GENERAL INFORMATION .....</b>                               | <b>5</b>  |
| 2.1. PRODUCT DESCRIPTION .....                                    | 5         |
| 2.2. TABLE OF CARRIER FREQUENCYS .....                            | 5         |
| <b>3. MEASUREMENT UNCERTAINTY .....</b>                           | <b>6</b>  |
| <b>4. DESCRIPTION OF TEST MODES .....</b>                         | <b>6</b>  |
| <b>5. SYSTEM TEST CONFIGURATION .....</b>                         | <b>8</b>  |
| 5.1. CONFIGURATION OF EUT SYSTEM .....                            | 8         |
| 5.2. EQUIPMENT USED IN EUT SYSTEM .....                           | 8         |
| 5.3. SUMMARY OF TEST RESULTS.....                                 | 8         |
| <b>6. TEST FACILITY .....</b>                                     | <b>9</b>  |
| <b>TEST METHODOLOGY .....</b>                                     | <b>9</b>  |
| <b>7. ALL TEST EQUIPMENT LIST .....</b>                           | <b>9</b>  |
| <b>8. RADIATED EMISSION.....</b>                                  | <b>11</b> |
| 8.1TEST LIMIT.....  | 11        |
| 8.2. MEASUREMENT PROCEDURE .....                                  | 12        |
| 8.3. TEST SETUP .....   | 14        |
| 8.4. TEST RESULT.....   | 16        |
| <b>9. BAND EDGE EMISSION.....</b>                                 | <b>31</b> |
| 9.1. MEASUREMENT PROCEDURE .....                                  | 31        |
| 9.2 TEST SETUP.....   | 31        |
| 9.3 RADIATED TEST RESULT.....                                     | 32        |
| <b>10. 20DB BANDWIDTH.....</b>                                    | <b>36</b> |
| 10.1. MEASUREMENT PROCEDURE .....                                 | 36        |
| 10.2. TEST SET-UP.....  | 36        |
| 10.3. LIMITS AND MEASUREMENT RESULTS.....                         | 36        |
| <b>11. FCC LINE CONDUCTED EMISSION TEST .....</b>                 | <b>43</b> |
| 11.1. LIMITS OF LINE CONDUCTED EMISSION TEST.....                 | 43        |
| 11.2. BLOCK DIAGRAM OF LINE CONDUCTED EMISSION TEST .....         | 43        |
| 11.3. PRELIMINARY PROCEDURE OF LINE CONDUCTED EMISSION TEST ..... | 44        |
| 11.4. FINAL PROCEDURE OF LINE CONDUCTED EMISSION TEST.....        | 44        |
| 11.5. TEST RESULT OF LINE CONDUCTED EMISSION TEST .....           | 45        |
| <b>APPENDIX A: PHOTOGRAPHS OF TEST SETUP .....</b>                | <b>47</b> |
| <b>APPENDIX B: PHOTOGRAPHS OF EUT .....</b>                       | <b>50</b> |

### 1. VERIFICATION OF CONFORMITY

|                                 |   |
|---------------------------------|---|
| <b>Applicant</b>                | iLuv Creative Technology  |
| <b>Address</b>                  | 2 Harbor Park Drive,Port Washington, NY 11050   |
| <b>Manufacturer</b>             | GUANGZHOU U&I TECHNOLOGY COMPANY LIMITED  |
| <b>Address</b>                  | 4th Floor, 15th Building, Vtrek Innovation Industrial Park, No. 644 Shibei Road, Panyu District, Guangzhou, China |
| <b>Product Designation</b>      | Bluetooth Earphone  |
| <b>Brand Name</b>               | iLuv  |
| <b>Test Model</b>               | MetalForgeAir   |
| <b>Series Model</b>             | MFAIRSG, MFAIRSI, MFAIRRG, BS152RL  |
| <b>Difference description</b>   | All the same except for the appearance color.   |
| <b>Date of test</b>             | Oct.17, 2016 to Oct.18, 2016  |
| <b>Deviation</b>                | None  |
| <b>Condition of Test Sample</b> | Normal  |
| <b>Report Template</b>          | AGCRT-US-BR/RF  |

We hereby certify that:

The above equipment was tested by Dongguan Precise Testing Service Co., Ltd. The test data, the energy emitted by the sample tested as described in this report is in compliance with the requirements of FCC Rules Part 15.249.

*Time Huang*

Tested By \_\_\_\_\_  
Time Huang(Huang Nanhui)      Oct.28, 2016

*Forrest Lei*

Reviewed By \_\_\_\_\_  
Forrest Lei(Lei Yonggang)      Oct.28, 2016

*Solger Zhang*

Approved By \_\_\_\_\_  
Solger Zhang(Zhang Hongyi)  
Authorized Officer      Oct.28, 2016

## 2. GENERAL INFORMATION

### 2.1. PRODUCT DESCRIPTION

A major technical description of EUT is described as following

|                            |  |
|----------------------------|--|
| <b>Operation Frequency</b> | 2.402 GHz to 2.480GHz                            |
| <b>RF Output Power</b>     | 0.38dBm(Max EIRP Power=Max radiation field-95.2) |
| <b>Bluetooth Version</b>   | V4.1   |
| <b>Modulation</b>          | GFSK ,π /4-DQPSK, 8DPSK                          |
| <b>Number of channels</b>  | 79 for BR/EDR                                    |
| <b>Hardware Version</b>    | VOA  |
| <b>Software Version</b>    | V01  |
| <b>Antenna Designation</b> | Ceramic Antenna                                  |
| <b>Antenna Gain</b>        | 2.12dBi  |
| <b>Power Supply</b>        | DC 3.7V  |

Note: 1.The USB port only be used for charging and can't be used to transfer data with PC.  
2. The model had been tested, and the Bluetooth Low Energy mode is not supported.

### 2.2. TABLE OF CARRIER FREQUENCIES

BR/EDR channel List

| Frequency Band | Channel Number | Frequency |
|----------------|----------------|-----------|
| 2400~2483.5MHZ | 0              | 2402MHZ   |
|                | 1              | 2403MHZ   |
|                | :              | :         |
|                | 38             | 2440 MHZ  |
|                | 39             | 2441 MHZ  |
|                | 40             | 2442 MHZ  |
|                | :              | :         |
|                | 77             | 2479 MHZ  |
|                | 78             | 2480 MHZ  |

### 3. MEASUREMENT UNCERTAINTY

The reported uncertainty of measurement  $y \pm U$ , where expanded uncertainty  $U$  is based on a standard uncertainty multiplied by a coverage factor of  $k=2$ , providing a level of confidence of approximately 95 %.

| No. | Item                    | Uncertainty   |
|-----|-------------------------|---------------|
| 1   | Conducted Emission Test | $\pm 3.18$ dB |
| 2   | All emissions, radiated | $\pm 3.91$ dB |
| 3   | Temperature             | $\pm 0.5$ °C  |
| 4   | Humidity                | $\pm 2$ %     |

### 4. DESCRIPTION OF TEST MODES

| NO. | TEST MODE DESCRIPTION         |
|-----|-------------------------------|
| 1   | Low channel GFSK              |
| 2   | Middle channel GFSK           |
| 3   | High channel GFSK             |
| 4   | Low channel $\pi/4$ -DQPSK    |
| 5   | Middle channel $\pi/4$ -DQPSK |
| 6   | High channel $\pi/4$ -DQPSK   |
| 7   | Low channel 8DPSK             |
| 8   | Middle channel 8DPSK          |
| 9   | High channel 8DPSK            |
| 10  | BT Link with charging         |
| 11  | BT Link                       |

Note:

1. All the test modes can be supply by battery, only the result of the worst case was recorded in the report, if no other cases.
2. For Radiated Emission, 3axis were chosen for testing for each applicable mode.
3. The EUT used fully-charged battery when tested.

### Software Setting

The screenshot displays the BlueTest3 software interface. The window title is "BlueTest3". It is divided into several sections:

- Test Mode:** A list of test modes including PAUSE, RADIO STATUS, RADIO STATUS FULL, TXSTART, TXDATA1 (highlighted), TXDATA2, TXDATA3, TXDATA4, RXSTART1, RXSTART2, and RXDATA1.
- Test Arguments:** Fields for "LO Freq. (MHz)" set to 2402 and "Power (Ext, Int)" set to 255 and 63.
- Buttons:** "Close", "Execute", "Cold Reset", and "Warm Reset".
- Test Results:** A section with a "Save to file" checkbox, a "Browse for file" button, and a "Display" section with radio buttons for "Standard" (selected) and "Bit Error". Below this is a text field containing ".\logfile.txt".
- Output Log:** A large text area at the bottom showing the following log output:

```
Opening USB SFI (602250).
Transport active.
da1 (Hardware ID 0x332) firmware version 8648.
Sent Command Varid 5004, parameters: 0017 0004 001B 0000 0000 0000
Radio Test CFG PKT successful
Sent Command Varid 5004, parameters: 0017 0003 0011 0000 0000 0000
Radio Test CFG PKT successful
Sent Command Varid 5004, parameters: 0004 0962 FF32 0000 0000 0000
Radio Test TXDATA1 successful
Sent Command Varid 5004, parameters: 0004 0962 FF3C 0000 0000 0000
Radio Test TXDATA1 successful
Sent Command Varid 5004, parameters: 0004 0962 FF3F 0000 0000 0000
Radio Test TXDATA1 successful
```

## 5. SYSTEM TEST CONFIGURATION

### 5.1. CONFIGURATION OF EUT SYSTEM

Configure 1: (Normal hopping)

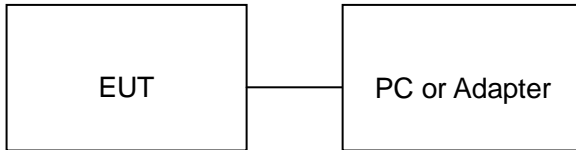

**Note:** Owing to the EUT has own battery, Testing will be performed while PC or adapter remove.

Configure 2: (Control continuous TX)

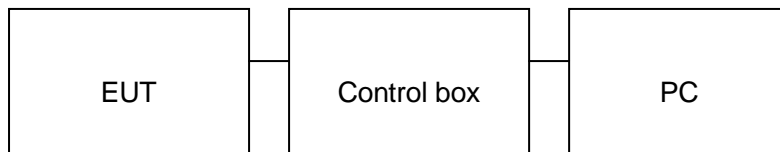

### 5.2. EQUIPMENT USED IN EUT SYSTEM

| Item | Equipment          | Mfr/Brand | Model/Type No.  | Remark    |
|------|--------------------|-----------|-----------------|-----------|
| 1    | Bluetooth Earphone | iLuv      | MetalForgeAir   | EUT       |
| 2    | Battery            | CEL       | 351025          | Accessory |
| 3    | PC                 | Sony      | E1412AYCW       | A.E       |
| 4    | Control box        | CSR       | N/A             | A.E       |
| 5    | Adapter            | ETPCA     | ETPCA-050100U3W | A.E       |

### 5.3. SUMMARY OF TEST RESULTS

| FCC RULES | DESCRIPTION OF TEST | RESULT    |
|-----------|---------------------|-----------|
| §15.249   | Radiated Emission   | Compliant |
| §15.249   | Band Edges          | Compliant |
| §15.207   | Conduction Emission | Compliant |
| §15.215   | Bandwidth           | Compliant |



## 6. TEST FACILITY

|                             |  |
|-----------------------------|--|
| <b>Site</b>                 | Dongguan Precise Testing Service Co., Ltd.   |
| <b>Location</b>             | Building D, Baoding Technology Park, Guangming Road2, Dongcheng District, Dongguan, Guangdong, China,  |
| <b>FCC Registration No.</b> | 371540   |
| <b>Description</b>          | The test site is constructed and calibrated to meet the FCC requirements in documents ANSI C63.4:2014. |

## TEST METHODOLOGY

All measurements contained in this report were conducted with ANSI C63.10-2013

## 7. ALL TEST EQUIPMENT LIST

FOR RADIATED EMISSION TEST (BELOW 1GHZ)

| Radiated Emission Test Site         |                 |              |               |                  |                 |
|-------------------------------------|-----------------|--------------|---------------|------------------|-----------------|
| Name of Equipment                   | Manufacturer    | Model Number | Serial Number | Last Calibration | Due Calibration |
| EMI Test Receiver                   | Rohde & Schwarz | ESCI         | 101417        | July 4, 2016     | July 3, 2017    |
| Trilog Broadband Antenna (25M-1GHz) | SCHWARZBECK     | VULB9160     | 9160-3355     | July 4, 2016     | July 3, 2017    |
| Signal Amplifier                    | SCHWARZBECK     | BBV 9475     | 9745-0013     | July 4, 2016     | July 3, 2017    |
| RF Cable                            | SCHWARZBECK     | AK9515E      | 96221         | July 4, 2016     | July 3, 2017    |
| 3m Anechoic Chamber                 | CHENGYU         | 966          | PTS-001       | June 6, 2016     | June 5, 2017    |
| MULTI-DEVICE Positioning Controller | Max-Full        | MF-7802      | MF780208339   | N/A              | N/A             |
| Active loop antenna (9K-30MHz)      | Schwarzbeck     | FMZB1519     | 1519-038      | June 6, 2016     | June 5, 2017    |
| Spectrum analyzer                   | Agilent         | E4407B       | MY46185649    | June 6, 2016     | June 5, 2017    |
| Radiation Cable 1                   | MXT             | RS1          | R005          | June 6, 2016     | June 5, 2017    |
| Radiation Cable 2                   | MXT             | RS1          | R006          | June 6, 2016     | June 5, 2017    |

FOR RADIATED EMISSION TEST (1GHZ ABOVE)

| Radiated Emission Test Site         |                 |              |               |                  |                 |
|-------------------------------------|-----------------|--------------|---------------|------------------|-----------------|
| Name of Equipment                   | Manufacturer    | Model Number | Serial Number | Last Calibration | Due Calibration |
| EMI Test Receiver                   | Rohde & Schwarz | ESCI         | 101417        | July 4, 2016     | July 3, 2017    |
| Horn Antenna (1G-18GHz)             | SCHWARZBECK     | BBHA9120D    | 9120D-1246    | July 11, 2016    | July 10, 2017   |
| Spectrum Analyzer                   | Agilent         | E4411B       | MY4511453     | July 4, 2016     | July 3, 2017    |
| Signal Amplifier                    | SCHWARZBECK     | BBV 9718     | 9718-269      | July 7, 2016     | July 6, 2017    |
| RF Cable                            | SCHWARZBECK     | AK9515H      | 96220         | July 8, 2016     | July 7, 2017    |
| 3m Anechoic Chamber                 | CHENGYU         | 966          | PTS-001       | June 6, 2016     | June 5, 2017    |
| MULTI-DEVICE Positioning Controller | Max-Full        | MF-7802      | MF780208339   | N/A              | N/A             |
| Horn Ant (18G-40GHz)                | Schwarzbeck     | BBHA 9170    | 9170-181      | June 6, 2016     | June 5, 2017    |
| Radiation Cable 1                   | MXT             | RS1          | R005          | June 6, 2016     | June 5, 2017    |
| Radiation Cable 2                   | MXT             | RS1          | R006          | June 6, 2016     | June 5, 2017    |

| Conducted Emission Test Site   |                 |              |               |                  |                 |
|--------------------------------|-----------------|--------------|---------------|------------------|-----------------|
| Name of Equipment              | Manufacturer    | Model Number | Serial Number | Last Calibration | Due Calibration |
| EMI Test Receiver              | Rohde & Schwarz | ESCI         | 101417        | July 4, 2016     | July 3, 2017    |
| Artificial Mains Network       | Narda           | L2-16B       | 000WX31025    | July 8, 2016     | July 7, 2017    |
| Artificial Mains Network (AUX) | Narda           | L2-16B       | 000WX31026    | July 8, 2016     | July 7, 2017    |
| RF Cable                       | SCHWARZBECK     | AK9515E      | 96222         | July 4, 2016     | July 3, 2017    |
| Shielded Room                  | CHENGYU         | 843          | PTS-002       | June 6, 2016     | June 5, 2017    |
| Conduction Cable               | MXT             | SE1          | S003          | June 6, 2016     | June 5, 2017    |

## 8. RADIATED EMISSION

### 8.1 TEST LIMIT

#### Standard FCC15.249

| Fundamental Frequency | Field Strength of Fundamental (millivolts/meter) | Field Strength of Harmonics (microvolts/meter) |
|-----------------------|--|--|
| 900-928MHz            | 50   | 500  |
| 2400-2483.5MHz        | 50   | 500  |
| 5725-5875MHz          | 50   | 500  |
| 24.0-24.25GHz         | 250  | 2500   |

#### Standard FCC 15.209

| Frequency (MHz) | Distance Meters | Field Strengths Limit  |                |
|-----------------|-----------------|--|----------------|
|                 |                 | $\mu$ V/m  | dB( $\mu$ V)/m |
| 0.009 ~ 0.490   | 300             | 2400/F(kHz)  | ---            |
| 0.490 ~ 1.705   | 30              | 24000/F(kHz)   | ---            |
| 1.705 ~ 30      | 30              | 30   | ---            |
| 30 ~ 88         | 3               | 100  | 40.0           |
| 88 ~ 216        | 3               | 150  | 43.5           |
| 216 ~ 960       | 3               | 200  | 46.0           |
| 960 ~ 1000      | 3               | 500  | 54.0           |
| Above 1000      | 3               | Other:74.0 dB( $\mu$ V)/m (Peak) 54.0 dB( $\mu$ V)/m (Average) |                |

Remark: (1) Emission level  $\text{dB}\mu\text{V} = 20 \log \text{Emission level } \mu\text{V/m}$   
(2) The smaller limit shall apply at the cross point between two frequency bands.  
(3) Distance is the distance in meters between the measuring instrument, antenna and the closest point of any part of the device or system.

## 8.2. MEASUREMENT PROCEDURE

1. The measuring distance of 3m shall be used for measurements. The EUT was placed on the top of a rotating table 0.8 meter above the ground at a 3 meter semi-anechoic chamber. The table was rotated 360 degrees to determine the position of the highest radiation(Below 1GHz)
2. The measuring distance of 3m shall used for measurements. The EUT was placed on the top of a rotating table 1.5 meter above the ground at a 3 meter semi-anechoic chamber. The table was rotated 360 degrees to determine the position of the highest radiation(Above 1GHz)
3. The height of the test antenna shall vary between 1m to 4m.Both horizontal and vertical polarization Of the antenna are set to make the measurement.
4. The initial step in collecting radiated emission data is a receive peak detector mode. Pre-scanning the measurement frequency range. Significant peaks are then marked and then Quasi Peak detector mode re-measured.
5. All readings are peak unless otherwise stated QP in column of Note. Peak denoted that the Peak reading compliance with the QP limits and then QP Mode measurement didn't perform(Below 1GHz)
6. All readings are Peak mode value unless otherwise stated AVG in column of Note. If the Peak mode measured value compliance with the Peak limits and lower than AVG Limits, the EUT shall be deemed to meet Peak&AVG limits and then only Peak mode was measured, but AVG mode didn't perform.(Above 1GHz)

The following table is the setting of spectrum analyzer and receiver.

| <b>Spectrum Parameter</b> | <b>Setting</b>  |
|---------------------------|---|
| Start ~Stop Frequency     | 9KHz~150KHz/RB 200Hz for QP                               |
| Start ~Stop Frequency     | 150KHz~30MHz/RB 9KHz for QP                               |
| Start ~Stop Frequency     | 30MHz~1000MHz/RB 120KHz for QP                            |
| Start ~Stop Frequency     | 1GHz~26.5GHz<br>1MHz/3MHz for Peak, 1MHz/10Hz for Average |
| <b>Receiver Parameter</b> | <b>Setting</b>  |
| Start ~Stop Frequency     | 9KHz~150KHz/RB 200Hz for QP                               |
| Start ~Stop Frequency     | 150KHz~30MHz/RB 9KHz for QP                               |
| Start ~Stop Frequency     | 30MHz~1000MHz/RB 120KHz for QP                            |

### 8.3. TEST SETUP

Radiated Emission Test-Setup Frequency Below 30MHz

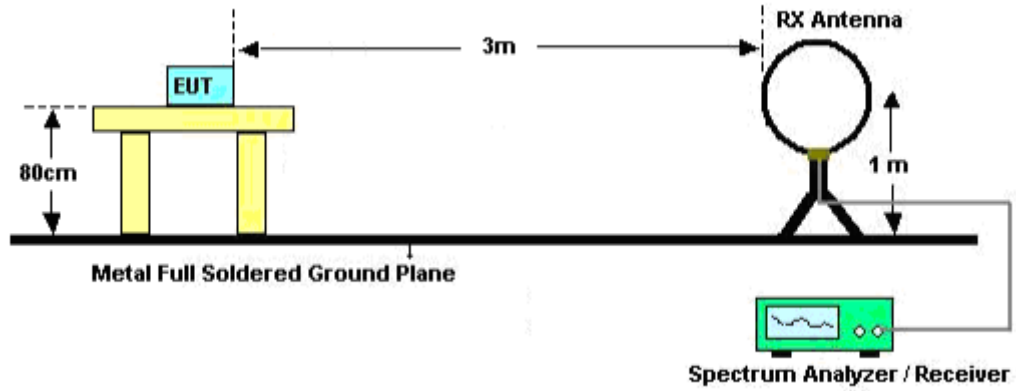

RADIATED EMISSION TEST SETUP 30MHz-1000MHz

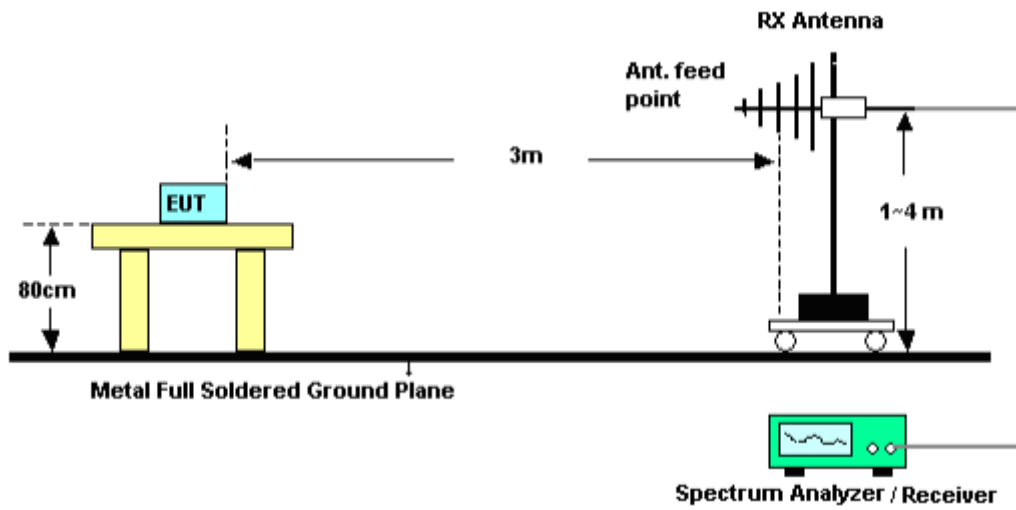

### RADIATED EMISSION TEST SETUP ABOVE 1000MHz

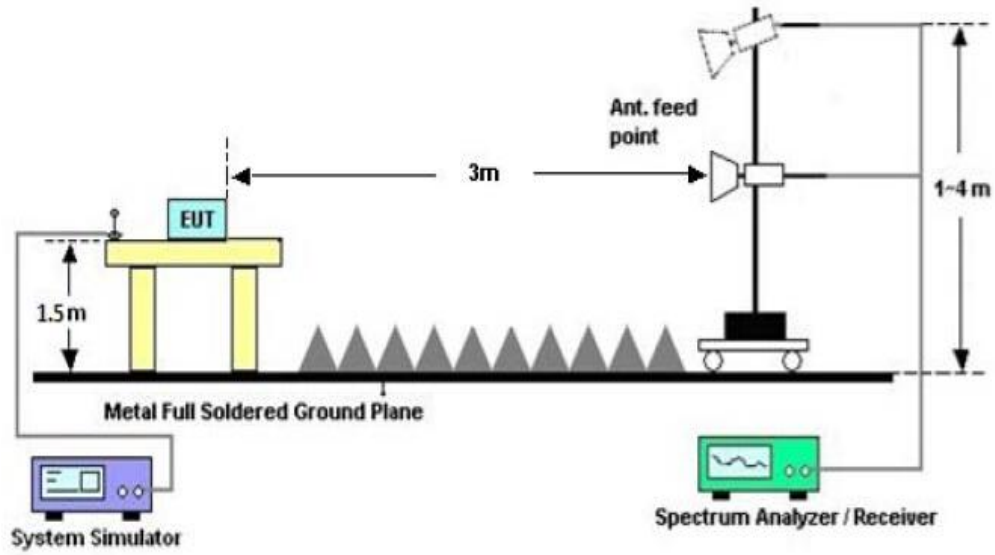

**8.4. TEST RESULT**

**(Worst modulation:GFSK)**

**FOR BR/EDR**

**RADIATED EMISSION BELOW 30MHZ**

No emission found between lowest internal used/generated frequencies to 30MHz.

**RADIATED EMISSION BELOW 1GHZ**

**RADIATED EMISSION TEST- (30MHZ-1GHZ)-LOW CHANNEL-HORIZONTAL**

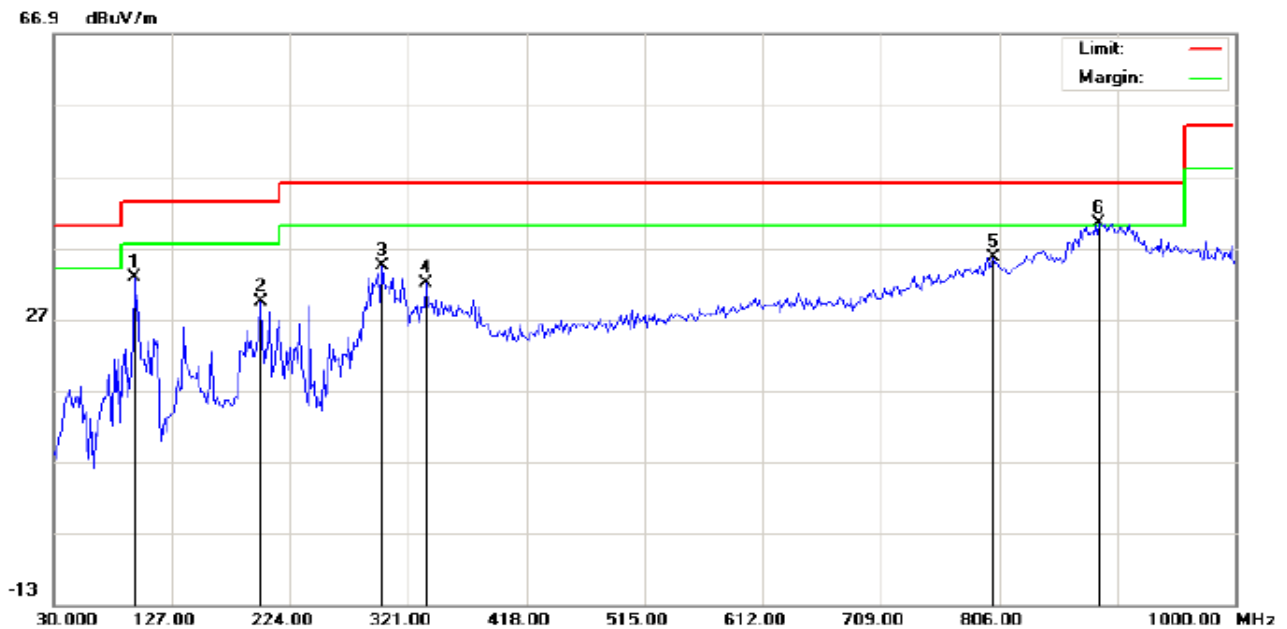

|                                 |                                 |                   |
|---------------------------------|---------------------------------|-------------------|
| Site: site #1                   | Polarization: <i>Horizontal</i> | Temperature: 23.5 |
| Limit: FCC Class B 3M Radiation | Power:                          | Humidity: 55.8 %  |
| EUT: Bluetooth Headset          | Distance:                       |                   |
| M/N: Metal ForgeAir             |                                 |                   |
| Mode: Low Channel TX            |                                 |                   |
| Note:                           |                                 |                   |

| No. | Mk | Freq.    | Reading | Factor | Measurement | Limit  | Over   | Detector | Antenna Height | Table Degree | Comment |
|-----|----|----------|---------|--------|-------------|--------|--------|----------|----------------|--------------|---------|
|     |    | MHz      | dBuV    | dB/m   | dBuV/m      | dBuV/m | dB     |          | cm             | degree       |         |
| 1   |    | 96.2833  | 25.98   | 6.77   | 32.75       | 43.50  | -10.75 | peak     |                |              |         |
| 2   |    | 199.7500 | 17.49   | 11.99  | 29.48       | 43.50  | -14.02 | peak     |                |              |         |
| 3   |    | 299.9833 | 19.04   | 15.41  | 34.45       | 46.00  | -11.55 | peak     |                |              |         |
| 4   |    | 335.5500 | 14.17   | 17.78  | 31.95       | 46.00  | -14.05 | peak     |                |              |         |
| 5   |    | 801.1500 | 8.34    | 27.32  | 35.66       | 46.00  | -10.34 | peak     |                |              |         |
| 6   | *  | 888.4500 | 12.05   | 28.31  | 40.36       | 46.00  | -5.64  | peak     |                |              |         |

**RESULT: PASS**



RADIATED EMISSION TEST- (30MHZ-1GHZ)-LOW CHANNEL -VERTICAL

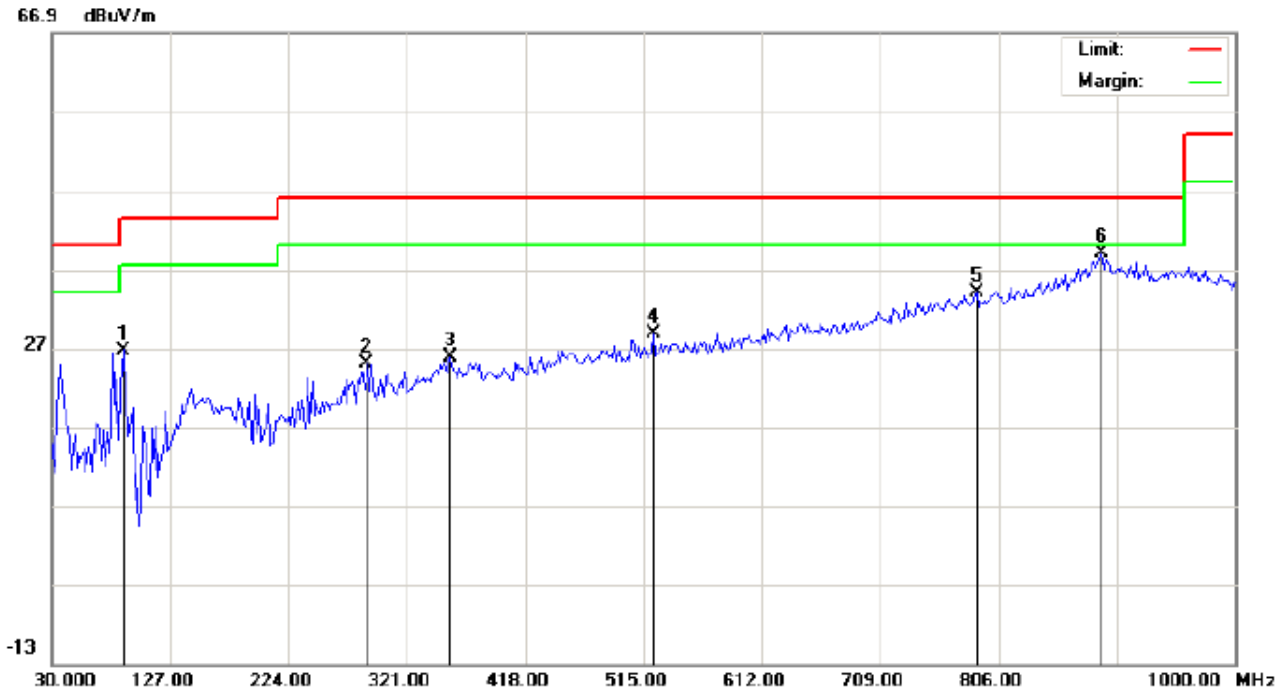

Site: site #1  
Limit: FCC Class B 3M Radiation  
EUT: Bluetooth Headset  
M/N: Metal ForgeAir  
Mode: Low Channel TX  
Note:

Polarization: **Vertical**  
Power:  
Distance:

Temperature: 23.5  
Humidity: 55.8 %

| No. | Mk | Freq.    | Reading | Factor | Measurement | Limit  | Over   | Detector | Antenna Height | Table Degree | Comment |
|-----|----|----------|---------|--------|-------------|--------|--------|----------|----------------|--------------|---------|
|     |    | MHz      | dBuV    | dB/m   | dBuV/m      | dBuV/m | dB     |          | cm             | degree       |         |
| 1   |    | 88.2000  | 21.96   | 4.74   | 26.70       | 43.50  | -16.80 | peak     |                |              |         |
| 2   |    | 288.6666 | 9.93    | 15.07  | 25.00       | 46.00  | -21.00 | peak     |                |              |         |
| 3   |    | 356.5667 | 7.12    | 18.78  | 25.90       | 46.00  | -20.10 | peak     |                |              |         |
| 4   |    | 523.0833 | 7.08    | 21.75  | 28.83       | 46.00  | -17.17 | peak     |                |              |         |
| 5   |    | 788.2167 | 6.86    | 27.16  | 34.02       | 46.00  | -11.98 | peak     |                |              |         |
| 6   | *  | 890.0667 | 10.57   | 28.35  | 38.92       | 46.00  | -7.08  | peak     |                |              |         |

**RESULT: PASS**

**Note:** 1. Factor=Antenna Factor + Cable loss, Margin=Measurement-Limit.

2. The "Factor" value can be calculated automatically by software of measurement system.

RADIATED EMISSION TEST- (30MHZ-1GHZ)-MIDDLE CHANNEL-HORIZONTAL

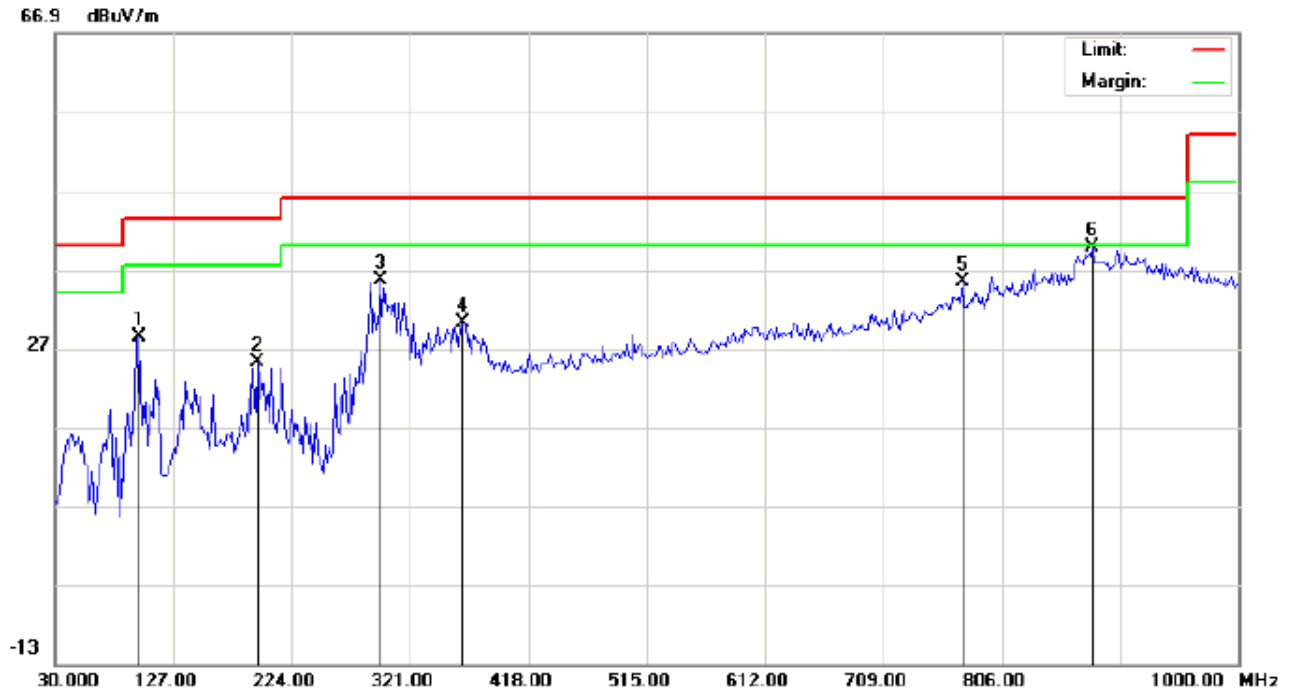

Site: site #1  
Limit: FCC Class B 3M Radiation  
EUT: Bluetooth Headset  
M/N: Metal ForgeAir  
Mode: Middle Channel TX  
Note:

Polarization: *Horizontal*  
Power:  
Distance:

Temperature: 23.5  
Humidity: 55.8 %

| No. | Mk | Freq.    | Reading | Factor | Measurement | Limit  | Over   | Detector | Antenna Height | Table Degree | Comment |
|-----|----|----------|---------|--------|-------------|--------|--------|----------|----------------|--------------|---------|
|     |    | MHz      | dBuV    | dB/m   | dBuV/m      | dBuV/m | dB     |          | cm             | degree       |         |
| 1   |    | 99.5167  | 18.37   | 10.00  | 28.37       | 43.50  | -15.13 | peak     |                |              |         |
| 2   |    | 196.5167 | 13.29   | 11.84  | 25.13       | 43.50  | -18.37 | peak     |                |              |         |
| 3   |    | 296.7500 | 20.78   | 14.86  | 35.64       | 46.00  | -10.36 | peak     |                |              |         |
| 4   |    | 364.6500 | 11.39   | 18.84  | 30.23       | 46.00  | -15.77 | peak     |                |              |         |
| 5   |    | 773.6667 | 8.46    | 26.96  | 35.42       | 46.00  | -10.58 | peak     |                |              |         |
| 6   | *  | 880.3667 | 11.67   | 28.10  | 39.77       | 46.00  | -6.23  | peak     |                |              |         |

**RESULT: PASS**



RADIATED EMISSION TEST- (30MHZ-1GHZ)-HIGH CHANNEL-HORIZONTAL

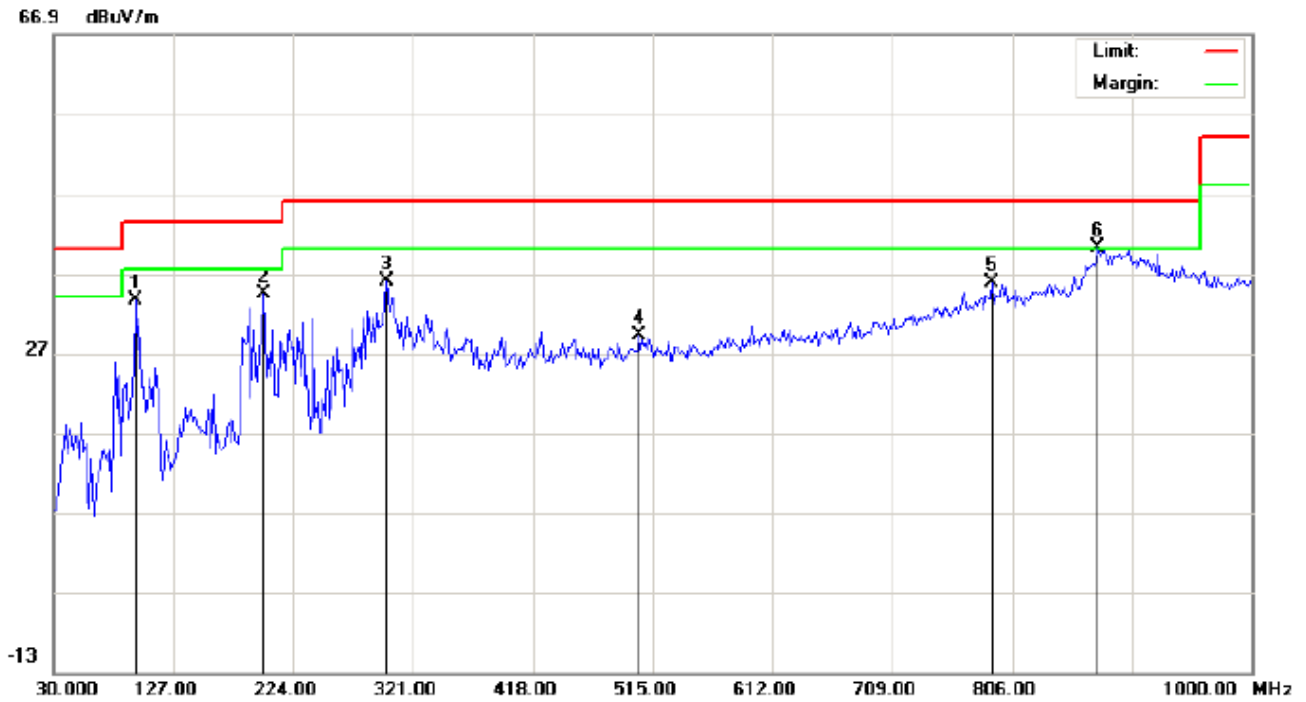

Site: site #1  
Limit: FCC Class B 3M Radiation  
EUT: Bluetooth Headset  
M/N: Metal ForgeAir  
Mode: High Channel TX  
Note:

Polarization: *Horizontal*  
Power:  
Distance:

Temperature: 23.5  
Humidity: 55.8 %

| No. | Mk | Freq.    | Reading | Factor | Measurement | Limit  | Over   | Detector | Antenna Height | Table Degree | Comment |
|-----|----|----------|---------|--------|-------------|--------|--------|----------|----------------|--------------|---------|
|     |    | MHz      | dBuV    | dB/m   | dBuV/m      | dBuV/m | dB     |          | cm             | degree       |         |
| 1   |    | 96.2833  | 26.76   | 6.77   | 33.53       | 43.50  | -9.97  | peak     |                |              |         |
| 2   |    | 199.7500 | 22.45   | 11.99  | 34.44       | 43.50  | -9.06  | peak     |                |              |         |
| 3   |    | 299.9833 | 20.53   | 15.41  | 35.94       | 46.00  | -10.06 | peak     |                |              |         |
| 4   |    | 503.6833 | 8.01    | 21.23  | 29.24       | 46.00  | -16.76 | peak     |                |              |         |
| 5   |    | 789.8333 | 8.53    | 27.18  | 35.71       | 46.00  | -10.29 | peak     |                |              |         |
| 6   | *  | 875.5167 | 12.30   | 27.97  | 40.27       | 46.00  | -5.73  | peak     |                |              |         |

**RESULT: PASS**

RADIATED EMISSION TEST- (30MHZ-1GHZ)-HIGH CHANNEL -VERTICAL

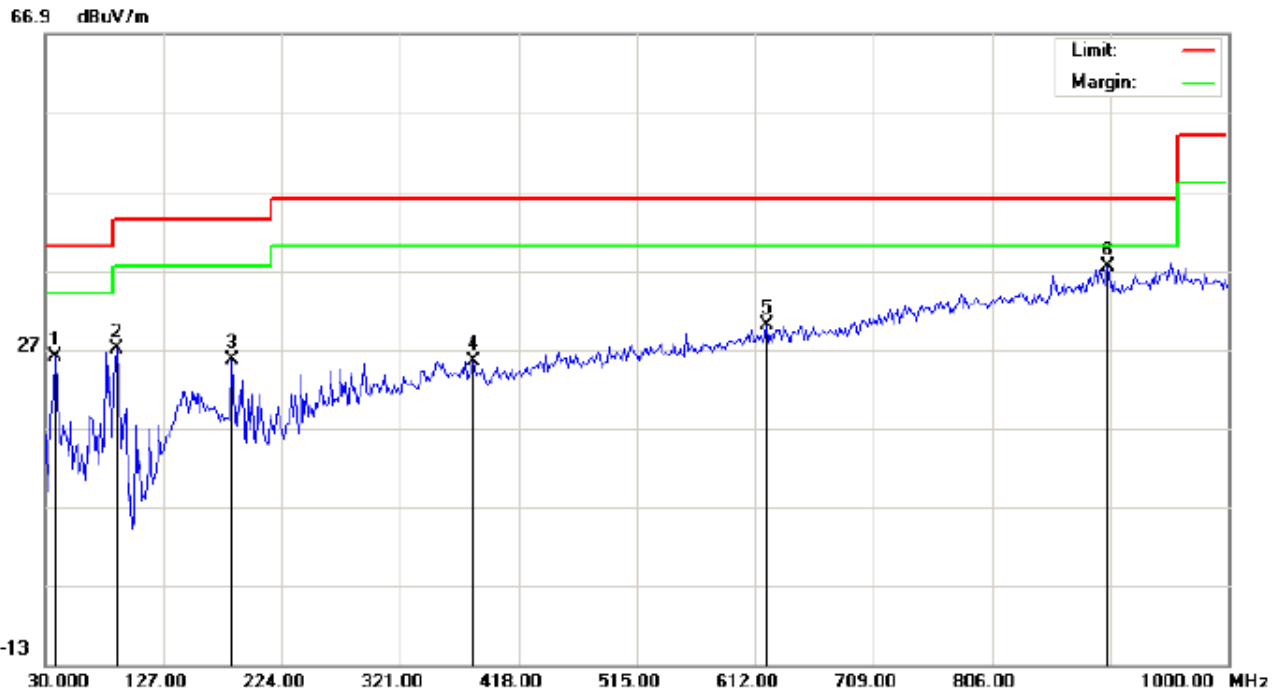

Site: site #1  
Limit: FCC Class B 3M Radiation  
EUT: Bluetooth Headset  
M/N: Metal ForgeAir  
Mode: High Channel TX  
Note:

Polarization: **Vertical**  
Power:  
Distance:

Temperature: 23.5  
Humidity: 55.8 %

| No. | Mk | Freq.    | Reading | Factor | Measurement | Limit  | Over   | Detector | Antenna Height | Table Degree | Comment |
|-----|----|----------|---------|--------|-------------|--------|--------|----------|----------------|--------------|---------|
|     |    | MHz      | dBuV    | dB/m   | dBuV/m      | dBuV/m | dB     |          | cm             | degree       |         |
| 1   |    | 38.0833  | 19.55   | 6.39   | 25.94       | 40.00  | -14.06 | peak     |                |              |         |
| 2   |    | 88.2000  | 22.35   | 4.74   | 27.09       | 43.50  | -16.41 | peak     |                |              |         |
| 3   |    | 183.5833 | 12.38   | 13.16  | 25.54       | 43.50  | -17.96 | peak     |                |              |         |
| 4   |    | 380.8167 | 6.56    | 18.94  | 25.50       | 46.00  | -20.50 | peak     |                |              |         |
| 5   |    | 621.7000 | 6.69    | 23.22  | 29.91       | 46.00  | -16.09 | peak     |                |              |         |
| 6   | *  | 901.3833 | 8.68    | 28.65  | 37.33       | 46.00  | -8.67  | peak     |                |              |         |

**RESULT: PASS**

**Note:** 1. Factor=Antenna Factor + Cable loss, Margin=Measurement-Limit.

2. The "Factor" value can be calculated automatically by software of measurement system.





RADIATED EMISSION TEST- (ABOVE 1GHZ)-MIDDLE CHANNEL-HORIZONTAL

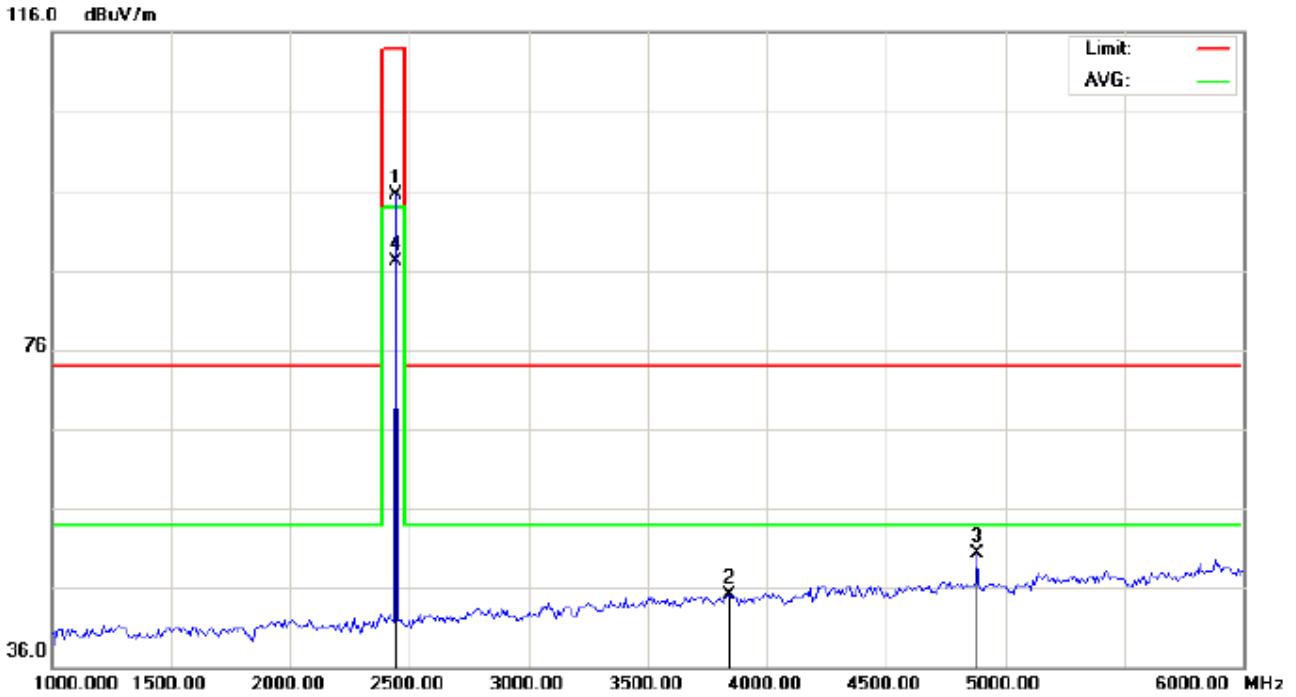

Site: site #1 Polarization: *Horizontal* Temperature: 22.7  
Limit: FCC Class B 3M Radiation above 1GHZ(PK)- Power: Humidity: 53.6 %  
EUT: Bluetooth Earphone Distance:  
M/N: MetalForgeAir  
Mode: Middle Channel TX  
Note:

| No. | Mk | Freq.    | Reading | Factor | Measurement | Limit  | Over   | Detector | Antenna Height | Table Degree | Comment |
|-----|----|----------|---------|--------|-------------|--------|--------|----------|----------------|--------------|---------|
|     |    | MHz      | dBuV    | dB/m   | dBuV/m      | dBuV/m | dB     |          | cm             | degree       |         |
| 1   |    | 2441.000 | 85.24   | 10.36  | 95.60       | 114.00 | -18.40 | peak     |                |              |         |
| 2   |    | 3841.667 | 30.95   | 14.21  | 45.16       | 74.00  | -28.84 | peak     |                |              |         |
| 3   |    | 4882.000 | 42.38   | 7.89   | 50.27       | 74.00  | -23.73 | peak     |                |              |         |
| 4   | *  | 2441.000 | 76.65   | 10.36  | 87.01       | 94.00  | -6.99  | AVG      | 100            | 291          |         |

**RESULT: PASS**





RADIATED EMISSION TEST- (ABOVE 1GHZ)-HIGH CHANNEL-HORIZONTAL

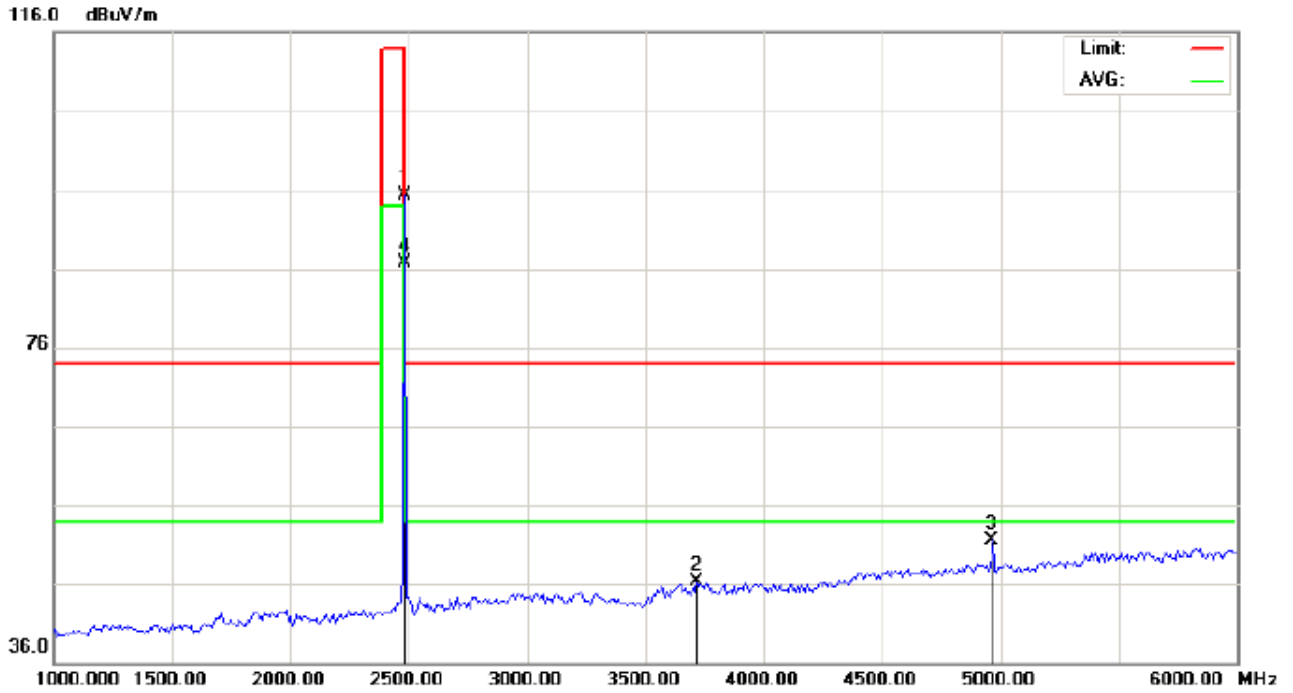

Site: site #1  
Limit: FCC Class B 3M Radiation above 1GHZ(PK)-  
EUT: Bluetooth Earphone  
M/N: MetalForgeAir  
Mode: High Channel TX  
Note:

Polarization: *Horizontal*  
Power:  
Distance:

Temperature: 22.7  
Humidity: 53.6 %

| No. | Mk | Freq.    | Reading | Factor | Measurement | Limit  | Over   | Detector | Antenna Height | Table Degree | Comment |
|-----|----|----------|---------|--------|-------------|--------|--------|----------|----------------|--------------|---------|
|     |    | MHz      | dBuV    | dB/m   | dBuV/m      | dBuV/m | dB     |          | cm             | degree       |         |
| 1   |    | 2480.000 | 84.97   | 10.41  | 95.38       | 114.00 | -18.62 | peak     |                |              |         |
| 2   |    | 3716.667 | 32.92   | 13.44  | 46.36       | 74.00  | -27.64 | peak     |                |              |         |
| 3   |    | 4960.000 | 43.51   | 8.09   | 51.60       | 74.00  | -22.40 | peak     |                |              |         |
| 4   | *  | 2480.000 | 76.32   | 10.41  | 86.73       | 94.00  | -7.27  | AVG      | 100            | 286          |         |

**RESULT: PASS**



**Field strength of the fundamental signal****1Mbps Result:****Peak value**

| Frequency | Reading Level | Factor | Measurement | Limit    | Over   | Antenna      |
|-----------|---------------|--------|-------------|----------|--------|--------------|
| (MHz)     | (dBuv)        | (dB/m) | (dBuv/m)    | (dBuv/m) | (dB)   | Polarization |
| 2402      | 84.21         | 10.32  | 94.53       | 114      | -19.47 | Horizontal   |
| 2402      | 84.32         | 10.32  | 94.64       | 114      | -19.36 | Vertical     |
| 2441      | 85.24         | 10.36  | 95.60       | 114      | -18.40 | Horizontal   |
| 2441      | 84.99         | 10.36  | 95.35       | 114      | -18.65 | Vertical     |
| 2480      | 84.97         | 10.41  | 95.38       | 114      | -18.62 | Horizontal   |
| 2480      | 85.17         | 10.41  | 95.58       | 114      | -18.42 | Vertical     |

**Average value**

| Frequency | Reading Level | Factor | Measurement | Limit    | Over  | Antenna      |
|-----------|---------------|--------|-------------|----------|-------|--------------|
| (MHz)     | (dBuv)        | (dB/m) | (dBuv/m)    | (dBuv/m) | (dB)  | Polarization |
| 2402      | 75.57         | 10.32  | 85.89       | 94       | -8.11 | Horizontal   |
| 2402      | 75.80         | 10.32  | 86.12       | 94       | -7.88 | Vertical     |
| 2441      | 76.65         | 10.36  | 87.01       | 94       | -6.99 | Horizontal   |
| 2441      | 76.31         | 10.36  | 86.67       | 94       | -7.33 | Vertical     |
| 2480      | 76.32         | 10.41  | 86.73       | 94       | -7.27 | Horizontal   |
| 2480      | 76.56         | 10.41  | 86.97       | 94       | -7.03 | Vertical     |

**2Mbps Result:****Peak value**

| Frequency | Reading Level | Factor | Measurement | Limit    | Over   | Antenna      |
|-----------|---------------|--------|-------------|----------|--------|--------------|
| (MHz)     | (dBuv)        | (dB/m) | (dBuv/m)    | (dBuv/m) | (dB)   | Polarization |
| 2402      | 84.21         | 10.32  | 94.53       | 114      | -19.47 | Horizontal   |
| 2402      | 84.13         | 10.32  | 94.45       | 114      | -19.55 | Vertical     |
| 2441      | 85.13         | 10.36  | 95.49       | 114      | -18.51 | Horizontal   |
| 2441      | 85.07         | 10.36  | 95.43       | 114      | -18.57 | Vertical     |
| 2480      | 85.05         | 10.41  | 95.46       | 114      | -18.54 | Horizontal   |
| 2480      | 84.97         | 10.41  | 95.38       | 114      | -18.62 | Vertical     |

**Average value**

| Frequency | Reading Level | Factor | Measurement | Limit    | Over  | Antenna      |
|-----------|---------------|--------|-------------|----------|-------|--------------|
| (MHz)     | (dBuv)        | (dB/m) | (dBuv/m)    | (dBuv/m) | (dB)  | Polarization |
| 2402      | 75.67         | 10.32  | 85.99       | 94       | -8.01 | Horizontal   |
| 2402      | 75.50         | 10.32  | 85.82       | 94       | -8.18 | Vertical     |
| 2441      | 76.50         | 10.36  | 86.86       | 94       | -7.14 | Horizontal   |
| 2441      | 76.39         | 10.36  | 86.75       | 94       | -7.25 | Vertical     |
| 2480      | 76.41         | 10.41  | 86.82       | 94       | -7.18 | Horizontal   |
| 2480      | 76.28         | 10.41  | 86.69       | 94       | -7.31 | Vertical     |

**3Mbps Result:****Peak value**

| Frequency | Reading Level | Factor | Measurement | Limit    | Over   | Antenna      |
|-----------|---------------|--------|-------------|----------|--------|--------------|
| (MHz)     | (dBuv)        | (dB/m) | (dBuv/m)    | (dBuv/m) | (dB)   | Polarization |
| 2402      | 84.06         | 10.32  | 94.38       | 114      | -19.62 | Horizontal   |
| 2402      | 84.00         | 10.32  | 94.32       | 114      | -19.68 | Vertical     |
| 2441      | 84.99         | 10.36  | 95.35       | 114      | -18.65 | Horizontal   |
| 2441      | 84.93         | 10.36  | 95.29       | 114      | -18.71 | Vertical     |
| 2480      | 84.88         | 10.41  | 95.29       | 114      | -18.71 | Horizontal   |
| 2480      | 84.80         | 10.41  | 95.21       | 114      | -18.79 | Vertical     |

**Average value**

| Frequency | Reading Level | Factor | Measurement | Limit    | Over  | Antenna      |
|-----------|---------------|--------|-------------|----------|-------|--------------|
| (MHz)     | (dBuv)        | (dB/m) | (dBuv/m)    | (dBuv/m) | (dB)  | Polarization |
| 2402      | 75.36         | 10.32  | 85.68       | 94       | -8.32 | Horizontal   |
| 2402      | 75.25         | 10.32  | 85.57       | 94       | -8.43 | Vertical     |
| 2441      | 76.27         | 10.36  | 86.63       | 94       | -7.37 | Horizontal   |
| 2441      | 76.18         | 10.36  | 86.54       | 94       | -7.46 | Vertical     |
| 2480      | 76.13         | 10.41  | 86.54       | 94       | -7.46 | Horizontal   |
| 2480      | 76.08         | 10.41  | 86.49       | 94       | -7.51 | Vertical     |

## 9. BAND EDGE EMISSION

### 9.1. MEASUREMENT PROCEDURE

- 1The EUT operates at hopping-off test mode. The lowest or highest channels are tested to verify the largest transmission and spurious emissions power at the continuous transmission mode.
- 2Max hold the trace of the setup 1, and the EUT operates at hopping-on test mode to verify the largest spurious emissions power.
- 3Set the spectrum analyzer in the following setting in order to capture the lower and upper band-edges of the emission

### 9.2 TEST SETUP

RADIATED EMISSION TEST SETUP

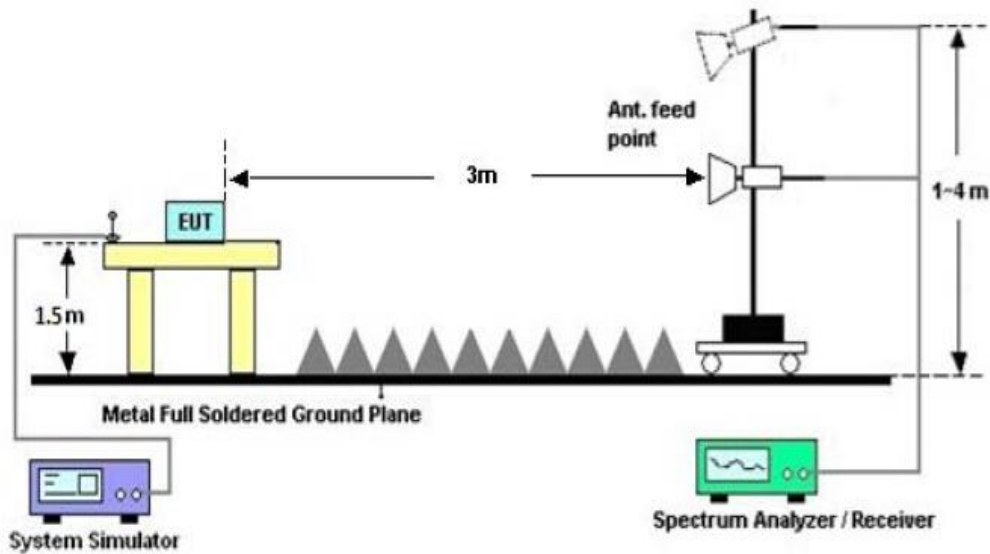

### 9.3 RADIATED TEST RESULT

(Worst modulation: GFSK)

FOR BR/EDR

TEST PLOT OF BAND EDGE FOR LOW CHANNEL-Horizontal

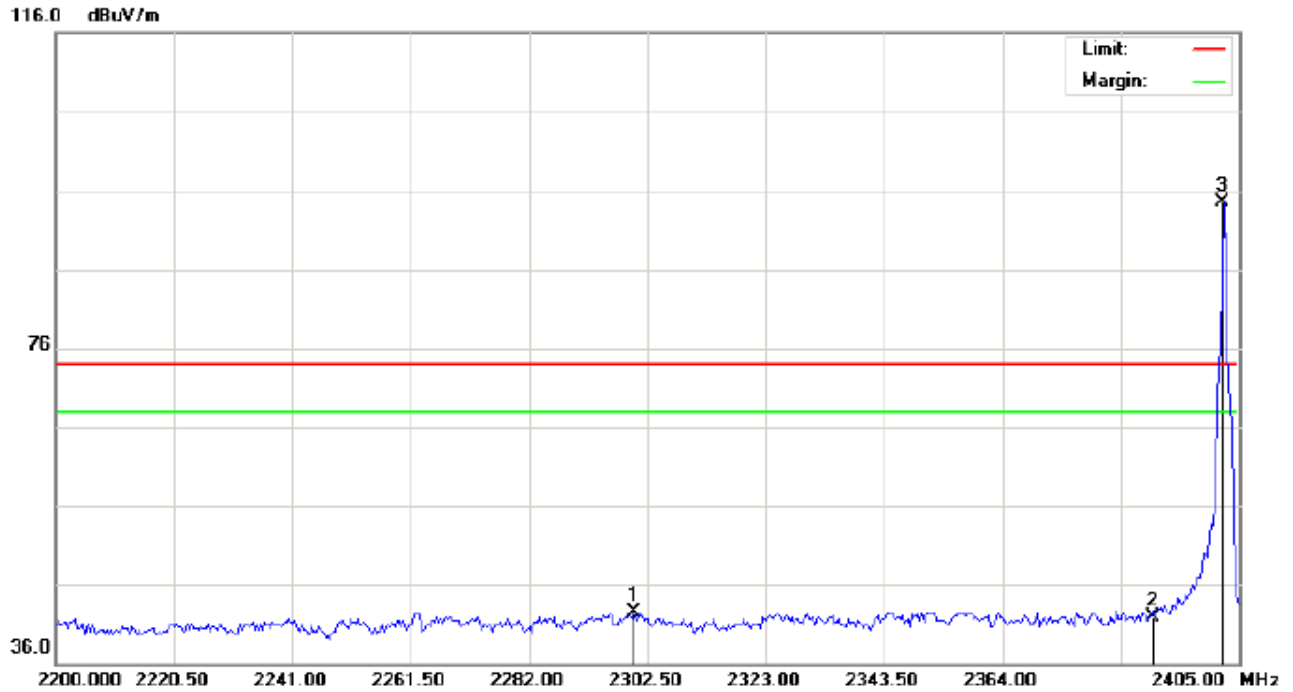

|  |                                 |                 |
|--|---------------------------------|-----------------|
| Site: site #1                                  | Polarization: <i>Horizontal</i> | Temperature: 26 |
| Limit: FCC Class B 3M Radiation above 1GHZ(PK) | Power:                          | Humidity: 60 %  |
| EUT: Bluetooth Earphone                        | Distance:                       |                 |
| M/N: MetalForgeAir                             |                                 |                 |
| Mode: Low Channel TX                           |                                 |                 |
| Note:  |                                 |                 |

| No. | Mk | Freq.    | Reading | Factor | Measurement | Limit  | Over   | Detector | Antenna Height | Table Degree | Comment |
|-----|----|----------|---------|--------|-------------|--------|--------|----------|----------------|--------------|---------|
|     |    | MHz      | dBuV    | dB/m   | dBuV/m      | dBuV/m | dB     |          | cm             | degree       |         |
| 1   |    | 2300.108 | 32.31   | 10.21  | 42.52       | 74.00  | -31.48 | peak     |                |              |         |
| 2   |    | 2390.000 | 31.50   | 10.31  | 41.81       | 74.00  | -32.19 | peak     |                |              |         |
| 3   | *  | 2402.000 | 84.22   | 10.32  | 94.54       | 74.00  | 20.54  | peak     |                |              |         |









## 10. 20DB BANDWIDTH

### 10.1. MEASUREMENT PROCEDURE

1. Connect EUT RF output port to the Spectrum Analyzer through an RF attenuator
2. Set the EUT Work on the top, the middle and the bottom operation frequency individually.
3. Set Span = approximately 2 to 3 times the 20 dB bandwidth, centered on a hopping channel  
RBW  $\geq$  1% of the 20 dB bandwidth, VBW  $\geq$  RBW; Sweep = auto; Detector function = peak
4. Set SPA Trace 1 Max hold, then View.

### 10.2. TEST SET-UP

(BLOCK DIAGRAM OF CONFIGURATION)

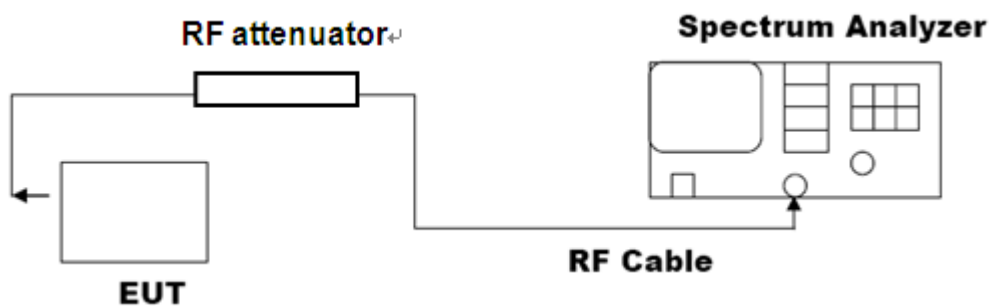

Note: The EUT has been used temporary antenna connector for testing.

### 10.3. LIMITS AND MEASUREMENT RESULTS

FOR BR/EDR

| BLUETOOTH 1MBPS LIMITS AND MEASUREMENT RESULT |                    |              |               |        |
|---|--------------------|--------------|---------------|--------|
| Applicable Limits                             | Measurement Result |              |               |        |
|   | Test Data (MHz)    |              |               | Result |
|   |                    | 99%OBW (MHz) | -20dB BW(MHz) |        |
| N/A   | Low Channel        | 0.937        | 1.108         | PASS   |
|   | Middle Channel     | 0.938        | 1.109         | PASS   |
|   | High Channel       | 0.940        | 1.086         | PASS   |

TEST PLOT OF BANDWIDTH FOR LOW CHANNEL

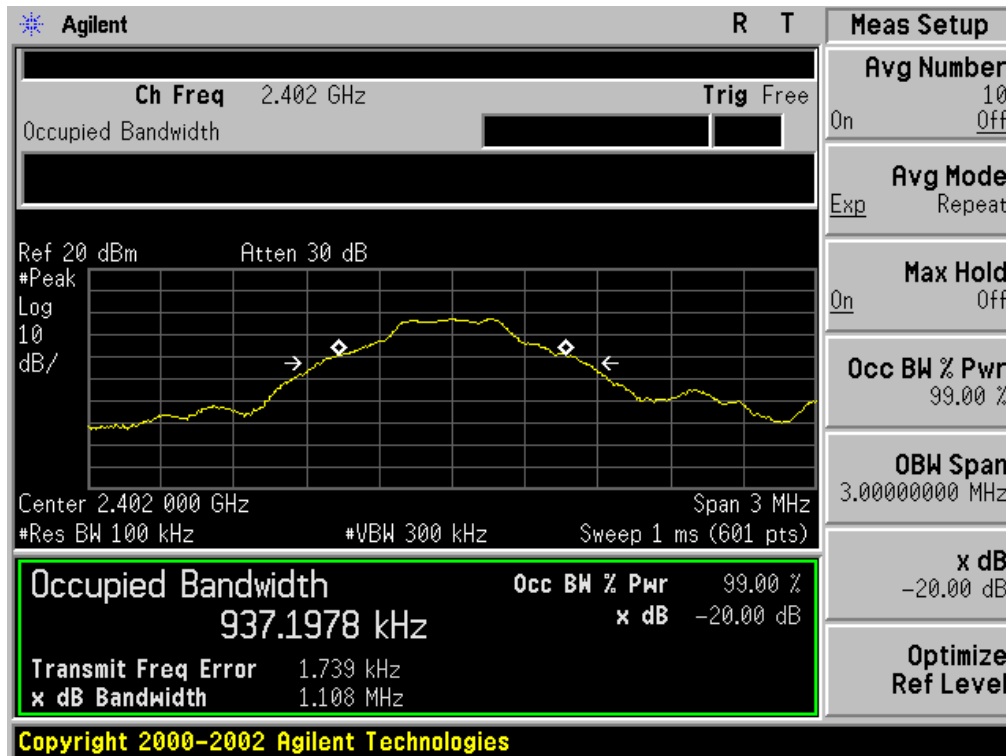

TEST PLOT OF BANDWIDTH FOR MIDDLE CHANNEL

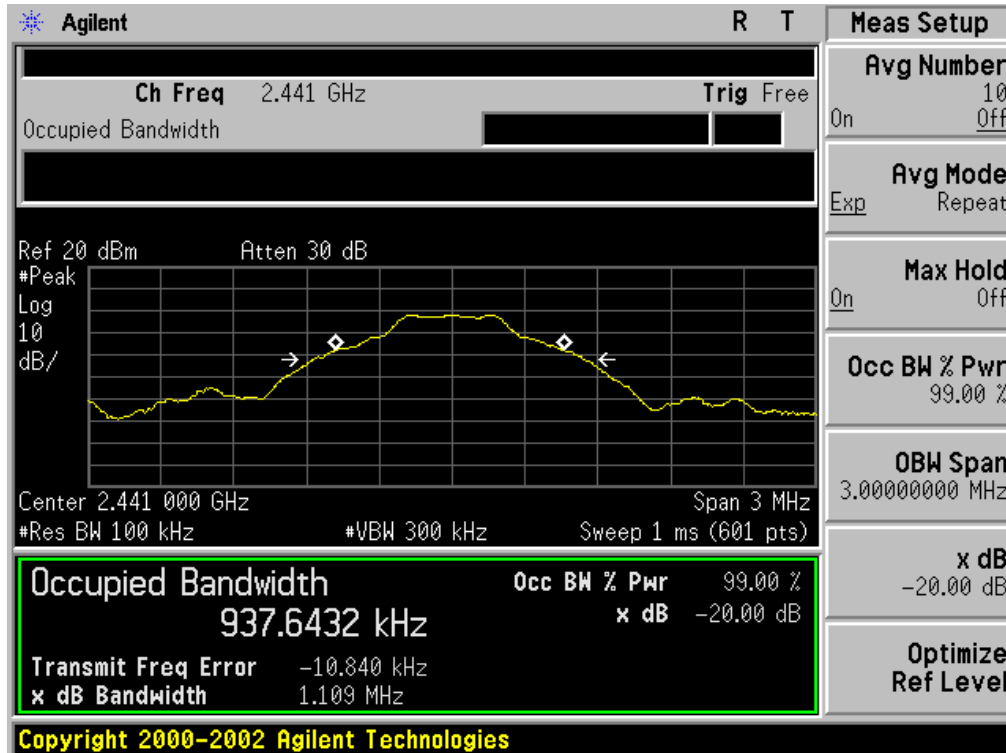



| BLUETOOTH 2MBPS LIMITS AND MEASUREMENT RESULT |                    |              |               |        |
|---|--------------------|--------------|---------------|--------|
| Applicable Limits                             | Measurement Result |              |               |        |
|   | Test Data (MHz)    |              |               | Result |
|   |                    | 99%OBW (MHz) | -20dB BW(MHz) |        |
| N/A   | Low Channel        | 1.223        | 1.373         | PASS   |
|   | Middle Channel     | 1.224        | 1.377         | PASS   |
|   | High Channel       | 1.216        | 1.370         | PASS   |

TEST PLOT OF BANDWIDTH FOR LOW CHANNEL

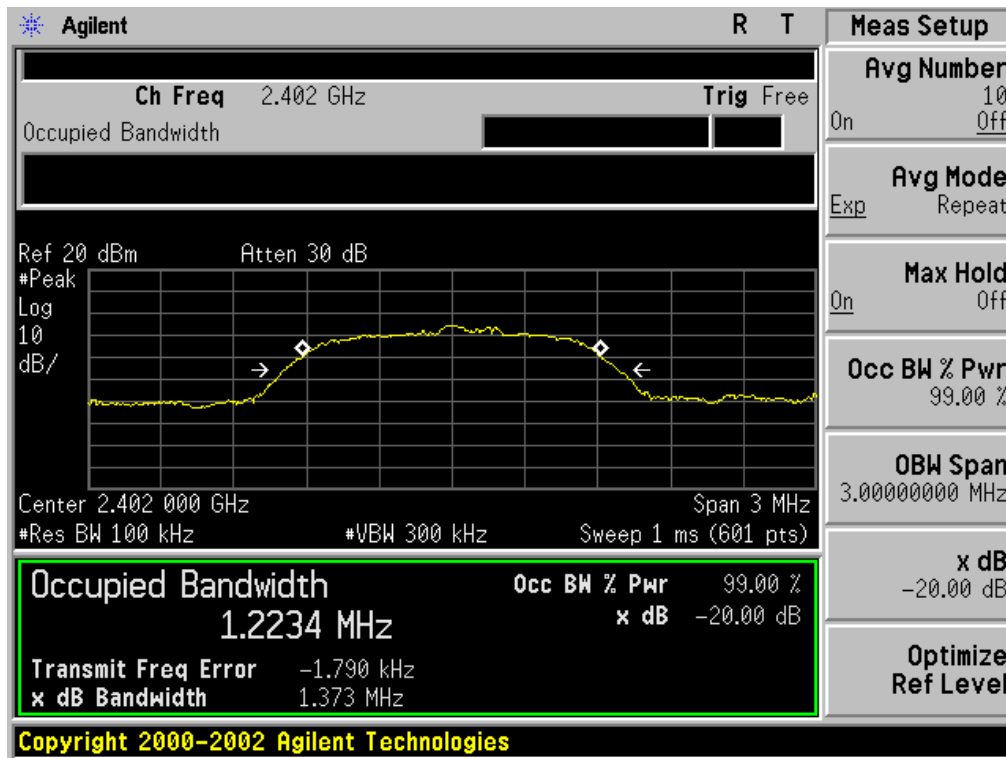

TEST PLOT OF BANDWIDTH FOR MIDDLE CHANNEL

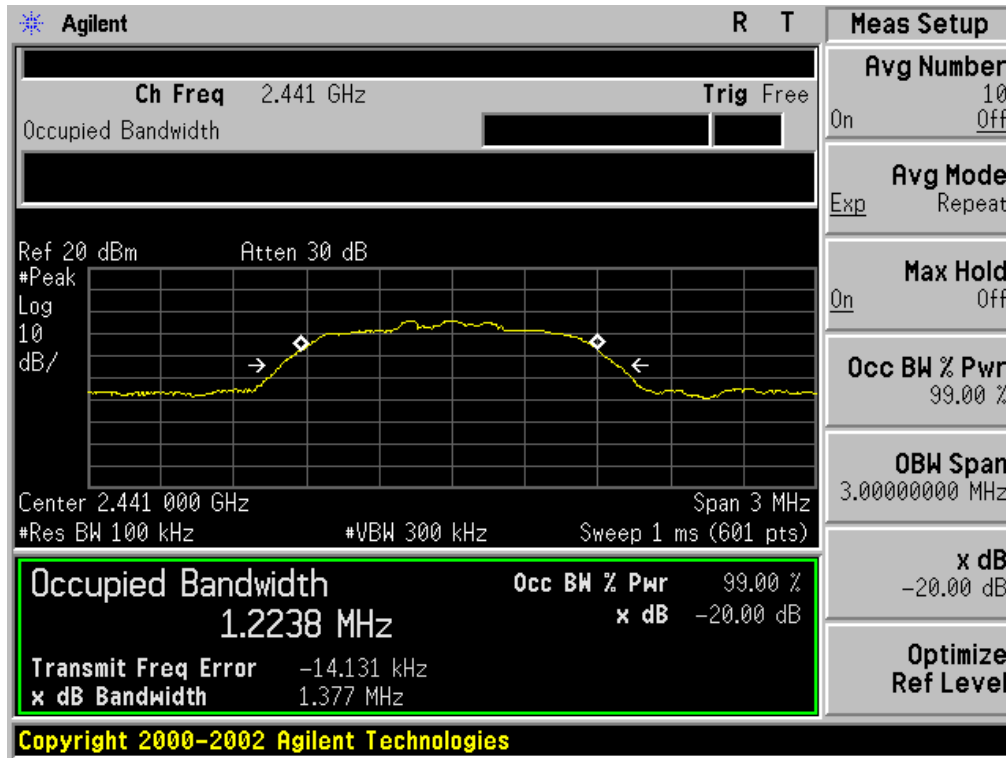

TEST PLOT OF BANDWIDTH FOR HIGH CHANNEL

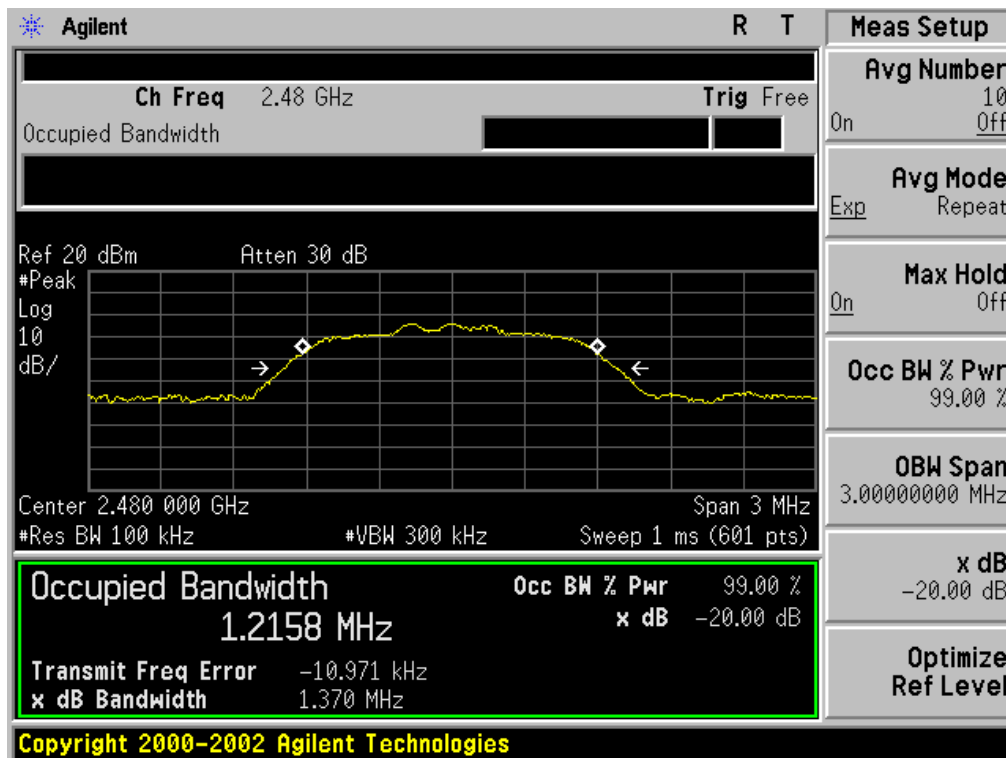



| BLUETOOTH 3MBPS LIMITS AND MEASUREMENT RESULT |                    |              |               |        |
|---|--------------------|--------------|---------------|--------|
| Applicable Limits                             | Measurement Result |              |               |        |
|   | Test Data (MHz)    |              |               | Result |
|   |                    | 99%OBW (MHz) | -20dB BW(MHz) |        |
| N/A   | Low Channel        | 1.236        | 1.375         | PASS   |
|   | Middle Channel     | 1.233        | 1.383         | PASS   |
|   | High Channel       | 1.236        | 1.374         | PASS   |

TEST PLOT OF BANDWIDTH FOR LOW CHANNEL

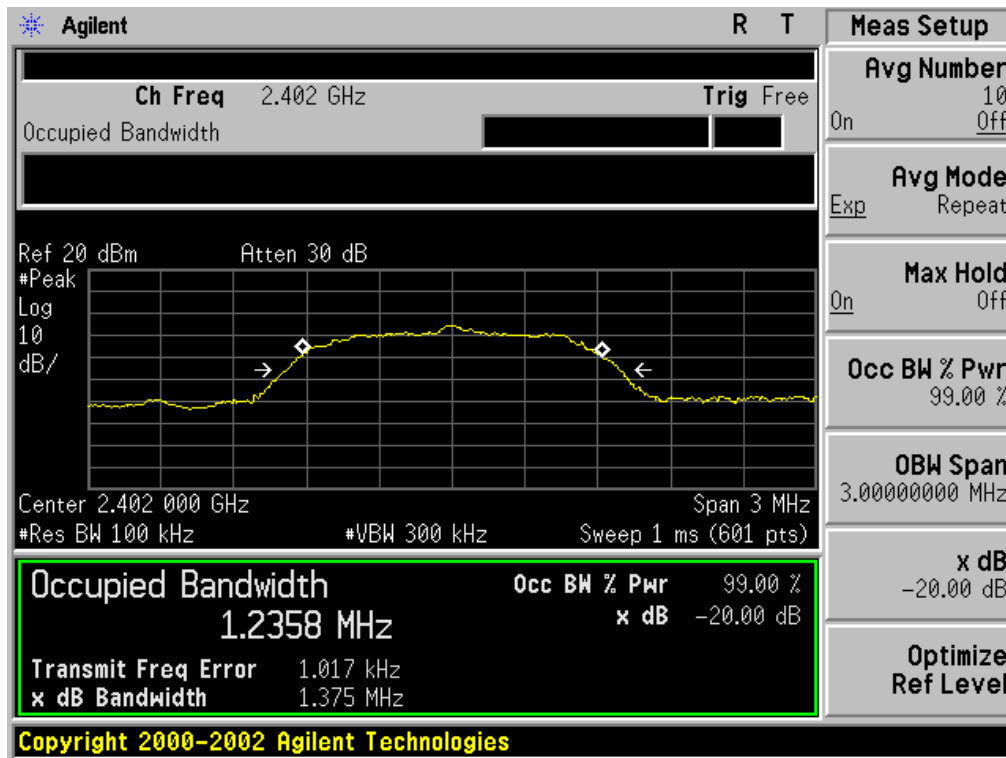

TEST PLOT OF BANDWIDTH FOR MIDDLE CHANNEL

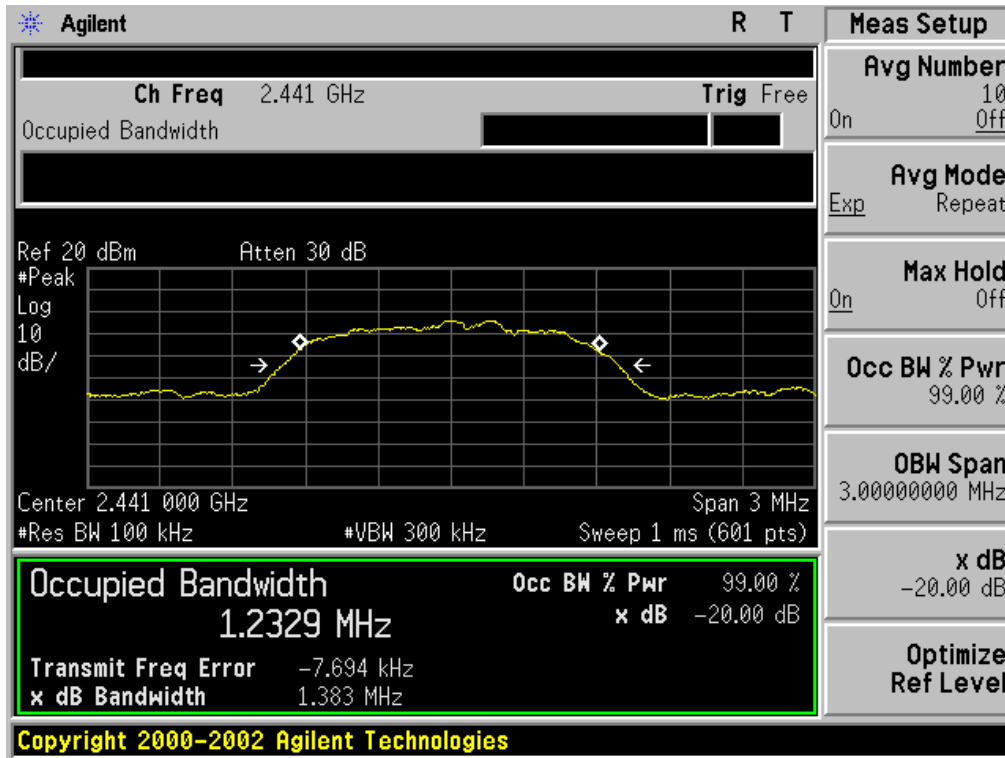

TEST PLOT OF BANDWIDTH FOR HIGH CHANNEL

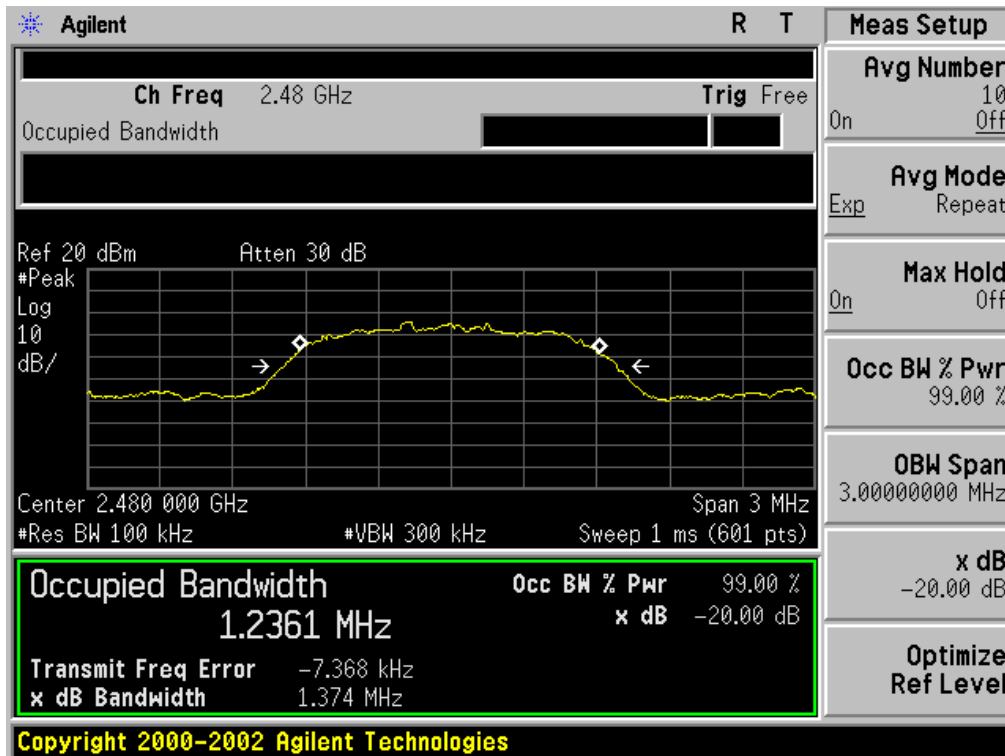

## 11. FCC LINE CONDUCTED EMISSION TEST

### 11.1. LIMITS OF LINE CONDUCTED EMISSION TEST

| Frequency     | Maximum RF Line Voltage |                |
|---------------|-------------------------|----------------|
|               | Q.P.( dBuV)             | Average( dBuV) |
| 150kHz~500kHz | 66-56                   | 56-46          |
| 500kHz~5MHz   | 56                      | 46             |
| 5MHz~30MHz    | 60                      | 50             |

Note:

1. The lower limit shall apply at the transition frequency.
2. The limit decreases linearly with the logarithm of the frequency in the range 0.15 MHz to 0.50 MHz.

### 11.2. BLOCK DIAGRAM OF LINE CONDUCTED EMISSION TEST

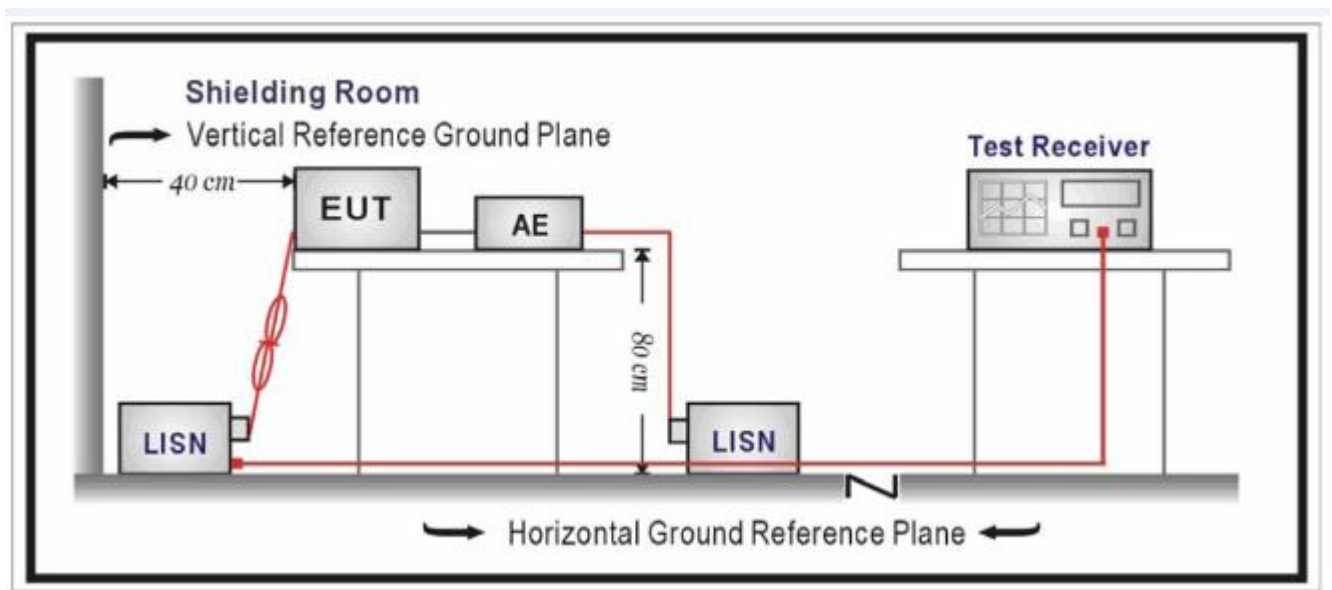

### **11.3. PRELIMINARY PROCEDURE OF LINE CONDUCTED EMISSION TEST**

1. The equipment was set up as per the test configuration to simulate typical actual usage per the user's manual. When the EUT is a tabletop system, a wooden table with a height of 0.8 meters is used and is placed on the ground plane as per ANSI C63.10 (see Test Facility for the dimensions of the ground plane used). When the EUT is a floor-standing equipment, it is placed on the ground plane which has a 3-12 mm non-conductive covering to insulate the EUT from the ground plane.
2. Support equipment, if needed, was placed as per ANSI C63.10.
3. All I/O cables were positioned to simulate typical actual usage as per ANSI C63.10.
4. All support equipments received AC120V/60Hz power from a LISN, if any.
5. The EUT received DC charging voltage by adapter or PC which received 120V/60Hz power by a LISN.
6. The test program was started. Emissions were measured on each current carrying line of the EUT using a spectrum Analyzer / Receiver connected to the LISN powering the EUT. The LISN has two monitoring points: Line 1 (Hot Side) and Line 2 (Neutral Side). Two scans were taken: one with Line 1 connected to Analyzer / Receiver and Line 2 connected to a 50 ohm load; the second scan had Line 1 connected to a 50 ohm load and Line 2 connected to the Analyzer / Receiver.
7. Analyzer / Receiver scanned from 150 kHz to 30MHz for emissions in each of the test modes.
8. During the above scans, the emissions were maximized by cable manipulation.
9. The test mode(s) were scanned during the preliminary test.

Then, the EUT configuration and cable configuration of the above highest emission level were recorded for reference of final testing.

### **11.4. FINAL PROCEDURE OF LINE CONDUCTED EMISSION TEST**

1. EUT and support equipment was set up on the test bench as per step 2 of the preliminary test.
2. A scan was taken on both power lines, Line 1 and Line 2, recording at least the six highest emissions. Emission frequency and amplitude were recorded into a computer in which correction factors were used to calculate the emission level and compare reading to the applicable limit. If EUT emission level was less -2dB to the A.V. limit in Peak mode, then the emission signal was re-checked using Q.P and Average detector.
3. The test data of the worst case condition(s) was reported on the Summary Data page.

11.5. TEST RESULT OF LINE CONDUCTED EMISSION TEST

By adapter(worst case)  
FOR BR/EDR

Line Conducted Emission Test Line 1-L

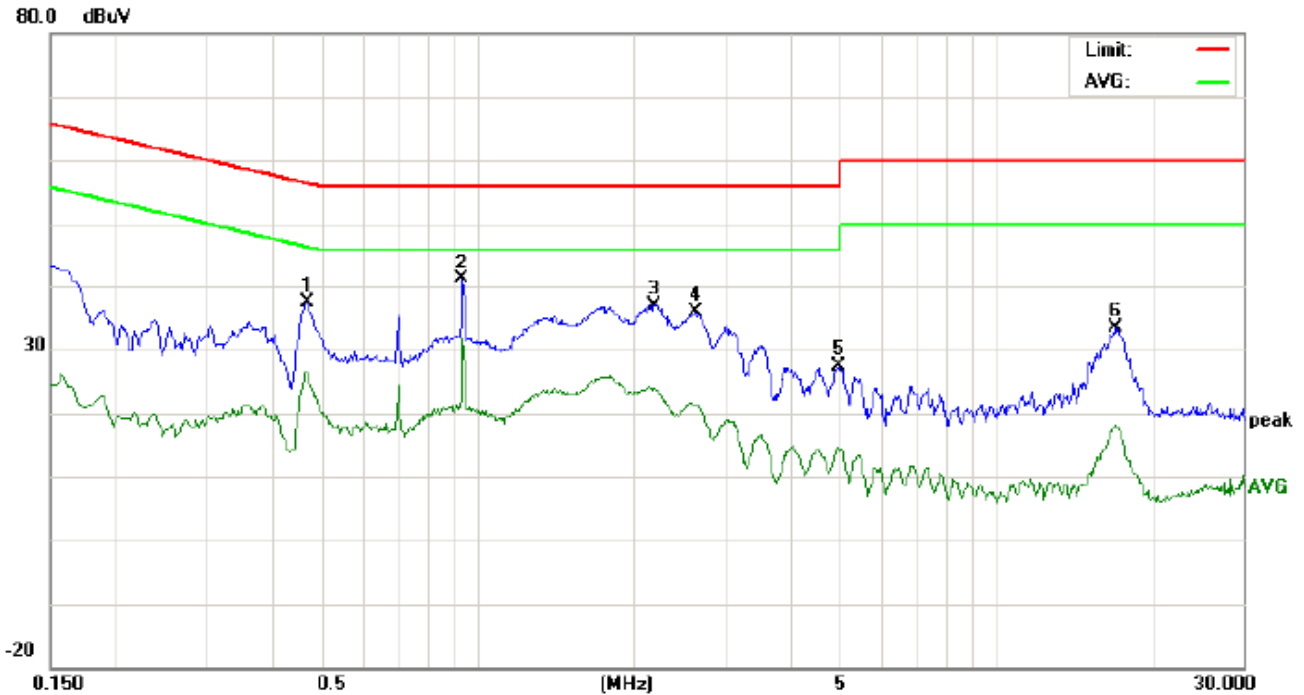

Site: Conduction Phase: L1 Temperature: 23.4  
Limit: FCC Class B Conduction(QP) Power: Humidity: 55.2 %  
EUT: Bluetooth Earphone  
M/N: MetalForgeAir  
Mode: BT Link with charging  
Note:

| No. | Freq. (MHz) | Reading_Level (dBuV) |    |       | Correct Factor (dB) | Measurement (dBuV) |    |       | Limit (dBuV) |       | Margin (dB) |        | P/F | Comment |
|-----|-------------|----------------------|----|-------|---------------------|--------------------|----|-------|--------------|-------|-------------|--------|-----|---------|
|     |             | Peak                 | QP | AVG   |                     | Peak               | QP | AVG   | QP           | AVG   | QP          | AVG    |     |         |
| 1   | 0.4700      | 26.92                |    | 16.00 | 10.38               | 37.30              |    | 26.38 | 56.51        | 46.51 | -19.21      | -20.13 | P   |         |
| 2   | 0.9380      | 30.83                |    | 21.13 | 10.39               | 41.22              |    | 31.52 | 56.00        | 46.00 | -14.78      | -14.48 | P   |         |
| 3   | 2.1980      | 26.63                |    | 13.63 | 10.30               | 36.93              |    | 23.93 | 56.00        | 46.00 | -19.07      | -22.07 | P   |         |
| 4   | 2.6460      | 25.29                |    | 10.82 | 10.46               | 35.75              |    | 21.28 | 56.00        | 46.00 | -20.25      | -24.72 | P   |         |
| 5   | 4.9699      | 17.18                |    | 4.06  | 10.24               | 27.42              |    | 14.30 | 56.00        | 46.00 | -28.58      | -31.70 | P   |         |
| 6   | 17.0419     | 23.23                |    | 8.01  | 10.13               | 33.36              |    | 18.14 | 60.00        | 50.00 | -26.64      | -31.86 | P   |         |

Line Conducted Emission Test Line 2-N

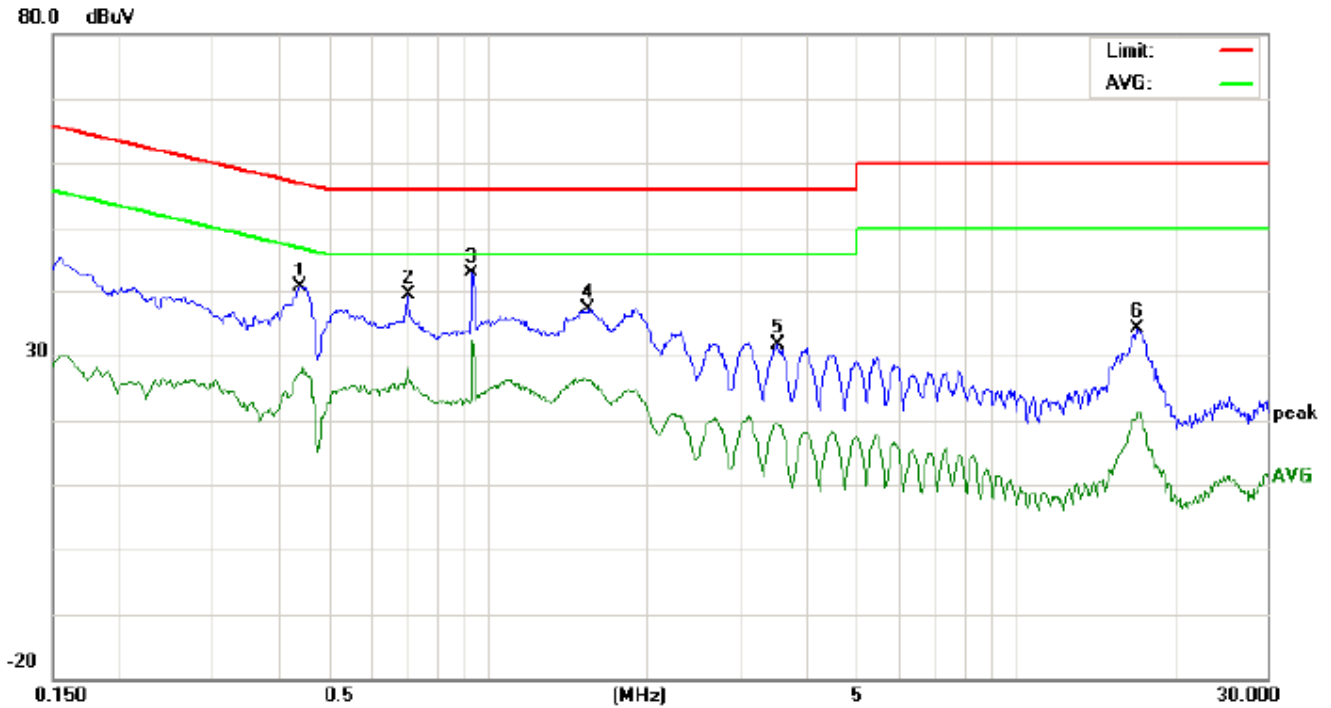

Site: Conduction Phase: **N** Temperature: 23.4  
Limit: FCC Class B Conduction(QP) Power: Humidity: 55.2 %  
EUT: Bluetooth Earphone  
M/N: MetalForgeAir  
Mode: BT Link with charging  
Note:

| No. | Freq. (MHz) | Reading_Level (dBuV) |    |       | Correct Factor (dB) | Measurement (dBuV) |    |       | Limit (dBuV) |       | Margin (dB) |        | P/F | Comment |
|-----|-------------|----------------------|----|-------|---------------------|--------------------|----|-------|--------------|-------|-------------|--------|-----|---------|
|     |             | Peak                 | QP | AVG   |                     | Peak               | QP | AVG   | QP           | AVG   | QP          | AVG    |     |         |
| 1   | 0.4420      | 30.22                |    | 17.07 | 10.36               | 40.58              |    | 27.43 | 57.02        | 47.02 | -16.44      | -19.59 | P   |         |
| 2   | 0.7059      | 28.94                |    | 17.85 | 10.35               | 39.29              |    | 28.20 | 56.00        | 46.00 | -16.71      | -17.80 | P   |         |
| 3   | 0.9379      | 32.37                |    | 22.03 | 10.39               | 42.76              |    | 32.42 | 56.00        | 46.00 | -13.24      | -13.58 | P   |         |
| 4   | 1.5540      | 26.84                |    | 15.70 | 10.36               | 37.20              |    | 26.06 | 56.00        | 46.00 | -18.80      | -19.94 | P   |         |
| 5   | 3.5339      | 21.21                |    | 8.94  | 10.50               | 31.71              |    | 19.44 | 56.00        | 46.00 | -24.29      | -26.56 | P   |         |
| 6   | 17.1058     | 24.10                |    | 10.85 | 10.13               | 34.23              |    | 20.98 | 60.00        | 50.00 | -25.77      | -29.02 | P   |         |

### APPENDIX A: PHOTOGRAPHS OF TEST SETUP

#### FCC LINE CONDUCTED EMISSION TEST SETUP



#### FCC RADIATED EMISSION TEST SETUP

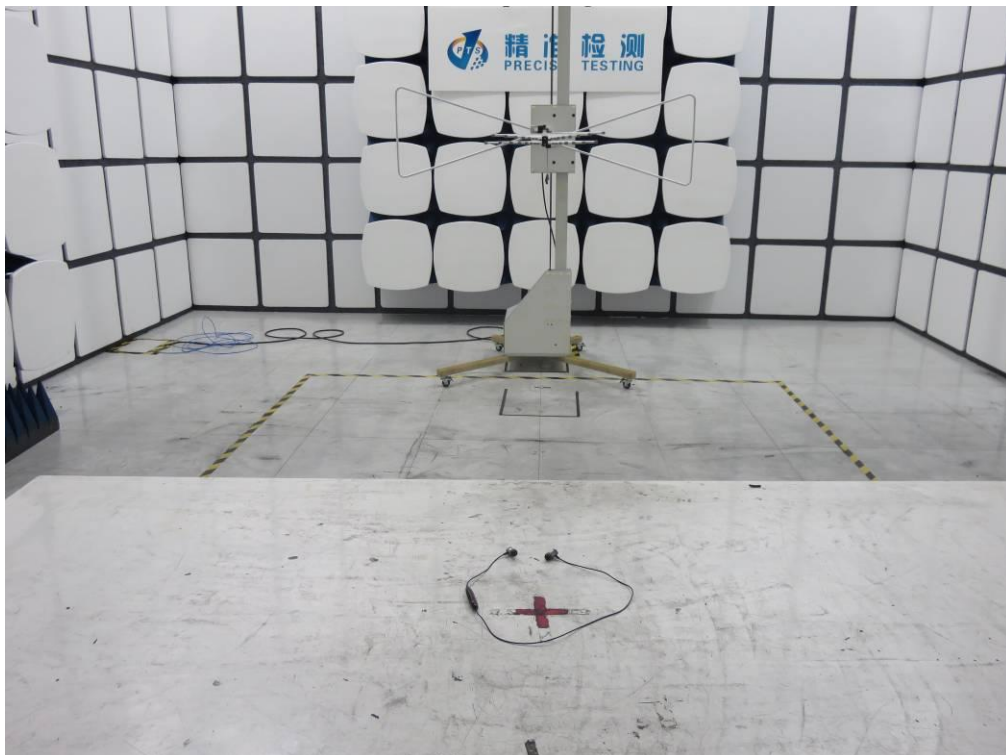

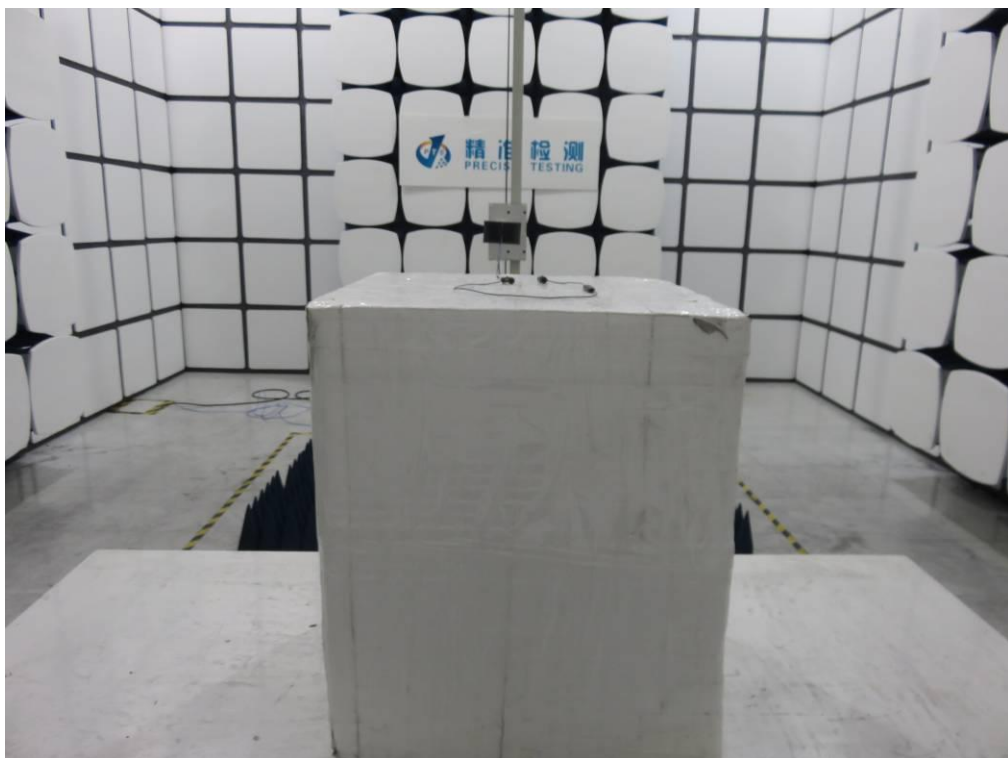
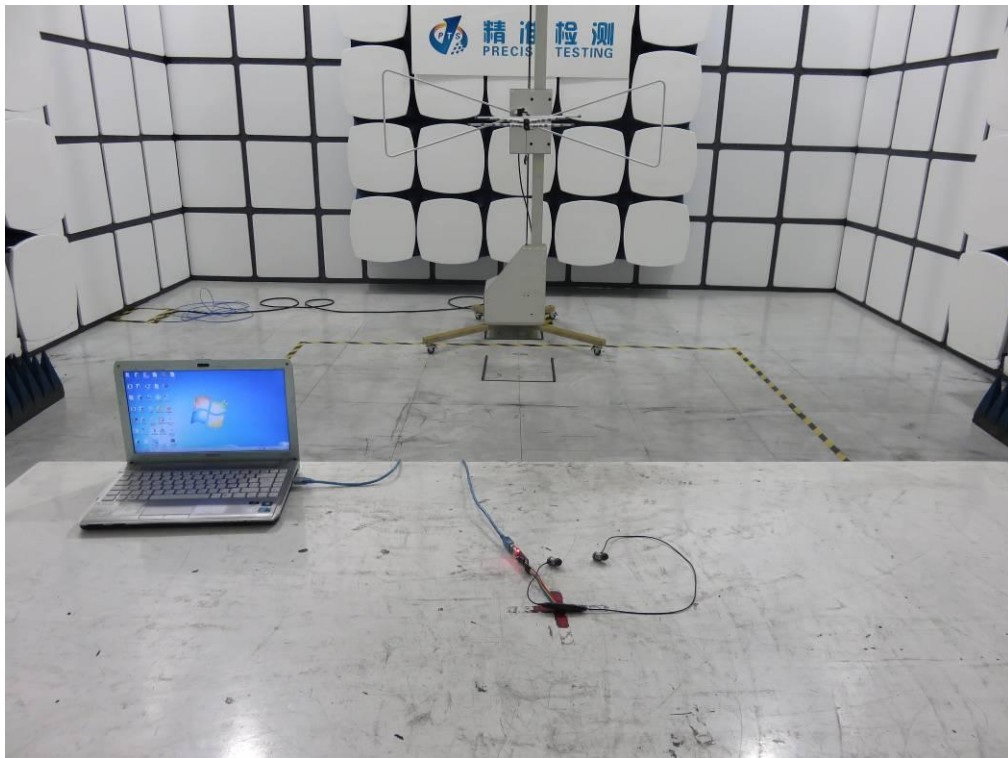



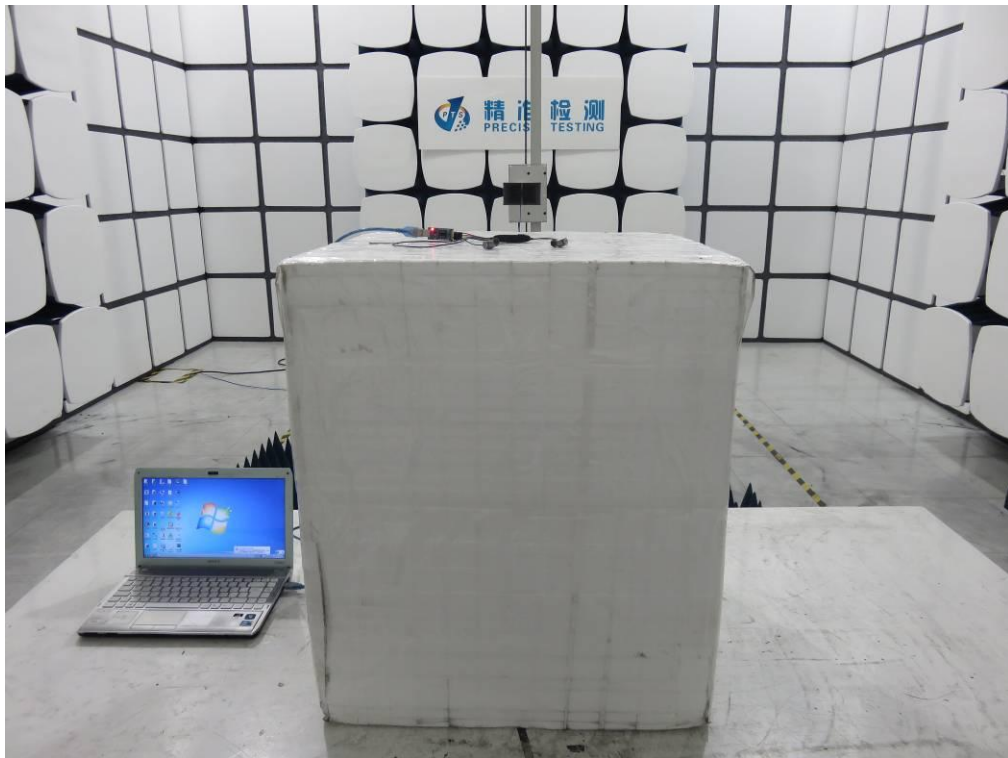

**APPENDIX B: PHOTOGRAPHS OF EUT**  
TOP VIEW OF EUT



**BOTTOM VIEW OF EUT**



FRONT VIEW OF EUT



BACK VIEW OF EUT





LEFT VIEW OF EUT



RIGHT VIEW OF EUT



VIEW OF EUT (PORT)



OPEN VIEW OF EUT

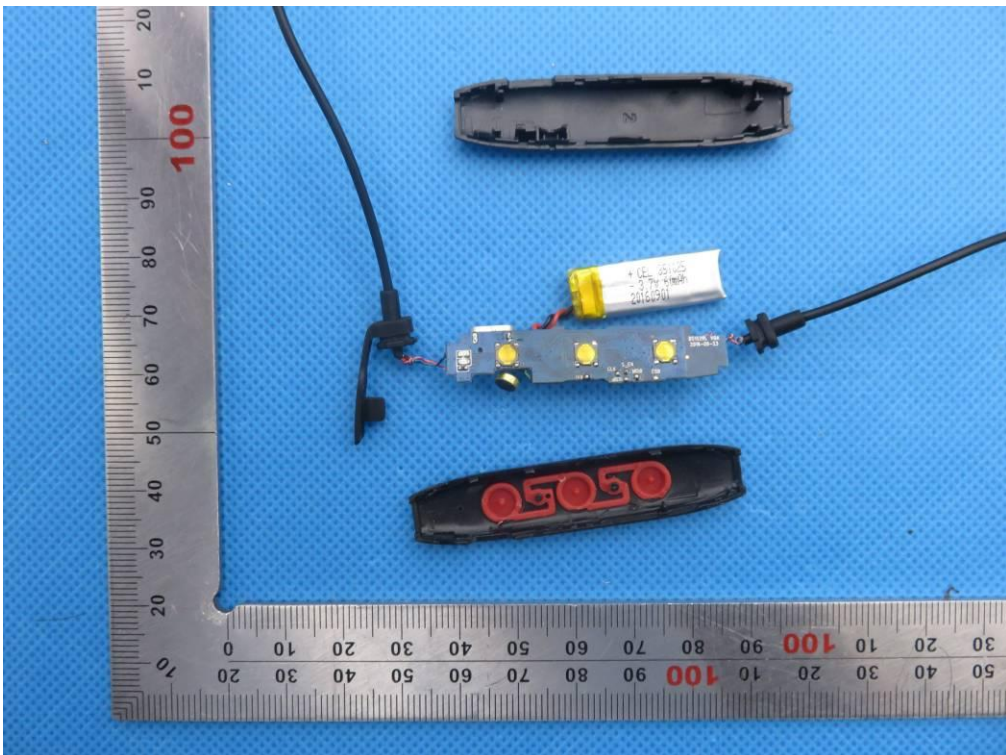



INTERNAL VIEW OF EUT-1

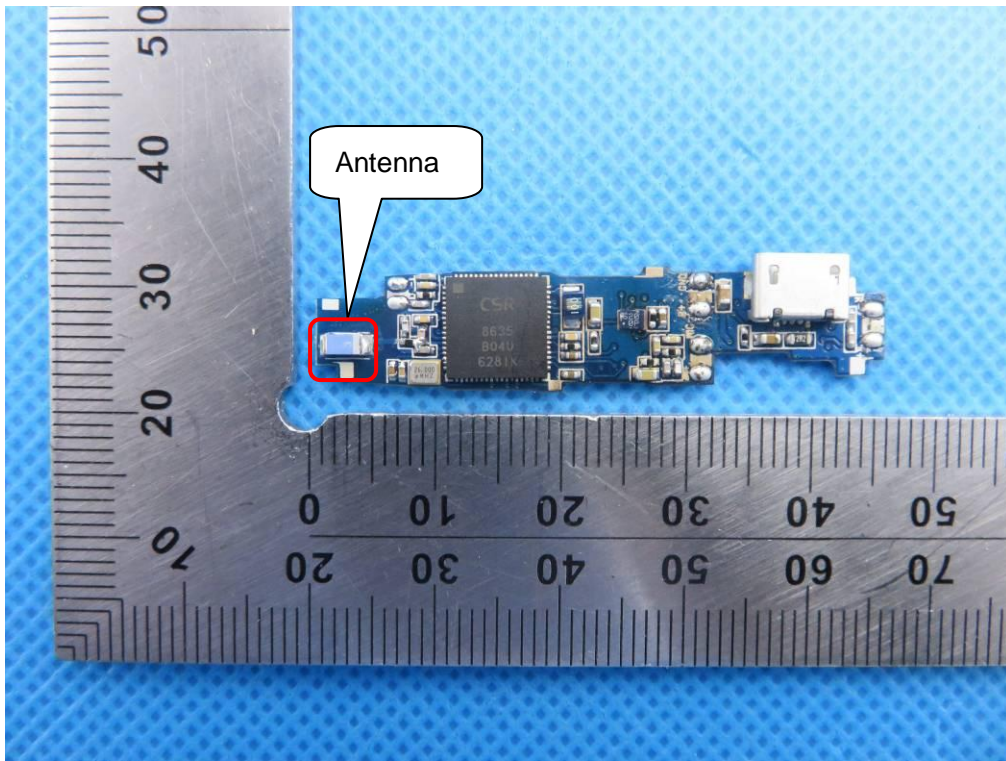

INTERNAL VIEW OF EUT-2

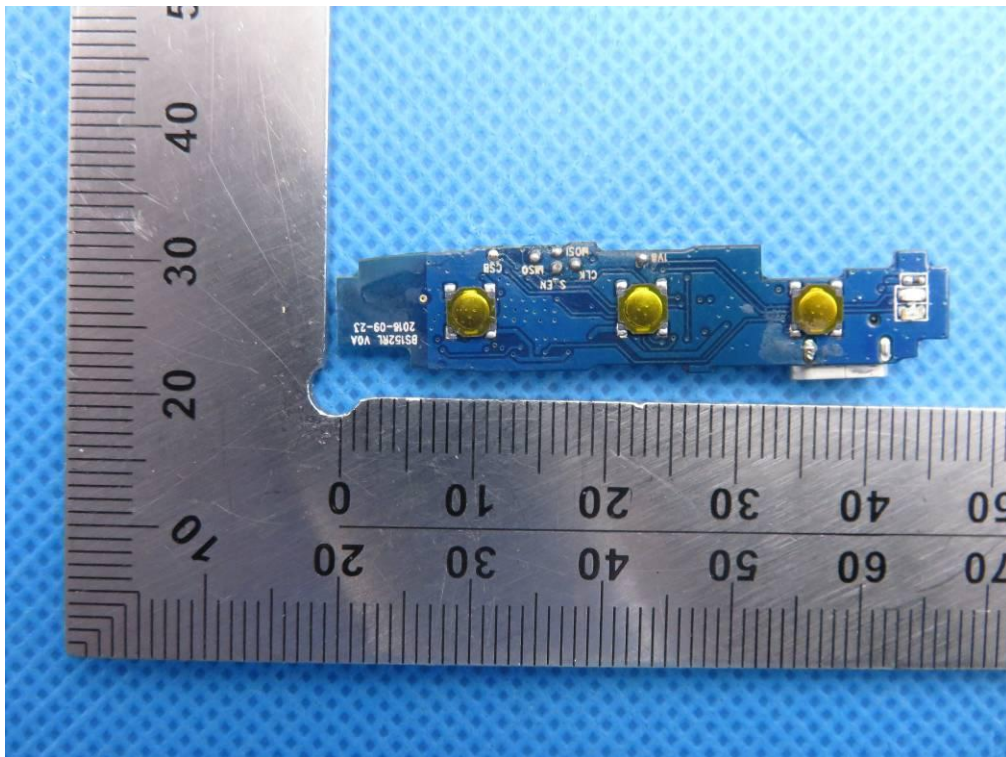

INTERNAL VIEW OF EUT-3

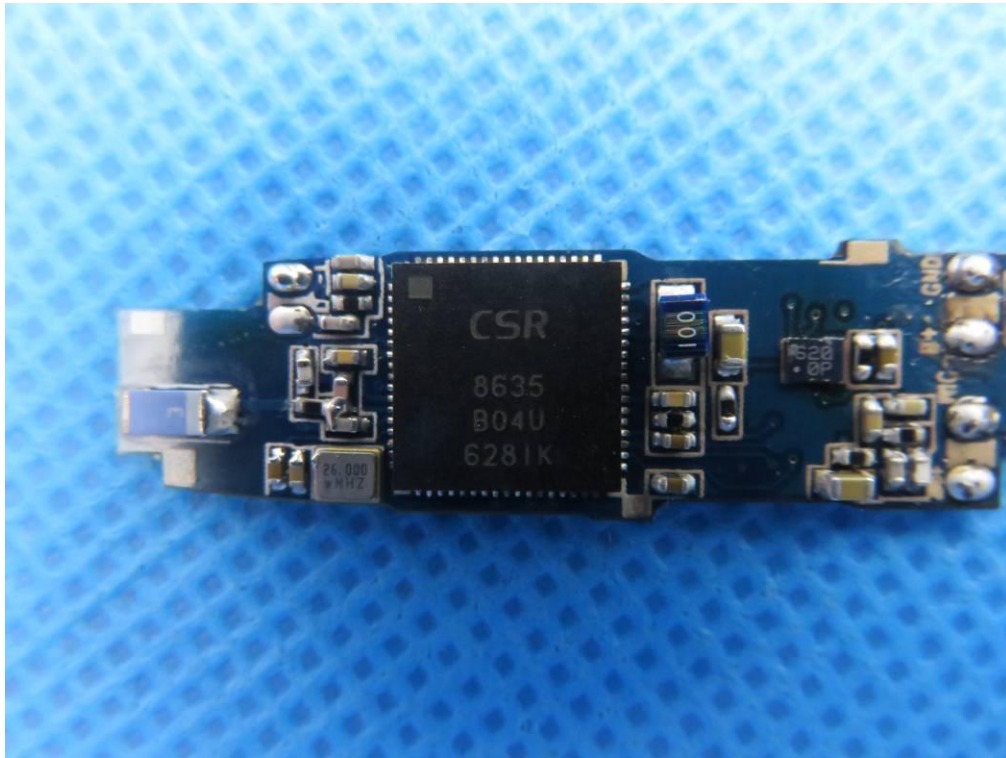

VIEW OF ADAPTER(AE)



The adapter was supplied by AGC

----END OF REPORT----