



FCC 47 CFR PART 15 SUBPART C

TEST REPORT

For

Applicant: iLuv Creative Technology

Address: 2 Harbor Park Drive, Port Washington, NY11050, USA

Product Name: Bluetooth Wireless Speaker

Model Name: IMM157, IMM157B

Brand Name: iLuv

FCC ID: ATL-IMM157

Report No.: MTE/CLY/D12091274

Date of Issue: Sep. 11, 2012

Issued by: Most Technology Service Co., Ltd.

Address : No.5, Langshan 2nd Road, North District, Hi-tech Industrial Park,
Nanshan, Shenzhen, Guangdong, China

Tel : 86-755-8617 0306

Fax : 86-755-8617 0310

The report consists 45 pages in total. It may be duplicated completely for legal use with the approval of the applicant. It should not be reproduced except in full, without the written approval of our laboratory. The client should not use it to claim product endorsement by MOST. The test results in the report only apply to the tested sample. The test report shall be invalid without all the signatures of testing engineers, reviewer and approver.

TABLE OF CONTENTS

1. VERIFICATION OF CONFORMITY..... 4

2. GENERAL INFORMATION..... 5

2.1 Product Information 5

2.2 Objective 6

2.3 Test Standards and Results..... 6

2.4 Environmental Conditions..... 6

2.5 MEASUREMENT UNCERTAINTY 6

3. TEST FACILITY..... 7

3.1 TEST FACILITY..... 7

3.2 Test Conditions..... 7

3.3 Channel List 8

3.4 Description of Test Modes 8

3.5 Table of Parameters of Text Software Setting..... 9

3.6 FCC PART 15.205 RESTRICTED BANDS OF OPERATIONS..... 10

4. SETUP OF EQUIPMENT UNDER TEST..... 11

4.1 SUPPORT EQUIPMENT 11

4.2 TEST EQUIPMENT LIST..... 12

5. 47 CFR Part 15C 15.249 Requirements..... 13

5.1 Spurious Emission Test 13

5.1.1 Requirement..... 13

5.1.2 Test Description..... 14

5.1.3 Test Description..... 15

5.1.5 Test Result..... 16

5.2 Band Edge..... 22

5.2.1 Requirement..... 22

5.2.2 Test Description..... 22

5.2.3 Test Result..... 22

5.3 LINE CONDUCTED EMISSION TEST 25

5.3.1. LIMITS OF LINE CONDUCTED EMISSION TEST..... 25

5.3.2. BLOCK DIAGRAM OF TEST SETUP..... 25

5.3.3. PRELIMINARY PROCEDURE OF LINE CONDUCTED EMISSION TEST 26

5.3.4. FINAL PROCEDURE OF LINE CONDUCTED EMISSION TEST 26

5.3.5. Test result..... 26

5.3.5. TEST RESULT OF LINE CONDUCTED EMISSION TEST 26

5.4 20 dB Bandwidth 29

5.4.1 Definition 29

5.4.2 Block Diagram Of Test Setup 29

5.4.3 Test Result..... 29

APPENDIX 1 31

PHOTOGRAPHS OF TEST SETUP..... 31

1. VERIFICATION OF CONFORMITY

Equipment Under Test: Bluetooth Wireless Speaker
Brand Name: iLuv
Model Number: IMM157
Series Number: IMM157B
Description of Differences: The series models are different in model name with the same functions.
FCC ID: ATL-IMM157
Applicant: iLuv Creative Technology
 2 Harbor Park Drive, Port Washington, NY11050, USA
Manufacturer: Wonders Technology Co., Ltd.
 DOSS Industrial Zone, Qiping Kengdu Industrial Area Guihua Village,
 Guanlan Town Baoan District, Shenzhen, China
Technical Standards: 47 CFR Part 15 Subpart C
File Number: MTE/CLY/D12091274
Date of test: Sep. 05-07, 2012
Deviation: None
Condition of Test Sample: Normal
Test Result: PASS

The above equipment was tested by MOST for compliance with the requirements set forth in FCC rules and the Technical Standards mentioned above. This said equipment in the configuration described in this report shows the maximum emission levels emanating from equipment and the level of the immunity endurance of the equipment are within the compliance requirements.

The test results of this report relate only to the tested sample identified in this report.

Prepare by (+ signature): 

 Carol Yin Sep. 09, 2012

Review by (+ signature): 

 Elva Wong Sep. 10, 2012

Approved by (+ signature): 

 Yvette Zhou(Manager) Sep. 11, 2012



2. GENERAL INFORMATION

2.1 Product Information

| | |
|------------------------------------|--|
| Product: | Bluetooth Wireless Speaker |
| Trade Name: | iLuv |
| Model Number: | iMM157 |
| Series Number: | iMM157B |
| Description of Differences: | The series models are different in model name with the same functions. |
| Power Supply: | Input: 100-240V~, 50-60Hz, 0.3A Output: 5Vdc |
| Frequency Range: | 2402MHz -2480MHz |
| Modulation Type: | GFSK |
| Modulation Technique: | FHSS |
| Antenna Type: | Internal Fixed |
| Antenna Gain: | 4.0dBi |
| Channel Spacing: | 1MHz |
| Channel Number: | 79 |
| Temperature Range: | -40°C ~ +80°C |

NOTE:

1. For a more detailed features description about the EUT, please refer to User's Manual.
2. USB Port only has charging function without data transmission.

2.2 Objective

Perform FCC Part 15 Subpart C tests for FCC Marking.

2.3 Test Standards and Results

Test items and the results are as bellow:

| No. | Section | Description | Result | Date of Test |
|-----|-----------|------------------------------------|--------|--------------|
| 1 | 15.249(a) | Spurious Emission | PASS | 2012-09-07 |
| 2 | 15.249(a) | Band Edge | PASS | 2012-09-05 |
| 3 | 15.207 | Power Line Conducted Emission Test | PASS | 2012-09-07 |
| 4 | 15.249 | 20dB Bandwidth | PASS | 2012-09-05 |

Note: 1. The test result judgment is decided by the limit of measurement standard
2. The information of measurement uncertainty is available upon the customer's request.

2.4 Environmental Conditions

During the measurement the environmental conditions were within the listed ranges:

- Temperature: 15-35°C
- Humidity: 30-60 %
- Atmospheric pressure: 86-106 kPa

2.5 MEASUREMENT UNCERTAINTY

The uncertainty is calculated using the methods suggested in the "Guide to the Expression of Uncertainty in Measurement" (GUM) published by ISO.

The report uncertainty of measurement $y \pm U$, where expanded uncertainty U is based on a standard uncertainty multiplied by a coverage factor of $k=2$, Providing a level of confidence of approximately 95%

- Uncertainty of Conducted Emission, $U_c = \pm 1.8\text{dB}$
- Uncertainty of Radiated Emission, $U_c = \pm 3.2\text{dB}$

3. TEST FACILITY

3.1 TEST FACILITY

| | |
|-----------------------|---|
| Test Site: | Most Technology Service Co., Ltd. |
| Location: | No.5, Langshan 2nd Rd., North Hi-Tech Industrial park, Nanshan, Shenzhen, Guangdong, China |
| Description: | <p>There is one 3m semi-anechoic an area test sites and two line conducted labs for final test. The Open Area Test Sites and the Line Conducted labs are constructed and calibrated to meet the FCC requirements in documents ANSI C63.4:2009 and CISPR 16 requirements.</p> <p>The FCC Registration Number is 490827.</p> <p>The IC Registration Number is 46405-7103.</p> <p>The CNAS Registration Number is CNAS L3573.</p> |
| Site Filing: | The site description is on file with the Federal Communications Commission, 7435 Oakland Mills Road, Columbia, MD 21046. |
| Instrument Tolerance: | All measuring equipment is in accord with ANSI C63.4:2009 and CISPR 16 requirements that meet industry regulatory agency and accreditation agency requirement. |
| Ground Plane: | Two conductive reference ground planes were used during the Line Conducted Emission, one in vertical and the other in horizontal. The dimensions of these ground planes are as below. The vertical ground plane was placed distancing 40 cm to the rear of the wooden test table on where the EUT and the support equipment were placed during test. The horizontal ground plane projected 50 cm beyond the footprint of the EUT system and distanced 80 cm to the wooden test table. For Radiated Emission Test, one horizontal conductive ground plane extended at least 1m beyond the periphery of the EUT and the largest measuring antenna, and covered the entire area between the EUT and the antenna. |

3.2 Test Conditions

The EUT has been tested under normal operating (TX) and standby (RX) condition.

The field strength of radiation emission was measured in the following position: EUT stand-up position (Y axis), lie-down position (X, Z axis).

The following data show only with the worst case setup.

The worst case of Y axis was reported.

Based on client request, all normal using modes of the normal function were tested but only the worst test data of the worst mode is reported by this report.

3.3 Channel List

| Channel List for GFSK Mode | | | | | |
|----------------------------|-----------------|---------|-----------------|---------|-----------------|
| Channel | Frequency (MHz) | Channel | Frequency (MHz) | Channel | Frequency (MHz) |
| 01 | 2402MHz | 28 | 2429MHz | 55 | 2456MHz |
| 02 | 2403MHz | 29 | 2430MHz | 56 | 2457MHz |
| 03 | 2404MHz | 30 | 2431MHz | 57 | 2458MHz |
| 04 | 2405MHz | 31 | 2432MHz | 58 | 2459MHz |
| 05 | 2406MHz | 32 | 2433MHz | 59 | 2460MHz |
| 06 | 2407MHz | 33 | 2434MHz | 60 | 2461MHz |
| 07 | 2408MHz | 34 | 2435MHz | 61 | 2462MHz |
| 08 | 2409MHz | 35 | 2436MHz | 62 | 2463MHz |
| 09 | 2410MHz | 36 | 2437MHz | 63 | 2464MHz |
| 10 | 2411MHz | 37 | 2438MHz | 64 | 2465MHz |
| 11 | 2412MHz | 38 | 2439MHz | 65 | 2466MHz |
| 12 | 2413MHz | 39 | 2440MHz | 66 | 2467MHz |
| 13 | 2414MHz | 40 | 2441MHz | 67 | 2468MHz |
| 14 | 2415MHz | 41 | 2442MHz | 68 | 2469MHz |
| 15 | 2416MHz | 42 | 2443MHz | 69 | 2470MHz |
| 16 | 2417MHz | 43 | 2444MHz | 70 | 2471MHz |
| 17 | 2418MHz | 44 | 2445MHz | 71 | 2472MHz |
| 18 | 2419MHz | 45 | 2446MHz | 72 | 2473MHz |
| 19 | 2420MHz | 46 | 2447MHz | 73 | 2474MHz |
| 20 | 2421MHz | 47 | 2448MHz | 74 | 2475MHz |
| 21 | 2422MHz | 48 | 2449MHz | 75 | 2476MHz |
| 22 | 2423MHz | 49 | 2450MHz | 76 | 2477MHz |
| 23 | 2424MHz | 50 | 2451MHz | 77 | 2478MHz |
| 24 | 2425MHz | 51 | 2452MHz | 78 | 2479MHz |
| 25 | 2426MHz | 52 | 2453MHz | 79 | 2480MHz |
| 26 | 2427MHz | 53 | 2454MHz | | |
| 27 | 2428MHz | 54 | 2455MHz | | |

3.4 Description of Test Modes

To investigate the maximum EMI emission characteristics generates from EUT, the test system was pre-scanning tested base on the consideration of following EUT operation mode or test configuration mode which possible have effect on EMI emission level, Each of these EUT operation mode(s) or test configuration mode(s) mentioned above was evaluated respectively

| Pre-test Mode | Description |
|---------------|---------------------|
| Mode 1 | GFSK CH01/CH41/CH79 |

Note:

The measurements are performed at the highest, middle, lowest available channels.

The measurements are performed at all bit rate of transmitter, the worst data was reported.

3.5 Table of Parameters of Text Software Setting

During testing channel & power controlling software provided by the customer was used to control the operating channel as well as the output power level, the RF output power selection is for the setting of RF output power expected by the customer and is going to be fixed on the firmware of the final end product power parameters of Bluetooth.

| Test software Version | Test program:N/A | | |
|-----------------------|------------------|---------|---------|
| GFSK Mode | 2402MHz | 2442MHz | 2480MHz |

Conducted Emissions

The EUT is placed on the turntable, which is 0.8 m above ground plane. According to the requirements in Section 13.1.4.1 of ANSI C63.4:2009,Conducted emissions from the EUT measured in the frequency range between 0.15 MHz and 30MHz using CISPR Quasi-peak and average detector modes.

Radiated Emissions

The EUT is placed on a turn table, which is 0.8 m above ground plane. The turntable shall rotate 360 degrees to determine the position of maximum emission level. EUT is set 3m away from the receiving antenna, which varied from 1m to 4m to find out the highest emission. And also, each emission was to be maximized by changing the polarization of receiving antenna both horizontal and vertical. In order to find out the maximum emissions, exploratory radiated emission measurements were made according to the requirements in Section 13.1.4.1 of ANSI C63.4:2009.

3.6 FCC PART 15.205 RESTRICTED BANDS OF OPERATIONS

(a) Except as shown in paragraph (d) of this section, only spurious emissions are permitted in any of the frequency bands listed below:

| MHz | MHz | MHz | GHz |
|----------------------------|-----------------------|-----------------|------------------|
| 0.090 - 0.110 | 16.42 - 16.423 | 399.9 - 410 | 4.5 - 5.15 |
| ¹ 0.495 - 0.505 | 16.69475 - 16.69525 | 608 - 614 | 5.35 - 5.46 |
| 2.1735 - 2.1905 | 16.80425 - 16.80475 | 960 - 1240 | 7.25 - 7.75 |
| 4.125 - 4.128 | 25.5 - 25.67 | 1300 - 1427 | 8.025 - 8.5 |
| 4.17725 - 4.17775 | 37.5 - 38.25 | 1435 - 1626.5 | 9.0 - 9.2 |
| 4.20725 - 4.20775 | 73 - 74.6 | 1645.5 - 1646.5 | 9.3 - 9.5 |
| 6.215 - 6.218 | 74.8 - 75.2 | 1660 - 1710 | 10.6 - 12.7 |
| 6.26775 - 6.26825 | 108 - 121.94 | 1718.8 - 1722.2 | 13.25 - 13.4 |
| 6.31175 - 6.31225 | 123 - 138 | 2200 - 2300 | 14.47 - 14.5 |
| 8.291 - 8.294 | 149.9 - 150.05 | 2310 - 2390 | 15.35 - 16.2 |
| 8.362 - 8.366 | 156.52475 - 156.52525 | 2483.5 - 2500 | 17.7 - 21.4 |
| 8.37625 - 8.38675 | 156.7 - 156.9 | 2655 - 2900 | 22.01 - 23.12 |
| 8.41425 - 8.41475 | 162.0125 - 167.17 | 3260 - 3267 | 23.6 - 24.0 |
| 12.29 - 12.293 | 167.72 - 173.2 | 3332 - 3339 | 31.2 - 31.8 |
| 12.51975 - 12.52025 | 240 - 285 | 3345.8 - 3358 | 36.43 - 36.5 |
| 12.57675 - 12.57725 | 322 - 335.4 | 3600 - 4400 | (²) |
| 13.36 - 13.41 | | | |

¹ Until February 1, 1999, this restricted band shall be 0.490-0.510 MHz.

² Above 38.6

(b) Except as provided in paragraphs (d) and (e), the field strength of emissions appearing within these frequency bands shall not exceed the limits shown in Section 15.209. At frequencies equal to or less than 1000 MHz, compliance with the limits in Section 15.209 shall be demonstrated using measurement instrumentation employing a CISPR quasi-peak detector. Above 1000 MHz, compliance with the emission limits in Section 15.209 shall be demonstrated based on the average value of the measured emissions. The provisions in Section 15.35 apply to these measurements.

4. SETUP OF EQUIPMENT UNDER TEST

4.1 SUPPORT EQUIPMENT

| Device Type | Manufacturer | Model Name | Serial No. | Data Cable | Power Cable |
|-------------|--------------|------------|------------|------------|-------------|
| --- | --- | --- | --- | --- | --- |

Remark:

All the equipment/cables were placed in the worst-case configuration to maximize the emission during the test. Grounding was established in accordance with the manufacturer's requirements and conditions for the intended use.

4.2 TEST EQUIPMENT LIST

Instrumentation: The following list contains equipment used at Most for testing. The equipment conforms to the CISPR 16-1 / ANSI C63.2 Specifications for Electromagnetic Interference and Field Strength Instrumentation from 10 kHz to 1.0 GHz or above.

| No. | Equipment | Manufacturer | Model No. | S/N | Calculator date | Calculator Interval |
|-----|--------------------------------------|-------------------|-----------------|-------------|-----------------|---------------------|
| 1 | Test Receiver | Rohde & Schwarz | ESCI | 100492 | 2012/03/14 | 1 Year |
| 2 | L.I.S.N. | Rohde & Schwarz | ENV216 | 100093 | 2012/03/14 | 1 Year |
| 3 | Coaxial Switch | Anritsu Corp | MP59B | 6200283933 | 2012/03/14 | 1 Year |
| 4 | Terminator | Hubersuhner | 50 _Ω | No.1 | 2012/03/14 | 1 Year |
| 5 | RF Cable | SchwarzBeck | N/A | No.1 | 2012/03/14 | 1 Year |
| 6 | Test Receiver | Rohde & Schwarz | ESPI | 101202 | 2012/03/14 | 1 Year |
| 7 | Bilog Antenna | SCHWARZBECK | BBHA9120D | D69250 | 2012/03/14 | 1 Year |
| 8 | Cable | Resenberger | N/A | NO.1 | 2012/03/14 | 1 Year |
| 9 | Cable | SchwarzBeck | N/A | NO.2 | 2012/03/14 | 1 Year |
| 10 | Cable | SchwarzBeck | N/A | NO.3 | 2012/03/14 | 1 Year |
| 11 | DC Power Filter | DuoJi | DL2×30B | N/A | 2012/03/14 | 1 Year |
| 12 | Single Phase Power Line Filter | DuoJi | FNF 202B30 | N/A | 2012/03/14 | 1 Year |
| 13 | 3 Phase Power Line Filter | DuoJi | FNF 402B30 | N/A | 2012/03/14 | 1 Year |
| 14 | Test Receiver | Rohde & Schwarz | ESCI | 100492 | 2012/03/14 | 1 Year |
| 15 | Absorbing Clamp | Luthi | MDS21 | 3635 | 2012/03/14 | 1 Year |
| 16 | Coaxial Switch | Anritsu Corp | MP59B | 6200283933 | 2012/03/14 | 1 Year |
| 17 | AC Power Source | Kikusui | AC40MA | LM003232 | 2012/03/14 | 1 Year |
| 18 | Test Analyzer | Kikusui | KHA1000 | LM003720 | 2012/03/14 | 1 Year |
| 19 | Line Impedence Network | Kikusui | LIN40MA-PCR-L | LM002352 | 2012/03/14 | 1 Year |
| 20 | ESD Tester | Kikusui | KES4021 | LM003537 | 2012/03/14 | 1 Year |
| 21 | EMC PRO System | EM Test | UCS-500-M4 | V0648102026 | 2012/03/14 | 1 Year |
| 22 | Signal Generator | IFR | 2032 | 203002/100 | 2012/03/14 | 1 Year |
| 23 | Amplifier | A&R | 150W1000 | 301584 | 2012/03/14 | 1 Year |
| 24 | CDN | FCC | FCC-801-M2-25 | 47 | 2012/03/14 | 1 Year |
| 25 | CDN | FCC | FCC-801-M3-25 | 107 | 2012/03/14 | 1 Year |
| 26 | EM Injection Clamp | FCC | F-203I-23mm | 403 | 2012/03/14 | 1 Year |
| 27 | RF Cable | MIYAZAKI | N/A | No.1/No.2 | 2012/03/14 | 1 Year |
| 28 | Universal Radio Communication Tester | ROHDE&SCHWARZ | CMU200 | 0304789 | 2012/03/14 | 1 Year |
| 29 | Telecommunication Antenna | European Antennas | PSA 75301R/170 | 0304213 | 2012/03/14 | 1 Year |
| 30 | Telecommunication Test Equipment | R&S | CMU200 | N/A | 2012/03/14 | 1 Year |
| 31 | 8 Loop Antenna | ARA | PLA-1030/B | 1029 | 2012/02/19 | 1 Year |

NOTE: Equipments listed above have been calibrated and are in the period of validation.

5. 47 CFR Part 15C 15.249 Requirements

5.1 Spurious Emission Test

5.1.1 Requirement

According to FCC section 15.249(a):

Except as provided in paragraph (a) of this section, the field strength of emissions from intentional radiators operated within these frequency bands shall comply with the following:

| Fundamental Frequency (MHz) | Field Strength of Fundamental (mV/m) | Field Strength of Harmonics (µV/m) |
|-----------------------------|--------------------------------------|------------------------------------|
| 902-928 | 50 | 500 |
| 2400-2483.5 | 50 | 500 |
| 5725-5875 | 50 | 500 |
| 24000-24250 | 250 | 2500 |

According to FCC section 15.109 (a), except as provided elsewhere in this subpart, the emissions from an intentional radiator shall not exceed the field strength levels specified in the following table:

| Frequency (MHz) | Field Strength (µV/m) | Measurement Distance (m) |
|-----------------|-----------------------|--------------------------|
| 1.705 – 30.0 | 30 | 30 |
| 30 – 88 | 100 | 3 |
| 88 – 216 | 150 | 3 |
| 216 – 960 | 200 | 3 |
| Above 960 | 500 | 3 |

Remark: Except as provided in paragraph (g), fundamental emissions from intentional radiators operating under this Section shall not be located in the frequency bands 54-72 MHz, 76-88 MHz, 174-216 MHz or 470-806 MHz. However, operation within these frequency bands is permitted under other sections of this Part, e.g., Sections 15.231 and 15.241.

In the above emission table, the tighter limit applies at the band edges.

| Frequency (MHz) | Field Strength (µV/m) | Measurement Distance (m) |
|-----------------|-----------------------|--------------------------|
| 30 – 88 | 100 | 3 |
| 88 – 216 | 150 | 3 |
| 216 – 960 | 200 | 3 |
| Above 960 | 500 | 3 |

5.1.2 Test Description

Test Setup:

From 9KHz to 30MHz:

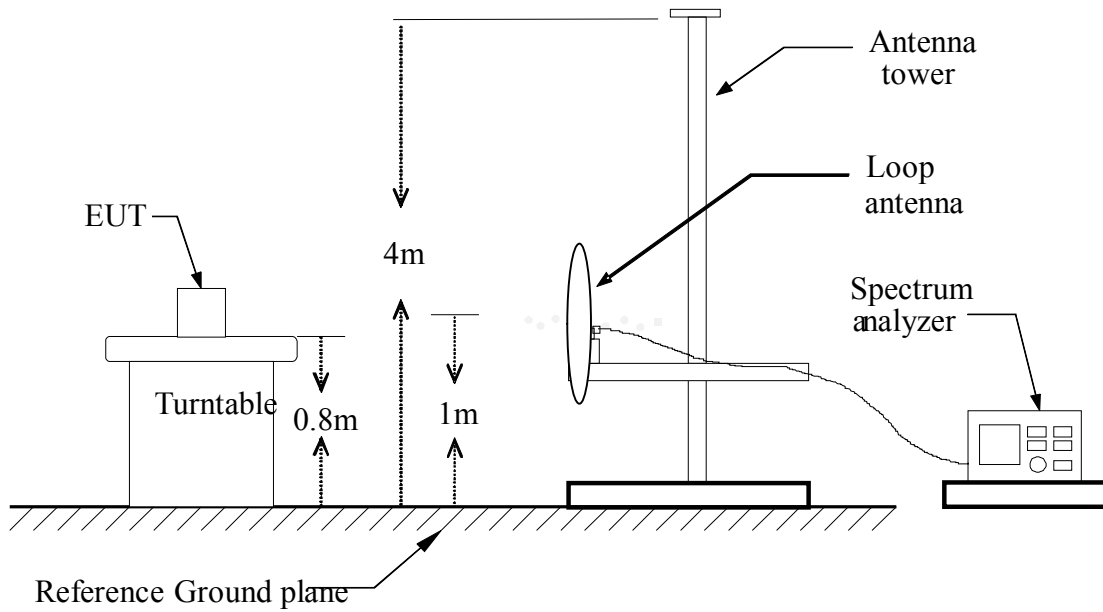

From 30MHz to 1GHz:

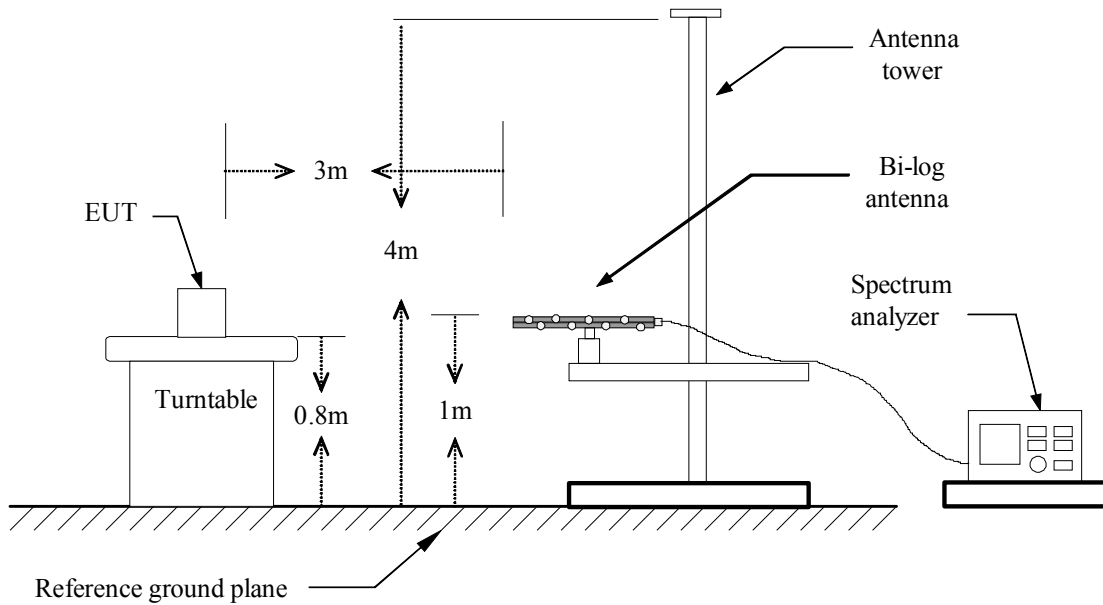

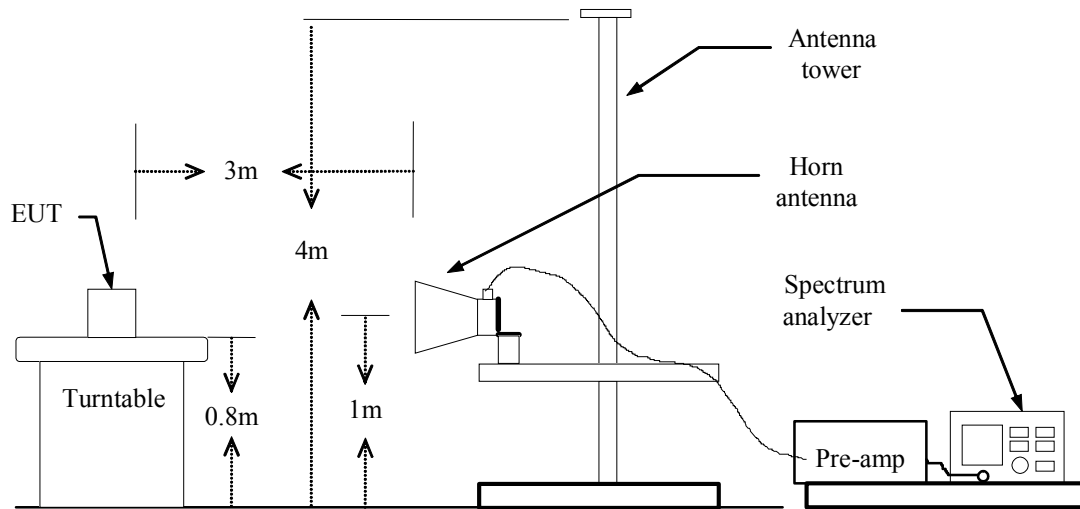
Above 1GHz:**5.1.3 Test Description**

1. The EUT is placed on a turntable, which is 0.8m above ground plane.
2. The turntable shall be rotated for 360 degrees to determine the position of maximum emission level.
3. EUT is set 3m away from the receiving antenna, which is varied from 1m to 4m to find out the highest emissions.
4. Maximum procedure was performed on the six highest emissions to ensure EUT compliance.
5. And also, each emission was to be maximized by changing the polarization of receiving antenna both horizontal and vertical.
6. Set the spectrum analyzer in the following setting as:
 Below 1GHz: RBW=100 kHz / VBW=300 kHz / Sweep=AUTO
 Above 1GHz ☹ a) PEAK: RBW=VBW=1MHz / Sweep=AUTO
 5.1.4 AVERAGE: RBW=1MHz / VBW=10Hz / Sweep=AUTO
7. Repeat above procedures until the measurements for all frequencies are complete.

5.1.5 Test Result

From 9 KHz to 30MHz:

| Freq. (MHz) | Ant. Pol H/V | Peak Reading (dBuV) | AV Reading (dBuV) | Ant. / CL CF (dB) | Actual Fs | | Peak Limit (dBuV/m) | AV Limit (dBuV/m) | AV Margin (dB) |
|-------------|--------------|---------------------|-------------------|-------------------|---------------|-------------|---------------------|-------------------|----------------|
| | | | | | Peak (dBuV/m) | AV (dBuV/m) | | | |
| N/A | H | | | | | | | | >20 |
| | | | | | | | | | |
| | | | | | | | | | |
| N/A | V | | | | | | | | >20 |
| | | | | | | | | | |
| | | | | | | | | | |

-Note: No test data was detected in below 30MHz.

From 30MHz to 1GHz:

The following test mode(s) were scanned during the preliminary test:

| Preliminary Radiated Emission Test | | | | |
|------------------------------------|------------|-------------------|----------|-------------------------------------|
| Frequency Range Investigated | | 9KHz TO 26 GHz | | |
| Mode of operation | Date | Report No. | Data# | Worst Mode |
| Bluetooth Mode | 2012-09-07 | MTE/CLY/D12091274 | 1_(V, H) | <input checked="" type="checkbox"/> |
| LINE INPUT Mode | 2012-09-07 | MTE/CLY/D12091274 | 1_(V, H) | <input type="checkbox"/> |

Note:

The Bluetooth model was carried out for GFSK modulation types, GFSK Low channel modulation type was the worst case condition, The test data was shown on the summary data page.



Address: No. 5, Langshan 2nd Rd., North Hi-Tech Industrial park
 Guangdong, China
 Tel: 0755-86170306 Fax: 0755-86170310

Radiated Emission Measurement

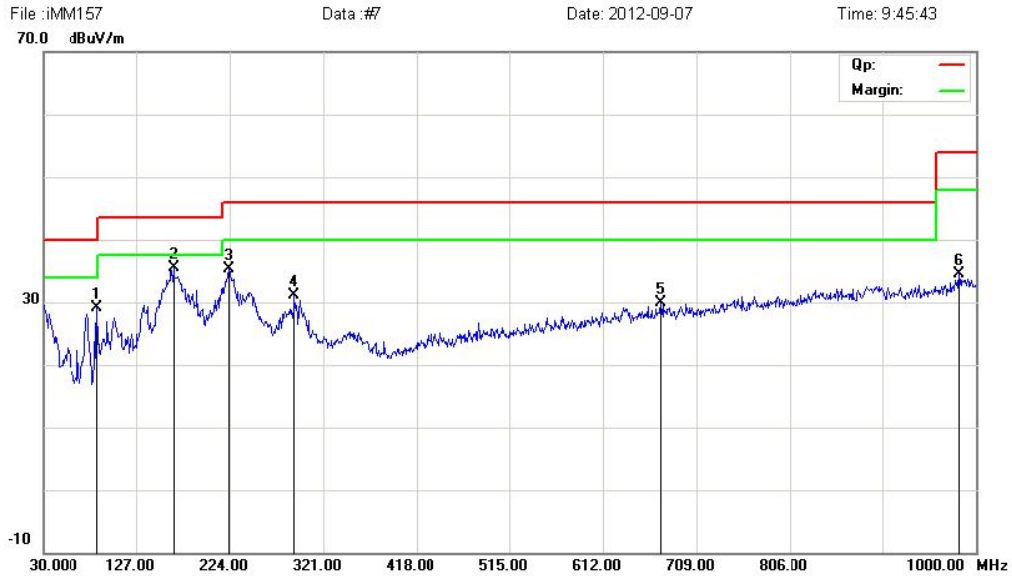

Site site #1 Polarization: **Vertical** Temperature: 26
 Limit: FCC Part 15 B 3M Radiation Power: DC 5V by AC adapter 120V/60Hz Humidity: 61 %
 EUT: Bluetooth Wireless Speaker Distance:
 M/N: IMM157
 Mode: Bluetooth Playing
 Note:

| No. | Mk. | Freq. | Reading Level | Correct Factor | Measurement | Limit | Over | Antenna Height | Table Degree | Comment |
|-----|-----|----------|---------------|----------------|-------------|--------|--------|----------------|--------------|---------|
| | | MHz | dBuV | dB | dBuV/m | dBuV/m | dB | cm | degree | |
| 1 | | 86.2600 | 17.86 | 11.33 | 29.19 | 40.00 | -10.81 | QP | 0 | |
| 2 | * | 165.8000 | 18.35 | 17.20 | 35.55 | 43.50 | -7.95 | QP | 0 | |
| 3 | | 223.0300 | 18.86 | 16.36 | 35.22 | 46.00 | -10.78 | QP | 0 | |
| 4 | | 290.9300 | 11.69 | 19.38 | 31.07 | 46.00 | -14.93 | QP | 0 | |
| 5 | | 672.1400 | 5.44 | 24.52 | 29.96 | 46.00 | -16.04 | QP | 0 | |
| 6 | | 982.5400 | 5.74 | 28.80 | 34.54 | 54.00 | -19.46 | QP | 0 | |

*:Maximum data x:Over limit l:over margin

Engineer Signature: Allen



Address: No. 5, Langshan 2nd Rd., North Hi-Tech Industrial park
 Guangdong, China
 Tel: 0755-86170306 Fax: 0755-86170310

Radiated Emission Measurement

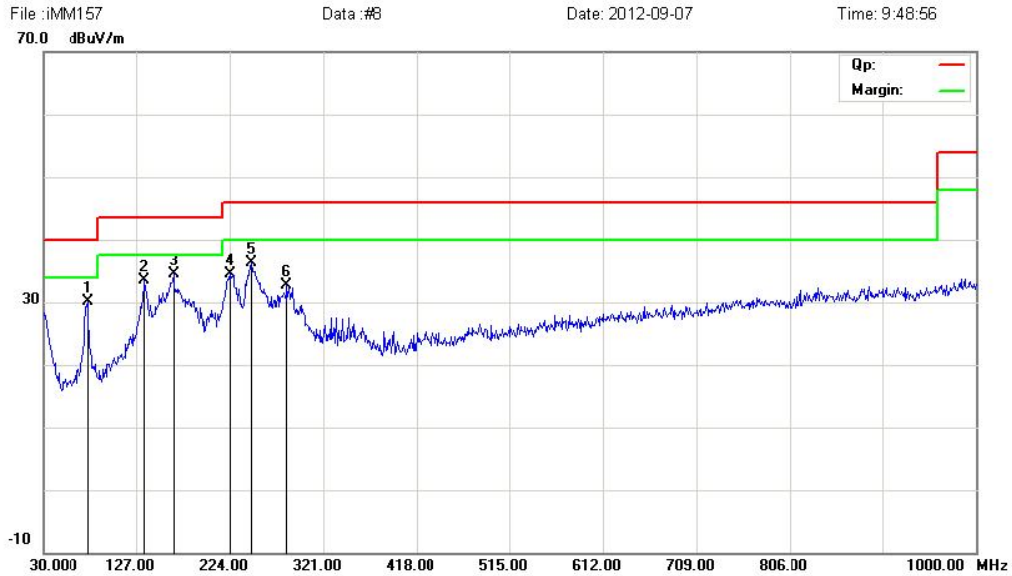

Site site #1 Polarization: **Horizontal** Temperature: 26
 Limit: FCC Part 15 B 3M Radiation Power: DC 5V by AC adapter 120V/60Hz Humidity: 61 %
 EUT: Bluetooth Wireless Speaker Distance:
 M/N: IMM157
 Mode: Bluetooth Playing
 Note:

| No. | Mk. | Freq. | Reading Level | Correct Factor | Measurement | Limit | Over | Antenna Height | Table Degree | Comment |
|-----|-----|----------|---------------|----------------|-------------|--------|--------|----------------|--------------|---------|
| | | MHz | dBuV | dB | dBuV/m | dBuV/m | dB | cm | degree | |
| 1 | | 76.5600 | 18.51 | 11.57 | 30.08 | 40.00 | -9.92 | QP | 0 | |
| 2 | | 135.7298 | 16.16 | 17.42 | 33.58 | 43.50 | -9.92 | QP | 0 | |
| 3 | * | 165.8000 | 17.35 | 17.20 | 34.55 | 43.50 | -8.95 | QP | 0 | |
| 4 | | 224.0000 | 18.11 | 16.38 | 34.49 | 46.00 | -11.51 | QP | 0 | |
| 5 | | 246.3100 | 18.97 | 17.40 | 36.37 | 46.00 | -9.63 | QP | 0 | |
| 6 | | 283.1700 | 13.24 | 19.43 | 32.67 | 46.00 | -13.33 | QP | 0 | |

*:Maximum data x:Over limit l:over margin

Engineer Signature: Allen

From 30MHz to 1GHz

Above 1 GHz

Operation Mode: GFSK Mode/CH Low **Test Date:** Sep. 07, 2012
Temperature: 20°C **Tested by:** Sky Guo
Humidity: 70 % RH **Polarity:** Ver. / Hor.

| Freq. (MHz) | Ant. Pol H/V | Peak Reading (dBuV) | AV Reading (dBuV) | Ant. / CL CF (dB) | Actual Fs | | Peak Limit (dBuV/m) | AV Limit (dBuV/m) | AV Margin (dB) |
|-------------|--------------|---------------------|-------------------|-------------------|---------------|-------------|---------------------|-------------------|----------------|
| | | | | | Peak (dBuV/m) | AV (dBuV/m) | | | |
| 2402.00 | H | 89.25 | 68.75 | 16.25 | 106.50 | 85.00 | 114.00 | 94.00 | -9.00 |
| 4804.00 | H | 45.37 | 21.94 | 20.18 | 65.55 | 42.12 | 74.00 | 54.00 | -11.88 |
| N/A | | | | | | | | | >20 |
| 2402.00 | V | 89.78 | 67.59 | 16.25 | 106.03 | 83.84 | 114.00 | 94.00 | -10.16 |
| 4804.00 | V | 44.82 | 23.19 | 20.18 | 65.00 | 43.37 | 74.00 | 54.00 | -10.63 |
| N/A | | | | | | | | | >20 |

Notes:

1. Measuring frequencies from 1 GHz to the 10th harmonic of highest fundamental frequency.
2. Measurements above show only up to 6 maximum emissions noted, or would be lesser if no specific emissions from the EUT are recorded (ie: margin>20dB from the applicable limit) and considered that's already beyond the background noise floor.
3. Radiated emissions measured in frequency above 1000MHz were made with an instrument using Peak detector mode and average detector mode of the emission shown in Actual FS column.
4. Spectrum setting:
 - a. Peak Setting 1GHz - 26GHz, RBW = 1MHz, VBW = 1MHz, Sweep time = 200 ms.
 - b. AV Setting 1GH z- 26GHz, RBW = 1MHz, VBW = 10Hz, Sweep time = 200 ms.

Operation Mode: GFSK Mode/CH High **Test Date:** Sep. 07, 2012
Temperature: 20°C **Tested by:** Sky Guo
Humidity: 70 % RH **Polarity:** Ver. / Hor.

| Freq. (MHz) | Ant. Pol H/V | Peak Reading (dBuV) | AV Reading (dBuV) | Ant. / CL CF (dB) | Actual Fs | | Peak Limit (dBuV/m) | AV Limit (dBuV/m) | AV Margin (dB) |
|-------------|--------------|---------------------|-------------------|-------------------|---------------|-------------|---------------------|-------------------|----------------|
| | | | | | Peak (dBuV/m) | AV (dBuV/m) | | | |
| 2480.00 | H | 87.94 | 64.58 | 17.24 | 105.18 | 81.82 | 114.00 | 94.00 | -12.18 |
| 4960.00 | H | 45.85 | 20.96 | 22.64 | 68.49 | 43.60 | 74.00 | 54.00 | -10.40 |
| N/A | | | | | | | | | >20 |
| 2480.00 | V | 86.84 | 62.71 | 17.24 | 104.08 | 79.95 | 114.00 | 94.00 | -14.05 |
| 4960.00 | V | 44.81 | 21.73 | 22.64 | 66.54 | 44.37 | 74.00 | 54.00 | -9.63 |
| N/A | | | | | | | | | >20 |

Notes:

1. Measuring frequencies from 1 GHz to the 10th harmonic of highest fundamental frequency.
2. Measurements above show only up to 6 maximum emissions noted, or would be lesser if no specific emissions from the EUT are recorded (ie: margin>20dB from the applicable limit) and considered that's already beyond the background noise floor.
3. Radiated emissions measured in frequency above 1000MHz were made with an instrument using Peak detector mode and average detector mode of the emission shown in Actual FS column.
4. Spectrum setting:
 - a. Peak Setting 1GHz - 26GHz, RBW = 1MHz, VBW = 1MHz, Sweep time = 200 ms.
 - b. AV Setting 1GH z- 26GHz, RBW = 1MHz, VBW = 10Hz, Sweep time = 200 ms.

5.2 Band Edge

5.2.1 Requirement

According to FCC section 15.249(a), in any 100kHz bandwidth outside the frequency band in which the spread spectrum or digitally modulated intentional radiator is operating, the radio frequency power that is produced by the intentional radiator shall be at least 20dB below that in the 100kHz bandwidth within the band that contains the highest level of the desired power, based on either an RF conducted or a radiated measurement.

5.2.2 Test Description

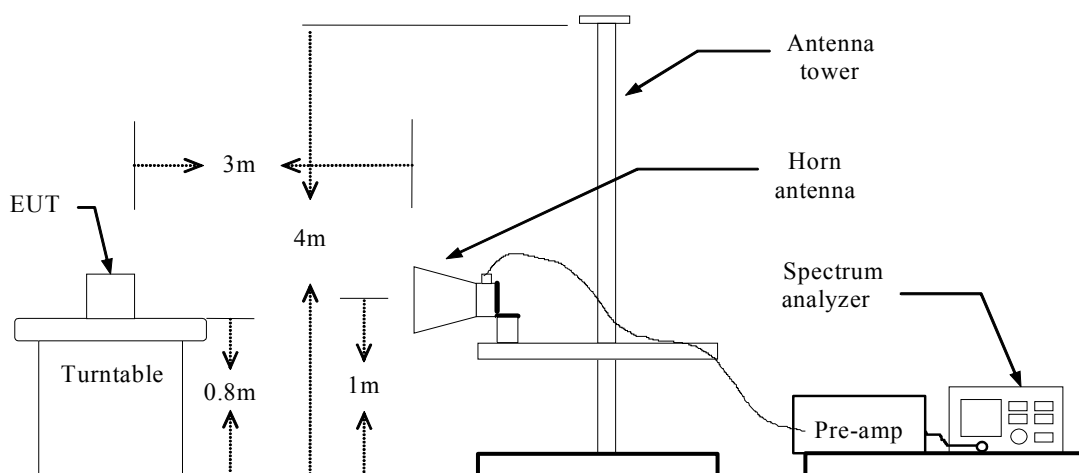

5.2.3 Test Result

The EUT operates at hopping-off test mode. The lowest and highest channels are tested to verify the band edge emissions.

GFSK Modulation Mode:

| Test Mode | | Channel Marked Frequency | Limit (dBuV/m) | Test Result Highest Emission (dBuV/m) | | | |
|-----------|--------------|--------------------------|-------------------------|---------------------------------------|---------|------------|---------|
| | | | | Vertical | | Horizontal | |
| | | | | Peak | Average | Peak | Average |
| Bluetooth | Low Channel | 2390MHz | 74(Peak) 54(Average) | 58.17 | 28.44 | 58.76 | 28.45 |
| | | 2400MHz | | 58.54 | 33.42 | 59.81 | 33.41 |
| | High Channel | 2483.5MHz | | 58.99 | 29.78 | 59.29 | 30.97 |
| | | 2500MHz | | 58.03 | 28.13 | 59.56 | 28.55 |

Test Plot:

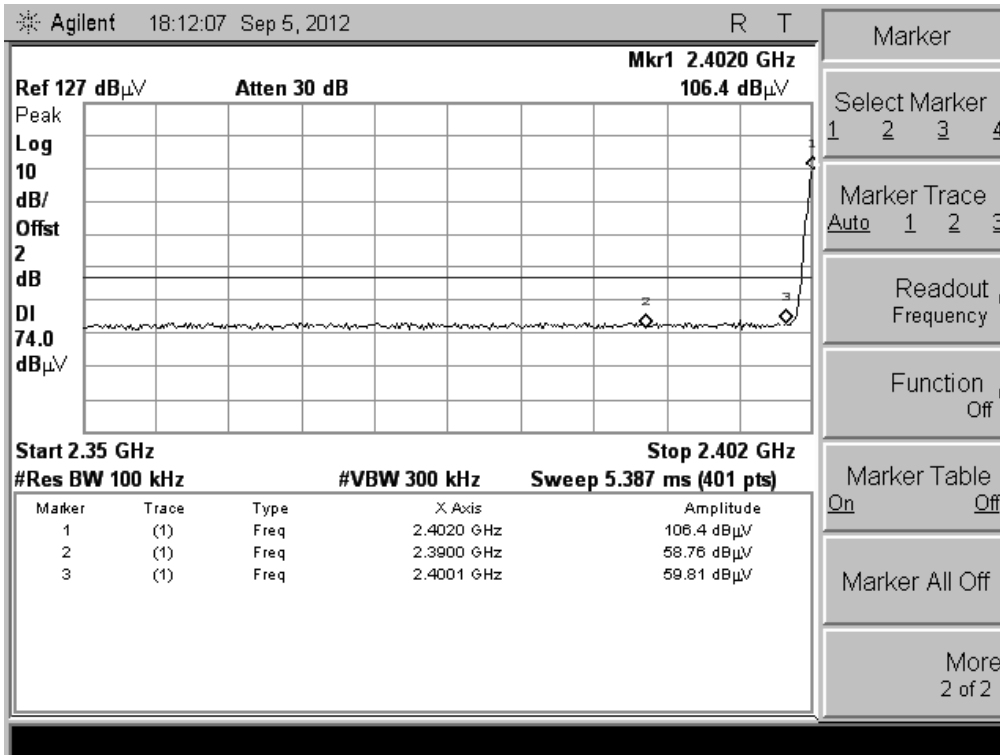

(CH Low, Horizontal, Peak)

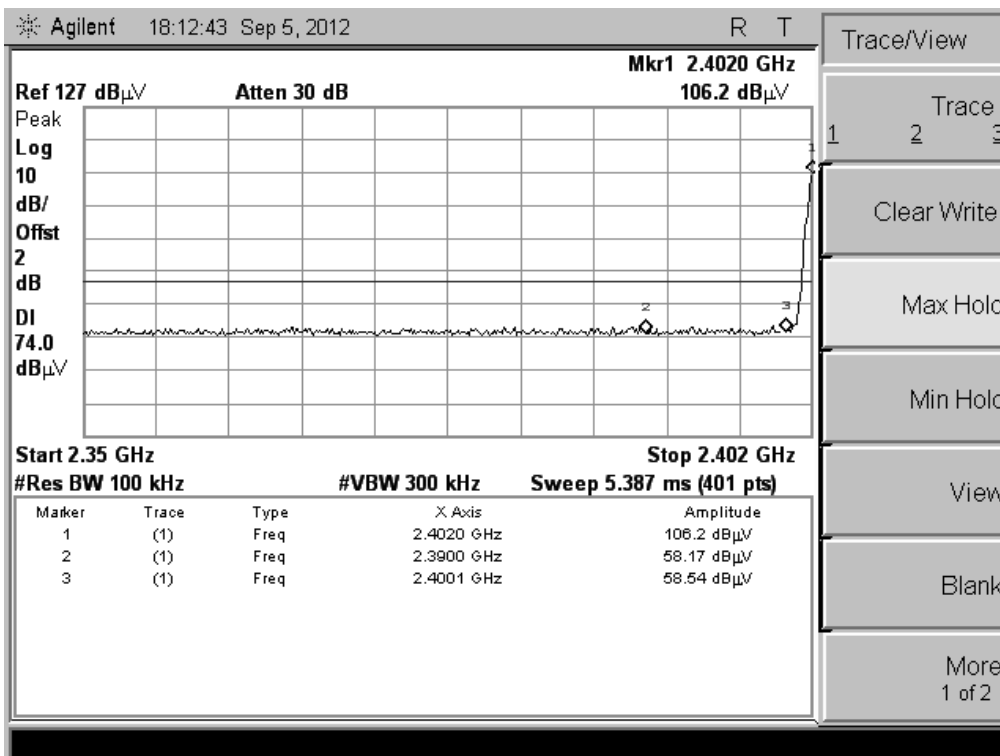

(CH Low, Vertical, Peak)

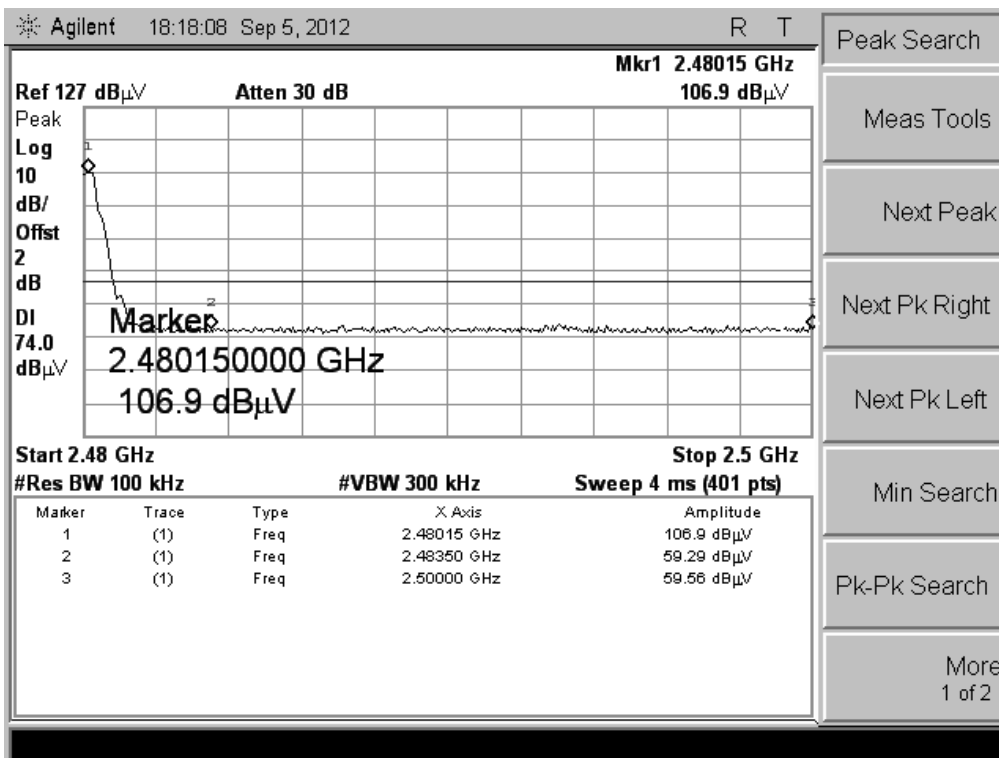

(CH High, Horizontal, Peak)

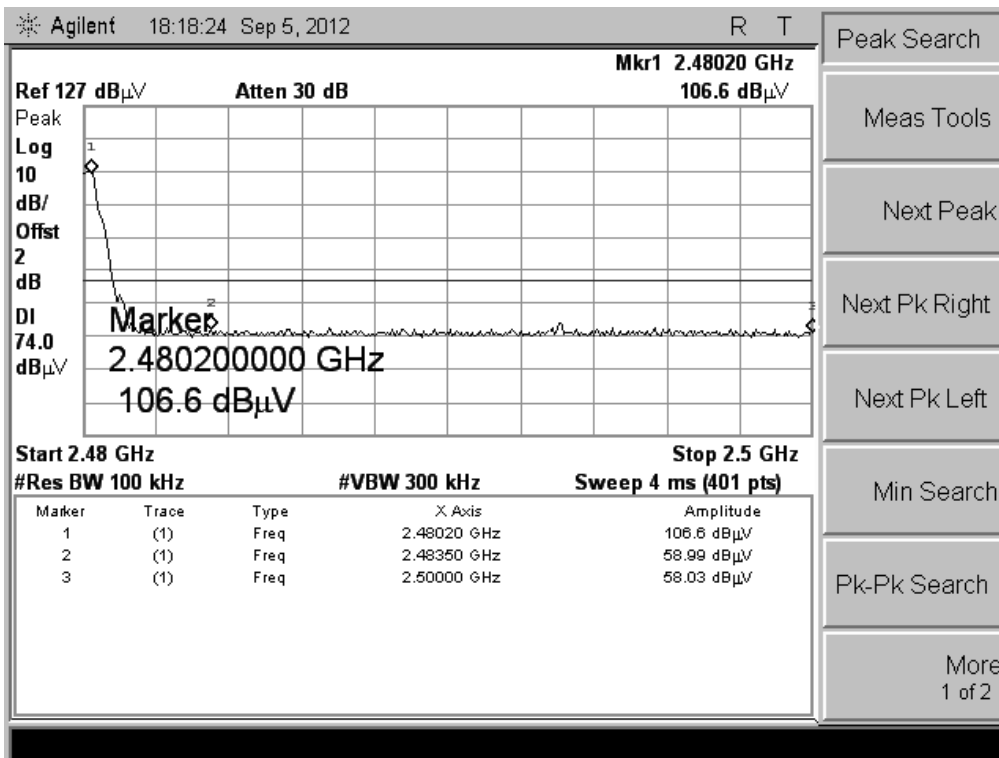

(CH High, Vertical, Peak)

5.3 LINE CONDUCTED EMISSION TEST

5.3.1. LIMITS OF LINE CONDUCTED EMISSION TEST

| Frequency | Maximum RF Line Voltage | |
|---------------|-------------------------|----------------|
| | Q.P.(dBuV) | Average(dBuV) |
| 150kHz-500kHz | 66-56 | 56-46 |
| 500kHz-5MHz | 56 | 46 |
| 5MHz-30MHz | 60 | 50 |

- **Note:** 1. the lower limit shall apply at the transition frequency.
 2. The limit decreases linearly with the logarithm of the frequency in the range 0.15 MHz to 0.50 MHz

5.3.2. BLOCK DIAGRAM OF TEST SETUP

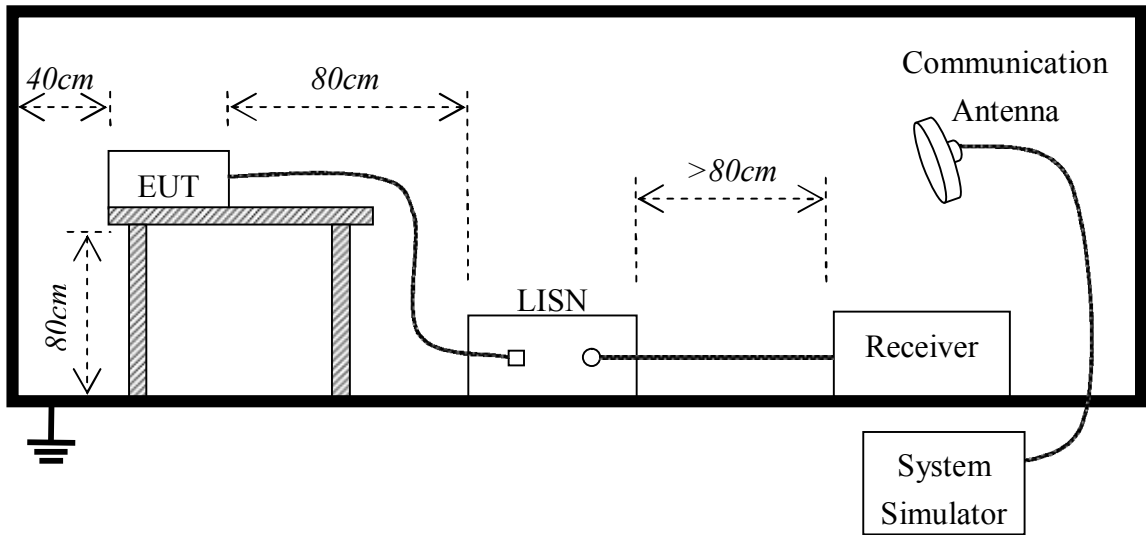

5.3.3. PRELIMINARY PROCEDURE OF LINE CONDUCTED EMISSION TEST

- 1) The equipment was set up as per the test configuration to simulate typical actual usage per the user's manual. When the EUT is a tabletop system, a wooden table with a height of 0.8 meters is used and is placed on the ground plane as per FCC Part 15 (see Test Facility for the dimensions of the ground plane used). When the EUT is floor-standing equipment, it is placed on the ground plane which has a 3-12 mm non-conductive covering to insulate the EUT from the ground plane.
- 2) Support equipment, if needed, was placed as per FCC Part 15.
- 3) All I/O cables were positioned to simulate typical actual usage as per FCC Part 15.
- 4) The EUT received DC 22V by Adapter which received AC120V/60Hz power through a Line Impedance Stabilization Network (LISN) which supplied power source and was grounded to the ground plane.
- 5) All support equipments received power from a second LISN supplying power of AC 120V/60Hz, if any.
- 6) The EUT test program was started. Emissions were measured on each current carrying line of the EUT using a spectrum Analyzer / Receiver connected to the LISN powering the EUT. The LISN has two monitoring points: Line 1 (Hot Side) and Line 2 (Neutral Side). Two scans were taken: one with Line 1 connected to Analyzer / Receiver and Line 2 connected to a 50 ohm load; the second scan had Line 1 connected to a 50 ohm load and Line 2 connected to the Analyzer / Receiver.
- 7) Analyzer / Receiver scanned from 150 kHz to 30 MHz for emissions in each of the test modes.
- 8) During the above scans, the emissions were maximized by cable manipulation.

5.3.4. FINAL PROCEDURE OF LINE CONDUCTED EMISSION TEST

EUT and support equipment was set up on the test bench as per step 9 of the preliminary test.

A scan was taken on both power lines, Line 1 and Line 2, recording at least the six highest emissions. Emission frequency and amplitude were recorded into a computer in which correction factors were used to calculate the emission level and compare reading to the applicable limit. If EUT emission level was less -2dB to the A.V. limit in Peak mode, then the emission signal was re-checked using Q.P and Average detector.

5.3.5. Test result

The following test mode(s) were scanned during the preliminary test:

| Preliminary Conducted Emission Test | | | | |
|-------------------------------------|------------|-------------------|----------|-------------------------------------|
| Frequency Range Investigated | | 150KHz TO 30 MHz | | |
| Mode of operation | Date | Report No. | Data# | Worst Mode |
| Bluetooth Mode | 2012-09-07 | MTE/CLY/D12091274 | 1_(V, H) | <input checked="" type="checkbox"/> |
| LINE INPUT Mode | 2012-09-07 | MTE/CLY/D12091274 | 1_(V, H) | <input type="checkbox"/> |

Then, the EUT configuration and cable configuration of the above highest emission level were recorded for reference of final testing.

Note:

The Bluetooth model was carried out for GFSK, π / 4-DPSK and 8-DPSK modulation types, GFSK Low channel modulation type was the worst case condition, The test data was shown on the summary data page.

5.3.5. TEST RESULT OF LINE CONDUCTED EMISSION TEST



Address: No. 5, Langshan 2nd Rd., North Hi-Tech Industrial park
 Guangdong, China
 Tel: 0755-86170306 Fax: 0755-86170310

Conducted Emission Measurement

File: iMM157

Data #26

Date: 2012-09-07

Time: 15:34:11

80.0 dBuV

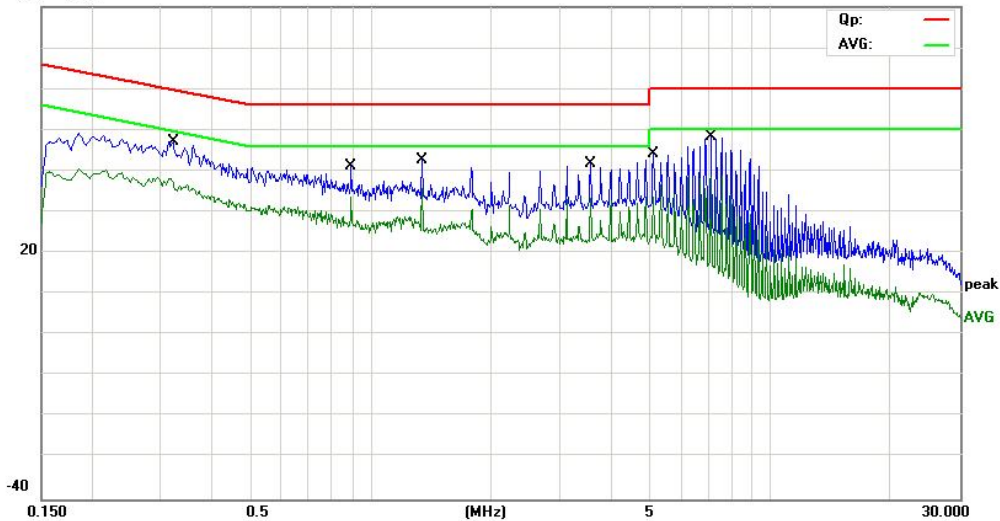

Site site #1

Phase: **L1**

Temperature: 26

Limit: FCC Part15 B Class B QP

Power: DC 5V by AC adapter 120V/60Hz

Humidity: 60 %

EUT: Bluetooth Wireless Speaker

M/N: iMM157

Mode: Bluetooth Playing

Note:

| No. | Mk. | Freq. MHz | Reading Level dBuV | Correct Factor dB | Measure- ment dBuV | Limit dBuV | Over dB | Detector | Comment |
|-----|-----|--------------|--------------------------|-------------------------|--------------------------|---------------|------------|----------|---------|
| 1 | | 0.3220 | 36.08 | 11.19 | 47.27 | 59.66 | -12.39 | QP | |
| 2 | | 0.8980 | 31.11 | 10.00 | 41.11 | 56.00 | -14.89 | QP | |
| 3 | | 1.3460 | 32.86 | 9.65 | 42.51 | 56.00 | -13.49 | QP | |
| 4 | | 3.5660 | 31.23 | 10.57 | 41.80 | 56.00 | -14.20 | QP | |
| 5 | | 5.1220 | 32.31 | 11.93 | 44.24 | 60.00 | -15.76 | QP | |
| 6 | * | 7.1300 | 37.59 | 10.72 | 48.31 | 60.00 | -11.69 | QP | |

*:Maximum data x:Over limit l:over margin

Engineer Signature: Sky



Address: No. 5, Langshan 2nd Rd., North Hi-Tech Industrial park
 Guangdong, China
 Tel: 0755-86170306 Fax: 0755-86170310

Conducted Emission Measurement

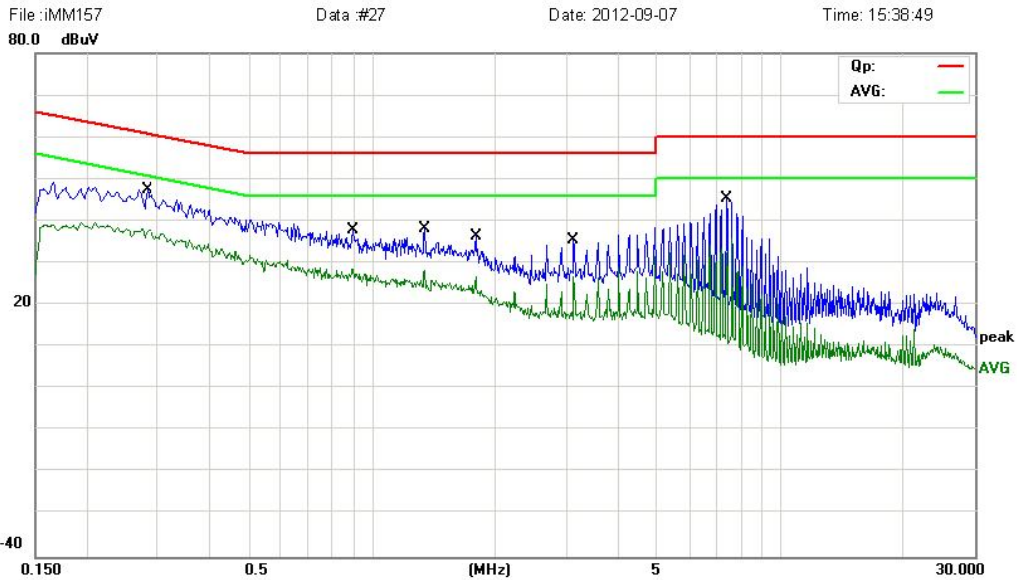

Site site #1 Phase: **N** Temperature: 26
 Limit: FCC Part15 B Class B QP Power: DC 5V by AC adapter 120V/60Hz Humidity: 60 %
 EUT: Bluetooth Wireless Speaker
 M/N: IMM157
 Mode: Bluetooth Playing
 Note:

| No. | Mk. | Freq. MHz | Reading Level dBuV | Correct Factor dB | Measure- ment dBuV | Limit dBuV | Over dB | Detector | Comment |
|-----|-----|--------------|--------------------------|-------------------------|--------------------------|---------------|------------|----------|---------|
| 1 | * | 0.2820 | 36.07 | 11.45 | 47.52 | 60.76 | -13.24 | QP | |
| 2 | | 0.9020 | 27.85 | 10.00 | 37.85 | 56.00 | -18.15 | QP | |
| 3 | | 1.3500 | 28.35 | 9.65 | 38.00 | 56.00 | -18.00 | QP | |
| 4 | | 1.7940 | 27.20 | 9.21 | 36.41 | 56.00 | -19.59 | QP | |
| 5 | | 3.1380 | 25.23 | 10.14 | 35.37 | 56.00 | -20.63 | QP | |
| 6 | | 7.4020 | 34.69 | 10.56 | 45.25 | 60.00 | -14.75 | QP | |

*:Maximum data x:Over limit l:over margin

Engineer Signature: Sky

5.4 20 dB Bandwidth

5.4.1 Definition

Intentional radiators operating under the alternative provisions to the general emission limits, as Contained in §§15.217 through 15.257 and in sub-part E of this part, must be designed to ensure that the 20 dB Bandwidth of the emission, or whatever bandwidth may otherwise be specified in the specific Rule section under which the equipment operates, is contained within the frequency band designated in the rule section under which the equipment is operated.

5.4.2 Block Diagram Of Test Setup

The EUT is powered by the Battery, is coupled to the Spectrum Analyzer (SA) through the Attenuator/DC Block. The path loss as the factor is calibrated to correct the reading. During the measurement, the EUT is activated and is set to operate at maximum power. The RF load attached to the EUT antenna terminal is 50Ohm.

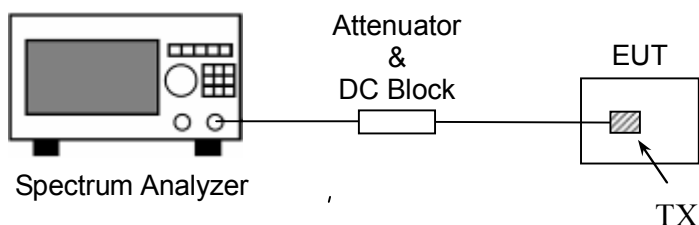

5.4.3 Test Result

GFSK Modulation test result:

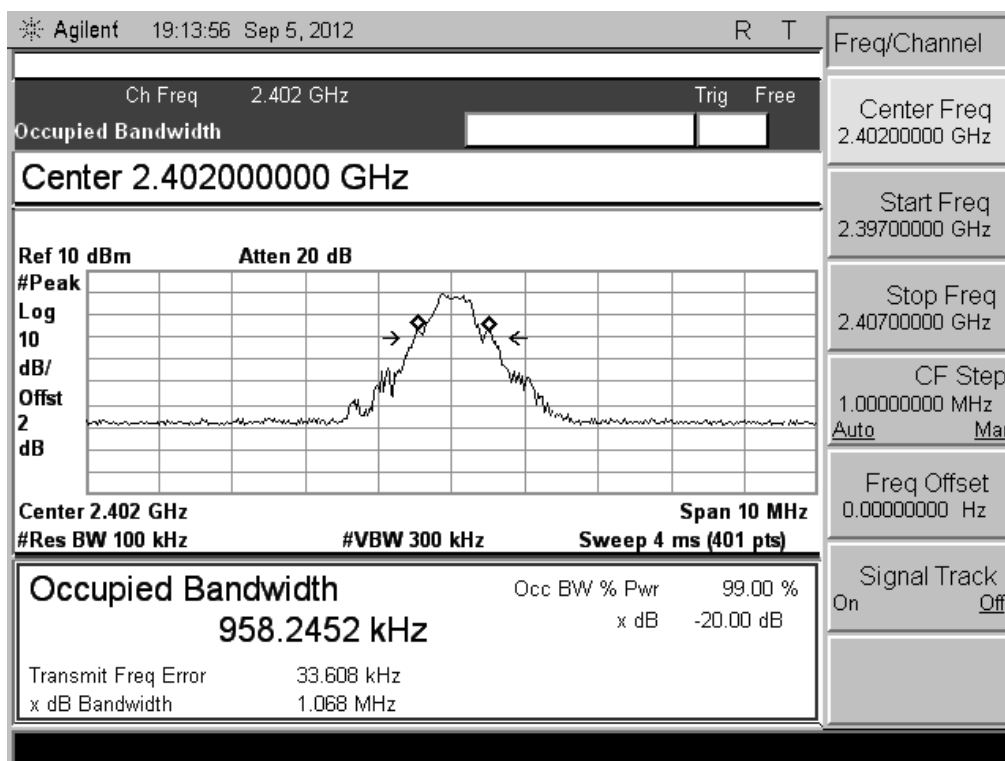

CH Low

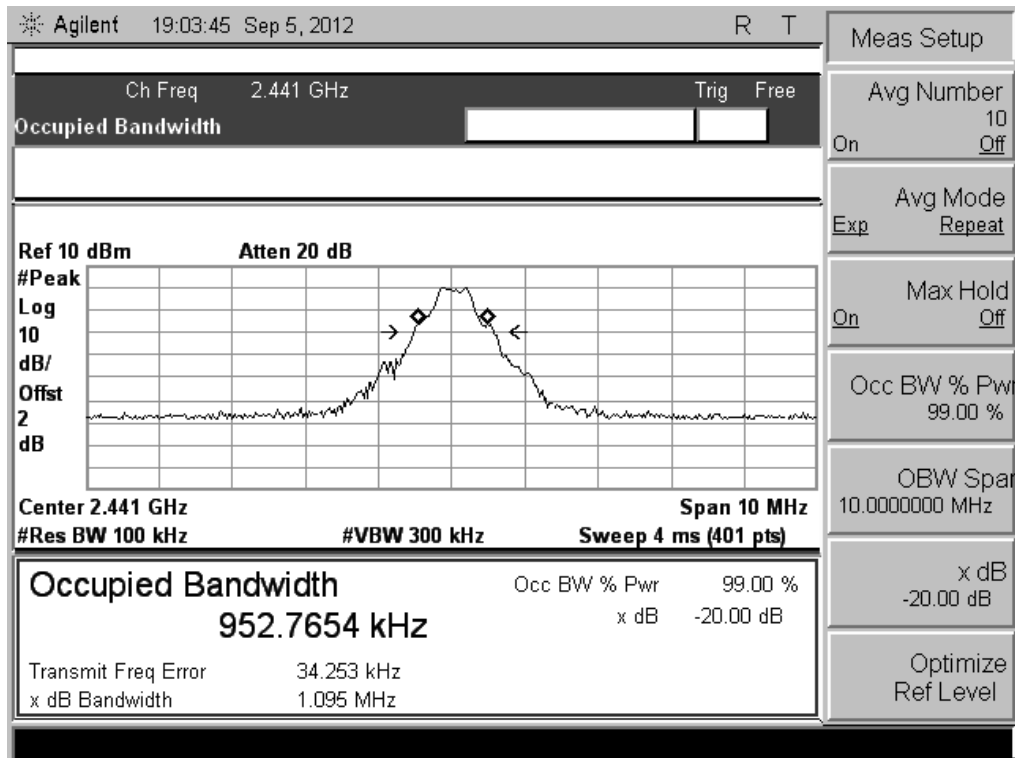

CH MID

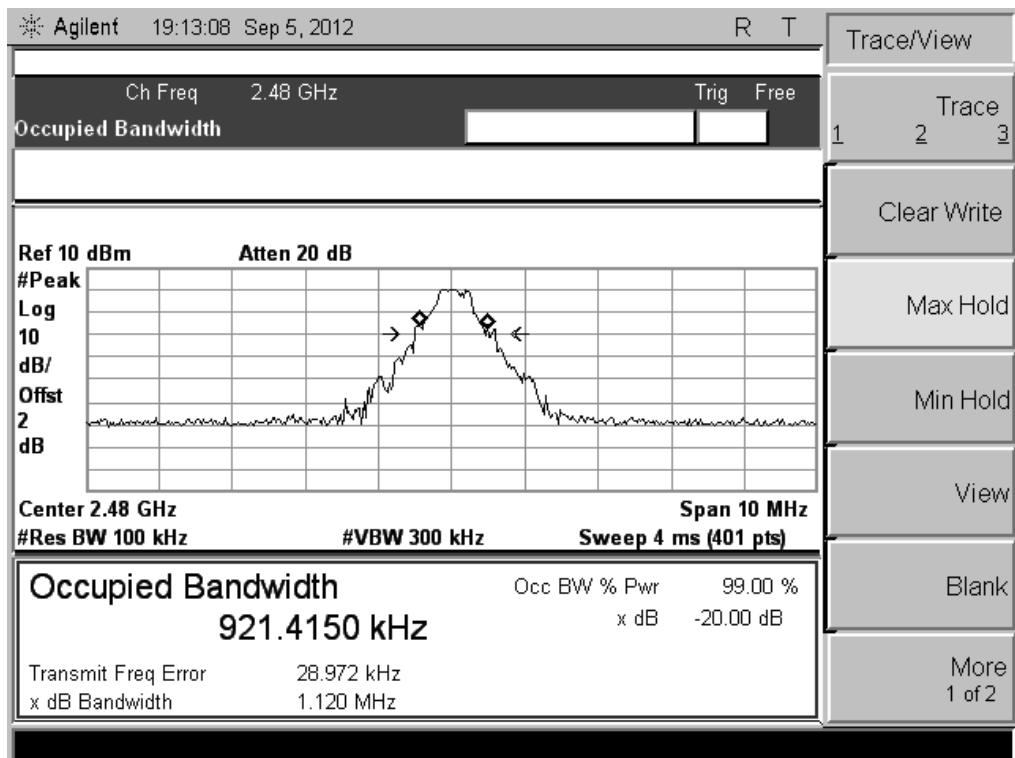

CH High

APPENDIX 1
PHOTOGRAPHS OF TEST SETUP

CONDUCTED TEST SETUP



CE TEST SETUP



RE TEST SETUP

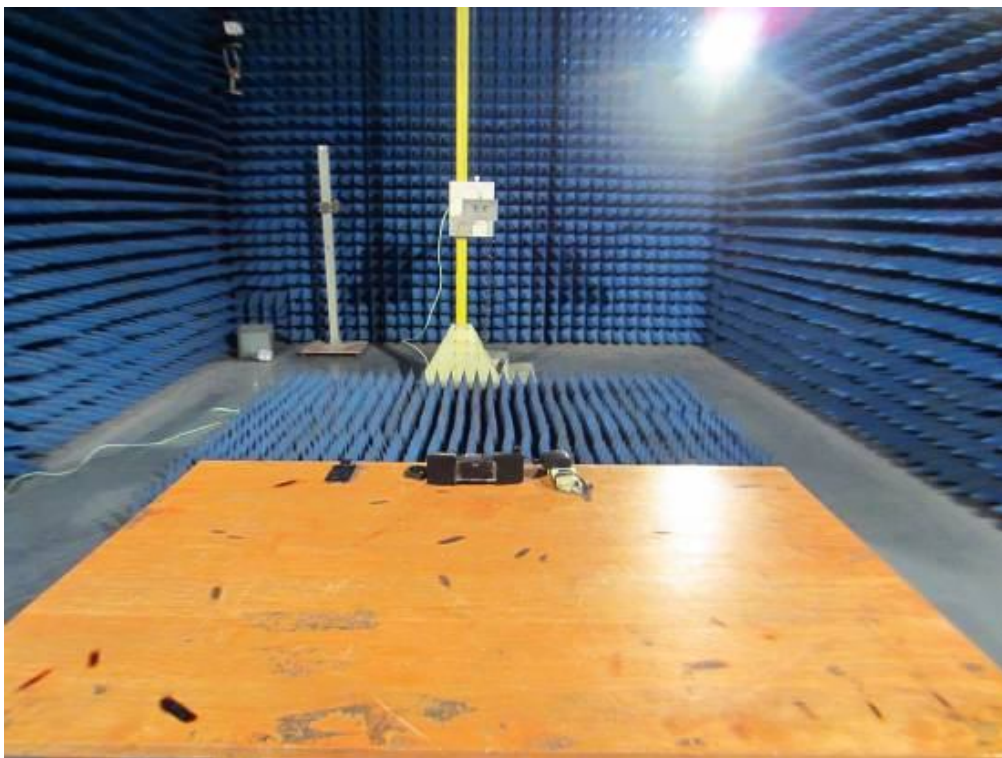
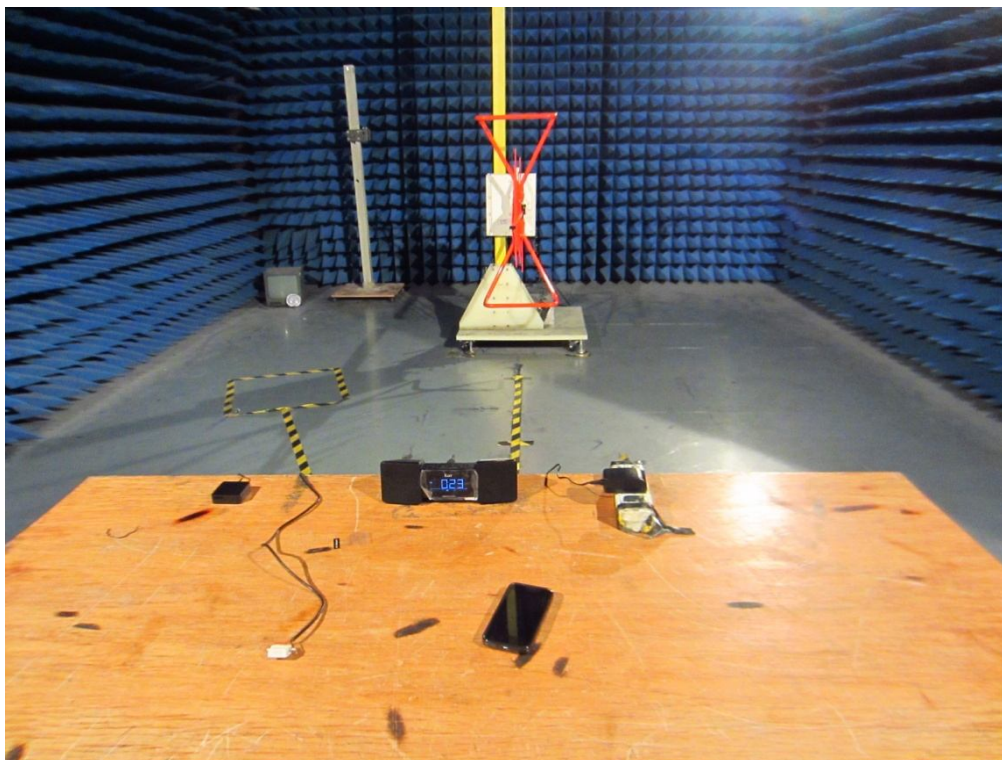

-----END OF REPORT-----