

# Bluetooth Water Splash Proof In-ear Sports Earphone

## Quick Start Guide

Item # FITACTJET3BK

1. Make sure the following items are included in your package.

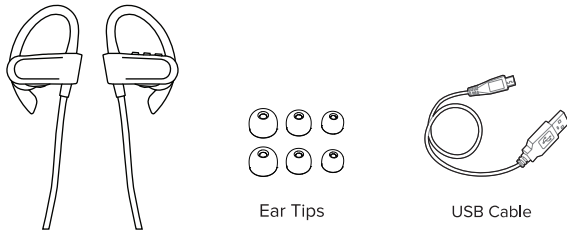

2. For a look at the various buttons and parts on your earphones, view the graphic below.

1. Earloop
2. Ear Tip
3. Volume Down/Previous Track
4. Power/Play/Answer
5. Volume Up/Next Track
6. LED Indicator Light
7. Microphone
8. Charging Port

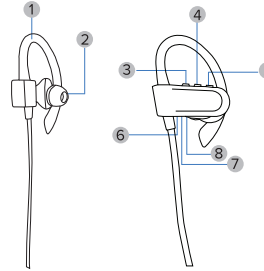

3. **Charging:** When charging, the LED Indicator Light will turn red. When charging is complete, the LED Indicator Light will turn off. Your earphones can take up to two hours to charge.

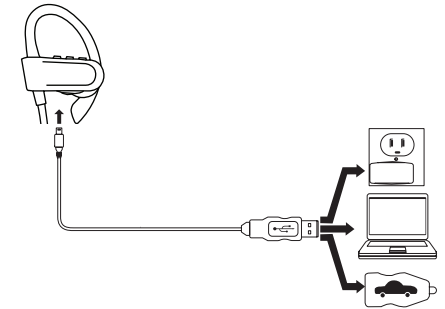

### 4. Powering ON/Powering OFF Your Earphones:

-Press and hold the Power button for approximately 3-5 seconds to power on your earphones. Your earphones will automatically connect with the last phone they were paired with if they have previously been paired.

-Once powered on, you can press and hold the Power button again for approximately three seconds to power off your earphones.

NOTE: In order to save power, your earphones will automatically power off if left unpaired and idle for several minutes.

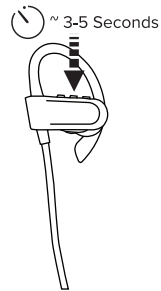

### 5. Pairing Your Earphones With a Bluetooth Phone

-Immediately after powering on your earphones, the LED Indicator Light will alternately flash red and blue to indicate that your earphones are ready to be paired.

-Go to the Bluetooth Manager on your phone. Search Bluetooth devices and select "iLuv FitActive jet3" to start connecting. Once paired, the LED Indicator Light will slowly flash blue every few seconds.

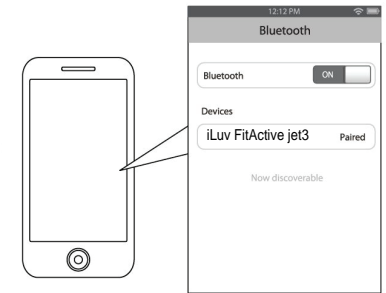
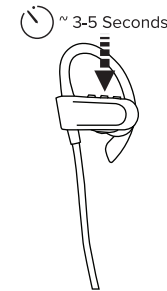

### 6. Wearing Your Earphones

For the best sound performance and a secure, comfortable fit, be sure that the ear buds rest gently in your ear and drape around the back of your neck. Use the ear tips that works best for you.

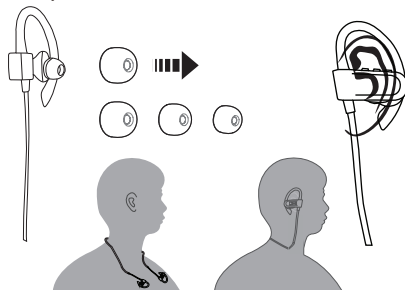

### 7. Listening to Music

#### Play/Pause

Press the Power button to get music from your audio source to play or pause.

#### Next/Previous Song

Press and hold the Volume Up or Volume Down buttons to advance to the next song or go back to the previous one.

#### Increase/Decrease Volume

Repeatedly tap the Volume Up or Volume Down buttons to increase or decrease the volume.

NOTE: Music will automatically pause when a call is dialed out or when there is an incoming call. It will resume when the call ends.



### 8. Using Your Earphones During Phone Calls

#### Answering an Incoming Call

To answer an incoming call, quickly press the Answer button.

#### Ending a Call

To end a call, quickly press the Answer button, and the call will be disconnected.

#### Adjusting Volume

By pressing the Volume Up or Volume Down buttons you can increase or decrease the volume of the phone call.

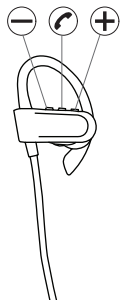

## **FCC Statement**

This device complies with part 15 of the FCC rules. Operation is subject to the following two conditions: (1) this device may not cause harmful interference, and (2) this device must accept any interference received, including interference that may cause undesired operation.

Changes or modifications not expressly approved by the party responsible for compliance could void the user's authority to operate the equipment.

NOTE: This equipment has been tested and found to comply with the limits for a Class B digital device, pursuant to part 15 of the FCC Rules. These limits are designed to provide reasonable protection against harmful interference in a residential installation. This equipment generates uses and can radiate radio frequency energy and, if not installed and used in accordance with the instructions, may cause harmful interference to radio communications. However, there is no guarantee that interference will not occur in a particular installation. If this equipment does cause harmful interference to radio or television reception, which can be determined by turning the equipment off and on, the user is encouraged to try to correct the interference by one or more of the following measures:

- Reorient or relocate the receiving antenna.
- Reorient or relocate the receiving antenna.
- Reorient or relocate the receiving antenna.
- Consult the dealer or an experienced radio/TV technician for help important announcement

Important Note:

## **Radiation Exposure Statement**

This equipment complies with FCC radiation exposure limits set forth for an uncontrolled environment. This equipment should be installed and operated with minimum distance 0cm between the radiator and your body. This transmitter must not be co-located or operating in conjunction with any other antenna or transmitter.