

Radio Test Report

FCC ID: ATL-FITACTAIR

Report No. : IP-RF15040228
Applicant : iLuv Creative Technology
Equipment Under Test (EUT)
EUT Name : Fit Active Air
Model No. : FITACTAIR
Serial No. : N/A
Receipt Date : 2015-03-26
Test Date : 2015-03-27 to 2015-04-13
Issue Date : 2015-04-15
Standards : FCC Part 15C, 15.247
Conclusions : **PASS**

In the configuration tested, the EUT complied with the standards specified above

Test/Witness Engineer

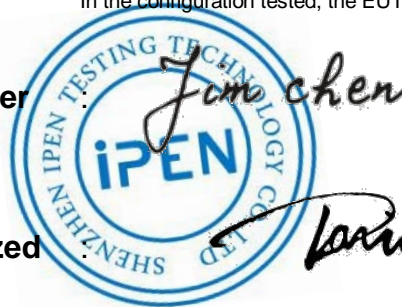

Approved & Authorized



This report details the results of the testing carried out on one sample. The results contained in this test report do not relate to other samples of the same product. The manufacturer should ensure that all products in series production are in conformity with the product sample detailed in the report.

TABLE OF CONTENTS

1	GENERAL INFORMATION	4
1.1	Client Information	4
1.2	General Description of EUT (Equipment Under Test).....	4
1.3	Block Diagram Showing the Configuration of System Tested.....	5
1.4	Description of Support Units	5
1.5	Description of Operating Mode.....	6
1.6	Description of Test Software Setting.....	6
1.7	Test Facility.....	7
2	TEST RESULTS SUMMARY	8
3	TEST EQUIPMENT	9
4	CONDUCTED EMISSION.....	10
4.1	Test Standard and Limit	10
4.2	Test Setup.....	10
4.3	Test Procedure.....	10
4.4	Test Data.....	11
5	RADIATE EMISSION TEST	14
5.1	Test Standard and Limit	14
5.2	Test Setup.....	14
5.3	Test Procedure.....	16
5.4	Test Data.....	16
6	BAND EDGE	24
6.1	Test Standard and Limit	24
6.2	Test Setup.....	24
6.3	Test Procedure.....	24
6.4	Test Data.....	25
7	PEAK POWER TEST	30
7.1	Test Standard and Limit	30
7.2	Test Setup.....	30
7.3	Test Procedure.....	30
7.4	Test Data.....	30
8	BANDWIDTH	33
8.1	Test Standard and Limit	33
8.2	Test Setup.....	33
8.3	Test Procedure.....	33
8.4	Test Data.....	33
9	POWER DENSITY	36
9.1	Test Standard and Limit	36
9.2	Test Setup.....	36
9.3	Test Procedure.....	36
9.4	Test Data.....	36
10	ANTENNA CONDUCTED EMISSIONS	39
10.1	Test Standard and Limit	39
10.2	Test Setup.....	39
10.3	Test Procedure.....	39
10.4	Test Data.....	40

11 ANTENNA REQUIREMENT44
11.1 Standard and Limit.....44
11.2 Antenna Construction44

12 APPENDIX- RF EXPOSURE INFORMATION.....45

13 PHOTOGRAPHS - CONSTRUCTIONAL DETAILS.....47

14 FCC ID LABEL51

15 LABEL LOCATION52

16 PHOTOGRAPHS – TEST SETUP.....53

1 General Information

1.1 Client Information

Applicant : iLuv Creative Technology
Address : 2 Harbor Park Drive, Port Washington, NY 11050
Manufacturer : Shenzhen Lanxinqiao Technology Co.,Ltd.
Address : 3rd Floor, No. 1 Building, Launch Science Park, Wuhe Road, Bantian Street, Longgang Area, Shenzhen,Guangdong, China

1.2 General Description of EUT (Equipment Under Test)

EUT Name	:	Fit Active Air	
Model No.	:	FITACTAIR	
Serial No.	:	N/A	
Product Description	:	Operation Frequency:	Bluetooth: 2402MHz~2480MHz
	:	Number of Channel:	40 Channels see note (2)
	:	Out Power	2.45 dBm (Max.)
	:	Antenna Designation:	0 dBi see note (3)
	:	Modulation Type:	GFSK Mode
Power Supply	:	DC Voltage supplied from Li-ion System	
Power Rating	:	DC 5.0V from Host system DC 3.7V 1000mAh Li-ion battery	
Connecting I/O Port(S)	:	Please refer to the User's Manual	

Note:

- (1) For a more detailed features description, please refer to the manufacturer's specifications or the User's Manual.
- (2) Channel List:

Bluetooth(BLE) Channel List					
Channel	Frequency (MHz)	Channel	Frequency (MHz)	Channel	Frequency (MHz)
00	2402	14	2430	28	2458
01	2404	15	2432	29	2460
02	2406	16	2434	30	2462
03	2408	17	2436	31	2464
04	2410	18	2438	32	2466
05	2412	19	2440	33	2468

06	2414	20	2442	34	2470
07	2416	21	2444	35	2472
08	2418	22	2446	36	2474
09	2420	23	2448	37	2476
10	2422	24	2450	38	2478
11	2424	25	2452	39	2480
12	2426	26	2454		
13	2428	27	2456		

(3) Antenna description

Ant.	Brand	Model Name	Antenna Type	Gain(dBi)
1	N/A	N/A	Integral Ant	0

1.3 Block Diagram Showing the Configuration of System Tested

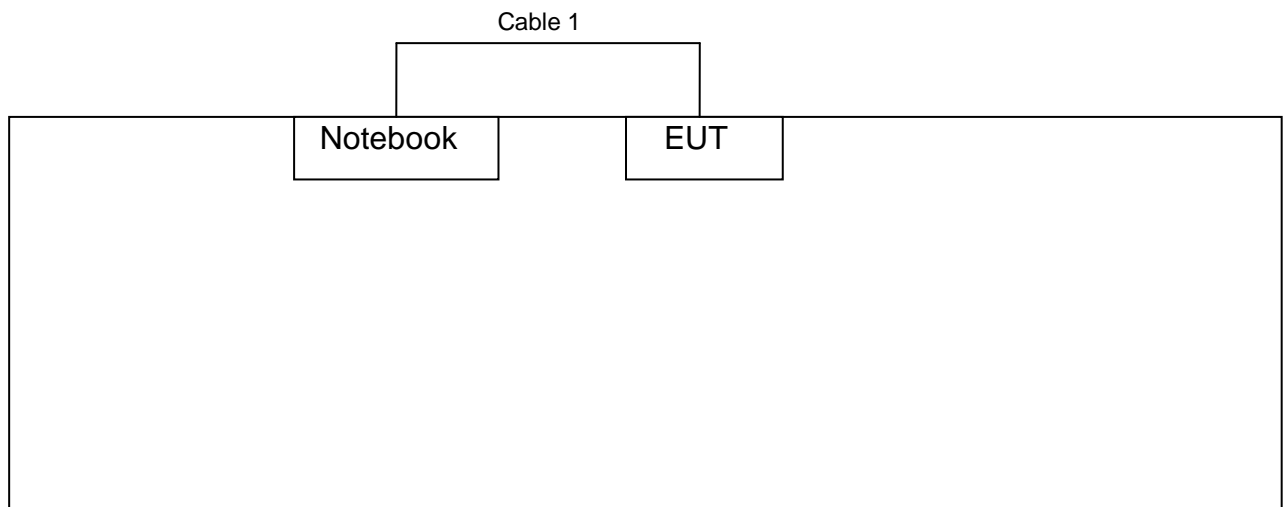

1.4 Description of Support Units

Equipment Information				
Name	Model	S/N	Manufacturer	FCC DOC/ID
Notebook	B470A2450	VNF3G06957	Lenovo	DOC
Cable Information				
Number	Shielded Type	Ferrite Core	Length	Note

Cable 1	NO	NO	1.0M	USB Calbe

1.5 Description of Operating Mode

To investigate the maximum EMI emission characteristics generated from EUT, the test system was pre-scanning tested based on the consideration of following EUT operation mode or test configuration mode which possible have effect on EMI emission level. Each of these EUT operation mode(s) or test configuration mode(s) mentioned above was evaluated respectively.

For Conducted Test	
Final Test Mode	Description
Mode 1	USB Charging Mode

For Radiated Test	
Final Test Mode	Description
Mode 2	BLE TX Mode

Note:

- (1) For all test, we have verified the construction and function in typical operation. And all the test modes were carried out with the EUT in transmitting operation in maximum power with all kinds of data rate.
According to ANSI C63.4 standards, the measurements are performed at the highest, middle, lowest available channels, and the worst case data rate as follows:
Bluetooth BLE Mode: GFSK Modulation Transmitting mode.
- (2) During the testing procedure, the continuously transmitting with the maximum power mode was programmed by the customer.
- (3) The EUT is considered a mobile unit; in normal use it was positioned on X-plane. The worst case was found positioned on X-plane. Therefore only the test data of this X-plane was used for radiated emission measurement test.

1.6 Description of Test Software Setting

During testing channel & Power controlling software provided by the customer was used to control operating channel as well as the output power level. The RF output power selection is for setting of RF output power expected by the customer and is going to be fixed on the firmware of the final end product power parameters of Bluetooth mode.

Test Software Version	Test Program: BLE RF Test.exe
-----------------------	-------------------------------

Channel	CH 01	CH 20	CH 39
BLE Mode	DEF	DEF	DEF

1.7 Test Facility

The reports were prepared by the Shenzhen iPEN Testing Technology Co., Ltd., in their facilities located at 8/F Haoyunlai Building B, 2 Baomin Road Xixiang Street, Bao'an District, Shenzhen, China.

The testing was performed by the Shenzhen Toby Technology Co., Ltd., and the FCC List No. is 811562.

2 TEST RESULTS SUMMARY

FCC Part 15 Subpart C(15.247)/RSS-210: 2010				
Standard Section		Test Item	Judgment	Remark
FCC	IC			
15.203	/	Antenna Requirement	PASS	N/A
15.207	RSS-GEN 7.2.4	Conducted Emission	PASS	N/A
15.205	RSS-GEN 7.2.2	Restricted Bands	PASS	N/A
15.247(a)(2)	RSS-210 A.8.2(a)	6dB Bandwidth	PASS	N/A
15.247(b)	RSS-210 A.8.4(4)	Peak Output Power	PASS	N/A
15.247(e)	RSS-210 A.8.2(b)	Power Spectral Density	PASS	N/A
15.247(d)	RSS-210 Annex 8 (A8.5)	Transmitter Radiated Spurious Emission	PASS	N/A
<p>Note: "/" for no requirement for this test item. N/A is an abbreviation for Not Applicable.</p>				

3 TEST EQUIPMENT

No.	Equipment	Manufacturer	Model No.	Last Cal.	Cal. Interval
IP-EMC001	EMI Test Receiver	Rohde & Schwarz	ESCS30	Jan.06,2015	1 Year
IP -EMC002	AMN	Rohde & Schwarz	ESH3-Z5	Jan.06,2015	1 Year
IP -EMC003	ANN	SCHWARZBECK	NNBL 8226-2	Jan.06,2015	1 Year
IP -EMC004	EMI Test Receiver	Rohde & Schwarz	ESI26	Jan.06,2015	1 Year
IP -EMC005	Bilog Antenna	Chase	CBL6112B	Jan.06,2015	1 Year
IP -EMC006	Positioning Controller	C&C	CC-C-1F	Jan.06,2015	1 Year
IP -EMC007	Spectrum Analyzer	Agilent	E4407B	Jan.06,2015	1 Year
IP -EMC008	Pre-amplifier	Agilent	8449B	Jan.06,2015	1 Year
IP -EMC009	Pre-amplifier	Agilent	8447D	Jan.06,2015	1 Year
IP -EMC010	Horn Antenna	ETS LINDGREN	3117	Jan.06,2015	1 Year

4 Conducted Emission

4.1 Test Standard and Limit

4.1.1 Test Standard

FCC 15.207

4.1.2 Test Limit

Conducted Emission Test Limit

Frequency	Maximum RF Line Voltage (dB μ V)	
	Quasi-peak Level	Average Level
150kHz~500kHz	66 ~ 56 *	56 ~ 46 *
500kHz~5MHz	56	46
5MHz~30MHz	60	50

Notes:

- (1) *Decreasing linearly with logarithm of the frequency.
- (2) The lower limit shall apply at the transition frequencies.
- (3) The limit decrease in line with the logarithm of the frequency in the range of 0.15 to 0.50MHz.

4.2 Test Setup

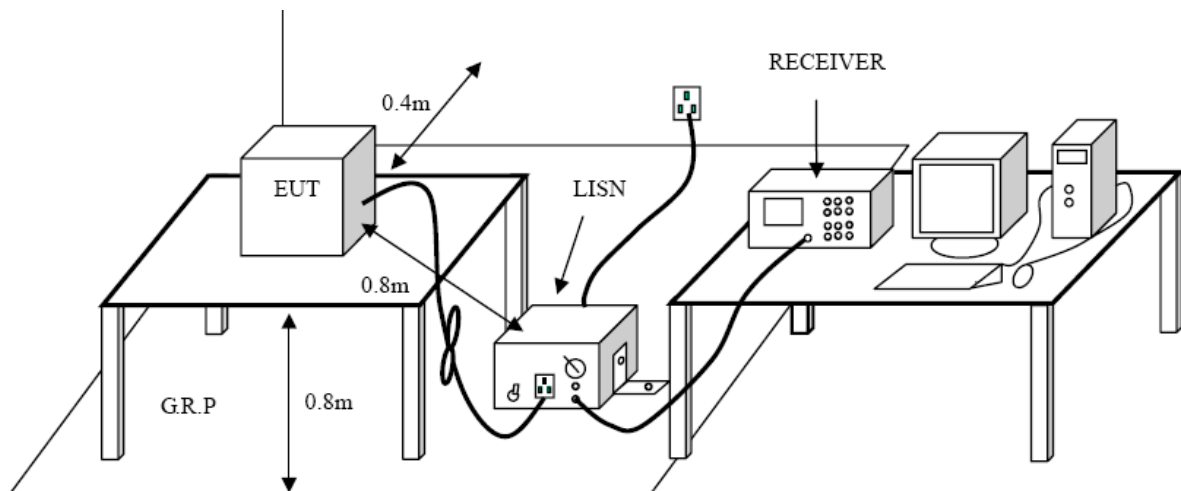

4.3 Test Procedure

The EUT was placed 0.8 meters from the horizontal ground plane with EUT being connected to the power mains through a line impedance stabilization network (LISN). All other support equipments powered from additional LISN(s). The LISN provide 50 Ohm/ 50uH of coupling impedance for the measuring instrument.

Interconnecting cables that hang closer than 40 cm to the ground plane shall be folded back and forth in the center forming a bundle 30 to 40 cm long.

I/O cables that are not connected to a peripheral shall be bundled in the center. The end of the cable may be terminated, if required, using the correct terminating impedance. The overall length shall not exceed 1 m.

LISN at least 80 cm from the nearest part of EUT chassis.

The bandwidth of EMI test receiver is set at 9kHz, and the test frequency band is from 0.15MHz to 30MHz.

4.4 Test Data

EUT:	Fit Active Air	Model Name:	FITACTAIR
Temperature :	23°C	Relative Humidity :	48 %
Terminal	Line		
Test Voltage :	AC120V/60Hz		
Test Mode :	Mode 1		

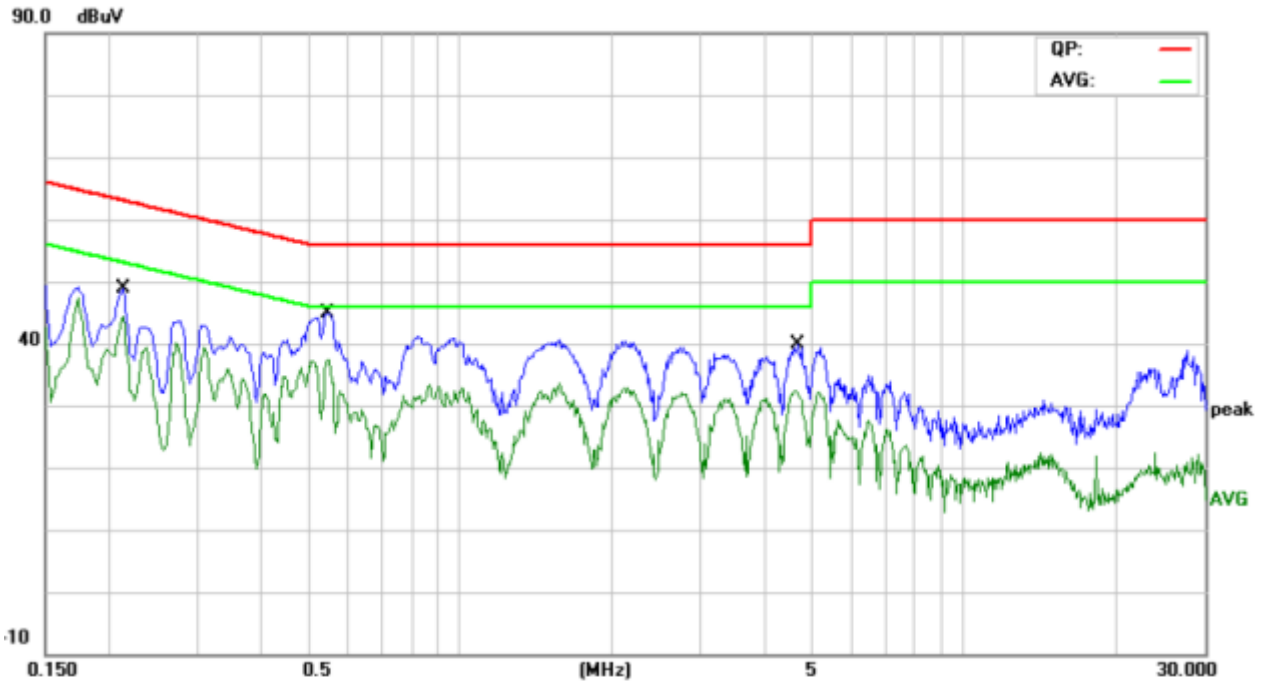

No.	Mk.	Freq. MHz	Reading Level dBuV	Correct Factor dB	Measure- ment dBuV	Limit dBuV	Over dB	Detector	Comment
1		0.2140	37.27	10.02	47.29	63.04	-15.75	QP	
2		0.2140	33.99	10.02	44.01	53.04	-9.03	AVG	
3		0.5460	34.45	10.04	44.49	56.00	-11.51	QP	
4	*	0.5460	27.27	10.04	37.31	46.00	-8.69	AVG	
5		4.6860	26.34	9.97	36.31	56.00	-19.69	QP	
6		4.6860	22.12	9.97	32.09	46.00	-13.91	AVG	

EUT:	Fit Active Air	Model Name:	FITACTAIR
Temperature :	23°C	Relative Humidity :	48 %
Terminal	Neutral		
Test Voltage :	AC120V/60Hz		
Test Mode :	Mode 1		

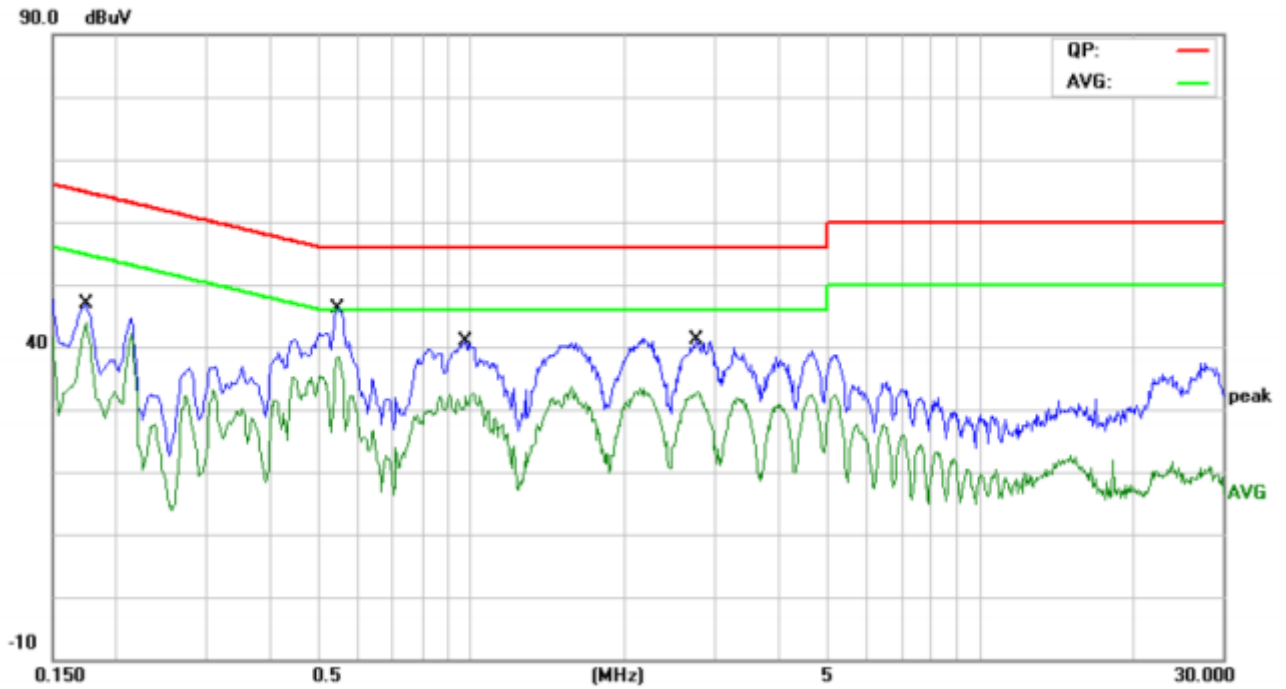

No.	Mk.	Freq. MHz	Reading Level dBuV	Correct Factor dB	Measure- ment dBuV	Limit dBuV	Over dB	Detector	Comment
1		0.1740	34.47	10.12	44.59	64.76	-20.17	QP	
2		0.1740	33.73	10.12	43.85	54.76	-10.91	AVG	
3		0.5460	35.54	10.02	45.56	56.00	-10.44	QP	
4	*	0.5460	28.31	10.02	38.33	46.00	-7.67	AVG	
5		0.9780	28.67	10.15	38.82	56.00	-17.18	QP	
6		0.9780	21.85	10.15	32.00	46.00	-14.00	AVG	
7		2.7700	26.95	10.06	37.01	56.00	-18.99	QP	
8		2.7700	22.20	10.06	32.26	46.00	-13.74	AVG	

5 Radiate Emission Test

5.1 Test Standard and Limit

5.1.1 Test Standard

FCC 15.209

5.1.2 Test Limit

Radiated Emission Limits (9kHz~1000MHz)

Frequency (MHz)	Field Strength (microvolt/meter)	Measurement Distance (meters)
0.009~0.490	2400/F(KHz)	300
0.490~1.705	24000/F(KHz)	30
1.705~30.0	30	30
30~88	100	3
88~216	150	3
216~960	200	3
Above 960	500	3

Radiated Emission Limit (Above 1000MHz)

	Peak	Average
Above 1000	74	54

Note:

- (1) The tighter limit applies at the band edges.
- (2) Emission Level(dBuV/m)=20log Emission Level(uV/m)

5.2 Test Setup

Test Below 30MHz:

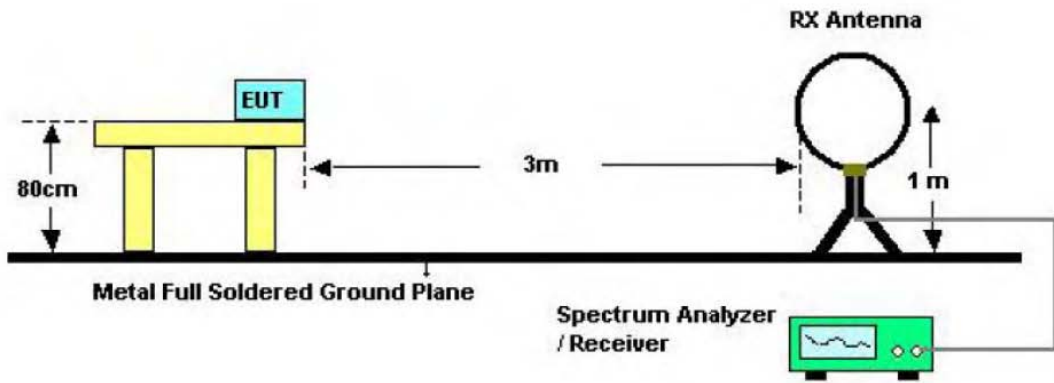

Test above 30MHz and below 1 GHz

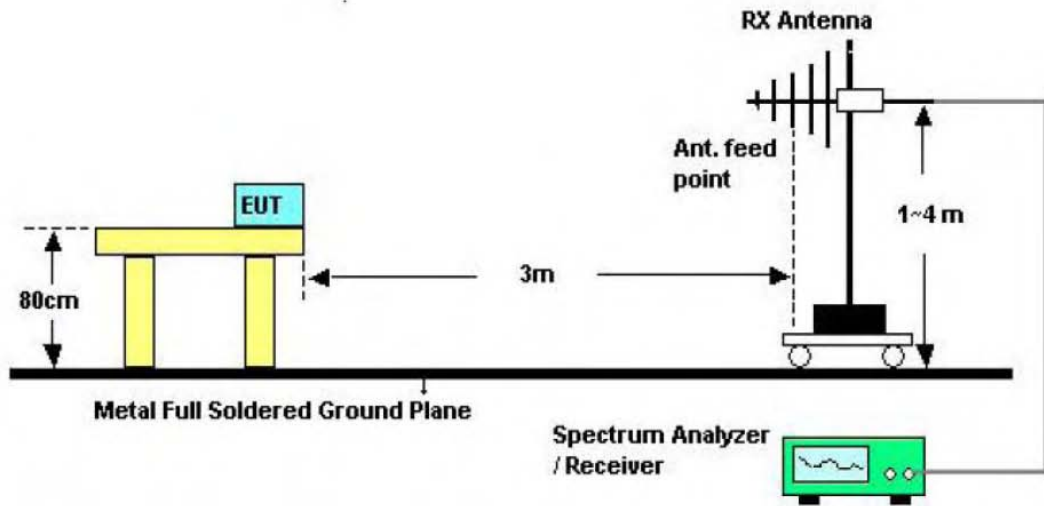

Test above 1 GHz

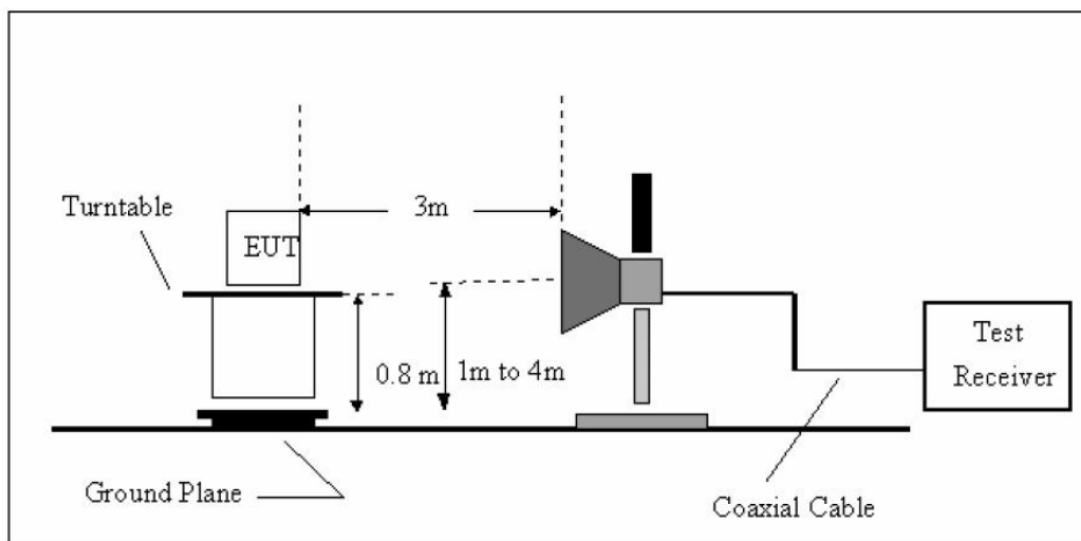

5.3 Test Procedure

- (1) The measuring distance of 3m shall be used for measurements at frequency up to 1GHz and above 1 GHz. The EUT was placed on a rotating 0.8m high above the ground, the table was rotated 360 degrees to determine the position of the highest radiation.
- (2) The Test antenna shall vary between 1m and 4m, Both Horizontal and Vertical antenna are set to make measurement.
- (3) The initial step in collecting conducted emission data is a spectrum analyzer peak detector mode pre-scanning the measurement frequency range. Significant peaks are then marked and then Quasi Peak detector mode re-measured.
- (4) If the Peak Mode measured value compliance with and lower than Quasi Peak Mode Limit Bellow 1 GHz, the EUT shall be deemed to meet QP Limits and then no additional QP Mode measurement performed. But the Peak Value and average value both need to comply with applicable limit above 1 GHz.
- (5) Testing frequency range below 1GHz the measuring instrument use VBW=120 kHz with Quasi-peak detection.
- (6) Testing frequency range above 1GHz the measuring instrument use RBW=1 MHz and VBW=3 MHz with Peak Detector for Peak Values, and use RBW=1 MHz and VBW=10 Hz with Peak Detector for Average Values.
- (7) For the actual test configuration, please see the test setup photo.

5.4 Test Data

- (1) 9kHz~30MHz

Note: The emissions of 9kHz~30MHz are not reported, because the levels are too low against the limit.

(2) 30MHz~ 1GHz

Temperature :	23℃	Relative Humidity :	48 %
Antenna.	Horizontal		
Test Voltage :	AC120V/60Hz		
Test Mode :	Mode 1: USB Charging Mode		
Remark:	Emission Level= Read Level+ Correct Factor		

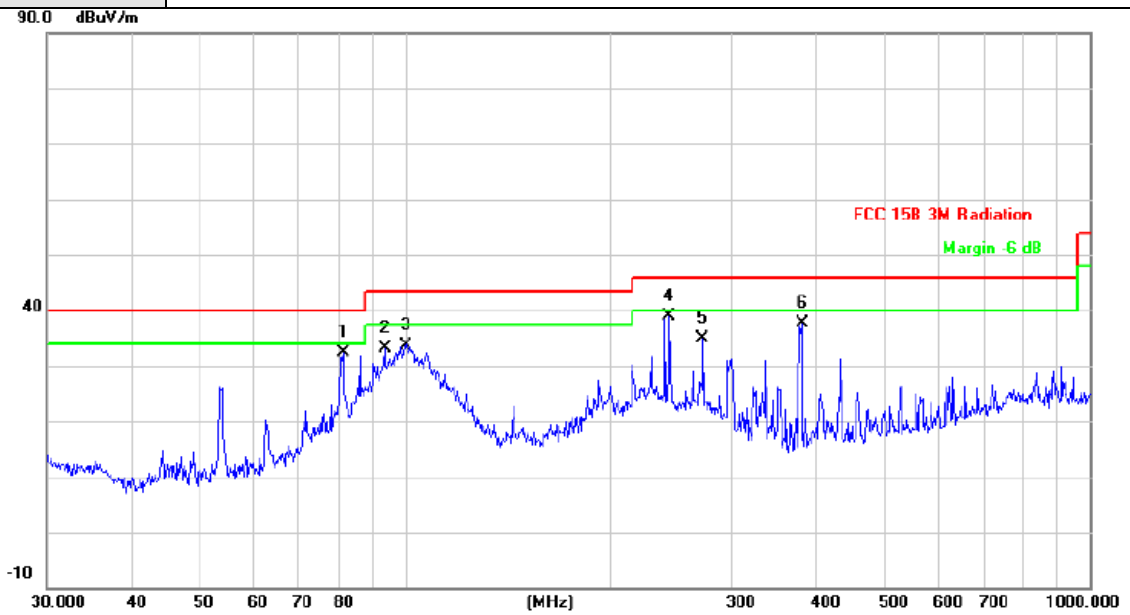

No.	Mk.	Freq. MHz	Reading Level dBuV	Correct Factor dB/m	Measure- ment dBuV/m	Limit dBuV/m	Over dB	Detector
1		81.2116	55.55	-23.21	32.34	40.00	-7.66	peak
2		93.4402	55.45	-22.39	33.06	43.50	-10.44	peak
3		100.2286	55.57	-21.82	33.75	43.50	-9.75	peak
4	*	243.3771	57.27	-18.43	38.84	46.00	-7.16	peak
5		272.2776	52.60	-17.63	34.97	46.00	-11.03	peak
6		379.9141	51.69	-14.14	37.55	46.00	-8.45	peak

Temperature :	23 °C	Relative Humidity :	48 %
Antenna.	Vertical		
Test Voltage :	AC120V/60Hz		
Test Mode :	Mode 1: USB Charging Mode		
Remark:	Emission Level= Read Level+ Correct Factor		

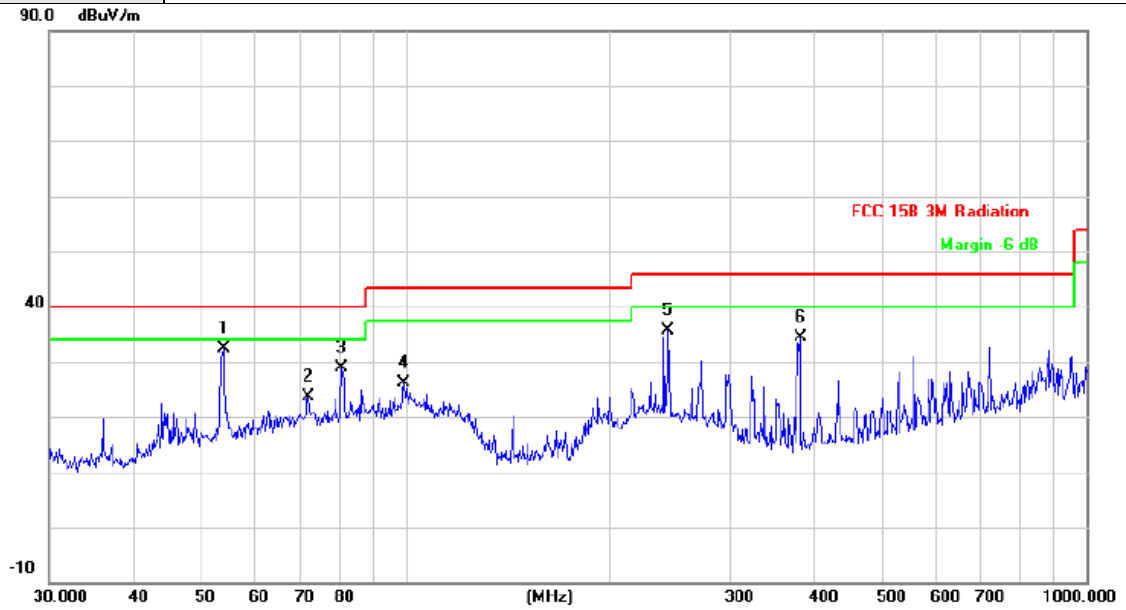

No.	Mk.	Freq.	Reading Level	Correct Factor	Measurement	Limit	Over	Detector
		MHz	dBuV	dB/m	dBuV/m	dBuV/m	dB	
1	*	54.0711	56.93	-24.45	32.48	40.00	-7.52	peak
2		72.0843	47.13	-23.54	23.59	40.00	-16.41	peak
3		80.6442	52.03	-23.25	28.78	40.00	-11.22	peak
4		99.5281	48.10	-21.86	26.24	43.50	-17.26	peak
5		243.3772	54.03	-18.43	35.60	46.00	-10.40	peak
6		379.9141	48.57	-14.14	34.43	46.00	-11.57	peak

Temperature :	23°C	Relative Humidity :	48 %
Antenna.	Horizontal		
Test Voltage :	DC 3.7V		
Test Mode :	Mode 2: BLE TX2402MHz Mode		
Remark:	Emission Level= Read Level+ Correct Factor		

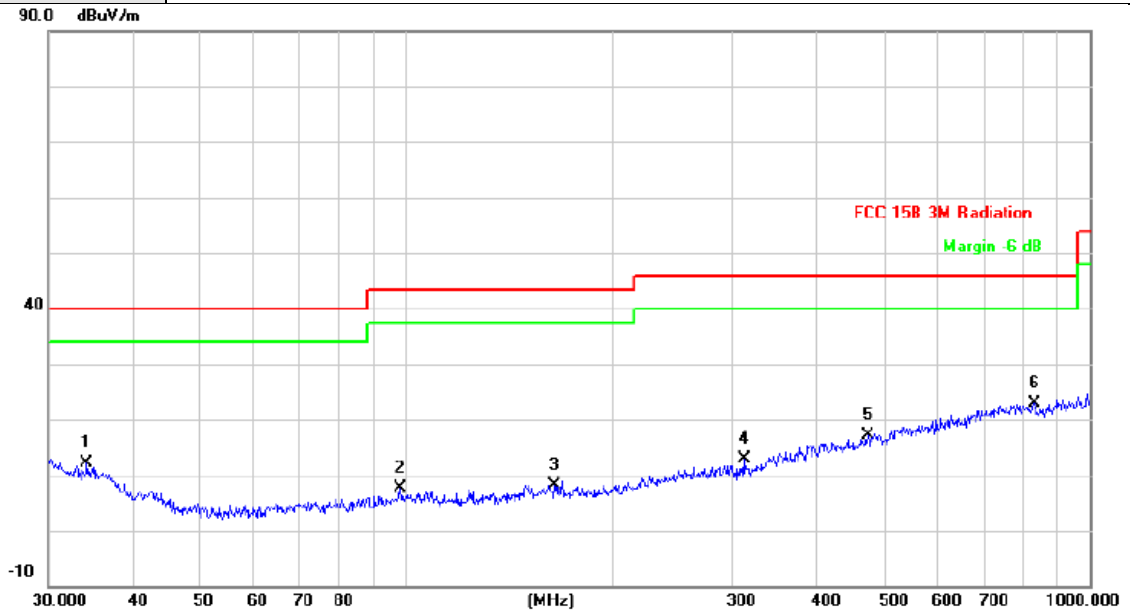

No.	Mk.	Freq. MHz	Reading Level dBuV	Correct Factor dB/m	Measure- ment dBuV/m	Limit dBuV/m	Over dB	Detector
1		34.1561	28.54	-16.53	12.01	40.00	-27.99	peak
2		98.1419	29.53	-21.98	7.55	43.50	-35.95	peak
3		164.9075	29.04	-20.84	8.20	43.50	-35.30	peak
4		312.1794	29.43	-16.63	12.80	46.00	-33.20	peak
5		473.8347	28.66	-11.64	17.02	46.00	-28.98	peak
6	*	830.4002	29.30	-6.38	22.92	46.00	-23.08	peak

Temperature :	23°C	Relative Humidity :	48 %
Antenna.	Vertical		
Test Voltage :	DC 3.7V		
Test Mode :	Mode 2: BLE TX2402MHz Mode		
Remark:	Emission Level= Read Level+ Correct Factor		

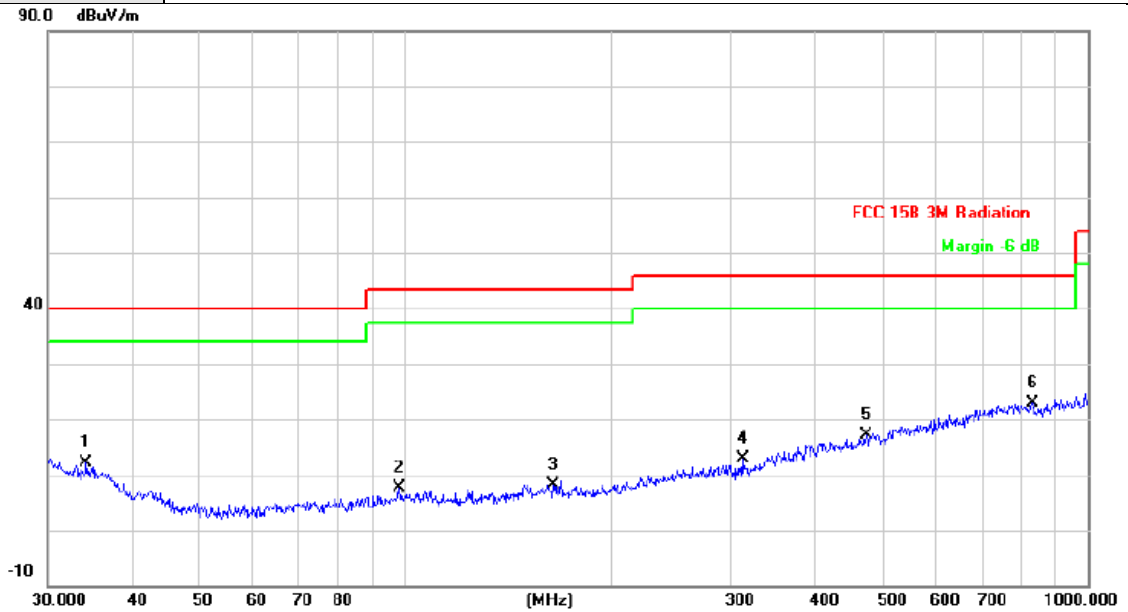

No.	Mk.	Freq. MHz	Reading Level dBuV	Correct Factor dB/m	Measure- ment dBuV/m	Limit dBuV/m	Over dB	Detector
1		34.1561	28.54	-16.53	12.01	40.00	-27.99	peak
2		98.1419	29.53	-21.98	7.55	43.50	-35.95	peak
3		164.9075	29.04	-20.84	8.20	43.50	-35.30	peak
4		312.1794	29.43	-16.63	12.80	46.00	-33.20	peak
5		473.8347	28.66	-11.64	17.02	46.00	-28.98	peak
6	*	830.4002	29.30	-6.38	22.92	46.00	-23.08	peak

(3) 1GHz~26.5 GHz

Temperature :	23℃	Relative Humidity :	48 %
Antenna.	Horizontal		
Test Voltage :	DC 3.7V		
Test Mode :	Mode 2: BLE TX2402MHz Mode		
Remark:	Emission Level= Read Level+ Correct Factor		

No. Mk.	Freq.	Reading Level	Correct Factor	Measurement	Limit	Over	
	MHz	dBuV	dB	dBuV/m	dBuV/m	dB	Detector
1	4803.403	47.09	8.18	55.27	74.00	-18.73	peak
2 *	4803.850	35.93	8.18	44.11	54.00	-9.89	AVG

Temperature :	23℃	Relative Humidity :	48 %
Antenna.	Vertical		
Test Voltage :	DC 3.7V		
Test Mode :	Mode 2: BLE TX2402MHz Mode		
Remark:	Emission Level= Read Level+ Correct Factor		

No. Mk.	Freq.	Reading Level	Correct Factor	Measurement	Limit	Over	
	MHz	dBuV	dB	dBuV/m	dBuV/m	dB	Detector
1	4803.442	48.27	8.18	56.45	74.00	-17.55	peak
2 *	4803.889	36.99	8.18	45.17	54.00	-8.83	AVG

Temperature :	23°C	Relative Humidity :	48 %
Antenna.	Horizontal		
Test Voltage :	DC 3.7V		
Test Mode :	Mode 2: BLE TX2442MHz Mode		
Remark:	Emission Level= Read Level+ Correct Factor		

No. Mk.	Freq.	Reading Level	Correct Factor	Measurement	Limit	Over	
	MHz	dBuV	dB	dBuV/m	dBuV/m	dB	Detector
1	4883.535	47.59	8.22	55.81	74.00	-18.19	peak
2 *	4883.871	36.01	8.22	44.23	54.00	-9.77	AVG

Temperature :	23°C	Relative Humidity :	48 %
Antenna.	Vertical		
Test Voltage :	DC 3.7V		
Test Mode :	Mode 2: BLE TX2442MHz Mode		
Remark:	Emission Level= Read Level+ Correct Factor		

No. Mk.	Freq.	Reading Level	Correct Factor	Measurement	Limit	Over	
	MHz	dBuV	dB	dBuV/m	dBuV/m	dB	Detector
1 *	4883.871	38.01	8.22	46.23	54.00	-7.77	AVG
2	4884.261	47.50	8.21	55.71	74.00	-18.29	peak

Temperature :	23°C	Relative Humidity :	48 %
Antenna.	Horizontal		
Test Voltage :	DC 3.7V		
Test Mode :	Mode 2: BLE TX2480MHz Mode		
Remark:	Emission Level= Read Level+ Correct Factor		

No. Mk.	Freq.	Reading Level	Correct Factor	Measurement	Limit	Over	
	MHz	dBuV	dB	dBuV/m	dBuV/m	dB	Detector
1	4959.388	48.88	8.23	57.11	74.00	-16.89	peak
2 *	4959.871	38.22	8.23	46.45	54.00	-7.55	AVG

Temperature :	23°C	Relative Humidity :	48 %
Antenna.	Vertical		
Test Voltage :	DC 3.7V		
Test Mode :	Mode 2: BLE TX2480MHz Mode		
Remark:	Emission Level= Read Level+ Correct Factor		

No. Mk.	Freq.	Reading Level	Correct Factor	Measurement	Limit	Over	
	MHz	dBuV	dB	dBuV/m	dBuV/m	dB	Detector
1	4959.580	48.11	8.23	56.34	74.00	-17.66	peak
2 *	4959.871	36.31	8.23	44.54	54.00	-9.46	AVG

6 Band Edge

6.1 Test Standard and Limit

6.1.1 Test Standard

FCC 15.209/FCC 15.247

6.1.2 Limits

Restricted Frequency Band (MHz)	Class B (dBuV/m)(at 3 M)	
	Peak	Average
2310 ~2390	74	54
2483.5 ~2500	74	54

6.2 Test Setup

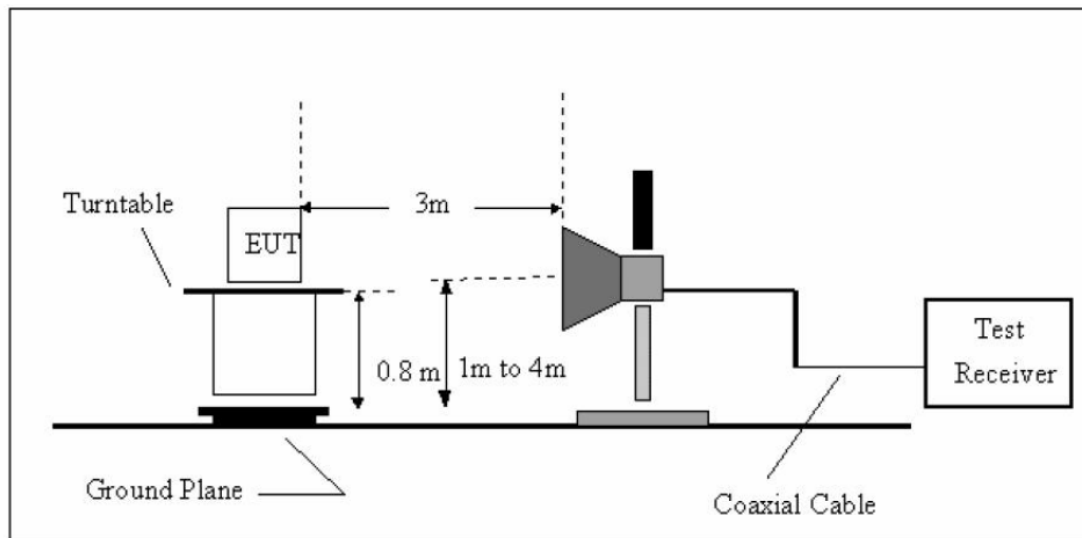

6.3 Test Procedure

- (1) The measuring distance of 3m shall be used for measurements at frequency up to 1GHz and above 1 GHz. The EUT was placed on a rotating 0.8m high above ground, the table was rotated 360 degrees to determine the position of the highest radiation.
- (2) The Test antenna shall vary between 1m and 4m, Both Horizontal and Vertical antenna are set to make measurement.
- (3) The initial step in collecting conducted emission data is a spectrum analyzer peak detector mode pre-scanning the measurement frequency range. Significant peaks are then marked and then Quasi Peak detector mode re-measured.
- (4) If the Peak Mode measured value compliance with and lower than Quasi Peak Mode Limit

Bellow 1 GHz, the EUT shall be deemed to meet QP Limits and then no additional QP Mode measurement performed. But the Peak Value and average value both need to comply with applicable limit above 1 GHz.

- (5) Testing frequency range below 1GHz the measuring instrument use VBW=120 kHz with Quasi-peak detection.
- (6) Testing frequency range above 1GHz the measuring instrument use RBW=1 MHz and VBW=3 MHz with Peak Detector for Peak Values, and use RBW=1 MHz and VBW=10 Hz with Peak Detector for Average Values.
- (7) For the actual test configuration, please see the test setup photo.

6.4 Test Data

(1) Radiation Test

Temperature :	23°C	Relative Humidity :	48 %
Antenna.	Horizontal		
Test Voltage :	DC 3.7V		
Test Mode :	Mode 2: BLE TX2402MHz Mode		
Remark:	Emission Level= Read Level+ Correct Factor		

No. Mk.	Freq.	Reading Level	Correct Factor	Measurement	Limit	Over	Detector	Comment
	MHz	dBuV	dB	dBuV/m	dBuV/m	dB		
1	2390.000	45.67	0.77	46.44	74.00	-27.56	peak	
2	2390.000	32.58	0.77	33.35	54.00	-20.65	AVG	
3 X	2401.800	83.29	0.82	84.11	74.00	10.11	peak	Fundamental Frequency
4 *	2402.000	81.85	0.82	82.67	54.00	28.67	AVG	Fundamental Frequency

Temperature :	23°C	Relative Humidity :	48 %
Antenna.	Vertical		
Test Voltage :	DC 3.7V		
Test Mode :	Mode 2: BLE TX2402MHz Mode		
Remark:	Emission Level= Read Level+ Correct Factor		

No. Mk.	Freq.	Reading Level	Correct Factor	Measurement	Limit	Over	Detector	Comment
	MHz	dBuV	dB	dBuV/m	dBuV/m	dB		
1	2390.000	45.58	0.77	46.35	74.00	-27.65	peak	
2	2390.000	32.65	0.77	33.42	54.00	-20.58	AVG	
3 X	2401.700	84.85	0.82	85.67	74.00	11.67	peak	Fundamental Frequency
4 *	2402.000	83.64	0.82	84.46	54.00	30.46	AVG	Fundamental Frequency

Temperature :	23°C	Relative Humidity :	48 %
Antenna.	Horizontal		
Test Voltage :	DC 3.7V		
Test Mode :	Mode 2: BLE TX2480MHz Mode		
Remark:	Emission Level= Read Level+ Correct Factor		

No.	Mk.	Freq.	Reading Level	Correct Factor	Measurement	Limit	Over	Detector	Comment
		MHz	dBuV	dB	dBuV/m	dBuV/m	dB		
1	X	2479.700	84.53	1.15	85.68	74.00	11.68	peak	Fundamental Frequency
2	*	2479.900	83.20	1.15	84.35	54.00	30.35	AVG	Fundamental Frequency
3		2483.500	53.60	1.17	54.77	74.00	-19.23	peak	
4		2483.500	34.51	1.17	35.68	54.00	-18.32	AVG	
5		2500.000	44.55	1.23	45.78	74.00	-28.22	peak	
6		2500.000	32.35	1.23	33.58	54.00	-20.42	AVG	

Temperature :	23°C	Relative Humidity :	48 %
Antenna.	Vertical		
Test Voltage :	DC 3.7V		
Test Mode :	Mode 2: BLE TX2480MHz Mode		
Remark:	Emission Level= Read Level+ Correct Factor		

No.	Mk.	Freq.	Reading Level	Correct Factor	Measurement	Limit	Over	Detector	Comment
		MHz	dBuV	dB	dBuV/m	dBuV/m	dB		
1	X	2479.700	81.29	3.50	84.79	74.00	10.79	peak	Fundamental Frequency
2	*	2479.900	80.31	3.50	83.81	54.00	29.81	AVG	Fundamental Frequency
3		2483.500	49.71	3.51	53.22	74.00	-20.78	peak	
4		2483.500	32.54	3.51	36.05	54.00	-17.95	AVG	
5		2500.000	40.69	3.52	44.21	74.00	-29.79	peak	
6		2500.000	29.36	3.52	32.88	54.00	-21.12	AVG	

(2) Conducted Test

Temperature :	23°C	Relative Humidity :	48 %
Test Voltage :	DC 3.7V		
Test Mode :	Mode 2: BLE TX2402MHz Mode		
Remark:			

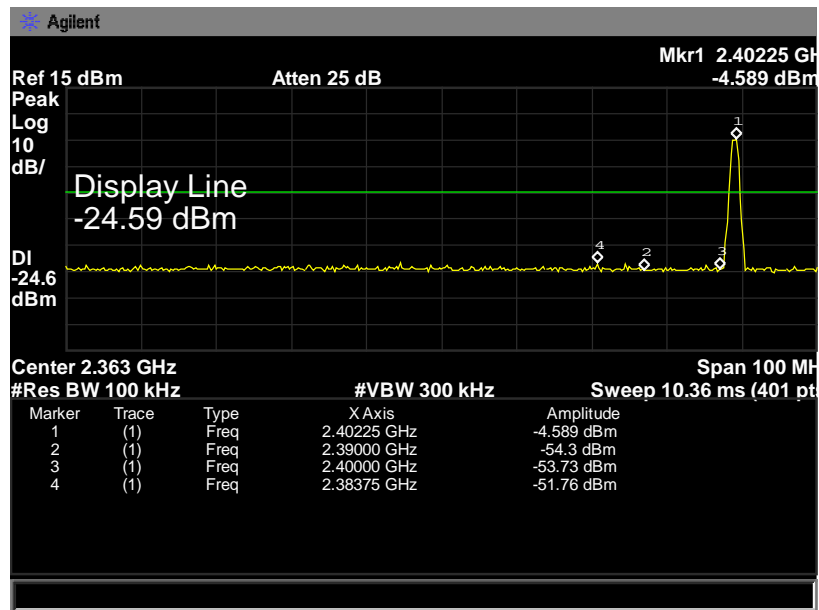

Temperature :	23°C	Relative Humidity :	48 %
Test Voltage :	DC 3.7V		
Test Mode :	Mode 2: BLE TX2480MHz Mode		
Remark:			

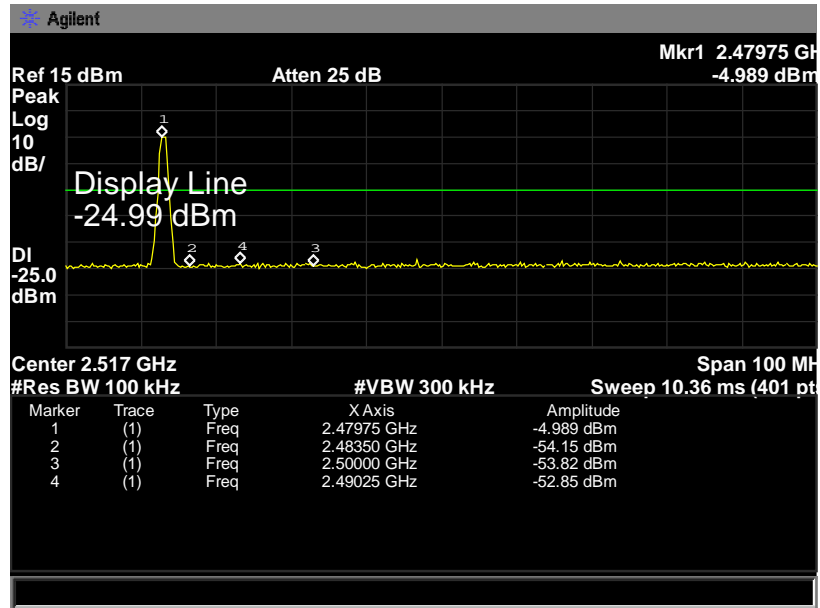

7 Peak Power Test

7.1 Test Standard and Limit

7.1.1 Test Standard

FCC 15.247

7.1.2 Limits

FCC Part 15 Subpart C(15.247)		
Test Item	Limit	Frequency Range(MHz)
Peak Output Power	1 Watt or 30 dBm	2400~2483.5

7.2 Test Setup

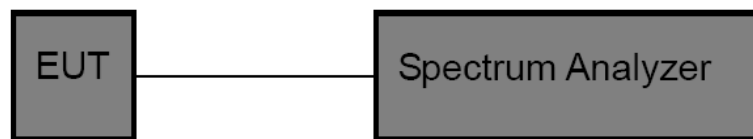

7.3 Test Procedure

The EUT was directly connected to the Spectrum Analyzer and antenna output port as show in the block diagram above. The measurement is according to section 9.1.1 of KDB 558074 D01 DTS Meas Guidance v03r02.

- (1) Set the $RBW \geq DTS$ Bandwidth
- (2) Set $VBW \geq 3 * RBW$
- (3) Set $Span \geq 3 * RBW$
- (4) Sweep time=auto
- (5) Detector= peak
- (6) Trace mode= maxhold.
- (7) Allow trace to fully stabilize, and then use peak marker function to determine the peak amplitude level.

7.4 Test Data

Peak Power		
Channel frequency (MHz)	Test Result (dBm)	Limit (dBm)
2402	-3.923	30
2442	-3.938	
2480	-4.435	

2402 MHz

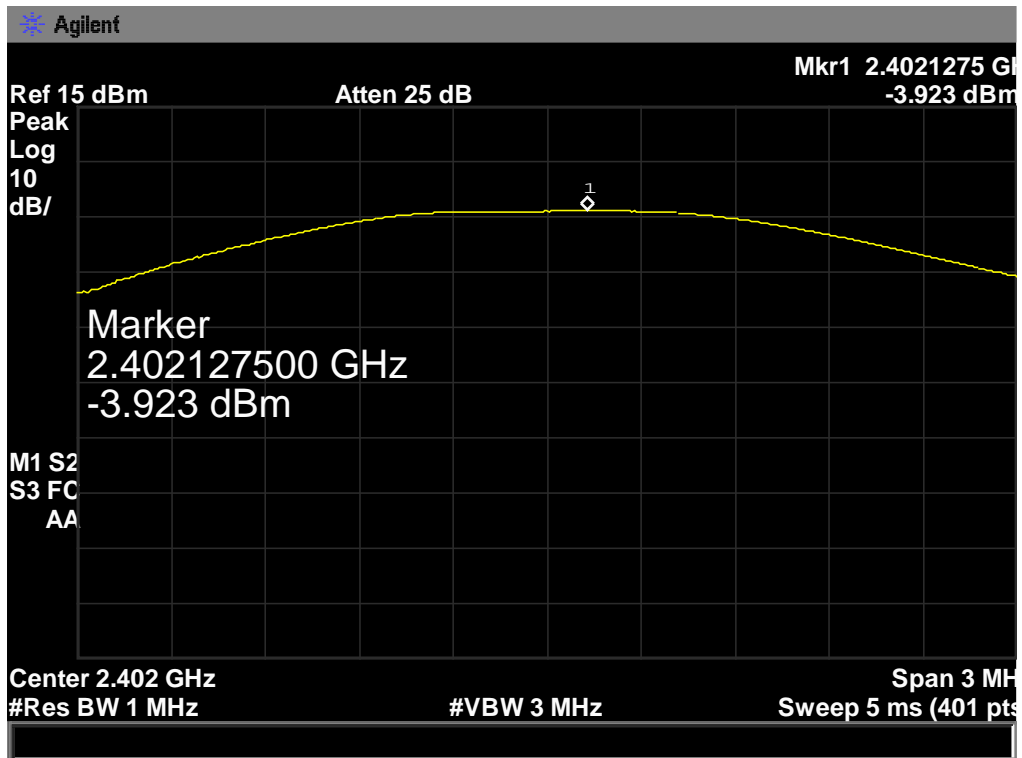

2442 MHz

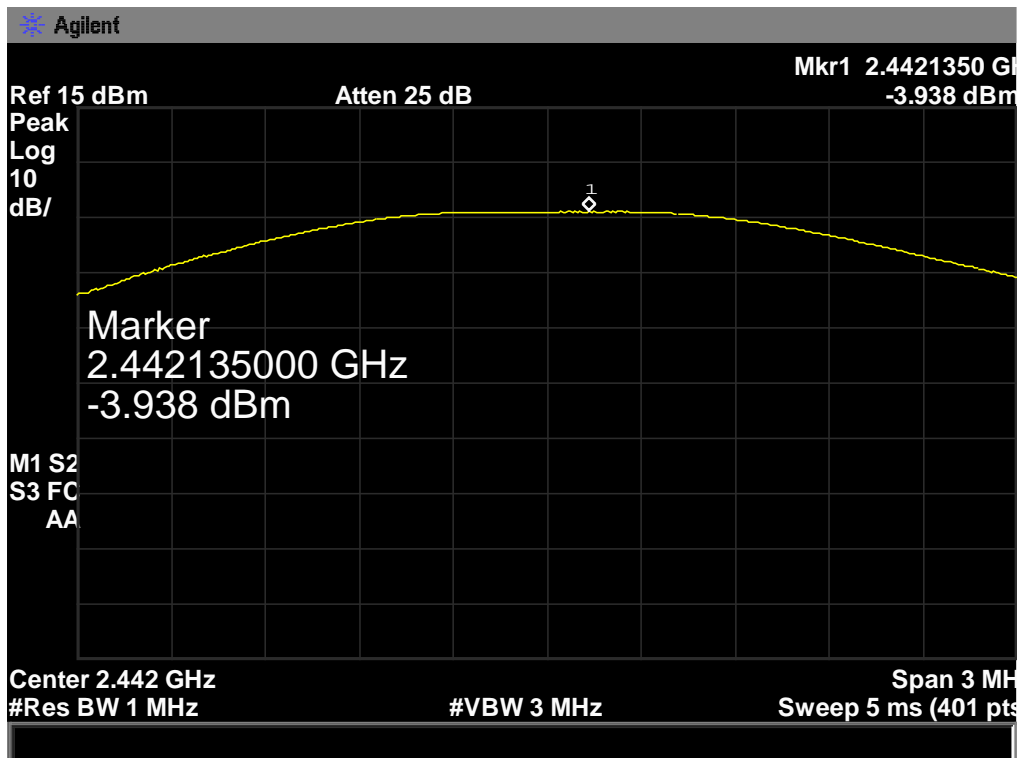

2480 MHz

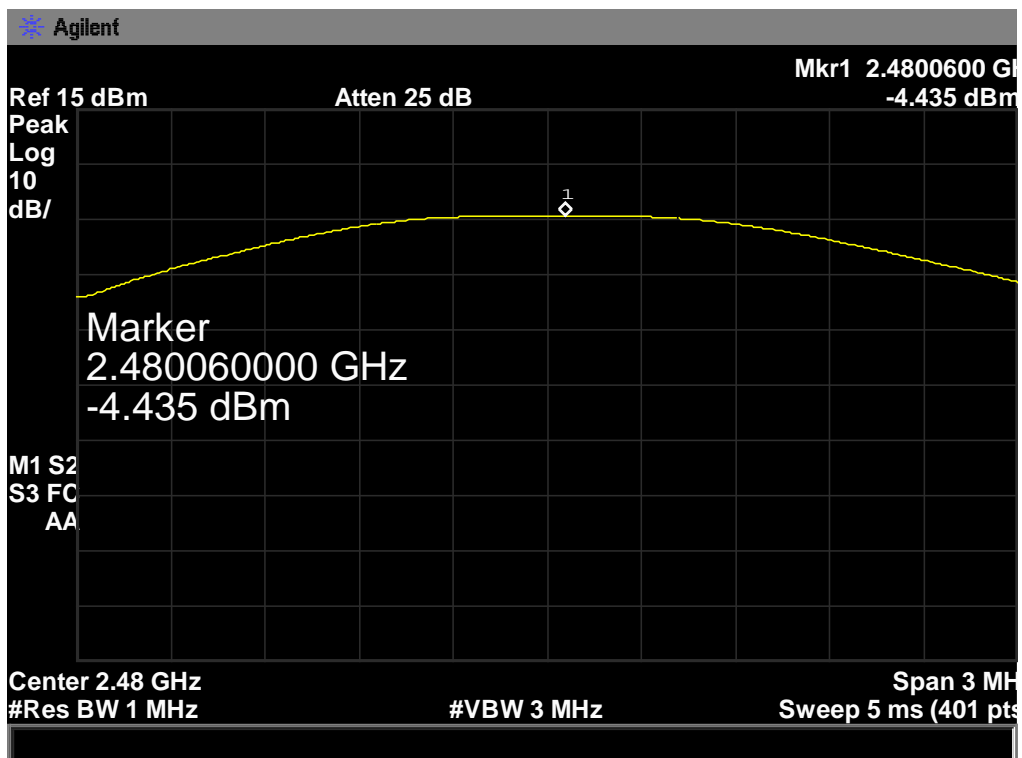

8 Bandwidth

8.1 Test Standard and Limit

8.1.1 Test Standard

FCC 15.247

8.1.2 Limits

FCC Part 15 Subpart C(15.247)/RSS-210		
Test Item	Limit	Frequency Range(MHz)
Bandwidth	≥ 500 KHz (6dB bandwidth)	2400~2483.5

8.2 Test Setup

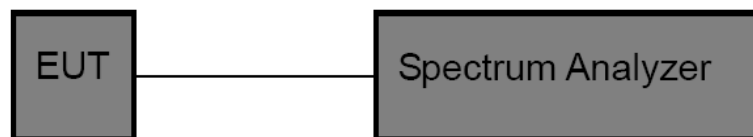

8.3 Test Procedure

- (1) The EUT was directly connected to the spectrum analyzer and antenna output port as show in the block diagram above.
- (2) The bandwidth is measured at an amplitude level reduced 6dB from the reference level. The reference level is the level of the highest amplitude signal observed from the transmitter at the fundamental frequency. Once the reference level is established, the equipment is conditioned with typical modulating signal to produce the worst –case (i.e the widest) bandwidth.
- (3) Measure the channel separation the spectrum analyzer was set to Resolution Bandwidth:100 kHz, and Video Bandwidth:300 kHz, Detector: Peak, Sweep Time set auto.

8.4 Test Data

-6 dB Bandwidth		
Channel frequency (MHz)	Test Result (kHz)	Limit (kHz)
2402	730.259	>500
2442	705.210	
2480	694.380	

2402 MHz

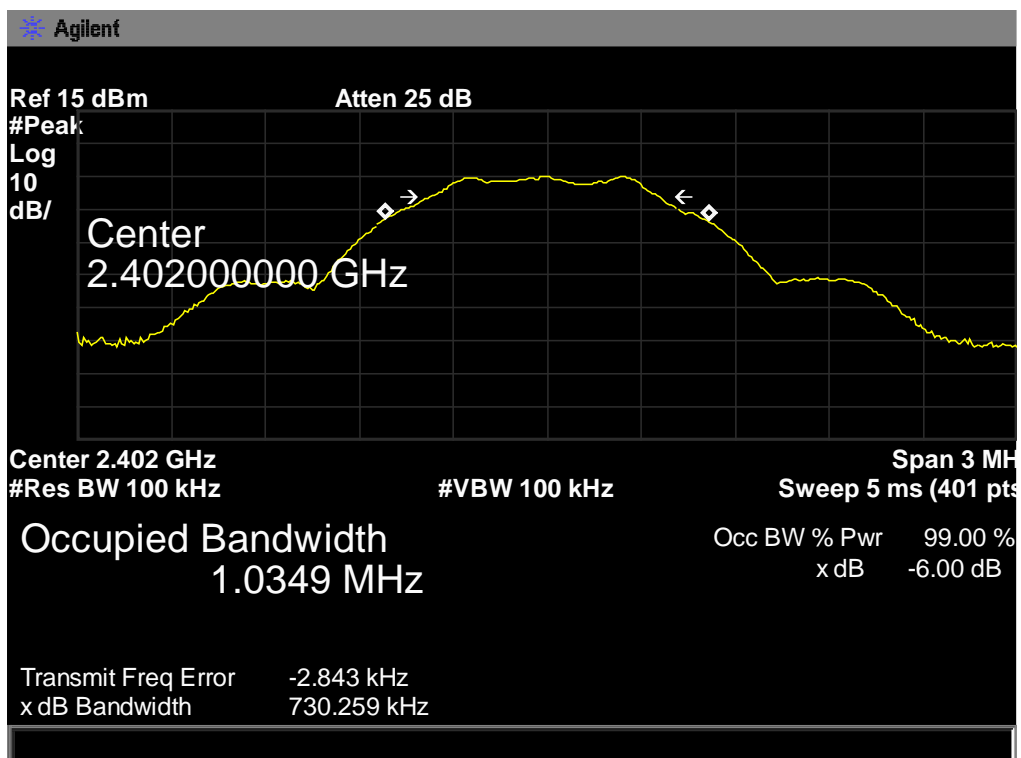

2442 MHz

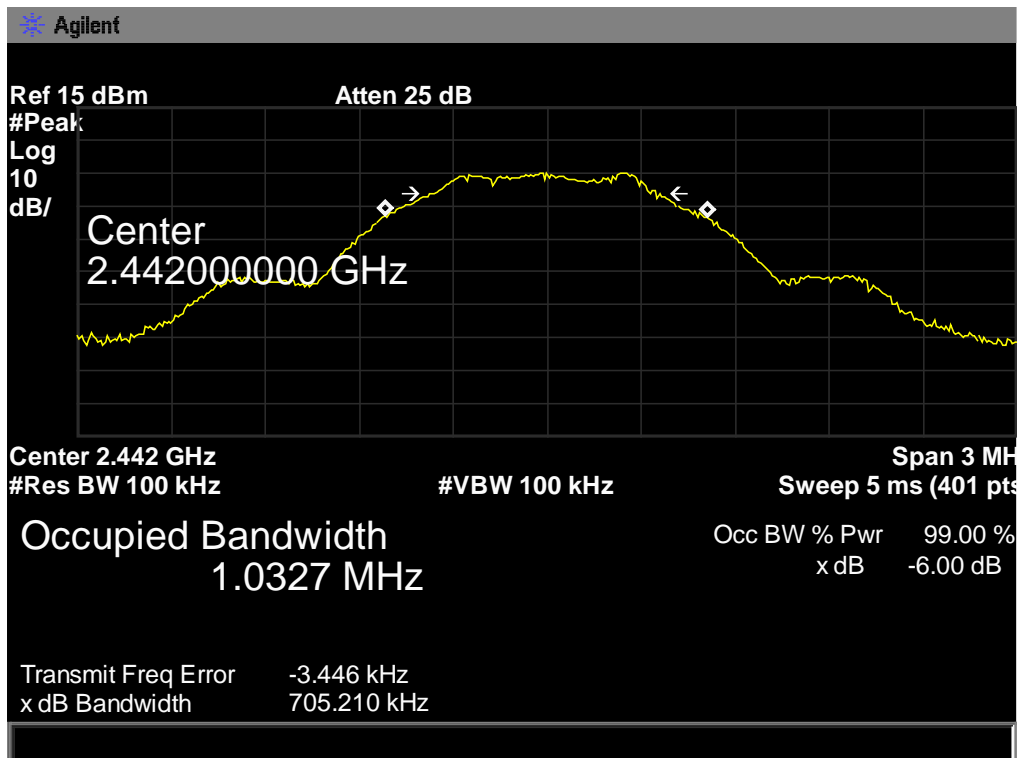

2480 MHz

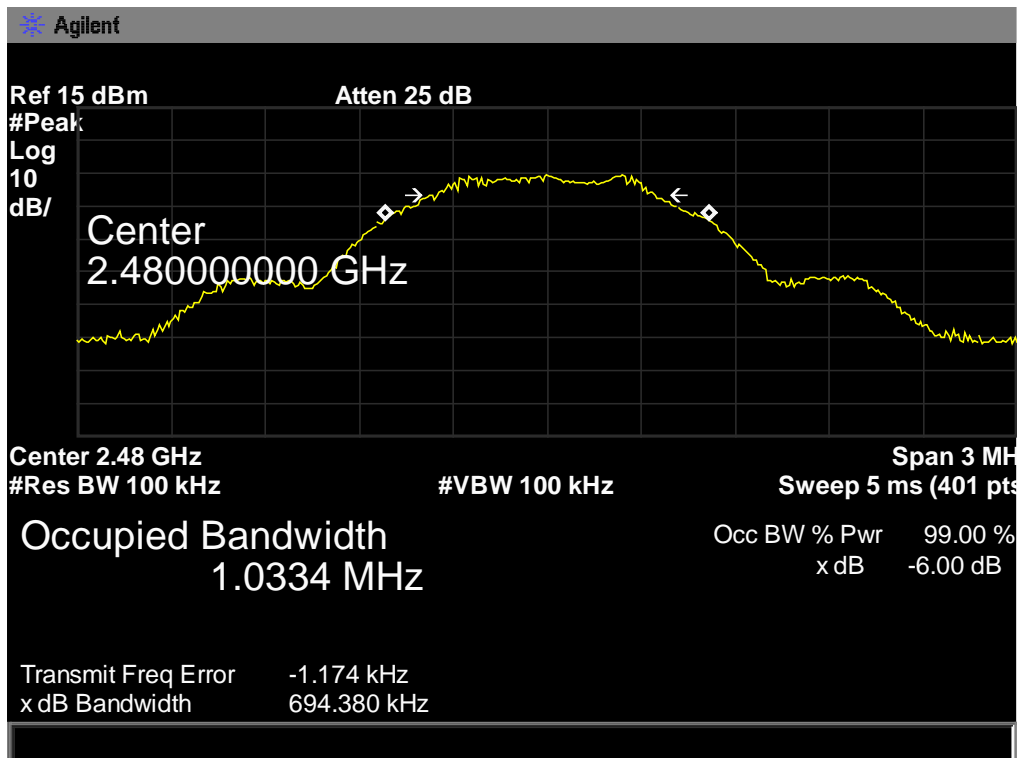

9 Power Density

9.1 Test Standard and Limit

9.1.1 Test Standard

FCC 15.247

9.1.2 Limits

FCC Part 15 Subpart C(15.247)		
Test Item	Limit	Frequency Range(MHz)
Power Spectral Density	8dBm(in any 3 kHz)	2400~2483.5

9.2 Test Setup

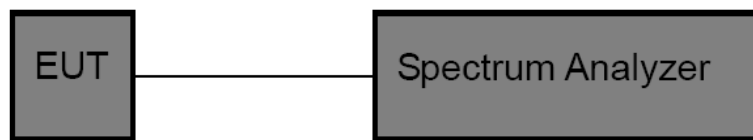

9.3 Test Procedure

The EUT was directly connected to the Spectrum Analyzer and antenna output port as show in the block diagram above. The measurement according to section 10.2 of KDB 558074 D01 DTS Meas Guidance v03r02.

- (1) The EUT was directly connected to the spectrum analyzer and antenna output port as show in the block diagram above.
- (2) Set analyser center frequency to DTS channel center frequenyc.
- (3) Set the span to 1.5 times the DTS bandwidth.
- (4) Set the RBW to: 3 kHz
- (5) Set the VBW to: 10 kHz
- (6) Detector: peak
- (7) Sweep time: auto
- (8) Allow trace to fully stabilize. Then use the peak marker function to determine the maximum amplitude level.

9.4 Test Data

Power Density		
Channel frequency (MHz)	Test Result (dBm)	Limit (dBm)
2402	-18.65	<8
2442	-18.67	
2480	-19.14	

2402 MHz

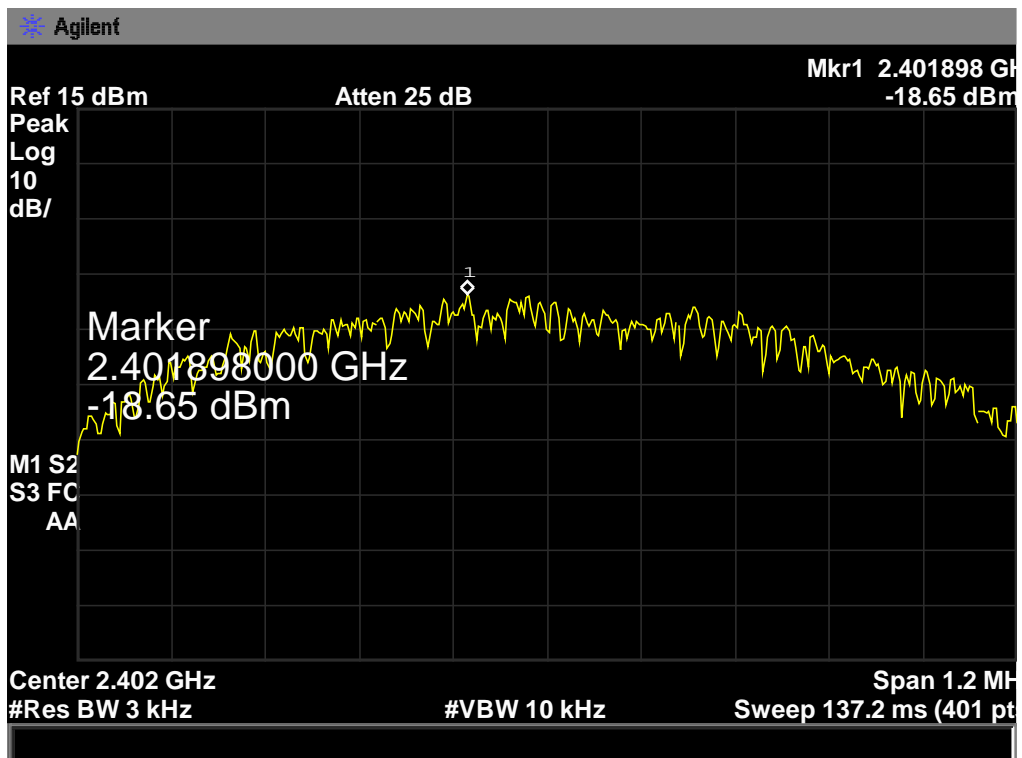

2442 MHz

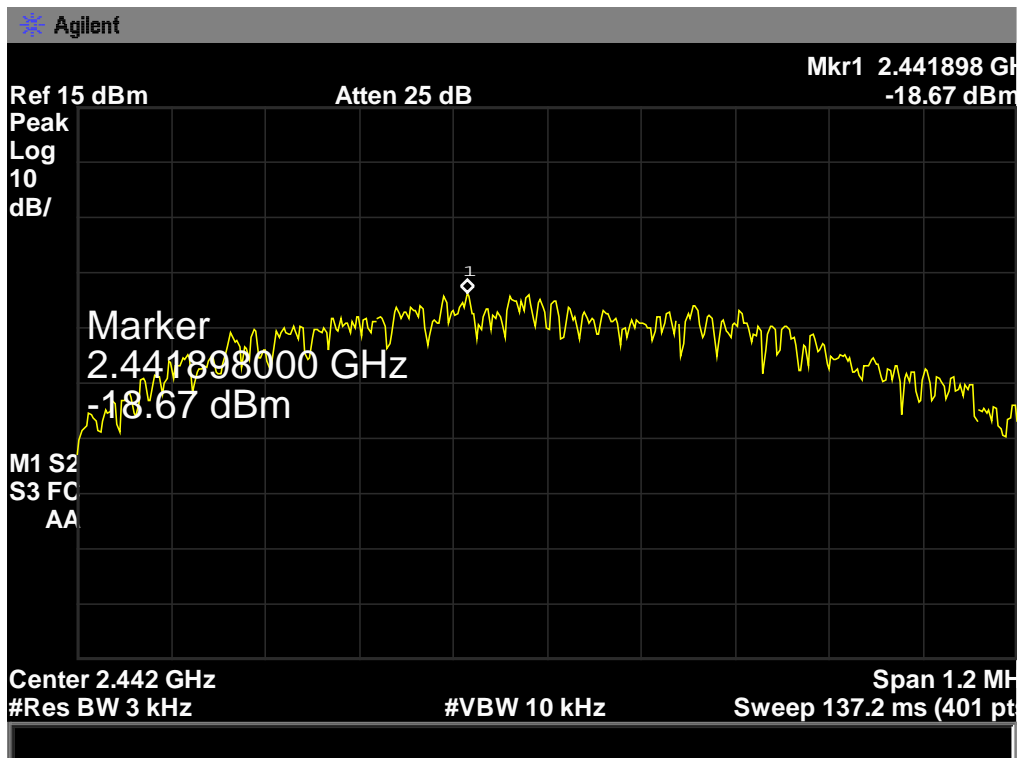

2480 MHz

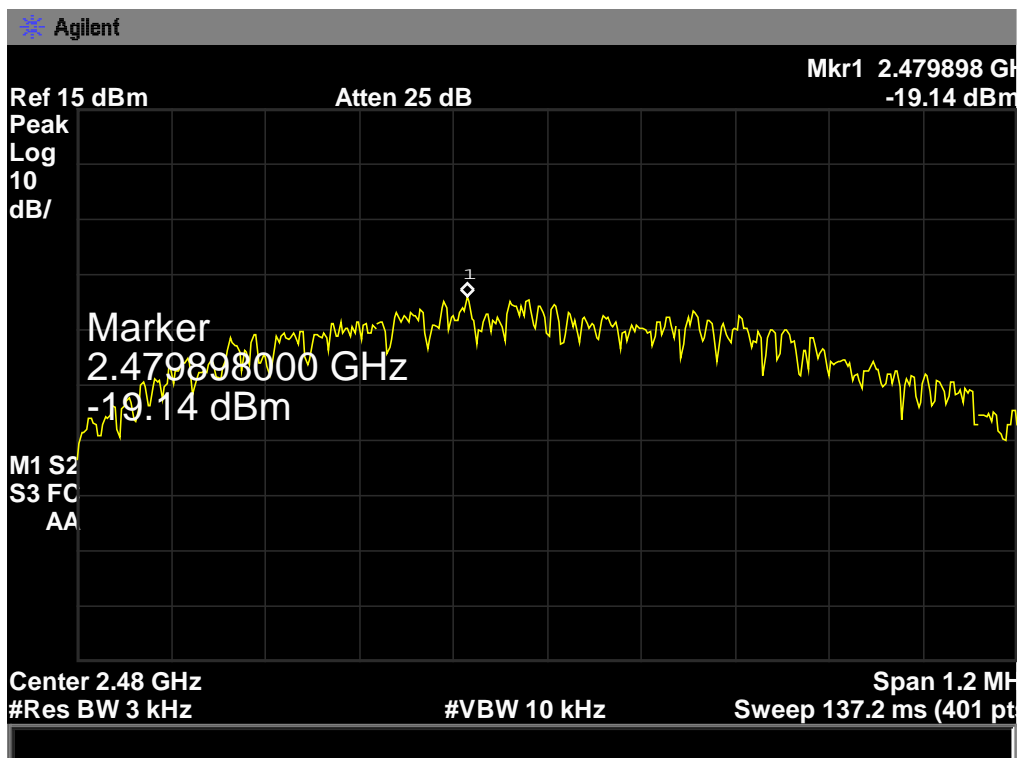

10 Antenna Conducted Emissions

10.1 Test Standard and Limit

10.1.1 Test Standard

FCC 15.247

10.1.2 Limits

In any 100 kHz bandwidth outside the frequency band in which the spread spectrum or digitally modulated intentional radiator is operating, the radio frequency power that is produced by the intentional radiator shall be at least 20 dB below that in the 100 kHz bandwidth within the band that contains the highest level of the desired power. In case the emission fall within the restricted band specified on 15.205(a), then the 15.209(a) limit in the table below has to be followed.

Frequencies (MHz)	Field Strength (microvolt/meter)	Measurement Distance (meters)
0.009~0.490	2400/F(KHz)	300
0.490~1.705	24000/F(KHz)	30
1.705~30.0	30	30
30~88	100	3
88~216	150	3
216~960	200	3
Above~960	500	3

10.2 Test Setup

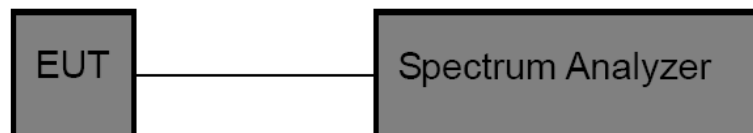

10.3 Test Procedure

- (1) The EUT was directly connected to the spectrum analyzer and antenna output port as show in the block diagram above.
- (2) Spectrum Setting:
RBW=100 KHz, VBW=300 KHz.

Frequency range: from 30 MHz to 25 GHz.

10.4 Test Data

TX 2402 MHz Conducted Spurious Emission (1GHz~26.5GHz)

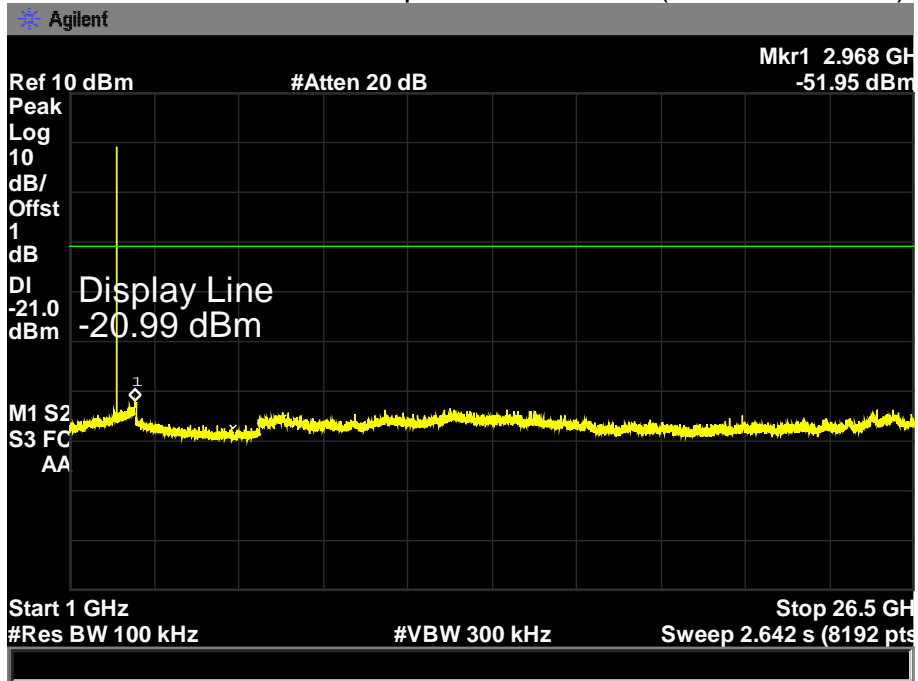

TX 2402 MHz Conducted Spurious Emission (30MHz~1GHz)

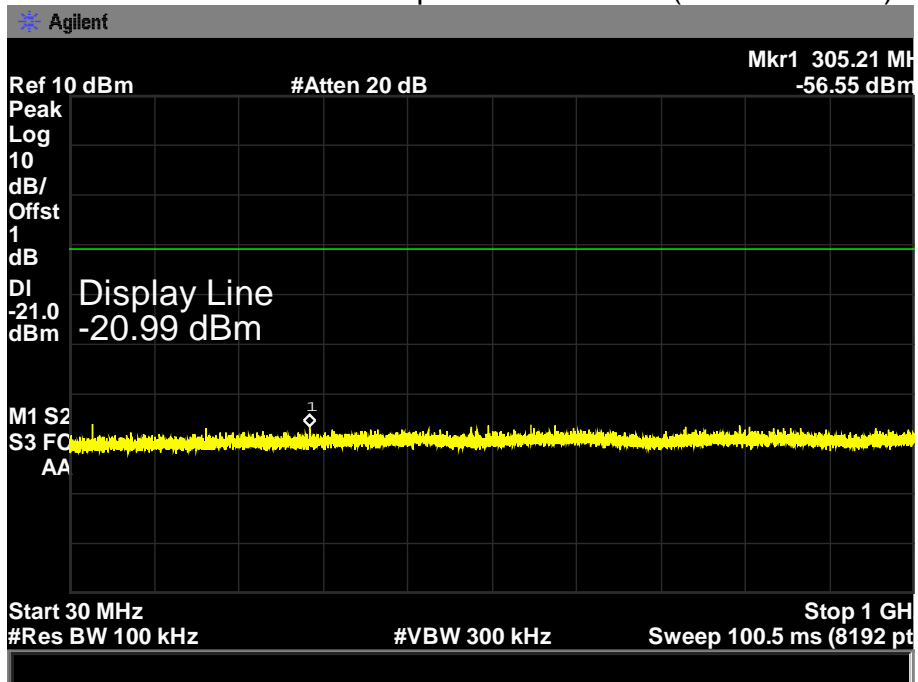

TX 2442 MHz Conducted Spurious Emission (1GHz~26.5GHz)

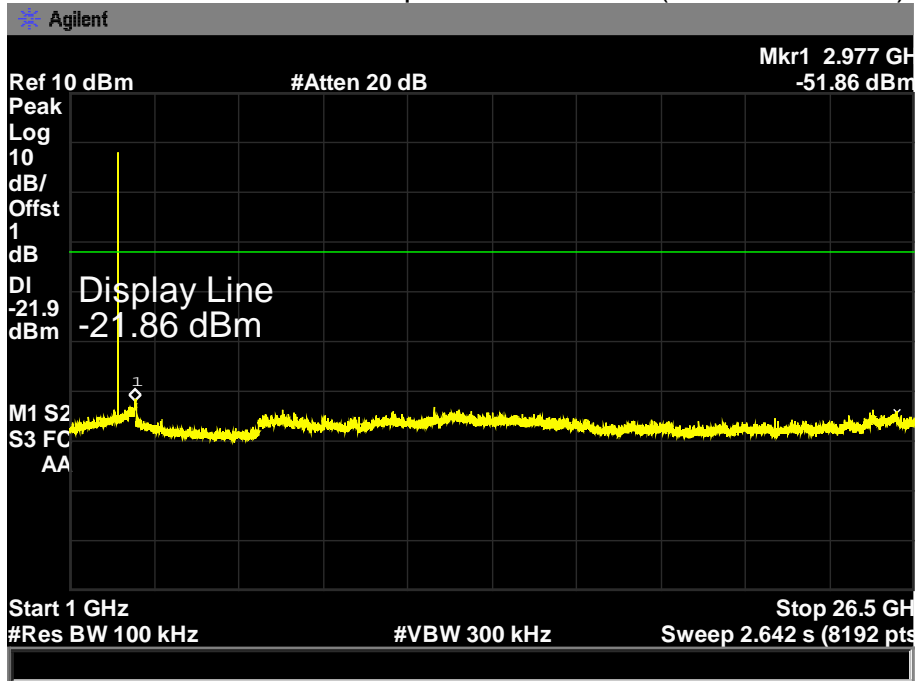

TX 2442 MHz Conducted Spurious Emission (30MHz~1GHz)

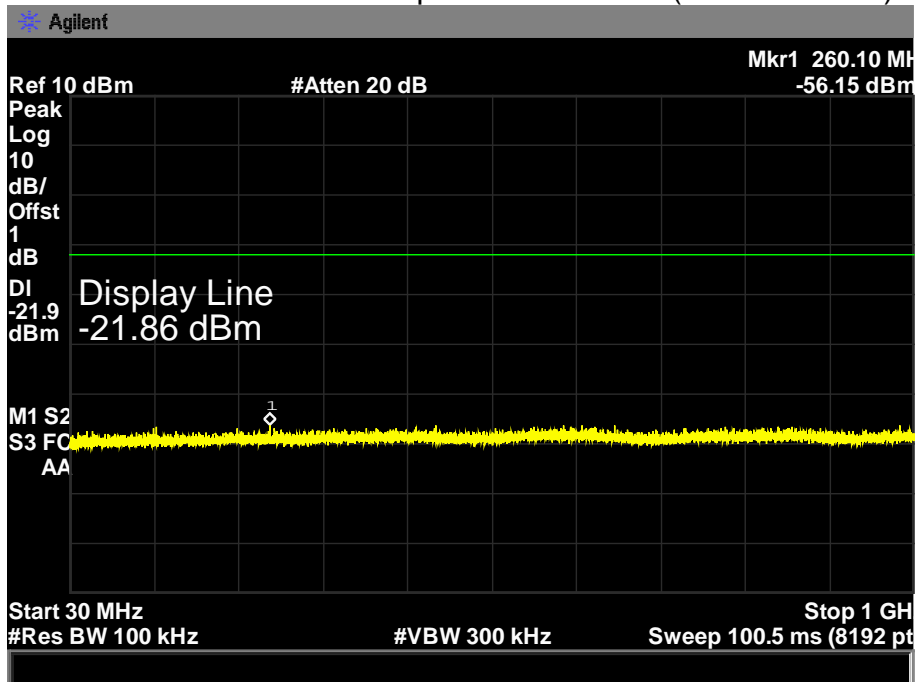

TX 2480 MHz Conducted Spurious Emission (1GHz~26.5GHz)

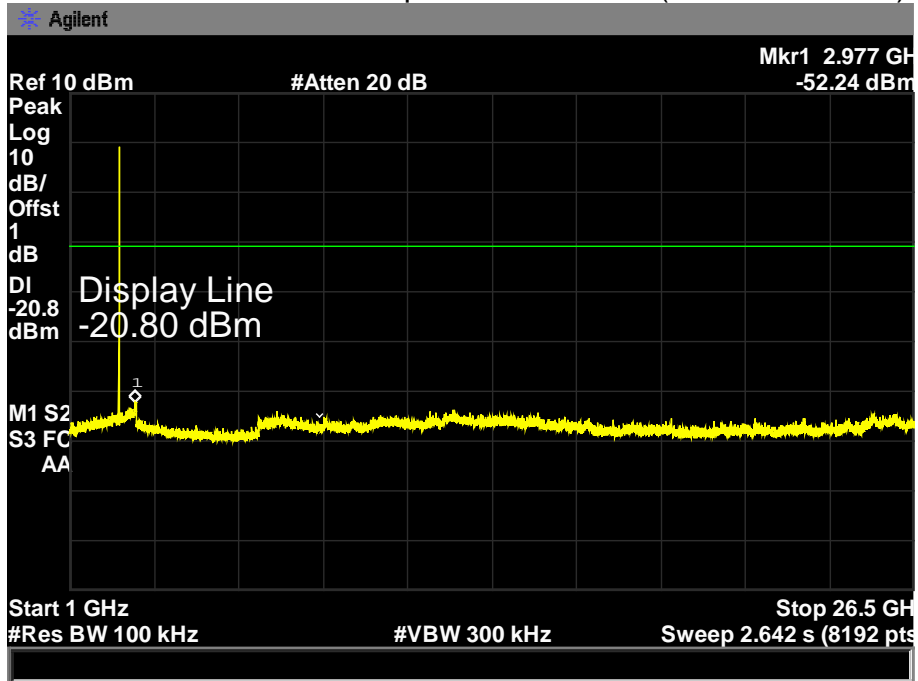

TX 2480 MHz Conducted Spurious Emission (30MHz~1GHz)

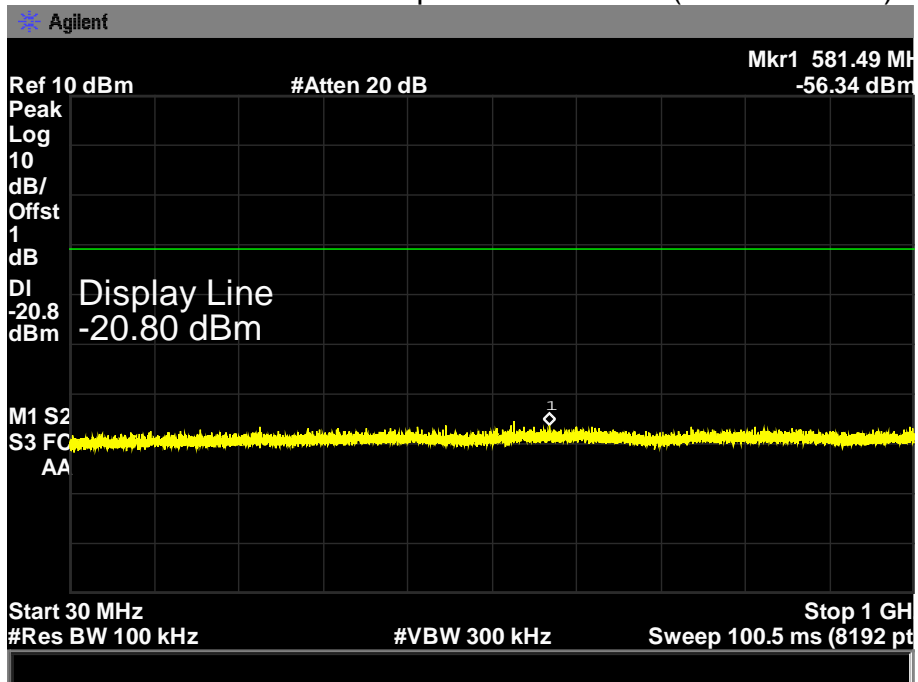

11 Antenna Requirement

11.1 Standard and Limit

11.1.1 Requirement Standard

FCC 15.203

11.1.2 Requirement Description

According to section 15.203, an intentional radiator shall be designed to ensure that no antenna other than that furnished by the responsible party shall be used with the device.

11.2 Antenna Construction

The Antenna is an Integral Antenna, with gain of 0 dBi. No consideration of replacement.

Therefore, the equipment complies with the antenna requirement of Section 15.203