

**VOD1023  
DVD PLAYER  
WITH  
DROP-DOWN  
VIDEO  
MONITOR**



**Operation  
Manual**



128-7255

128-7255

1 of 35

## Important Notice

An LCD panel and/or video monitor may be installed in a motor vehicle and visible to the driver if the LCD panel or video monitor is used for vehicle information, system control, rear or side observation or navigation. If the LCD panel or video monitor is used for television reception, video or DVD play, the LCD panel or video monitor must be installed so that these features will only function when the vehicle is in "park" or when the vehicle's parking brake is applied.

An LCD panel or video monitor used for television reception, video or DVD play that operates when the vehicle is in gear or when the parking brake is not applied must be installed to the rear of the driver's seat where it will not be visible, directly or indirectly, to the operator of the motor vehicle.

## Warnings

Do not use any solvents or cleaning materials when cleaning the video monitor.

Do not use any abrasive cleaners, they may scratch the screen. Use only a lightly dampened lint free cloth to wipe the screen if it is dirty.

Lock the LCD screen in the fully closed position when not in use.

Before putting on headphones always adjust the volume setting to the lowest position.

Remember to leave the dome light switch in the off or auto positions when the vehicle is unattended, as the dome lights, if left on, can drain the vehicle's battery.

Do not put pressure on the screen.

Caution children to avoid touching or scratching the screen, as it may become dirty or damaged.

## Television Reception

This entertainment system is designed primarily for viewing prerecorded movies or playing video games. Television reception in a moving vehicle will be limited and in some areas will not be possible due to weak and variable signal strength. Television viewing in a stationary vehicle will result in an improvement, but may still be marginal due to signal strength. The quality of the picture will not be consistent with home TV reception. Reception may be affected by weather and distance from TV station. A weak signal may cause the picture to roll, be snowy, or cause some color loss.

Licensed under one or more of the following patents,

Patent NOS. 5,775,762 and 5,927,784

Congratulations on your purchase of the Audiovox VOD1023 DVD Player with Drop-Down Video /Monitor. The VOD1023 has been designed to give you and your family many years of video entertainment in the mobile environment. Please read the directions that follow to familiarize yourself with the product and to ensure that you obtain the best results from your equipment. **Please note:** Installation options vary, see the individual owner's manuals for each component in your system to obtain a full understanding of each component's operation.

### Safety Precaution

For safety reasons, when changing video media it is recommended that the vehicle is not in motion, and that you do not allow children to unfasten seat-belts to change video media or make any adjustments to the system. System adjustments can be accomplished using the remote control, while seat-belts remain fastened. Enjoy your Audiovox entertainment system but remember the safety of all passengers remains the number one priority.

### Features

- 10.2 Inch TFT (Thin Film Transistor) Active Matrix LCD (Liquid Crystal Display) Monitor
- OSD (On Screen Display) for Control of Picture Quality and Functions
- Optional TV Tuner\*
- Full Function Remote Control
- Infrared Transmitter for IR Wireless Headphones.
- Two Audio / Video Inputs (AV1/AUX)
- Built-in DVD Player
- Two Headphone Jacks
- Built-in Five Frequency Wireless FM Modulator (\*\*Optional Relay Box)
- AV Line Out
- Forward and Side Remote Sensor
- Dome Lights with 3-Position Switch
- Backlit Controls for Low Light Operation
- Last Position Memory for DVD

#### Options

\* Audiovox P/N PODTVT

\*\* Audiovox P/N SIRSWB

-3-

128-7255  
3 of 35

## Controls and Indicators Diagram

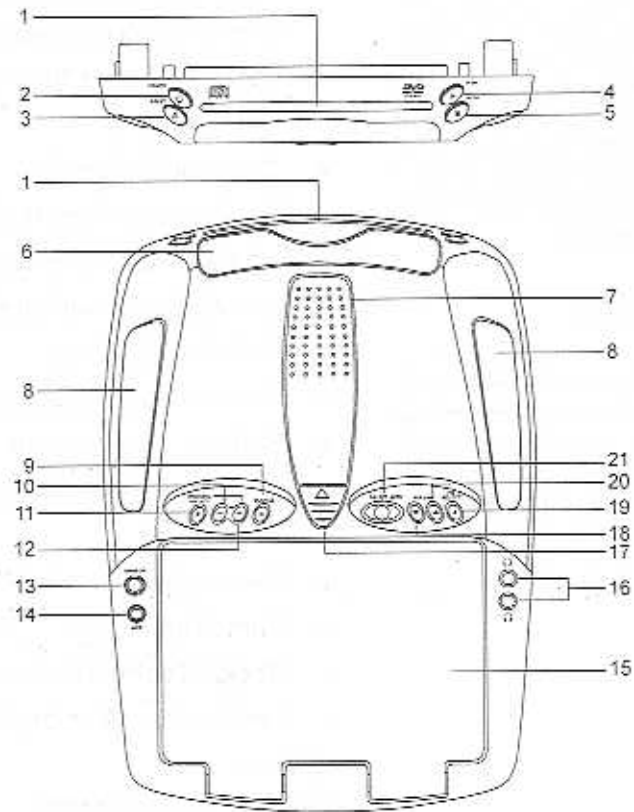

## Control Function Descriptions

1. **DVD Disc insertion slot** – For loading Disc.
2. **POWER Button** – Used to turn the system ON/OFF. Bright red when system is on, dim when off.
3. **EJECT ( ▲ ) Button** – For ejecting discs from the disc compartment.
4. **PLAY ( ► ) Button** – This button is used to start playback of a disc.
5. **STOP ( ■ ) Button** – To stop playback.
6. **Infrared Transmitter and Sensor** – Use to transmit audio to the wireless headphones. Also allows the remote control to operate the VOD1023 and to control other accessories in the system.
7. **VOD1023 Ventilation Opening.**
8. **Dome Lights** – Provide additional interior illumination.
9. **SOURCE Select** – Used to select one of the three sources (DVD, AV1, AUX, \*TV Optional).
10. **( – ) Button** – Used to decrease levels in the picture adjustment mode.
11. **PICTURE SELECT Button** – Allows the user enter the picture adjustment mode.
12. **( + ) Button** – Used to increase levels in the picture adjust mode.
13. **Side Remote Sensor Eye** – Allows the remote control to operate the VOD1023, control volume to wired headphone jacks and control the other accessories.
14. **AUX Input**
  - Auxiliary Audio Right Input.
  - Auxiliary Audio Left Input.
  - Auxiliary Video Input.
15. **Drop Down LCD Panel.**
16. **Headphone Jacks** – Allow the use of wired headphones with a 1/8" plug for listening to the video program audio.
17. **Screen release** – Moves in direction of the arrow to release the drop down screen.
18. **VOLUME ( ▲ ) Button** – Use this button to raise the volume level of the headphone jacks.

\* Consult the PODTVT Installation/Owner's Manual for optional TV tuner instructions.

19. **FM Select Button** – When this button is pressed it will turn on the wireless FM Modulator and then cycle through FM frequencies (Channel 1, 88.3MHz; Channel 2, 88.7MHz; Channel 3, 89.1MHz; Channel 4, 89.5MHz; Channel 5, 89.9MHz and OFF).

20. **VOLUME (▼) Button** – Use this button to decrease the volume level of the headphone jacks.

*Note: These buttons will not affect the volume of wireless headphones or the wireless FM modulator. When using these devices the volume must be adjusted with the wireless headphone volume control or with your radio's volume control (see page 16, Wireless Headphones, or page 17, Wireless FM Modulator).*

#### 21. **Three position Dome Light Switch**

- Auto – Automatically switches on the dome lights in conjunction with the vehicle's interior illumination.
- Off – The dome lights will not turn on in this position.
- On – Turns on the dome lights.

*Note : Audiovox recommends the use of the Audiovox HP275 Headphones when using wired headphones.*

## Remote Control Operation

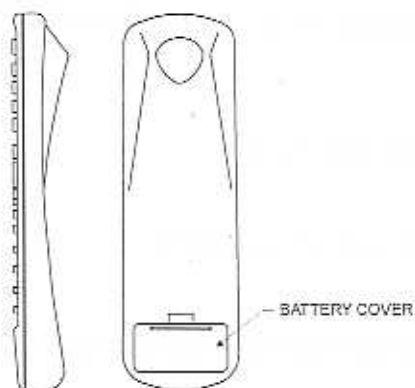

### Battery Installation

Before attempting to operate your Remote Control, install the batteries as described below.

- 1) Turn the Remote Control face down. Using a fingernail, lift the battery cover off.
- 2) Install two "AAA" batteries as shown. Make sure that proper polarity (+ or -) is observed.
- 3) Align the cover tabs with the remote control and press down until the cover clicks.

The remote control will operate the VOD1023 and most Audiovox VCP's. It is not a universal remote control and will not control equipment from other manufacturers.

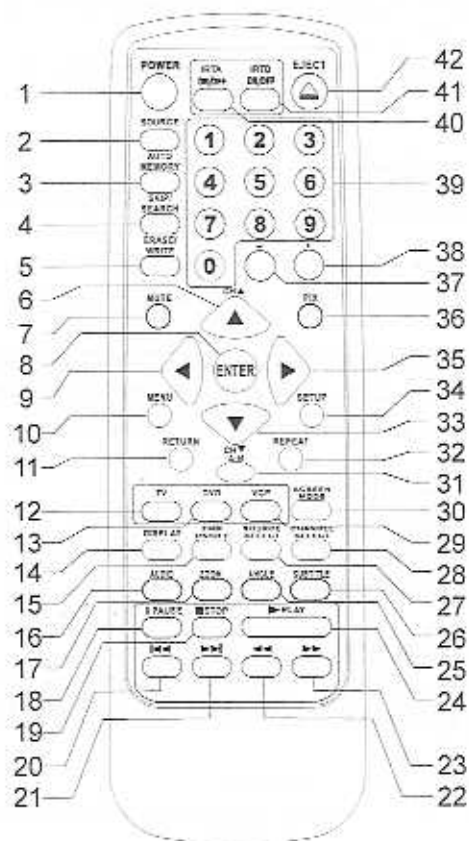

## Remote Control Function Descriptions

\*Function control is available on the unit and the remote control.

\*\* Not used in this model

\*\*\* The TV Option will only be displayed and the TV control functions are only available if the optional TV Tuner (P/N PODTVT) is installed.

- 1. POWER Button\***  
Press this button to turn the VOD1023 on. Press the button again to turn the VOD1023 off.
- 2. SOURCE Button\***  
Each time the button is pressed, the audio / video source will change: DVD, AV1, AUX and TV\*\*\*.
- 3. AUTO MEMORY Button (AUTO PROGRAM Button)\*\*\***  
When the AUTO MEMORY button is pressed, all channels are searched and channels that are detected with signals of sufficient levels are automatically stored.
- 4. SKIP/SEARCH Button\*\*\***  
This button selects between SKIP and SEARCH mode. In "SKIP mode" the TV tuner will tune and stop on channels that are programmed into memory when CHANNEL UP/DOWN buttons are used. When the SKIP mode is disabled, the TV will stop on all active channels.
- 5. ERASE/WRITE Button\*\*\***  
While tuned to a channel, pressing this button will store or erase the channel from memory. The stored channel numbers are displayed in "GREEN" and the erased channel numbers are displayed in "RED".
- 6. Channel Up (▲) Button**  
Use this button to increase the channel number\*\*\* to the desired channel and to scroll upward in menu options.



**7. MUTE Button**

Press this button to mute the audio.  
Pressing the button again restores the sound to the previously set level.

**8. ENTER Button**

Used to implement a selected setting or menu option.

**9. LEFT ( ◀ ) Button**

Allows the user to shift left in the menu options.

**10. MENU Button**

Allows the user to access the DVD (DVD MODE) main menu and monitor menu (TV MODE).

**11. RETURN Button\*\***

**12. TV Mode Select Button\*\*\***

Switches certain function keys on the remote control for TV functions.

**13. DVD Mode Select button**

Switches certain function keys on the remote control for DVD functions.

#### 14. DISPLAY Button

Press to display DVD Disc current information.

Press DISPLAY button	DVD Player Perform
Once	Display current TITLE , CHAPTER & elapsed time
Twice	Display current SUBTITLE
3 times	Display current AUDIO language & channel
4 times	Display current surround mode
5 times	Display current ANGLE
6 times	Display A-B current status
7 times	Display REPEAT current status
8 times	Display off

*For Subtitle, Audio, Surround, Angle, A - B & Repeat, press Enter key repeatedly to change the options. These options may vary from disc to disc.*

#### 15. FM TRANSMITTER ON/OFF Button

Turns FM Modulator power on/off.

#### 16. AUDIO Button

Press this button to display and select the desired AUDIO language. Each time the button is pressed, the language or track changes. **NOTE: The languages & tracks you can select are vary from disc to disc.**

**17. ZOOM Button** – Press this button to zoom the picture

Press ZOOM button	OSD	DVD Player Perform
Once	2X	ZOOM picture 2 times
Twice	3X	ZOOM picture 3 times
3 times	4X	ZOOM picture 4 times
4 times	1/2	Reduces picture to 1/2 normal size
5 times	1/3	Reduces picture to 1/3 normal size
6 times	1/4	Reduces picture to 1/4 normal size
7 times	OFF	Returns to normal size

**18. PAUSE ( || ) Button**

Allows the user to pause the playback.

**19. STOP ( ■ ) Button\***

Disc playback will be stopped.

**20. PREVIOUS ( ◀◀ ) Button**

Allows the user to return to the previous chapter or track.

**21. NEXT ( ▶▶ ) Button**

Allows the user to skip to the next chapter or track.

**22. REV ( ◀◀ ) Button**

Allows the user to search in a backward direction at 2, 4, 8, 16 and 32 times the normal speed.

**23. FWD (▶▶) Button**

Allows the user to search in a forward direction at 2,4,8, 16 and 32 times the normal speed.

**24. PLAY (▶)Button\***

Press this button to activate the play mode when a disc is loaded into the disc compartment.

**25. ANGLE Button**

Press this button to display and select the available camera angles. Each time the button is pressed, the angle will change.

*NOTE: The number of angles vary from disc to disc.*

**26. SUBTITLE Button**

Press this button to display and select the available subtitle language in DVD. Each time the button is pressed, the subtitle language changes. *NOTE: The type & number of languages for subtitles vary from disc to disc.*

**27. SOURCE SELECT Button\*\***

With FM ON, used to select the Audio source to the FM Modulator, POD audio or SAT Audio (Second IR input).

With FM OFF, used to select from SAT Audio or Car Audio.

**28. CHANNEL SELECT Button\* (FM Select)**

Selects the FM modulator Frequency (Frequency 1, 88.3MHz, Frequency 2, 88.7MHz, Frequency 3, 89.1MHz, Frequency 4, 89.5MHz, Frequency 5, 89.9MHz).

**29. VCP Mode Select button**

Switches certain function keys on the remote control for VCP functions.

**30. Screen Mode Button**

Allows the user to change screen format ( Aspect Ratio, 4:3 or 16:9 )

**31. A-B Button**

Allows the user to repeat playback of a DVD or CD from point A to point B.

**32. REPEAT Button**

Allows the user to repeat a chapter, title, track, or all of a DVD, CD or MP3.

**33. Channel Down (▼) Button**

Use this button to decrease the channel number\*\*\* to the desired channel and to scroll downward in the menu options.

**34. SETUP Button**

Allows the user to access the DVD setup menu and select various playback options (Display, OSD Language, Defaults, Parental Control, Password, Exit Setup).

**35. RIGHT (►) Button**

Allows the user to shift to the right in the menu options.

**36. PIX Button (PICTURE SELECT)**

Each time this button is pressed, the OSD will display the "adjustment bars" for BRIGHTNESS, CONTRAST, COLOR or TINT. Once the desired adjustment bar is displayed, use the VOLUME UP/DOWN buttons to adjust the setting. The display will automatically turn off if no adjustments are made within 6 seconds, or if any other button is depressed.

**37. VOLUME DOWN (-) Button\***

Use this button to decrease the volume level of the wired headphone jacks. It is also used to make picture adjustments in picture select mode.

**38. VOLUME UP (+) Button\***

Use this button to raise the volume level of the wired headphone jacks. It is also used to make picture adjustments in picture select mode.

*Note: The volume buttons will not affect the volume of wireless headphones or the wireless FM Modulator. When using these devices the volume must be adjusted with the wireless headphone volume control or with your radio's volume control (see page 16, Headphones, or page 17, Wireless FM Modulator).*

**39. NUMBER Buttons**

Allows the user to enter numbers 0 to 9 for selection of CD tracks, DVD chapters, and password setting.

**40. IRTA ON/OFF Buttons**

Turn Infrared Transmitter power ON/OFF for IR Wireless Headphone Channel A.

**41. IRTB ON/OFF Buttons\*\***

Turn Infrared Transmitter power ON/OFF for IR Wireless Headphone Channel B.

**42. EJECT (■) Button\***

The disc will be ejected from the disc compartment.

## Turning the VOD1023 On or Off

1. Sliding the screen release lock forward will unlock the LCD screen and it will drop down slightly. Pivot the screen downward until a comfortable viewing angle is reached. The internal hinge friction will hold the screen in position while the system is in use.
2. Pressing the power button on the unit or the remote control will turn the system on or off alternately. When in use the internal backlighting will illuminate the controls.
3. After the unit has been turned on load a disc into the disc slot (label side up). Adjust the viewing angle by pivoting the screen to optimize the picture quality.
4. Remember to turn the unit off and pivot the LCD to the locked position when not in use.

## Overhead Dome Lights

The lights integrated into the VOD1023 are controlled by a three position slide switch. Sliding the switch to the on position will turn the lights on. The off position will prevent the lights from turning on at all times, and the auto position will allow the lights to turn on and off with the vehicle's interior lighting. Refer to the Installation Manual for the wire connections. Do not leave the vehicle unattended with the dome light switch in the on position, as this could result in a discharged battery.

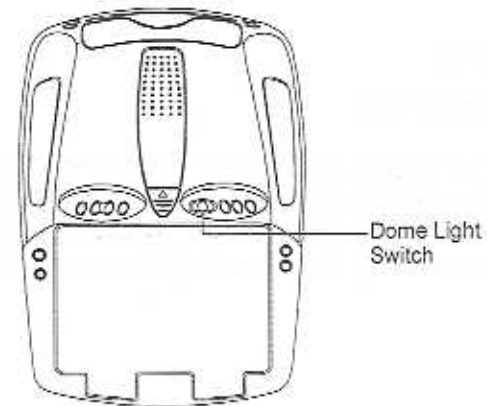

## Remote Sensor

The VOD1023 incorporates two Infrared sensors which relay signals from the remote control to allow the unit to be controlled simply by pointing its remote control at the remote sensor eye. The repeater function allows control of auxiliary equipment such as an Audiovox Video Cassette Player. The infrared sensor can relay signals from most manufacturer's remote controls to its respective component connected to the AV 1 input. In this case you must use the remote control supplied with the component.

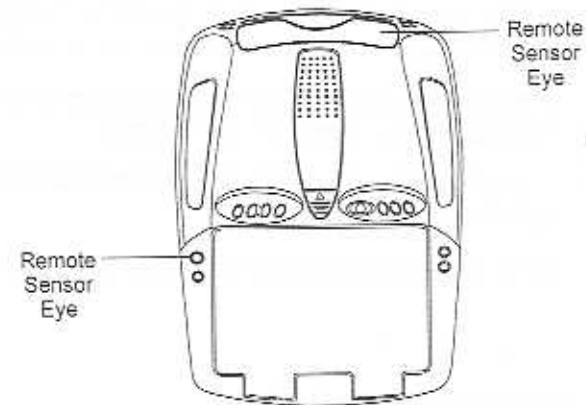

## Accessories

### Wireless Headphones

The VOD1023 includes a built-in infrared transmitter for use with Audiovox wireless headphones (Part Number MVIRHS). The volume can then be adjusted using the controls on each headset. Any number of wireless headphones may be used but they must be used within a line of sight from the transmitter, as infrared transmissions, like visible light travel only in a straight line. See the documentation accompanying your Audiovox wireless headphones.



### **Wired Headphones**

There are two 1/8" headphone jacks on the VOD1023 that can be used with any standard wired stereo headphones. These jacks are controlled by the volume up / down buttons on the VOD1023 or the remote control.

### **Wireless FM Modulator**

The VOD1023 is equipped with built-in wireless FM Modulator\*, that allows you to listen to the VOD1023 audio signal by tuning your vehicle's radio to the selected frequency, (88.3, 88.7, 89.1, 89.5, 89.9MHz). This feature is accessed by using either the FM transmitter buttons on the remote (On/Off, Channel Select) or the FM Select button on the unit.

### **AV1 Input**

The AV1 video input may be connected to a Video cassette Player (VCP), video game system, or other audio / video devices. To access the AV1 input, turn the VOD1023 on and press the source button on the VOD1023 or the Source button on the remote control until "AV1" is displayed on the screen. Turn the video source component on with its power button or remote control. The VOD1023 is now ready to play the audio and video signals from the source connected to AV1 input. The AV1 input requires a 8010730 cable.

**\*NOTE:** In certain areas where there are a large number of FM radio stations (e.g. large cities, urban areas), the reception of the FM signal from the overhead pod may not be satisfactory, resulting in static, distorted sound or signal bleed thru from strong local radio stations. This is not a defect in the product, but the result of a stronger local radio station overpowering the wireless FM transmitter in your overhead pod.

If wireless reception is unsatisfactory, an optional wired relay box (Audiovox P/N SIRS WB) can be installed which will improve audio quality. Please contact the installer if this is the case with your product.

### **AUX A/V Input**

The VOD1023 will accept an audio/video input through the RCA jacks located on the side of the unit. The audio / video device could be a video game system, video camera, or other input device.

### **Audio/Video Out**

The VOD1023 provides an AV output for an optional video monitor(s). (Refer to page 6 of the Installation Guide for more details.) This output will provide an A/V signal that duplicates the signal processed by the VOD1023 to an additional monitor or video display. The audio signal can also be used to feed an AUX input on a vehicle radio if available. Please see your installer for more information.

### **DVD Basics**

To get the optimum use out of the DVD player, make sure you read this section completely.

### **Regional Coding**

Both the DVD player and disc are coded by region. These regional codes must match in order for the disc to play. If the codes don't match, the disc won't play. This unit's code is region 1. Other regional codes cannot be played in this unit. The unit will display "WRONG REGION."

### Types of Discs your DVD will play

- DVD discs – DVDs discs which contain video.
- Audio discs – Audio CDs that contain music or sound content only.
- MP3 discs – A disc that contains audio files (for example, a CD-R/CD-RW with downloaded MP3 files).

### Loading and Playing Discs

Before you load a disc, make sure that it is compatible with the player.

**Note: the following Discs CANNOT be used with this player :**

- *MiniDisc*
- *Laserdisc*
- *CD-I, CD-ROM, DVD-ROM*

### To load and Play a Disc

When you press the Power button the unit will turn on and display the source selected. Select DVD mode and insert the disc (Label Up) into the disc compartment. When the disc is half way in it will be automatically pulled in and play will begin.

### Last Memory

The player is able to resume playback from the last position if any power interruption happens, provided the disc is not removed from the player.

Note : This function is only available on DVD's and Audio CD's.

## Settings and Adjustments

The Setup Menu contains features and options that let you customize your DVD player. For example, you can set a language for the on-screen display, limit playback for children, load default settings for the picture quality etc.

### Using the Setup Menu

1. Press the SETUP button on the remote. The Setup Menu appears on the screen as shown in the diagram to the right. There are 5 icons on the top part of the Setup Menu. Each icon represents a page.



Main Page



Audio Setup



Password Setup



Preference Setup



Exit Setup

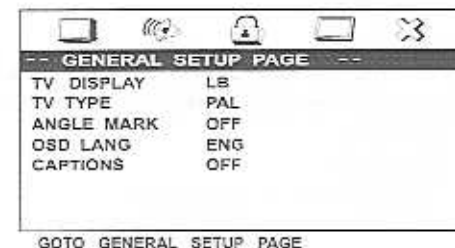

2. In order to Go to the desired page, move the highlight using the cursor button ◀ or ▶ to the desired icon and press enter.
3. After entering the desired page, highlight the desired item using the ▲ or ▼ cursor button and press enter.
4. Press ▲ or ▼ to select the desired options, and then press ENTER to confirm the selection.
5. Repeat steps 3-4 to continue setting the items in the same Setup Page.
6. To change to another Setup page, press ◀ until the highlight moves back to the icon on the top part of the Setup Menu. Then, repeat steps 2-5.

### Exiting the Setup Menu

Press the SETUP button again or Move the highlight to "X" icon and then press ENTER.

## MAIN PAGE

### TV DISPLAY

The TV DISPLAY setup allows you to adjust screen aspect ratio.

#### 4:3 PS

This displays a wide picture on the screen with a portion of the left & right side removed.

#### 4:3 LB

This displays a wide picture with black bands on the upper and lower portions of the screen.

#### 16:9

This displays a wide picture with black bands on the upper and lower portion of the screen. The bands will vary, depending on what aspect ratio the disc is.

Note : This setting can only be made when the player is in the Stop mode or when there is no disc in the player.

### TV TYPE

The TV TYPE setup allows you to select the system to fit to the color system of the TV to be connected.

PAL - Select this type for PAL TV

MULTI - Select this type for multi-system TV

NTSC - Select this type for NTSC TV

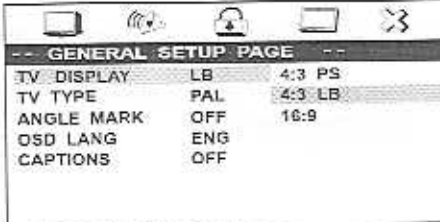

The screenshot shows the 'GENERAL SETUP PAGE' with a navigation bar at the top containing icons for TV, audio, lock, and other settings. The main menu lists several options: TV DISPLAY (LB), TV TYPE (PAL), ANGLE MARK (OFF), OSD LANG (ENG), and CAPTIONS (OFF). The 'TV DISPLAY' option is highlighted, and its sub-menu is shown to the right, listing '4:3 PS' and '4:3 LB'.

-- GENERAL SETUP PAGE --		
TV DISPLAY	LB	4:3 PS
TV TYPE	PAL	4:3 LB
ANGLE MARK	OFF	16:9
OSD LANG	ENG	
CAPTIONS	OFF	

SET TV DISPLAY MODE

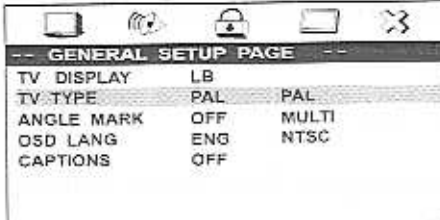

The screenshot shows the 'GENERAL SETUP PAGE' with a navigation bar at the top. The main menu lists several options: TV DISPLAY (LB), TV TYPE (PAL), ANGLE MARK (OFF), OSD LANG (ENG), and CAPTIONS (OFF). The 'TV TYPE' option is highlighted, and its sub-menu is shown to the right, listing 'PAL' and 'MULTI'.

-- GENERAL SETUP PAGE --		
TV DISPLAY	LB	
TV TYPE	PAL	PAL
ANGLE MARK	OFF	MULTI
OSD LANG	ENG	NTSC
CAPTIONS	OFF	

SET TV STANDARD

### ANGLE MARK

The ANGLE MARK setup allows you to turn on/off the angle mark display on the screen.

- ON - The screen shows angle mark if an angle option is available on a DVD
- OFF - There is no angle mark display on the screen even though there is an angle option available on a DVD.

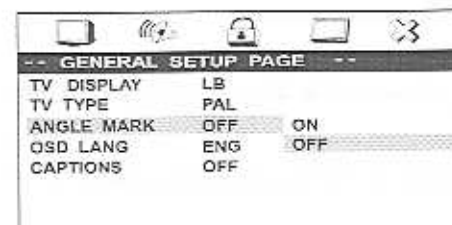

SET ANGLE MARK

### OSD LANG (Language for On-Screen Display)

The OSD LANGUAGE setup allows you to select the language for the on-screen display. The user can either select English, French, German, Spanish or Italian for the OSD language.

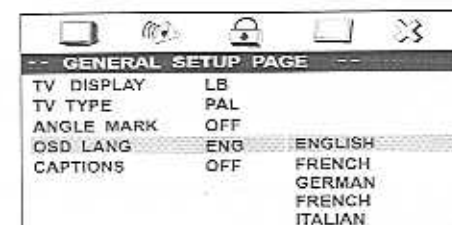

SET OSD LANGUAGE

### CAPTIONS (Closed Caption)

The CAPTIONS setup allows you to turn on and off the closed caption signal to be passed to the television through the video output for decoding.

- ON - To turn on the closed caption signal to be passed to the television for decoding
- OFF - To turn off the closed caption signal to be passed to the television for decoding

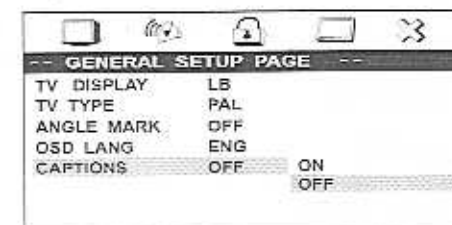

CAPTION

## AUDIO SETUP PAGE

### EQ TYPE

The equalizer allows you to choose from a variety of preset equalizer settings.

The options are : *OFF, ROCK, POP, LIVE, DANCE, TECHNO, CLASSIC and SOFT.*

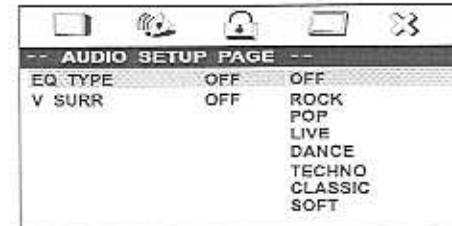

CAPTION

### V SURR (Virtual Surround)

The Virtual Surround allows you to add a surround sound effect to the audio.

ON - Turn on the virtual surround sound  
OFF - Turn off the virtual surround sound

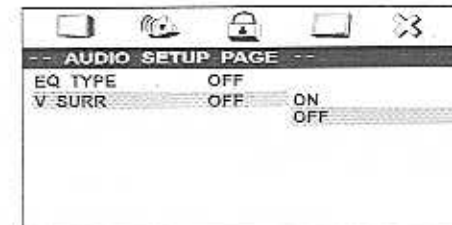

V SURR

## PASSWORD SETUP PAGE

### PASSWORD CHANGE

This item allows you to change the password.

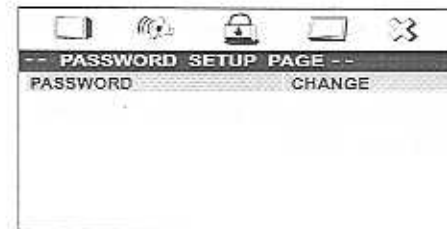

CHANGE PASSWORD

After you have selected the password change, the figure below is shown:

#### OLD PASSWORD

Input the old password or the default password ( 4 digits )

#### NEW PASSWORD

Input a new password ( 4 digits ) using the numbers buttons (0~9)

#### CONFIRM PWD

Confirm the new password by entering the same password again.  
Then press ENTER to apply the changes.



**NOTE:** The Default Password is **3308**. This password is always effective even after you have selected your own password and changed it. To avoid the possibility of others using the default password to set the parental level and change the password, you can record this default password in another area and delete it from this manual. Some discs can be limited depending on the age of users while some discs cannot.



## PREFERENCE PAGE

The setting in this page can only be made when the player is in the Stop mode or when there is no disc in the player.

### **PARENTAL CONTROL**

This item allows you to limit movie playback from G to Adult. The lower the value, the more strict the control.

G  
PG  
PG - 13  
R  
NC - 17  
ADULT

After the desired rating is selected the password must be entered to confirm the setting.

### **DEFAULT - RESET**

The DEFAULT - RESET allows you to reset all options to factory settings.  
Note : This function will not affect the parental control settings.

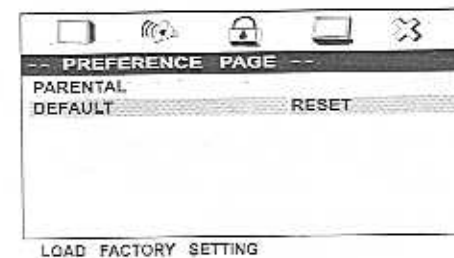
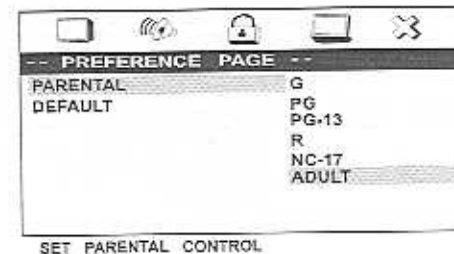

## Playing DVDs

Press the DISPLAY button on the remote control to display the status banner. Pressing the DISPLAY button consecutively changes the options as below.

Press DISPLAY button	Information display on the screen
Once	Current title, chapter and elapsed time
Twice	Current subtitle information
3 times	Current audio language and audio channel
4 times	Current surround sound setting
5 times	Current angle setting
6 times	Current A-B setting
7 times	Current repeat status
8 times	Display off

### Selecting a Chapter

You can skip to a specific chapter by using the numbers keys.  
For example, if you want to skip to chapter 2, press '02'.

For subtitle, audio, surround, angle, A-B, and repeat, press the Enter button repeatedly to change the options. These options may vary from disc to disc.

### Using the Repeat Feature

The default mode for the Repeat feature is OFF. Pressing REPEAT consecutively changes the repeat options:

- CHAPTER - repeat the chapter that is playing
- TITLE - repeat the title that is playing
- ALL - repeat the entire disc

Note : Repeat Off mode has no OSD display.

## Playing Audio CDs

When playing an audio CD, the DISPLAY banner appears automatically. It displays the current track playing, the total number of tracks and the elapsed time for the track playing. Pressing the DISPLAY button on the remote consecutively changes the options of the display.

Press DISPLAY x 1	SINGLE ELAPSED appears along with the current track playing, the total number of tracks and the time playing on that track
Press DISPLAY x 2	SINGLE REMAIN appears along with the current track playing, the total number of tracks and the amount of time left of that track.
Press DISPLAY x 3	TOTAL ELAPSED appears along with the current track playing and the total time the CD has been playing.
Press DISPLAY x 4	TOTAL REMAIN appears along with the current track playing, the total number of tracks and the amount of time left on the CD.
Press DISPLAY x 5	Turn off the DISPLAY banner.

### Selecting a Track

You can skip to a specific track by using the numbers keys. For example, if you want to skip to track 7, press "07"

### Using the REPEAT feature

The default mode for Repeat feature is OFF. Pressing REPEAT consecutively changes the repeat options:

- TRACK - repeat the track that is playing
- ALL - repeat the entire disc that is playing

As you toggle through the options, the repeat option changes at that time. The track, for example, repeats once that track has ended. The selected repeat option loops repeatedly until you turn it off.

Note : Repeat Off mode has no OSD display.

### Selecting a Play Mode

In CD playback, the play mode can be changed by pressing ZOOM. Pressing ZOOM consecutively changes the play mode options:

- RANDOM - play the songs in random order
- SHUFFLE - play the songs in random order
- PROGRAM - play the songs on the disc in the order you have programmed. (See page 28)
- Normal (no OSD is displayed)

## Program Play

You can play the tracks on a disc in the desired order using the PROGRAM function.

1. Press ZOOM until the PROGRAM table is displayed on the screen as shown in diagram to the right.

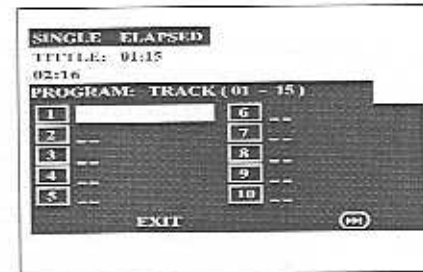

2. Input the desired tracks using numbers buttons ( 0~9 ) on the remote as shown in diagram. If you want to program more than 10 songs, you can highlight ►► and press ENTER to go to the next page.

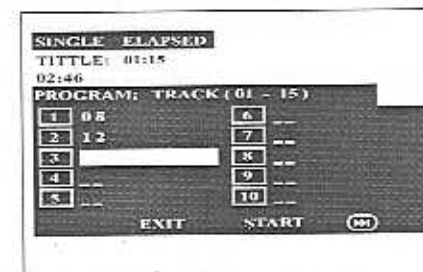

3. After creating the programmed list, move the highlight to **START**, and then press ENTER to start playback of the programmed songs.

When the playback of the programmed songs has finished, the DVD player stops and the program list is deleted. To repeat playing the program list, use the Repeat feature during the program playback.

### Deleting a programmed list

To delete the programmed list, press STOP while the programmed list is being played or change to another play mode using the ZOOM button.

## Playing MP3 Discs

MP3 is a format for storing digital audio. An audio CD-quality song can be compressed into the MP3 format with very little loss of quality, while taking up much less space. CD-R/CD-RW discs that have been encoded in MP3 format can be played on your DVD player. The DVD player plays the songs in the order they were burned on to the disc.

Press the DISPLAY button on the remote to display the current play mode and to change the time display between time elapsed and time remain.

- Time elapsed is the time that the song has been playing.
- Time remaining is the amount of time left for the song being played.

## Selecting Folders and Songs

When an MP3 is loaded in the player, the navigation menu appears automatically.

1. Press ▲ or ▼ to move the highlight to the desired folder and press ENTER to display the songs in the folder.

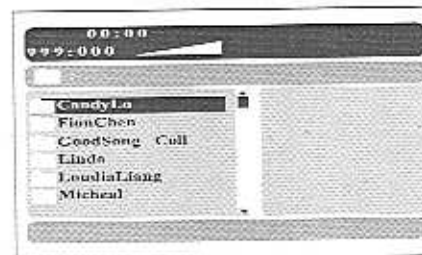

2. Press ▲ or ▼ to move the highlight to the desired song and press ENTER to begin playback of the highlighted song.

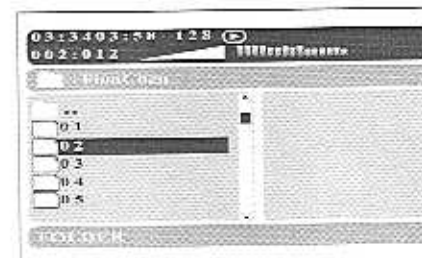

### Skipping Songs

Use the Next (▶▶) button on the remote control to move to the next song. Use the Previous (◀◀) button to move to the previous song.

### Selecting a Play Mode

You can choose what order the songs will play on a disc temporarily. The default play mode is FOLDER. Press REPEAT consecutively to choose the desired play mode. The play mode options are :

- FOLDER                Plays the songs in a folder in the order they were recorded.
- SHUFFLE              Plays the songs in a folder in random order.
- RANDOM              Plays the songs in a folder in random order.
- SINGLE                Plays a selected song.
- REPEAT ONE         Repeat the song that is playing.
- REPEAT FOLDER     Repeat the folder that is playing.

## Troubleshooting

<u>PROBLEM</u>	<u>SOLUTION</u>
Poor in vehicle radio reception	<ul style="list-style-type: none"> <li>• Check the condition of the vehicle's radio antenna.</li> <li>• Verify that the antenna is fully raised.</li> <li>• If a relay box (SIRSWB) has been insatalled, make sure that the FM Modulator is turned OFF.</li> <li>• If a wired RF modulator has been installed, verify that it is turned OFF by using the remote or switch.</li> </ul>
IR sensor inoperative	<ul style="list-style-type: none"> <li>• Verify that the batteries in the remote are fresh.</li> <li>• Verify that the remote sensor eye is not obstructed.</li> <li>• Verify that the infrared transmitter is affixed over the sensor eye of the component to be controlled.</li> </ul>
Disc won't play	<ul style="list-style-type: none"> <li>• Insert a disc with the label side facing up.</li> <li>• Check the type of disc you put into disc tray. This DVD player only plays DVD's, audio CDs and MP3s.</li> <li>• Both the unit and the disc are coded by region. If the regional codes don't match, the disc can't be played. This DVD player is Region Number 1.</li> </ul>

<u>PROBLEM</u>	<u>SOLUTION</u>
Play starts, but then stops immediately	<ul style="list-style-type: none"> <li>• The disc is dirty. Clean it.</li> <li>• Condensation has formed. Allow player to dry out.</li> </ul>
No sound or distorted sound	<ul style="list-style-type: none"> <li>• Make sure your DVD player is connected properly. Make sure all cables are securely inserted into the appropriate jacks.</li> <li>• If you are using the IR headphones, make sure you turn on the IR power.</li> <li>• Make sure the FM Modulator is ON and the proper Frequency has been selected.</li> </ul>
Can't advance through a movie	<ul style="list-style-type: none"> <li>• You can't advance through the opening credits and warning information that appears at the beginning of movies because the disc is programmed to prohibit that action.</li> </ul>

<u>PROBLEM</u>	<u>SOLUTION</u>
The icon (⏮) appears on screen	The feature or action cannot be completed at this time because: <ol style="list-style-type: none"> <li>1. The disc's software restricts it.</li> <li>2. The disc's software doesn't support the feature (e.g., angles)</li> <li>3. The feature is not available at the moment.</li> <li>4. You've requested a title or chapter number that is out of range.</li> </ol>
Picture is distorted	<ul style="list-style-type: none"> <li>• The disc might be damaged. Try another disc.</li> <li>• It is normal for some distortion to appear during forward or reverse scan.</li> </ul>
No forward or reverse scan	<ul style="list-style-type: none"> <li>• Some discs have sections that prohibit rapid scanning or title and chapter skip.</li> <li>• If you try to skip through the warning information and credits at the beginning of a movie, you won't be able to. This part of the movie is often programmed to prohibit skipping through it.</li> </ul>



Replacement Parts		Specifications	
Remote Control	1363855	LCD Backlighting	Edge Light Tube
		Resolution	2400 x 480
		Pixels	1152,000
		Operation Temperature	32 -140° F (0 - 60° C)
		Storage Temperature	-4 - 176° F (-20 - 80° C)
		Backlight life	30,000 Hours
		Video Display System	NTSC/PAL
		Headphone Audio Output	0.03W @ 32 ohms
		Video Output	1.0Vp-p @ 75 ohms
		Power Source	12V DC



## 12 MONTH LIMITED WARRANTY

*Applies to Audiovox Mobile Video Products*

AUDIOVOX ELECTRONICS CORP. (the Company) warrants to the original retail purchaser of this product that should this product or any part thereof, under normal use and conditions, be proven defective in material or workmanship within 12 months from the date of original purchase, such defect(s) will be repaired or replaced with reconditioned product (at the Company's option) without charge for parts and repair labor.

To obtain repair or replacement within the terms of this Warranty, the product is to be delivered with proof of warranty coverage (e.g. dated bill of sale), specification of defect(s), transportation prepaid, to the Company at the address shown below.

This Warranty does not extend to the elimination of externally generated static or noise, to correction of antenna problems, to costs incurred for installation, removal or reinstallation of the product, or to damage to tapes, discs, speakers, accessories, or vehicle electrical systems.

This Warranty does not apply to any product or part thereof which, in the opinion of the Company, has suffered or been damaged through alteration, improper installation, mishandling, misuse, neglect, accident, or by removal or defacement of the factory serial number/bar code label(s). THE EXTENT OF THE COMPANY'S LIABILITY UNDER THIS WARRANTY IS LIMITED TO THE REPAIR OR REPLACEMENT PROVIDED ABOVE AND, IN NO EVENT, SHALL THE COMPANY'S LIABILITY EXCEED THE PURCHASE PRICE PAID BY PURCHASER FOR THE PRODUCT.

This Warranty is in lieu of all other express warranties or liabilities. ANY IMPLIED WARRANTIES, INCLUDING ANY IMPLIED WARRANTY OF MERCHANTABILITY, SHALL BE LIMITED TO THE DURATION OF THIS WRITTEN WARRANTY. ANY ACTION FOR BREACH OF ANY WARRANTY HEREUNDER INCLUDING ANY IMPLIED WARRANTY OF MERCHANTABILITY MUST BE BROUGHT WITHIN A PERIOD OF 24 MONTHS FROM DATE OF ORIGINAL PURCHASE. IN NO CASE SHALL THE COMPANY BE LIABLE FOR ANY CONSEQUENTIAL OR INCIDENTAL DAMAGES FOR BREACH OF THIS OR ANY OTHER WARRANTY, EXPRESS OR IMPLIED, WHATSOEVER. No person or representative is authorized to assume for the Company any liability other than expressed herein in connection with the sale of this product.

Some states do not allow limitations on how long an implied warranty lasts or the exclusion or limitation of incidental or consequential damage so the above limitations or exclusions may not apply to you. This Warranty gives you specific legal rights and you may also have other rights which vary from state to state.

U.S.A. : AUDIOVOX ELECTRONICS CORPORATION, 150 MARCUS BLVD., HAUPPAUGE, NEW YORK 11788 • 1-800-645-4994

CANADA : CALL 1-800-645-4994 FOR LOCATION OF WARRANTY STATION SERVING YOUR AREA

Notice: The changes or modifications not expressly approved by the party responsible for compliance could void the user's authority to operate the equipment.

**IMPORTANT NOTE:** To comply with the FCC RF exposure compliance requirements, no change to the antenna or the device is permitted. Any change to the antenna or the device could result in the device exceeding the RF exposure requirements and void user's authority to operate the device.

