

FCC CERTIFICATION TEST REPORT

FOR

Applicant	:	Action Electronics Co.,Ltd.
Address	:	2480, TINGKAT PERUSAHAAN ENAM, PRAI FREE TRADE ZONE, 13600, PERAI, PENANG, MALAYSIA
Equipment under Test	:	10.1 LCD Monitor with DVD player
Model No.	:	ODM91012, AMVXMTG10, VXMTG10
Trade Mark	:	ADVENT, AUDIOVOX, ROSEN, INVISION, ACTION
FCC ID	:	ATI9R3ODM91012
Manufacturer	:	Action Electronics Co.,Ltd.
Address	:	2480, TINGKAT PERUSAHAAN ENAM, PRAI FREE TRADE ZONE, 13600, PERAI, PENANG, MALAYSIA

Issued By: Dongguan Dongdian Testing Service Co., Ltd.

Add: No. 17, Zongbu Road 2, Songshan Lake Sci&Tech, Industry Park,
Dongguan City, Guangdong Province, China, 523808

Tel: +86-0769-38826678, **E-mail:** ddt@dgddt.com, <http://www.dgddt.com>

TABLE OF CONTENTS

	Test report declares.....	3
1.	Summary of test results	5
2.	General test information.....	6
2.1.	Description of EUT	6
2.2.	Accessories of EUT.....	6
2.3.	Assistant equipment used for test.....	6
2.4.	Block diagram of EUT configuration for test.....	6
2.5.	Deviations of test standard.....	7
2.6.	Test environment conditions	7
2.7.	Test laboratory.....	7
2.8.	Measurement uncertainty.....	8
3.	Equipment used during test	9
4.	Radiated emission.....	10
4.1.	Block diagram of test setup.....	10
4.2.	Limit.....	11
4.3.	Test Procedure	12
4.4.	Test result.....	14
5.	20dB Bandwidth	21
5.1.	Block diagram of test setup.....	21
5.2.	Limits	21
5.3.	Test Procedure	21
5.4.	Test Result	21
5.5.	Original test data	22
6.	Power Line Conducted Emission	24
6.1.	Block diagram of test setup.....	24
6.2.	Power Line Conducted Emission Limits (Class B)	24
6.3.	Test Procedure	24
6.4.	Test Result	25
7.	Antenna Requirements	26
8.	Test setup photograph	27
9.	Photos of the EUT	28

TEST REPORT DECLARE

Applicant	:	Action Electronics Co.,Ltd.
Address	:	2480, TINGKAT PERUSAHAAN ENAM, PRAI FREE TRADE ZONE, 13600, PERAI, PENANG, MALAYSIA
Equipment under Test	:	10.1 LCD Monitor with DVD player
Model No.	:	ODM91012, AMVXMTG10, VXMTG10
Trade Mark	:	ADVENT, AUDIOVOX, ROSEN, INVISION, ACTION
Manufacturer	:	Action Electronics Co.,Ltd.
Address	:	2480, TINGKAT PERUSAHAAN ENAM, PRAI FREE TRADE ZONE, 13600, PERAI, PENANG, MALAYSIA

Test Standard Used:

FCC Rules and Regulations Part 15 Subpart C section 15.239.

Test procedure used:

ANSI C63.10:2013, ANSI C63.4:2014.

We Declare:

The equipment described above is tested by Dongguan Dongdian Testing Service Co., Ltd. and in the configuration tested the equipment complied with the standards specified above. The test results are contained in this test report and Dongguan Dongdian Testing Service Co., Ltd. is assumed of full responsibility for the accuracy and completeness of these tests.

After test and evaluation, our opinion is that the equipment provided for test compliance with the requirement of the above FCC standards.

Report No:	DDT-R20031901-5E2		
Date of Receipt:	Mar. 24, 2020	Date of Test:	Mar. 24, 2020 ~ Apr. 26, 2020

Prepared By:

Sam Li

Sam Li/Engineer

Approved By:



Damon Hu/EMC Manager

Note: This report applies to above tested sample only. This report shall not be reproduced in parts without written approval of Dongguan Dongdian Testing Service Co., Ltd.

Revision history

Rev.	Revisions	Issue Date	Revised By
---	Initial issue	Apr. 26, 2020	

1. Summary of test results

Description of Test Item	Standard	Results
Field Strength of the Fundamental Signal	FCC Part 15: 15.239(b) ANSI C63.10:2013 ANSI C63.4:2014	PASS
20dB Bandwidth	FCC Part 15: 15.239(a) ANSI C63.10:2013 ANSI C63.4:2014	PASS
Radiated Emission	FCC Part 15: 15.209 FCC Part 15: 15.239(c) ANSI C63.10:2013 ANSI C63.4:2014	PASS
Power Line Conducted Emissions	FCC Part 15: 15.207 ANSI C63.10:2013 ANSI C63.4:2014	N/A
Antenna requirement	FCC Part 15: 15.203 ANSI C63.10:2014	PASS

Note: N/A is an abbreviation for Not Applicable, and means this item is not applicable for this device.

2. General test information

2.1. Description of EUT

EUT* Name	: 10.1 LCD Monitor with DVD player
Model Number	: ODM91012, AMVXMTG10, VXMTG10
Difference of model number	: All models are identical in circuitry and electrical, mechanical and physical construction; the only differences are the appearance color, shape, material and model no. for trading purpose. Therefore the test performed on the model ODM91012.
EUT function description	: Please reference user manual of this device
Power supply	: DC 12V
Operation frequency	: 88.1MHz-107.9MHz
Modulation	: FM
Channel Separation	: 200kHz
Antenna Type	: Dedicated line antenna
Sample Type	: Series production

Note: EUT is the ab. of equipment under test.

2.2. Accessories of EUT

Description of Accessories	Manufacturer	Model number	Serial No.	Other
/	/	/	/	/

2.3. Assistant equipment used for test

Assistant equipment	Manufacturer	Model number	Serial No.	Other
/	/	/	/	/

2.4. Block diagram of EUT configuration for test



The test software was used to control EUT work in Continuous Tx mode, and select test channel, wireless mode.

In section 15.31(m), regards to the operating frequency range over 10 MHz, the Lowest frequency, the middle frequency, and the highest frequency of channel were selected to perform the test, and the selected channel see below:

Channel	Frequency
The Lowest channel	88.1MHz
The Middle channel	98.1MHz
The Highest channel	107.9MHz

FM channel as below table:

Operation Frequency each of Channel							
Channel	Frequency	Channel	Frequency	Channel	Frequency	Channel	Frequency
1	88.1MHz	26	93.1MHz	51	98.1MHz	76	103.1MHz
2	88.3MHz	27	93.3MHz	52	98.3MHz	77	103.3MHz
3	88.5MHz	28	93.5MHz	53	98.5MHz	78	103.5MHz
4	88.7MHz	29	93.7MHz	54	98.7MHz	79	103.7MHz
5	88.9MHz	30	93.9MHz	55	98.9MHz	80	103.9MHz
6	89.1MHz	31	94.1MHz	56	99.1MHz	81	104.1MHz
7	89.3MHz	32	94.3MHz	57	99.3MHz	82	104.3MHz
8	89.5MHz	33	94.5MHz	58	99.5MHz	83	104.5MHz
9	89.7MHz	34	94.7MHz	59	99.7MHz	84	104.7MHz
10	89.9MHz	35	94.9MHz	60	99.9MHz	85	104.9MHz
11	90.1MHz	36	95.1MHz	61	100.1MHz	86	105.1MHz
12	90.3MHz	37	95.3MHz	62	100.3MHz	87	105.3MHz
13	90.5MHz	38	95.5MHz	63	100.5MHz	88	105.5MHz
14	90.7MHz	39	95.7MHz	64	100.7MHz	89	105.7MHz
15	90.9MHz	40	95.9MHz	65	100.9MHz	90	105.9MHz
16	91.1MHz	41	96.1MHz	66	101.1MHz	91	106.1MHz
17	91.3MHz	42	96.3MHz	67	101.3MHz	92	106.3MHz
18	91.5MHz	43	96.5MHz	68	101.5MHz	93	106.5MHz
19	91.7MHz	44	96.7MHz	69	101.7MHz	94	106.7MHz
20	91.9MHz	45	96.9MHz	70	101.9MHz	95	106.9MHz
21	92.1MHz	46	97.1MHz	71	102.1MHz	96	107.1MHz
22	92.3MHz	47	97.3MHz	72	102.3MHz	97	107.3MHz
23	92.5MHz	48	97.5MHz	73	102.5MHz	98	107.5MHz
24	92.7MHz	49	97.7MHz	74	102.7MHz	99	107.7MHz
25	92.9MHz	50	97.9MHz	75	102.9MHz	100	107.9MHz

2.5. Deviations of test standard

No Deviation.

2.6. Test environment conditions

During the measurement the environmental conditions were within the listed ranges:

Temperature range:	21-25°C
Humidity range:	40-75%
Pressure range:	86-106kPa

2.7. Test laboratory

Dongguan Dongdian Testing Service Co., Ltd

Add: No. 17, Zongbu Road 2, Songshan Lake Sci&Tech, Industry Park, Dongguan City,

Guangdong Province, China, 523808

Tel: +86-0769-38826678, <http://www.dgddt.com>, Email: ddt@dgddt.com

CNAS Accreditation No. L6451; A2LA Accreditation No. 3870.01

Designation Number: CN1182; Test Firm Registration Number: 540522

Industry Canada site registration number: 10288A-1

2.8. Measurement uncertainty

Test Item	Uncertainty
Bandwidth	1.1%
Peak Output Power (Conducted) (Spectrum analyzer)	0.86dB (10MHz ≤ f < 3.6GHz);
	1.38dB (3.6GHz ≤ f < 8GHz)
Peak Output Power (Conducted) (Power Sensor)	0.74dB
Dwell Time	0.6%
Conducted spurious emissions	0.86dB (10MHz ≤ f < 3.6GHz);
	1.40dB (3.6GHz ≤ f < 8GHz)
	1.66dB (8GHz ≤ f < 22GHz)
Uncertainty for radio frequency (RBW<20kHz)	3×10^{-8}
Temperature	0.4°C
Humidity	2%
Uncertainty for Radiation Emission test (30MHz-1GHz)	4.70dB (Antenna Polarize: V)
	4.84dB (Antenna Polarize: H)
Uncertainty for Radiation Emission test (1GHz-18GHz)	4.10dB (1-6GHz)
	4.40dB (6GHz-18GHz)
Uncertainty for Power line conduction emission test	3.32dB (150kHz-30MHz)
Note: This uncertainty represents an expanded uncertainty expressed at approximately the 95% confidence level using a coverage factor of k=2.	

3. Equipment used during test

Equipment	Manufacturer	Model No.	Serial No.	Last Cal.	Cal. Interval
RF Connected Test (Tonscend RF Measurement System)					
Spectrum analyzer	R&S	FSU26	200071	Sep. 29, 2019	1 Year
Wideband Radio Communication tester	R&S	CMW500	117491	Jun. 25, 2019	1 Year
Vector Signal Generator	Agilent	E8267D	US49060192	Sep. 29, 2019	1 Year
Vector Signal Generator	Agilent	N5182A	MY48180737	Jun. 25, 2019	1 Year
Power Sensor	Agilent	U2021XA	MY55150010	Jun. 28, 2019	1 Year
Power Sensor	Agilent	U2021XA	MY55150011	Jun. 28, 2019	1 Year
DC Power Source	MATRIS	MPS-3005L-3	D813058W	Jun. 25, 2019	1 Year
RF Cable	Micable	C10-01-01-1	100309	Sep. 29, 2019	1 Year
Temp&Humi Programmable	ZHIXIANG	ZXGDJS-150L	ZX170110-A	Oct. 21, 2019	1 Year
Test Software	JS Tonscend	JS1120-3	Ver.2.7	N/A	N/A
Radiation 2#chamber					
EMI Test Receiver	R&S	ESCI	101364	Sep. 29, 2019	1 Year
Spectrum analyzer	Agilent	E4447A	MY50180031	Jun. 25, 2019	1 Year
Trilog Broadband Antenna	Schwarzbeck	VULB 9163	9163-994	Nov. 15, 2019	1 Year
Active Loop antenna	Schwarzbeck	FMZB-1519	1519-038	Sep. 29, 2019	1 Year
Double Ridged Horn Antenna	Schwarzbeck	BBHA9120	02108	Jul. 21, 2019	1 Year
Broad Band Horn Antenna	Schwarzbeck	BBHA 9170	790	Sep. 29, 2019	1 Year
Pre-amplifier	TERA-MW	TRLA-0040 G35	101303	Sep. 29, 2019	1 Year
RF Cable	N/A	14+1.5m	06270619	Sep. 29, 2019	1 Year
Test software	Audix	E3	V 6.111111b	N/A	N/A

4. Radiated emission

4.1. Block diagram of test setup

In 3m Anechoic Chamber Test Setup Diagram for 9kHz-30MHz

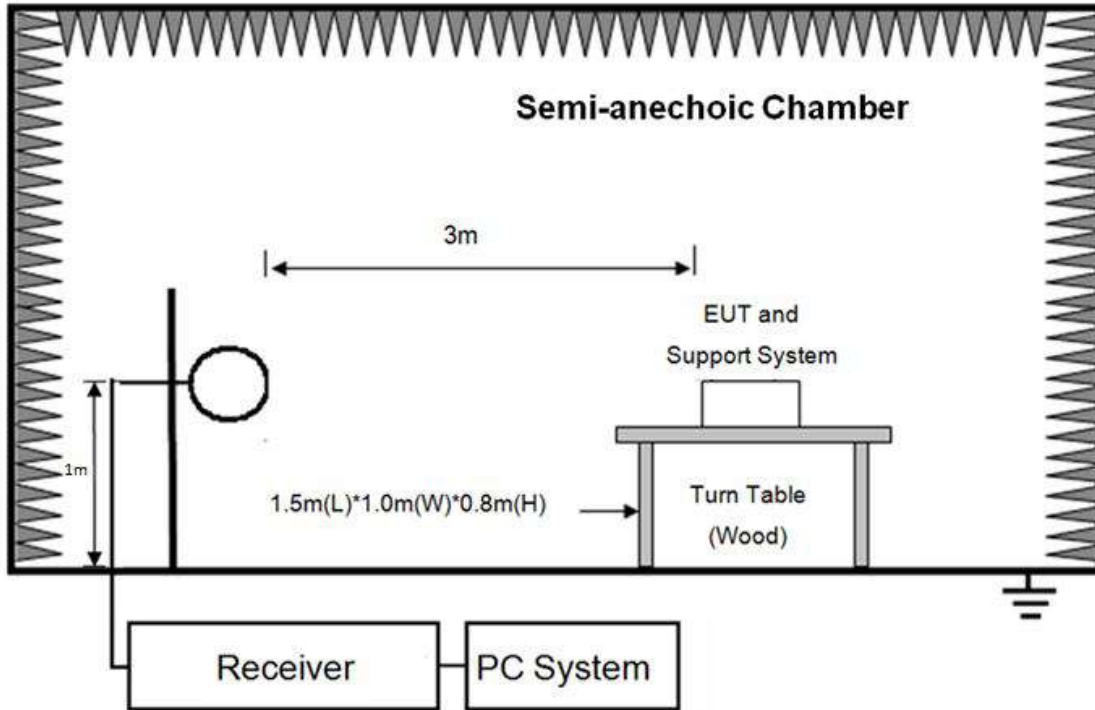

In 3m Anechoic Chamber Test Setup Diagram for below 1GHz

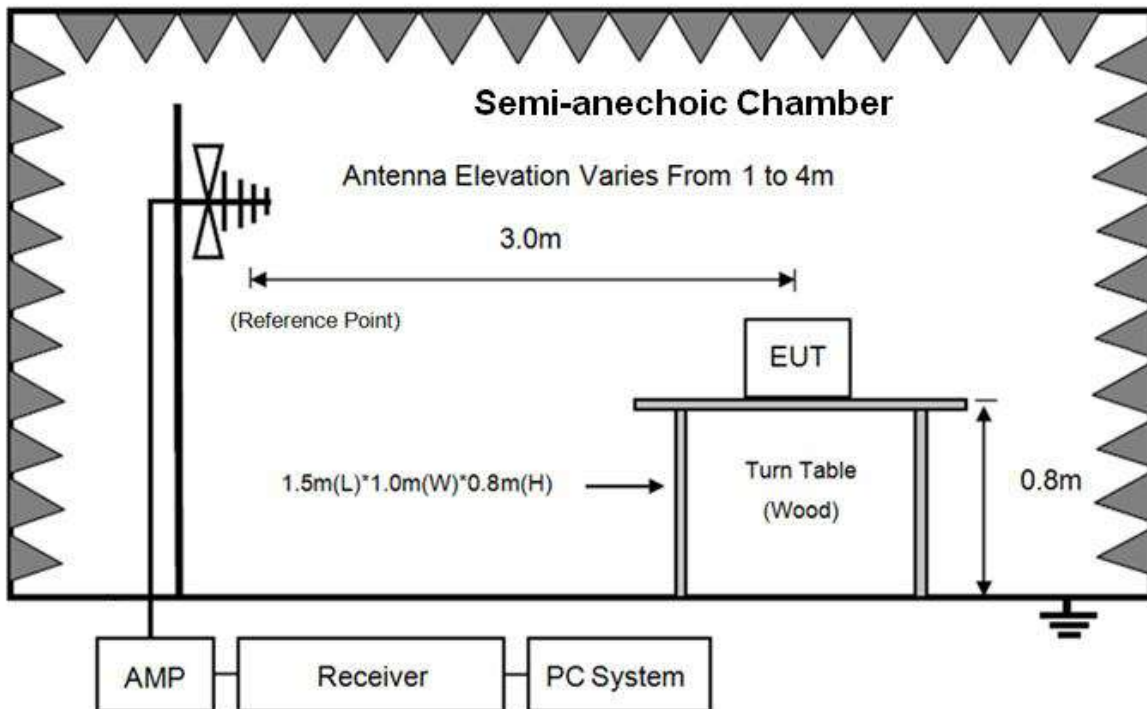

In 3m Anechoic Chamber Test Setup Diagram for frequency above 1GHz

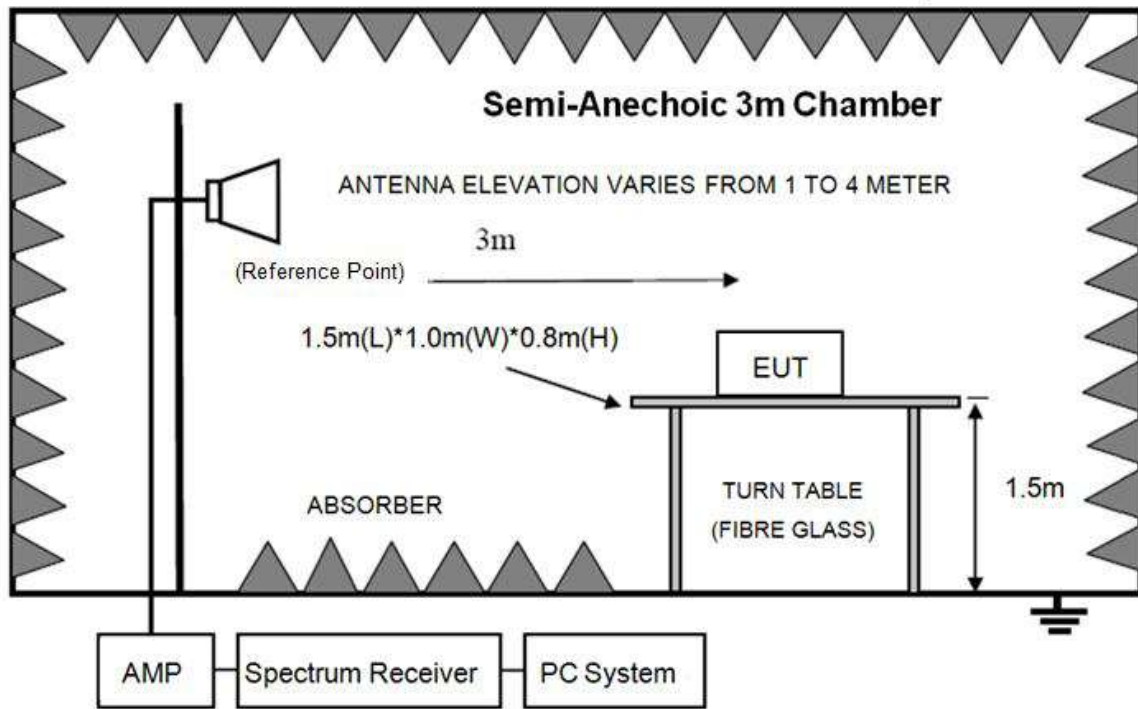

Note: For harmonic emissions test an appropriate high pass filter was inserted in the input port of AMP.

4.2. Limit

4.2.1 FCC 15.205 Restricted frequency band

MHz	MHz	MHz	GHz
0.090-0.110	16.42-16.423	399.9-410	4.5-5.15
¹ 0.495-0.505	16.69475-16.69525	608-614	5.35-5.46
2.1735-2.1905	16.80425-16.80475	960-1240	7.25-7.75
4.125-4.128	25.5-25.67	1300-1427	8.025-8.5
4.1772&4.1775	37.5-38.25	1435-1626.5	9.0-9.2
4.2072&4.2075	73-74.6	1645.5-1646.5	9.3-9.5
6.215-6.218	74.8-75.2	1660-1710	10.6-12.7
6.26775-6.26825	108-121.94	1718.8-1722.2	13.25-13.4
6.31175-6.31225	123-138	2200-2300	14.47-14.5
8.291-8.294	149.9-150.05	2310-2390	15.35-16.2
8.362-8.366	156.52475-156.52525	2483.5-2500	17.7-21.4
8.37625-8.38675	156.7-156.9	2690-2900	22.01-23.12
8.41425-8.41475	162.0125-167.17	3260-3267	23.6-24.0
12.29-12.293	167.72-173.2	3332-3339	31.2-31.8
12.51975-12.52025	240-285	3345.8-3358	36.43-36.5
12.57675-12.57725	322-335.4	3600-4400	(²)
13.36-13.41			

4.2.2 FCC 15.209 Limit.

FREQUENCY MHz	DISTANCE Meters	FIELD STRENGTHS LIMIT	
		$\mu\text{V}/\text{m}$	$\text{dB}(\mu\text{V})/\text{m}$
0.009 ~ 0.490	300	2400/F(kHz)	67.6-20log(F)
0.490 ~ 1.705	30	24000/F(kHz)	87.6-20log(F)
1.705 ~ 30.0	30	30	29.54
30 ~ 88	3	100	40.0
88 ~ 216	3	150	43.5
216 ~ 960	3	200	46.0
960 ~ 1000	3	500	54.0
Above 1000	3	74.0 $\text{dB}(\mu\text{V})/\text{m}$ (Peak) 54.0 $\text{dB}(\mu\text{V})/\text{m}$ (Average)	

4.2.3 FCC 15.239(b) Limit.

FREQUENCY MHz	DISTANCE Meters	FIELD STRENGTHS LIMIT	
		$\mu\text{V}/\text{m}$	$\text{dB}(\mu\text{V})/\text{m}$
88 ~ 108	3	250	48.0(Average)
			68.0(Peak)

Note: (1) The emission limits shown in the above table are based on measurements employing a CISPR QP detector except for the frequency bands 9-90kHz, 110-490kHz and above 1000MHz. Radiated emissions limits in these three bands are based on measurements employing an average detector.

(2) At frequencies below 30MHz, measurement may be performed at a distance closer than that specified, and the limit at closer measurement distance can be extrapolated by below formula:

$$\text{Limit}_{3\text{m}}(\text{dB}\mu\text{V}/\text{m}) = \text{Limit}_{30\text{m}}(\text{dB}\mu\text{V}/\text{m}) + 40\text{Log}(30\text{m}/3\text{m})$$

4.2.3 Limit for this EUT

All the emissions appearing within 15.205 restricted frequency bands shall not exceed the limits shown in 15.209 and 15.239, all the other emissions shall be at least 20dB below the fundamental emissions, or comply with 15.209 limits.

4.3. Test Procedure

(1) EUT was placed on a non-metallic table, 80 cm above the ground plane inside a semi-anechoic chamber.

(2) Test antenna was located 3m from the EUT on an adjustable mast, and the antenna used as below table.

Test frequency range	Test antenna used
9kHz-30MHz	Active Loop antenna
30MHz-1GHz	Trilog Broadband Antenna
1GHz-18GHz	Double Ridged Horn Antenna(1GHz-18GHz)
18GHz-40GHz	Horn Antenna(18GHz-40GHz)

According ANSI C63.10:2013 clause 6.4.4.2 and 6.5.3, for measurements below 30 MHz, the

loop antenna was positioned with its plane vertical from the EUT and rotated about its vertical axis for maximum response at each azimuth position around the EUT. And the loop antenna also be positioned with its plane horizontal at the specified distance from the EUT. The center of the loop is 1 m above the ground. For measurement above 30MHz, the Trilog Broadband Antenna or Horn Antenna was located 3m from EUT, Measurements were made with the antenna positioned in both the horizontal and vertical planes of Polarization, and the measurement antenna was varied from 1 m to 4 m. in height above the reference ground plane to obtain the maximum signal strength.

(3) Below pre-scan procedure was first performed in order to find prominent frequency spectrum radiated emissions from 9kHz to 1GHz:

(a) Scanning the peak frequency spectrum with the antenna specified in step (3), and the EUT was rotated 360 degree, the antenna height was varied from 1m to 4m (Except loop antenna, it's fixed 1m above ground.)

(b) Change work frequency or channel of device if practicable.

(c) Change modulation type of device if practicable.

(d) Change power supply range from 85% to 115% of the rated supply voltage

(e) Rotated EUT though three orthogonal axes to determine the attitude of EUT arrangement produces highest emissions.

Spectrum frequency from 9 kHz to 1GHz (tenth harmonic of fundamental frequency) was investigated, the EUT works the highest frequency in 107.9MHz under the FM transmitting mode, therefore the test is performed up to 1GHz, and there are no obvious emissions detected from 9 kHz to 30MHz, so below final test was performed with frequency range from 30MHz to 1GHz.

(4) For final emissions measurements at each frequency of interest, the EUT was rotated and the antenna height was varied between 1m and 4m in order to maximize the emission. Measurements in both horizontal and vertical polarities were made and the data was recorded. In order to find the maximum emission, the relative positions of equipments and all of the interface cables were changed according to ANSI C63.10:2013 on Radiated Emission test.

(5) The emissions from 9kHz to 1GHz were measured based on CISPR QP detector except for the frequency bands 9-90kHz, 110-490kHz, for emissions from 9kHz-90kHz,110kHz-490kHz and above 1GHz were measured based on average detector, for emissions above 1GHz, peak emissions also be measured and need comply with Peak limit.

(6) The emissions from 9 kHz to 1GHz, QP or average values were measured with EMI receiver with below RBW.

Frequency band	RBW
9kHz-150kHz	200Hz
150kHz-30MHz	9kHz
30MHz-1GHz	120kHz

4.4. Test result

PASS. (See below detailed test result)

4.4.1 Field Strength of the Fundamental Signal

Freq. (MHz)	Read level (dB μ V)	Antenna Factor (dB/m)	Cable Loss (dB)	PK Result Level (dB μ V/m)	AV Limit (dB μ V/m)	Over Limit (dB)	Polarization
88.1	19.50	10.57	4.32	34.39	48.00	-13.61	HORIZONTAL
88.1	27.97	10.57	4.32	42.86	48.00	-5.14	VERTICAL
98.1	18.31	11.72	4.40	34.43	48.00	-13.57	HORIZONTAL
98.1	26.61	11.72	4.40	42.73	48.00	-5.27	VERTICAL
107.9	18.25	11.42	4.47	34.14	48.00	-13.86	HORIZONTAL
107.9	27.62	11.42	4.47	43.51	48.00	-4.49	VERTICAL
Result: Pass							

Note: 1. Result Level = Read Level + Antenna Factor + Cable loss.

2. If Peak Result complies with AV limit, AV Result is deemed to comply with AV limit.

3. Test setup: RBW: 120 kHz, VBW: 300 kHz, Sweep time: auto.

4.4.2 Radiated Emissions

TR-4-E-009 Radiated Emission Test Result

Test Site : DDT 3m Chamber 1# D:\2020 RE 1# Report data\Q20031901-5E ODM91012\FCC BELOW1G.EM6
Test Date : 2020-04-06 **Tested By** : Jacky
EUT : 10.1 LCD Monitor with DVD player **Model Number** : ODM91012
Power Supply : DC 12V **Test Mode** : FM Tx mode
Condition : Temp:24.5°C,Humi:55%,Press:100.1kPa **Antenna/Distance** : 2019 VULB 9163 1#/3m/HORIZONTAL
Memo : 88.1

Data: 1

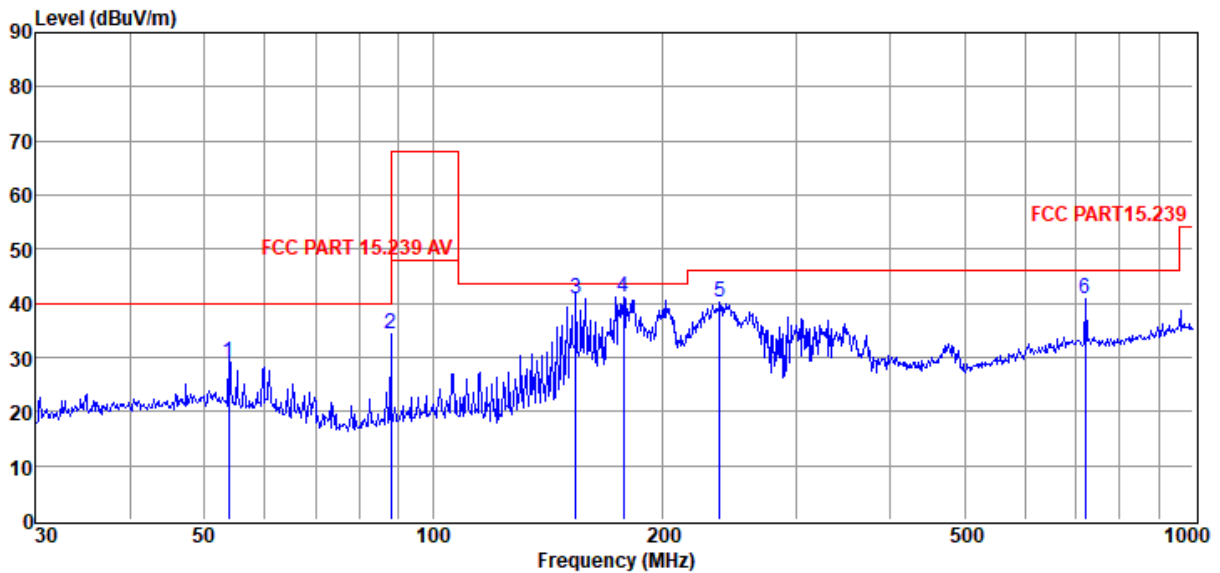

Item (Mark)	Freq. (MHz)	Read Level (dBμV)	Antenna Factor (dB/m)	Cable Loss (dB)	Result Level (dBμV/m)	Limit Line (dBμV/m)	Over Limit (dB)	Detector	Polarization
1	53.88	11.47	13.71	4.03	29.21	40.00	-10.79	QP	HORIZONTAL
2	88.10	19.50	10.57	4.32	34.39	/	/	Peak	HORIZONTAL
3	154.28	27.51	8.47	4.77	40.75	43.50	-2.75	QP	HORIZONTAL
4	178.13	26.68	9.69	4.91	41.28	43.50	-2.22	QP	HORIZONTAL
5	238.31	22.55	12.57	5.23	40.35	46.00	-5.65	QP	HORIZONTAL
6	721.73	13.73	20.08	7.14	40.95	46.00	-5.05	QP	HORIZONTAL

Note: 1. Result Level = Read Level + Antenna Factor + Cable loss.
 2. If Peak Result complies with QP limit, QP Result is deemed to comply with QP limit.
 3. Test setup: RBW: 120 kHz, VBW: 300 kHz, Sweep time: auto.

TR-4-E-009 Radiated Emission Test Result

Test Site : DDT 3m Chamber 1# D:\2020 RE 1# Report data\Q20031901-5E ODM91012\FCC BELOW1G.EM6
Test Date : 2020-04-06 **Tested By** : Jacky
EUT : 10.1 LCD Monitor with DVD player **Model Number** : ODM91012
Power Supply : DC 12V **Test Mode** : FM Tx mode
Condition : Temp:24.5°C,Humi:55%,Press:100.1kPa **Antenna/Distance** : 2019 VULB 9163 1#/3m/VERTICAL
Memo : 88.1

Data: 2

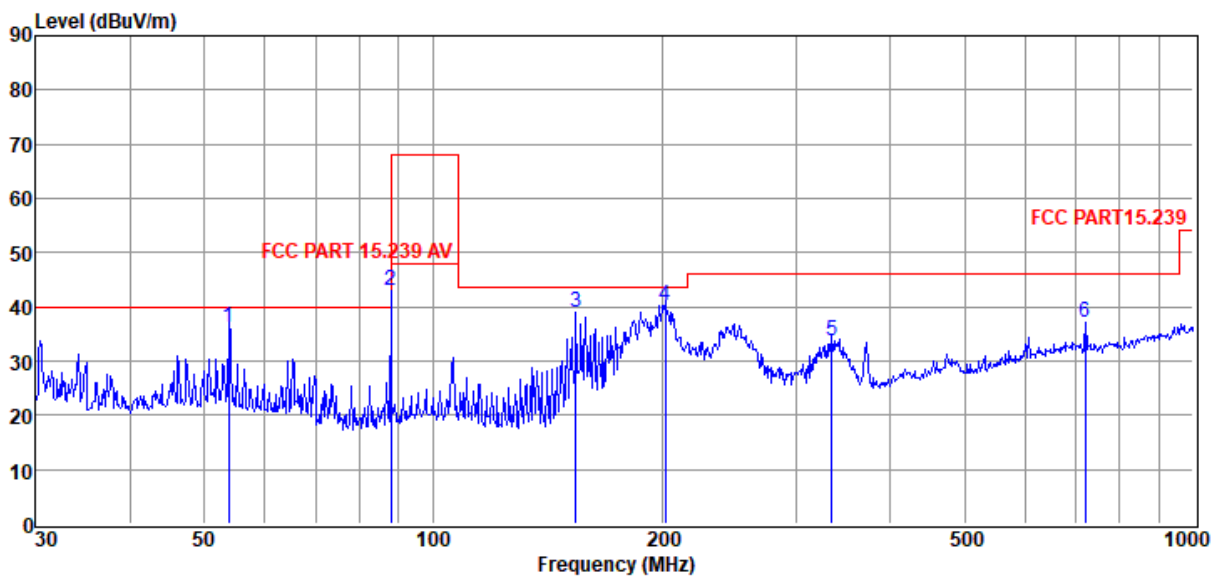

Item (Mark)	Freq. (MHz)	Read Level (dBμV)	Antenna Factor (dB/m)	Cable Loss (dB)	Result Level (dBμV/m)	Limit Line (dBμV/m)	Over Limit (dB)	Detector	Polarization
1	53.88	18.48	13.71	4.03	36.22	40.00	-3.78	QP	VERTICAL
2	88.10	27.97	10.57	4.32	42.86	/	/	Peak	VERTICAL
3	154.28	25.63	8.47	4.77	38.87	43.50	-4.63	QP	VERTICAL
4	202.10	23.72	11.47	5.04	40.23	43.50	-3.27	QP	VERTICAL
5	334.86	13.54	14.56	5.69	33.79	46.00	-12.21	QP	VERTICAL
6	721.73	9.76	20.08	7.14	36.98	46.00	-9.02	QP	VERTICAL

- Note: 1. Result Level = Read Level + Antenna Factor + Cable loss.
 2. If Peak Result complies with QP limit, QP Result is deemed to comply with QP limit.
 3. Test setup: RBW: 120 kHz, VBW: 300 kHz, Sweep time: auto.

TR-4-E-009 Radiated Emission Test Result

Test Site : DDT 3m Chamber 1#

D:\2020 RE 1# Report data\Q20031901-5E ODM91012\FCC BELOW1G.EM6

Test Date : 2020-04-06

Tested By : Jacky

EUT : 10.1 LCD Monitor with DVD player

Model Number : ODM91012

Power Supply : DC 12V

Test Mode : FM Tx mode

Condition : Temp:24.5°C,Humi:55%,Press:100.1kPa

Antenna/Distance : 2019 VULB 9163 1#/3m/VERTICAL

Memo : 98.1

Data: 3

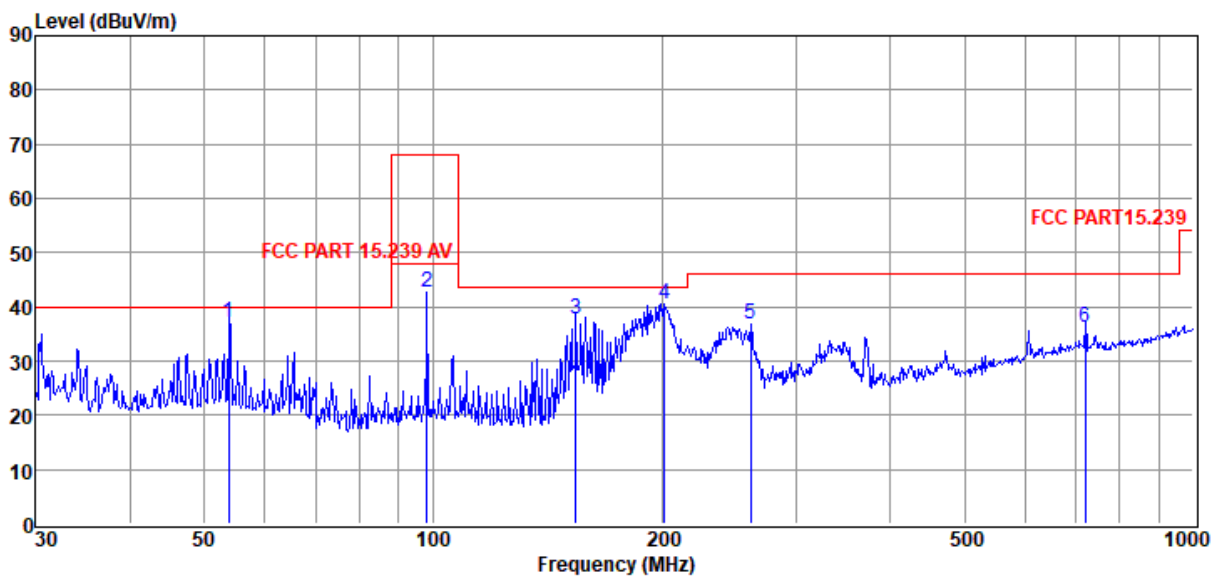

Item (Mark)	Freq. (MHz)	Read Level (dBμV)	Antenna Factor (dB/m)	Cable Loss (dB)	Result Level (dBμV/m)	Limit Line (dBμV/m)	Over Limit (dB)	Detector	Polarization
1	53.88	19.35	13.71	4.03	37.09	40.00	-2.91	QP	VERTICAL
2	98.10	26.61	11.72	4.40	42.73	/	/	Peak	VERTICAL
3	154.28	24.56	8.47	4.77	37.80	43.50	-5.70	QP	VERTICAL
4	201.39	24.07	11.45	5.04	40.56	43.50	-2.94	QP	VERTICAL
5	261.98	18.12	13.20	5.35	36.67	46.00	-9.33	QP	VERTICAL
6	721.73	8.83	20.08	7.14	36.05	46.00	-9.95	QP	VERTICAL

Note: 1. Result Level = Read Level + Antenna Factor + Cable loss.

2. If Peak Result complies with QP limit, QP Result is deemed to comply with QP limit.

3. Test setup: RBW: 120 kHz, VBW: 300 kHz, Sweep time: auto.

TR-4-E-009 Radiated Emission Test Result

Test Site : DDT 3m Chamber 1# D:\2020 RE 1# Report data\Q20031901-5E ODM91012\FCC BELOW1G.EM6
Test Date : 2020-04-06 **Tested By** : Jacky
EUT : 10.1 LCD Monitor with DVD player **Model Number** : ODM91012
Power Supply : DC 12V **Test Mode** : FM Tx mode
Condition : Temp:24.5°C,Humi:55%,Press:100.1kPa **Antenna/Distance** : 2019 VULB 9163 1#/3m/HORIZONTAL
Memo : 98.1

Data: 4

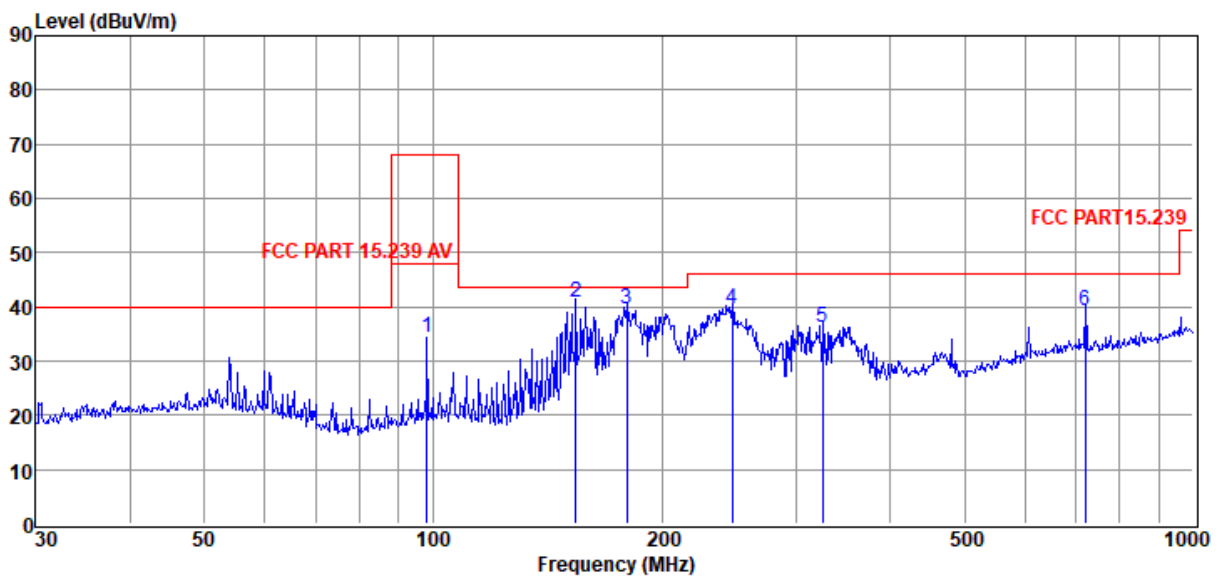

Item (Mark)	Freq. (MHz)	Read Level (dBμV)	Antenna Factor (dB/m)	Cable Loss (dB)	Result Level (dBμV/m)	Limit Line (dBμV/m)	Over Limit (dB)	Detector	Polarization
1	98.10	18.31	11.72	4.40	34.43	/	/	Peak	HORIZONTAL
2	154.28	27.50	8.47	4.77	40.74	43.50	-2.76	QP	HORIZONTAL
3	180.02	24.74	9.80	4.92	39.46	43.50	-4.04	QP	HORIZONTAL
4	247.68	21.35	12.82	5.28	39.45	46.00	-6.55	QP	HORIZONTAL
5	325.60	16.13	14.44	5.65	36.22	46.00	-9.78	QP	HORIZONTAL
6	721.73	12.11	20.08	7.14	39.33	46.00	-6.67	QP	HORIZONTAL

- Note: 1. Result Level = Read Level + Antenna Factor + Cable loss.
 2. If Peak Result complies with QP limit, QP Result is deemed to comply with QP limit.
 3. Test setup: RBW: 120 kHz, VBW: 300 kHz, Sweep time: auto.

TR-4-E-009 Radiated Emission Test Result

Test Site : DDT 3m Chamber 1# D:\2020 RE 1# Report data\Q20031901-5E ODM91012\FCC BELOW1G.EM6
Test Date : 2020-04-06 **Tested By** : Jacky
EUT : 10.1 LCD Monitor with DVD player **Model Number** : ODM91012
Power Supply : DC 12V **Test Mode** : FM Tx mode
Condition : Temp:24.5°C,Humi:55%,Press:100.1kPa **Antenna/Distance** : 2019 VULB 9163 1#/3m/VERTICAL
Memo : 107.9

Data: 5

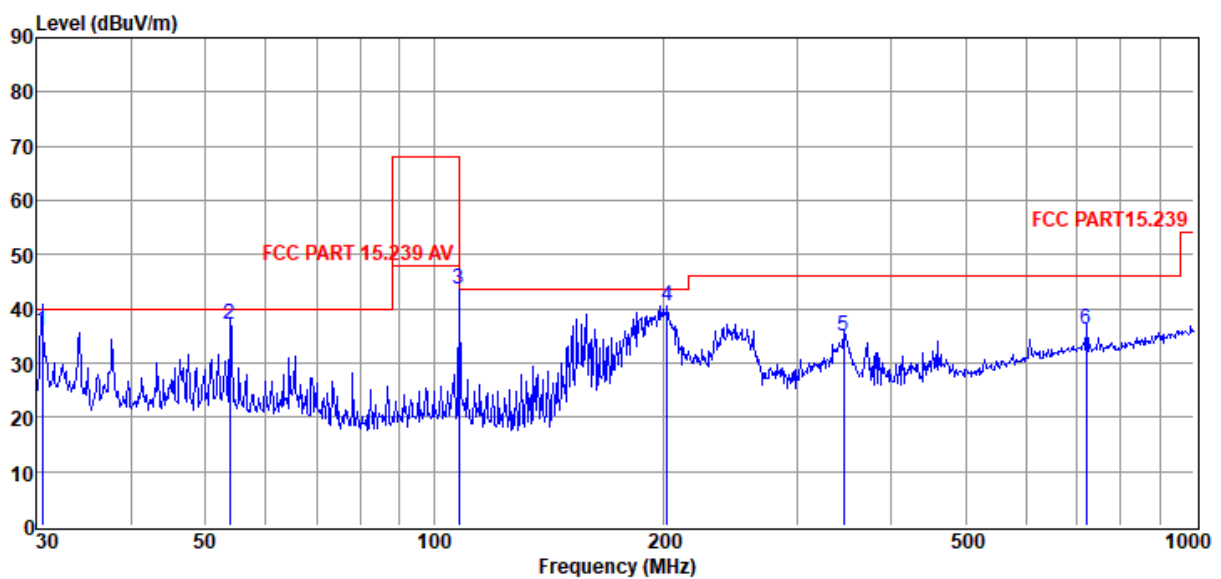

Item (Mark)	Freq. (MHz)	Read Level (dBμV)	Antenna Factor (dB/m)	Cable Loss (dB)	Result Level (dBμV/m)	Limit Line (dBμV/m)	Over Limit (dB)	Detector	Polarization
1	30.53	20.62	11.35	3.80	35.77	40.00	-4.23	QP	VERTICAL
2	53.88	19.36	13.71	4.03	37.10	40.00	-2.90	QP	VERTICAL
3	107.90	27.62	11.42	4.47	43.51	/	/	Peak	VERTICAL
4	202.81	24.03	11.49	5.05	40.57	43.50	-2.93	QP	VERTICAL
5	345.60	14.52	14.69	5.74	34.95	46.00	-11.05	QP	VERTICAL
6	721.73	8.99	20.08	7.14	36.21	46.00	-9.79	QP	VERTICAL

- Note: 1. Result Level = Read Level + Antenna Factor + Cable loss.
 2. If Peak Result complies with QP limit, QP Result is deemed to comply with QP limit.
 3. Test setup: RBW: 120 kHz, VBW: 300 kHz, Sweep time: auto.

TR-4-E-009 Radiated Emission Test Result

Test Site : DDT 3m Chamber 1# D:\2020 RE 1# Report data\Q20031901-5E ODM91012\FCC BELOW1G.EM6
Test Date : 2020-04-06 **Tested By** : Jacky
EUT : 10.1 LCD Monitor with DVD player **Model Number** : ODM91012
Power Supply : DC 12V **Test Mode** : FM Tx mode
Condition : Temp:24.5°C,Humi:55%,Press:100.1kPa **Antenna/Distance** : 2019 VULB 9163 1#/3m/HORIZONTAL
Memo : 107.9

Data: 6

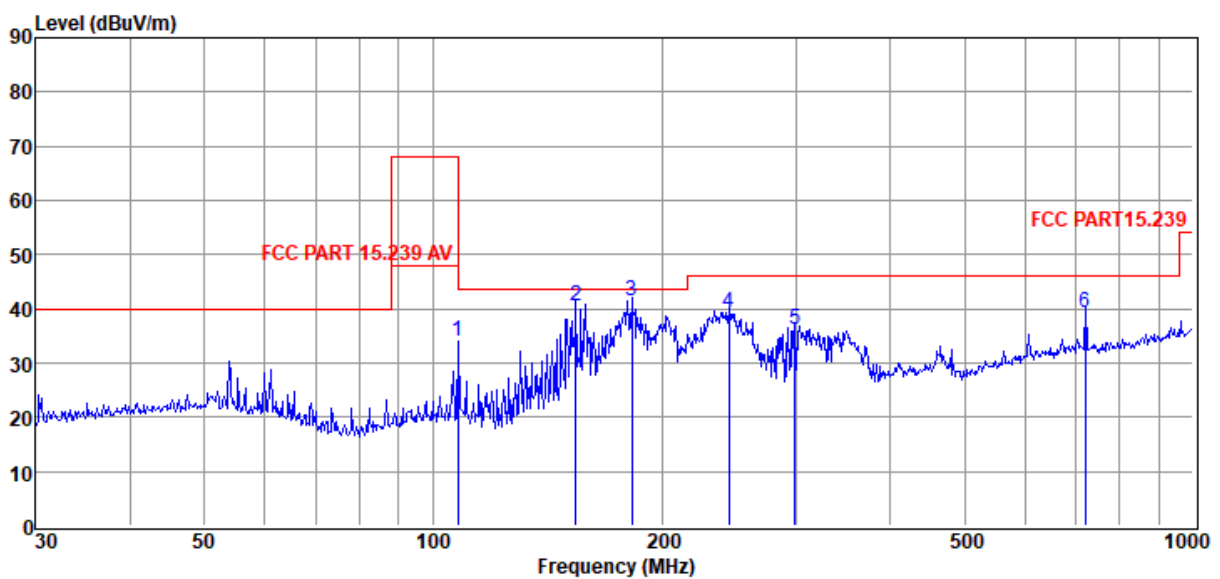

Item (Mark)	Freq. (MHz)	Read Level (dBμV)	Antenna Factor (dB/m)	Cable Loss (dB)	Result Level (dBμV/m)	Limit Line (dBμV/m)	Over Limit (dB)	Detector	Polarization
1	107.90	18.25	11.42	4.47	34.14	/	/	Peak	HORIZONTAL
2	154.28	27.28	8.47	4.77	40.52	43.50	-2.98	QP	HORIZONTAL
3	182.56	26.24	10.14	4.94	41.32	43.50	-2.18	QP	HORIZONTAL
4	245.09	21.23	12.75	5.27	39.25	46.00	-6.75	QP	HORIZONTAL
5	299.32	16.49	14.08	5.52	36.09	46.00	-9.91	QP	HORIZONTAL
6	721.73	12.02	20.08	7.14	39.24	46.00	-6.76	QP	HORIZONTAL

- Note: 1. Result Level = Read Level + Antenna Factor + Cable loss.
 2. If Peak Result complies with QP limit, QP Result is deemed to comply with QP limit.
 3. Test setup: RBW: 120 kHz, VBW: 300 kHz, Sweep time: auto.

5. 20dB Bandwidth

5.1. Block diagram of test setup

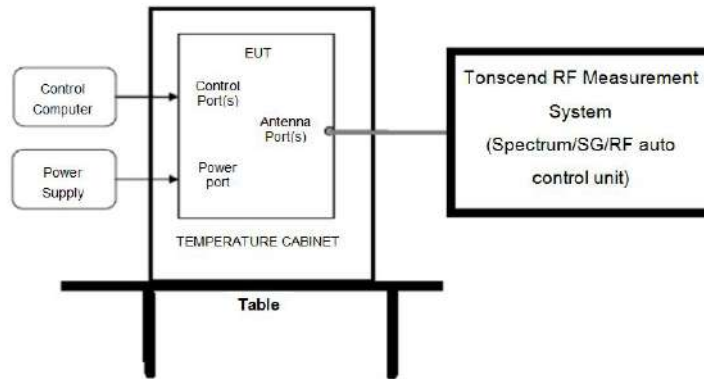

5.2. Limits

Emissions from the intentional radiator shall be confined within a band 200 kHz wide centered on the operating frequency. The 200 kHz band shall lie wholly within the frequency range of 88-108 MHz

5.3. Test Procedure

- (1) Connect EUT's antenna output to spectrum analyzer by RF cable.
- (2) The bandwidth of the fundamental frequency was measured by spectrum analyzer with 1 kHz RBW and 3 kHz VBW, span 200 kHz. The 20dB bandwidth is defined as the total spectrum the power of which is higher than peak power minus 20dB.

5.4. Test Result

Freq. (MHz)	20dB bandwidth Result (kHz)	Limit (kHz)	Conclusion
88.1	40.064	200	PASS
98.1	39.744	200	PASS
107.9	39.423	200	PASS

5.5. Original test data

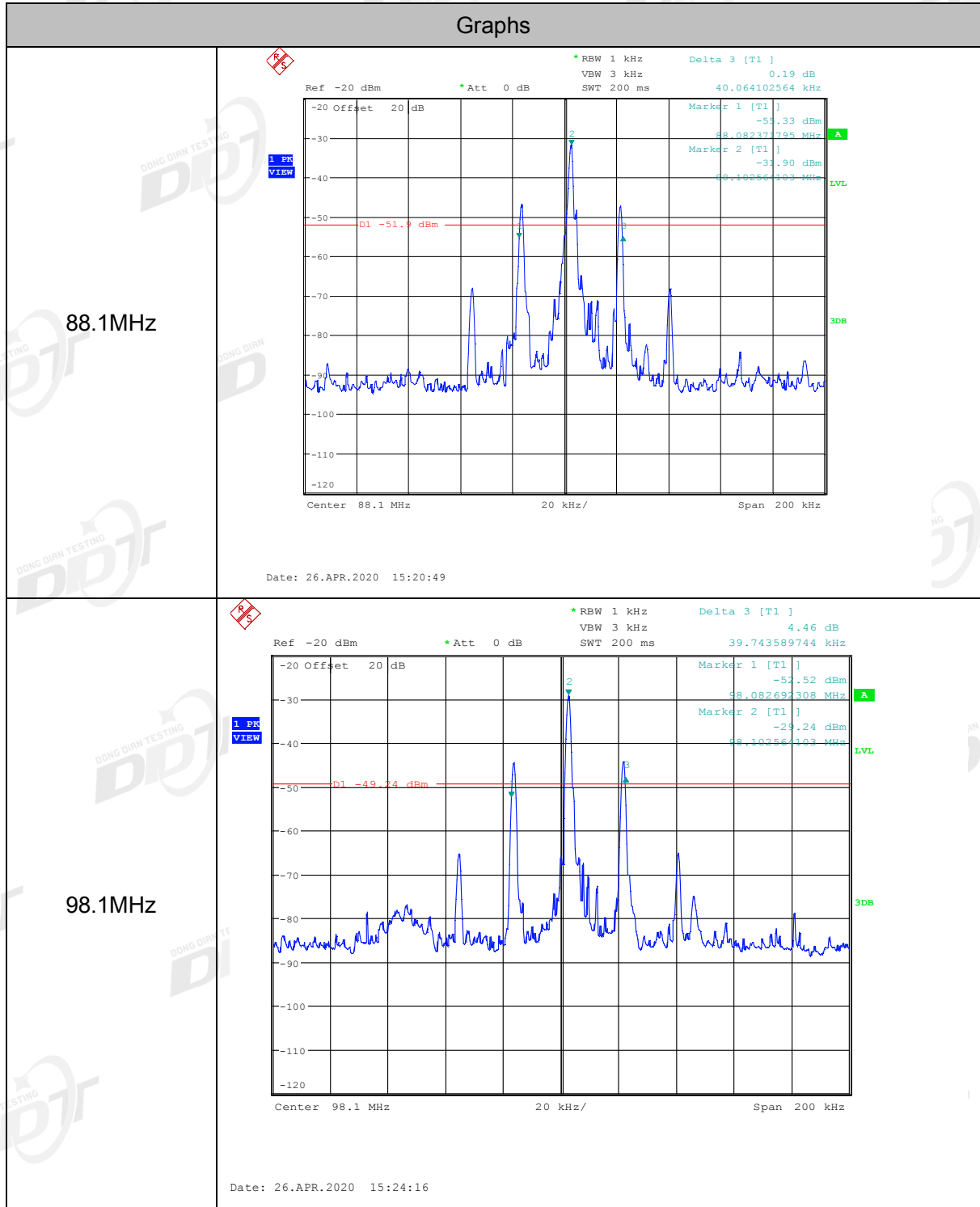

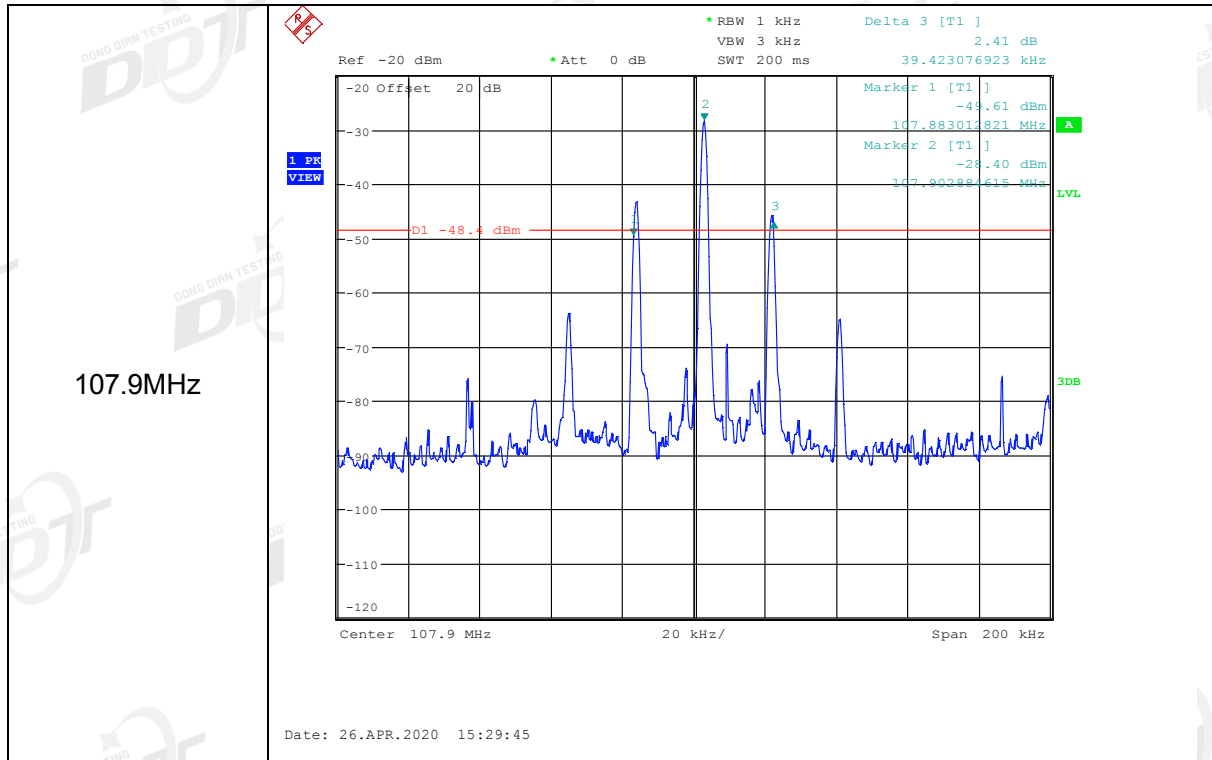

6. Power Line Conducted Emission

6.1. Block diagram of test setup

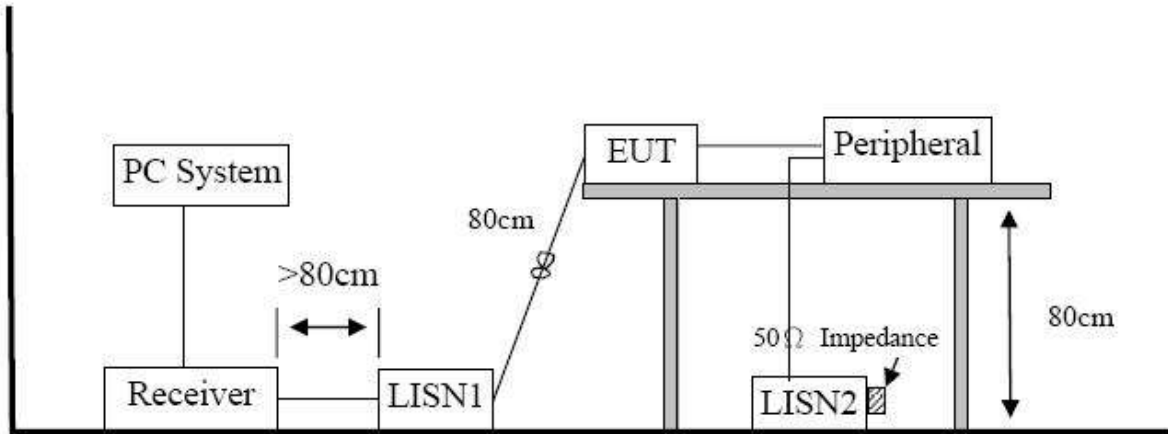

6.2. Power Line Conducted Emission Limits (Class B)

Frequency	Quasi-Peak Level dB(μ V)	Average Level dB(μ V)
150kHz ~ 500kHz	66 ~ 56*	56 ~ 46*
500kHz ~ 5MHz	56	46
5MHz ~ 30MHz	60	50

Note 1: * Decreasing linearly with logarithm of frequency.

Note 2: The lower limit shall apply at the transition frequencies.

6.3. Test Procedure

The EUT and Support equipment, if needed, were put placed on a non-metallic table, 80cm above the ground plane.

Configuration EUT to simulate typical usage as described in clause 2.4 and test equipment as described in clause 3 of this report.

All I/O cables were positioned to simulate typical actual usage as per ANSI C63.4.

All support equipment power received from a second LISN.

Emissions were measured on each current carrying line of the EUT using an EMI Test Receiver connected to the LISN powering the EUT.

The Receiver scanned from 150 kHz to 30MHz for emissions in each of the test modes.

During the above scans, the emissions were maximized by cable manipulation.

The test mode(s) described in clause 2.4 were scanned during the preliminary test.

After the preliminary scan, we found the test mode producing the highest emission level.

The EUT configuration and worst cable configuration of the above highest emission levels were recorded for reference of the final test.

EUT and support equipment were set up on the test bench as per the configuration with highest emission level in the preliminary test.

A scan was taken on both power lines, Neutral and Line, recording at least the six highest emissions.

Emission frequency and amplitude were recorded into a computer in which correction factors were used to calculate the emission level and compare reading to the applicable limit.

The test data of the worst-case condition(s) was recorded.

The bandwidth of test receiver is set at 9 kHz.

6.4. Test Result

Not Applicable, since the EUT is not AC-operated device.

7. Antenna Requirements

For intentional device, according to FCC 47 CFR Section 15.203, An intentional radiator shall be designed to ensure that no antenna other than that furnished by the responsible party shall be used with the device. The use of a permanently attached antenna or of an antenna that uses a unique coupling to the intentional radiator shall be considered sufficient to comply with the provisions of this section. The manufacturer may design the unit so that a broken antenna can be replaced by the user, but the use of a standard antenna jack or electrical connector is prohibited.