



TEST REPORT

This test report presents the measurement data required by the Commission for certifying the AS5ONEBTS-11 UMTS-CDMA cellular 850 transceiver, subject of this application. All the testing was performed during the period of December 16, 2005 to March 5, 2006. The measurement results have demonstrated the AS5ONEBTS-11 UMTS-CDMA cellular 850 transceiver is in full compliance with the Rules of the Commission.

For some of the required measurements where FCC Parts 2 and 22 did not give specific requirements, TIA/EIA and 3GPP2 requirements were used.



SUBEXHIBIT 10.1

Section 2.1033 (c)(14) REQUIRED MEASUREMENT DATA

The required measurement data is presented in the following exhibits as follows:

SUBEXHIBIT 10.2	Section 2.1046	Measurements Required: RF Power Output
SUBEXHIBIT 11.3	Section 2.1047	Measurements Required: Modulation Characteristics
SUBEXHIBIT 11.4	Section 2.1049	Measurements Required: Occupied Bandwidth
SUBEXHIBIT 11.5	Section 2.1051	Measurements Required: Spurious Emissions at Antenna Terminals
SUBEXHIBIT 11.6	Section 2.1053	Measurements Required: Field Strength of Spurious Radiation
SUBEXHIBIT 11.7	Section 2.1055	Measurements Required: Frequency Stability
SUBEXHIBIT 11.8	Section 2.947	Listing of Test Equipment Used



SUBEXHIBIT 10.2

Section 2.1046 MEASUREMENT REQUIRED: RF POWER OUTPUT

This test is a measurement of the RF power level transmitted at the AS5ONEBTS-11 UMTS-CDMA cellular 850 transceiver end antenna connector (EAC), as shown in the accompanying test set-up diagram. All the carriers were configured in cdma2000 (3G-1x) mode with pilot, page, sync and traffic channels per 3GPP2 cdma2000 standards, or in IS856 (3G-1xEV) mode with pilot, MAC and data channels per 3GPP2 High Rate Packet Data standards.

Power measurements were made with a Giga-tronics 8542C Universal Power Meter with 80621A Power Sensor (0.01 – 18 GHz) in the average mode. The test set-up for conducting the RF power output measurement from the UMTS-CDMA transceiver is shown in the following figure. Before the testing was started, the Base Station was given a sufficient “warm-up” period as required.

The measured channels and results are tabulated in the following table:

Table 10.2.1.1 Results of RF Power Output – Single Carrier cdma2000 (3G-1x)

Cellular Channel No.	Frequency (MHz)	Cellular Frequency Band	Output (dBm)
1019	869.88	A''	43.96
37	871.11	A3	44.10
78	872.34	A2	44.03
119	873.57		44.06
160	874.80		44.04
201	876.03	A1	44.04
242	877.26		44.02
283	878.49		44.00
384	881.52	B1	44.00
425	882.75		44.04
466	883.98		44.06
507	885.21	B2	44.05
548	886.44		44.09
589	887.67		44.02
630	888.90	B3	43.96
691	890.73	A'	44.02
777	893.31	B'	43.92



Table 11.2.1.2 Results of RF Power Output – Multi-Carrier cdma2000 (3G-1x)

Cellular Channel No.	Cellular Frequency Band	Output (dBm)	Output (Watts)
1019, 37	A''/A3	47.05	50
1019, 37, 78	A''/A3/A2	48.57	75
1019, 37, 78, 119		50.04	100
589, 630	B3/B2	47.10	50
548, 589, 630		49.07	75
507, 548, 589, 630		50.06	100

Table 10.2.2.1 Results of RF Power Output – Single Carrier IS-856 (3G-1xEV)

Cellular Channel No.	Frequency (MHz)	Cellular Frequency Band	Output (dBm)
1019	869.88	A''	43.94
37	871.11	A3	44.02
78	872.34	A2	44.01
119	873.57		44.03
160	874.80		44.10
201	876.03	A1	44.03
242	877.26		44.05
283	878.49		44.00
384	881.52	B1	43.95
425	882.75		44.02
466	883.98		44.18
507	885.21	B2	44.25
548	886.44		44.30
589	887.67		44.20
630	888.90	B3	44.06
691	890.73	A'	43.98
777	893.31	B'	43.80

Table 11.2.2.2 Results of RF Power Output – Multi-Carrier IS-856 (3G-1xEV)

Cellular Channel No.	Cellular Frequency Band	Output (dBm)	Output (Watts)
1019, 37	A''/A3	47.08	50
589, 630	B3/B2	47.16	50

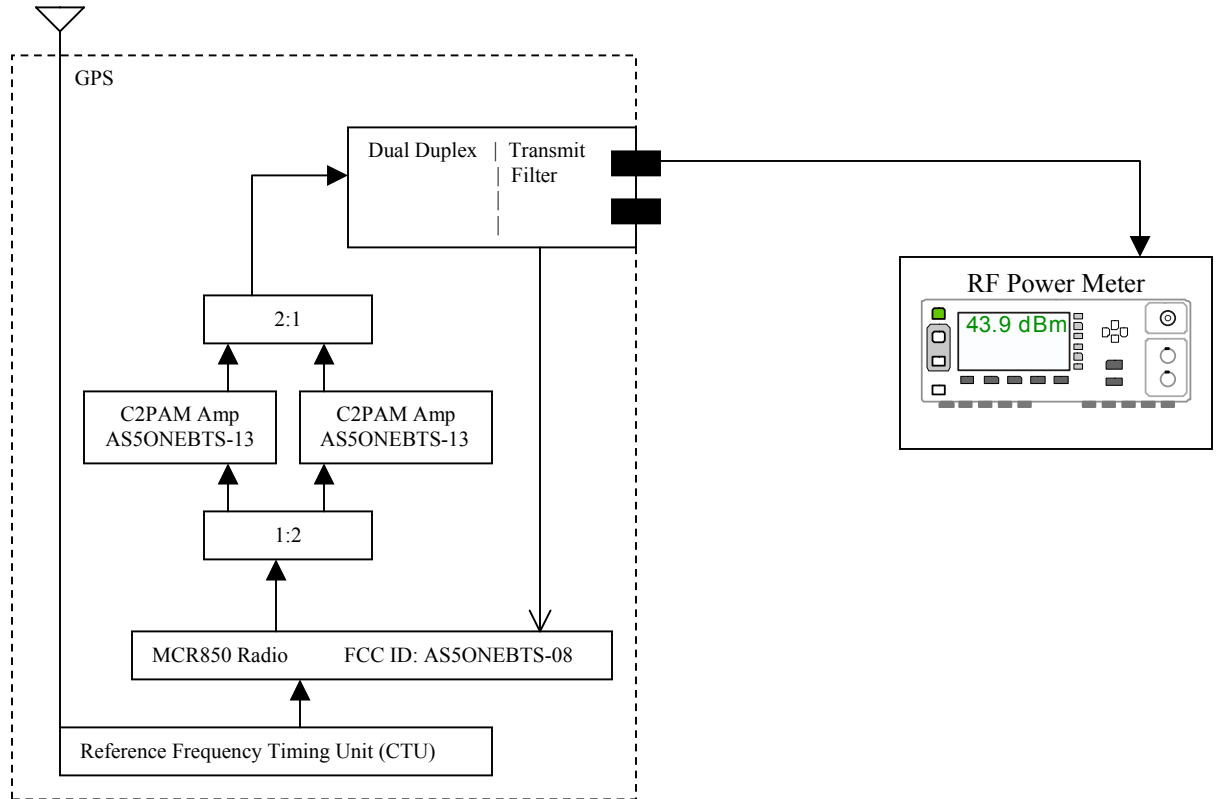


Results:

The RF power output across the Cellular Frequency Band 869.0 – 894 MHz are in full compliance with the Rules of the Commission.



FIGURE 10.2.1 TEST SET-UP FOR MEASUREMENT OF RADIO FREQUENCY POWER OUTPUT





SUBEXHIBIT 11.3

Section 2.1047 MEASUREMENT REQUIRED: MODULATION CHARACTERISTICS

The AS5ONEBTS-11 UMTS CDMA 850 transceiver utilizes digital Phase Shift Key (PSK) modulation and Quadrature Amplitude Modulation (QAM). The modulation accuracy measures the ability of the transmitter to generate the ideal signal which is defined by the waveform quality. The waveform quality is measured by determining the normalized correlated power between the actual waveform and the ideal waveform.

The measurements were performed with an Agilent E4440A PSA Spectrum Analyzer which was calibrated in accordance with ISO 9001 process.

The test set-up diagram is given in the Figure 10.3.1, where the Agilent E4440A PSA Spectrum Analyzer used the external signals from the base station as its trigger source and time reference.

Results:

The wave quality factors ρ (rho) measured were ≥ 0.98 . The following figures show representative screen plots of the code domain and modulation accuracy measurements. The modulation characteristics of the AS5ONEBTS-11 UMTS CDMA 850 transceiver is in full compliance with the Rules of the Commission across the Cellular Frequency Band 869.0 – 894.0 MHz.



FIGURE 11.3.1 TEST SET-UP FOR MEASUREMENT OF MODULATION ACCURACY

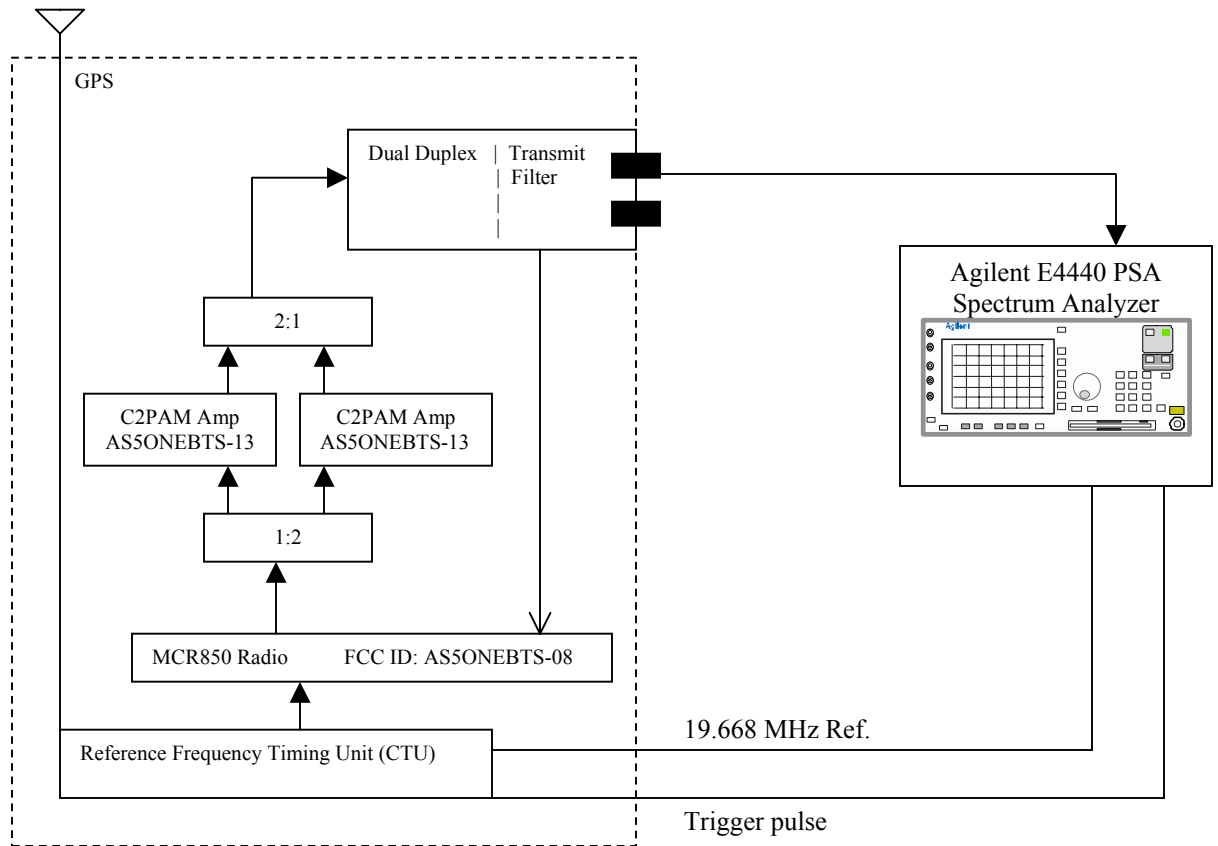




FIGURE 10.3.2 Screen Plot of Code Domain – cdma2000 (3G-1x)

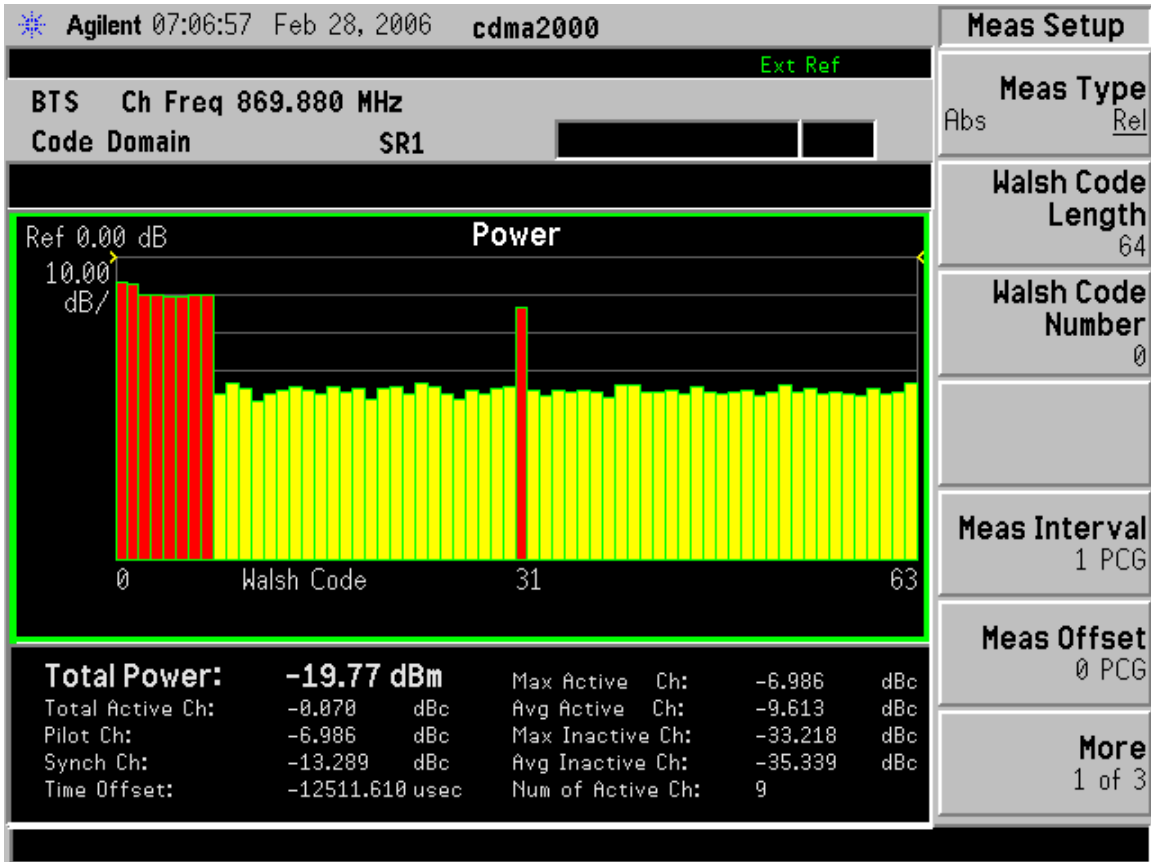




FIGURE 10.3.2 Screen Plot of Modulation Accuracy – cdma2000 (3G-1x)

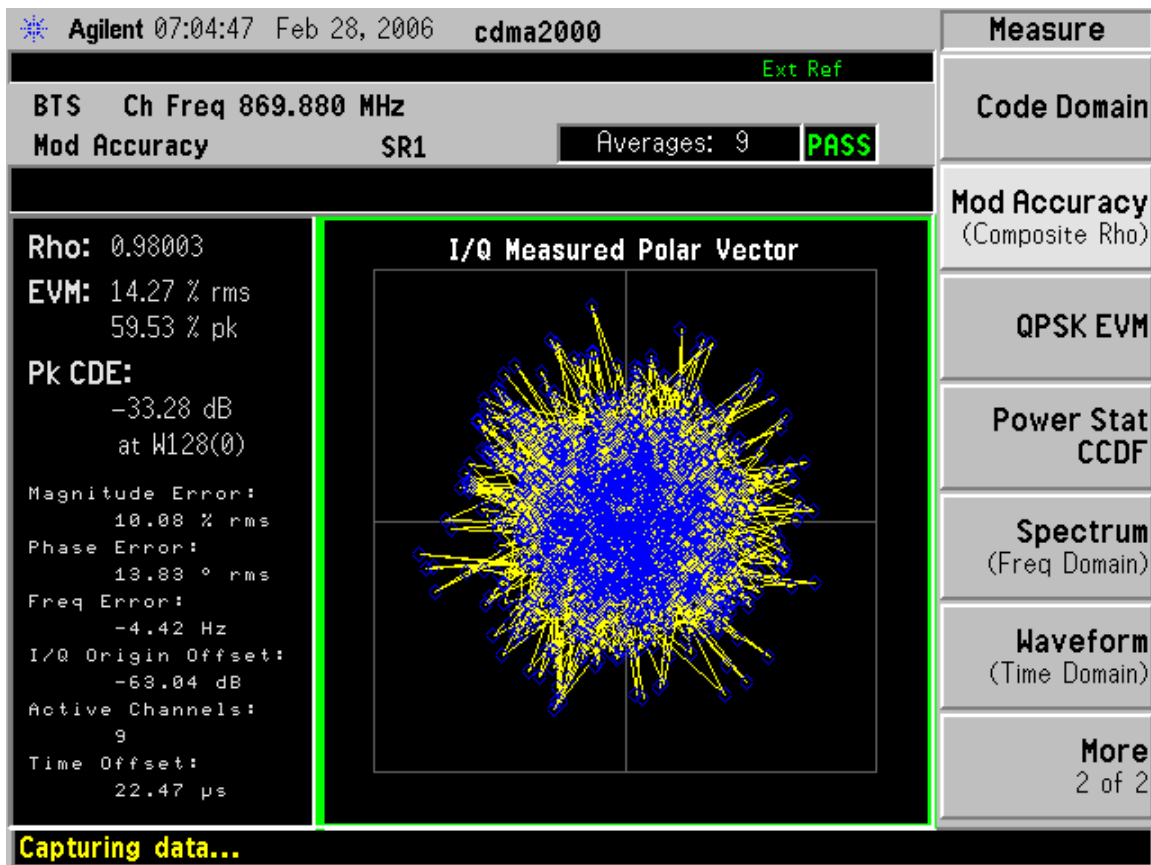




FIGURE 10.3.2 Screen Plot of Code Domain – IS-856 (3G-1xEV) Pilot Channel

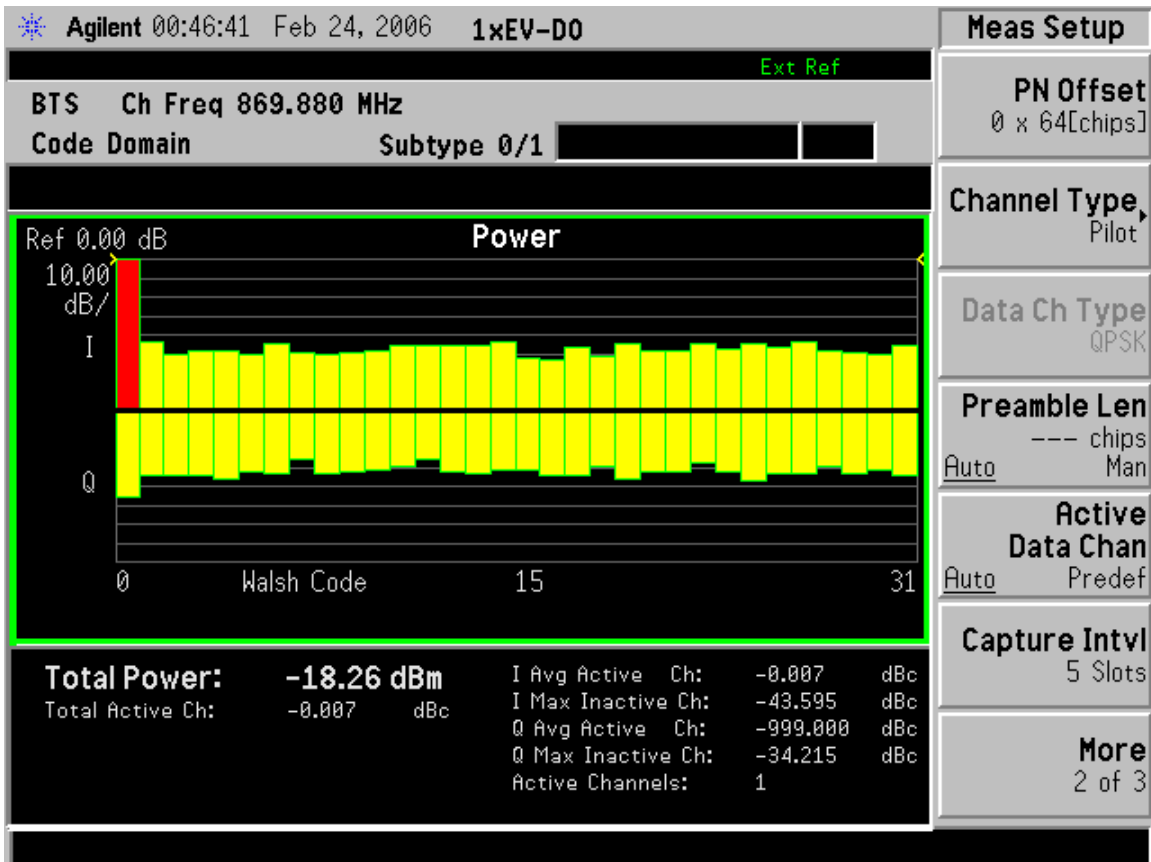




FIGURE 10.3.2 Screen Plot of Code Domain – IS-856 (3G-1xEV) 9 MAC channels

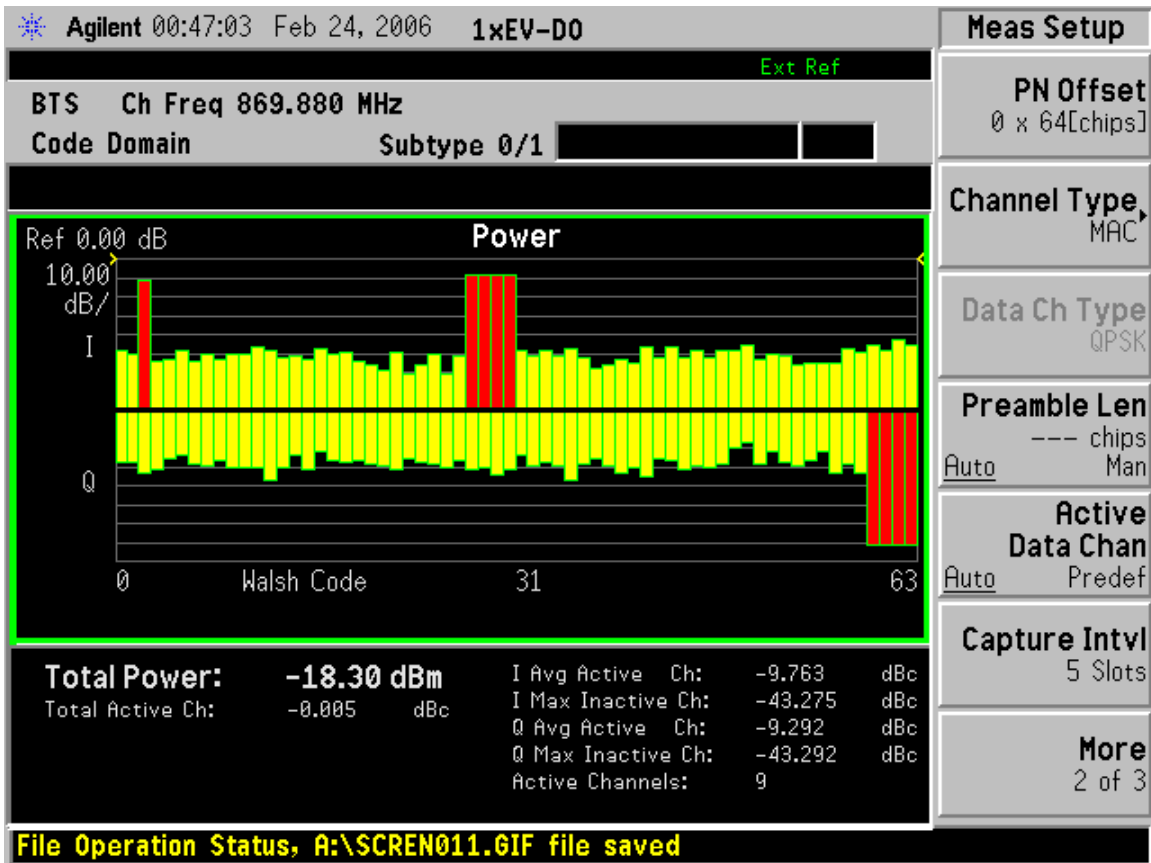




FIGURE 10.3.2 Screen Plot of Code Domain – IS-856 (3G-1xEV) 16 Data channels

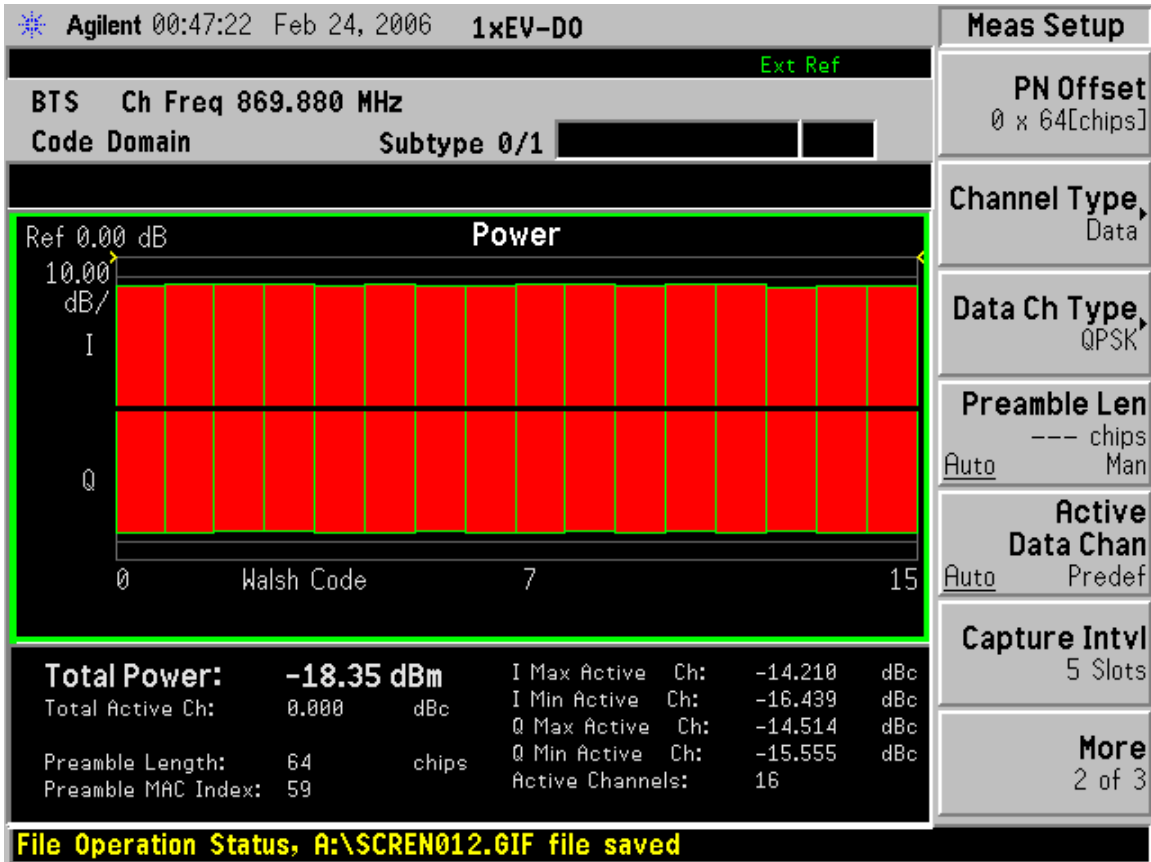




FIGURE 10.3.2 Screen Plot of Modulation Accuracy – IS-856 (3G-1xEV) Pilot

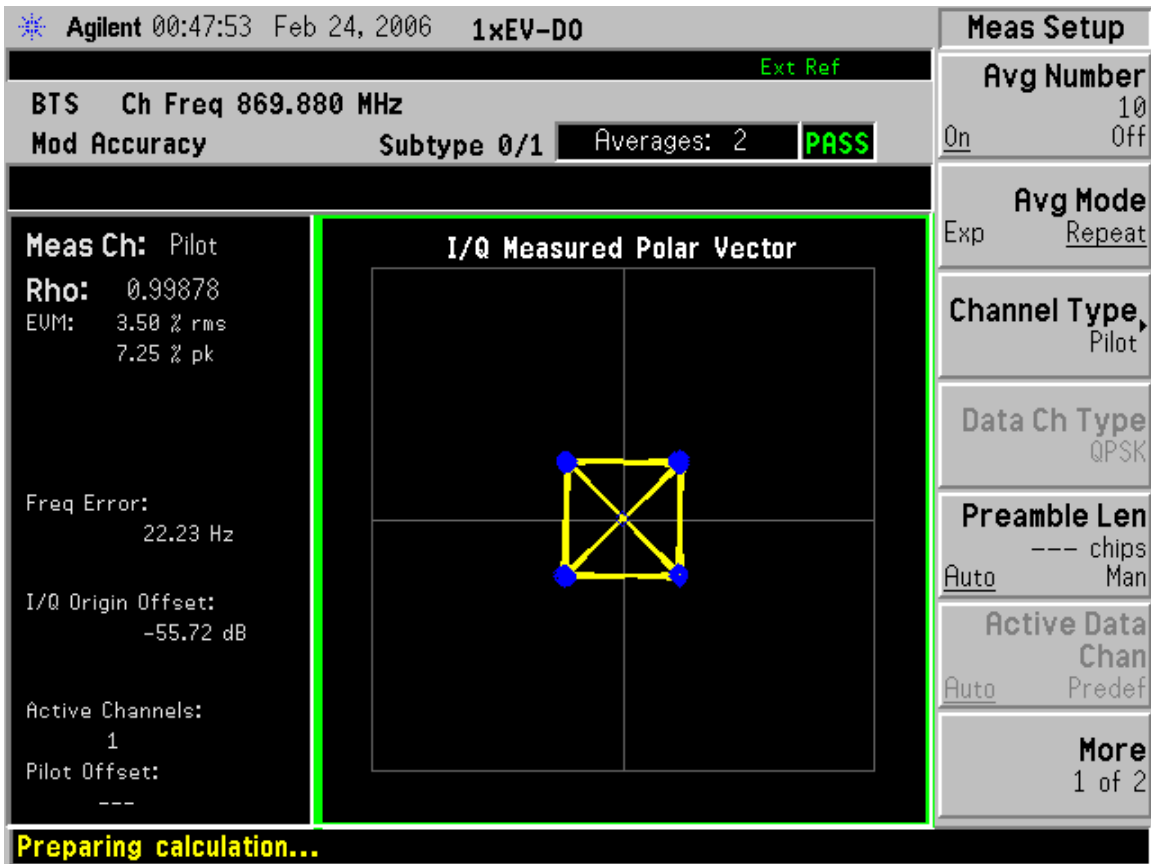




FIGURE 10.3.2 Screen Plot of Modulation Accuracy – IS-856 (3G-1xEV) 9 MAC channels

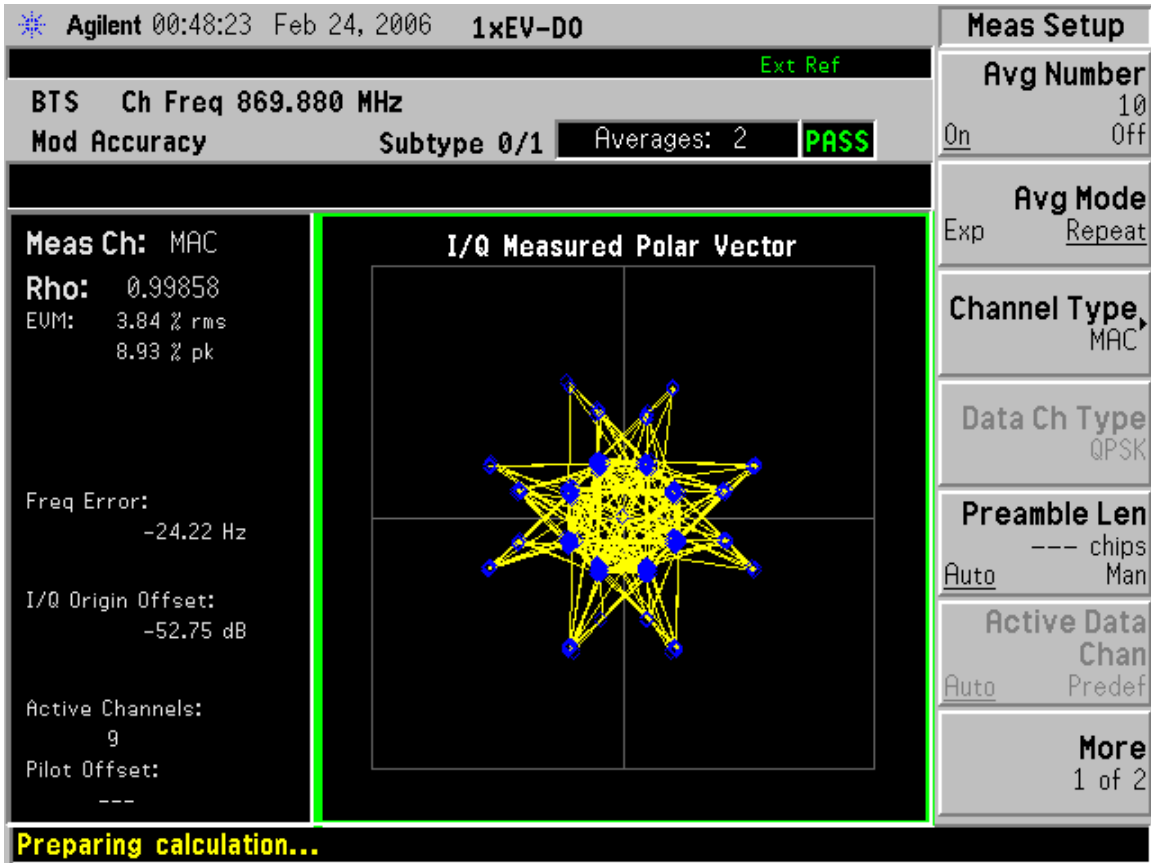




FIGURE 10.3.2 Screen Plot of Modulation Accuracy – IS-856 (3G-1xEV) 16 Data channels

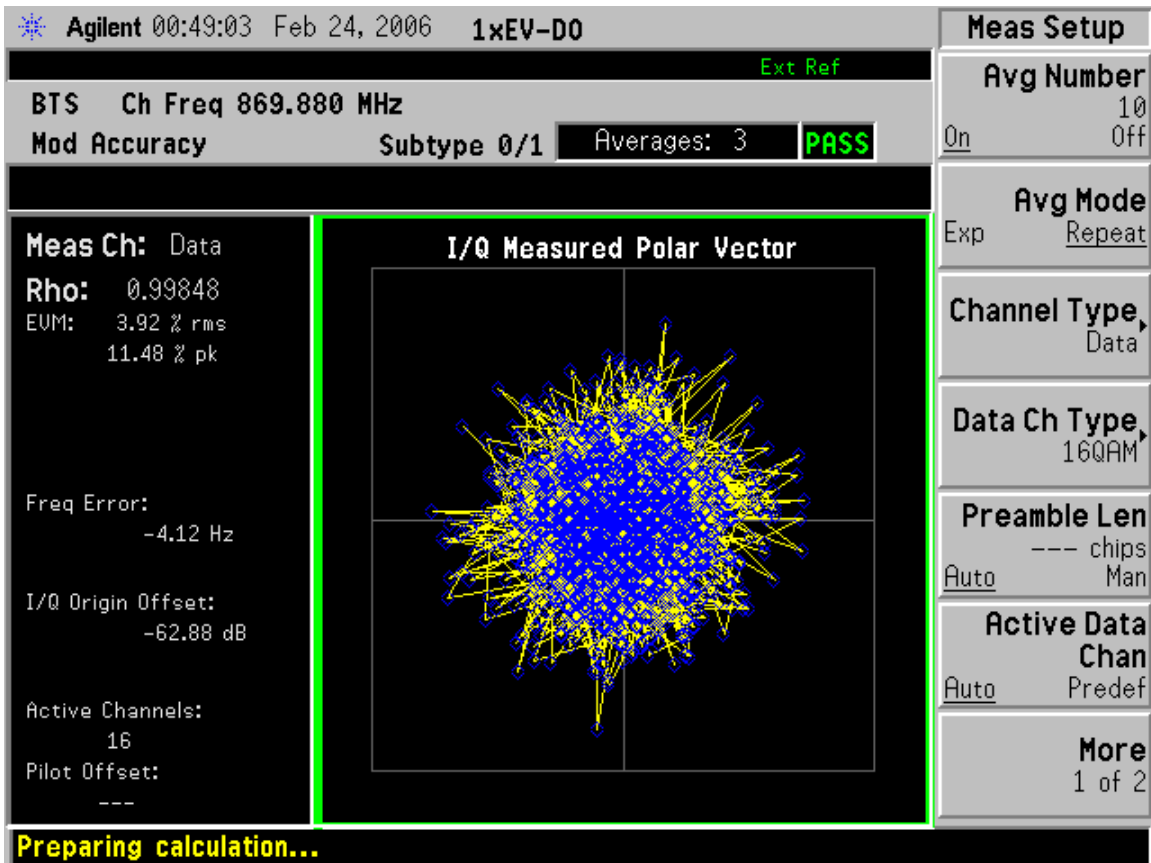




FIGURE 10.3.2 Screen Plot of Modulation Accuracy – IS-856 (3G-1xEV) Preamble

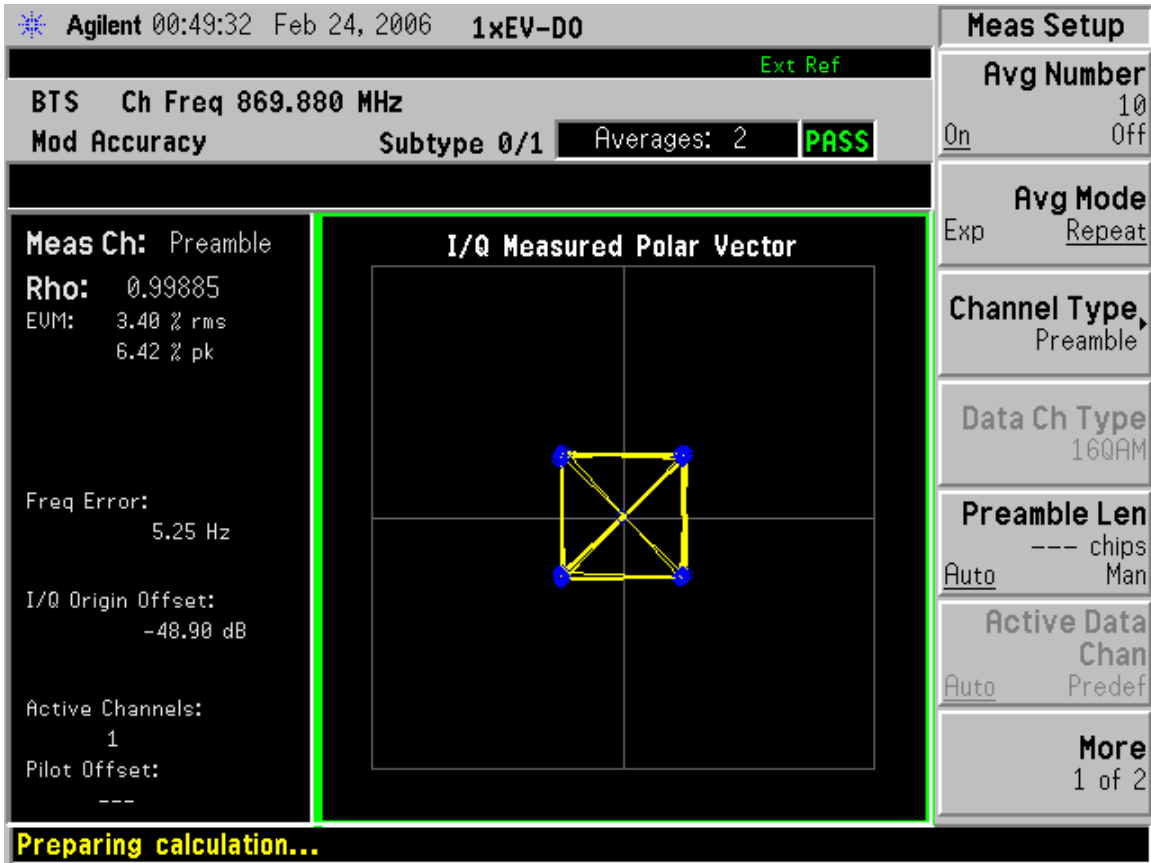
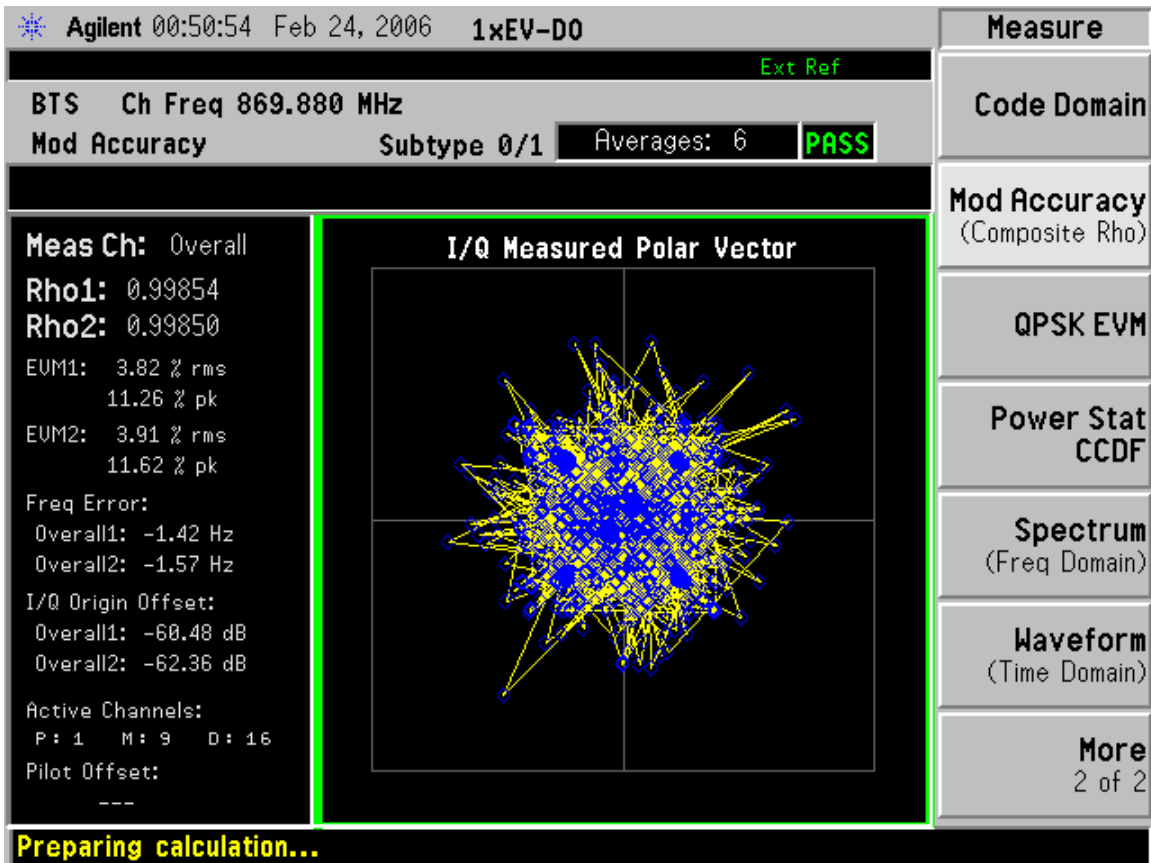




FIGURE 10.3.2 Screen Plot of Mod. Accuracy – IS-856 (3G-1xEV) Overall (pilot, 9 MAC, 16 data)





SUBEXHIBIT 11.4

Section 2.1049 MEASUREMENT REQUIRED: OCCUPIED BANDWIDTH

In compliance with Section 2.1049(h), the AS5ONEBTS-11 UMTS CDMA transceiver was configured in cdma2000 (3G-1x) mode with pilot, page, sync and traffic channels per 3GPP2 cdma2000 standards, or in IS856 (3G-1xEV) mode with pilot, MAC and data channels per 3GPP2 High Rate Packet Data standards.

The occupied bandwidth measurements were made at the end antenna connector (EAC) of the AS5ONEBTS-11 UMTS CDMA transceiver from : 1. the lowest available cellular CDMA channels in the A band, Ch 1019 at 869.88 MHz, 2. two contiguous A band channels (A², A3) for IS-856 and two to four contiguous A band channels (A², A3) for cdma2000, 3. the highest available cellular CDMA channels in the B band, Ch 777 at 893.31 MHz (B²), Ch 691 at 890.73 MHz (A²), and Ch 630 at 888.90 MHz (B3) 4. two contiguous B band channels (B3, B2) for IS-856 and two to four contiguous B band channels (B3, B2) for cdma2000. The carrier power level at the end antenna connector (EAC) of the AS5ONEBTS-11 UMTS CDMA transceiver was transmitting to the maximum rated mean power.

The emission limitations and the setting of measurement equipment for the occupied bandwidth measurement of a 1.23MHz CDMA cellular carrier were specified in Appendix A, Section 10 of FCC 02-229 Report and Order. FCC's requirements are tabulated in the following table:

Table 11.4.1 FCC Part 22 Spurious Emission Limits

Frequency	Required Minimum Attenuation below the Mean Carrier Power <i>P</i>	Minimum Resolution Bandwidth of Spectrum Analyzer
1MHz Bands Immediately Outside the Transmitting Frequency Band	(43 + P dBW) dBc	12.3 kHz
Out-of-Band (other than above)	(43 + P dBW) dBc	100 kHz

The requirements specified in TIA/EIA and 3GPP2 are tabulated in the following table:

Table 11.4.2 TIA/EIA and 3GPP2 Spurious Emission Limits

Displacement from the Carrier Center Frequency f_c	Required Minimum Attenuation	Resolution Bandwidth of Spectrum Analyzer
750 kHz < $ f - f_c \leq$ 1.98 MHz	45 dBc	30 kHz
1.98 MHz < $ f - f_c \leq$ 4.0 MHz	55 dBc	30 kHz

A combined requirement of FCC Part 22 and TIA/EIA-3GPP2 was used as the required emissions limit mask in the measurement. The measurements were performed with an Rohde & Schwartz EMI Test Receiver (ESMI) which was calibrated in accordance with ISO 9001 process. The test set-up diagram is given in the following.



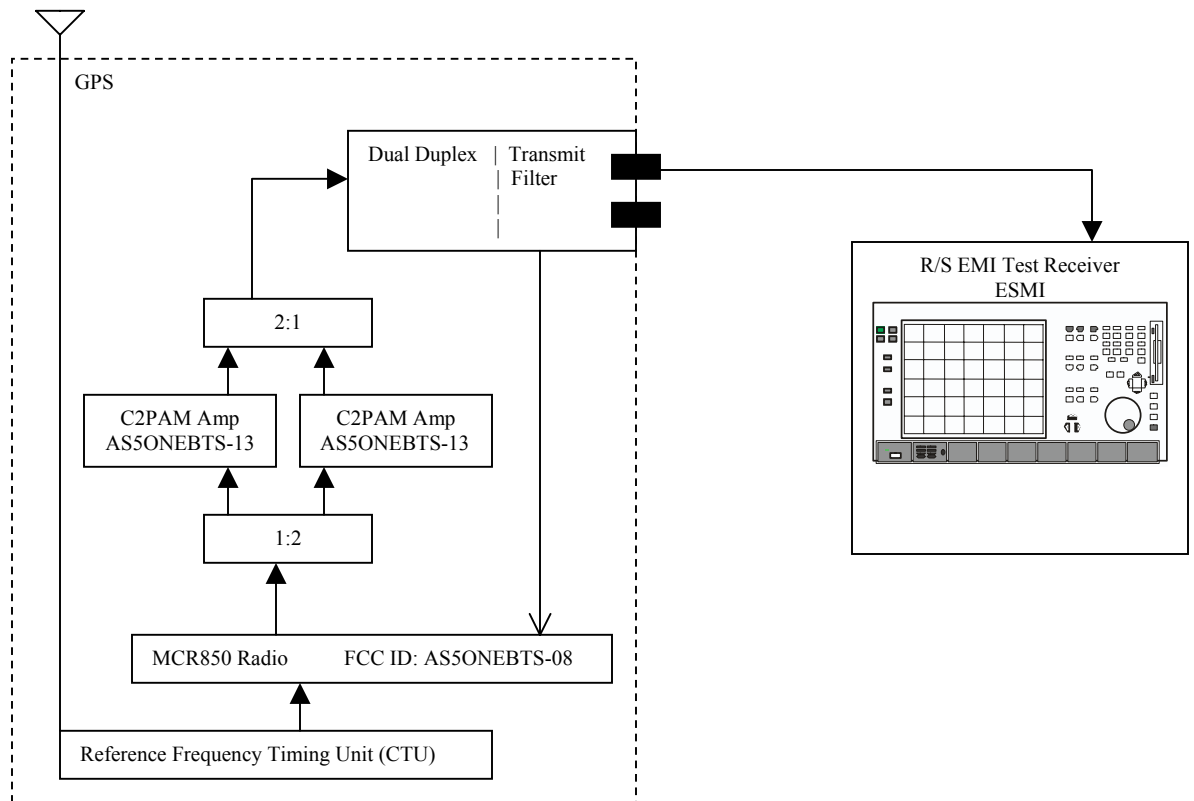
The spectrum analyzer was set with a 30 kHz resolution bandwidth and a 8 MHz span, as shown in the plots of the occupied bandwidth measurement attached in the following pages. The emissions outside the 8MHz span was evaluated in Measurement Required: Spurious Emissions at the Antenna Terminal. The maximum mean output power of the CDMA carrier, measured with a 3 MHz resolution bandwidth, aligns with the top of the spectrum analyzer display reticule, i.e., 0 dBm, by adjusting the REF LEVEL OFFSET of the spectrum analyzer. The top of the carrier measured with a 30 kHz resolution bandwidth, thus, was 16.1 dB below the carrier power measured with a resolution bandwidth greater than the carrier bandwidth 1.23 MHz. This 16.1dB offset was due to the fact that $10 \log (1230\text{kHz}/30\text{kHz}) = 16.1 \text{ dB}$.

Results:

From the occupied bandwidth plots attached in the following, it can be seen that all the waveforms are under the required emission mask with adequate margins. The measurement results demonstrate the full compliance with the Rules of the Commission across the Cellular Frequency Band 869.0 – 894.0 MHz.

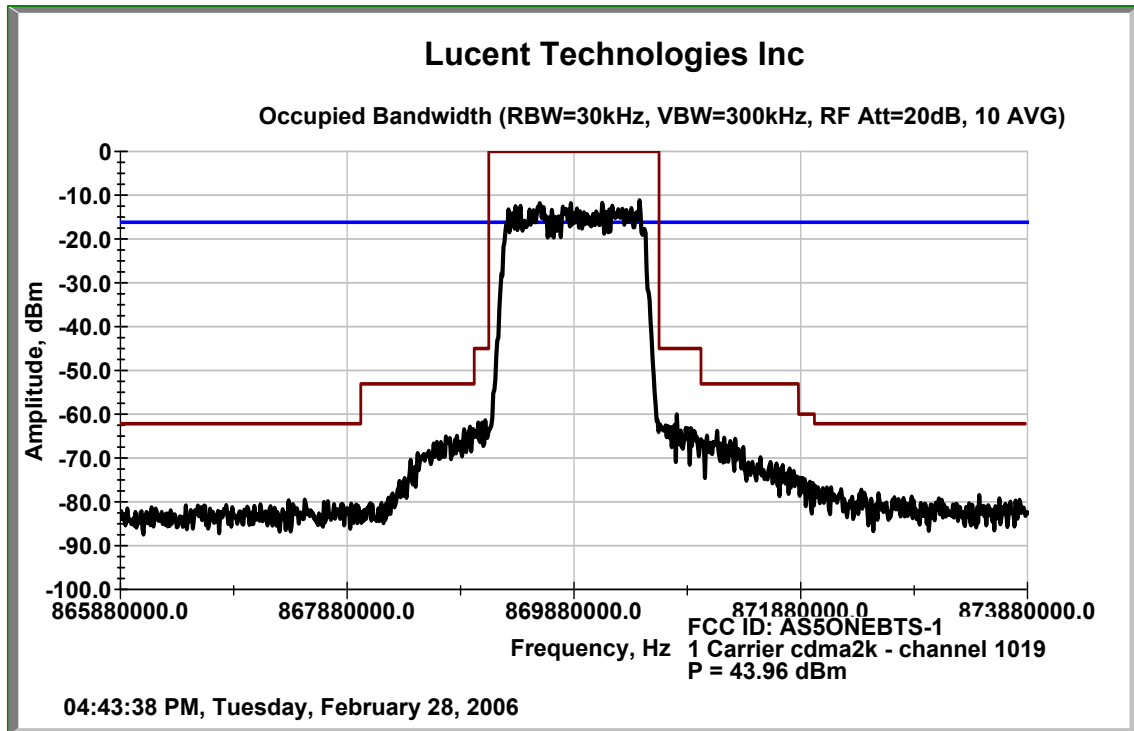


FIGURE 11.4.1 TEST SET-UP FOR MEASUREMENT OF OCCUPIED BANDWIDTH

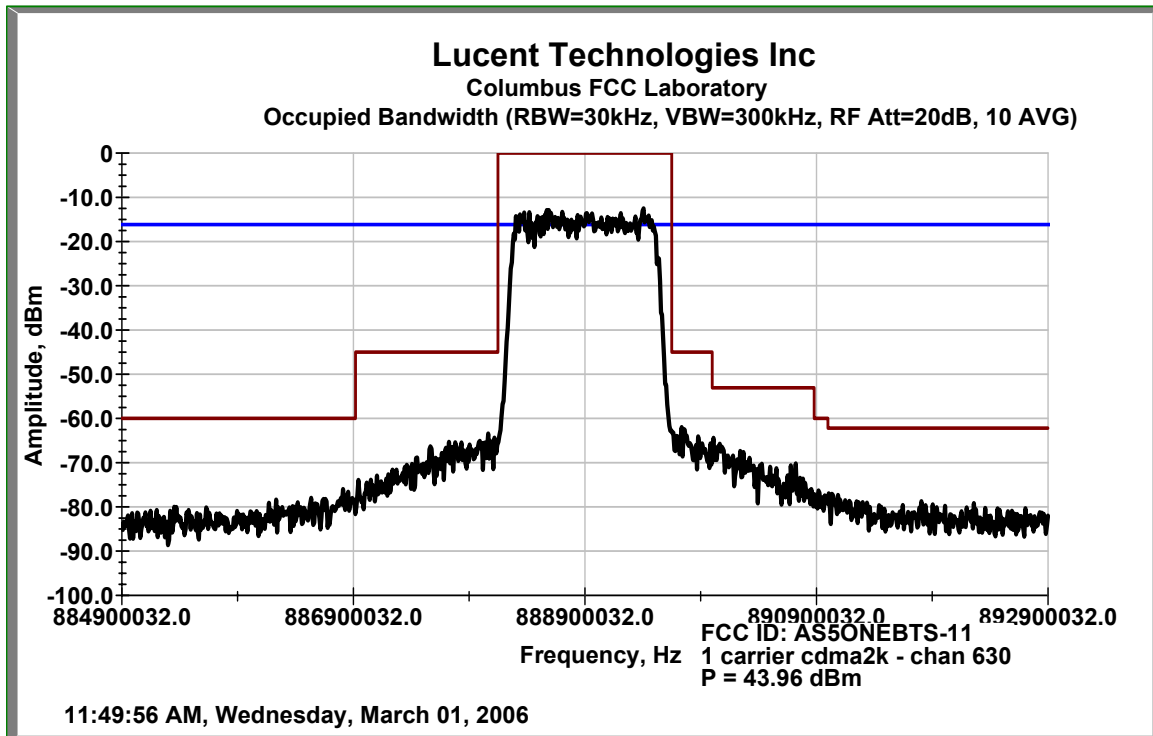




A” Band – Left Edge 1-carrier cdma2000 (3G-1x)

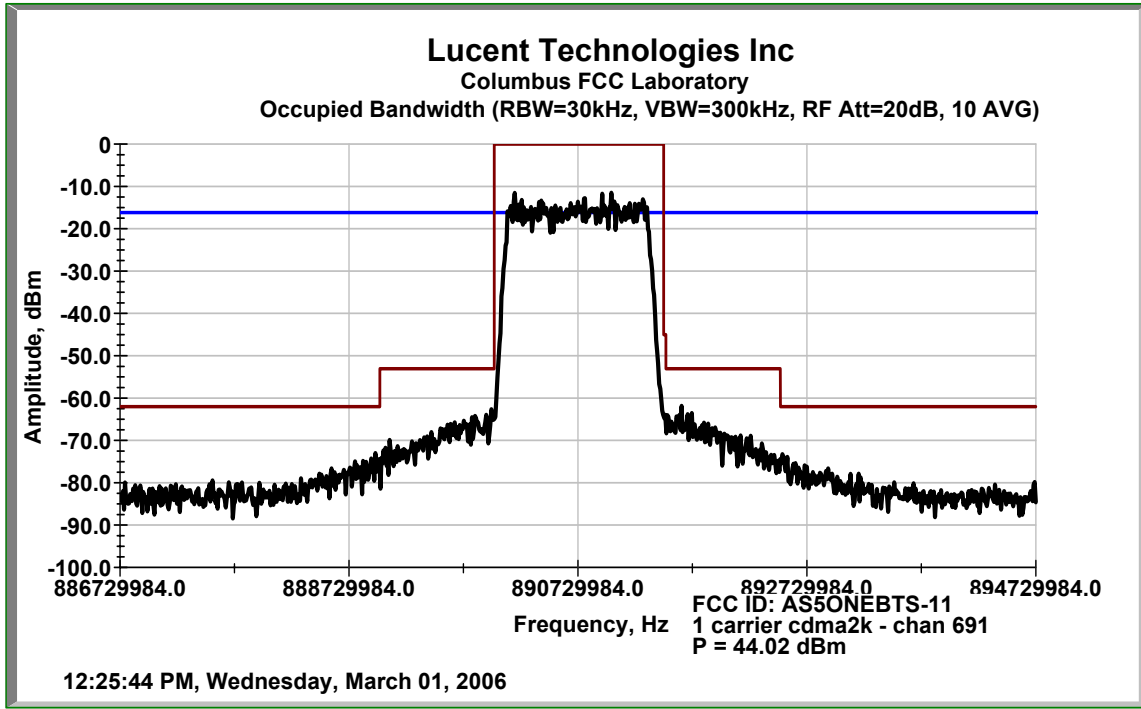


B3 Band – Right Edge 1-carrier cdma2000 (3G-1x)

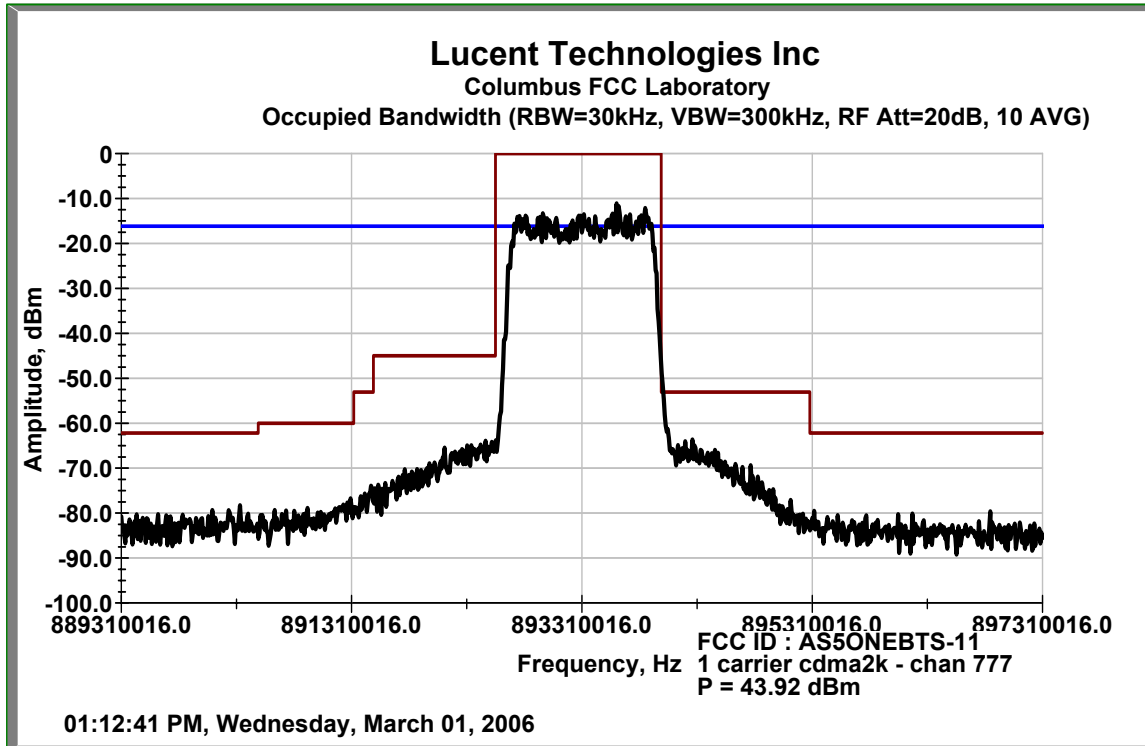




A' Band – Channel 691 1-carrier cdma2000 (3G-1x)

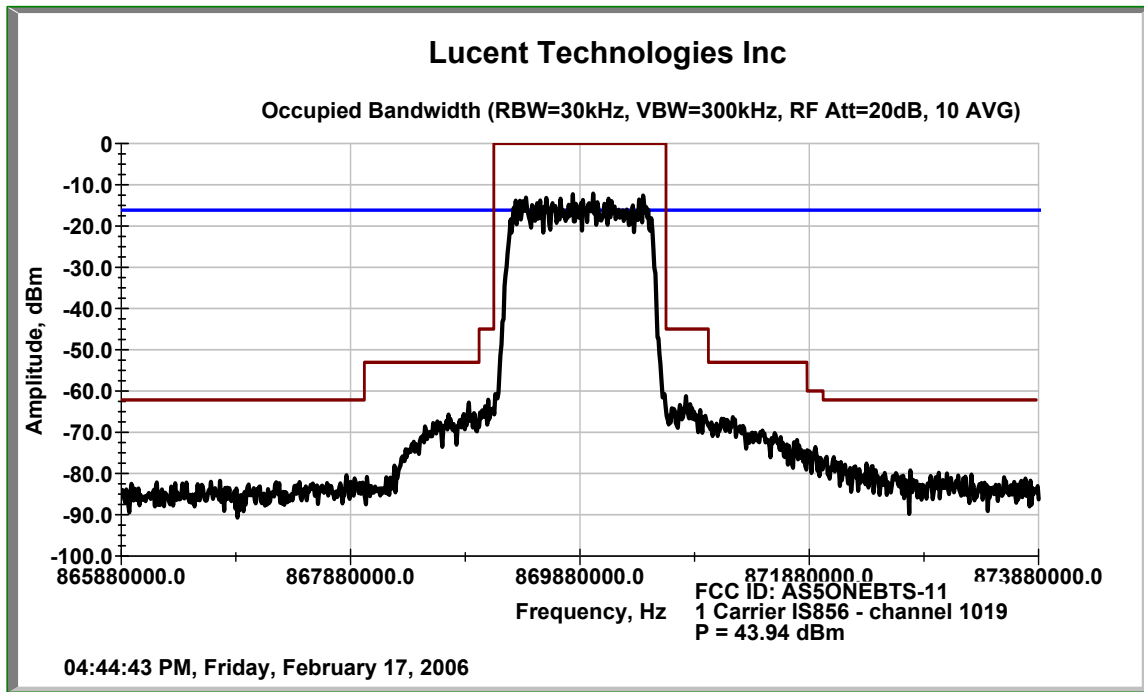


B' Band – Channel 777 1-carrier cdma2000 (3G-1x)

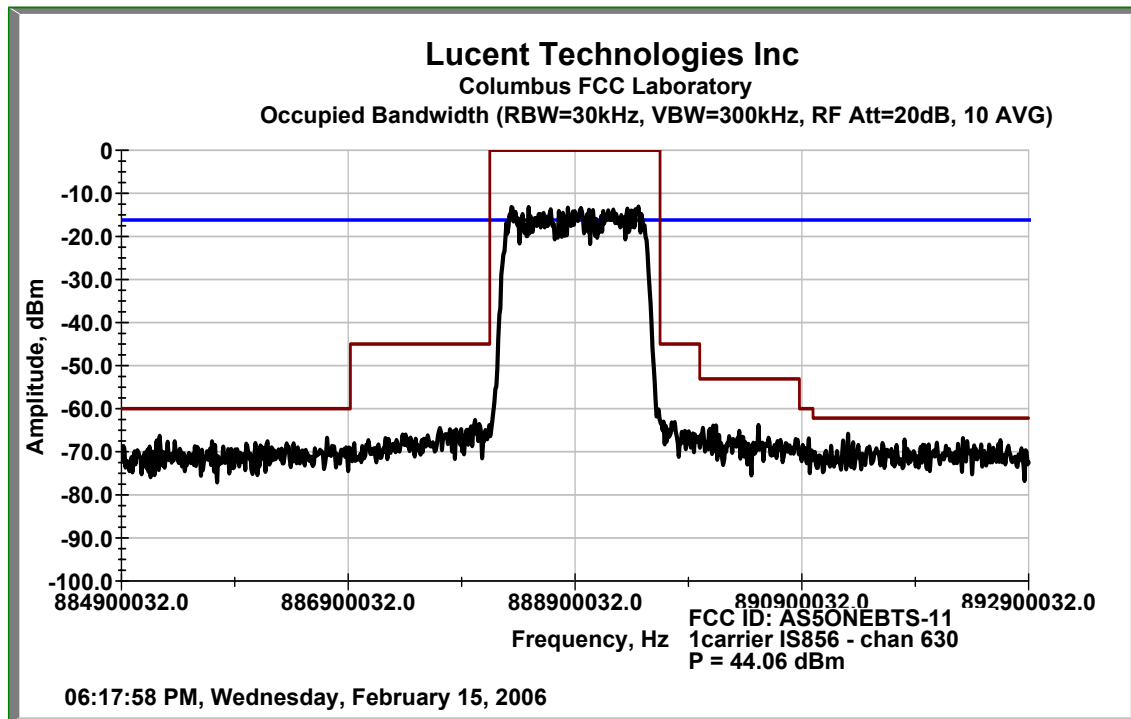




A” Band – Left Edge 1-carrier IS-856 (3G-1xEV)

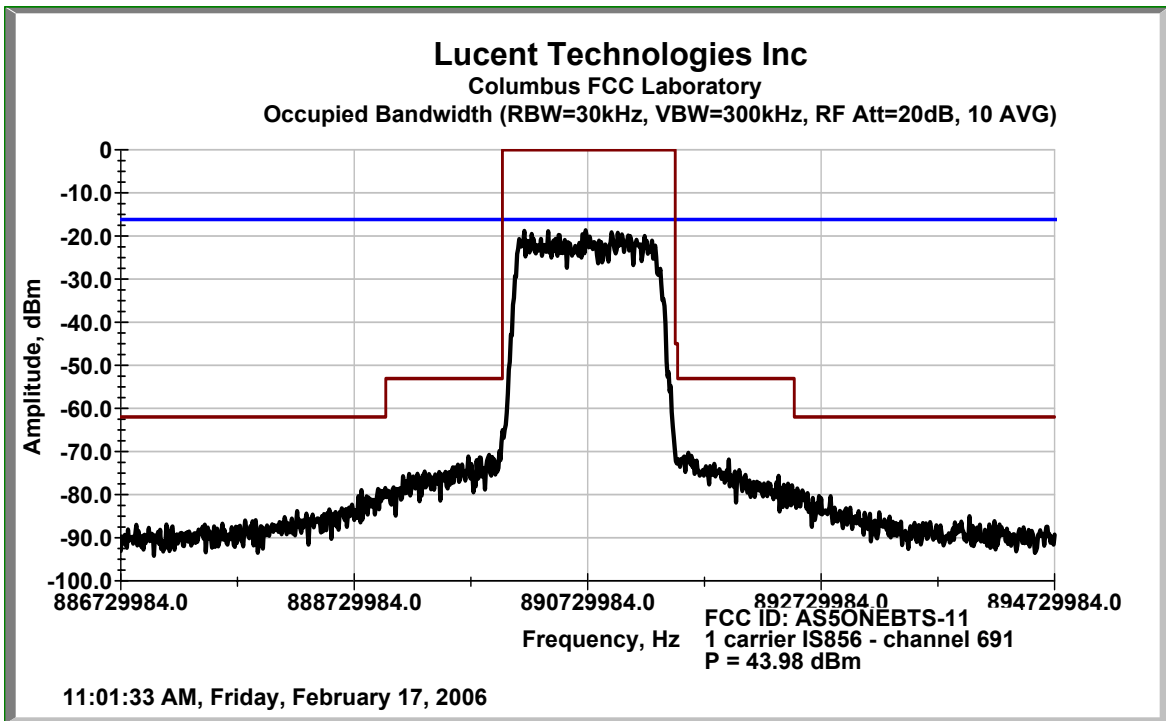


B3 Band – Right Edge 1-carrier IS-856 (3G-1xEV)

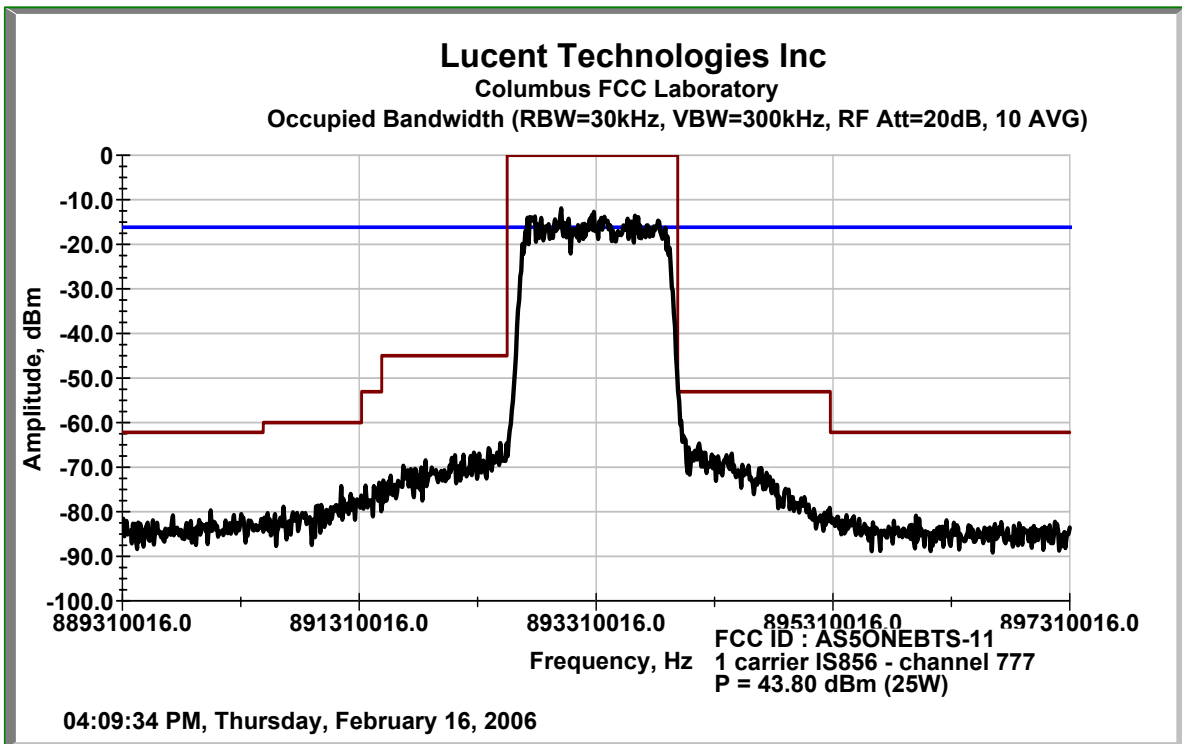




A' Band – Channel 691 1-carrier IS-856 (3G-1xEV)

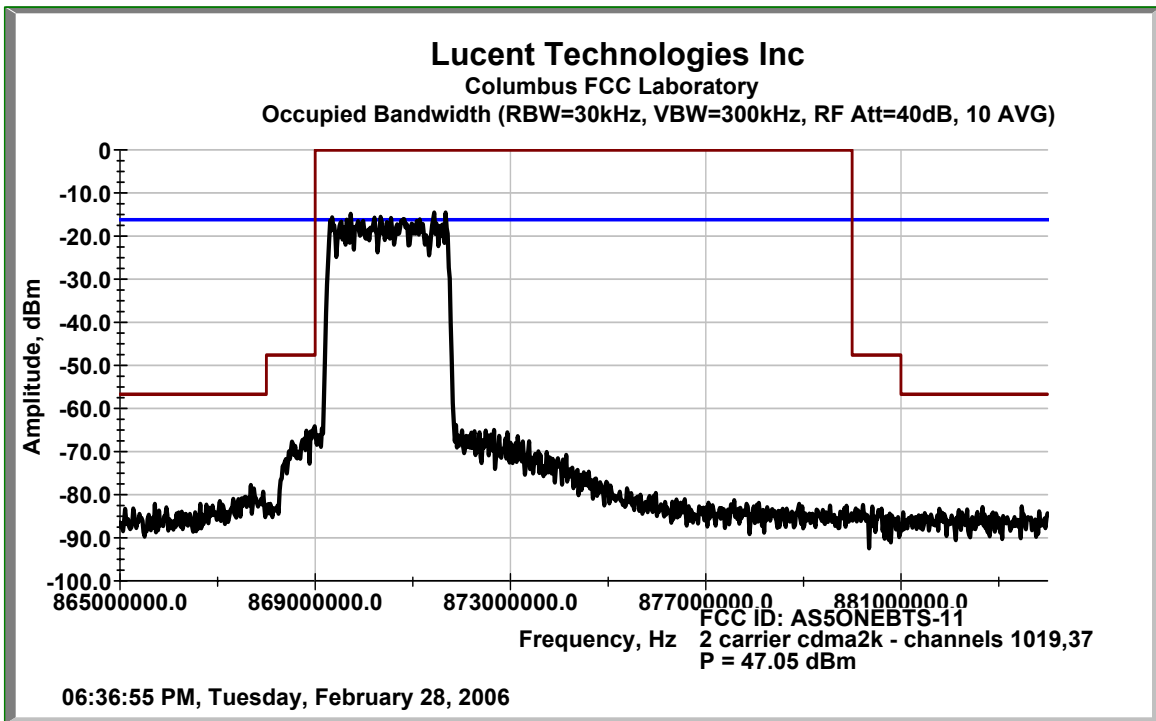


B' Band – Channel 777 1-carrier IS-856 (3G-1xEV)

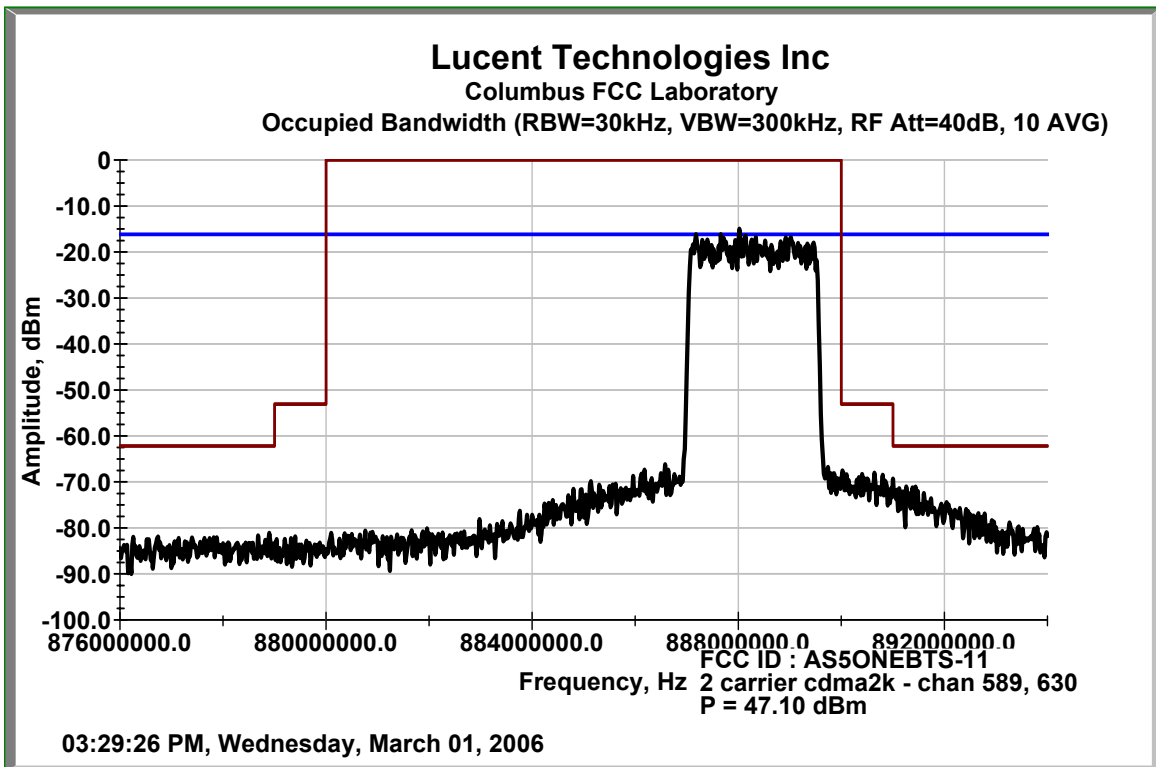




A*/A3 Band – Left Edge 2-carrier cdma2000 (3G-1x)

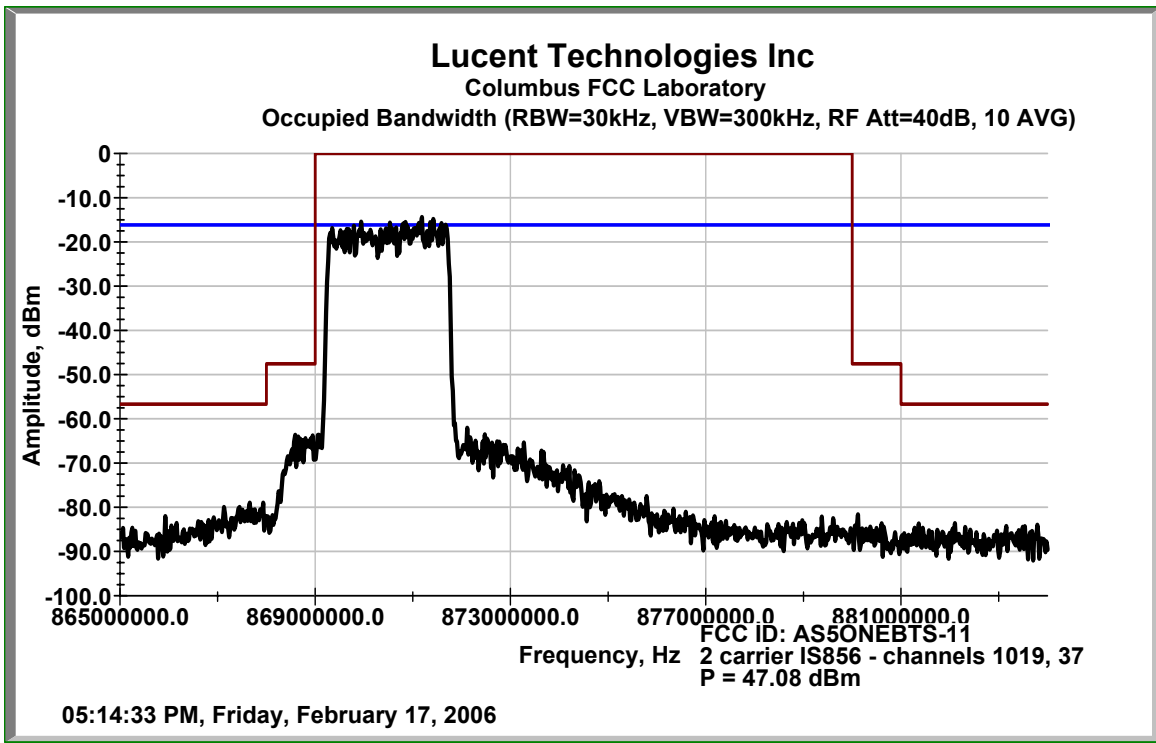


B3/B2 Band – Right Edge 2-carrier cdma2000 (3G-1x)

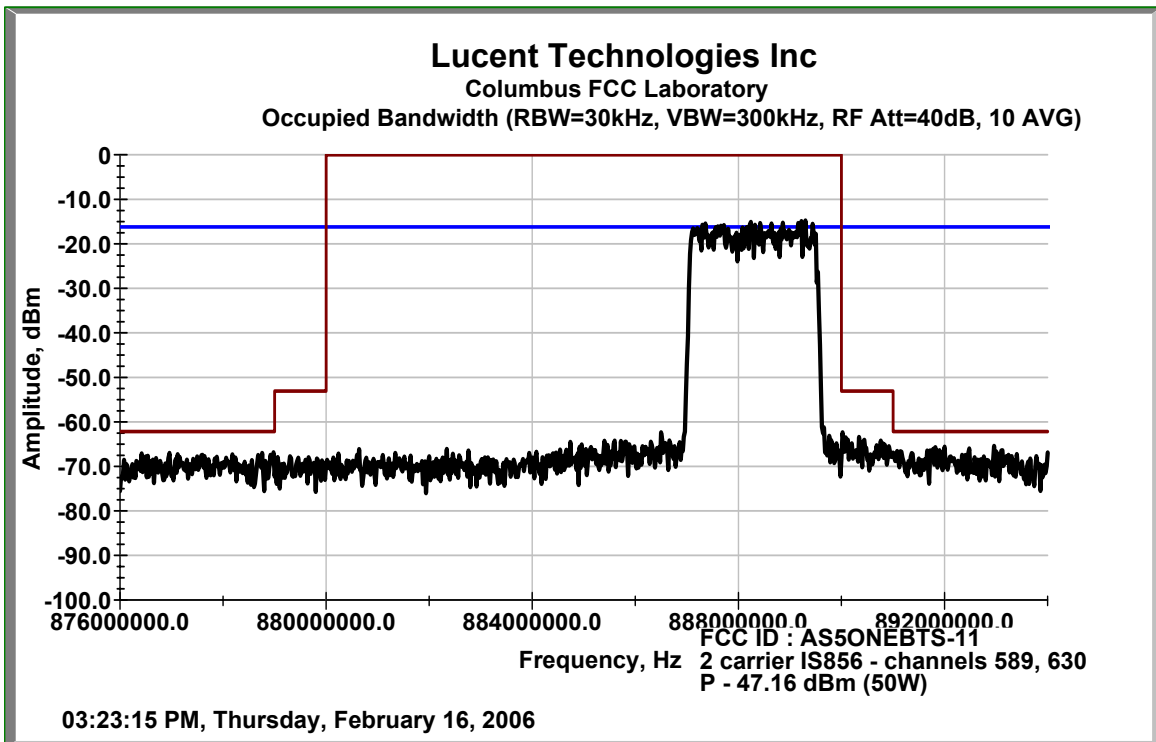




A3/A3 Band – Left Edge 2-carrier IS-856 (3G-1xEV)

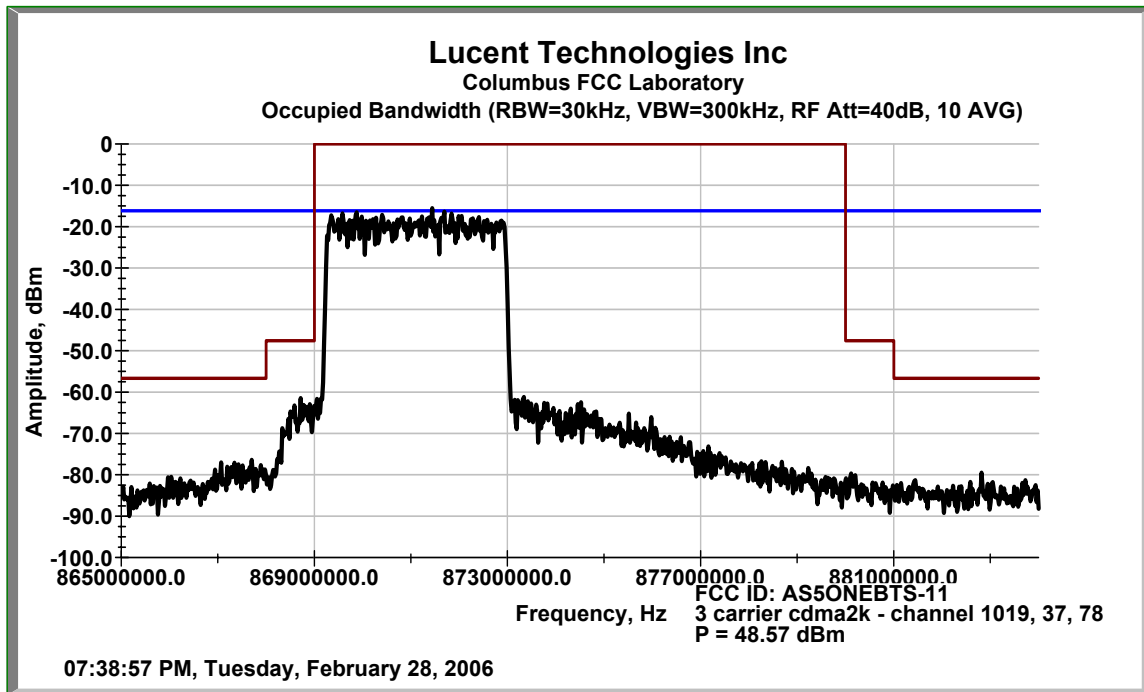


B3/B2 Band – Right Edge 2-carrier IS-856 (3G-1xEV)

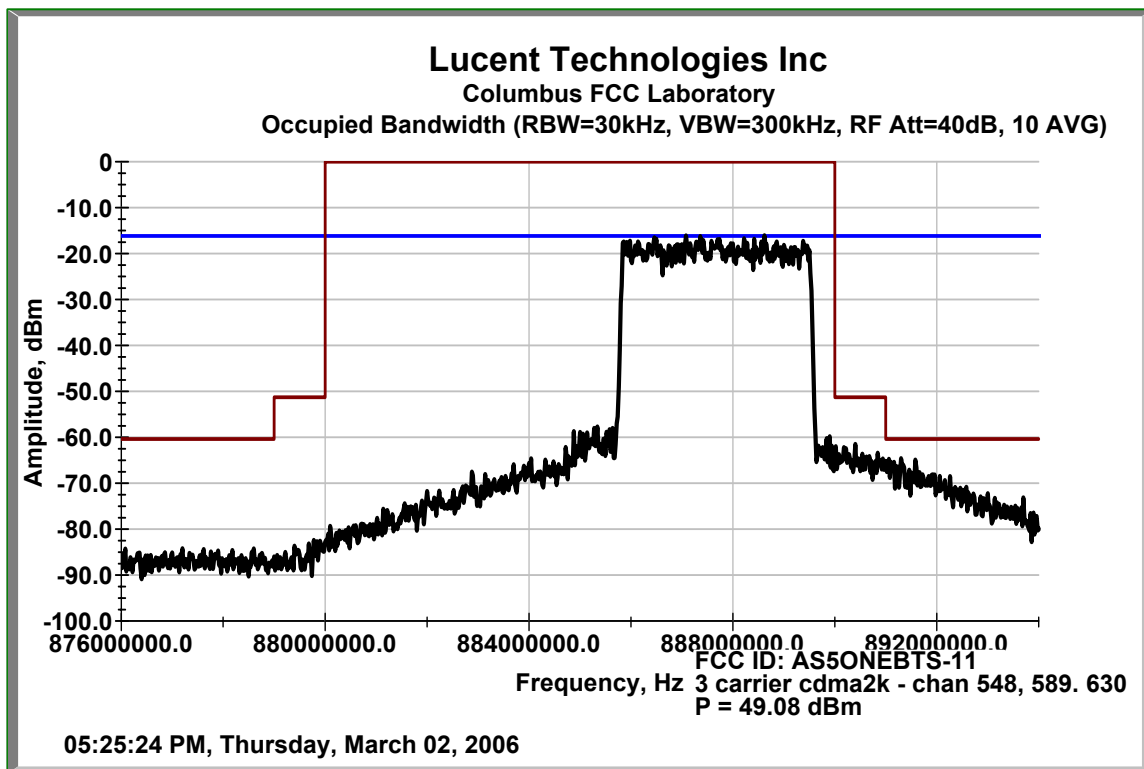




A²/A3/A2 Band – Left Edge 3-carrier cdma2000 (3G-1x)

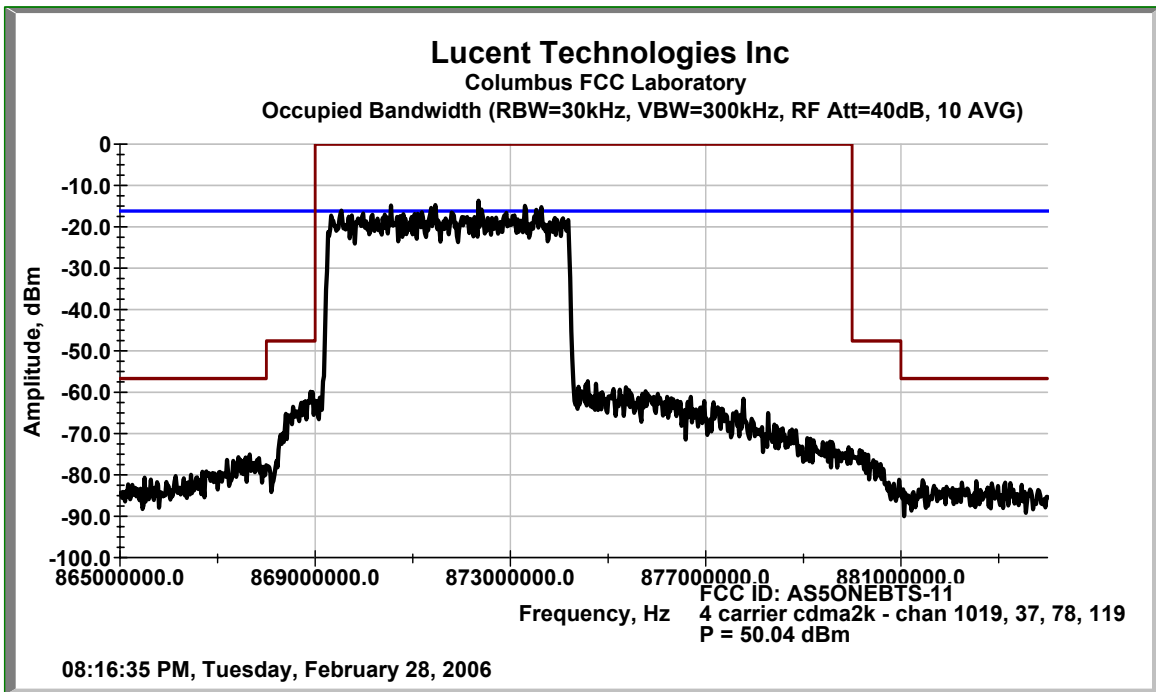


B3/B2 Band – Right Edge 3-carrier cdma2000 (3G-1x)

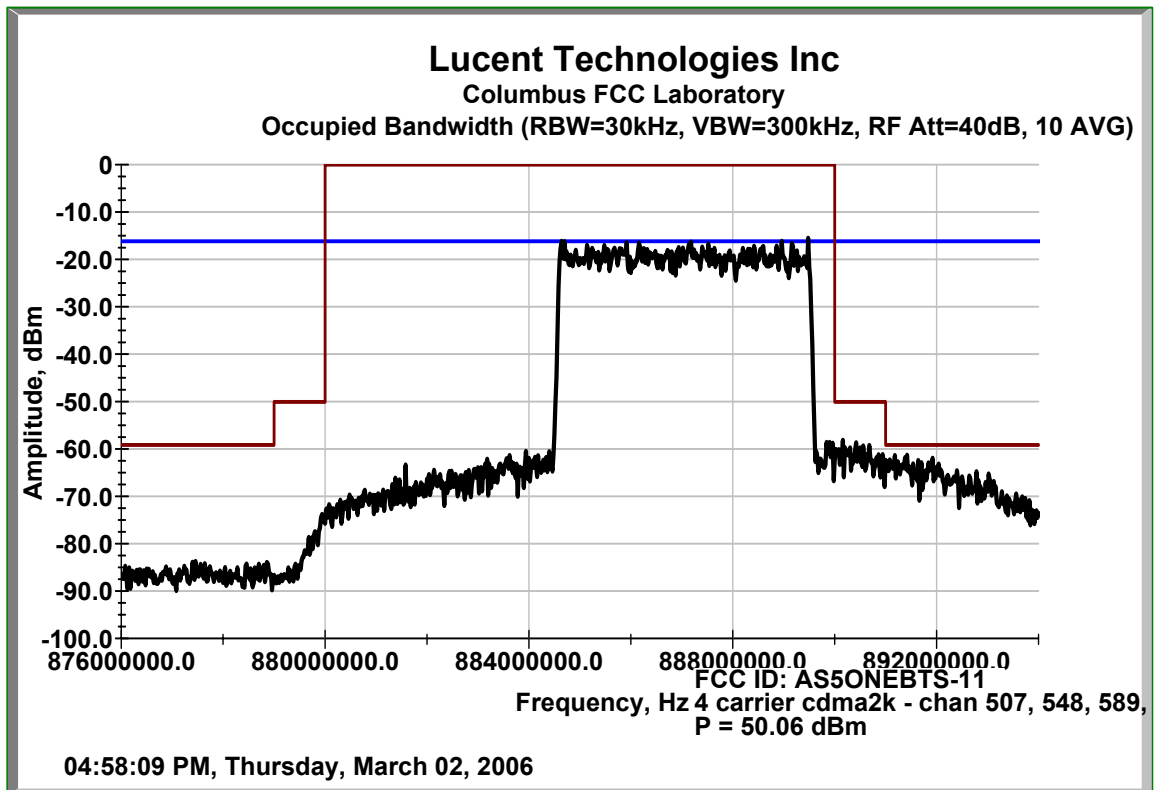




A"/A3/A2 Band – Left Edge 4-carrier cdma2000 (3G-1x)



B3/B2 Band – Right Edge 4-carrier cdma2000 (3G-1x)





SUBEXHIBIT 10.5

Section 2.1051 MEASUREMENT REQUIRED: SPURIOUS EMISSIONS AT THE ANTENNA TERMINALS

The spurious emissions at the end antenna connector (EAC) of the AS5ONEBTS-11 UMTS CDMA transceiver were investigated from 10 MHz to the 10th harmonic of the carrier or 10 GHz, per Section 2.1057(a)(1). The AS5ONEBTS-11 UMTS CDMA transceiver was configured in cdma2000 (3G-1x) mode with pilot, page, sync and traffic channels per 3GPP2 cdma2000 standards, or in IS856 (3G-1xEV) mode with pilot, MAC and data channels per 3GPP2 High Rate Packet Data standards.

The spurious emission measurements were made at the end antenna connector (EAC) of the AS5ONEBTS-11 UMTS CDMA transceiver from : 1. the lowest available cellular CDMA channels in the A band, Ch 1019 at 869.88 MHz, 2. two contiguous A band channels (A², A3) for IS-856 and two to four contiguous A band channels (A², A3) for cdma2000, 3. the highest available cellular CDMA channels in the B band, Ch 777 at 893.31 MHz (B¹), Ch 691 at 890.73 MHz (A¹), and Ch 630 at 888.90 MHz (B3) 4. two contiguous B band channels (B3, B2) for IS-856 and two to four contiguous B band channels (B3, B2) for cdma2000. The carrier power level at the end antenna connector (EAC) of the AS5ONEBTS-11 UMTS CDMA transceiver was transmitting to the maximum rated mean power.

The spurious emission limitations and the setting of measurement equipment for the spurious emissions measurement of a 1.23MHz CDMA cellular carrier were specified in Appendix A, Section 10 of FCC 02-229 Report and Order. FCC’s requirements are tabulated in the following table:

Table 11.4.1 FCC Part 22 Spurious Emission Limits

Frequency	Required Minimum Attenuation below the Mean Carrier Power <i>P</i>	Minimum Resolution Bandwidth of Spectrum Analyzer
1MHz Bands Immediately Outside the Transmitting Frequency Band	(43 + <i>P</i> dBW) dBc	12.3 kHz
Out-of-Band (other than above)	(43 + <i>P</i> dBW) dBc	100 kHz

Sections 2.1051 and 2.1057(c) specify that the spurious emissions attenuated more than 20 dB below the permissible value need not be reported.

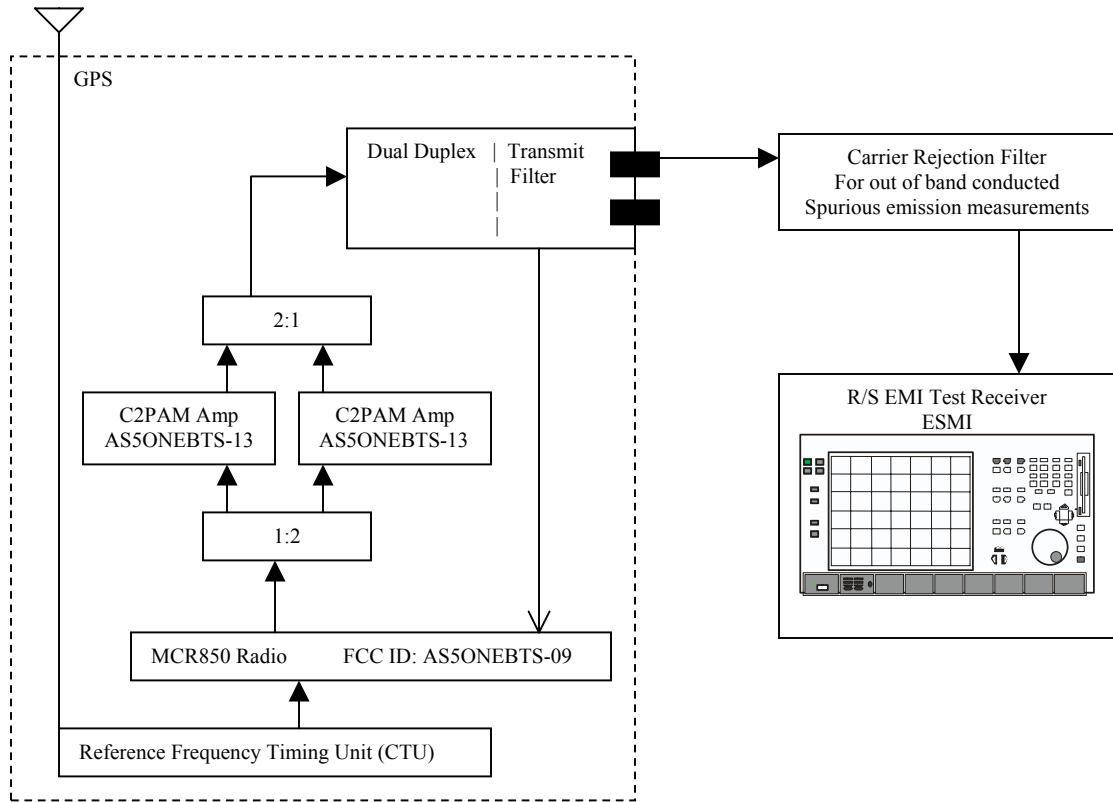
The measurements were performed with a Rohde & Schwarz ESMI Spectrum Analyzer which was calibrated in accordance with ISO 9001 process. The test set-up diagram is given in the following.

Results:

No reportable conducted spurious emissions were detected at the output terminal of the MCR850 transceiver during the entire spectrum investigated (10MHz to 10GHz). The measurement results of the AS5ONEBTS-08 MCR850 transceiver, subject of this application, demonstrate the full compliance with the Rules of the Commission of the Cellular bands.

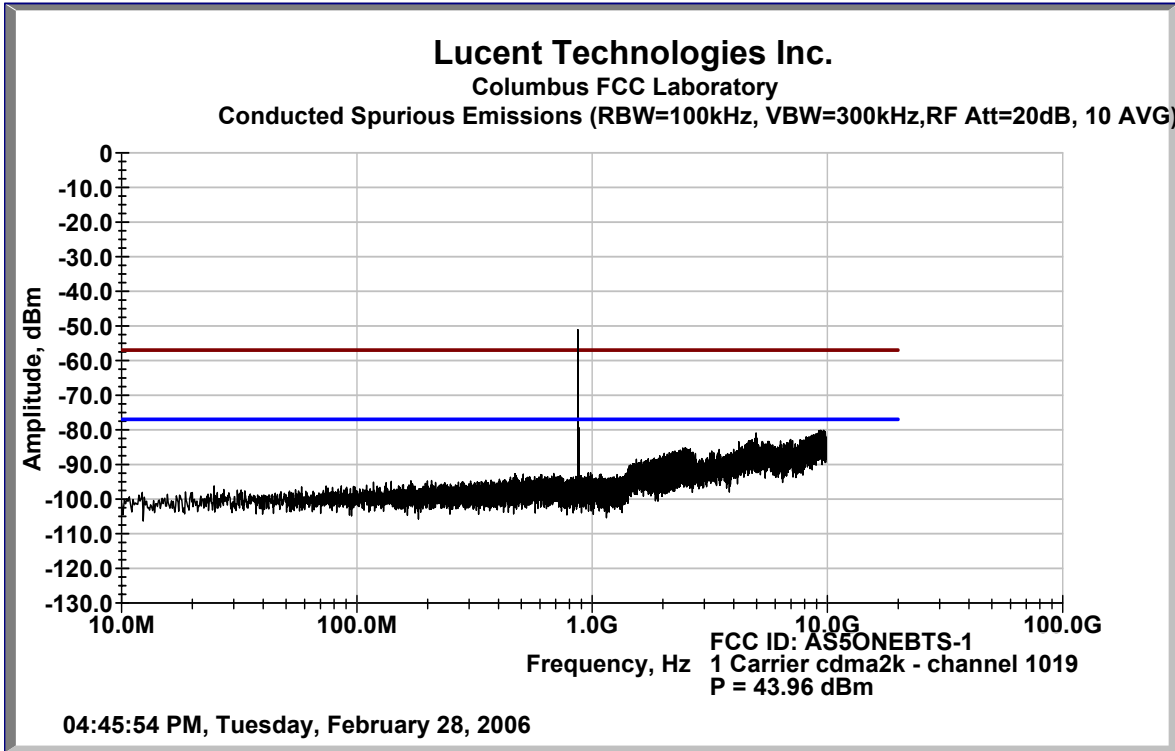


FIGURE 1104.1 TEST SET-UP FOR MEASUREMENT OF SPURIOUS EMISSIONS AT THE ANTENNA TERMINALS

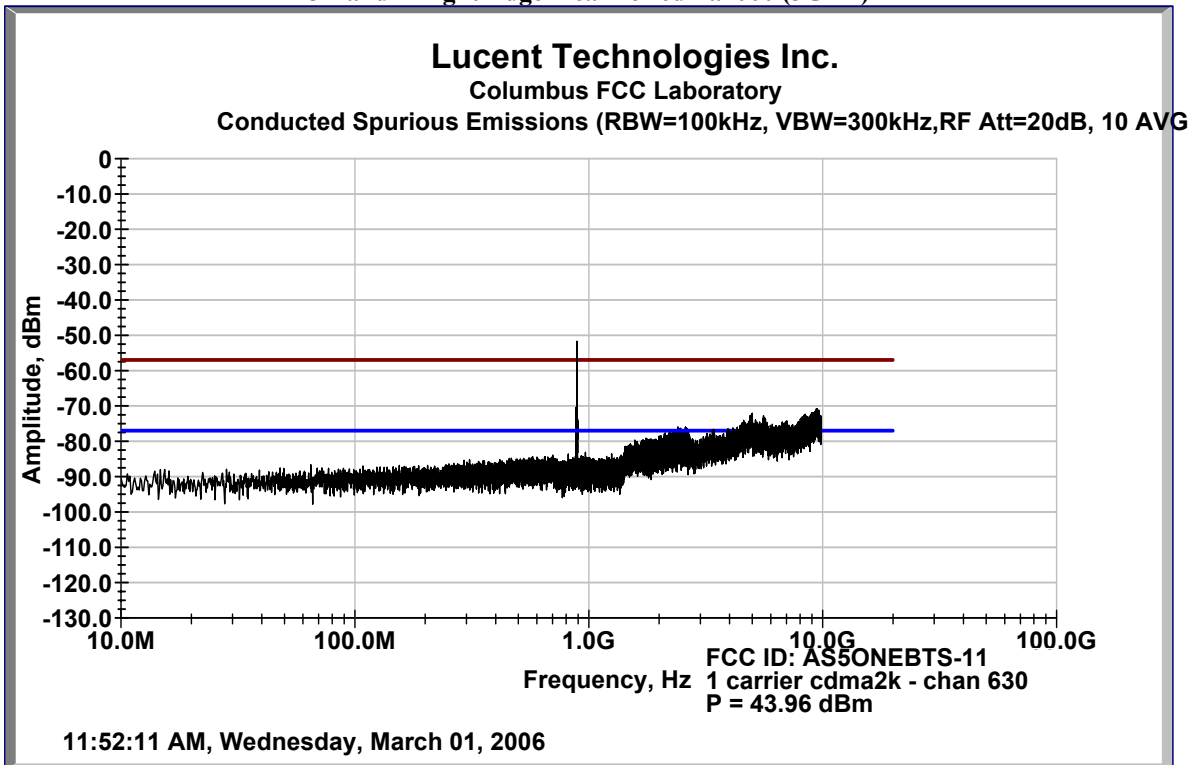




A” Band – Left Edge 1-carrier cdma2000 (3G-1x)

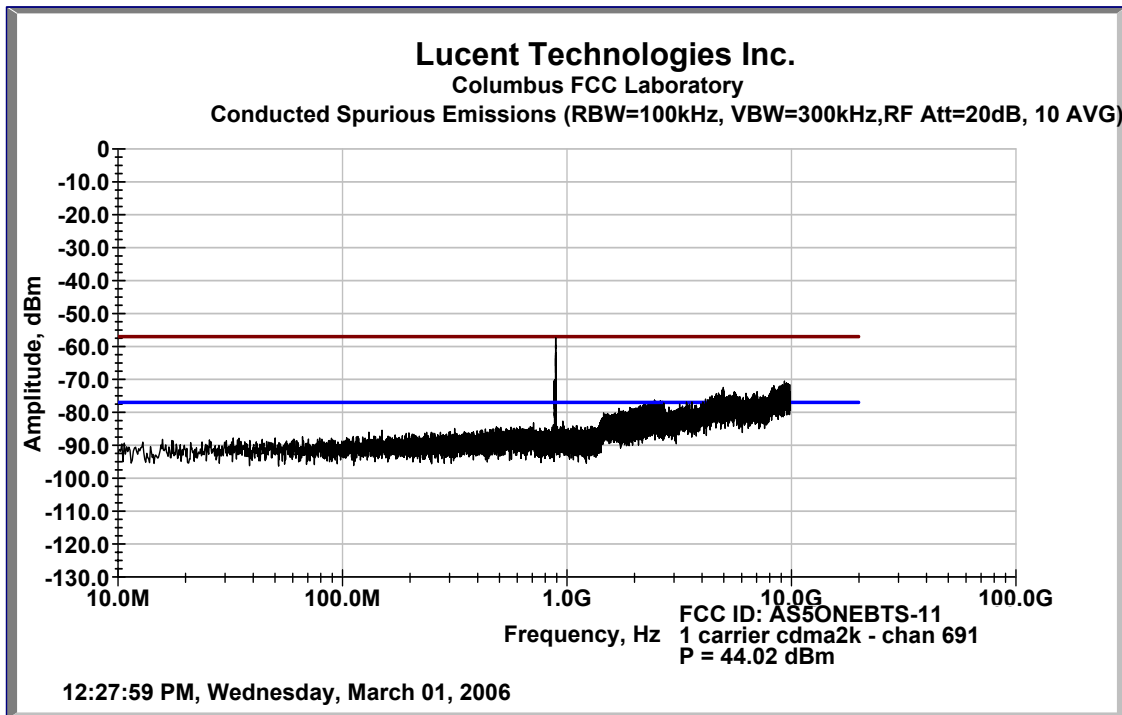


B3 Band – Right Edge 1-carrier cdma2000 (3G-1x)

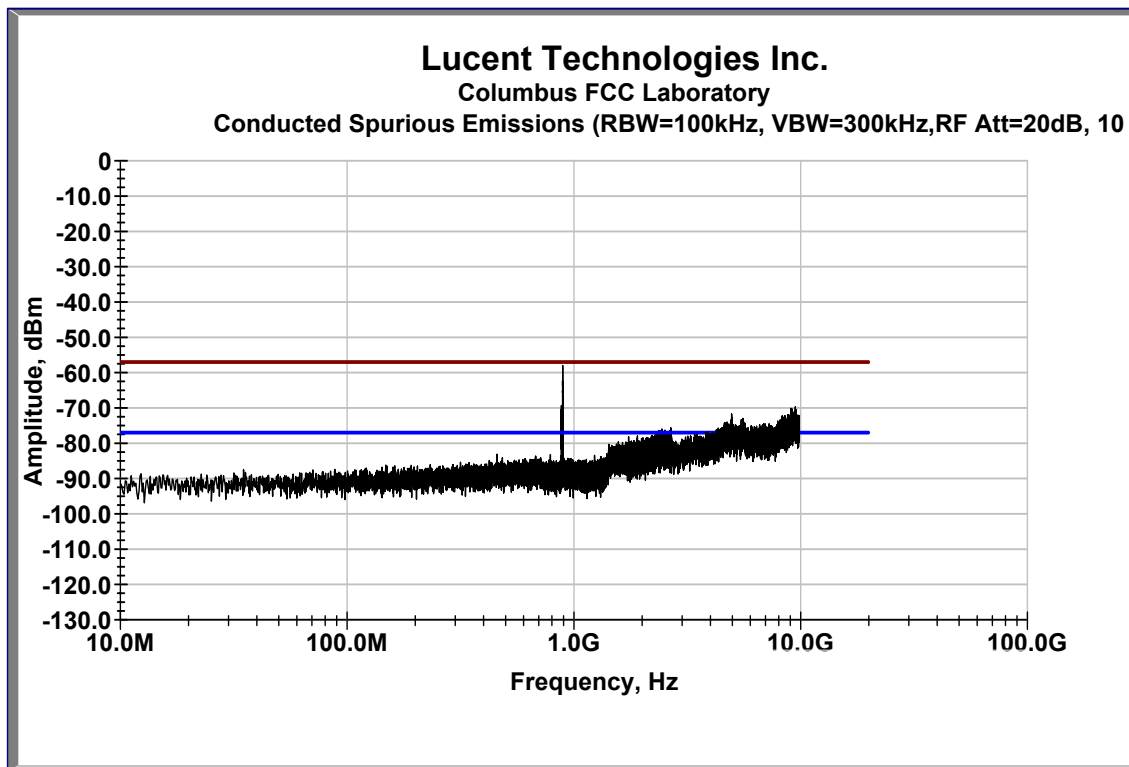




A' Band – Channel 691 1-carrier cdma2000 (3G-1x)

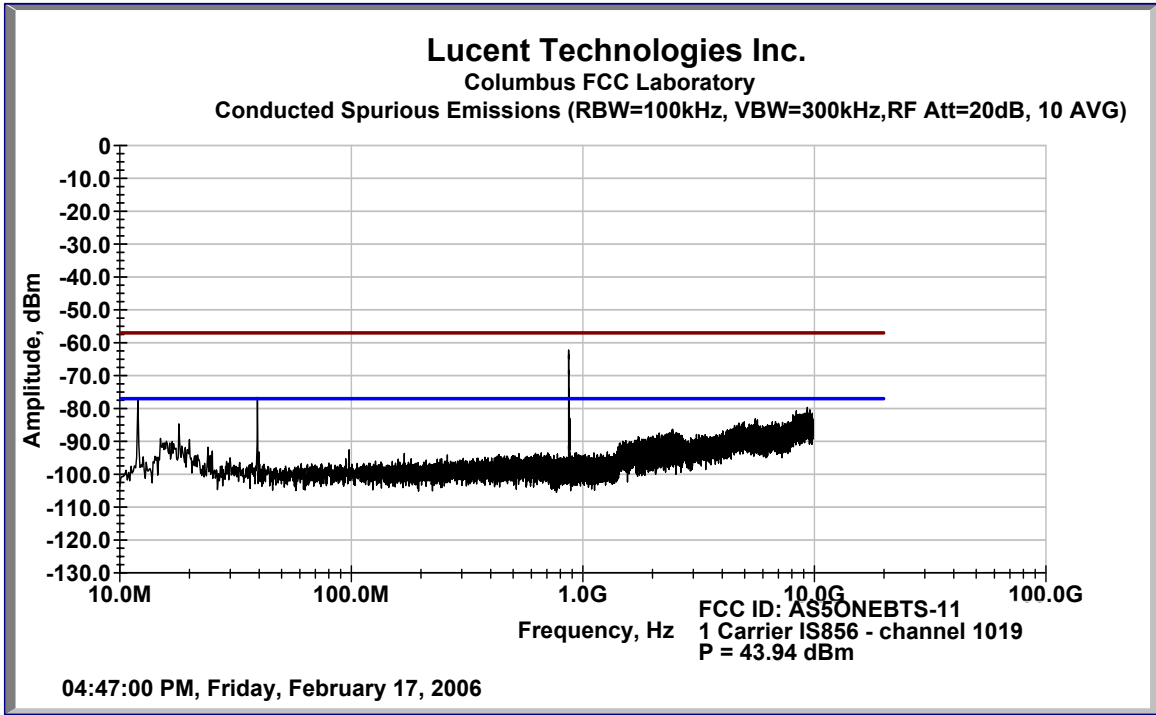


B' Band – Channel 777 1-carrier cdma2000 (3G-1x)

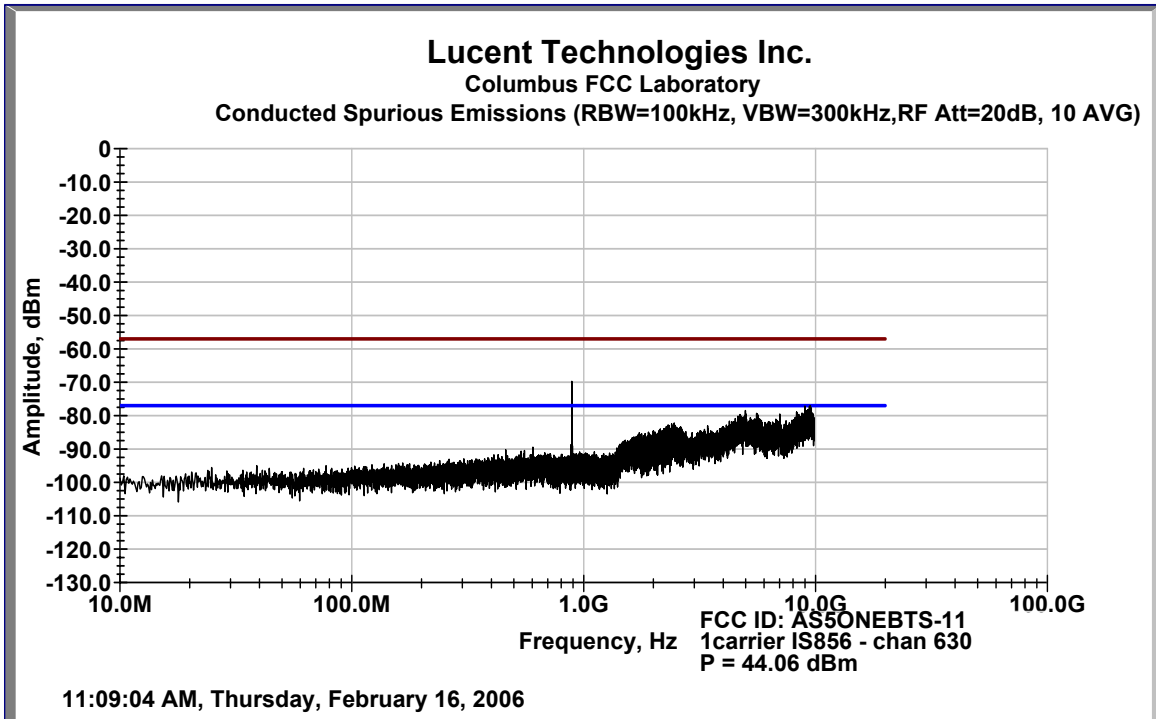




A” Band – Left Edge 1-carrier IS-856 (3G-1xEV)

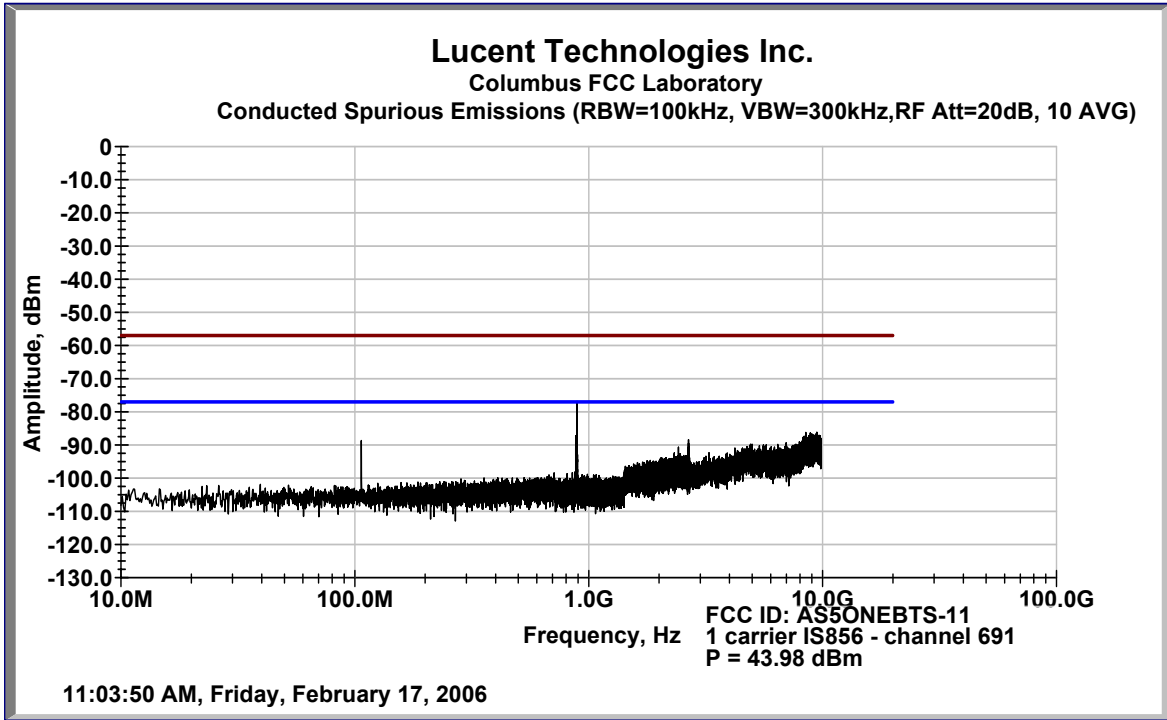


B3 Band – Right Edge 1-carrier IS-856 (3G-1xEV)





A' Band – Channel 691 1-carrier IS-856 (3G-1xEV)



B' Band – Channel 777 1-carrier IS-856 (3G-1xEV)

