

EXHIBIT 10: TEST REPORT

SYNOPSIS

The test report attached to this exhibit demonstrates that the Lucent Technologies' Cellular Frequency UMTS-CDMA Transceiver System (850), which is designed to operate in the Lucent UMTS Flexent® OneBTS™ 850 MHz Wireless Base Station, is in full compliance with all requirements of the Rules of the Commission as specified in the Code of Federal Regulations (CFR), Title 47 – Telecommunication; Part 22, Subpart H – Cellular Radiotelephone Service; Section 22.917 - Emission Limitations for Cellular Equipment; effective October 1, 2004. All testing was performed in accordance with CFR 47, Part 2, Subpart J – Equipment Authorization Procedures; effective October 1, 2004. It also demonstrates compliance with the spurious emissions limitations specified in ETSI TS 125 141 V5.9.0 (2004-09): Universal Mobile Telecommunications System (UMTS); Base Station Conformance Testing (FDD), (3GPP TS 25.141, Version 5.9.0, Release 5), which is the standard used as a guideline in the design of the MCR850 transceiver. The objective of this application is to obtain FCC initial authorization, under FCC ID: AS5ONEBTS-11, for operation in the Universal Mobile Telecommunications System (UMTS) with a single 5 MHz emission bandwidth carrier (4M10F9W) set to a maximum power level at the antenna terminal of 40 Watts (3-second), over the entire Cellular Frequency Spectrum 869-894 MHz.

The UMTS850 UMTS-CDMA Transceiver System (850) consists of the principle RF components: (1) Crystal Reference Oscillator Module (OMA) at 15 MHz, (2) UMTS-CDMA Multi-Carrier CDMA Radio (MCR850), Model BNJ65, which was previously authorized by the Federal Communications Commission under FCC ID: AS5ONEBTS-08, (3) single C2PAM power amplifiers per RF path, and (4) 25 MHz wide Dual Duplex (DDpx), low loss, transmit filters covering the cellular frequency spectrum: 869-894 MHz. These components are considered as a system due to (1) the DDpx filters providing RF feedback to the transceiver in the form of Closed Loop Gain Control (CLGC) to provide constant power over temperature, and (2) Lucent's proprietary Enhanced Digital Pre-Distortion (EDPD-UL) technology which enables software to communicate between the transceiver, power amplifier and the transmit filter to achieve this goal.

As a Transceiver System, all conducted RF characteristics and emissions measurements were performed at the transmit antenna terminal, using a production equipment frame. All testing was performed in the Lucent Technologies, Whippany, NJ, compliance laboratory by F. E. Chetwynd and M. P. Farina during the period June 13 to June 21, 2005; in adherence to a test plan generated by M. P. Farina, in accordance with Lucent's ISO/TL9000 Registration. All measurement instrumentation utilized were also calibrated in compliance with Lucent's ISO/TL9000 Registration. The Whippany 3 & 10 Meter Open Area Test Site (OATS) is authorized by the Federal Communications Commission (FCC) under Registration Number: 90770, in compliance with the requirements of Section 2.948 of the Rules of the Commission.

Frequency stability measurements were performed by M. Coelho, Lucent Technologies, Swindon, United Kingdom, under the direction of M. P. Farina, and in adherence to the previously cited ISO/TL9000 test plan. A full report is attached to this exhibit.

Lucent Technologies
Bell Labs Innovations



67 Whippany Road
Whippany, NJ 07981

Subject: **Application for FCC Initial Authorization, under
FCC ID: AS5ONEBTS-11, Covering the Cellular
Frequency UMTS-CDMA Transceiver System (850),
Operating Over the Spectrum 869-894 MHz with
a 5 MHz Carrier Emission Bandwidth.**

Michael P. Farina
JW10D0000
Telephone: 973-386-4344
mpfarina@lucent.com

June 22, 2005

TEST REPORT

INTRODUCTION:

The exhibits presented in this test report demonstrate that the Lucent Technologies' Cellular Frequency UMTS-CDMA Transceiver System (850), which is designed to operate in the Lucent UMTS Flexent® OneBTS™ 850 MHz Wireless Base Station, is in full compliance with all requirements of the Rules of the Commission as specified in the Code of Federal Regulations (CFR), Title 47 – Telecommunication; Part 22, Subpart H – Cellular Radiotelephone Service; Section 22.917 - Emission Limitations for Cellular Equipment; effective October 1, 2004. All testing was performed in accordance with CFR 47, Part 2, Subpart J – Equipment Authorization Procedures; effective October 1, 2004. It also demonstrates compliance with the spurious emissions limitations specified in ETSI TS 125 141 V5.9.0 (2004-09): Universal Mobile Telecommunications System (UMTS); Base Station Conformance Testing (FDD), (3GPP TS 25.141, Version 5.9.0, Release 5). This standard was the guideline used in the design of the MCR850 transceiver. The objective of this application is to obtain initial FCC authorization, under FCC ID: AS5ONEBTS-11, for operation in the Universal Mobile Telecommunications System (UMTS) with a single 5 MHz emission bandwidth carrier (4M10F9W) set to a maximum power level at the antenna terminal of 40 Watts (3-second), over the Cellular Frequency Spectrum 869-894 MHz.

The UMTS850 Transceiver System consists of the principle RF components: (1) Crystal Reference Oscillator Module (OMA) at 15 MHz, (2) UMTS-CDMA Multi-Carrier CDMA Radio (MCR850), Model BNJ65, which was previously authorized by the Federal Communications Commission under FCC ID: AS5ONEBTS-08, (3) single C2PAM power amplifier per RF path, and (4) 25 MHz wide Dual Duplex (DDpx), low loss, transmit filters covering the cellular frequency spectrum: 869-894 MHz. These components are considered as a system due to (1) the DDpx filters providing RF feedback to the transceiver in the form of Closed Loop Gain Control (CLGC) to provide constant power over temperature, and (2) Lucent's proprietary Enhanced Digital Pre-Distortion (EDPD-UL) technology which enables software to communicate between the transceiver, power amplifier and the transmit filter to achieve this goal.

As a Transceiver System, all conducted RF characteristics and emissions measurements were performed at the transmit antenna terminal, using a production equipment frame. All testing was performed in the Lucent Technologies, Whippany, NJ, compliance laboratory by F. E. Chetwynd and M. P. Farina during the period June 13 to June 21, 2005; in adherence to a test plan generated by M. P. Farina, in accordance with Lucent's ISO/TL9000 Registration. All measurement instrumentation utilized were also calibrated in compliance with Lucent's ISO/TL9000 Registration. The Whippany 3 & 10 Meter Open Area Test Site (OATS) is authorized by the Federal Communications Commission (FCC) under Registration Number: 90770, in compliance with the requirements of Section 2.948 of the Rules of the Commission.

Lucent Technologies Inc. - Proprietary
Use pursuant to Company Instructions.

Frequency stability measurements were performed by M. Coelho, Lucent Technologies, Swindon, United Kingdom, under the direction of M. P. Farina, and in adherence to the previously cited ISO/TL9000 test plan. A full report is attached to this exhibit.

This report fully documents all required tests and the test results, sufficient to show full compliance with the Rules of the Commission.

APPLICABLE FCC RULES AND INDUSTRY STANDARDS:

The exhibits presented in this test report demonstrate that the Lucent Technologies' Cellular Frequency UMTS-CDMA Transceiver System (850), which is designed to operate in the Lucent UMTS Flexent® OneBTS™ 850 MHz Wireless Base Station, is in full compliance with all requirements of the Rules of the Commission as specified in the Code of Federal Regulations (CFR), Title 47 – Telecommunication; Part 22, Subpart H – Cellular Radiotelephone Service; Section 22.917 - Emission Limitations for Cellular Equipment; effective October 1, 2004. All testing was performed in accordance with CFR 47, Part 2, Subpart J – Equipment Authorization Procedures; effective October 1, 2004. It also demonstrates compliance with the spurious emissions limitations specified in ETSI TS 125 141 V5.9.0 (2004-09): Universal Mobile Telecommunications System (UMTS); Base Station Conformance Testing (FDD), (3GPP TS 25.141, Version 5.9.0, Release 5). The specific test procedures that are both required for and are applicable to the UMTS850 Transceiver System are:

Part 2.1046	RF Power Output	Pages 4 – 5
Part 2.1047	Modulation Characteristics	Pages 6-11
Part 2.1049	Occupied Bandwidth	Pages 12-26
Part 2.1051	Spurious Emissions at the Antenna Terminals.	Pages 27-38
Part 2.1053	Field Strength of Spurious Radiation	Pages 39
Part 2.1055	Frequency Stability	Pages 40-64
Part 2.1057	Frequency Spectrum to be Investigated	
Part 22	Public Mobile Services; Subpart H – Cellular Radiotelephone Service	
Part 22.917	Emission Limitations for Cellular Equipment	
ETSI	TS 125 141 V5.9.0 (2004-09): Universal Mobile Telecommunications System (UMTS); Base Station (BS) Conformance Testing (FDD), (3GPP TS 25.141, Version 5.9.0, Release 5).	
ETSI	TS 125 104 V6.7.0 (2004-09): Universal Mobile Telecommunications System (UMTS); Base Station (BS) Radio Transmission and Reception (FDD), (3GPP TS 25.104, Version 6.7.0, Release 6).	
ANSI C63.4-2003	American National Standard for Methods of Measurement of Radio-Noise Emissions from Low-Voltage Electrical and Electronic in the Range of 9 kHz to 40 GHz; January 30, 2004	

PART 2.1046 MEASUREMENTS REQUIRED: RF POWER OUTPUT

The Cellular Frequency UMTS-CDMA Transceiver System (850), subject of this application for certification, is designed to provide a maximum RF power level, per single 5 MHz emission bandwidth carrier, of 40 Watts (+46 dBm) at the Equipment Antenna Terminal (EAC). This System is designed to operate in the cellular frequency spectrum: 869-894 MHz. A 25 MHz Wideband, Low Loss, Dual Duplex (DDpx) transmit filter is incorporated into this System for each of the 3 sectors. All conducted emission measurements are performed at the EAC. Five 5 MHz UMTS carrier channels were used throughout this test procedure, as tabulated below, to represent the lowest and the highest settable channels in the Cellular Frequency Band in the A and B sub-bands. Each time the carrier is set to each of the channels, the power level is adjusted, by software control, to +46 dBm (40 Watts at 3-second average) before performing each emission measurements. The carrier modulation is set to the full 24 Codes, as required by ETSI Test Model 5 for Voice + HSDPA (High Speed Downlink Packet Access).

Cellular Frequency Band	UMTS850 Carrier	Single Carrier Bandwidth	UARFCN Channel Number	UMTS Carrier Center Frequency	Measured Power Level
A	Lowest Settable for A-Band and to 869 MHz Band Edge	5 MHz	1007	871.5 MHz	+46 dBm
A	Highest Settable for A-Band	5 MHz	1037	877.5 MHz	+46 dBm
B	Lowest Settable for B-Band	5 MHz	1062	882.5 MHz	+46 dBm
B	Highest Settable for B-Band	5 MHz	1087	877.5 MHz	+46 dBm
B'	Highest Settable to 894 MHz Band Edge	5 MHz	1107	891.5 MHz	+46 dBm

Note: UARFCN = UTRA Absolute Radio Frequency Channel Number

These five frequencies are used for all of the conducted emission tests that follow.

Results: The 5 MHz UMTS 850 Transceiver System is compliant with the manufacturer's rated power level at the transmit antenna terminal for the above listed carrier frequencies.

Block Diagram Of The Power Measurement Test Set-Up And Test Equipment Configuration for the Lucent UMTS Flexent® OneBTS™ 850 MHz Wireless Base Station

40 Watt (+46 dBm) Average at Antenna Terminal

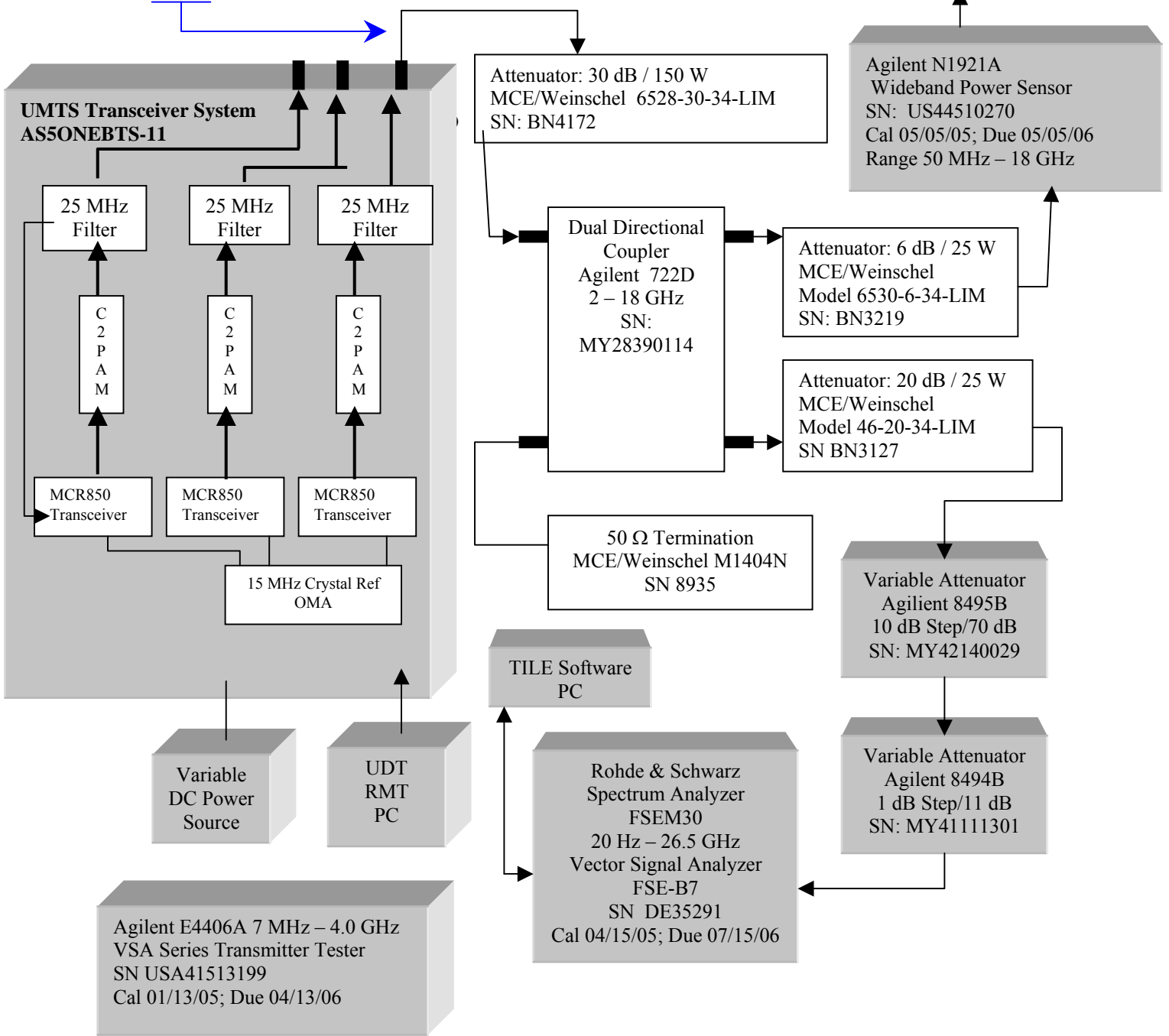

PART 2.1047 MEASUREMENTS REQUIRED: MODULATION CHARACTERISTICS

The modulation accuracy was measured at the Equipment Antenna Terminal (EAC) for each of the five UMTS 850 carriers UARFCN 1007, 1037, 1062, 1087 & 1107. ETSI TS 25.141 requires that the Error Vector Magnitude (EVM) be measured using a single active channel (SCH) with Test Model 4 (TM4) modulation; and the power level set to Pmax – 18 dB (+46 dBm- 18 dB = +28 dBm). The requirement is that the Error Vector Magnitude (EVM) be less than 17.5% rms. The test equipment used was an Agilent E4406A VSA Series Transmitter Tester (SN US41513199).

RMS Error Vector Magnitude (EVM) Measurement Summary at the Antenna Terminal:

Cellular Frequency Band	UMTS850 Carrier	Single Carrier Bandwidth	UARFCN Channel Number	UMTS Carrier Center Frequency	Modulation Accuracy EVM
A	Lowest Settable for A-Band and to 869 MHz Band Edge	5 MHz	1007	871.5 MHz	3.60 % rms
A	Highest Settable for A-Band	5 MHz	1037	877.5 MHz	1.67 % rms
B	Lowest Settable for B-Band	5 MHz	1062	882.5 MHz	1.13 % rms
B	Highest Settable for B-Band	5 MHz	1087	877.5 MHz	1.90 % rms
B'	Highest Settable to 894 MHz Band Edge	5 MHz	1107	891.5 MHz	5.95 % rms

Minimum Standard Requirement: The minimum standard requirement is that the RMS Error Vector Magnitude (EVM) shall be less than 17.5%.

Test Set-up and Configuration: Same as previously used for Part 2.1046 RF Power Measurement, with exception that the FSEM30 Spectrum Analyzer is replaced by:

- 1) Agilent E4406A VSA Series Transmitter Tester, 7 MHz – 4.0 GHz, SN US41513199

RESULTS: The UMTS850 UMTS-CDMA Transceiver System (850) demonstrated full compliance with the modulation accuracy requirements specified in ETSI TS 25.141. All 5 channels were less than the 17.5% rms limitation. The plots for each channel are included in this exhibit as shown below.

Modulation Characteristics: UARFCN Channel Number 1007 @ 871.50 MHz
Tx Antenna Terminal at +28 dBm per single 5 MHz carrier

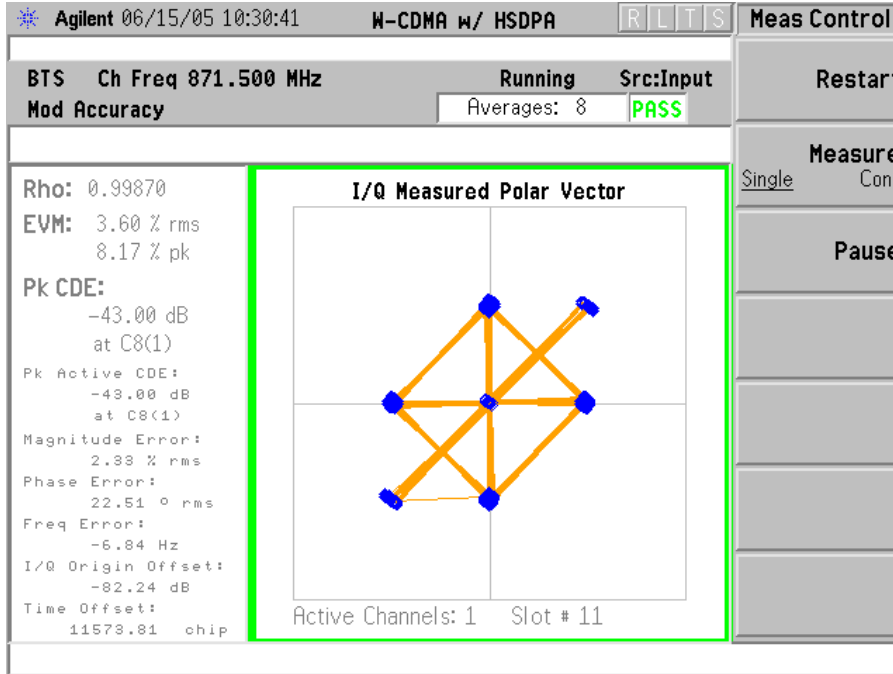

Modulation Characteristics: UARFCN Channel Number 1037 @ 877.50 MHz
Tx Antenna Terminal at +28 dBm per single 5 MHz carrier

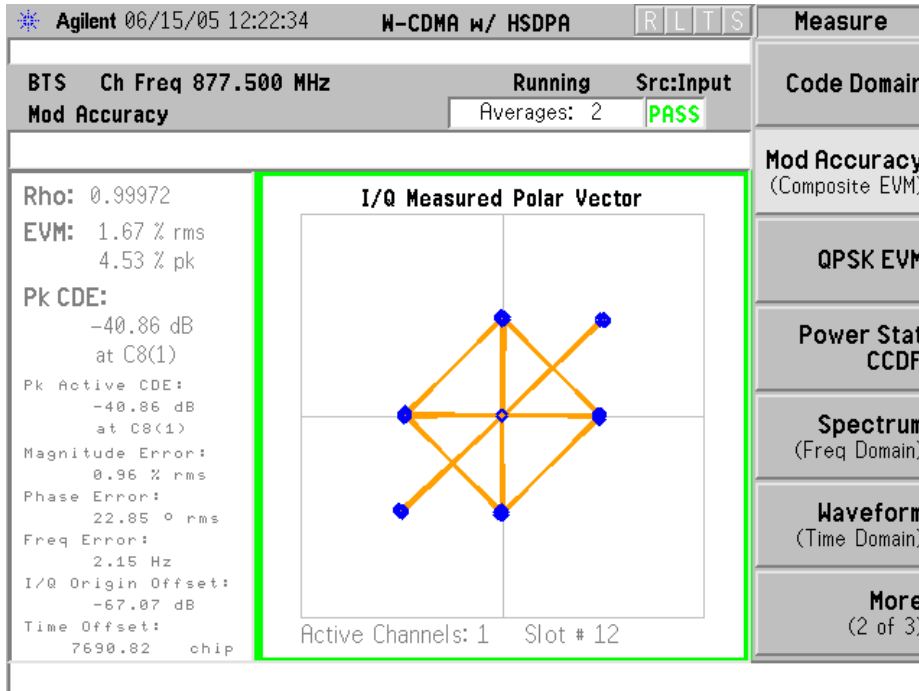

Modulation Characteristics: UARFCN Channel Number 1062 @ 882.50 MHz
Tx Antenna Terminal at +28 dBm per single 5 MHz carrier

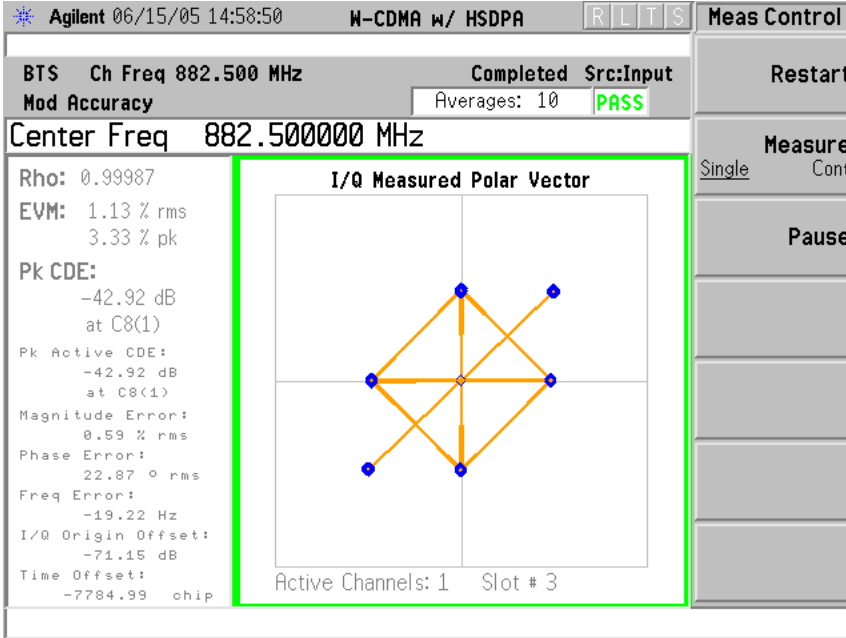

Modulation Characteristics: UARFCN Channel Number 1087 @ 887.50 MHz
Tx Antenna Terminal at +28 dBm per single 5 MHz carrier

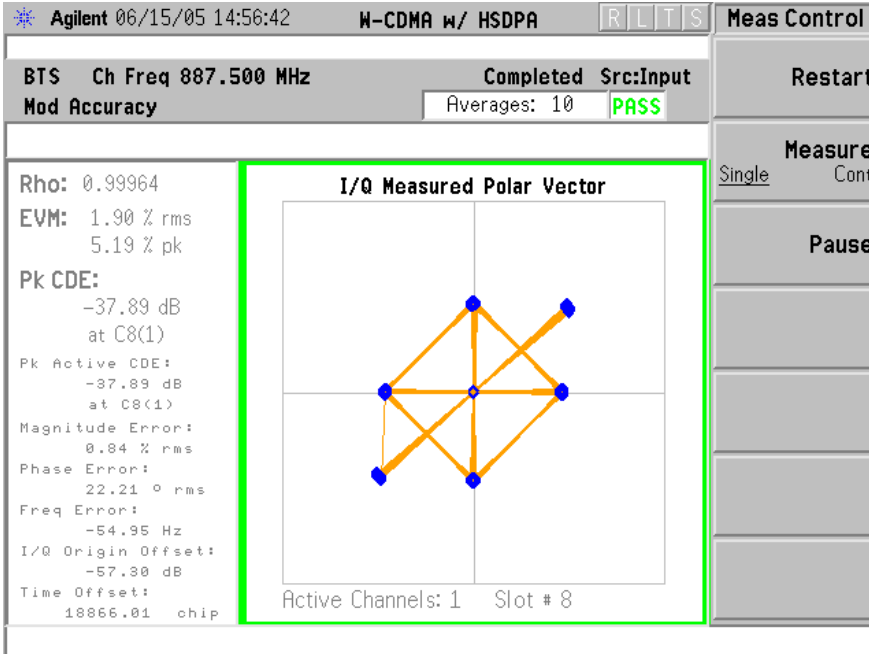

Modulation Characteristics: UARFCN Channel Number 1107 @ 891.50 MHz
Tx Antenna Terminal at +28 dBm per single 5 MHz carrier

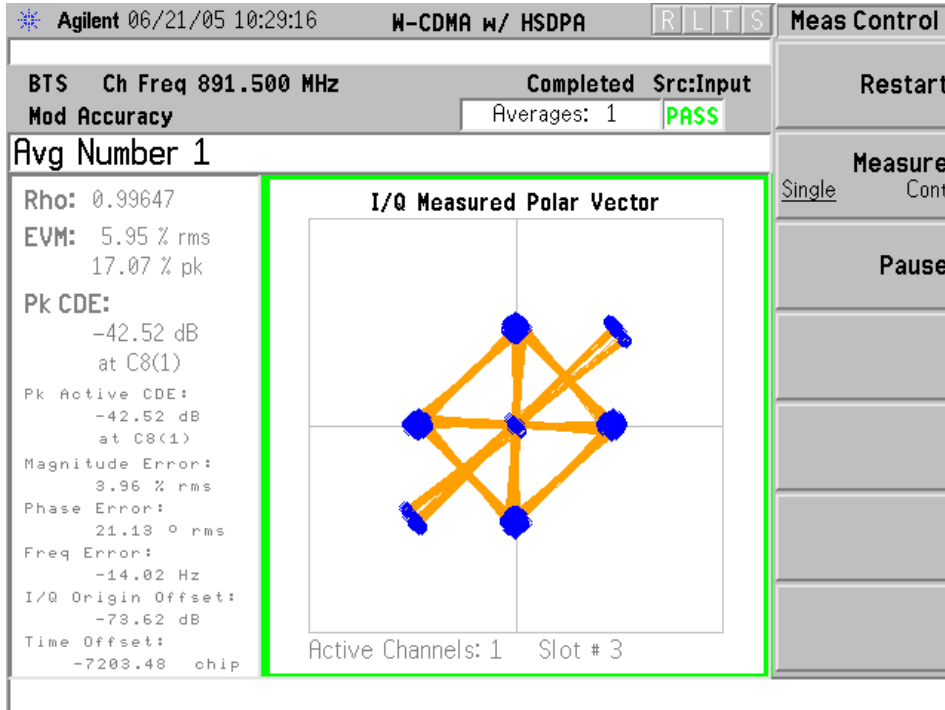

PART 2.1049 MEASUREMENTS REQUIRED: OCCUPIED BANDWIDTH

The occupied bandwidth was measured at the Equipment Antenna Terminal (EAC) for each of the five, UMTS 850, 5 MHz carriers. The power level was set to 40 Watts (+46 dBm) and the modulation set to Voice + HSDPA (High Speed Downlink Packet Access) to provide 24 active channels, as required for ETSI TS 25.141 Test Model 5 modulation.

The occupied bandwidth was measured by two methods:

1. The carrier 99% power bandwidth, which is also the necessary bandwidth, using an Agilent E4406A VSA Series Transmitter Tester (SN US41513199).
2. Emission mask limitation using a Rohde & Schwarz: Spectrum Analyzer FSEM30 (SN DE35291), to demonstrate compliance with the ETSI TS 25.141 emission mask requirements and with Part 24.238.
- 3.

Method 1: The carrier 99% power bandwidth was measured at the Equipment Antenna Terminal (EAC) with the 5 MHz carrier set to +46 dBm and modulated with the full 24 active channels. The measurement results show that the carrier is within the manufacturer’s rated 5 MHz bandwidth for all five carriers measured, as tabulated below. Measurements were performed for 5 carriers in one sector of this 3S1C equipment frame configuration. The RF path for all 3 sectors was identical. The actual data plots are attached to this exhibit.

Cellular Frequency Band	UMTS850 Carrier	Single Carrier Bandwidth	UARFCN Channel Number	UMTS Carrier Center Frequency	Measured Carrier 99% Power Bandwidth
A	Lowest Settable for A-Band and to 869 MHz Band Edge	5 MHz	1007	871.5 MHz	4.0930 MHz
A	Highest Settable for A-Band	5 MHz	1037	877.5 MHz	4.0971 MHz
B	Lowest Settable for B-Band	5 MHz	1062	882.5 MHz	4.0960 MHz
B	Highest Settable for B-Band	5 MHz	1087	877.5 MHz	4.1092 MHz
B'	Highest Settable to 894 MHz Band Edge	5 MHz	1107	891.5 MHz	4.0972 MHz

Results: For each UMTS1900 channel, the carrier does not exceed 5.0 MHz.
 The average and range of 99% power bandwidths/necessary bandwidths are:

Average	4.0985
Max	4.1092
Min	4.0930

Carrier Bandwidth Characteristics: UARFCN Channel Number 1007 @ 871.50 MHz
Tx Antenna Terminal at +46 dBm per single 5 MHz carrier

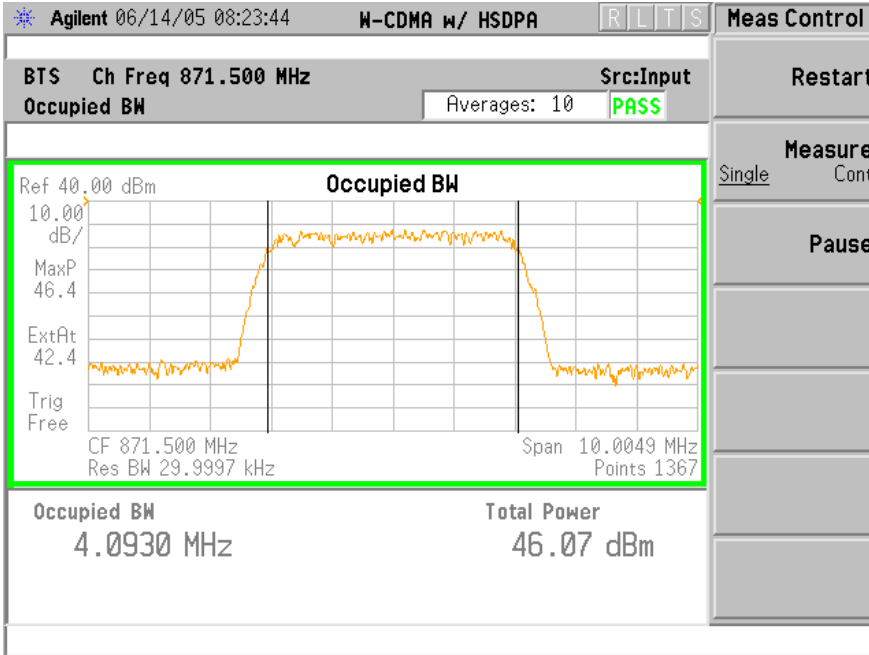

Carrier Bandwidth Characteristics: UARFCN Channel Number 1037 @ 877.50 MHz
Tx Antenna Terminal at +46 dBm per single 5 MHz carrier

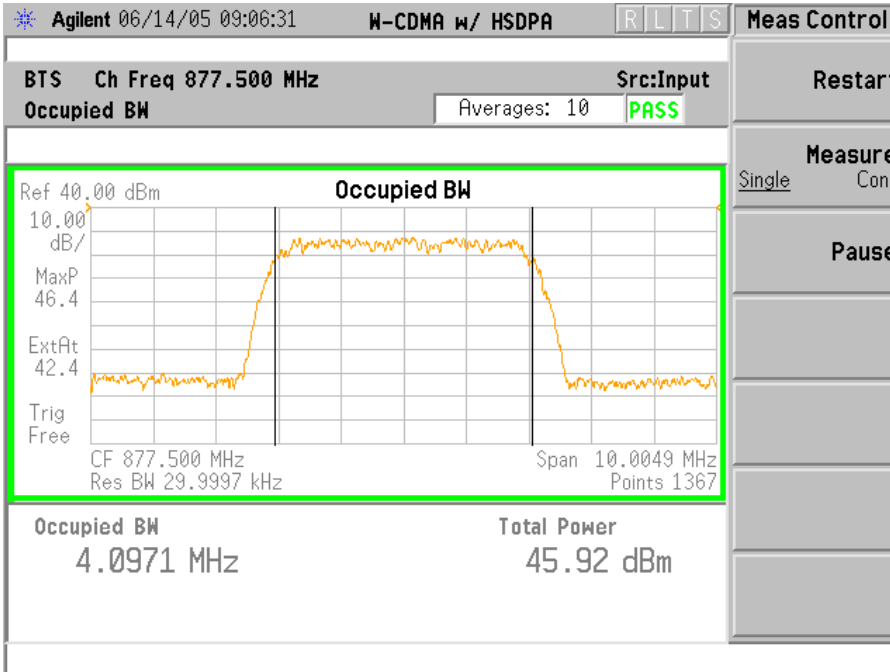

Carrier Bandwidth Characteristics: UARFCN Channel Number 1062 @ 882.50 MHz
Tx Antenna Terminal at +46 dBm per single 5 MHz carrier

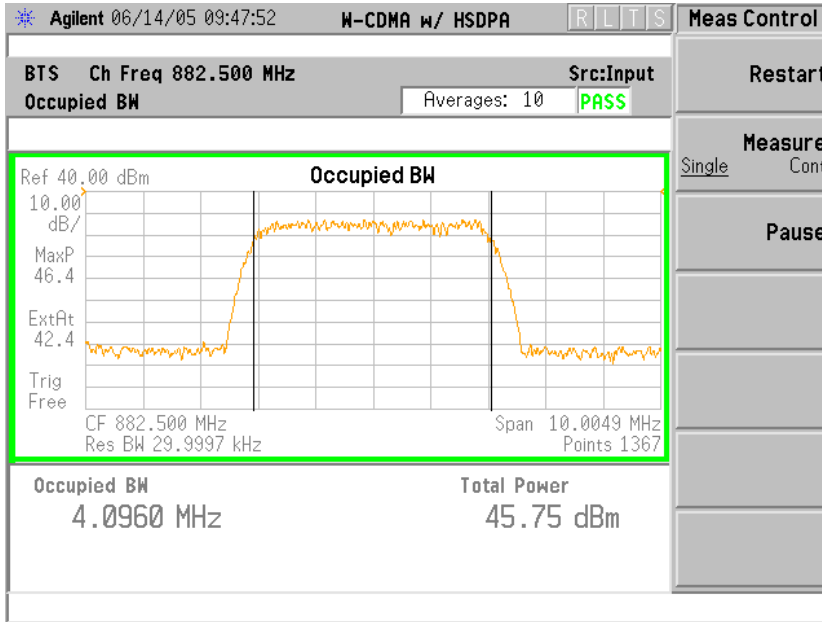

Carrier Bandwidth Characteristics: UARFCN Channel Number 1087 @ 887.50 MHz
Tx Antenna Terminal at +46 dBm per single 5 MHz carrier

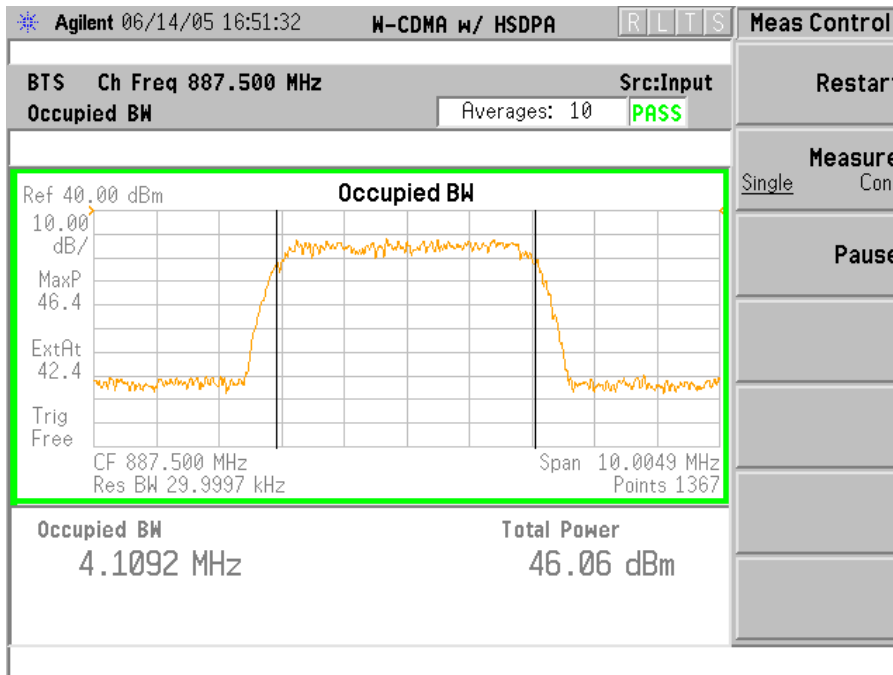

Carrier Bandwidth Characteristics: UARFCN Channel Number 1107 @ 891.50 MHz
Tx Antenna Terminal at +46 dBm per single 5 MHz carrier

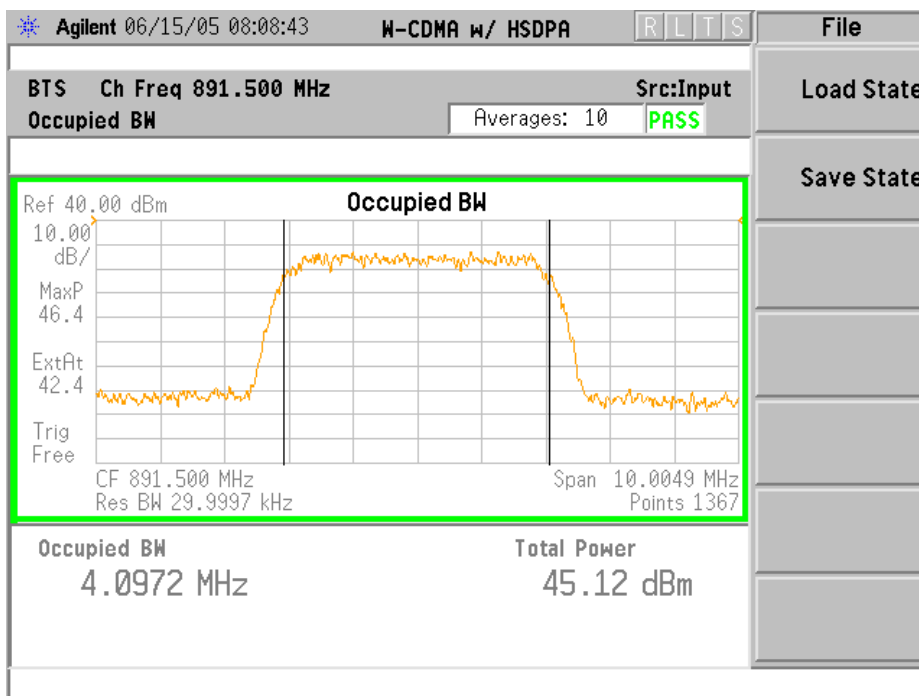

Method 2. Emission mask limitation using a Rohde & Schwarz: Spectrum Analyzer FSEM30 (SN DE35291) with Total Integrated Laboratory Environment (TILE) test software.

Measurement of the occupied bandwidth emission characteristics was performed at the Equipment Antenna Terminal (EAC) with the 5 MHz carrier set to +46 dBm, and the modulation set to Voice + HSDPA to provide 24 active channels as required by ETSI TS 25.141, Test Model 5, for all five carriers measured. In compliance with Part 22.917, the lowest and the highest settable channels in the cellular frequency band and in the A & B Sub-bands. The same UARFCN channels as used previously, will be repeated. The emission mask used to demonstrate compliance was as specified in ETSI TS 25.141 for $P \geq +43$ dBm. The mask attenuation values were based on a 30 kHz resolution bandwidth, which made the modulated 5 MHz carrier to be offset from +46 dBm by -22.2 dB, in accordance with the equation:

$$\text{Carrier Offset} = 10 \log (30 \text{ kHz}/5 \text{ MHz}) = -22.2 \text{ dB}$$

This series of measurements were performed using the EMC software:

Total Integrated Laboratory Environment (TILE)
By Quantum Change/EMC Systems, Inc.

The data/measurement plots for the five channels are attached below.

Test Set-up and Configuration: Same as previously used for Part 2.1046 RF Power Measurement.

RESULTS: The UARFCN 1007, 1037, 1062, 1087 & 1107 channels all demonstrate compliance with the emission mask specified by ETSI TS 25.141; the carriers do not exceed the mask limitation.

The data plots are attached below.

Occupied Bandwidth Characteristics: UARFCN Channel Number 1007 @ 871.50 MHz
Tx Antenna Terminal at +46 dBm per single 5 MHz carrier

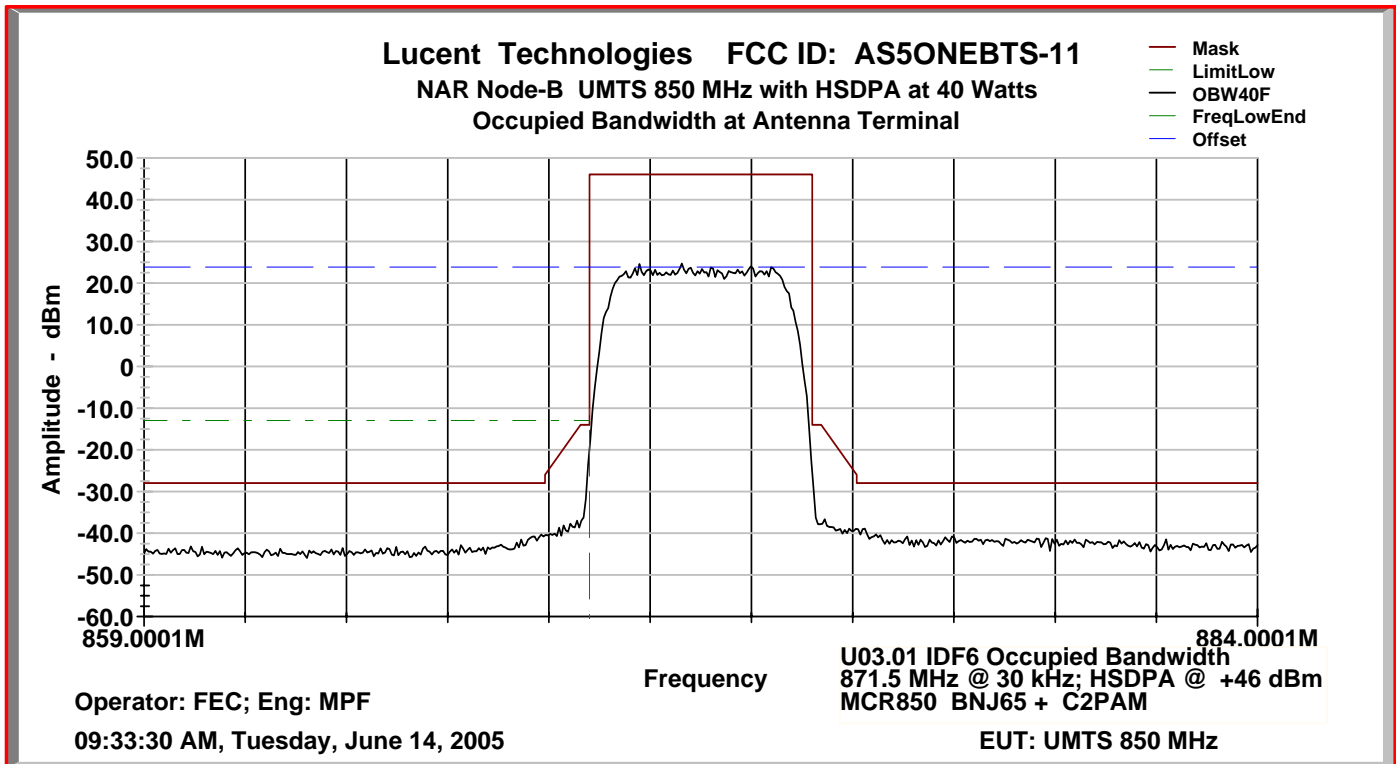

Occupied Bandwidth Characteristics: UARFCN Channel Number 1037 @ 877.50 MHz
Tx Antenna Terminal at +46 dBm per single 5 MHz carrier

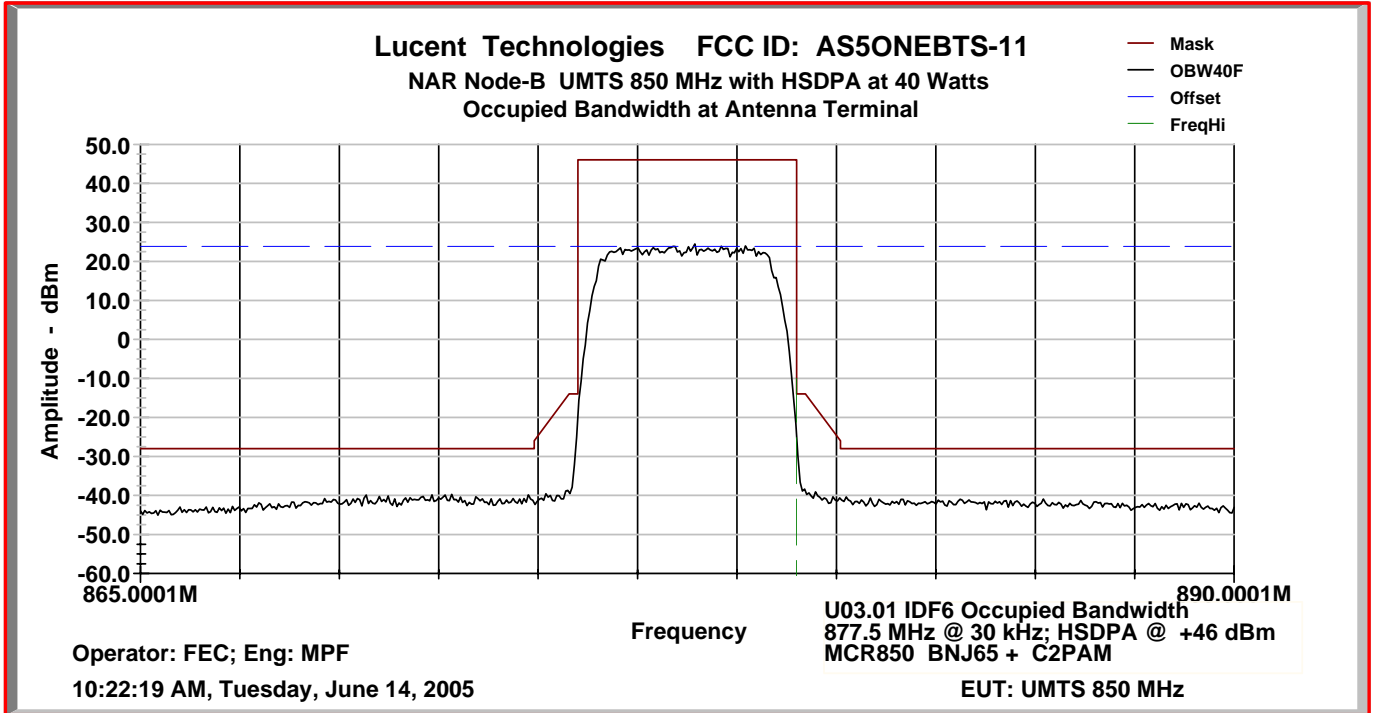

Occupied Bandwidth Characteristics: UARFCN Channel Number 1062 @ 882.50 MHz
Tx Antenna Terminal at +46 dBm per single 5 MHz carrier

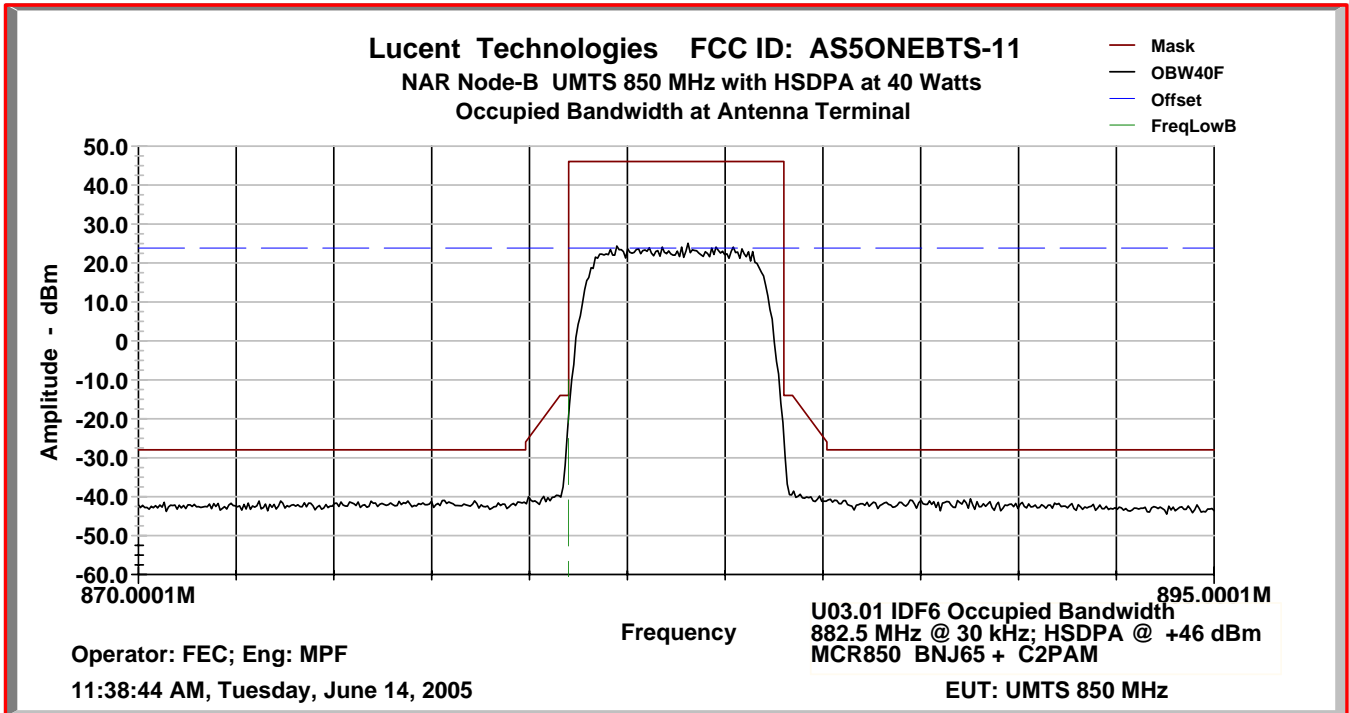

Occupied Bandwidth Characteristics: UARFCN Channel Number 1087 @ 887.50 MHz
Tx Antenna Terminal at +46 dBm per single 5 MHz carrier

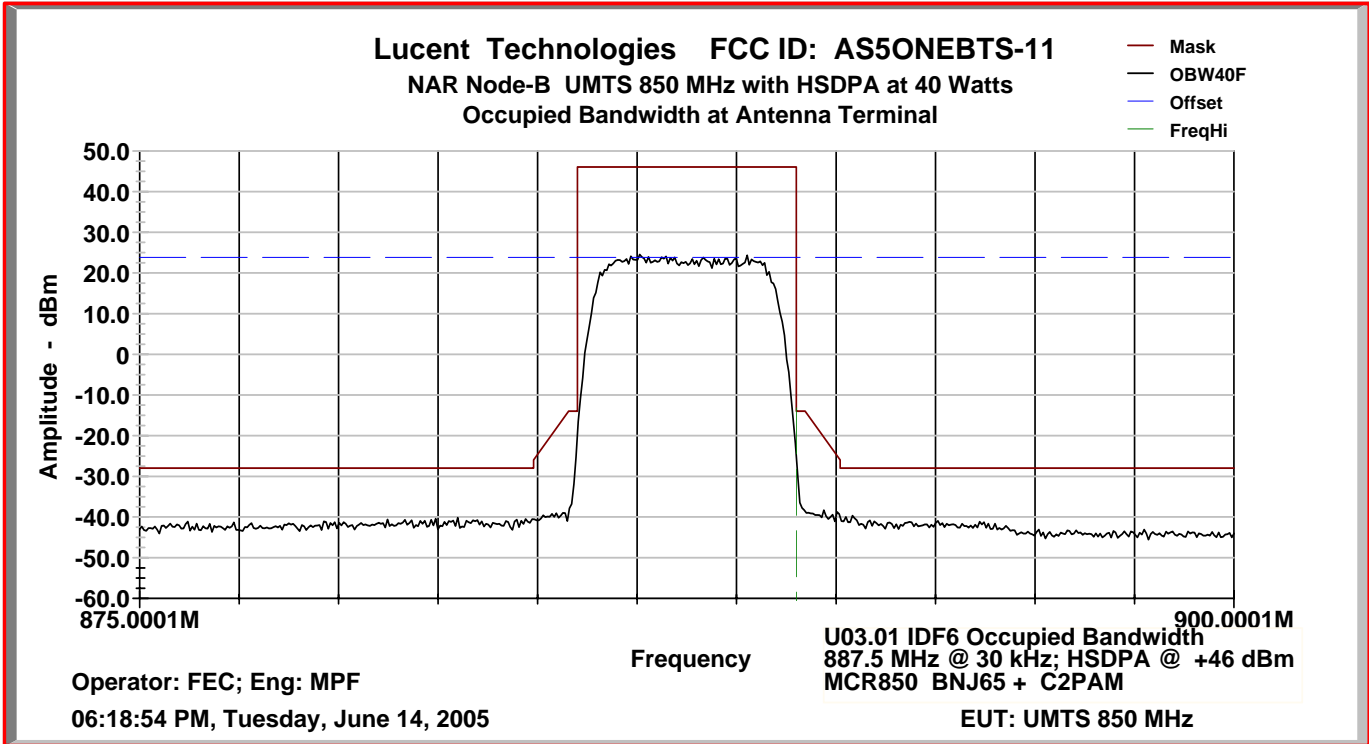

Occupied Bandwidth Characteristics: UARFCN Channel Number 1107 @ 891.50 MHz
Tx Antenna Terminal at +46 dBm per single 5 MHz carrier

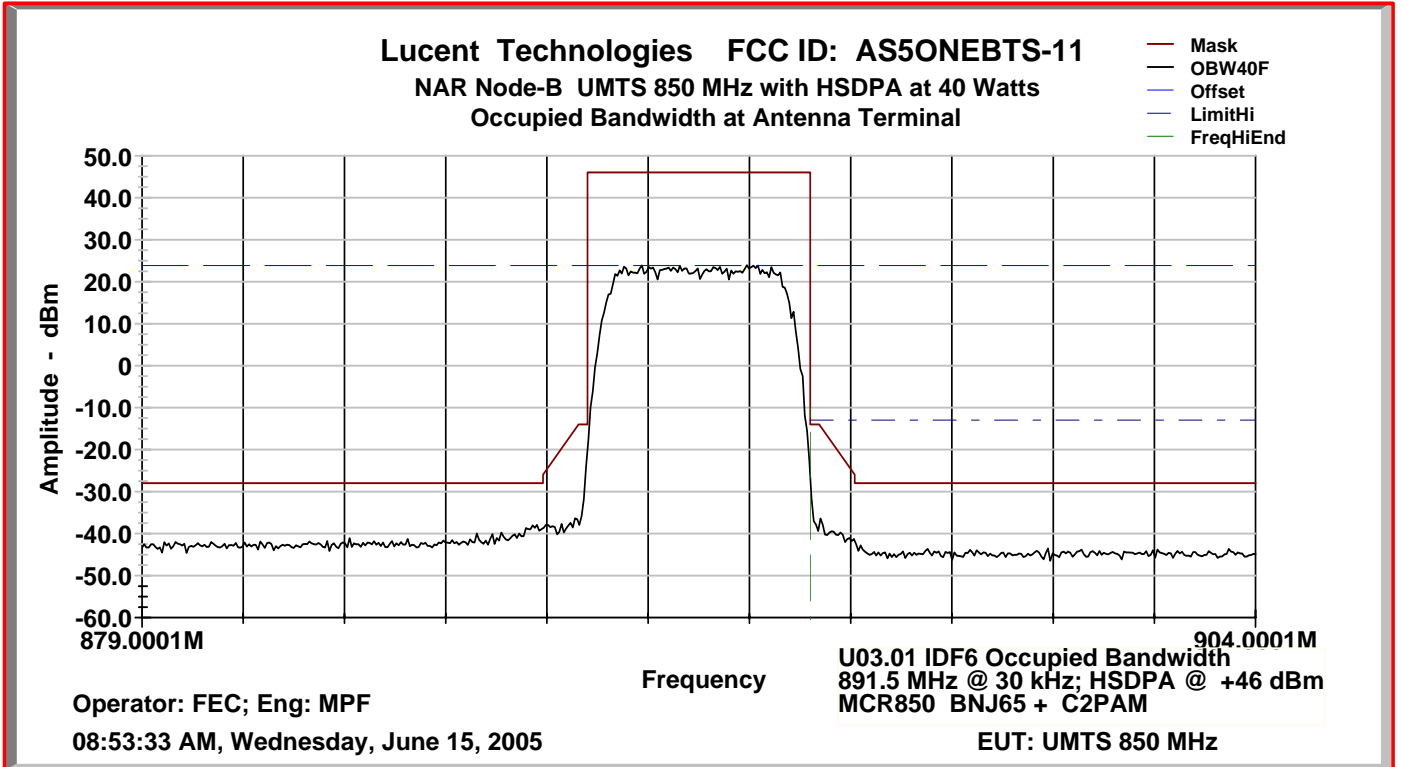

PART 2.1051 MEASUREMENTS REQUIRED: SPURIOUS EMISSIONS AT THE ANTENNA TERMINALS.

This test procedure is an extension of the occupied bandwidth measurement at the Equipment Antenna Connector (EAC) terminal, using the same carrier frequencies, power level setting procedure and modulated carrier offset procedure. In accordance with Part 2.1057(a), the required frequency spectrum to be investigated extends from the lowest RF signal generated to the 10th harmonic of the carrier at the EAC terminal. The emission limits at the antenna terminal are specified in Part 22.917 (a) ... the power of any emission shall be attenuated below the transmitter power (P) by at least $43 + 10 \log(P)$ dBc. The power P is the average carrier power measured at the EAC (antenna) terminal in Watts. Setting the power level at EAC to 40 Watts average, produces an emission attenuation below the carrier of 59.0 dBc. Part 22.917 (b) specifies the required Resolution Bandwidth (RBW) to be 100 kHz or greater. In accordance with Part 2.1051, "the magnitude of spurious emissions which are attenuated more than 20 dB below the permissible value need not be specified"; i.e., these are not reportable. Hence, the measurement equipment must be adjusted and configured to provide an instrumentation noise floor that is at least 20 dB or more below the $43 + 10 \log(P)$ dBc limit, which equates to 79.0 dBc. The pertinent test parameters are:

1. Frequency Spectrum: 10 MHz to 10 GHz
2. Resolution Bandwidth: 100 kHz or greater (Part 22.917)
3. Emission Limitation: $43 + 10 \log(P)$ dBc = $43 + 10 \log(40 \text{ Watts}) = 59.0$ dBc
4. Instrumentation Noise Floor: at least 20 dB greater than " $43 + 10 \log(P)$ dBc" = 79.0 dBc

Minimum Standard Requirement:

The emission limits at the antenna terminal are specified in Part 22.917 (a) ... the power of any emission shall be attenuated below the transmitter power (P) by at least $43 + 10 \log(P)$ dBc (i.e., attenuation below the unmodulated carrier). The power P is the average carrier power measured at the J4 antenna terminal in Watts. The measurement equipment must be adjusted and configured to provide an instrumentation noise floor that is 20 dB or more below the $43 + 10 \log(P)$ dBc limit. In summary:

1. Carrier Power Level = 46.0 dBm
2. Emission Limitation = 46.0 dBm – 59.0 dBc = -13.0 dBm
3. Reportable Emission Limit = -13.0 dBm – 20 dBc = -33.0 dBm
4. Emission power levels less than -33.0 dBm are not reportable; i.e., at ≥ 79.0 dBc

Test Set-up and Configuration: Same as previously used for Part 2.1046 RF Power Measurement.

Method of Measurement:

In order to suppress the instrumentation noise floor sufficient to detect and measure spurious signals that have power levels as low as 20 dB below the required limit, or as low as -33.0 dBm (i.e., 79 dBc), an EMC software package was employed to drive the spectrum analyzer, collect and compile the acquired data, perform mathematical corrections to the data by incorporating (i.e., programming) pre-measured path losses into the software, and then generate a graphical display as shown in this exhibit. The software package is: *TILE/IC (Total Integrated Laboratory Environment/Instrument Control System)*; purchased and licensed from Quantum Change/EMC Systems, Inc. The instrumentation noise floor is suppressed by the software's ability to split the spectrum being measured into many small segments, perform the mathematical corrections to each segment, and then sequentially compile all the segments into a continuous graphical display.

APPLICANT: LUCENT TECHNOLOGIES
EXHIBIT 10: TEST REPORT

FCC ID: AS5ONEBTS-11

Part 22.917 requires that emissions over the required spectrum 10 MHz to 10 GHz be measured using an instrumentation resolution bandwidth of 100 kHz or greater. The TILE/IC software was able to sufficiently suppress the normally high noise floor by measuring the spectrum in a sequential series of short segments using a peak detector, in combination with an appropriate low-pass filter and then with an appropriate high-pass filter, installed at the input terminal of the spectrum analyzer, to prevent the carrier from over driving the spectrum analyzer. The spectrum portion 894 MHz – 1.3 GHz, in close proximity to the carrier, was measured without filters.

The specific EMC test filters used were manufactured by TRILITHIC, Inc., Indianapolis, IN:

1. Low Pass Filter: Model 10LC800-3-AA; Product No. 23042
2. High Pass Filter: Model 4HC1400/8000-1-KK; Product No. 23042

The UARFCN 1007, 1037, 1062, 1087 & 1107 channels, tabulated below, all demonstrate compliance with the conducted emission limitation requirements specified by Part 22.917.

Cellular Frequency Band	UMTS850 Carrier	Single Carrier Bandwidth	UARFCN Channel Number	UMTS Carrier Center Frequency	Measured Carrier Power at Antenna Terminal
A	Lowest Settable for A-Band and to 869 MHz Band Edge	5 MHz	1007	871.5 MHz	+46 dBm
A	Highest Settable for A-Band	5 MHz	1037	877.5 MHz	+46 dBm
B	Lowest Settable for B-Band	5 MHz	1062	882.5 MHz	+46 dBm
B	Highest Settable for B-Band	5 MHz	1087	877.5 MHz	+46 dBm
B'	Highest Settable to 894 MHz Band Edge	5 MHz	1107	891.5 MHz	+46 dBm

Results: For each UMTS carrier, there were no reportable emissions. Data plots for each carrier are attached to this exhibit.

Conducted Emissions Characteristics: UARFCN Channel Number 1007 @ 871.50 MHz
Tx Antenna Terminal at +46 dBm per single 5 MHz carrier

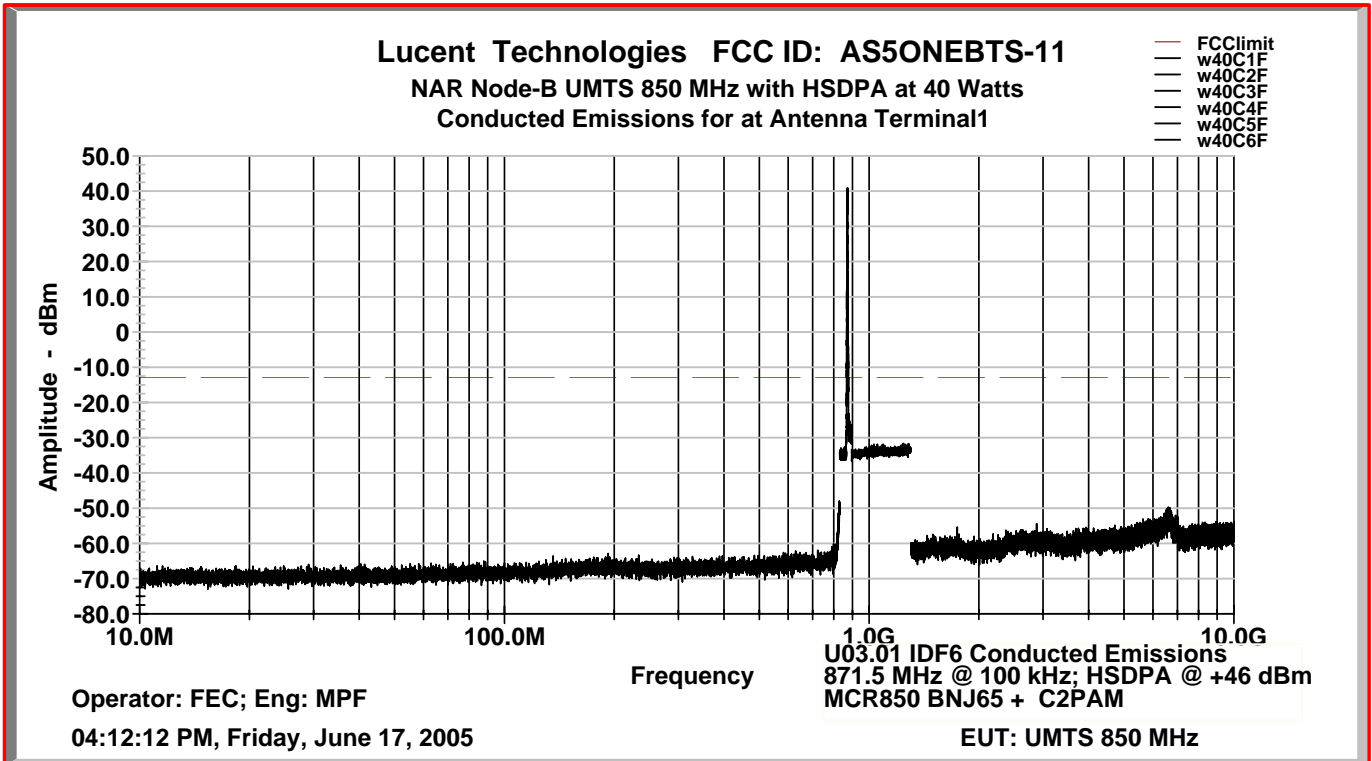

Conducted Emissions Characteristics: UARFCN Channel Number 1037 @ 877.50 MHz
Tx Antenna Terminal at +46 dBm per single 5 MHz carrier

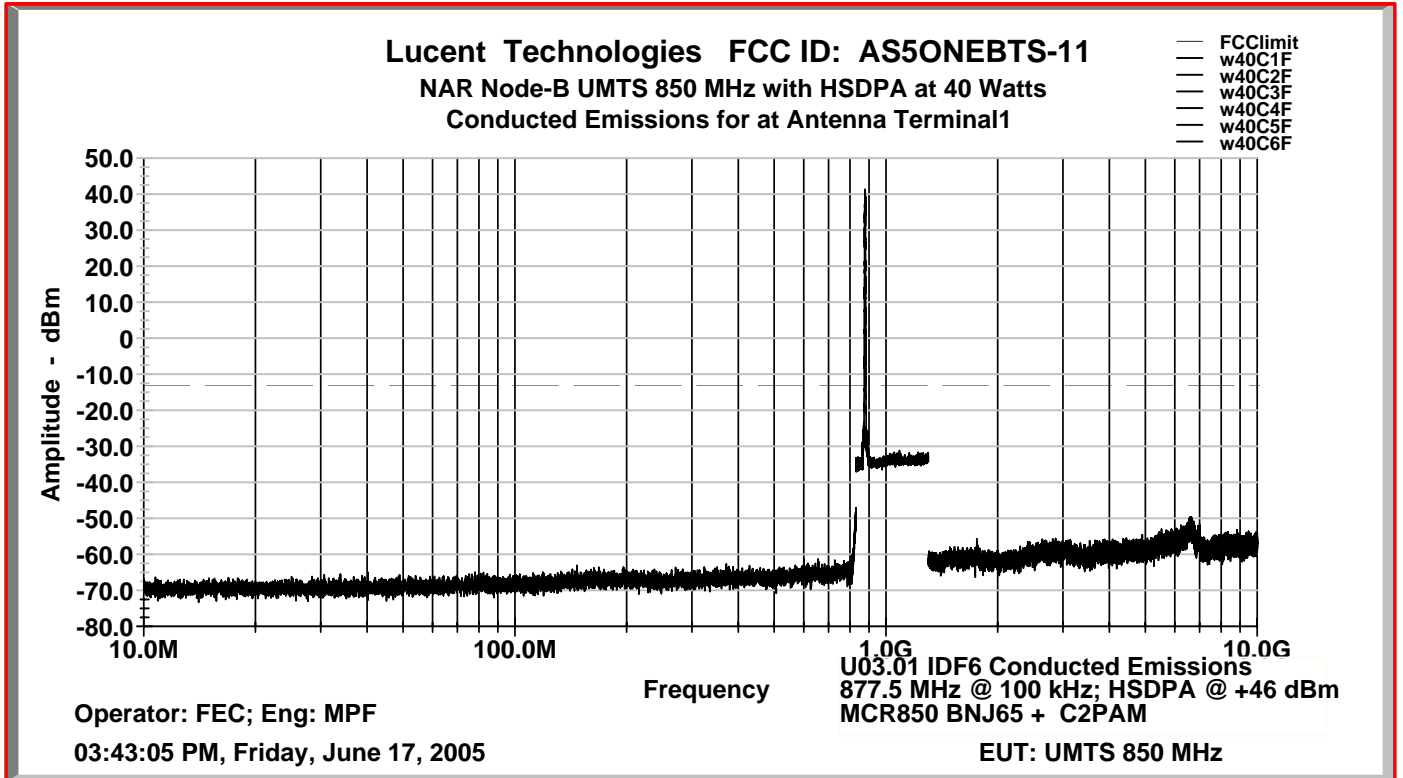

Conducted Emissions Characteristics: UARFCN Channel Number 1062 @ 882.50 MHz
Tx Antenna Terminal at +46 dBm per single 5 MHz carrier

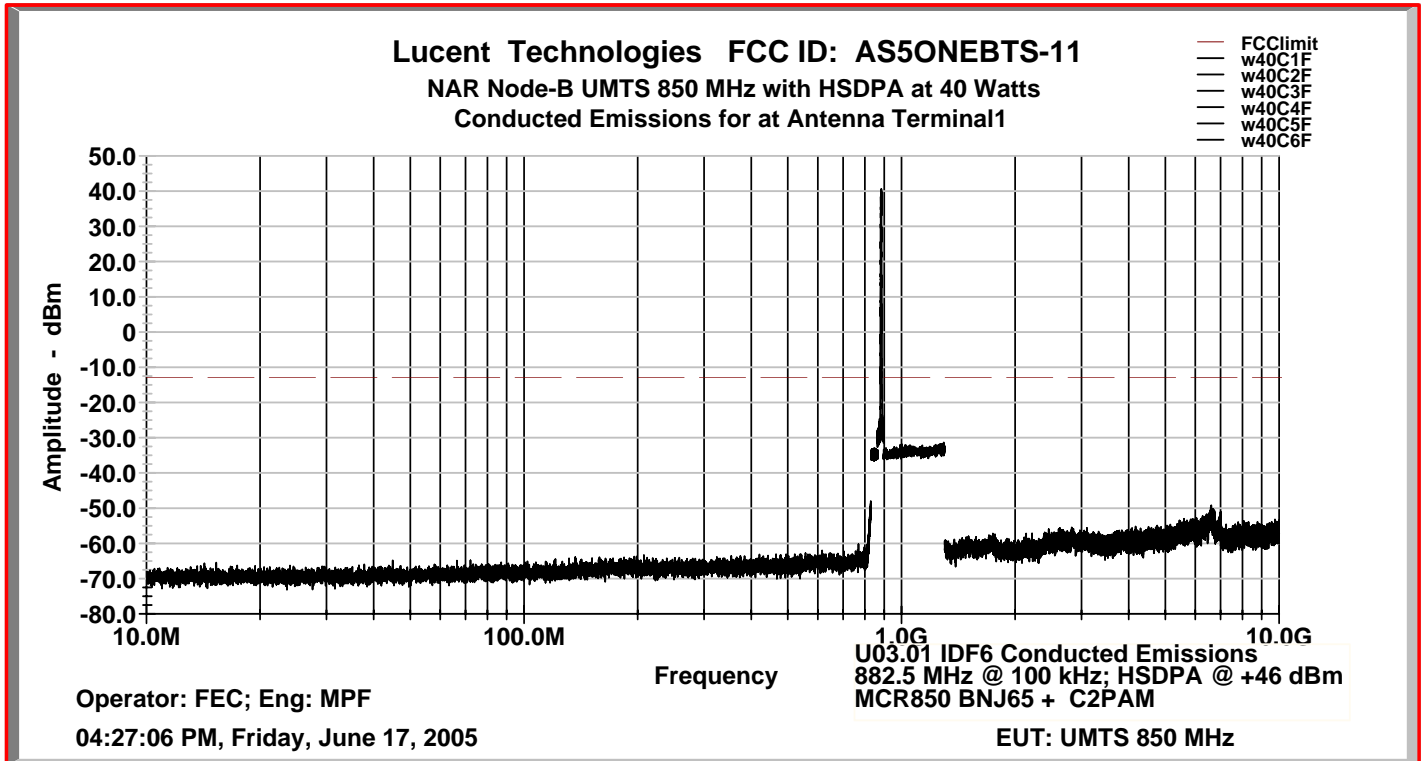

Conducted Emissions Characteristics: UARFCN Channel Number 1087 @ 887.50 MHz
Tx Antenna Terminal at +46 dBm per single 5 MHz carrier

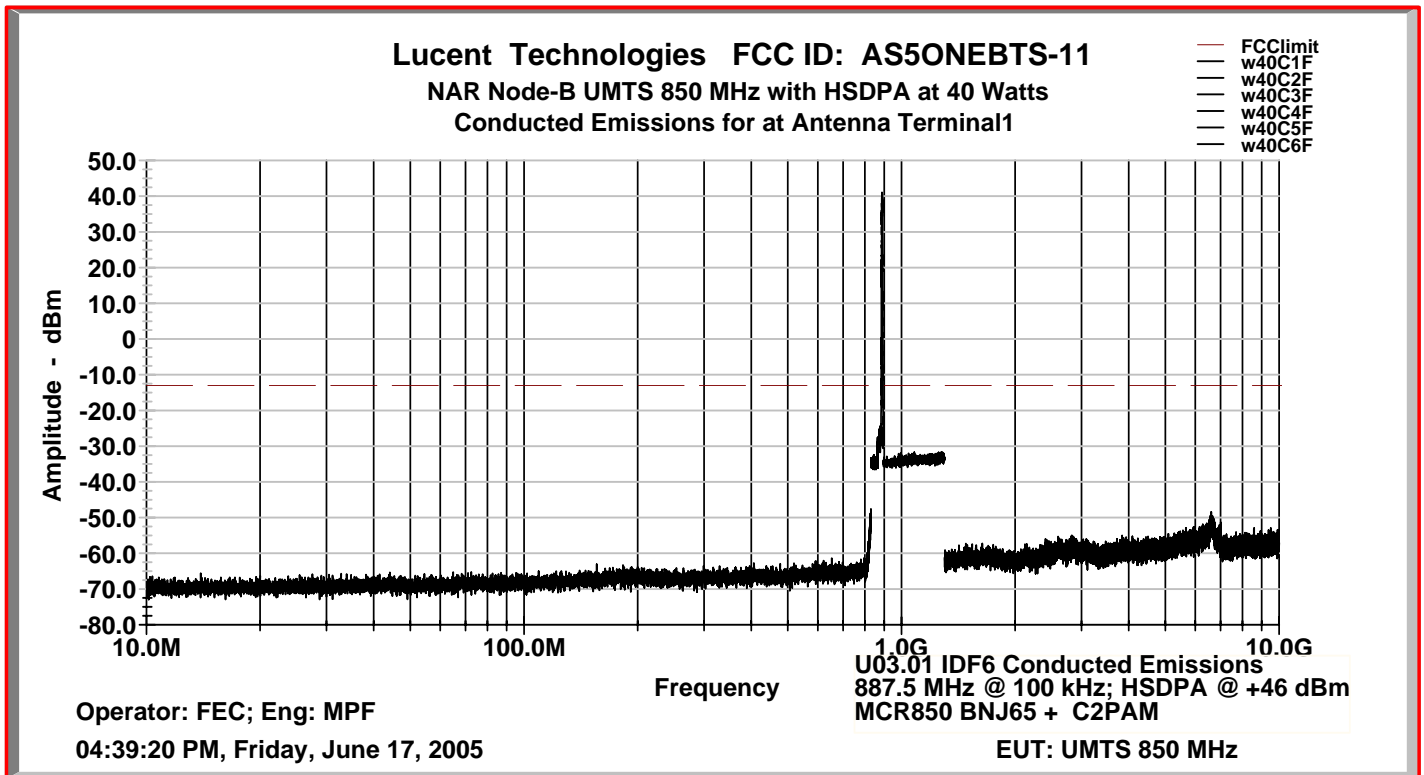

Conducted Emissions Characteristics: UARFCN Channel Number 1107 @ 891.50 MHz
Tx Antenna Terminal at +46 dBm per single 5 MHz carrier

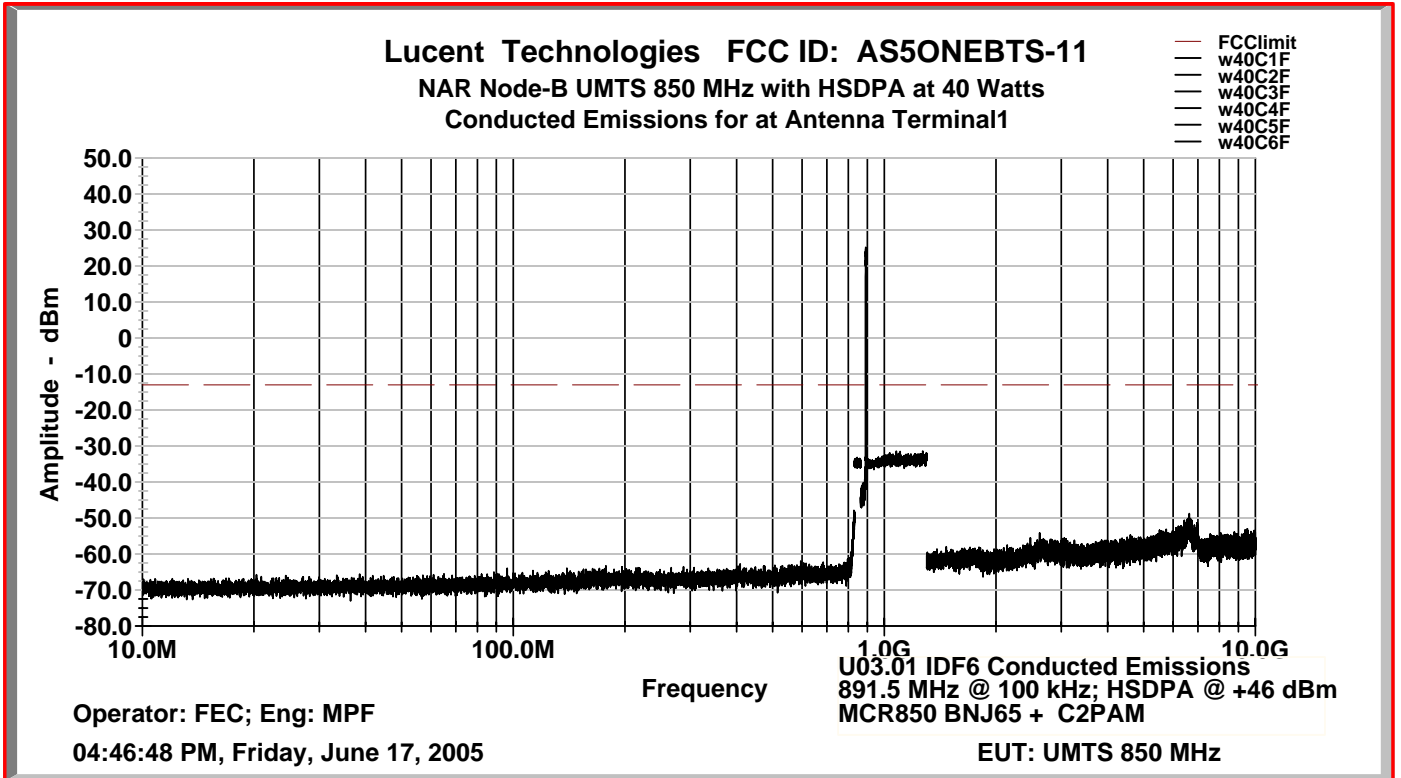

PART 2.1055 MEASUREMENTS REQUIRED: FREQUENCY STABILITY

The frequency stability was measured at the Equipment Antenna Terminal (EAC) and at the MCR850 transceiver output terminal for a single carrier set to UARFCN 1062 (882.5 MHz), which corresponds to mid cellular frequency band. Frequency stability measurements were performed by M. Coelho, Lucent Technologies, Swindon, United Kingdom, under the direction of M. P. Farina, and in adherence to the previously cited ISO/TL9000 test plan. These tests were performed twice for each of two crystal reference oscillator (OMA) manufacturers. The complete test reports are attached, which show the test results, test equipment configuration and photographs of the test set-up.

The procedure required by the FCC is specified in CFR 47, Part 2, Subpart J – Equipment Authorization Procedures, Section 2.1055 – Measurements Required: Frequency Stability, Effective: October 01, 2004. The requirements for base station/land station equipment, are summarized as:

Section 2.1055(a)(1): The frequency stability shall be measured with variation of ambient temperature from -30°C to $+50^{\circ}\text{C}$

Section 2.1055(b): Frequency measurements shall be made at the extremes of the specified temperature range and at intervals of not more than 10°C through the range. A period of time sufficient to stabilize all of the components of the oscillator circuit at each temperature level shall be allowed prior to frequency measurement. The short term transient effects on the frequency of the transmitter due to keying (except for broadcast transmitters) and any heating element cycling normally occurring at each ambient temperature level also shall be shown. (*Note: The term “keying” does not apply to base station/land station equipment. “Heating element” applies to “heat cartridges” if used .*) Only the portion or portions of the transmitter containing the frequency determining and stabilizing circuitry need be subjected to the temperature variation test.

Section 2.1055(d)(1): The frequency stability shall be measured with variation of primary supply voltage from 85% to 115% of the nominal value.

Frequency Stability Limitation:

The frequency stability is the measurement of the carrier center frequency deviation from its assigned value as a function of (1) temperature variation from -30°C to $+50^{\circ}\text{C}$, in $+10^{\circ}\text{C}$ increments, and (2) variation of supply voltage, at the equipment frame power input terminals, from 85% to 115% of the nominal value. This is a lengthy procedure and is performed one time with a single UMTS 850 carrier set to UARFCN 1062 (882.5 MHz). The required tolerance limit for UMTS 850 base station/land station equipment is specified in ETSI TS 25.141 as ± 0.05 ppm.

Results:

The UMTS-CDMA Transceiver System (850), subject of this application for certification under FCC ID: AS5ONEBTS-11, demonstrated full compliance with the requirements of FCC Rule Part 2.1055. The frequency stability for all measurements were well within the required ± 0.05 ppm, as shown in detail in the two attached Test Reports.

UMTS
Node B Compliance
03.01
FEI OMA
Test Report

850MHz Flexent[®] UMTS Macrocell

FCC 47 CFR 2.1055

Number:
Issue: 0.01
Status: Draft

Author: Michael Coelho
Date: 15 March 2005

Summary

This report describes the FCC 47 CFR 2.1055 tests completed on the Flexent UMTS Macrocell to verify compliance of the FEI OMA.

Functional tests were scheduled during the thermal test conditioning.

The test results showed that when the equipment was powered up all functional tests passed. These were:

Frequency Error

OMA Frequency Stability

CONTENTS

1.	Summary.....	29
2.	Object.....	31
3.	Introduction.....	31
3.1	Glossary.....	31
3.2	Scope.....	31
3.3	Specifications.....	31
3.4	Standards.....	31
4.	Equipment.....	31
4.1	Under Test.....	31
4.2	Test Equipment.....	31
5.	Test Procedure.....	32
5.1	Test Set up.....	32
5.2	Test Parameters.....	32
5.3	Functional Tests.....	33
6.	Results.....	33
7.	Conclusions.....	34
	APPENDIX A.....	35
	APPENDIX B.....	36
	APPENDIX C.....	37
	APPENDIX D.....	38

Object

This test was carried out to determine the frequency stability of the FEI OMA in a 850MHz Flexent® UMTS Macrocell Outdoor (3S1C 40 Watt) equipped cabinet over the temperature range -30°C to 50°C and at voltage extremes of +/- 15% from nominal (230V).

Introduction

This document contains the results of the FCC 47 CFR 2.1055 tests carried out on the Flexent® UMTS Macrocell to:

[3.3.1] Project Liberty NAR UMTS/W-CDMA 1900, Federal Communications Commission (FCC) Certification Test Plan For OneBTS UMTS/W-CDMA Wideband Transceiver UCR1900 Under FCC ID: AS5ONEBTS-01 And OneBTS UMTS/W-CDMA Power Amplifier PkLAM KS-24638 L1

Under FCC ID: AS5ONEBTS-02 by Michael P. Farina

Also included are lists showing the ancillary test equipment, equipment under test and functional tests conducted.

-22. Glossary

A/C	Alternating Current
°C	Degree Celsius
ETSI	European Telecommunications Standards Institution
HIOU	Hybrid Input Output Unit
Node B	UMTS Base Station
OMA	Oscillator Module
RH	Relative Humidity
RX	Receive
SRD	System Requirement Definition
TX	Transmit
MCR	Multi Carrier Radio
UCU	Universal Channel Unit
UDT	UMTS Diagnostic Tool
UMTS	Universal Mobile Telecommunication System
3S1C 40W	Three Sector, One Carrier, Forty Watt System

Scope

This test was applied to the Flexent® UMTS Macrocell as per product specification [3.3.2] (3S1C 40Watt) equipped cabinet. It was configured to released 03.01.

Specifications

[3.3.1] Project Liberty NAR UMTS/W-CDMA 1900, Federal Communications Commission (FCC), Certification Test Plan For OneBTS UMTS/W-CDMA Wideband Transceiver UCR1900, Under FCC ID: AS5ONEBTS-01 And OneBTS UMTS/W-CDMA Power Amplifier, PkLAM KS-24638 L1 Under FCC ID: AS5ONEBTS-02

[3.3.2] Agile - Document Number KS-24705 (L100) – OneBTS Compact Cell Outdoor Cabinet IRD-UTRAN-UTR-1 VERSION3.1

Standards

[3.4.3] ESTI TS 125 141 V5.8.0 (2003-12) Release 5

[3.4.4] Title 47--Telecommunication 47 Part 2 -- Frequency Allocations and Radio Treaty Matters; General Rules and Regulation, 2.1055 Measurements required: Frequency stability.

Equipment

-22. Under Test

The Flexent® UMTS Macrocell (3S1C 40Watt) equipped cabinet was equipped with hardware as listed in Appendix A - Table 4.0.

Appendix A contains the full list of equipment under test, together with their serial numbers.

-21. Test Equipment

The test equipment used to perform the investigation has been documented in Appendix B - Table 5.0

Lucent Technologies Inc. - Proprietary
Use pursuant to Company Instructions.

Figure 1.0 shows a schematic view of the test equipment layout

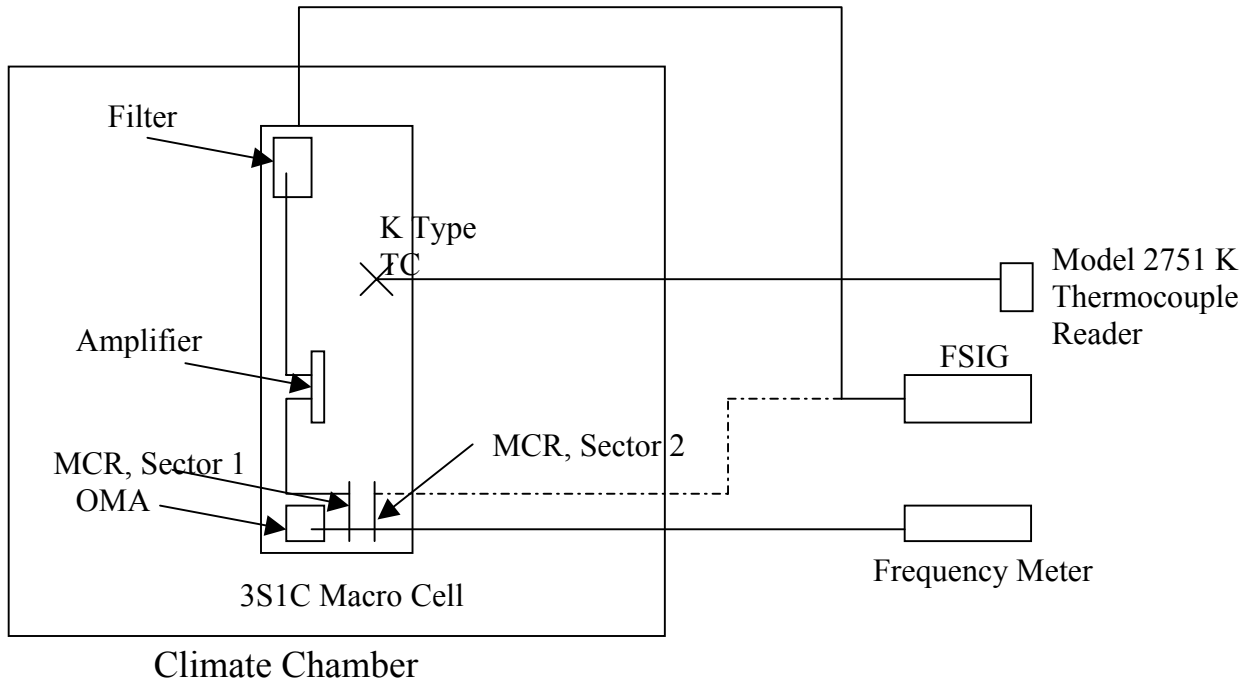

Figure 1.0 – Schematic Layout of Test Equipment

Test Procedure

-22. Test Set up

Prior to starting, the hardware was installed into the cabinet as per specification [3.3.2] and configured to U03.01 release.

Note: The cabinet was installed onto its plinth arrangement (optional) and then secured to a transportation pallet (for ease of installation and transportation into the thermal test chamber) during thermal test conditioning.

Test Parameters

- a) Points of Measurement:
 - i) The MCR measured at its RF output terminal
 - ii) The EAC transmit antenna terminal
 - iii) The Oscillator Module measured at its 15 MHz output terminal.
- b) Carrier Modulation:
 - Test Model 1 (Pmax = 46dBm)
 - Test Model 4 (Pmax – 18dB = 28dBm)
- c) Test Frequencies:
 - The FCC accepts a single test frequency, 876.5 MHz
- d) Carrier Power Level:
 - The transmit EAC terminal with the power level adjusted to +46 dBm (40 W).
 - The transmit power level at the MCR TX port adjusted to +5 dBm (40 W).
- e) Temperature Range
 - Variation of ambient temperature from –30°C to +50°C. Stabilized at increments of 10°C.

Lucent Technologies Inc. - Proprietary
Use pursuant to Company Instructions.

f) Supply Voltage Variation:

Input Supply Voltage	AC Input Voltage
85 % of Nominal	195.5 Vac
100 % of Nominal	230.0 Vac
115 % of Nominal	264.5 Vac

Table 1 Supply Voltage Variation

Functional Tests

Functional tests were carried out during thermal conditioning at stabilized temperatures. Measurement of Frequency Error and OMA Frequency Stability were taken

The universal diagnostic tool (UDT) used to perform the tests was version 3.0.0.

Results

Stabilized Temperature °C	Meas. Freq. 85 % Nom. Hz	Deviation 85 % Nom. ppm	Meas. Freq. 100 % Nom. Hz	Deviation 100 % Nom. ppm	Meas. Freq. 115 % Nom. Hz	Deviation 115 % Nom. ppm
- 30°C	-0.07	-0.0047	-0.07	-0.0047	-0.06	-0.0040
- 20°C	-0.06	-0.0040	-0.06	-0.0040	-0.06	-0.0040
- 10°C	-0.06	-0.0040	-0.06	-0.0040	-0.06	-0.0040
0°C	-0.07	-0.0047	-0.05	-0.0033	-0.06	-0.0040
+ 10°C	-0.05	-0.0033	-0.05	-0.0033	-0.06	-0.0040
+ 20°C	-0.06	-0.0040	-0.06	-0.0040	-0.06	-0.0040
+ 30°C	-0.07	-0.0047	-0.07	-0.0047	-0.07	-0.0047
+ 40°C	-0.07	-0.0047	-0.07	-0.0047	-0.07	-0.0047
+ 50°C	-0.07	-0.0047	-0.07	-0.0047	-0.06	-0.0040

Table 2 FCC 47 CFR 2.1055 OMA Stability

Testing Temp	Voltage Variation	EAC		MCR2	
		TM1 Pmax	TM4 Pmax – 18dBm	TM1Pmax	TM4Pmax – 18dBm
-30 °C	- 15%	17.05 Hz 46.2 dBm	18.90 Hz 28.1 dBm	-14.72Hz 5.0 dBm	-14.31 Hz -12.8 dBm
	Nominal	-19.31 Hz 46.1 dBm	18.40 Hz 28.0 dBm	-11.91 Hz 5.0dBm	-13.31 Hz -12.9 dBm
	+15%	-21.67 Hz 46.2 dBm	17.63 Hz 28.0 dBm	14.91Hz 5.2 dBm	15.43 Hz -12.9 dBm
-20 °C	- 15%	-17.31 Hz 46.2 dBm	17.02 Hz 28.0 dBm	-12.90Hz 5.1 dBm	13.69 Hz -12.8 dBm
	Nominal	8.82 Hz 46.1 dBm	14.58 Hz 28.0 dBm	16.01 Hz 5.2dBm	12.24 Hz -12.8 dBm
	+15%	20.50 Hz 46.1 dBm	-14.2 Hz 28.0 dBm	16.05Hz 5.1 dBm	-13.60 Hz -12.9 dBm
-10 °C	- 15%	-27.23 Hz 46.2 dBm	-21.67 Hz 28.2 dBm	14.19Hz 4.9 dBm	-15.49 Hz -12.7 dBm
	Nominal	-18.23 Hz 46.0 dBm	-19.63 Hz 28.3 dBm	14.41 Hz 5.0dBm	-16.36 Hz -12.8 dBm
	+15%	15.43 Hz 46.3 dBm	16.57 Hz 28.3 dBm	-17.32Hz 5.0 dBm	14.45 Hz -12.9 dBm

0 °C	- 15%	-21.52 Hz 46.9 dBm	22.99 Hz 28.5 dBm	13.25Hz 5.0 dBm	-19.30 Hz -12.9 dBm
	Nominal	13.90 Hz 46.4 dBm	18.87 Hz 28.5 dBm	-14.41 Hz 5.0dBm	-11.64 Hz -12.9 dBm
	+15%	18.11 Hz 46.3 dBm	14.37 Hz 28.5 dBm	-13.79Hz 5.0 dBm	-16.27 Hz -12.9 dBm
10 °C	- 15%	20.81 Hz 46.1 dBm	15.54 Hz 28.0 dBm	13.00Hz 5.0 dBm	-9.14 Hz -12.8 dBm
	Nominal	-15.39 Hz 46.0 dBm	18.31 Hz 28.0 dBm	15.56 Hz 5.0dBm	13.12 Hz -12.8 dBm
	+15%	17.97 Hz 46.0 dBm	-16.43 Hz 28.0 dBm	13.65Hz 5.0 dBm	13.68 Hz -12.8 dBm
20 °C	- 15%	23.00 Hz 46.1 dBm	-14.65 Hz 28.0 dBm	-10.67Hz 5.0 dBm	15.03 Hz -12.8 dBm
	Nominal	17.97 Hz 46.2 dBm	15.38 Hz 28.0 dBm	10.78 Hz 5.0dBm	12.48 Hz -12.8 dBm
	+15%	17.87 Hz 46.2 dBm	17.48 Hz 28.0 dBm	13.18Hz 5.0 dBm	12.57 Hz -12.9 dBm
30 °C	- 15%	-18.76 Hz 46.2 dBm	-16.05 Hz 27.9 dBm	9.13Hz 5.0 dBm	13.66 Hz -12.8 dBm
	Nominal	-13.96 Hz 46.1 dBm	18.38 Hz 28.0 dBm	11.55Hz 5.0 dBm	-12.74 Hz -12.8 dBm
	+15%	-12.35 Hz 46.2 dBm	-9.55 Hz 29.9 dBm	10.79Hz 4.9 dBm	12.88 Hz -12.8 dBm
40 °C	- 15%	-7.92 Hz 46.0 dBm	-8.09 Hz 28.0 dBm	9.19Hz 5.0 dBm	-12.60 Hz -12.8 dBm
	Nominal	-13.34 Hz 46.0 dBm	-9.11 Hz 28.0 dBm	11.85Hz 5.0 dBm	-14.81 Hz -12.8 dBm
	+15%	-11.78 Hz 46.0 dBm	10.87 Hz 28.0 dBm	10.51Hz 5.1 dBm	-8.77 Hz -12.9 dBm
50 °C	- 15%	-7.17 Hz 46.0 dBm	19.63 Hz 28.0 dBm	-9.06Hz 5.0 dBm	-10.71 Hz -12.8 dBm
	Nominal	-7.66 Hz 46.0 dBm	-8.38 Hz 28.0 dBm	-8.84 Hz 5.0 dBm	-17.87 Hz -12.8 dBm
	+15%	23.14 Hz 46.0 dBm	39.05 Hz 28.0 dBm	10.51Hz 5.1 dBm	8.36 Hz -12.9 dBm

Table 3 FCC 47 CFR 2.1055 Frequency Error Measurement

Conclusions

The FEI OMA meets the FCC Title 47 Part 2.1055 Frequency stability requirements.

APPENDIX A

Equipment Under Test

Table 4 details the Node B hardware.

BTS Element	Comcode	Serial number	Comment
Cabinet	---	05WH06404001	ODM3
Filter panel	408903250	05C805002135	Dual Duplexor #1
Filter panel	408903250	05C803004179	Dual Duplexor #2
Filter panel	408903250	05C803004728	Dual Duplexor #3
C2PAM	408762268	04BG57070054	PAM #1
C2PAM	408762268	04BG57070246	PAM #2
C2PAM	408762268	04BG57070521	PAM #3
MCR	201245297	04VC075750206	850 BNJ 65 S0:8 P4.0
MCR	201245297	04VC105750045	850 BNJ 65 S0:8 P4.0
MCR	201245297	04VC105750015	850 BNJ 65 S0:8 P4.0
CTU	---	03G004307648	---
UCU	201173276	03RC11030038	UCU II #1
UCU	201173276	03RC11030013	UCU II #2
UCU	201173276	03RC11030108	UCU II #3
URC II	---	05Y901021050	44 WW65 P2
Oscillator Module	408886042	4P063087638	---
CPC-A	---	408646040	CPC-A #1
CPC-B	---	408646032	CPC-B #1
CPC-B	408646032	01T766001685	CPC-B #2

Table 4 – Equipment Under Test

APPENDIX B

Test Equipment

Table 5 details the test equipment used to conduct the testing.

Equipment	Make & Model Number	Serial Number	Calibration
Thermal Chamber	Design Environmental	84905	Sept 05
Universal Frequency Counter	Fluke PM6685R	SM668746	Dec 05
Signal Analyser	Rohde & Schwarz – FSIG 3	10070	Nov 05
Power Signal Analyser	Agilent – E4440A	MY44303412	Jan 06
Humidity and Temperature Sensor	Vaisala HMP233 A2E2A2CC12D1A3B	T4710005	Jul 05

Table 5 – Test Equipment

APPENDIX C

Functional Tests

The following functional tests were carried out during thermal conditioning. These functional tests and the system configurations were extracted from the requirements

Test	Configuration	Functional Test	Notes
FCC 47 Part 2.1022	3S1C 40W <i>Cabinet A/C Powered</i> Note MCR Sector 2 will Tx@ 5dBm	TX: TM1 Max. Power Out; Frequency Error	Sector 1 (EAC)
		TX: TM 4 Pmax-18dBm Frequency Error	Sector 1 (EAC)
		TX:TM1 Max. Power Out Frequency Error	Sector 2 (TX1 MCR)
		TX: TM 4 Pmax-18dBm Frequency Error	Sector 2 (TX1 MCR)
		TX: OMA Frequency	OMA

Table 6 – Functional Tests

Functional Test	Pass / Fail Criteria
TX: Max. Power Out	+/- 2dB (+/-2.5dB*) from Manufactures Declared Power Output; 46dBm (40Watt System)
TX: Frequency Error	(50 Parts Per Billion = 0.05 Parts Per Million) TX Frequency, 876.5 MHz x 0.05 PPM = (+/- 43.82Hz)
OMA Frequency Accuracy	(50 Parts Per Billion = 0.05 Parts Per Million) PPM = +/- 0.75Hz

Table 7 – Functional Tests Pass / Fail Criteria

All functional test Pass / Fail Criteria was extracted from Standards [3.4.3].

APPENDIX D
BTS Testing Photographs

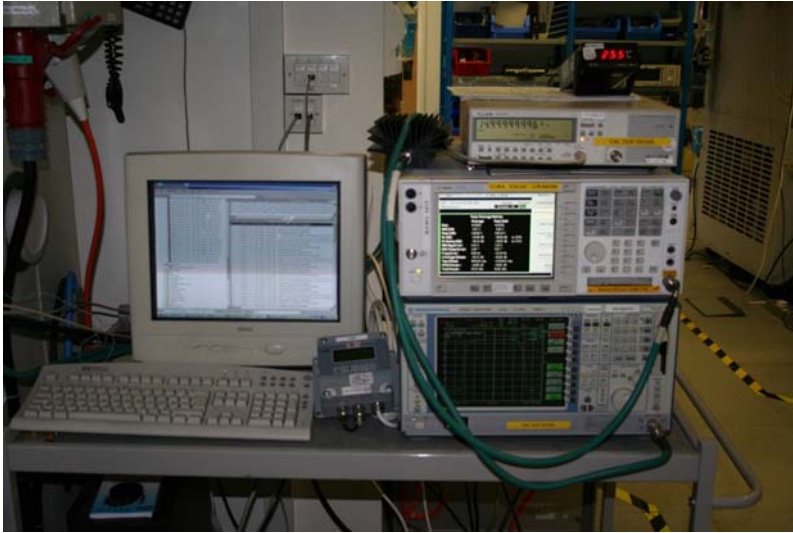

Figure 2 Test Equipment used in Measurement



Figure 3 Closed BTS under Test



Figure 4 Open BTS under Test

UMTS
Node B Compliance
03.01
Temex OMA
Test Report

850MHz Flexent[®] UMTS Macrocell

FCC 47 CFR 2.1055

Number:
Issue: 0.01
Status: Draft

Author: Michael Coelho
Date: 15 March 2005

Summary

This report describes the FCC 47 CFR 2.1055 tests completed on the Flexent UMTS Macrocell to verify compliance of the Temex OMA.

Functional tests were scheduled during the thermal test conditioning.

The test results showed that when the equipment was powered up all functional tests passed. These were:

Frequency Error

OMA Frequency Stability

CONTENTS

1.	Summary.....	29
2.	Object.....	31
3.	Introduction.....	31
3.1	Glossary.....	31
3.2	Scope.....	31
3.3	Specifications.....	31
3.4	Standards.....	31
4.	Equipment.....	31
4.1	Under Test.....	31
4.2	Test Equipment.....	31
5.	Test Procedure.....	32
5.1	Test Set up.....	32
5.2	Test Parameters.....	32
5.3	Functional Tests.....	33
6.	Results.....	33
7.	Conclusions.....	34
	APPENDIX A.....	35
	APPENDIX B.....	36
	APPENDIX C.....	37
	APPENDIX D.....	38

Object

This test was carried out to determine the frequency stability of the Temex OMA in a 850MHz Flexent® UMTS Macrocell Outdoor (3S1C 40 Watt) equipped cabinet over the temperature range -30°C to 50°C and at voltage extremes of +/- 15% from nominal (230V).

Introduction

This document contains the results of the FCC 47 CFR 2.1055 tests carried out on the Flexent® UMTS Macrocell to:

[3.3.1] Project Liberty NAR UMTS/W-CDMA 1900, Federal Communications Commission (FCC) Certification Test Plan For OneBTS UMTS/W-CDMA Wideband Transceiver UCR1900 Under FCC ID: AS5ONEBTS-01 And OneBTS UMTS/W-CDMA Power Amplifier PkLAM KS-24638 L1

Under FCC ID: AS5ONEBTS-02 by Michael P. Farina

Also included are lists showing the ancillary test equipment, equipment under test and functional tests conducted.

-21. Glossary

A/C	Alternating Current
°C	Degree Celsius
ETSI	European Telecommunications Standards Institution
HIOU	Hybrid Input Output Unit
Node B	UMTS Base Station
OMA	Oscillator Module
RH	Relative Humidity
RX	Receive
SRD	System Requirement Definition
TX	Transmit
MCR	Multi Carrier Radio
UCU	Universal Channel Unit
UDT	UMTS Diagnostic Tool
UMTS	Universal Mobile Telecommunication System
3S1C 40W	Three Sector, One Carrier, Forty Watt System

Scope

This test was applied to the Flexent® UMTS Macrocell as per product specification [3.3.2] (3S1C 40Watt) equipped cabinet. It was configured to released 03.01.

Specifications

[3.3.1] Project Liberty NAR UMTS/W-CDMA 1900, Federal Communications Commission (FCC), Certification Test Plan For OneBTS UMTS/W-CDMA Wideband Transceiver UCR1900, Under FCC ID: AS5ONEBTS-01 And OneBTS UMTS/W-CDMA Power Amplifier, PkLAM KS-24638 L1 Under FCC ID: AS5ONEBTS-02

[3.3.2] Agile - Document Number KS-24705 (L100) – OneBTS Compact Cell Outdoor Cabinet IRD-UTRAN-UTR-1 VERSION3.1

Standards

[3.4.3] ESTI TS 125 141 V5.8.0 (2003-12) Release 5

[3.4.4] Title 47--Telecommunication 47 Part 2 -- Frequency Allocations and Radio Treaty Matters; General Rules and Regulation, 2.1055 Measurements required: Frequency stability.

Equipment

-20. Under Test

The Flexent® UMTS Macrocell (3S1C 40Watt) equipped cabinet was equipped with hardware as listed in Appendix A - Table 4.0.

Appendix A contains the full list of equipment under test, together with their serial numbers.

-19. Test Equipment

The test equipment used to perform the investigation has been documented in Appendix B - Table 5.0

Lucent Technologies Inc. - Proprietary
Use pursuant to Company Instructions.

Figure 1.0 shows a schematic view of the test equipment layout

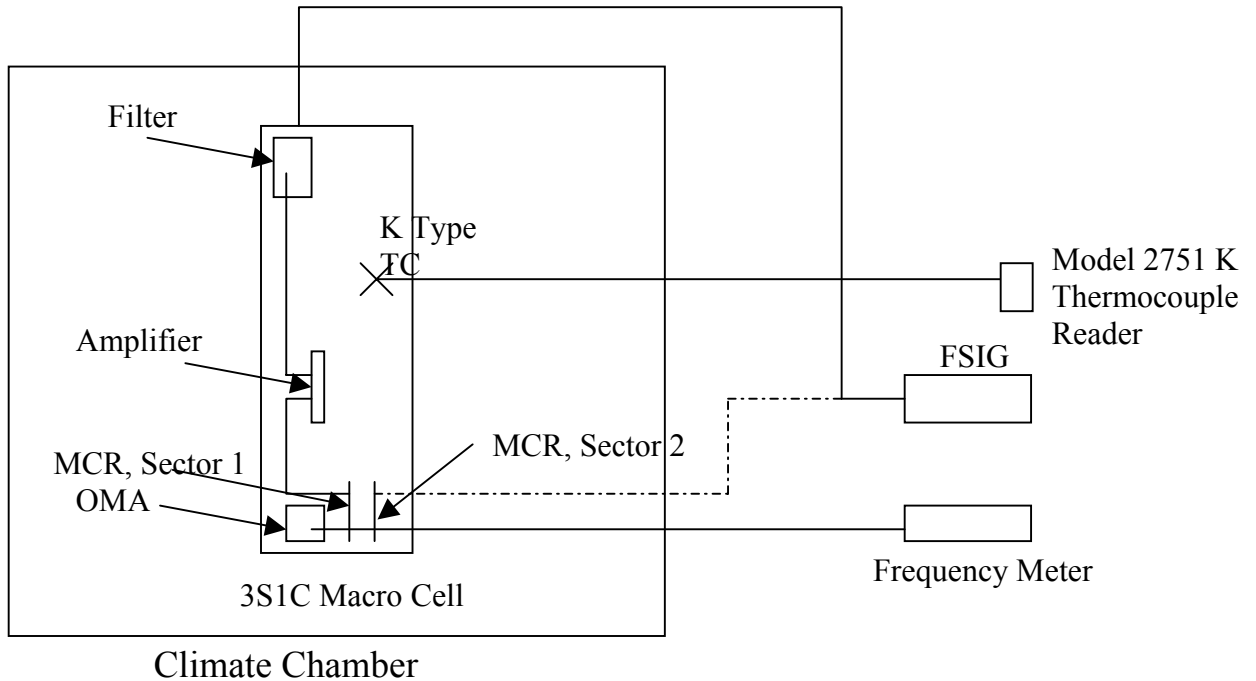

Figure 1.0 – Schematic Layout of Test Equipment

Test Procedure

-18. Test Set up

Prior to starting, the hardware was installed into the cabinet as per specification [3.3.2] and configured to U03.01 release.

Note: The cabinet was installed onto its plinth arrangement (optional) and then secured to a transportation pallet (for ease of installation and transportation into the thermal test chamber) during thermal test conditioning.

Test Parameters

- a) Points of Measurement:
 - i) The MCR measured at its RF output terminal
 - ii) The EAC transmit antenna terminal
 - iii) The Oscillator Module measured at its 15 MHz output terminal.
- b) Carrier Modulation:
 - Test Model 1 (Pmax = 46dBm)
 - Test Model 4 (Pmax – 18dB = 28dBm)
- c) Test Frequencies:
 - The FCC accepts a single test frequency, 876.5 MHz
- d) Carrier Power Level:
 - The transmit EAC terminal with the power level adjusted to +46 dBm (40 W).
 - The transmit power level at the MCR TX port adjusted to +5 dBm (40 W).
- e) Temperature Range
 - Variation of ambient temperature from –30°C to +50°C. Stabilized at increments of 10°C.

Lucent Technologies Inc. - Proprietary
Use pursuant to Company Instructions.

f) Supply Voltage Variation:

Input Supply Voltage	AC Input Voltage
85 % of Nominal	195.5 Vac
100 % of Nominal	230.0 Vac
115 % of Nominal	264.5 Vac

Table 1 Supply Voltage Variation

Functional Tests

Functional tests were carried out during thermal conditioning at stabilized temperatures. Measurement of Frequency Error and OMA Frequency Stability were taken

The universal diagnostic tool (UDT) used to perform the tests was version 3.0.0.

Results

Stabilized Temperature °C	Meas. Freq. 85 % Nom. Hz	Deviation 85 % Nom. ppm	Meas. Freq. 100 % Nom. Hz	Deviation 100 % Nom. ppm	Meas. Freq. 115 % Nom. Hz	Deviation 115 % Nom. ppm
-30°C	-0.03	-0.0020	0.03	0.0020	-0.03	-0.0020
-20°C	-0.03	-0.0020	0.03	0.0020	-0.04	-0.0026
-10°C	-0.03	-0.0020	0.04	0.0026	-0.03	-0.0020
0°C	-0.03	-0.0020	0.04	0.0026	-0.04	-0.0026
+10°C	-0.03	-0.0020	0.03	0.0020	-0.03	-0.0020
+20°C	-0.01	-0.0007	-0.02	-0.0013	0.03	-0.0020
+30°C	0.03	0.0020	0.03	0.0020	-0.03	-0.0020
+40°C	0.03	0.0020	-0.03	-0.0020	-0.03	-0.0020
+50°C	-0.03	-0.0020	0.03	0.0020	-0.03	-0.0020

Table 2 FCC 47 CFR 2.1055 OMA Stability

Testing Temp	Voltage Variation	EAC		MCR2	
		TM1 Pmax	TM4 Pmax – 18dBm	TM1Pmax	TM4Pmax – 18dBm
-30 °C	-15%	20.13 Hz 47.3 dBm	16.36 Hz 29.3 dBm	15.95Hz 5.2 dBm	-13.60 Hz -12.8 dBm
	Nominal	16.35 Hz 47.2 dBm	18.70 Hz 29.4 dBm	18.25Hz 5.2 Bm	15.14 Hz -12.7 dBm
	+15%	18.74 Hz 47.2 dBm	18.93 Hz 29.4 dBm	15.45Hz 5.3 dBm	14.33 Hz -12.8 dBm
-20 °C	-15%	19.17 Hz 47.1 dBm	12.87 Hz 29.2 dBm	17.97Hz 5.2 dBm	-19.90 Hz -12.7 dBm
	Nominal	17.65 Hz 47.1 dBm	15.77 Hz 29.2 dBm	17.28Hz 5.2dBm	16.31 Hz -12.7 dBm
	+15%	18.65 Hz 47.0 dBm	23.81 Hz 29.2 dBm	15.21Hz 5.2 dBm	20.40 Hz -12.8 dBm
-10 °C	-15%	14.57 Hz 47.2 dBm	24.04 Hz 29.4 dBm	18.49Hz 5.2 dBm	-13.46 Hz -12.7 dBm
	Nominal	21.33 Hz 47.2 dBm	20.31 Hz 29.4 dBm	15.27Hz 5.2dBm	12.15 Hz -12.8 dBm
	+15%	16.52 Hz 47.2 dBm	18.30 Hz 29.4 dBm	13.44Hz 5.2 dBm	11.46 Hz -12.5 dBm
0 °C	-15%	23.21 Hz 45.8 dBm	22.88 Hz 27.8 dBm	17.99Hz 5.2 dBm	-20.81 Hz -12.6 dBm

	Nominal	25.73 Hz 45.8 dBm	21.64 Hz 27.9 dBm	18.44Hz 5.2dBm	19.11 Hz -12.7 dBm
	+15%	19.56 Hz 45.9 dBm	23.33 Hz 27.9 dBm	17.14Hz 5.2 dBm	20.60 Hz -12.7 dBm
10 °C	- 15%	23.21 Hz 45.8 dBm	22.88 Hz 27.8 dBm	17.99Hz 5.2 dBm	20.81 Hz -12.6 dBm
	Nominal	25.73 Hz 45.8 dBm	-21.64 Hz 27.9 dBm	18.44Hz 5.2dBm	19.11 Hz -12.7 dBm
	+15%	19.56 Hz 45.9 dBm	23.94 Hz 27.8 dBm	17.14Hz 5.2 dBm	20.60 Hz -12.7 dBm
	- 15%	17.50 Hz 45.9 dBm	23.33 Hz 27.3 dBm	-13.29Hz 5.1 dBm	33.11 Hz -12.8 dBm
20 °C	Nominal	21.17 Hz 46.0 dBm	22.35 Hz 27.9 dBm	-14.58Hz 5.0dBm	-26.54 Hz -13.0 dBm
	+15%	16.33 Hz 45.8 dBm	-30.69 Hz 28.0 dBm	-5.63Hz 5.1 dBm	16.47 Hz -12.8 dBm
30 °C	- 15%	17.16 Hz 45.9 dBm	29.22 Hz 27.9 dBm	14.28Hz 5.2 dBm	14.59 Hz -12.7 dBm
	Nominal	16.13 Hz 45.9 dBm	20.50 Hz 27.7 dBm	12.93Hz 5.1 Bm	-16.45 Hz -12.7 dBm
	+15%	23.57 Hz 45.9 dBm	28.94 Hz 27.9 dBm	-7.58Hz 5.2 dBm	15.91 Hz -12.7 dBm
	- 15%	18.00 Hz 45.3 dBm	-29.21 Hz 27.3 dBm	13.26Hz 5.2 dBm	13.95 Hz -12.7 dBm
40 °C	Nominal	24.14 Hz 45.3 dBm	15.85 Hz 27.7 dBm	13.11Hz 5.2dBm	17.82 Hz -12.7 dBm
	+15%	21.29 Hz 45.2 dBm	18.87 Hz 27.4 dBm	16.45Hz 5.3 dBm	16.82 Hz -12.7 dBm
50 °C	- 15%	21.29 Hz 44.8 dBm	16.25 Hz 27.0 dBm	16.45Hz 5.3 dBm	17.82 Hz -12.7 dBm
	Nominal	25.12 Hz 44.8 dBm	27.31 Hz 27.0 dBm	39.44Hz 5.2dBm	18.57 Hz -12.7 dBm
	+15%	23.11 Hz 44.9 dBm	25.76 Hz 27.0 dBm	41.19Hz 5.2 dBm	19.49 Hz -12.6 dBm

Table 3 FCC 47 CFR 2.1055 Frequency Error Measurement

Conclusions

The Temex OMA meets the FCC Title 47 Part 2.1055 Frequency stability requirements.

APPENDIX A

Equipment Under Test

Table 4 details the Node B hardware.

BTS Element	Comcode	Serial number	Comment
Cabinet	---	05WH06404001	ODM3
Filter panel	408903250	05C805002135	Dual Duplexor #1
Filter panel	408903250	05C803004179	Dual Duplexor #2
Filter panel	408903250	05C803004728	Dual Duplexor #3
C2PAM	408762268	04BG57070054	PAM #1
C2PAM	408762268	04BG57070246	PAM #2
C2PAM	408762268	04BG57070521	PAM #3
MCR	201245297	04VC075750206	850 BNJ 65 S0:8 P4.0
MCR	201245297	04VC105750045	850 BNJ 65 S0:8 P4.0
MCR	201245297	04VC105750015	850 BNJ 65 S0:8 P4.0
CTU	---	03G004307648	---
UCU	201173276	03RC11030038	UCU II #1
UCU	201173276	03RC11030013	UCU II #2
UCU	201173276	03RC11030108	UCU II #3
URC II	---	05Y901021050	44 WW65 P2
Oscillator Module	408886042	05TM02050508	---
CPC-A	---	408646040	CPC-A #1
CPC-B	---	408646032	CPC-B #1
CPC-B	408646032	01T766001685	CPC-B #2

Table 4 – Equipment Under Test

APPENDIX B

Test Equipment

Table 5 details the test equipment used to conduct the testing.

Equipment	Make & Model Number	Serial Number	Calibration
Thermal Chamber	Design Environmental	84905	Sept 05
Universal Frequency Counter	Fluke PM6685R	SM668746	Dec 05
Signal Analyser	Rohde & Schwarz – FSIG 3	10070	Nov 05
Power Signal Analyser	Agilent – E4440A	MY44303412	Jan 06
Humidity and Temperature Sensor	Vaisala HMP233 A2E2A2CC12D1A3B	T4710005	Jul 05

Table 5 – Test Equipment

APPENDIX C

Functional Tests

The following functional tests were carried out during thermal conditioning. These functional tests and the system configurations were extracted from the requirements

Test	Configuration	Functional Test	Notes
FCC 47 Part 2.1022	3S1C 40W <i>Cabinet A/C Powered Note MCR Sector 2 will Tx@ 5dBm</i>	TX: TM1 Max. Power Out; Frequency Error	Sector 1 (EAC)
		TX: TM 4 Pmax-18dBm Frequency Error	Sector 1 (EAC)
		TX:TM1 Max. Power Out Frequency Error	Sector 2 (TX1 MCR)
		TX: TM 4 Pmax-18dBm Frequency Error	Sector 2 (TX1 MCR)
		TX: OMA Frequency	OMA

Table 6 – Functional Tests

Functional Test	Pass / Fail Criteria
TX: Max. Power Out	+/- 2dB (+/-2.5dB*) from Manufactures Declared Power Output; 46dBm (40Watt System)
TX: Frequency Error	(50 Parts Per Billion = 0.05 Parts Per Million) TX Frequency 876.5 MHz x 0.05 PPM = (+/- 43.82Hz)
OMA Frequency Accuracy	(50 Parts Per Billion = 0.05 Parts Per Million) PPM = +/- 0.75Hz

Table 7 – Functional Tests Pass / Fail Criteria

All functional test Pass / Fail Criteria was extracted from Standards [3.4.3].

APPENDIX D
BTS Testing Photographs

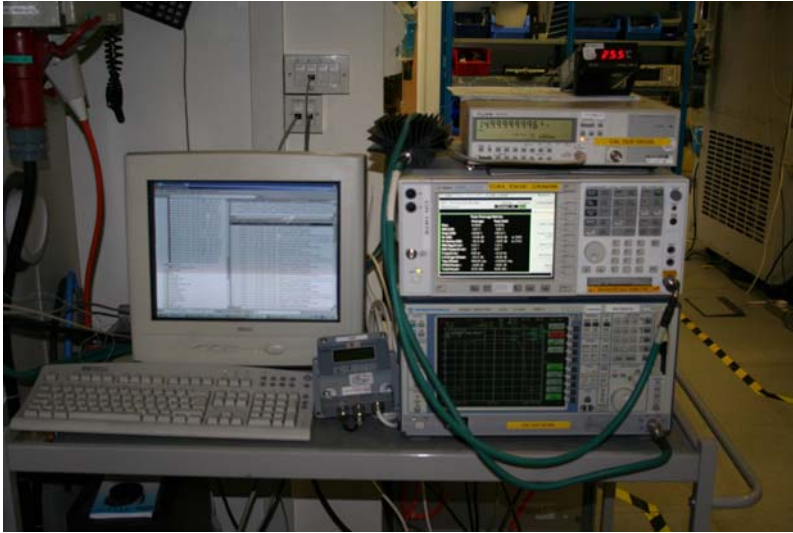

Figure 2 Test Equipment used in Measurement



Figure 3 Closed BTS under Test



Figure 4 Open BTS under Test