

11. Exhibit 11 FCC Filing Test Report

11.1 Listing of Required Measurements Section 2.1033(c)(14)

The data required by Section 2.1046 through 2.1057, inclusive, measured in accordance with the procedures set out in Section 2.1041.

Response: The lowest clock frequency in the **PCS Base Station System** is the 10 MHz rubidium reference oscillator. Conducted spurious measurements were performed over the range of 10 MHz to 20 GHz which is above the tenth harmonic of the transmit frequency range.

The following pages document the data required for the Product Certification authorization Class II Change of the Alcatel-Lucent **PCS Base Station System / FCC ID: AS5ONEBTS-10**, measured in accordance with the procedures set out in Section 2.1041 of the Rules. The Unit under Test, UUT Herein, was identified as serial number 10MH23CDA001.

Each required measurement and its corresponding exhibit number are:

Exhibit 12	Section 2.1046	Measurement of Radio Frequency Power Output
Exhibit 13	Section 2.1047	Measurement of Modulation Characteristics
Exhibit 14	Section 2.1049	Measurement of Occupied Bandwidth
Exhibit 15	Section 2.1051	Measurement of Spurious Emissions at Antenna
Exhibit 16	Section 2.1053	Field Strength of Spurious Radiation
Exhibit 17	Section 2.1055	Measurement of Frequency Stability

11.2 Test Equipment

11.2.1 Antenna Port Measurements Test Equipment

The following Equipment used for Antenna Port Measurements of RF Power, Modulation, Occupied bandwidth, Conducted Spurious Emissions. The following equipment was used for RF Power, Modulation, Occupied bandwidth and Conducted Spurious measurements that were performed from 10-11-2012 through 12-03-2012

<u>Equipment</u>	<u>Description</u>	<u>Reference #</u>	<u>Calibration Date</u>
Power Meter:	Agilent N1912A P Series Power Meter	E915	03/09/2012,
Power Head	Agilent N1921A 0.05-18GHz Wideband Pwr Sensor	E914	01/19/2012
EMC Analyzer	Rohde & Schwarz ESIB 40	E907 82-11301680	03/23/2012
Code Domain Analyzer	Agilent E4440A PSA Transmitter Tester	E1055	03/19/2011 (2yr cycle)
Computer Controller:	PC w/WIN OS & Agilent VSA Software		N/A
Computer Controller:	PC w/WIN OS	POR-2,	N/A
Low Pass Filter:	10 MHz-1.93 GHz, Custom manufactured	PCSLPF-10	02/03/12
High Pass Filters:	1.99-20 GHz, Custom manufactured	PCSHPF-10	02/03/12
The following test equipment was used as identified on individual data sheets:			
EMC Spectrum Analyzer	Rohde & Schwarz FSEM-30	E927 / 167437	04/24/2013
EMC Receiver / SA	Rohde & Schwarz ESIB-40	E936 / 166737	06/04/2013
EMC Receiver / SA	Rohde & Schwarz ESIB-40	E907 / 1000101	09/20/2013

11.2.2 Antenna Port Measurements Test Coupler

The RF Test coupler used for antenna port conducted testing is maintained calibration verified as a unit. The individual components are listed below. It is identified as Green 200W MULE. for Green Low Intermod High Power 200W. The MULE acronym stands for Multi Use Laboratory Equipment.

RF Test coupler Green 200W Mule performance verified on 4/27/12 and on 1/17/13

Directional Coupler:	HP 772D Dual Directional Coupler HP s/n 2039A00548/ FAC000WH013007ANJ0117
Attenuator, Variable	HP 8494B DC-18 GHz digital attenuator MY41110681
Attenuator, Variable	HP 8495B DC-18 GHz digital attenuator MY42140030
Attenuator, Fixed	Weinschel Corp DC-18 GHz, 200W Low Intermod 6791, s/n 002
Test Cables:	UFB197C-1-0240 & 0960-50U5GL s/n 007 & 003

11.2.3 Radiated Spurious Emissions Test Equipment

The following Equipment used for Radiated Spurious Measurements.

<u>Device</u>	<u>Manufacturer / Model / Description</u>	<u>GPCL ID</u>	<u>Last Cal Date</u>	<u>Term, mo</u>
EMC Spectrum Analyzer	Agilent / E7405A / 100Hz - 26.5GHz	E692	5/15/2013	12
EMI Test Receiver	Rohde & Schwarz / ESIB40	E908	3/12/2013	24
Attenuator 6 dB	Weinschel / 2-6 / 6dB, 5W, dc-18G	E1131	3/29/2013	24
Attenuator 6 dB	Weinschel / 2-6 / 6dB, 5W, dc-18G	E890	6/5/2013	24
Preamplifier	Hewlett Packard / 8449B / 1-26.6 GHz	E377	7/26/2013	12
Amplifier	Sonoma Instrument Co. / 310 / 9 kHz-1GHz	E507	6/5/2013	12
Biological Antenna	A.H. Systems Inc. / SAS521-2 / 25 -2000 MHz	E602	10/1/2012	24
Double-Ridged Horn	ETS Lindgren / 3117 / 1-18 GHz	E1073	9/9/2012	24
Double Ridged Horn	EMCO / 3115 / 1-18 GHz	E433	9/12/2012	24
Double Ridged Horn	EMC Test Systems / 3116 / 18-40 GHz	E520	12/26/2012	24
High Pass Filter	Trilithic / 5HC2850/18050-1.8-KK / PCS HPF	E986	03/20/2012	24

12. Exhibit 12 - Measurement Of Radio Frequency Power Output

FCC SECTION 2.1046RF power output.

For 3 MHz LTE 2x MIMO transmit carrier operation, the Alcatel-Lucent's PCS MCR1900 Transceiver System is specified to provide a continuous maximum power output of 32 Watt at each of its two transmit antenna terminals (45.05 dBm +2/-4 dB for each of the carriers). It also has a minimum power output at the antenna terminals of 0.05 Watts (17.0 dBm +2 / -4 dB). This power capability was demonstrated across the PCS downlink band of 1930 MHz to 1990 MHz.

For 5 MHz LTE 2x MIMO transmit carrier operation, the Alcatel-Lucent's PCS MCR1900 Transceiver System is specified to provide a continuous maximum power output of 48 Watt at each of its two transmit antenna terminals (46.81 dBm +2/-4 dB for each of the carriers). It also has a minimum power output at the antenna terminals of 0.08 Watts (19.05 dBm +2 / -4 dB). This power capability was demonstrated across the PCS downlink band of 1930 MHz to 1990 MHz.

12.1 RF Power Measurements

The test arrangements used to measure the radio frequency power output of the **PCS Base Station System/ AS5ONEBTS-10** is on the following page. Measurements were made respectively at each frequency where Occupied Bandwidth measurements were performed. This Class II Change is for use of the **PCS Base Station System** with 40W P2PAM amplifier modules supporting either 3M00F9W or 5M00F9W LTE carriers. Operation at 48W required a minimum of two amplifiers in the diversity path and two or three amplifiers in the primary path. Data provided herein used that configuration for all tests.

Demonstration of compliance with the operation was demonstrated for PCS Blocks A, D, B, E, F and C for the 1930-1990 downlink band as identified in this application. There is no retuning or change in hardware necessary for operation in any PCS Block. This testing requires that the J4 power level be calibrated for the specific channel of use. The test configuration, Figure 12a, allowed the measurement of output power for each channel investigated for Occupied Bandwidth. These included the upper and lower Block edges for each Block. The attenuation range was also verified

The applied signal, from the **PCS Base Station System/ AS5ONEBTS-10**, met the recommended characteristics per **3GPP TS 36.211 V9.1.0 (2010-03)** 3rd Generation Partnership Project; Technical Specification Group Radio Access Network; Evolved Universal Terrestrial Radio Access (E-UTRA); Physical Channels and Modulation (Release 9).

The power was set to the specified maximum carrier power for the specific Emissions Designator at each measurement frequency.. Power was verified for the QPSK, 16QAM and 64QAM modulation configurations. The specific Frequencies and channels and set power level was documented on each "Occupied Bandwidth" sheet and in Table 12.1 and Table 12.2

12.2 RF Power Measurements Result

For the Primary and Diversity antenna ports the **Base Station System/ AS5ONEBTS-10** delivered a minimum of 32 Watts for Emissions designator 3M00F9W and 48 Watts for Emissions Designator 5M00F9W when measured at the antenna output connection. This data is tabulated below and was recorded on the Occupied Bandwidth Data Sheets for each frequency Block. The Peak to Average Ratio (PAR/CCDF) was recorded as part of the Modulation verification documented in Exhibit 13. The measurements verify that the Peak to Average Ratio were less than 13 dB

Note: The **PCS Base Station System/ AS5ONEBTS-10** is a multi channel linear amplifier and its maximum power level is verified at each cell site during setup of the Alcatel-Lucent 9228 Macro (Formally Modular Cell 4.0B)

12.3 Test Equipment

12.3.1 Antenna Port Measurements Test Equipment

The following Equipment used for Antenna Port Measurements of RF Power, Modulation, Occupied bandwidth, Conducted Spurious Emissions.

The following equipment was used for RF Power, Modulation, Occupied bandwidth and Conducted Spurious measurements that were performed from 10-11-2012 through 12-03-2012

<u>Equipment</u>	<u>Description</u>	<u>Reference #</u>	<u>Calibration Date</u>
Power Meter:	Agilent N1912A P Series Power Meter	E915	03/09/2012,
Power Head	Agilent N1921A 0.05-18GHz Wideband Pwr Sensor	E914	01/19/2012
EMC Analyzer	Rohde & Schwarz ESIB 40	E907 82-11301680	03/23/2012
Code Domain Analyzer	Agilent E4440A PSA Transmitter Tester	E1055	03/19/2011 (2yr cycle)
Computer Controller:	PC w/WIN OS & Agilent VSA Software		N/A
Computer Controller:	PC w/WIN OS	POR-2,	N/A
Low Pass Filter:	10 MHz-1.93 GHz, Custom manufactured	PCSLPF-10	02/03/12
High Pass Filters:	1.99-20 GHz, Custom manufactured	PCSHPF-10	02/03/12
The following test equipment was used as identified on individual data sheets:			
EMC Spectrum Analyzer	Rohde & Schwarz FSEM-30	E927 / 167437	04/24/2013
EMC Receiver / SA	Rohde & Schwarz ESIB-40	E936 / 166737	06/04/2013
EMC Receiver / SA	Rohde & Schwarz ESIB-40	E907 / 1000101	09/20/2013

12.3.1.1 Antenna Port Measurements Test Coupler

The RF Test coupler used for antenna port conducted testing is maintained calibration verified as a unit. The individual components are listed below. It is identified as Green 200W MULE. for Green Low Intermod High Power 200W. The MULE acronym stands for Multi Use Laboratory Equipment.

RF Test coupler Green 200W Mule performance verified on 4/27/12 and on 1/17/13

Directional Coupler:	HP 772D Dual Directional Coupler HP s/n 2039A00548/ FAC000WH013007ANJ0117	
Attenuator, Variable	HP 8494B DC-18 GHz digital attenuator	MY41110681
Attenuator, Variable	HP 8495B DC-18 GHz digital attenuator	MY42140030
Attenuator, Fixed	Weinschel Corp DC-18 GHz, 200W Low Intermod	6791, s/n 002
Test Cables:	UFB197C-1-0240 & 0960-50U5GL	s/n 007 & 003

Figure 12 RF Power Test Configuration

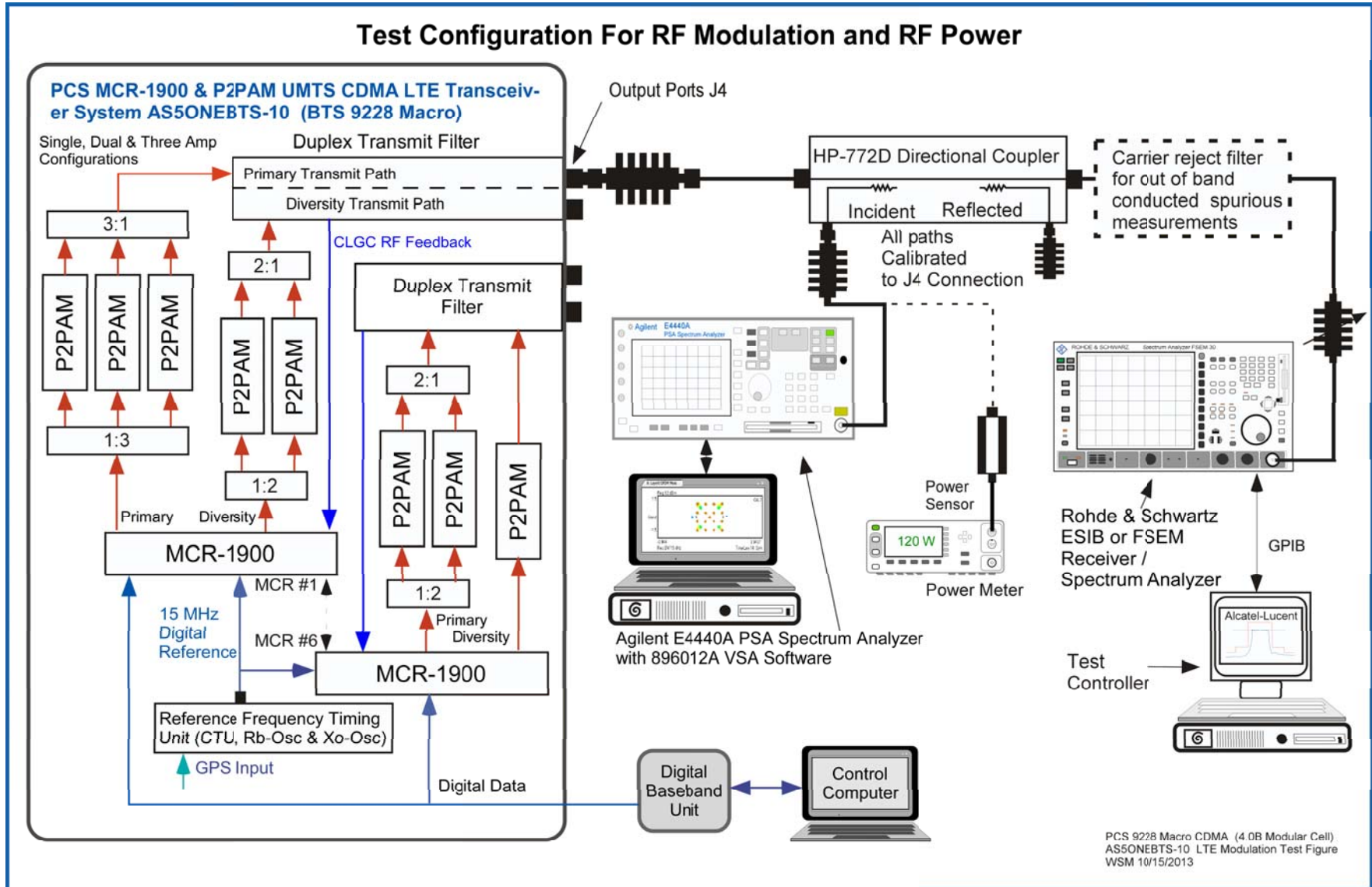

Table 12.1 Measurements required: RF power output 3M00F9W.

PCS - Block	PCS Channel #	Number of carriers	# of amplifiers in Primary Path	Primary Power per Carrier, W/c	# of amplifiers in Diversity Path	Diversity Power per Carrier, W/c	Results RF Power
A	30	1	2	32	1	32	Compliant
A	270	1	2	32	1	32	Compliant
D	330	1	2	32	1	32	Compliant
D	370	1	2	32	1	32	Compliant
B	430	1	2	32	1	32	Compliant
B	670	1	2	32	1	32	Compliant
E	730	1	2	32	1	32	Compliant
E	770	1	2	32	1	32	Compliant
F	830	1	2	32	1	32	Compliant
F	870	1	2	32	1	32	Compliant
C	930	1	2	32	1	32	Compliant
C	1170	1	2	32	1	32	Compliant

Table 12.2 Measurements required: RF power output 5M00F9W.

PCS - Block	PCS Channel #	Number of carriers	# of amplifiers in Primary Path	Primary Power per Carrier, W/c	# of amplifiers in Diversity Path	Diversity Power per Carrier, W/c	Results RF Power
A	50	1	3	48	2	48	Compliant
A	250	1	3	48	2	48	Compliant
D	350	1	3	48	2	48	Compliant
B	430	1	3	48	2	48	Compliant
B	670	1	3	48	2	48	Compliant
E	750	1	3	48	2	48	Compliant
F	850	1	3	48	2	48	Compliant
C	950	1	3	48	2	48	Compliant
C	1150	1	3	48	2	48	Compliant

13. Exhibit 13 Measurement Of Modulation And Signal Characteristics

SECTION 2.1047 Measurement Of Modulation Characteristics

The modulation characteristics and accuracy of the **PCS Base Station System/ AS5ONEBTS-10** output signal is a function of the input signal which is provided by the PCS Multi Carrier Radio (**MCR-1900**) which was authorized by the Federal Communications Commission under **FCC ID: AS5ONEBTS-09** and granted February 22, 2005 for PCS Blocks A-C.

13.1 Modulation Description

The LTE spectrum while appearing similar to CDMA differs greatly in complexity. The modulation used in evaluating the **PCS Base Station System's** Multi Carrier Radio **MCR-1900** are described in the pertinent standards documents which include **3GPP TS 36.211 V9.1.0 (2010-03) titled: 3rd Generation Partnership Project; Technical Specification Group Radio Access Network; Evolved Universal Terrestrial Radio Access (E-UTRA); Physical Channels and Modulation (Release 9)**. The modulation is Orthogonal Frequency Division Multiple Access (OFDMA) which is processed into an uplink IF signal. The input data stream is divided into several parallel sub-streams of reduced data rate and each sub-stream is transmitted on a separate orthogonal sub-carrier. The sub-carriers are modulated using either QPSK, 16QAM or 64QAM. There is no single measure of the modulation quality other than to verify that the subcarrier modulation constellations visual orientation match the symbol and amplitude criteria is consistent with QPSK, 16QAM and 64QAM.

13.2 Results

The **PCS Base Station System** was configured in the test setup shown in Figure 13A. The antenna connection J4 output was evaluated with an Agilent Transmitter Analyzer consisting of an Agilent E4440A PSA Spectrum Analyzer with 896012A VSA Software. Measurements were performed at the PCS Channels shown in Table 13.2

13.2.1 Results Summary

For each of the PCS channels tested, the **PCS Base Station System's** modulated sub-carriers constellations were consistent for the modulation type. All of the modulation plots include the CCDF plot which indicates the Peak to Average Ratio (PAR) of the transmitted signal. For all measurements the PAR was between 8 and 11 dB which is compliant with the CFR which specifies that the PAR be less than 13 dB. The **PCS Base Station System's** transmit signal modulation parameters and constellation for PCS channel 650 is shown in Figures 13B, 13C and 13D below for QPSK, 16QAM and 64QAM. A complete copy of all of the modulation data is attached in the Appendix.

TABLE 13.2a Channels and Modulation Characteristics Measurement for 3M00F9W

PCS - Block	PCS Channel #	Primary Modulation	Primary Peak to Average Ratio (PAR)	Diversity Modulation	Diversity Peak to Average Ratio (PAR)	Results
A	30	QPSK	11	QPSK	11	Compliant
A	30	16QAM	10.5	16QAM	11	Compliant
A	30	64QAM	11	64QAM	10.5	Compliant
A	270	QPSK	11	QPSK	11	Compliant
A	270	16QAM	11	16QAM	11	Compliant
A	270	64QAM	11	64QAM	11	Compliant
D	330	QPSK	11	QPSK	11	Compliant
D	330	16QAM	11	16QAM	11	Compliant
D	330	64QAM	10.5	64QAM	11	Compliant
D	370	QPSK	11	QPSK	10.5	Compliant
D	370	16QAM	10.5	16QAM	11	Compliant
D	370	64QAM	10.5	64QAM	10.5	Compliant
B	430	QPSK	10.5	QPSK	11	Compliant
B	430	16QAM	10.5	16QAM	10.5	Compliant
B	430	64QAM	11	64QAM	11	Compliant
B	670	QPSK	11	QPSK	11	Compliant
B	670	16QAM	11	16QAM	11	Compliant
B	670	64QAM	11	64QAM	11	Compliant
E	730	QPSK	11	QPSK	11	Compliant
E	730	16QAM	11	16QAM	11	Compliant
E	730	64QAM	10.5	64QAM	11	Compliant
E	770	QPSK	11	QPSK	11	Compliant
E	770	16QAM	10.5	16QAM	11	Compliant
E	770	64QAM	11	64QAM	11	Compliant
F	830	QPSK	10.5	QPSK	11	Compliant
F	830	16QAM	11	16QAM	10.5	Compliant
F	830	64QAM	11	64QAM	11	Compliant
F	870	QPSK	10.5	QPSK	11	Compliant
F	870	16QAM	10.5	16QAM	11	Compliant
F	870	64QAM	11	64QAM	10.5	Compliant
C	930	QPSK	11	QPSK	11	Compliant
C	930	16QAM	11	16QAM	11	Compliant
C	930	64QAM	10.5	64QAM	11	Compliant
C	1170	QPSK	11	QPSK	10.5	Compliant
C	1170	16QAM	10.5	16QAM	11	Compliant
C	1170	64QAM	11	64QAM	11	Compliant

TABLE 13.2b Channels and Modulation Characteristics Measurement for 5M00F9W

PCS - Block	PCS Channel #	Primary Modulation	Primary Peak to Average Ratio (PAR)	Diversity Modulation	Diversity Peak to Average Ratio (PAR)	Results
A	50	QPSK	9.5	QPSK	9.5	Compliant
A	50	16QAM	9.5	16QAM	9.5	Compliant
A	50	64QAM	9.5	64QAM	9.5	Compliant
A	250	QPSK	9.5	QPSK	9.5	Compliant
A	250	16QAM	9.75	16QAM	9.5	Compliant
A	250	64QAM	9.75	64QAM	9.75	Compliant
D	350	QPSK	9.5	QPSK	9.5	Compliant
D	350	16QAM	9.9	16QAM	9.5	Compliant
D	350	64QAM	9.9	64QAM	9.5	Compliant
B	450	QPSK	9.5	QPSK	9.75	Compliant
B	450	16QAM	10	16QAM	9.5	Compliant
B	450	64QAM	9.5	64QAM	9.5	Compliant
B	650	QPSK	9.5	QPSK	9.5	Compliant
B	650	16QAM	9.5	16QAM	9.5	Compliant
B	650	64QAM	9.5	64QAM	9.5	Compliant
E	750	QPSK	9.5	QPSK	9.5	Compliant
E	750	16QAM	9.5	16QAM	9.5	Compliant
E	750	64QAM	9.5	64QAM	9.5	Compliant
F	850	QPSK	9.5	QPSK	9.5	Compliant
F	850	16QAM	9.5	16QAM	9.5	Compliant
F	850	64QAM	9.5	64QAM	9.5	Compliant
C	950	QPSK	9.5	QPSK	9.5	Compliant
C	950	16QAM	9.5	16QAM	9.5	Compliant
C	950	64QAM	10	64QAM	9.5	Compliant
C	1150	QPSK	9.5	QPSK	9.5	Compliant
C	1150	16QAM	9.5	16QAM	9.5	Compliant
C	1150	64QAM	9.5	64QAM	9.5	Compliant

Figure 13A; Test Setup for Antenna Port Measurement of Modulation Characteristics and Code Domain

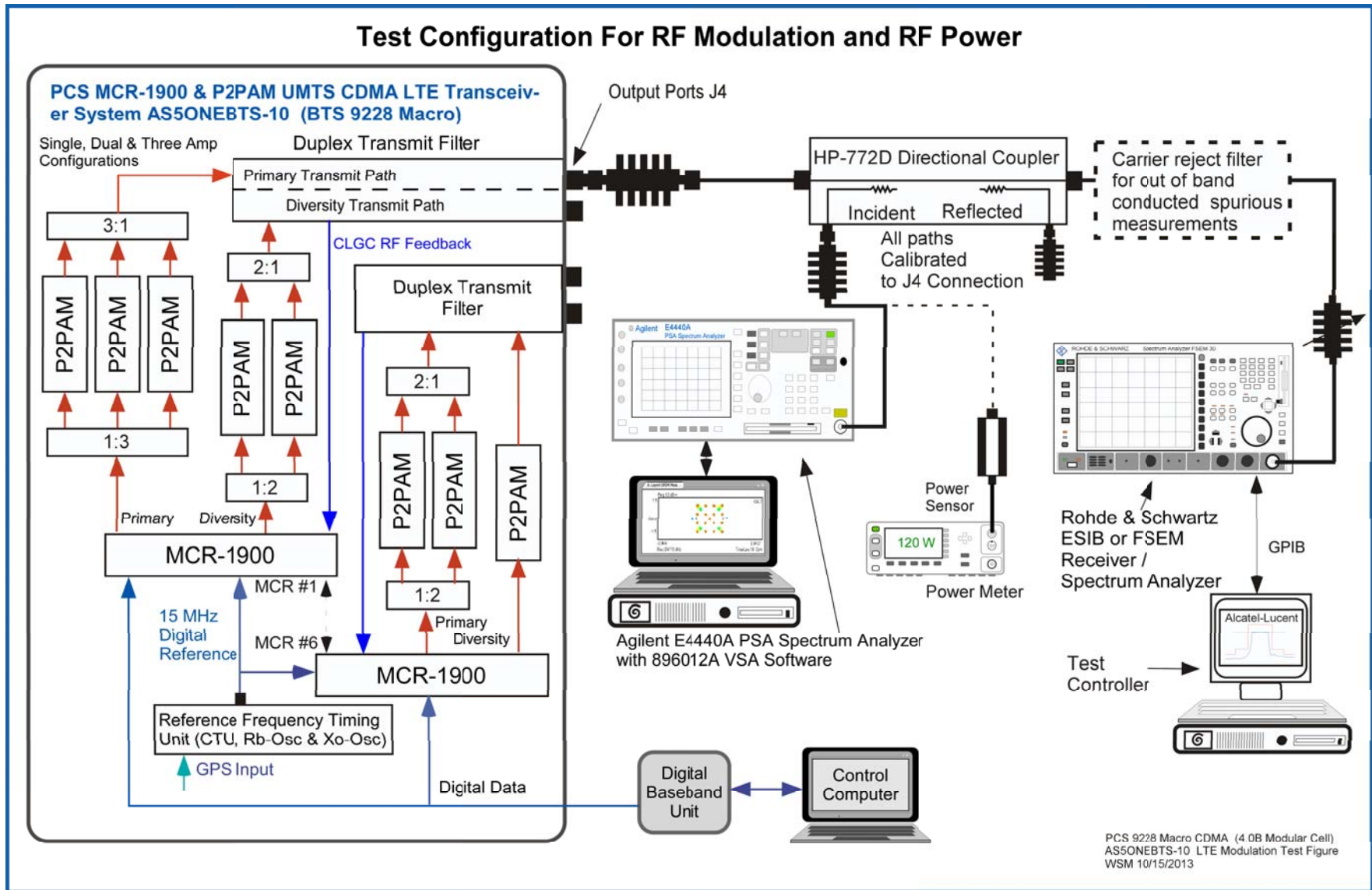

Figure 13B QPSK Modulation, Channel 30 Primary Tx Output 2 Amplifier

LTE - Agilent 89600B Vector Signal Analysis

11/21/2012 6:14:39 PM

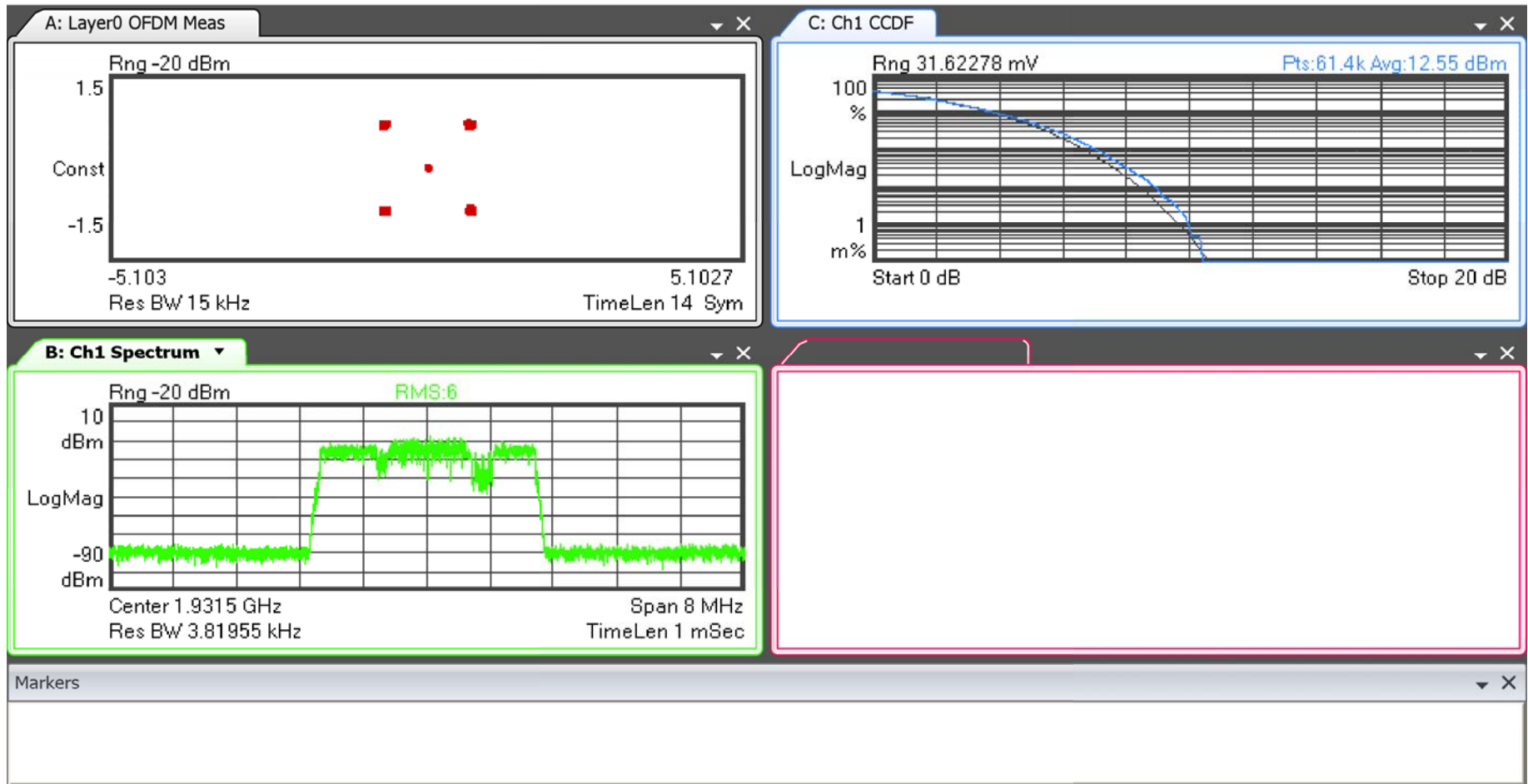

Figure 13C 16QAM Modulation, Channel 30 Diversity Tx Output 1 Amplifier

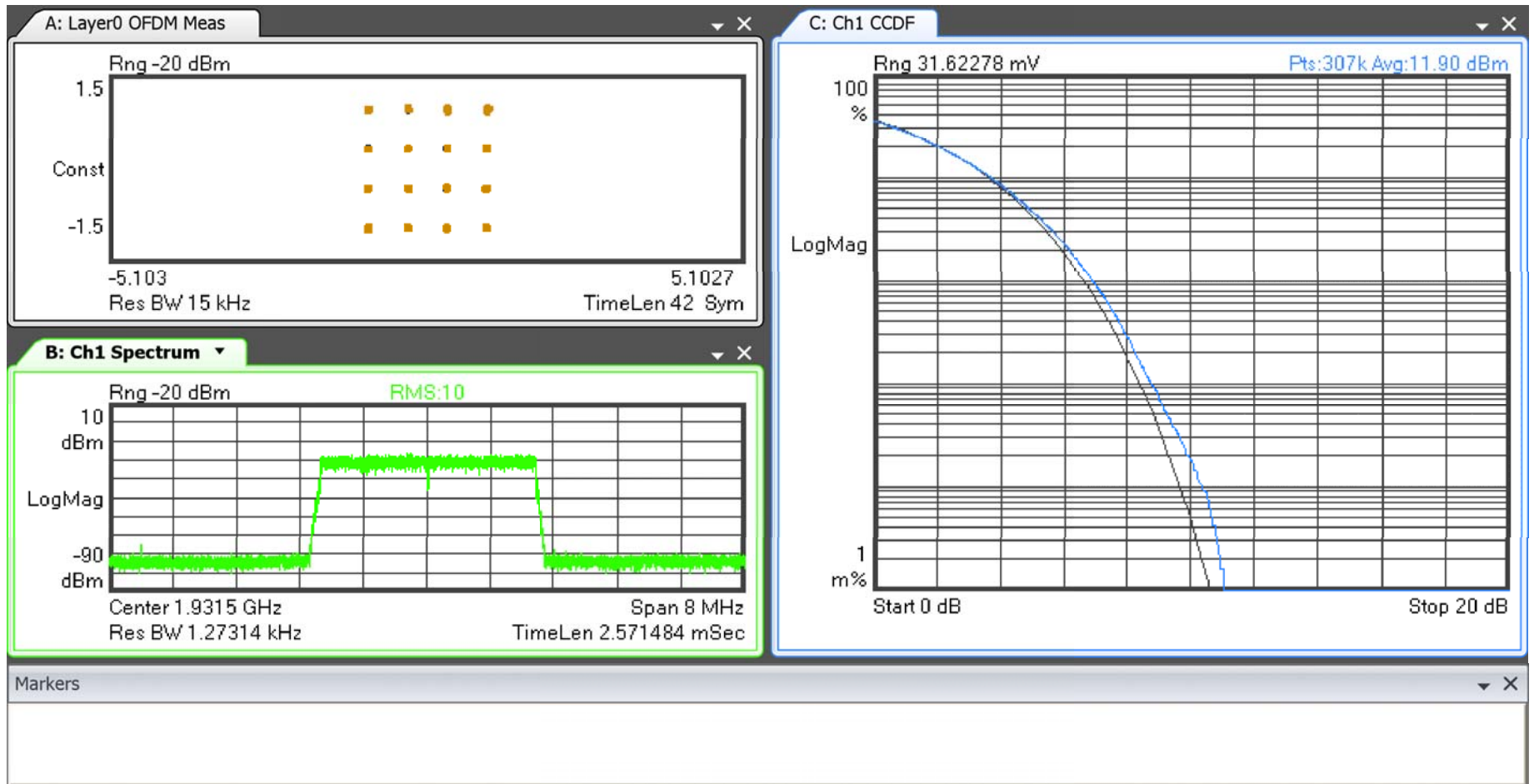
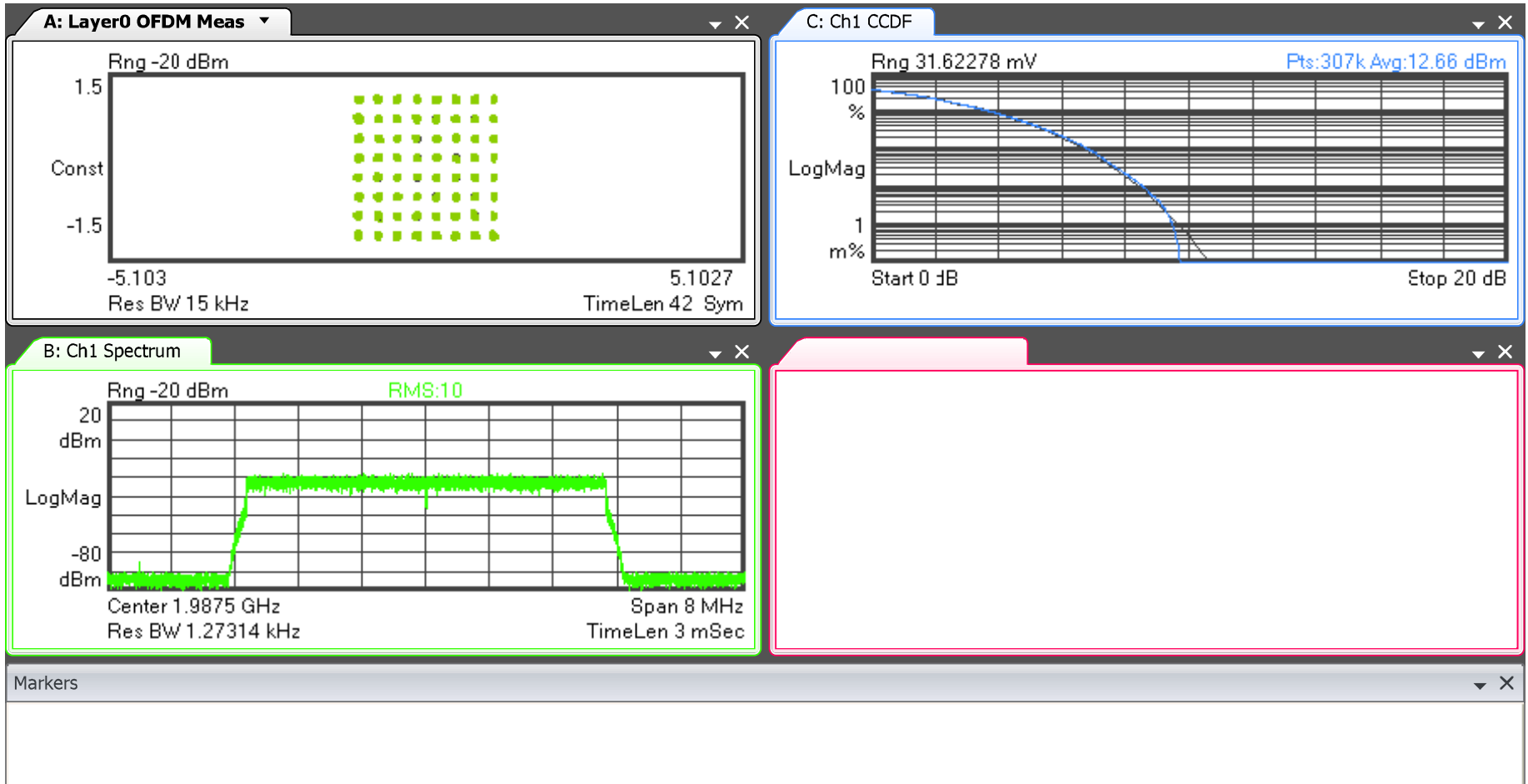

Figure 13D 64QAM Modulation, Channel 1150 Diversity Tx Output 2 Amplifier

LTE - Agilent 89600B Vector Signal Analysis

10/24/2012 10:20:19 AM



14. Exhibit 14 Measurement Of Occupied Bandwidth

FCC SECTION 2.1049 Measurement of Occupied Bandwidth

14.1 Measurement Overview

Occupied bandwidth measurements of the **PCS Base Station System** were performed while configured in all three of the defined subcarrier modulations defined in Exhibit 13. These measurements were performed with the **PCS Base Station System** operating in all PCS Blocks. This documents the typical performance of the **PCS Base Station System** while operating with the 3M00F9W LTE emissions designator at 32W per carrier and the 5M00F9W LTE emissions designator at 48W per carrier. All power adjustments were performed via the **MCR-1900 / AS5ONEBTS-10** and as described below.

The occupied bandwidth of the **PCS Base Station System/ FCC ID: AS5ONEBTS-10** was measured using a Rohde & Schwarz FSEM-30/ ESIB40 Spectrum Analyzer, a PC based instrumentation controller using TILE™ software and a calibrated RF attenuation and coupled signal path. The RF power level was measured and adjusted via the test setup in the Figure below. The set RF output from the transmitter was reduced by calibrated broadband RF Couplers and attenuators to amplitudes usable by the spectrum analyzer and power meter. The attenuation factors are reflected in the displayed values of the charts which are documented in absolute dBm. The typical occupied bandwidth measurement for the 3M00F9W LTE signal displays the signal adjusted to the -20 dBc level corresponding to the corrected RF power level for a 30 kHz resolution bandwidth (RBW) measurement of a 3 MHz signal ($-20 \text{ dB} = 10 \log(30 \text{ kHz} / 3 \text{ MHz})$). This set-point was performed as follows:

For each test the power calibration was individually verified at the transmitter antenna connection (J4) with a power meter by using the test setup depicted in Figure 14A. The power calibration was performed to calibrate the setting to the power meter measurement as a reference for both the measured 30 kHz Occupied Bandwidth signal at the -20 dBc (25.05 dBm) line and a 3 MHz RBW measurement against the “Top of Mask” limit as depicted in Figure 14B. The “Top of Mask” limit corresponds to a single carrier signal at the specified power level of 32 W/c as measured with an RBW of 3 MHz. Since the transmitter J4 output has a bandwidth of 3 MHz and the maximum analyzer resolution bandwidth is 3 MHz the power calibration reference line is the top of mask. The Top of Mask is +45.05 dBm and the power calibration line is thus 45.05 dBm. For power verification, the measurement made with an RBW setting of 3 MHz should align the spectrum analyzer measurement with the measurement performed using a power meter. The power meter has greater power accuracy and is thus used as the standard. The power level verifications using a power meter were first performed as part of each Occupied Bandwidth measurement. The signals, measured by the analyzer at RBW's of 3 MHz and 30 kHz, were corrected for path loss and were plotted against the mask limit. As part of the correlation between the power meter measurement and the test analyzer, software was used to place the 3 MHz RBW signal at the carrier power calibration line for the LTE 3 MHz bandwidth signals. The carrier as measured with 3 MHz and 30 kHz RBW were corrected with the same attenuation factors and the two measurements were co-plotted on the same graph. A typical single carrier example is shown in Figure 14B which depicts a single carrier (30 A Block) inside the mask appropriate for a single 3 MHz carrier in A Block.

The test procedure described above, references the carrier power and accurately places the 30 kHz RBW measured carrier at the -20 dBc reference line. For the 5M00F9W measurement the process is the same except the -22.22 dB below the top of mask reference line is at 24.59 dBm and the power calibration line is at 44.59 dBm to adjust for the bandwidth differences.

All of the plots are presented with a sufficiently wide frequency span for the specific signals or Block of interest and again for the entire PCS Band. This allows for ease of comparison of the broadband carriers performance. This data was recorded for all PCS blocks using the TILE™ software and placed in the Occupied Bandwidth Data Sheets.

14.2 Block Organization and Tests Performed

The **PCS Base Station System** product line allows the use of transmit filters with bandwidths of 20 MHz to as wide as 65 MHz. The use of Enhanced Digital Pre Distortion provides the spurious control which allows the use of wide bandwidth PCS Band filters. These wideband filters provide for the least spurious reduction at “edge of block” and “edge of band” and thus represent the most difficult compliance configuration. The filters do not provide for any spurious reduction at the internal block edges inside the band. The testing of the product documented herein was performed with 65 MHz PCS band filters. The demonstration of compliance for the **LTE PCS Base Station System** transmit configurations were performed for operation in PCS Blocks A, D, B, E, F and C for 1930-1990 MHz operation. The presented data for this Class II change demonstrates the **LTE PCS Base Station System** products conformance.

14.3 Applied Signal Characteristics

In order to adequately evaluate performance the occupied bandwidth was measured with each of the sub-carrier modulation factors and co-plotted. The applied signal from an **PCS Base Station System/ FCC ID: AS5ONEBTS-10**, met the recommended characteristics as defined in **3GPP TS 36.211 V9.1.0 (2010-03) titled: 3rd Generation Partnership Project; Technical Specification Group Radio Access Network; Evolved Universal Terrestrial Radio Access (E-UTRA); Physical Channels and Modulation (Release 9)**.

The power was set to the specified 32 W/carrier maximum for 3M00F9W and 48W/c for 5M00F9W at each measurement frequency to verify the spectral performance at that power level at each specific frequency of interest. Power was also verified for the QPSK, 16QAM and 64QAM modulation configurations. The attenuation range was also verified. The specific Frequencies and channels and set power level was documented on each "Occupied Bandwidth" sheet.

The FCC limits contained in **47CFR 24.238 1-Oct-2010** were followed.

14.3.1 Signal Bandwidth 3M00F9W

The 99%/-26dB signal bandwidth was measured using the setup of Figure 14A for channel 30. The measurement performed with a resolution bandwidth of 30 kHz and 300 kHz verified the signal is within the parameters of the emissions designator and is documented below.

Span	RBW	Step Size	99% BW	-26 dB Bw
MHz	kHz	kHz	MHz	MHz
8	30	10	2.71	2.815

14.3.2 Signal Bandwidth 5M00F9W

The 99%/-26dB signal bandwidth was measured using the setup of Figure 14A for channel 30. The measurement performed with a resolution bandwidth of 30 kHz and 300 kHz verified the signal is within the parameters of the emissions designator and is documented below

Span	RBW	Step Size	99% BW	-26 dB Bw
MHz	kHz	kHz	MHz	MHz
8	30	10	4.52	4.63

14.4 Measurement Offset

The spectrum analysis output plots shows the peak of the 3 MHz LTE channel signal -20 dB below the Mask reference / “zero dBc line” of the spectrum analyzer for the following reason: For the OFDM system there is no carrier without modulation. Since the LTE signal is broadband and 3 or 5 MHz wide, all measurements performed at narrower resolution bandwidths need be adjusted for the reduction in signal energy. The following relationship was used to provide the correct level for an unmodulated carrier vs. the modulated signal.

$$10*\log(\text{Resolution Bandwidth/ Transmit Bandwidth}) = \text{Signal Offset} \tag{1}$$

For the peak of the 3 MHz LTE signal measured with a RBW of 30 kHz the signal offset is:

$$\text{Signal Offset} = 10*\log(30 \text{ kHz} / 3 \text{ MHz}) = -20 \text{ dB}$$

For the peak of the 5 MHz LTE signal measured with a RBW of 30 kHz the signal offset is:

$$\text{Signal Offset} = 10*\log(30 \text{ kHz} / 5 \text{ MHz}) = -22.22 \text{ dB}$$

Limits which are specified as appropriate at a given RBW can be measured and evaluated at other RBW’s if the limit is adjusted per equation (1). To account for a worst case summation of multiple transmit signals, per KDB 662911 D01 Multiple Transmitter Output v01r0, the level needs be adjusted by 10LOG(N) where N= number of outputs. The adjustment is

$$\text{Additional offset dB} = 10* \log(N) \tag{2}$$

Limits adjusted per equation (1) need to account for multiple identical transmit outputs per equation (2).

14.5 Required Levels

Unlike CDMA there is no requirement in 3GPP TS 36.211 V9.1.0(2010-03) for Suppression inside the Licensee’s Frequency Block(s). Masks are therefore defined only by 47 CFR 24.238

The Limit in 47 CFR 24.238 for emissions in the 1 MHz band immediately outside and adjacent to a licensee’s frequency block is:

Emissions \leq 1 MHz outside the Block when measured with a RBW of 1% of the emissions Bandwidth shall be attenuated by :

$$-\{43+10\log(\text{mean power output in watts})\} = -13 \text{ dBm}$$

The Limit in 47 CFR 24.238 for emissions outside a licensee’s frequency block is:

Emissions $>$ 1 MHz outside the Block, when measured with a RBW of 1 MHz, shall be attenuated by :

$$-\{43+10\log(\text{mean power output in watts})\} = -13 \text{ dBm.}$$

Measurement at a Resolution Bandwidth of 30 kHz is based on our experience with 47 CFR 24.238 and **KDB 662911 D01**.

14.6 Adjusted Levels

The following levels apply when measurement of the above limits are performed with an RBW of 30 kHz.

1. On any frequency from the block edge to 1MHz above or below the Block edge the level shall not exceed -13 dBm when measured with a 30 kHz resolution bandwidth (Note 2 below).
For 32 Watts (3M00F9W) the required level is -13 dBm/ -58.05 dBc or -16dBm/-61.06 dBc for 2xMIMO
For 48 Watts (5M00F9W) the required level is -15.22 dBm/ -62.03 dBc or -18.22dBm/ -65.04 dBc for 2xMIMO
2. On any frequency greater than 1MHz above or below the Block edge, the level as measured with a 30 kHz RBW shall not exceed:
For 32 Watts (3M00F9W) the required level is -28.23 dBm / -31.24 dBm for 2xMIMO. (Note 2 below).
For 48 Watts (5M00F9W) the required level is -28.23 dBm / -33.46 dBm for 2xMIMO
 This is equal to -13 dBm / -16 dBm for 2x MIMO when measured with a 1 MHz resolution bandwidth. (Note 3 below)
3. From the edge of the Block to the 10th harmonic of the carrier at least

$$-\{43+10\log(\text{mean power output in watts})\} = -13 \text{ dBm. Or -16dBm for 2x MIMO}$$
 When measured with a 1 MHz resolution bandwidth.

Note 2: The -13 dBm level was computed as follows: The limit is specified as

$$-\{43+10\log(\text{mean power output in watts})\} \text{ dB} = -13 \text{ dBm}$$

When measured in a resolution bandwidth not less than 1% of the signal bandwidth. Since the carrier is a 3 MHz bandwidth signal, the limit is adjusted to

$$\text{For the 3M00F9W application: } -13 + 10\text{LOG}(30\text{kHz}/30 \text{ kHz}) \text{ dBm} = -13.00 \text{ dBm}$$

$$\text{For the 5M00F9W application: } -13 + 10\text{LOG}(30\text{kHz}/50 \text{ kHz}) \text{ dBm} = -15.22 \text{ dBm}$$

When accounting for a 2x MIMO signal, (per KDB 662911 D01 Multiple Transmitter Output v01r01), the level needs be adjusted by 10LOG(n) where n= number of outputs. The adjustment for n=2 is:

$$3.01 \text{ dB} = 10\text{LOG}(2)$$

The resultant limit for MIMO operation is:

$$\text{For the 3M00F9W application: } -13 \text{ dBm} - 3.01 \text{ dB} = -16.01 \text{ dBm; or}$$

$$\text{For the 5M00F9W application: } -15.22 \text{ dBm} - 3.01 \text{ dB} = -18.23 \text{ dBm;}$$

Note 3: The -31.24 dBm level is computed from -13 dBm measured with a 1 MHz resolution bandwidth adjusted by :

$$-13 + 10\text{LOG}(30\text{kHz}/1.0 \text{ MHz}) \text{ dBm} = -28.23 \text{ dBm}$$

When accounting for a 2x MIMO signal, (per KDB 662911 D01 Multiple Transmitter Output v01r01), the level needs be adjusted by 10LOG(n) where n= number of transmitter outputs. The adjustment for n=2 is:

$$3.01 \text{ dB} = 10\text{LOG}(2)$$

The resultant limit for MIMO operation is $-28.23 \text{ dBm} - 3.01 \text{ dB} = -31.24 \text{ dBm}$;

14.7 Mask Description for a Single Carrier.

The Mask limits are identical for the left and right side of the PCS Blocks and are as follows:

Figure 14B shows the 5 MHz LTE Mask limit for PCS Block A (1930-1945 MHz) for PCS channel 50. The horizontal line from a to aa (a-aa) is the 46.81 dBm/ 0 dBc reference level. The Power Calibration reference line g-gg is the top of mask reference line as the 3 MHz power calibration resolution bandwidth is less than the 5 MHz signal bandwidth.

The top of a typical 46.81 dBm single 5 MHz LTE QPSK carrier signal viewed at a resolution bandwidth of 30 kHz is shown at the 24.59 dBm/ -22.22 dBc line t-tt. This line is based on equations 1 and 2, and the ratio of the 5 MHz signal bandwidth and the 30 kHz resolution bandwidth of the spectrum analyzer.

The vertical line from a to b (i.e. a-b) and aa-bb are at the block edge for C Block. The horizontal lines c-b and bb-cc represent the limit for the 1st MHz outside the block. The placement of lines c-b and bb-cc is derived from evaluation of 1% of the signal bandwidth, the 30 kHz resolution bandwidth and adjustments for MIMO using the suggested value in of the rules.

Per Note 2 above, the limit for the 1st MHz outside the band with MIMO operation is **-18.23 dBm**.

The vertical line, c-d and cc-dd are the transitions at 1MHz outside the specified Block.

The horizontal line d-e and dd-ee are placed at the **-31.24 dBm level** per Note 3 above. The rules require a 1 MHz resolution bandwidth for measurements 1 MHz or greater outside the PCS band. Again, equation (1) and the ratio of 1 MHz to 5 MHz provides this value. The same logic was used in determining the other block and band edge tolerances.

14.8 Trace Description and Power Calibration

Figure 14B shows the 5 MHz LTE signal carrier operating in Block A channel 50 as measured with two different resolution bandwidths. The upper magenta trace displays the signal as measured with a resolution bandwidth of 3 MHz. The lower black trace is the same signal as measured with a 30 kHz resolution bandwidth and this is the appropriate trace for the mask evaluation. The wider resolution bandwidth allows for a true power calibration of the measured signal against the top of mask or Power calibration line. The top of the mask is appropriate for a single carrier power calibration with a signal bandwidth that is 3 MHz or narrower. If the signal bandwidth is greater than the measurement bandwidth a power calibration line which adjusts for the difference is appropriate for use.

For a 5M00F9W signal measured with a 3 MHz RBW the correction factor is:

$$-2.21 \text{ dB} = 10 * \text{Log}(3 \text{ MHz} / 5 \text{ MHz})$$

For a 48W / 46.81 dBm carrier the power calibration reference line is 46.81-2.21 = 44.59 dBm

These values are depicted on the occupied bandwidth charts as the dashed magenta Power Calibration Line gh-gg on each chart and as shown on example Chart 14B.

For a 3 MHz LTE signal carrier a power calibration line is unnecessary as the Top of Mask represents the true power.

14.9 Measurement of the 3 MHz Carrier Configuration

All of the tolerance lines for the output are referenced to the top of the Occupied Bandwidth mask, which is defined as 45.05 dBm/ zero dBc. For all measurements of the **PCS Base Station System/ FCC ID: AS5ONEBTS-10** Occupied Bandwidth, the output power was measured / adjusted individually to the 32 W level for each carrier and this is the 45.05 dBm value at the Top of Mask.

In order to depict the tolerance lines that are required by Sec 24.238 of the FCC Rules all measurements were made with a resolution bandwidth of 30 kHz and the limits were adjusted using equation (1). A sample detector was employed using minimum of 25 sweeps averaging per trace.

PCS - Block	PCS Channel #	Primary Occupied Bandwidth Compliance	Diversity Occupied Bandwidth Compliance
A	30	Compliant	Compliant
A	270	Compliant	Compliant
D	330	Compliant	Compliant
D	370	Compliant	Compliant
B	430	Compliant	Compliant
B	670	Compliant	Compliant
E	730	Compliant	Compliant
E	770	Compliant	Compliant
F	830	Compliant	Compliant
F	870	Compliant	Compliant
C	930	Compliant	Compliant
C	1170	Compliant	Compliant

14.10 Measurement of the 5 MHz Carrier Configuration

All of the tolerance lines for the output are referenced to the top of the Occupied Bandwidth mask, which is defined as 46.81 dBm/ zero dBc. For all measurements of the **PCS Base Station System/ FCC ID: AS5ONEBTS-10** Occupied Bandwidth, the output power was measured / adjusted individually to the 48 W level for each carrier and this is the 46.81 dBm value at the Top of Mask.

In order to depict the tolerance lines that are required by Sec 24.238 of the FCC Rules all measurements were made with a resolution bandwidth of 30 kHz and the limits were adjusted using equation (1). A sample detector was employed using minimum of 25 sweeps averaging per trace.

PCS - Block	PCS Channel #	Primary Occupied Bandwidth Compliance	Diversity Occupied Bandwidth Compliance
A	50	Compliant	Compliant
A	250	Compliant	Compliant
D	350	Compliant	Compliant
B	450	Compliant	Compliant
B	650	Compliant	Compliant
E	750	Compliant	Compliant
F	850	Compliant	Compliant
C	950	Compliant	Compliant
C	1150	Compliant	Compliant

14.11 Summary of Occupied Bandwidth Results

Both the 3M00F9W and 5M00F9W Occupied Bandwidth was fully compliant with FCC requirements. Measurements were performed at each block edge for each of the emissions designator and for both Primary and Diversity transmit ports.

The Block designation, PCS channels, frequencies and Measured RF Power are tabulated on each plot. The transmitter output signals are plotted for each frequency, modulation and channel of interest. Plots are provided for the PCS Block evaluated and two plots showing the three different modulations co-plotted together. This shows that the occupied bandwidth in the PCS Blocks in which this product can be operated, is in compliance with Section 24.238 of the Commission code. The signal used to show the occupied bandwidth is as defined and recommended in **3GPP TS 36.211 V9.1.0 (2010-03)**. The power output level was adjusted to provide the documented value on each chart.

RESULTS: The following exhibits illustrate the spectrums investigated and document compliance.

Figure 14A Test Setup for Antenna Port Measurement of Transmit Power, Occupied Bandwidth and Conducted Spurious Emissions

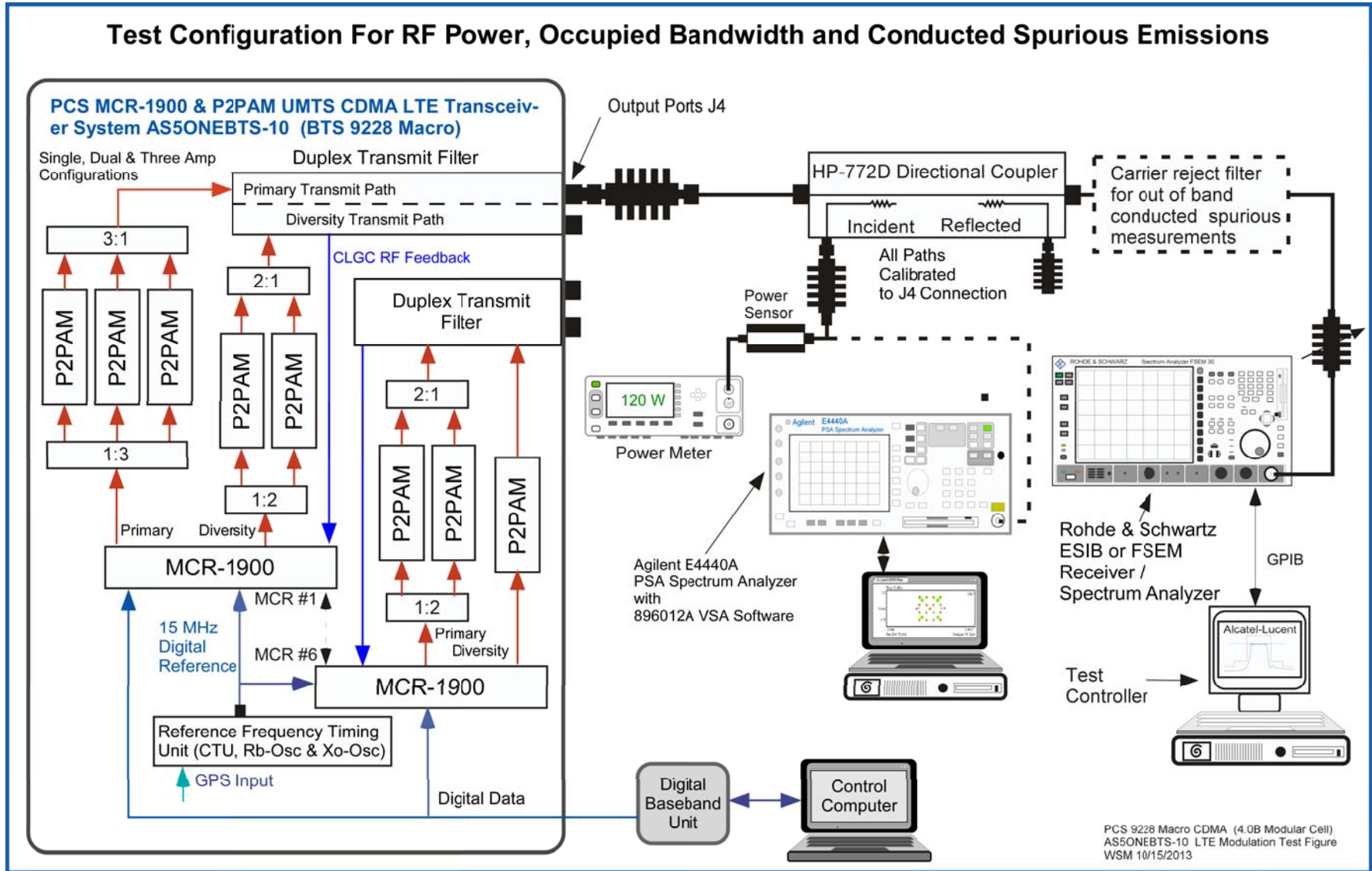
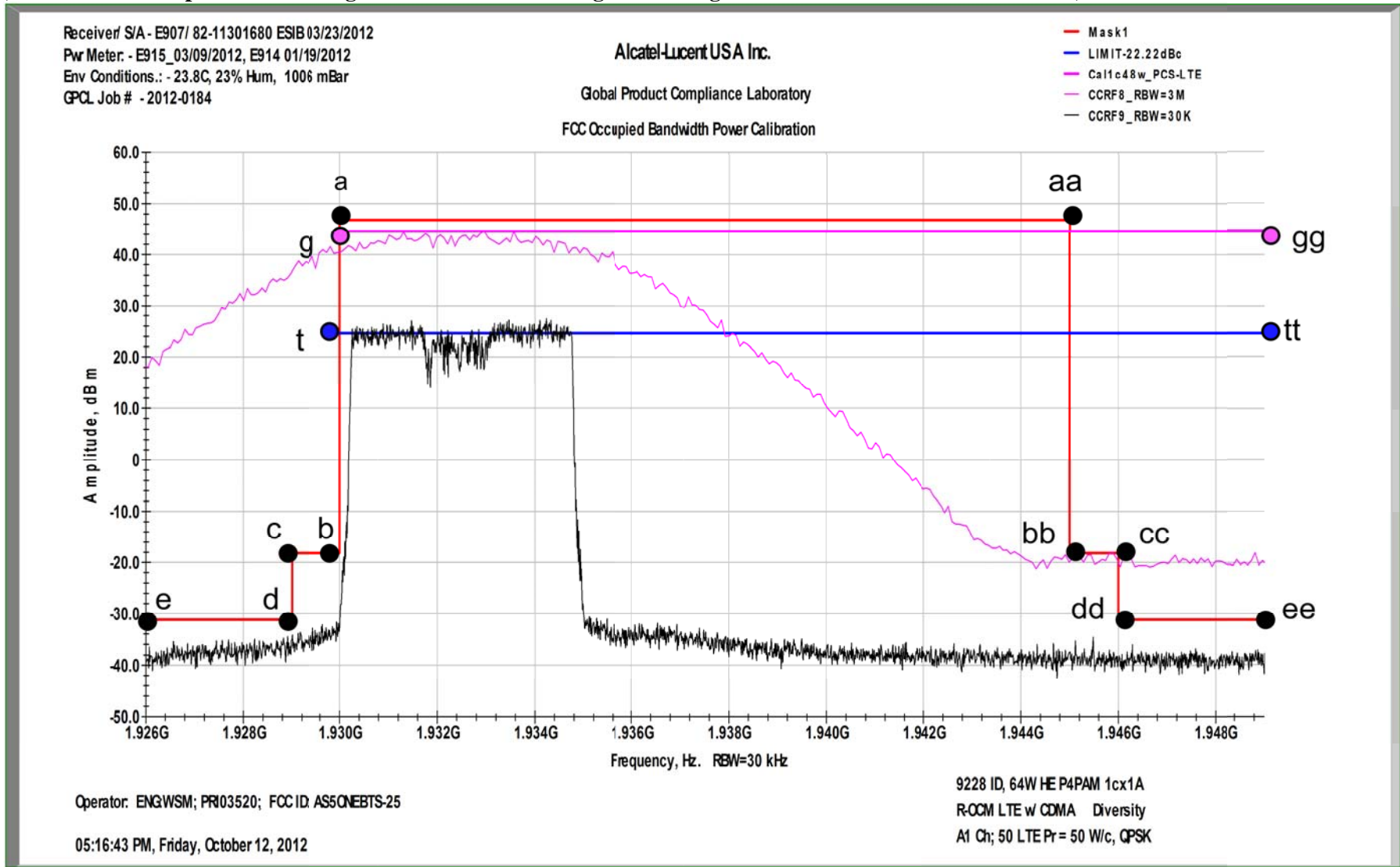

Figure 14B Occupied Bandwidth Mask for PCS Block Operation at 48 W with Power Calibration
(PCS A Block is depicted with a single 5 MHz LTE carrier signal showing use of the Power Calibration Trace)



**Measurements of
Transmitter Occupied Bandwidth
of
Alcatel-Lucent USA Inc.
LTE PCS 9228 Base Station Macro
FCC ID: AS5ONEBTS-10

Operational Configuration
with
Emissions Designator 3M00F9W
at 32 W/carrier**

W. Steve Majkowski NCE
FCC Wireless Compliance, CDMA Filing Lead
Alcatel-Lucent USA Inc.
Building 28-114J
600-700 Mountain Avenue, P.O. Box 636
New Providence, 07974-0636
Office: 908-582-3782
Cell: 732.259.1458
email: steve.majkowski@alcatel-lucent.com

FCC Occupied Bandwidth Emissions LTE3 MHz Ch A-30 1cx2A 32W/c 64QAM Primary Tx1

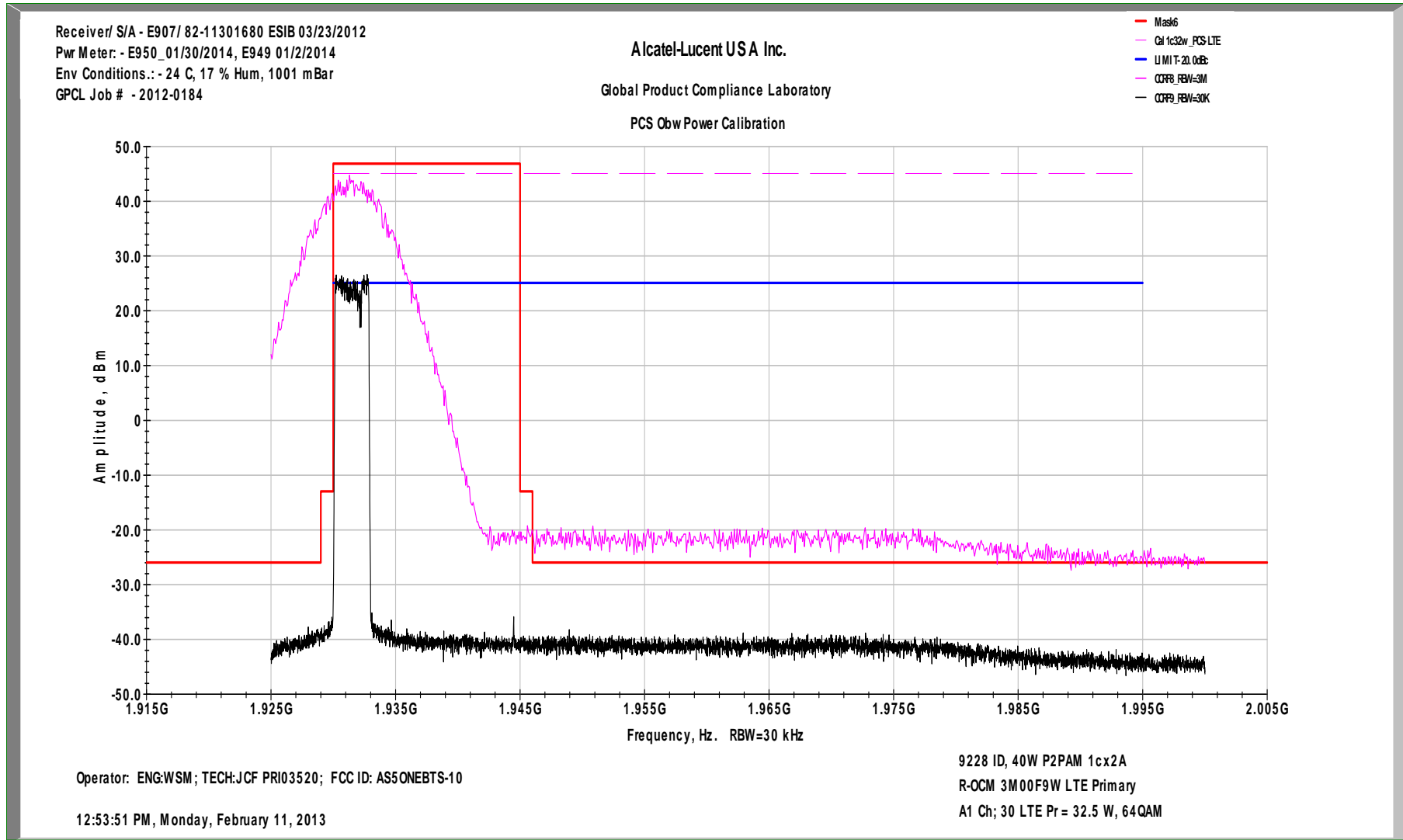

In-Band Intermodulation Graph LTE3 MHz Ch A-30 1cx2A 32W/c 64QAM Primary Tx1

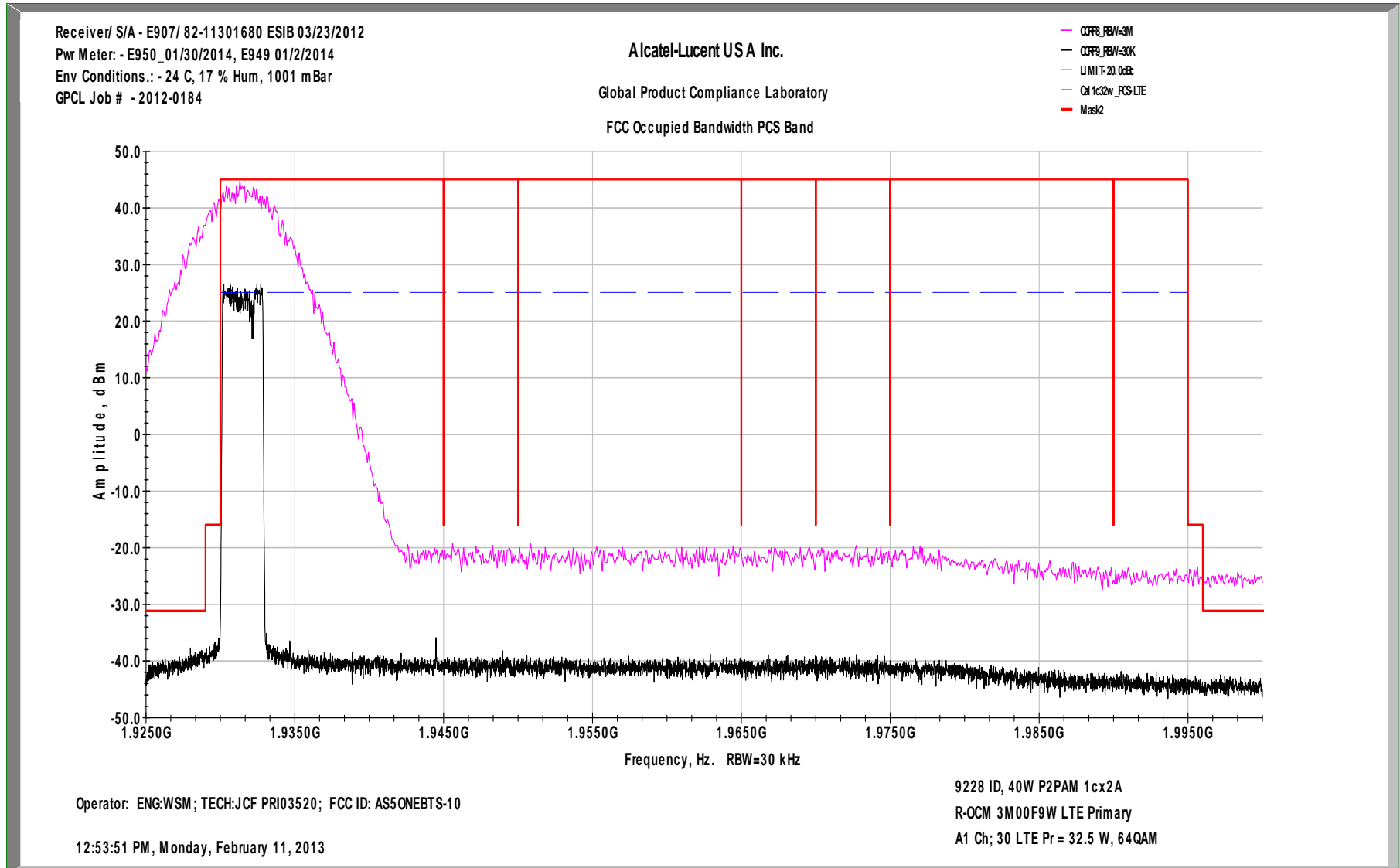

FCC Edge of Block Margin LTE3 MHz Ch A-30 1cx2A 32W/c 64QAM Primary Tx1

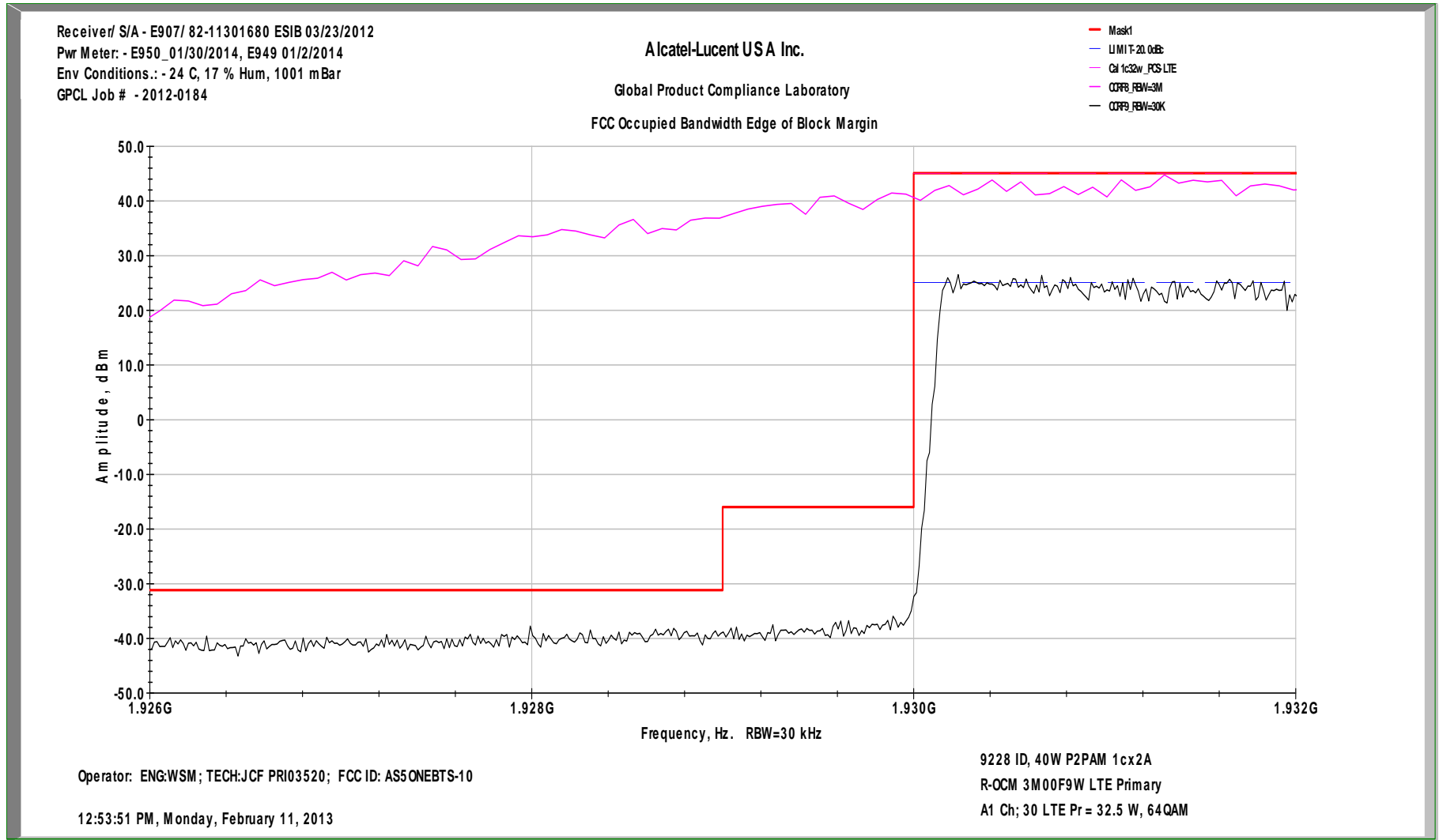

FCC Occupied Bandwidth w/ 3 Modulations LTE3 MHz Ch A-30 1cx2A 32W/c QPSK, 16QAM & 64QAM Primary Tx1

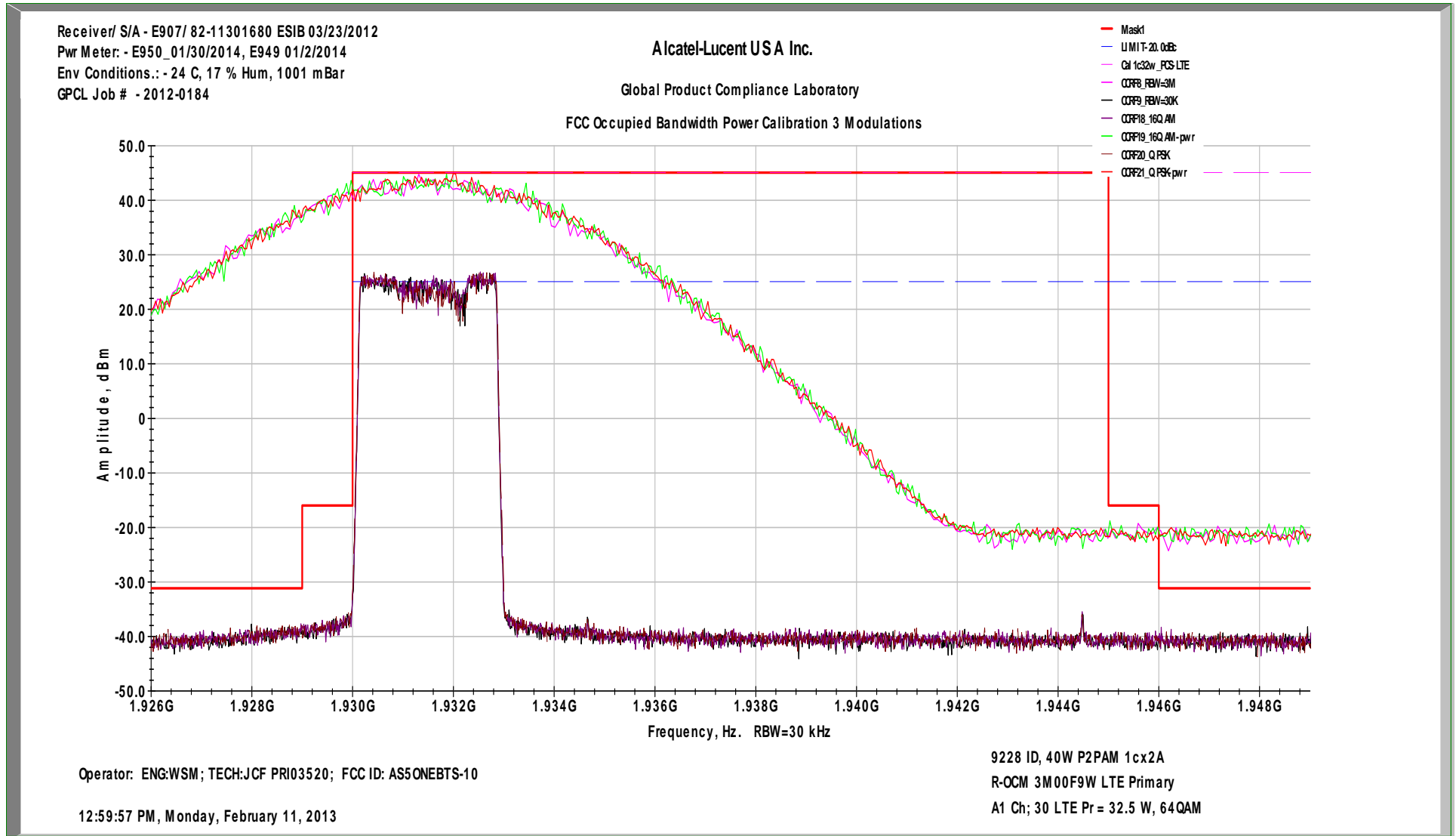

FCC Occupied Bandwidth Emissions LTE3 MHz Ch A-30 1cx1A 32W/c 64QAM Diversity Tx2

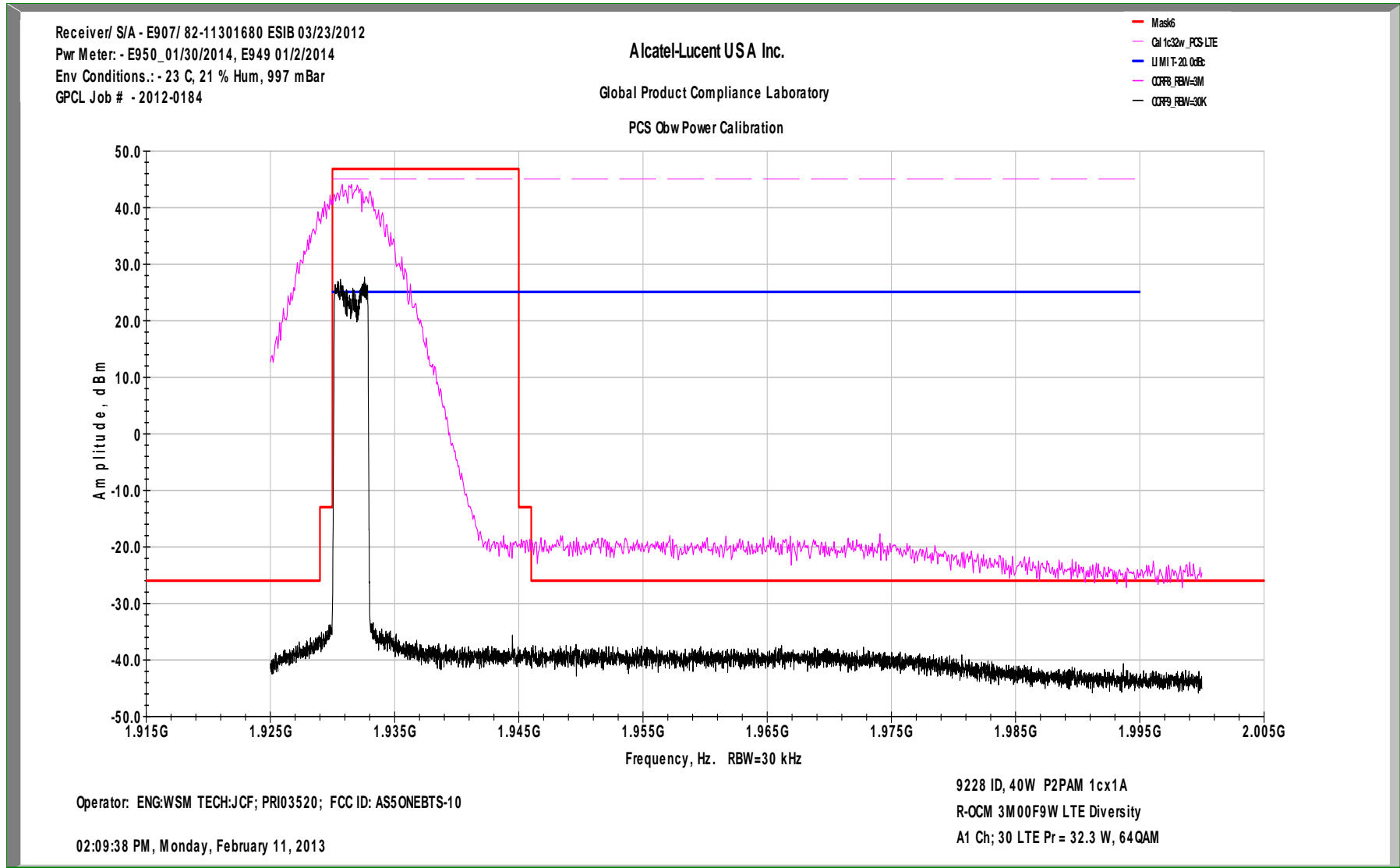

In-Band Intermodulation Graph LTE3 MHz Ch A-30 1cx1A 32W/c 64QAM Diversity Tx2

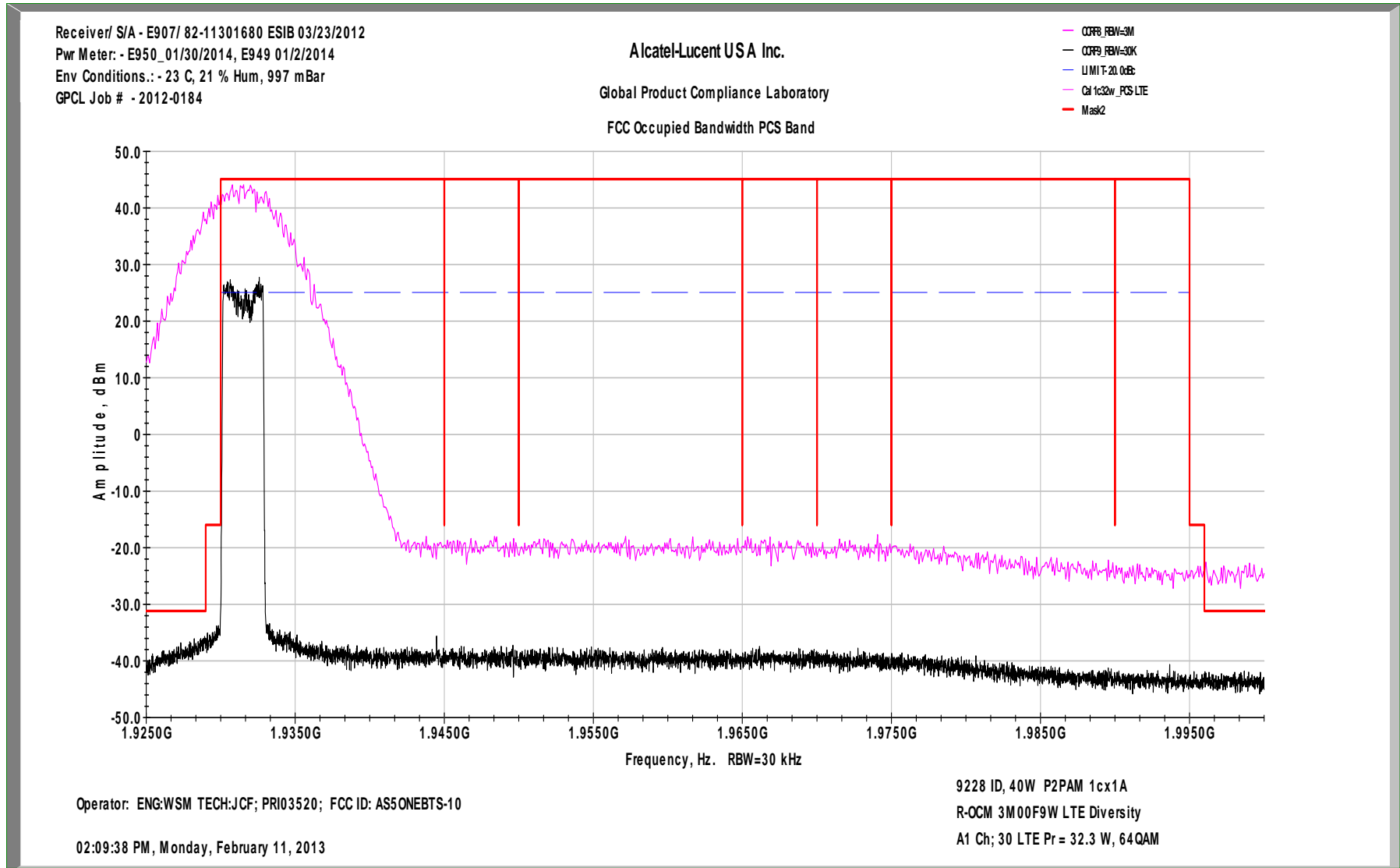

FCC Edge of Block Margin LTE3 MHz Ch A-30 1cx1A 32W/c 64QAM Diversity Tx2

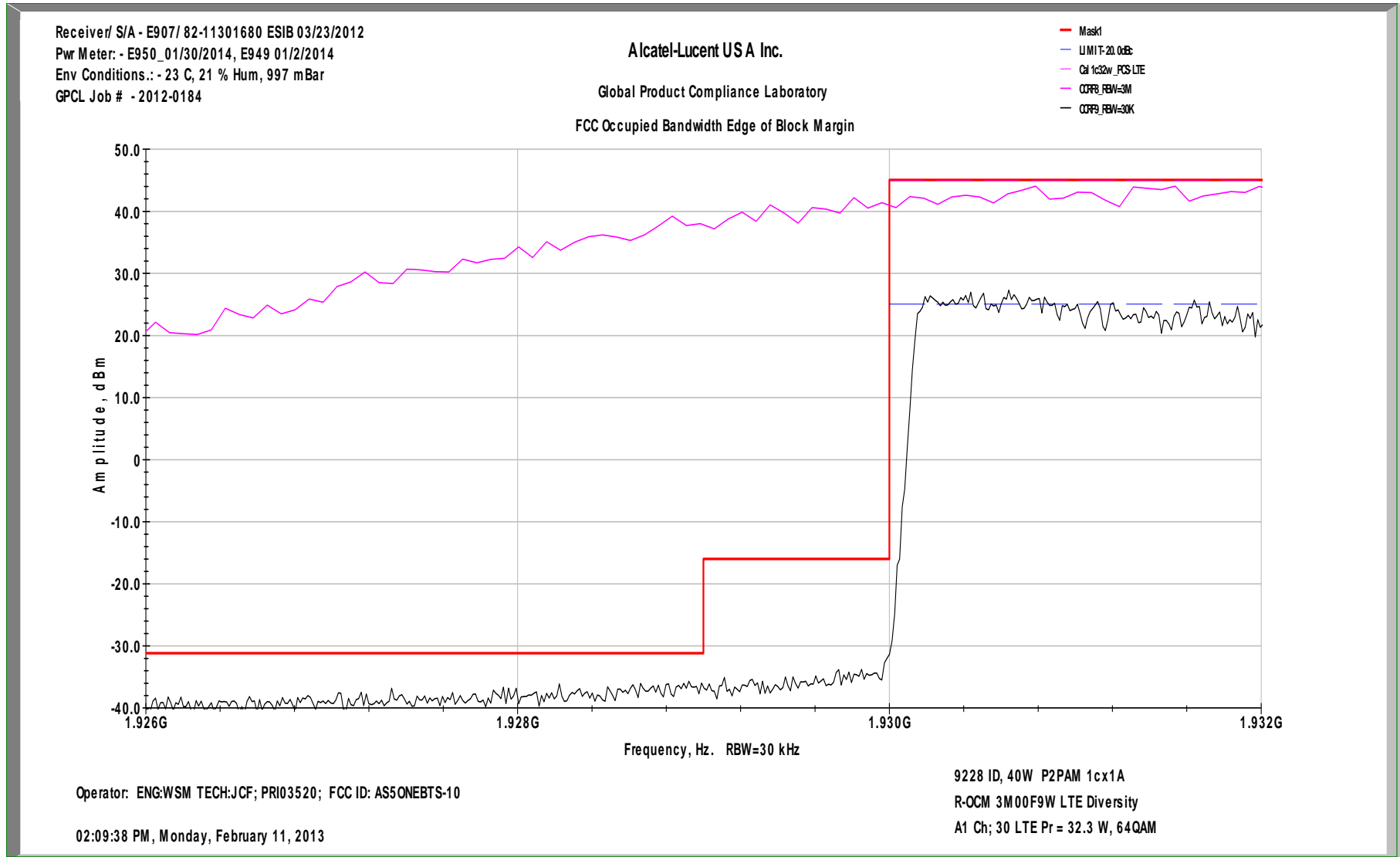

FCC Occupied Bandwidth w/ 3 Modulations LTE3 MHz Ch A-30 1cx1A 32W/c QPSK, 16QAM & 64QAM Diversity Tx2

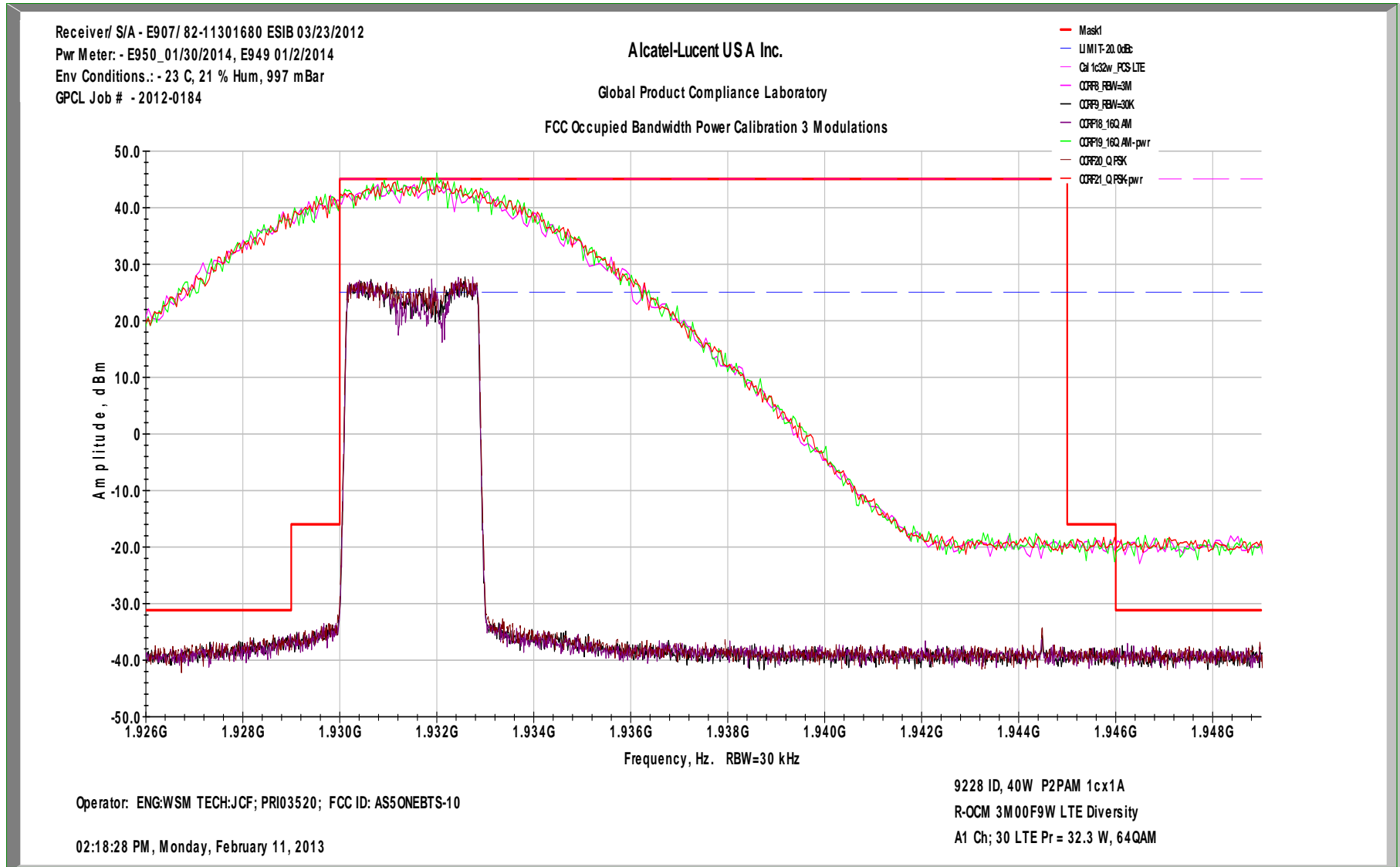

FCC Occupied Bandwidth Emissions LTE3 MHz Ch A-270 1cx2A 32W/c 64QAM Primary Tx1

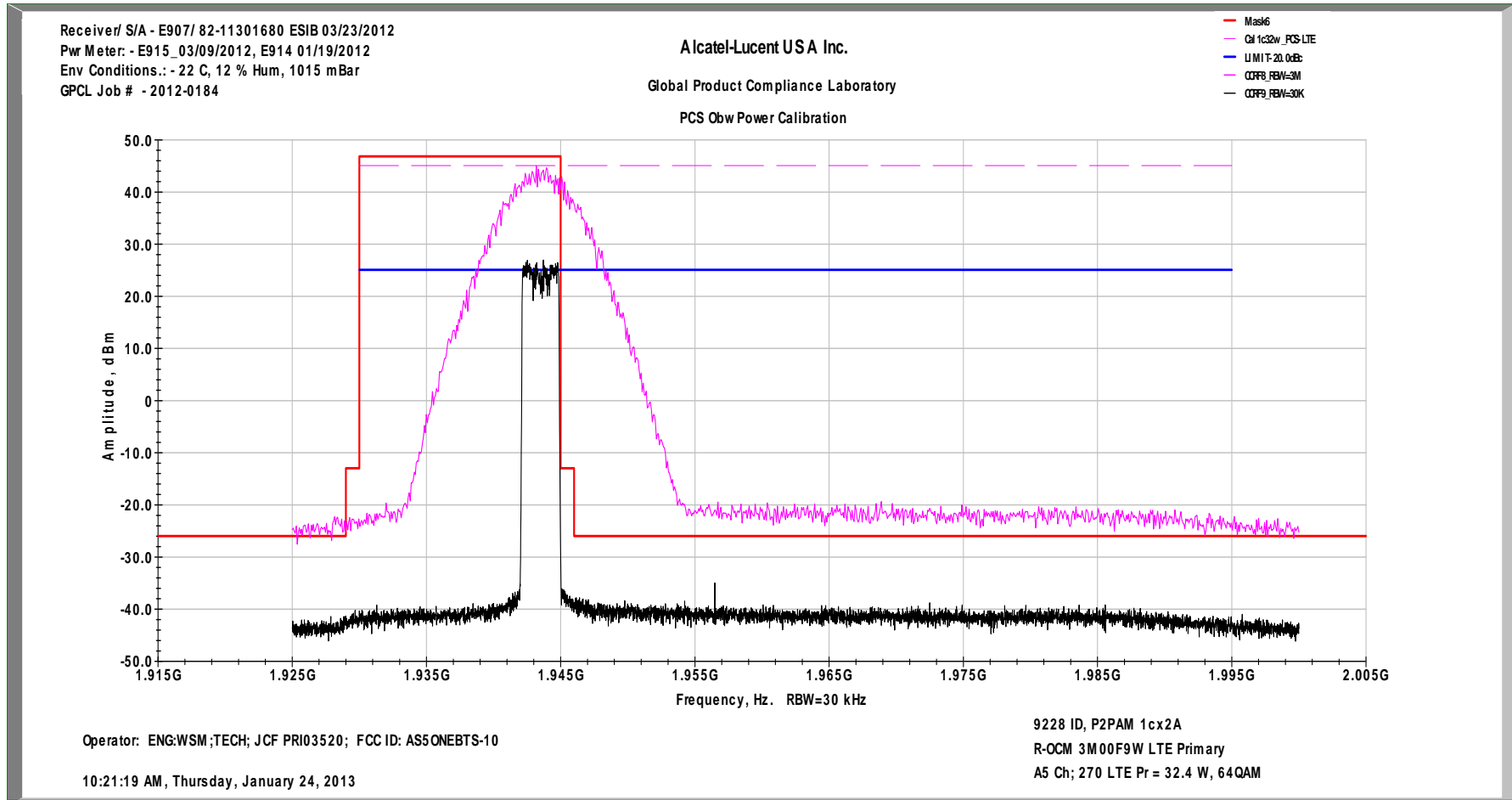

In-Band Intermodulation Graph LTE3 MHz Ch A-270 1cx2A 32W/c 64QAM Primary Tx1

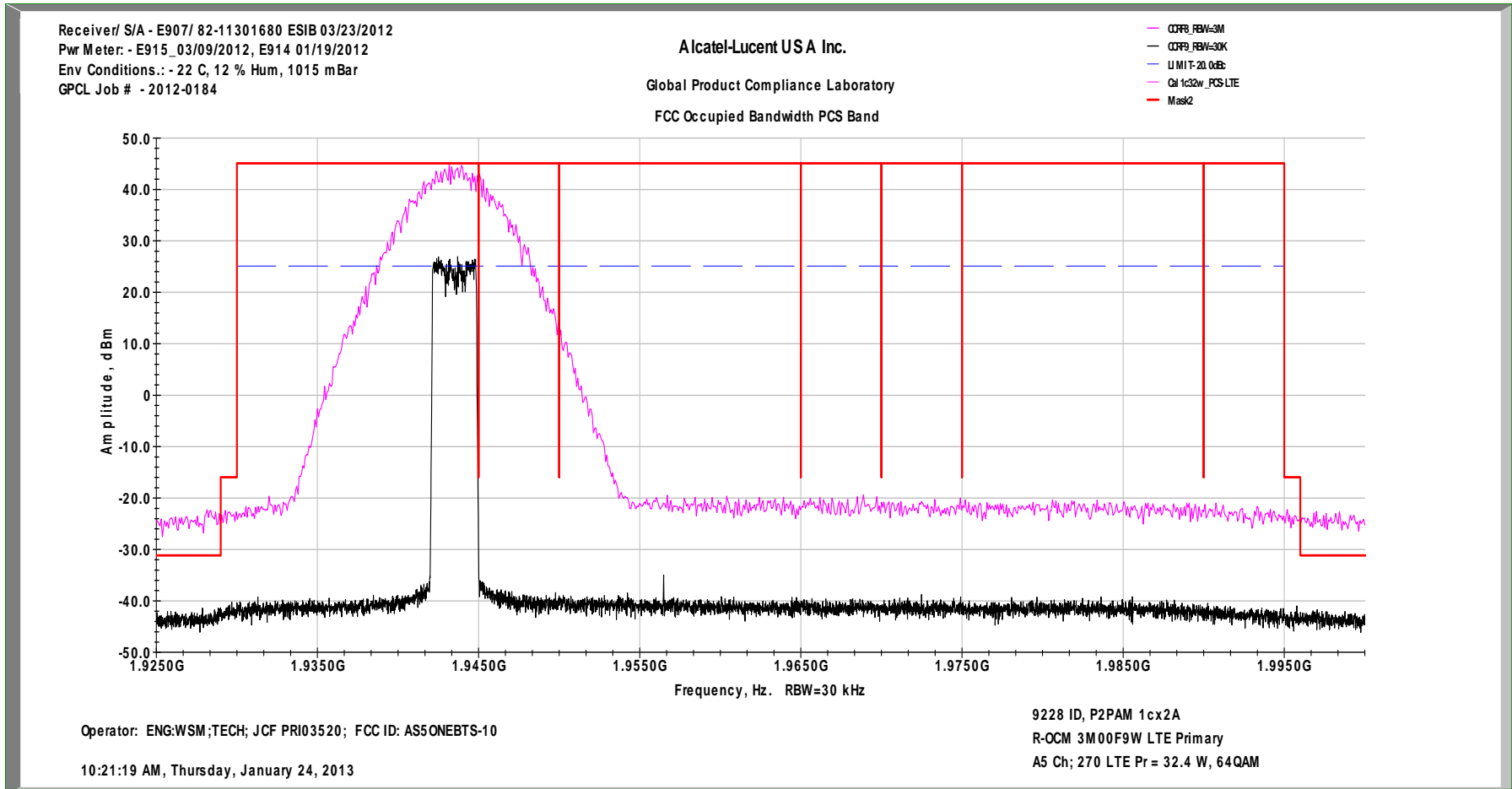

FCC Edge of Block Margin LTE3 MHz Ch A-270 1cx2A 32W/c 64QAM Primary Tx1

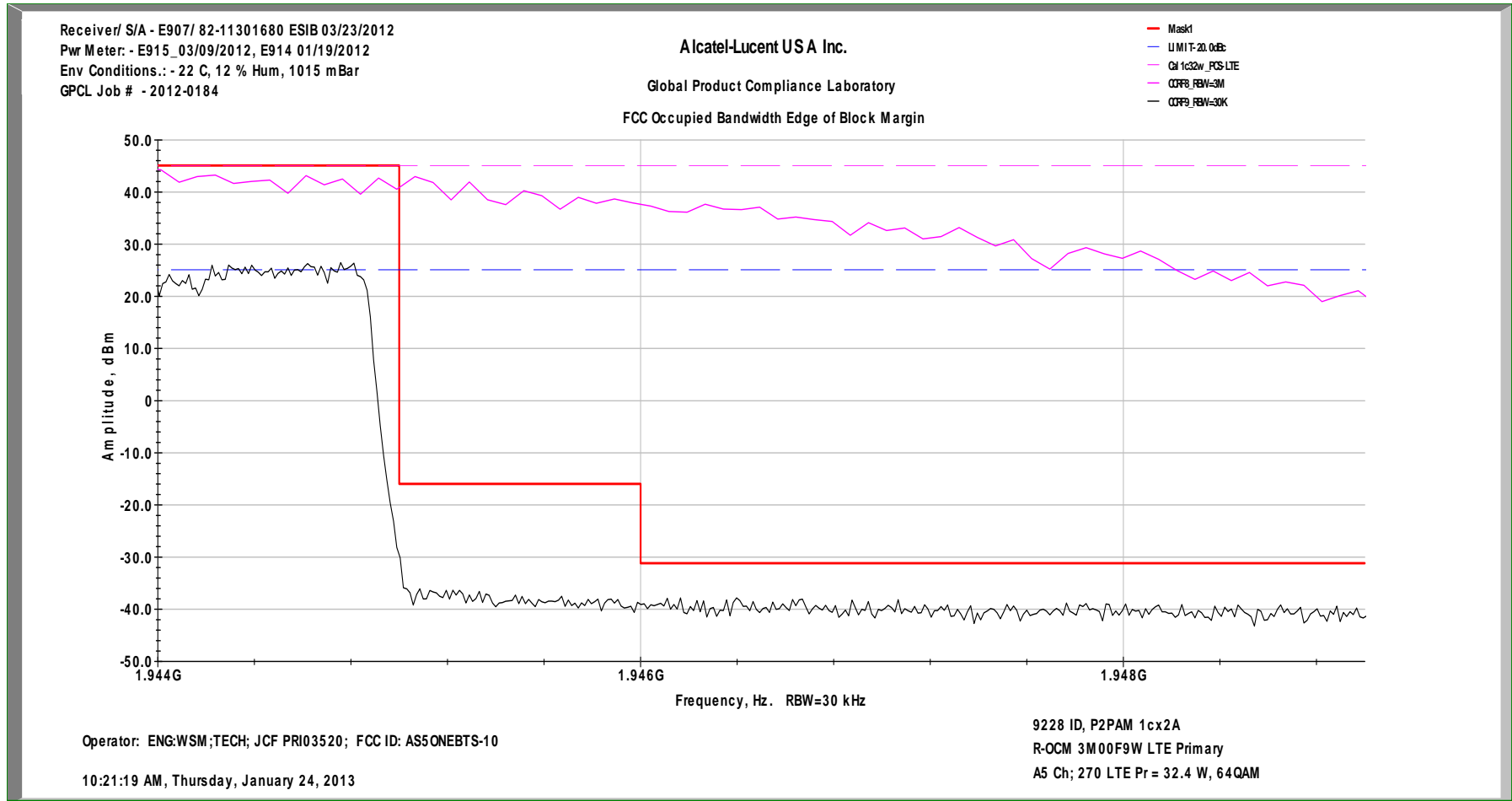

FCC Occupied Bandwidth w/ 3 Modulations LTE3 MHz Ch A-270 1cx2A 32W/c QPSK, 16QAM & 64QAM Primary Tx1

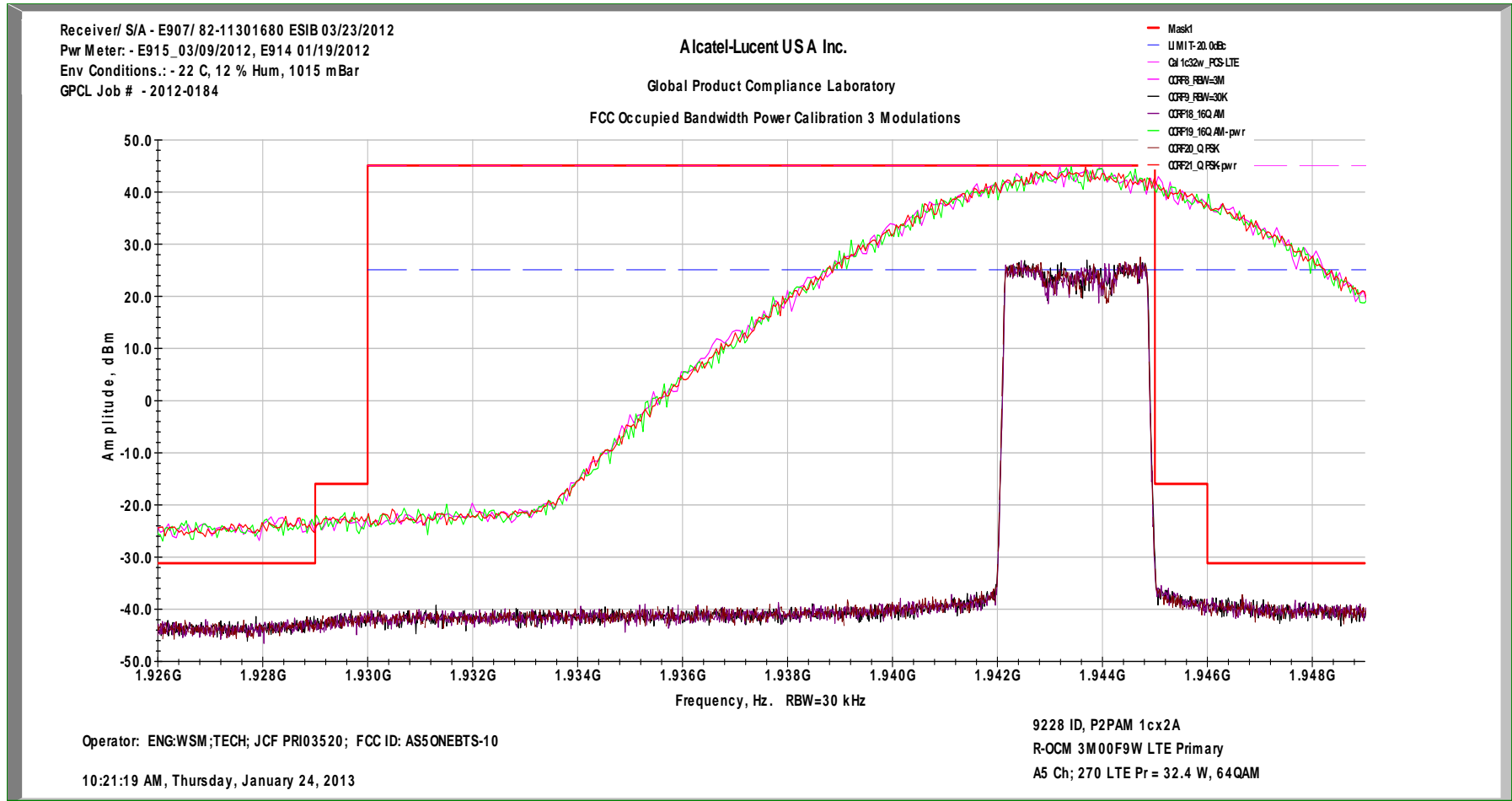

FCC Occupied Bandwidth Emissions LTE3 MHz Ch A-270 1cx1A 32W/c 64QAM Diversity Tx2

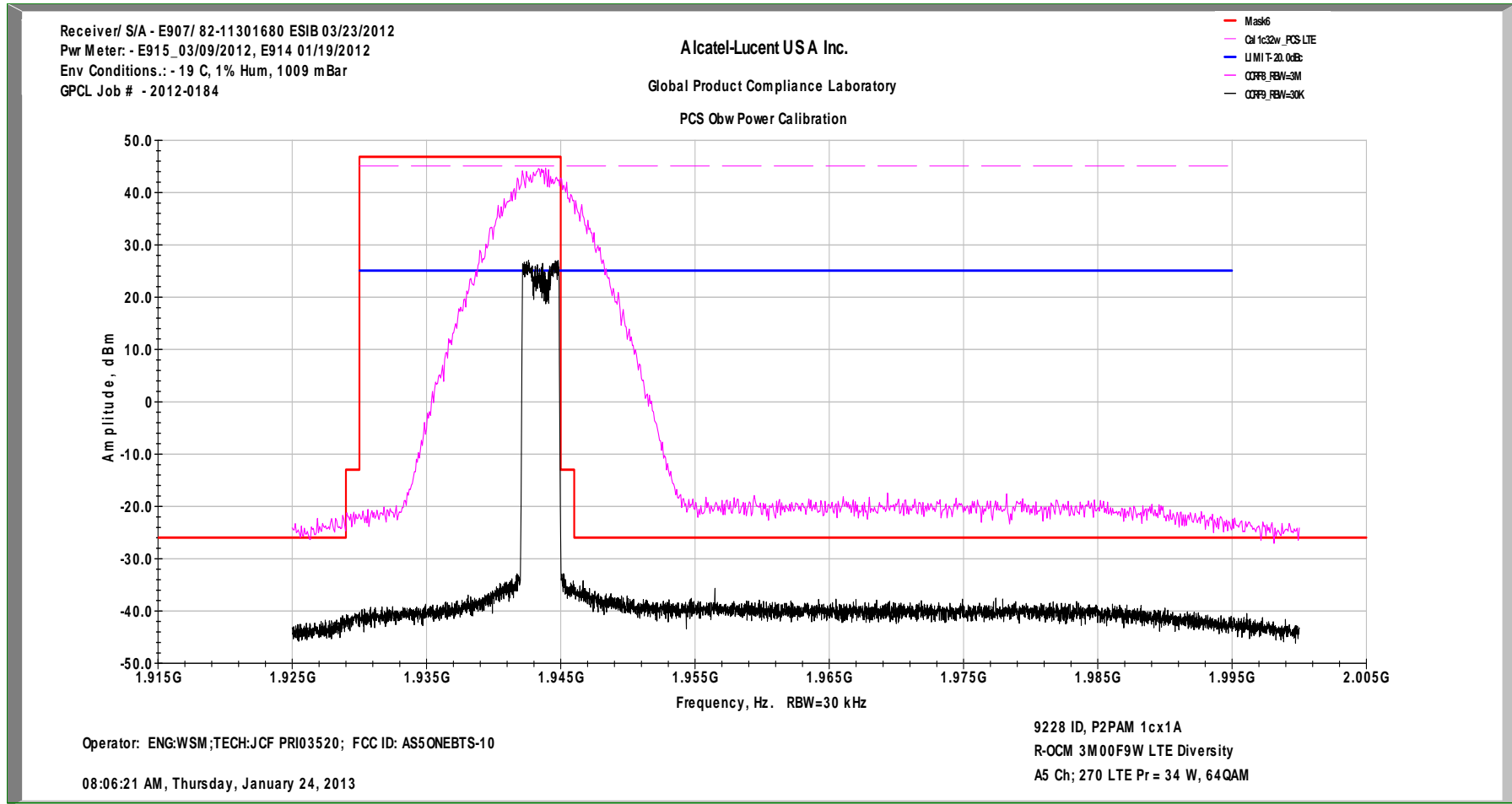

In-Band Intermodulation Graph LTE3 MHz Ch A-270 1cx1A 32W/c 64QAM Diversity Tx2

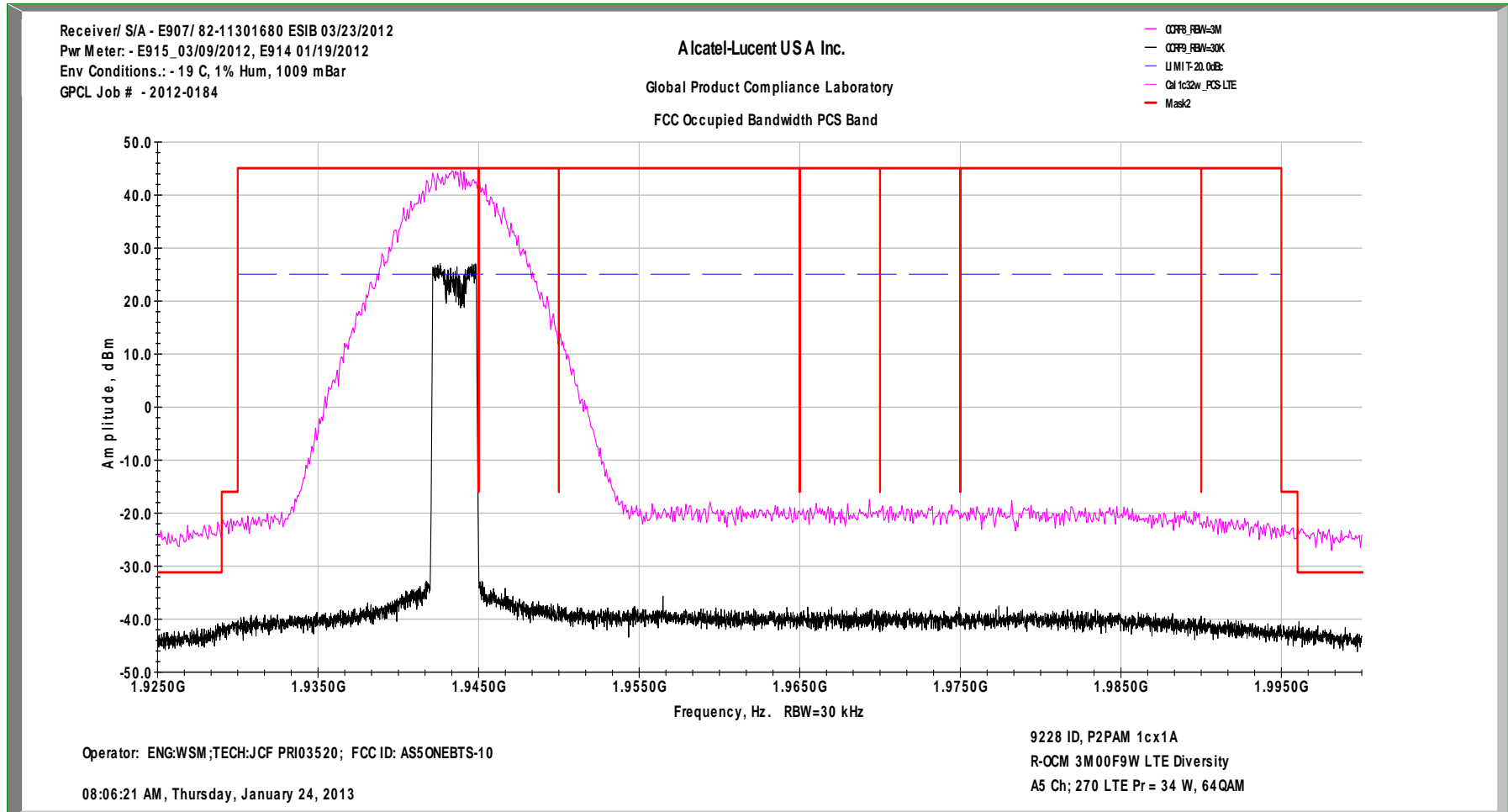

FCC Edge of Block Margin LTE3 MHz Ch A-270 1cx1A 32W/c 64QAM Diversity Tx2

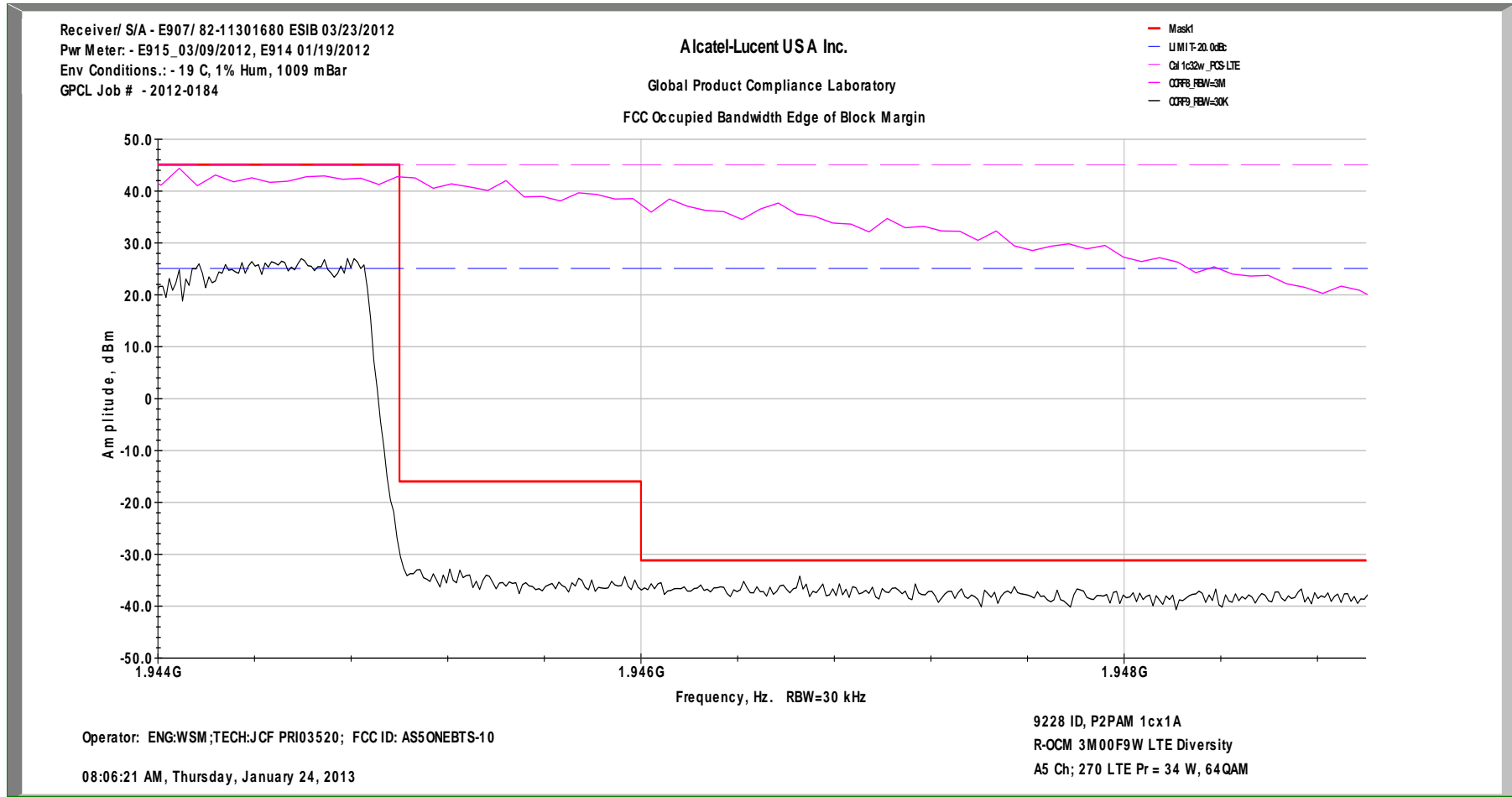

FCC Occupied Bandwidth w/ 3 Modulations LTE3 MHz Ch A-270 1cx1A 32W/c QPSK, 16QAM & 64QAM Diversity Tx2

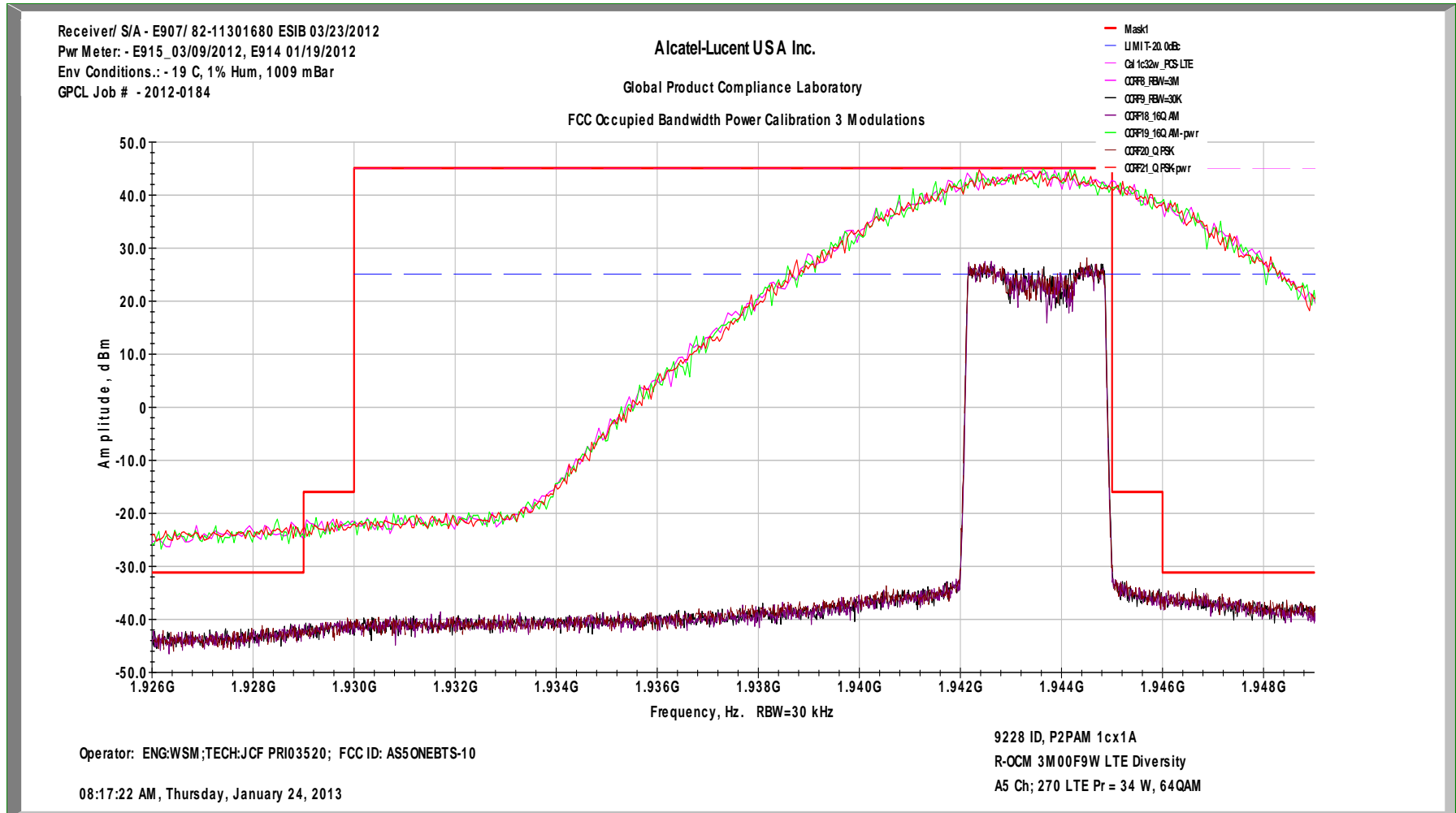

FCC Occupied Bandwidth Emissions LTE3 MHz Ch D-330 1cx2A 32W/c 64QAM Primary Tx1

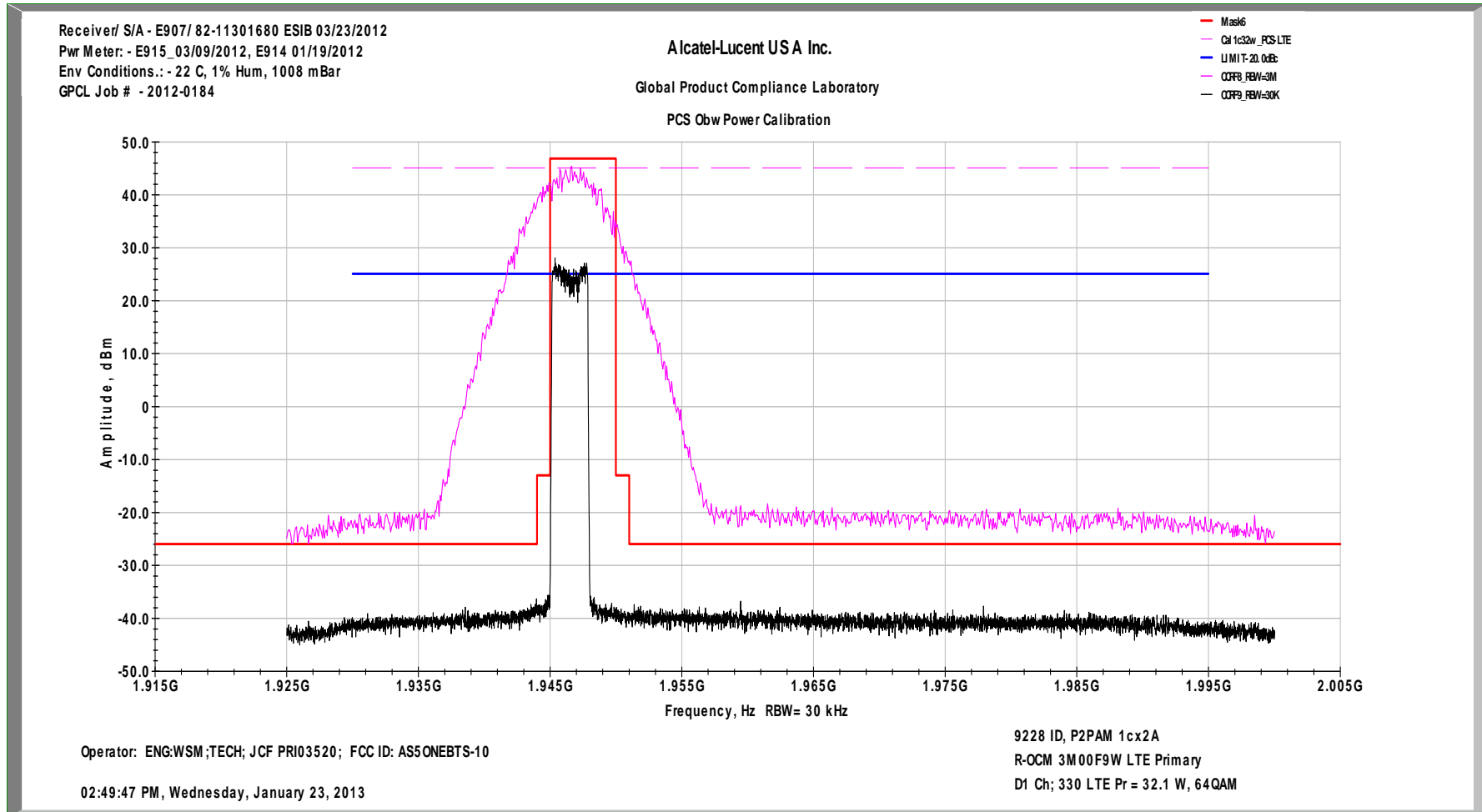

In-Band Intermodulation Graph LTE3 MHz Ch D-330 1cx2A 32W/c 64QAM Primary Tx1

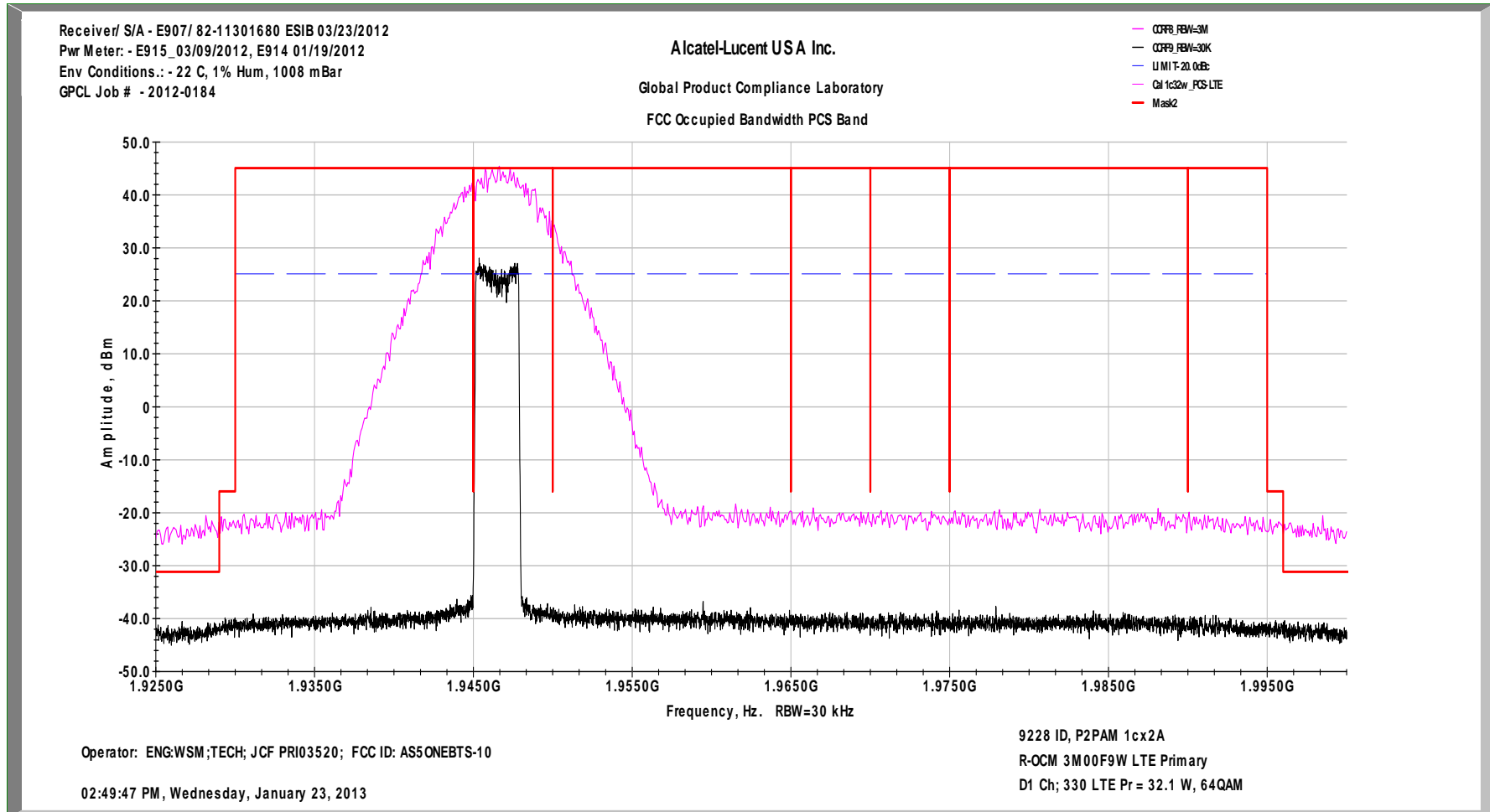

FCC Edge of Block Margin LTE3 MHz Ch D-330 1cx2A 32W/c 64QAM Primary Tx1

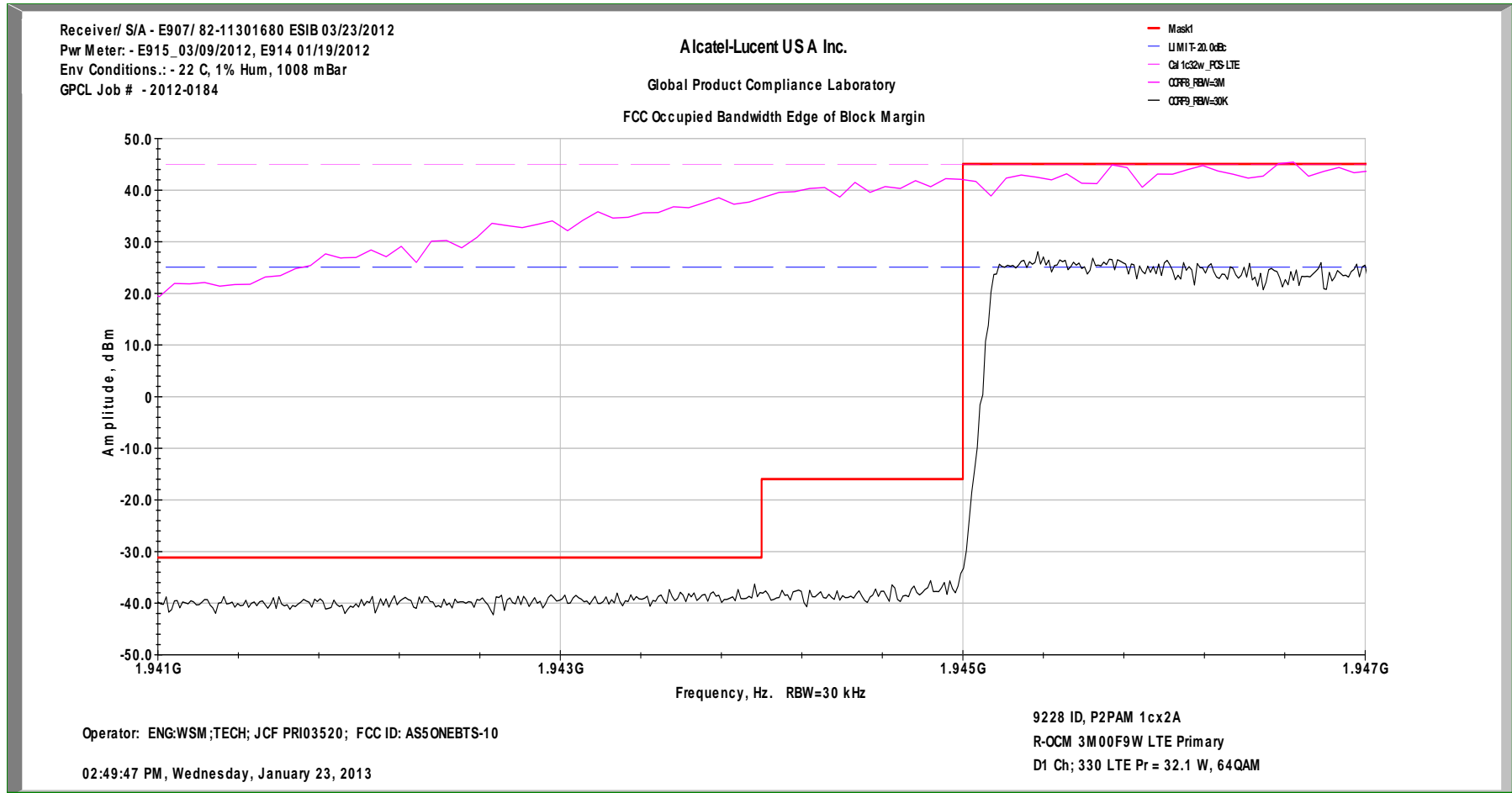

FCC Occupied Bandwidth w/ 3 Modulations LTE3 MHz Ch D-330 1cx2A 32W/c QPSK, 16QAM & 64QAM Primary Tx1

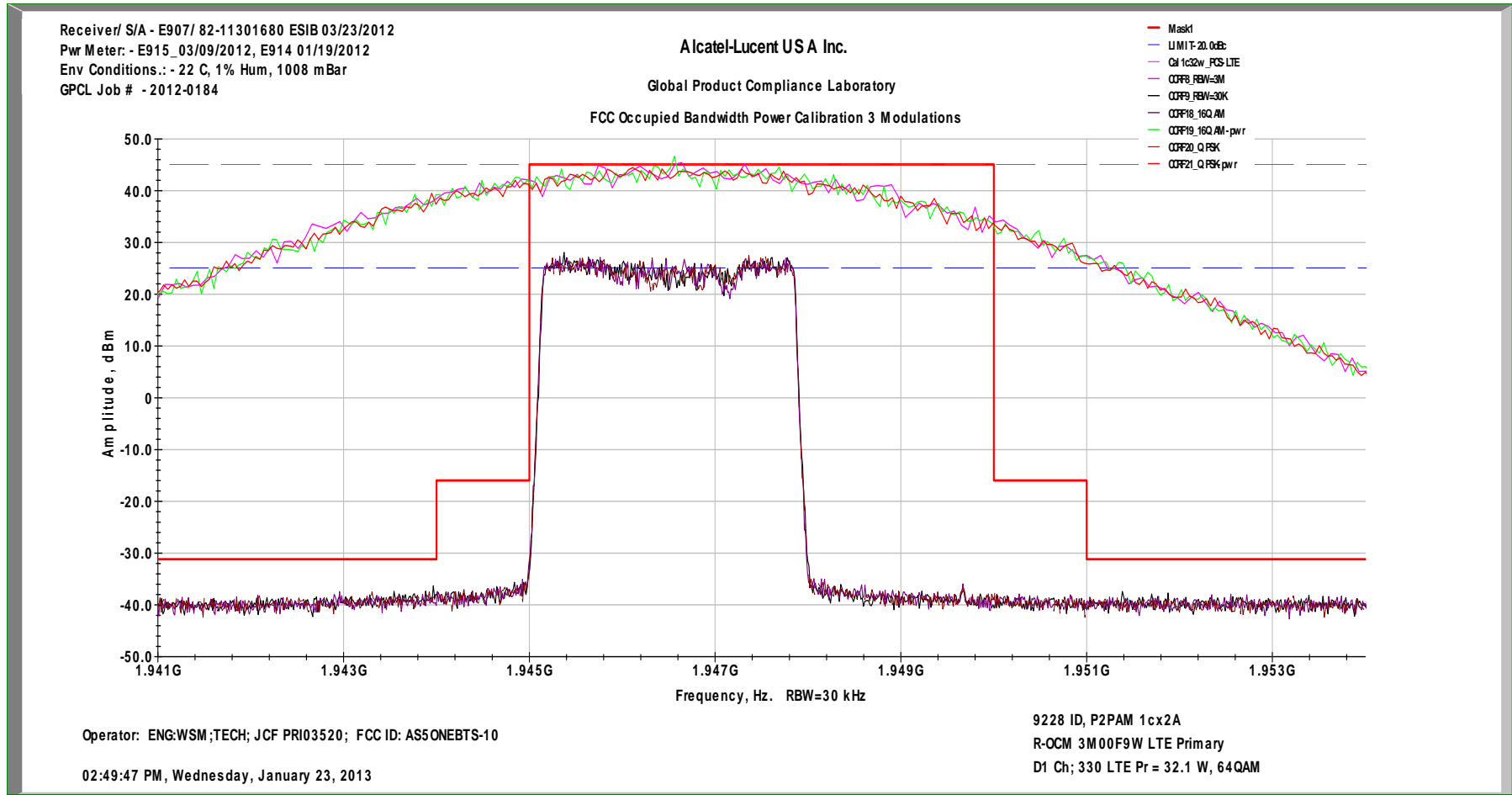

FCC Occupied Bandwidth Emissions LTE3 MHz Ch D-330 1cx1A 32W/c 64QAM Diversity Tx2

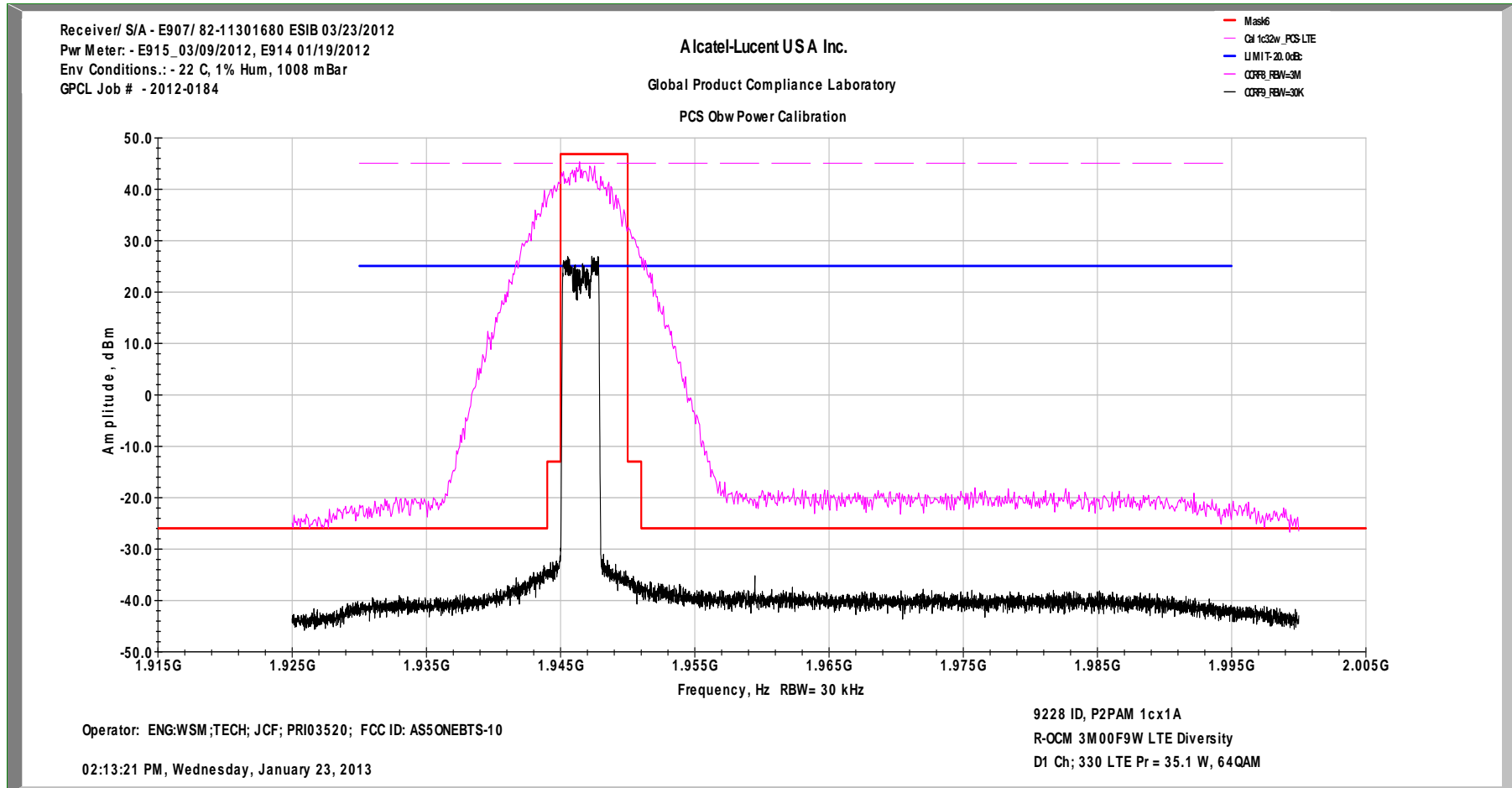

In-Band Intermodulation Graph LTE3 MHz Ch D-330 1cx1A 32W/c 64QAM Diversity Tx2

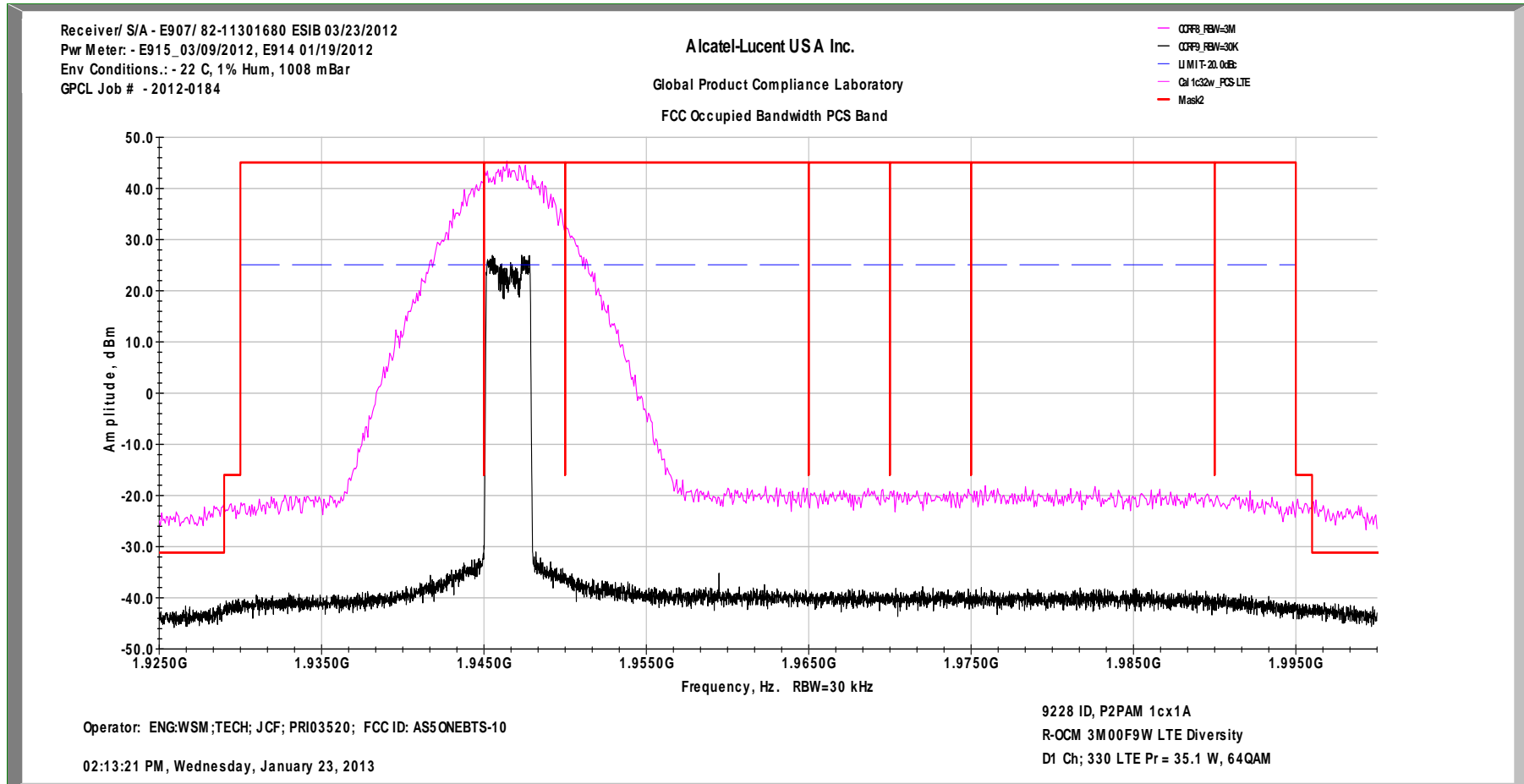

FCC Edge of Block Margin LTE3 MHz Ch D-330 1cx1A 32W/c 64QAM Diversity Tx2

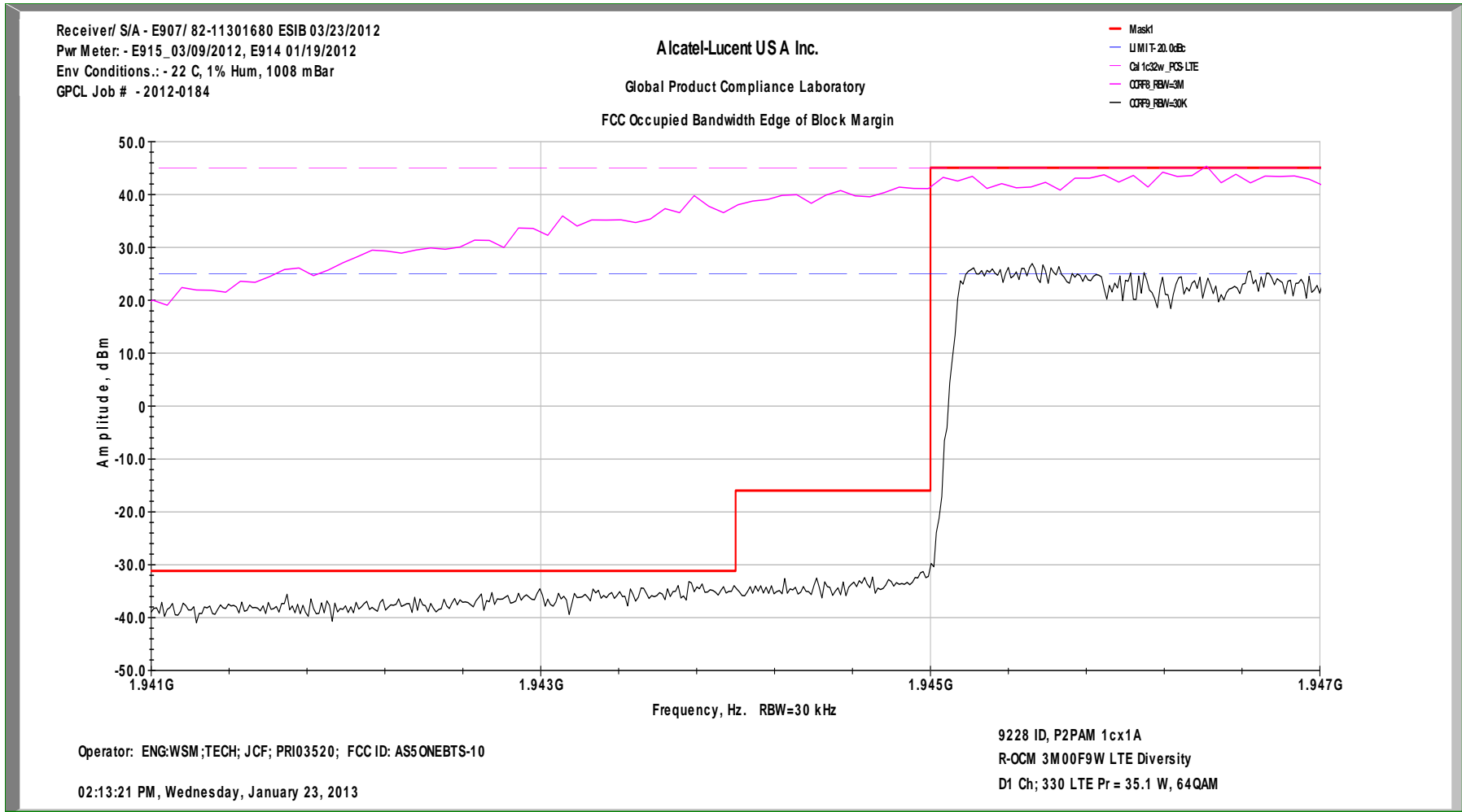

FCC Occupied Bandwidth w/ 3 Modulations LTE3 MHz Ch D-330 1cx1A 32W/c QPSK, 16QAM &64QAM Diversity Tx2

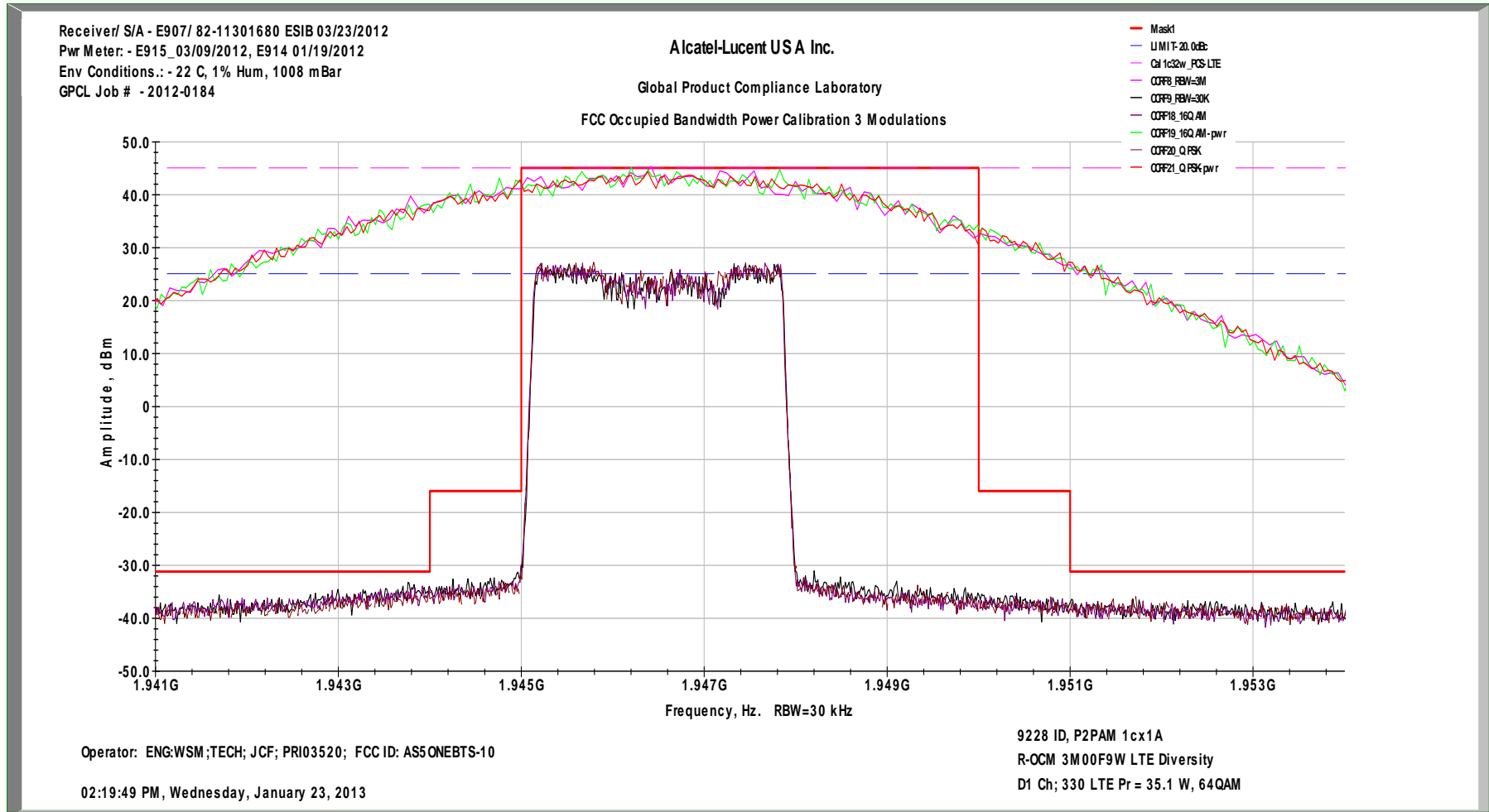

FCC Occupied Bandwidth Emissions LTE3 MHz Ch D-370 1cx2A 32W/c 64QAM Primary Tx1

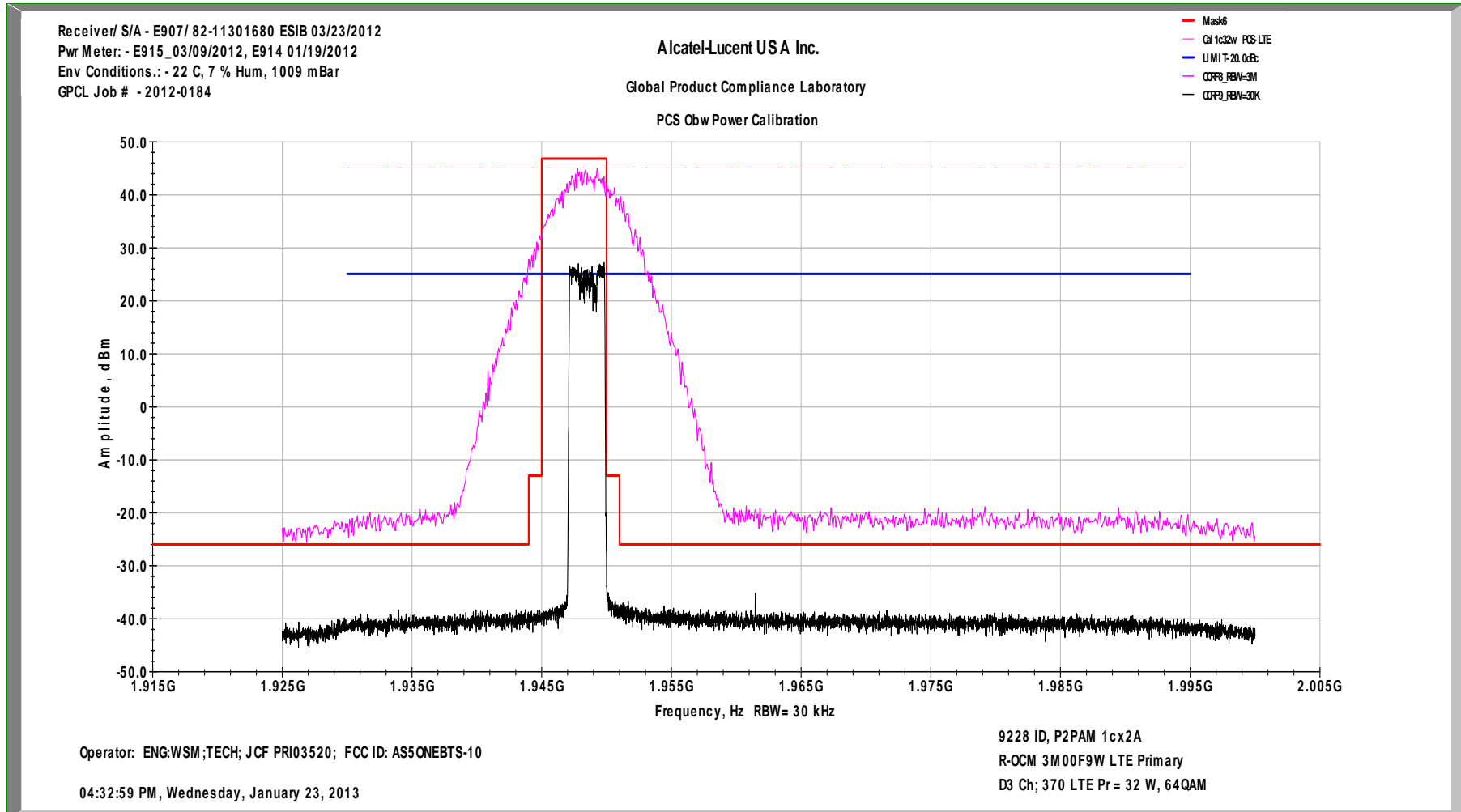

In-Band Intermodulation Graph LTE3 MHz Ch D-370 1cx2A 32W/c 64QAM Primary Tx1

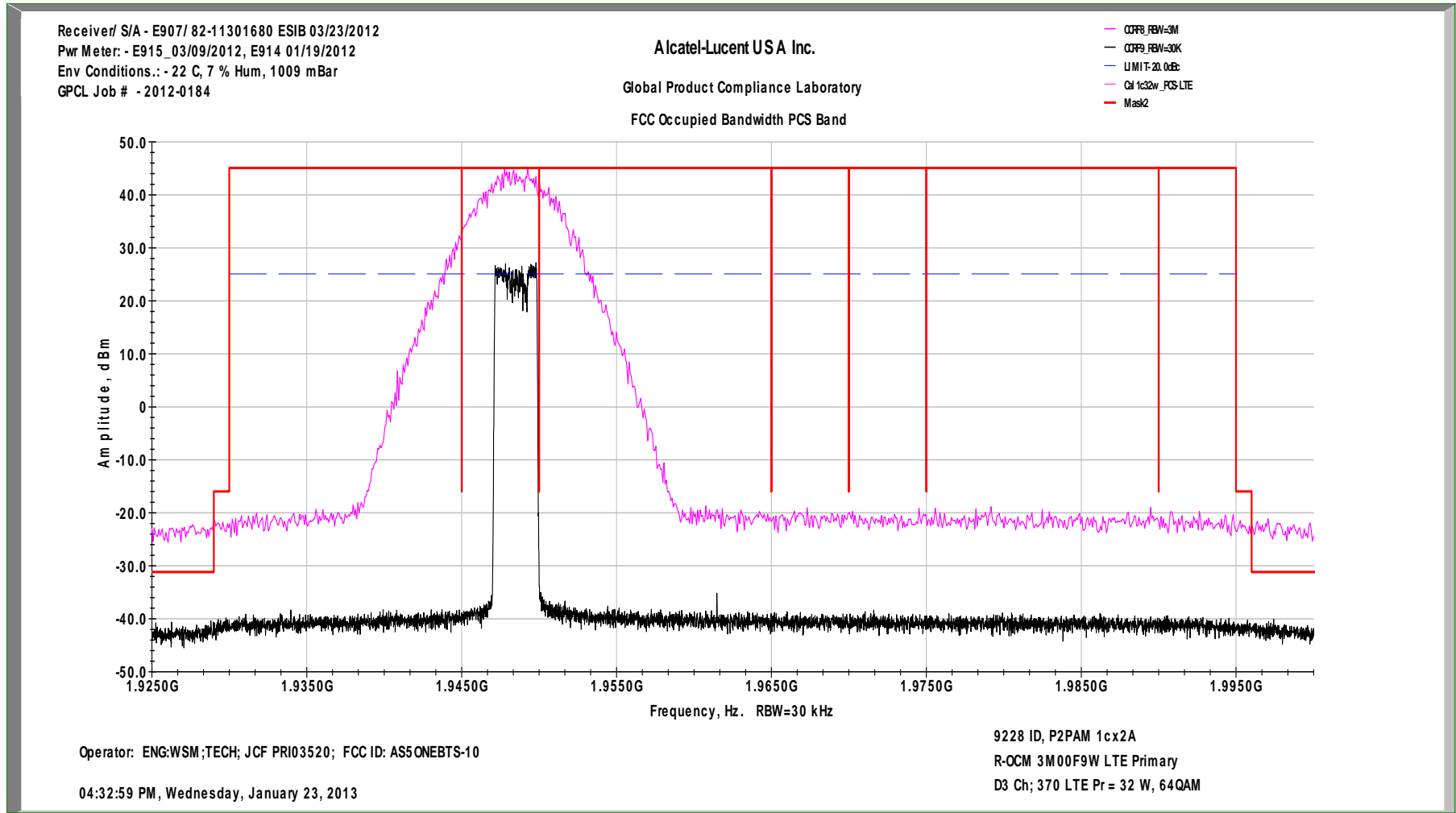

FCC Edge of Block Margin LTE3 MHz Ch D-370 1cx2A 32W/c 64QAM Primary Tx1

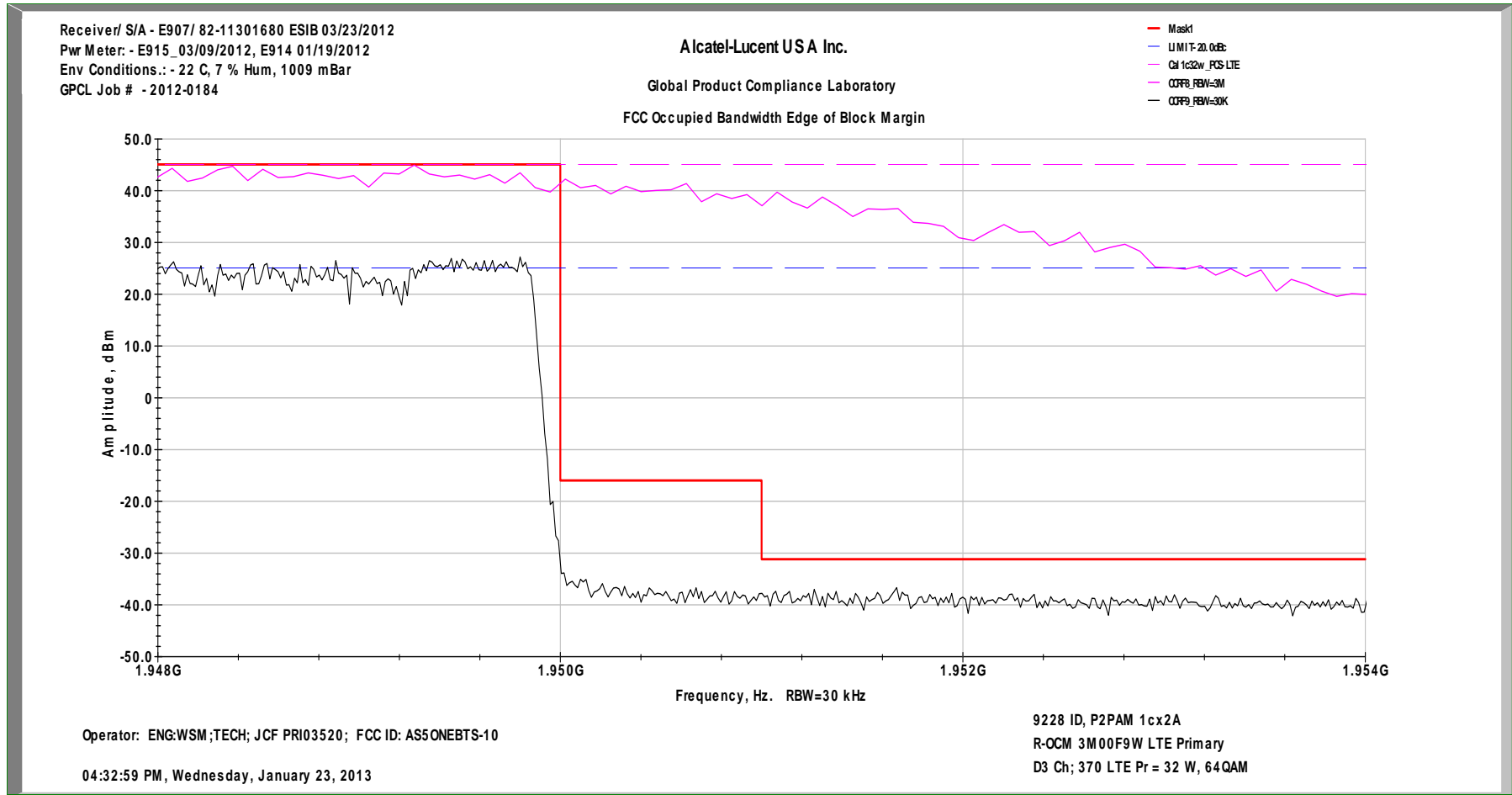

FCC Occupied Bandwidth w/ 3 Modulations LTE3 MHz Ch D-370 1cx2A 32W/c QPSK, 16QAM & 64QAM Primary Tx1

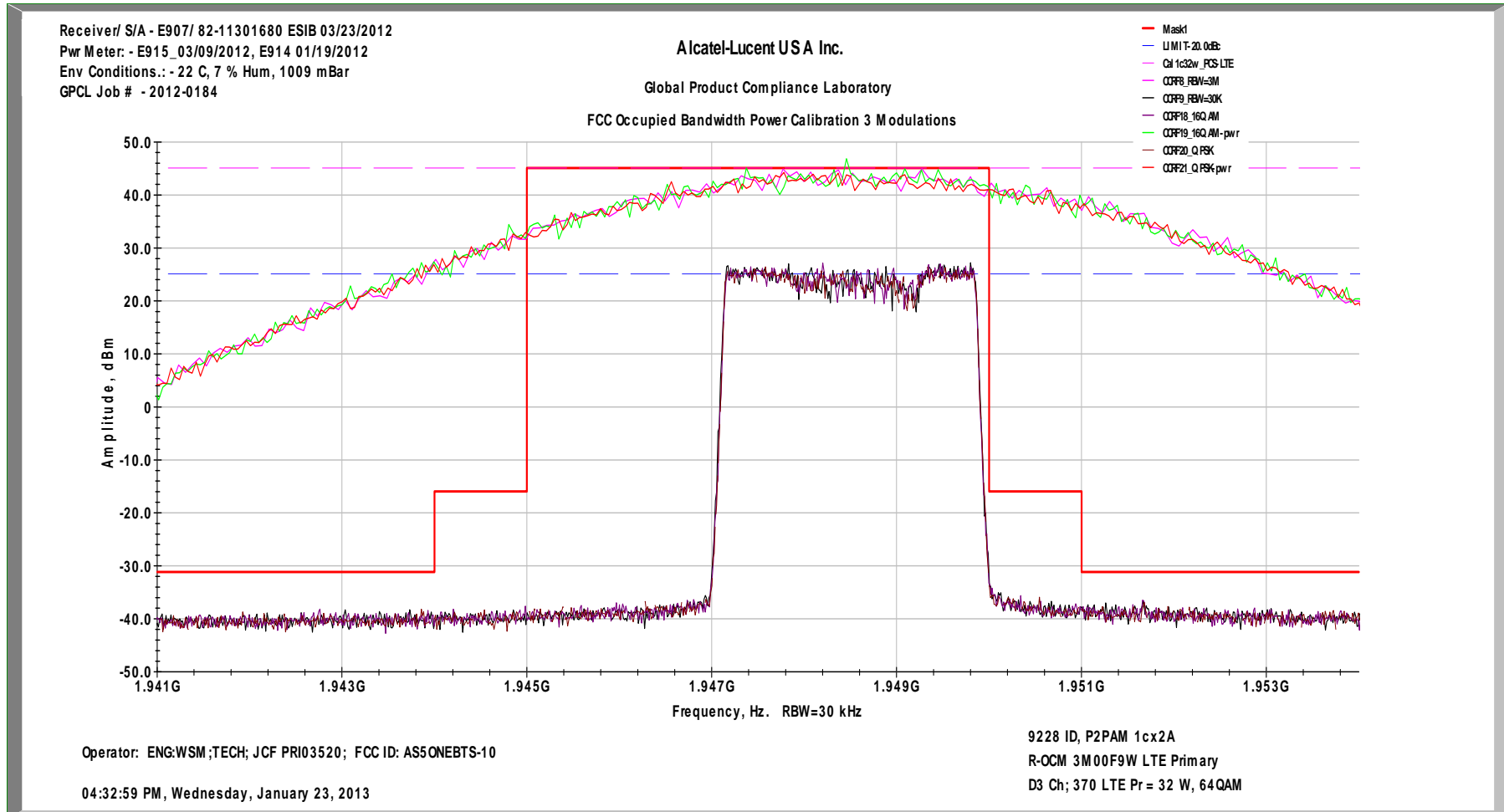

FCC Occupied Bandwidth Emissions LTE3 MHz Ch D-370 1cx1A 32W/c 64QAM Diversity Tx2

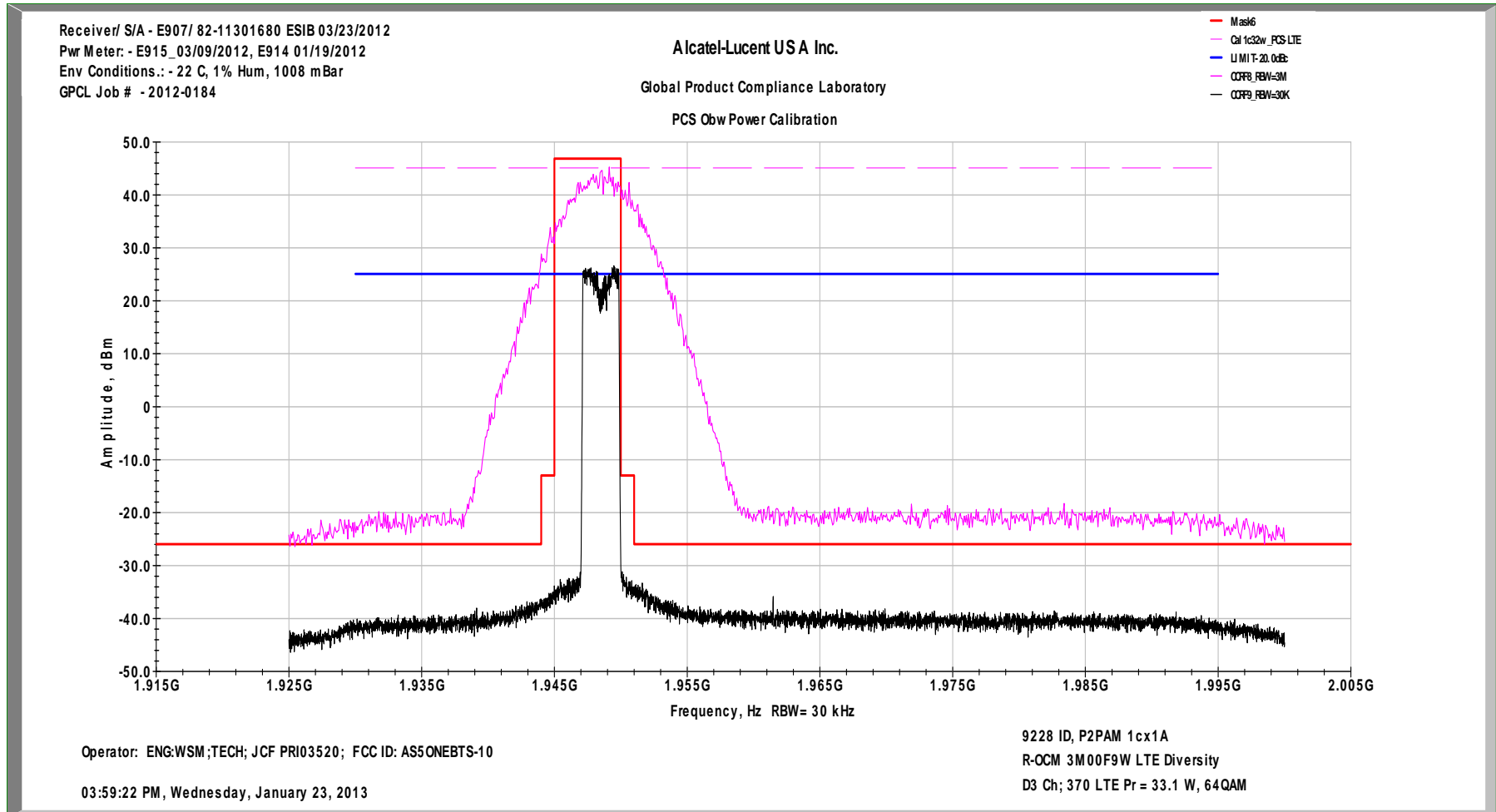

In-Band Intermodulation Graph LTE3 MHz Ch D-370 1cx1A 32W/c 64QAM Diversity Tx2

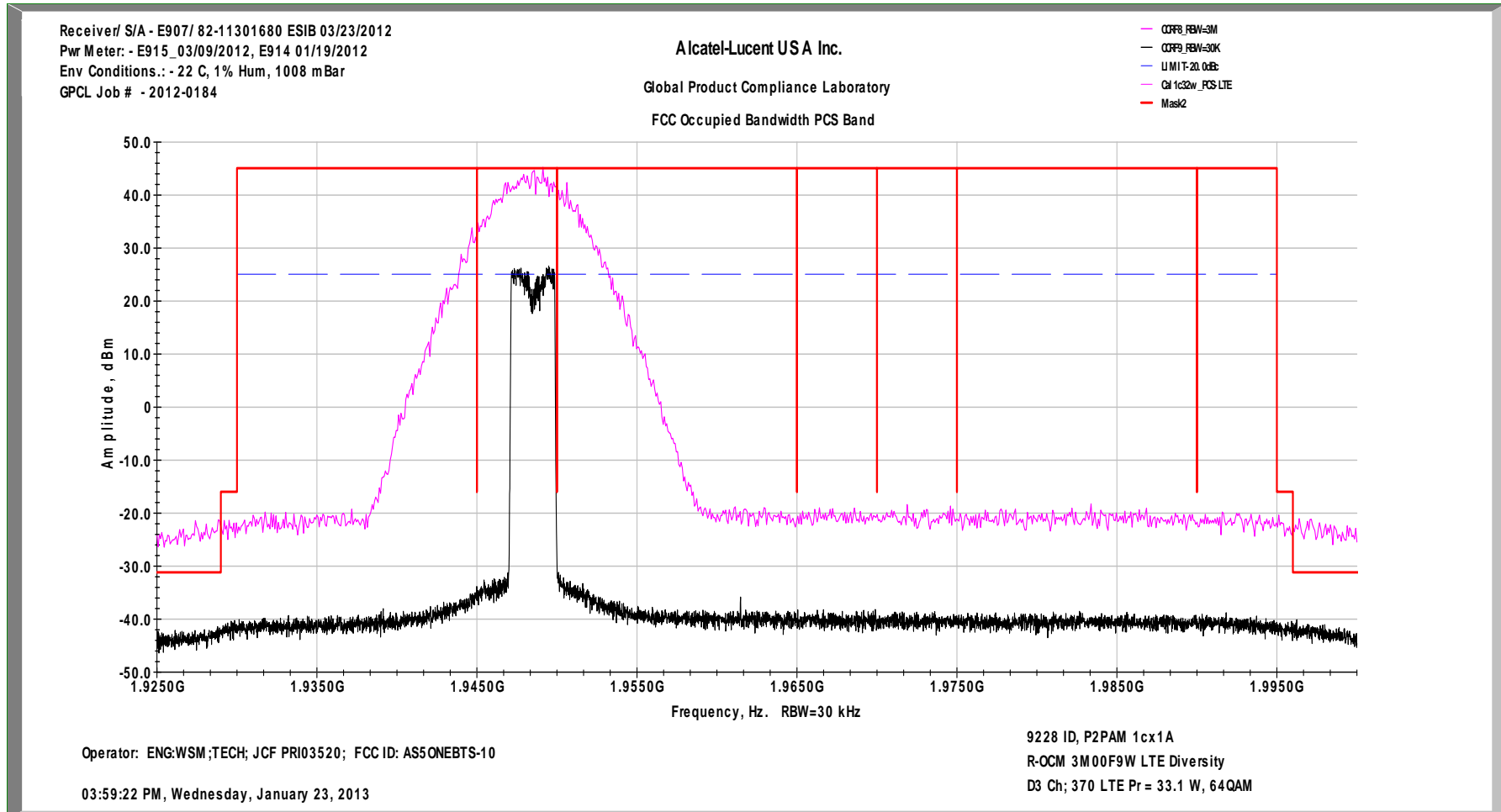

FCC Edge of Block Margin LTE3 MHz Ch D-370 1cx1A 32W/c 64QAM Diversity Tx2

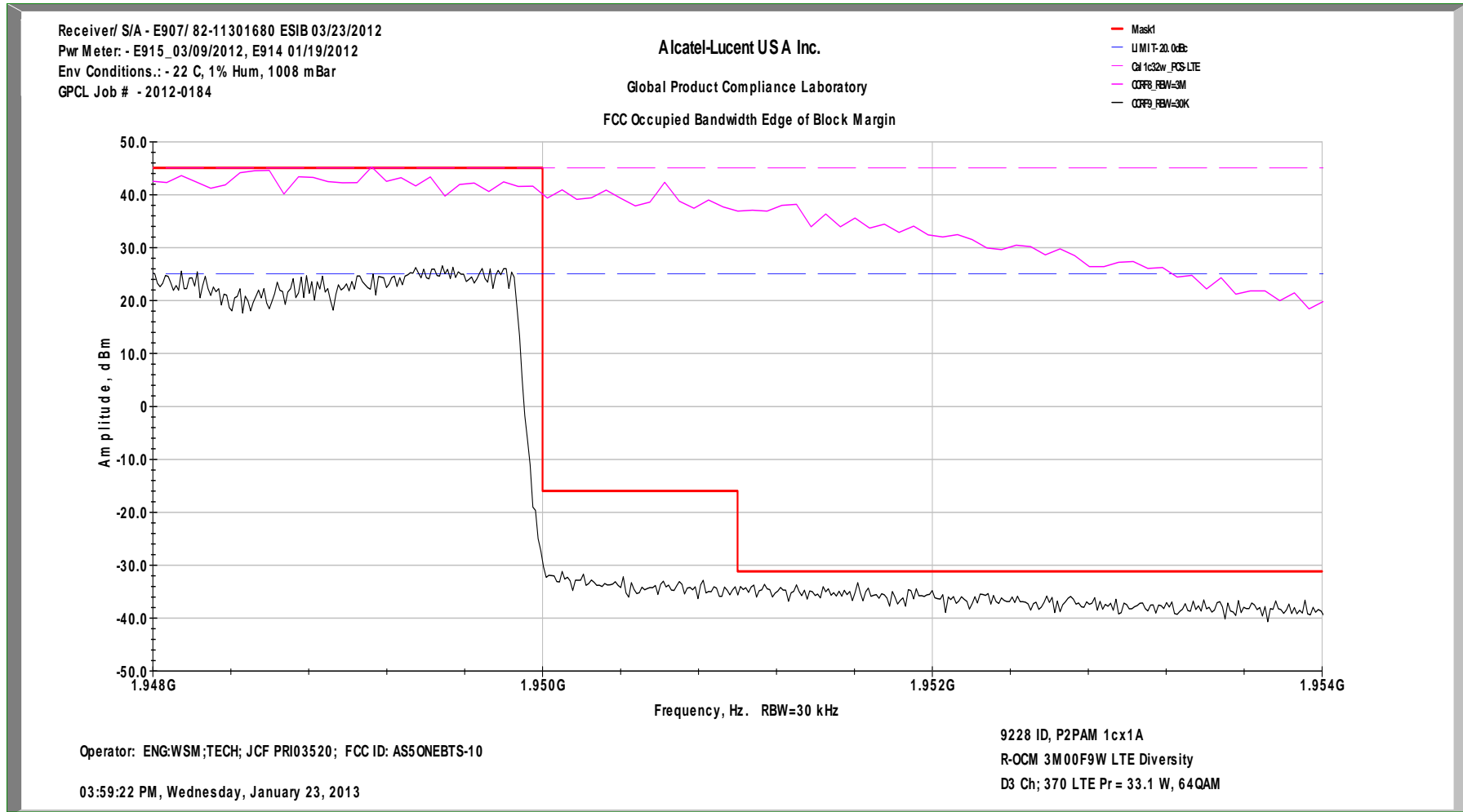

FCC Occupied Bandwidth w/ 3 Modulations LTE3 MHz Ch D-370 1cx1A 32W/c QPSK, 16QAM & 64QAM Diversity Tx2

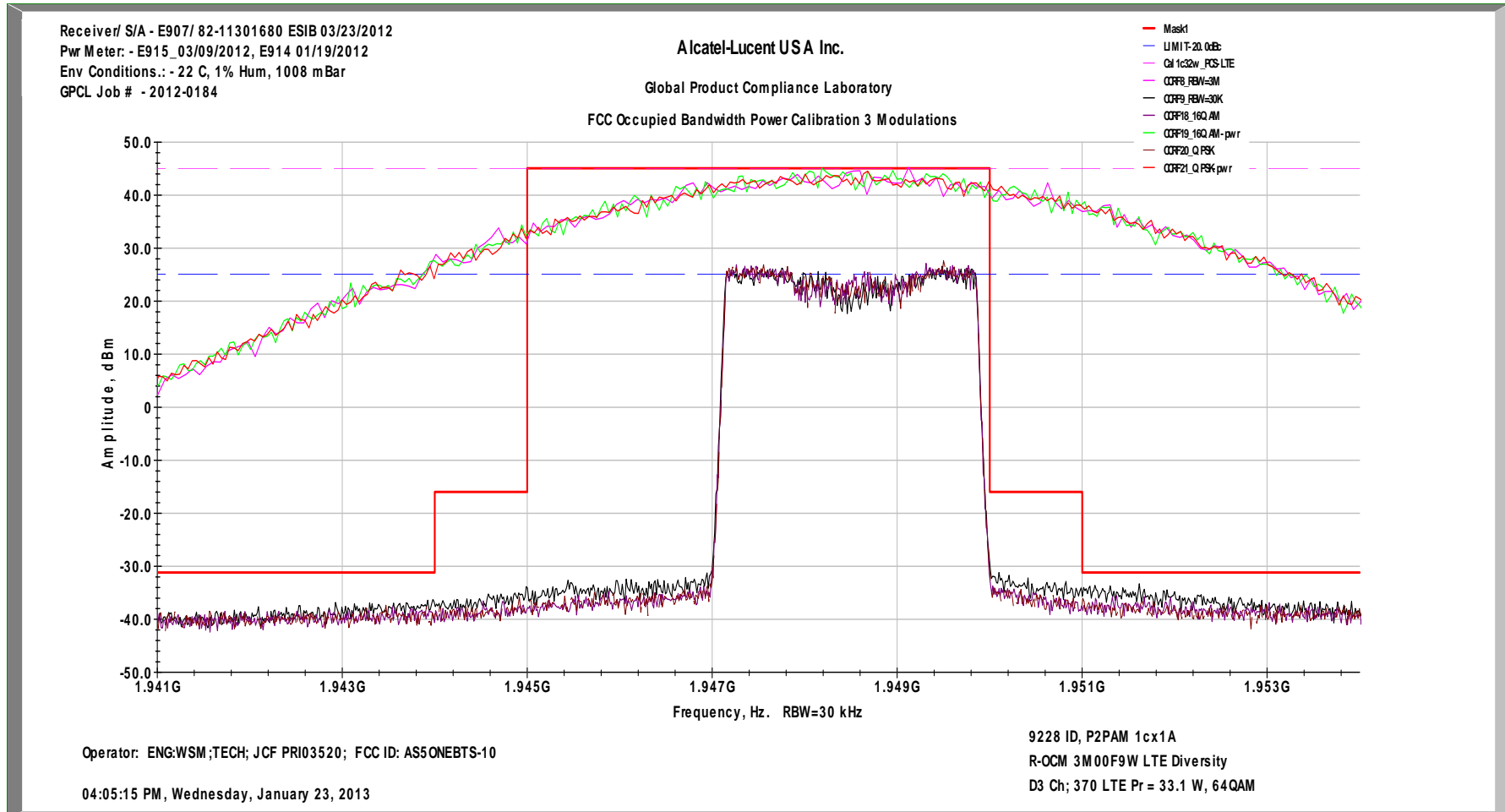

FCC Occupied Bandwidth Emissions LTE3 MHz Ch B-430 1cx2A 32W/c 64QAM Primary Tx1

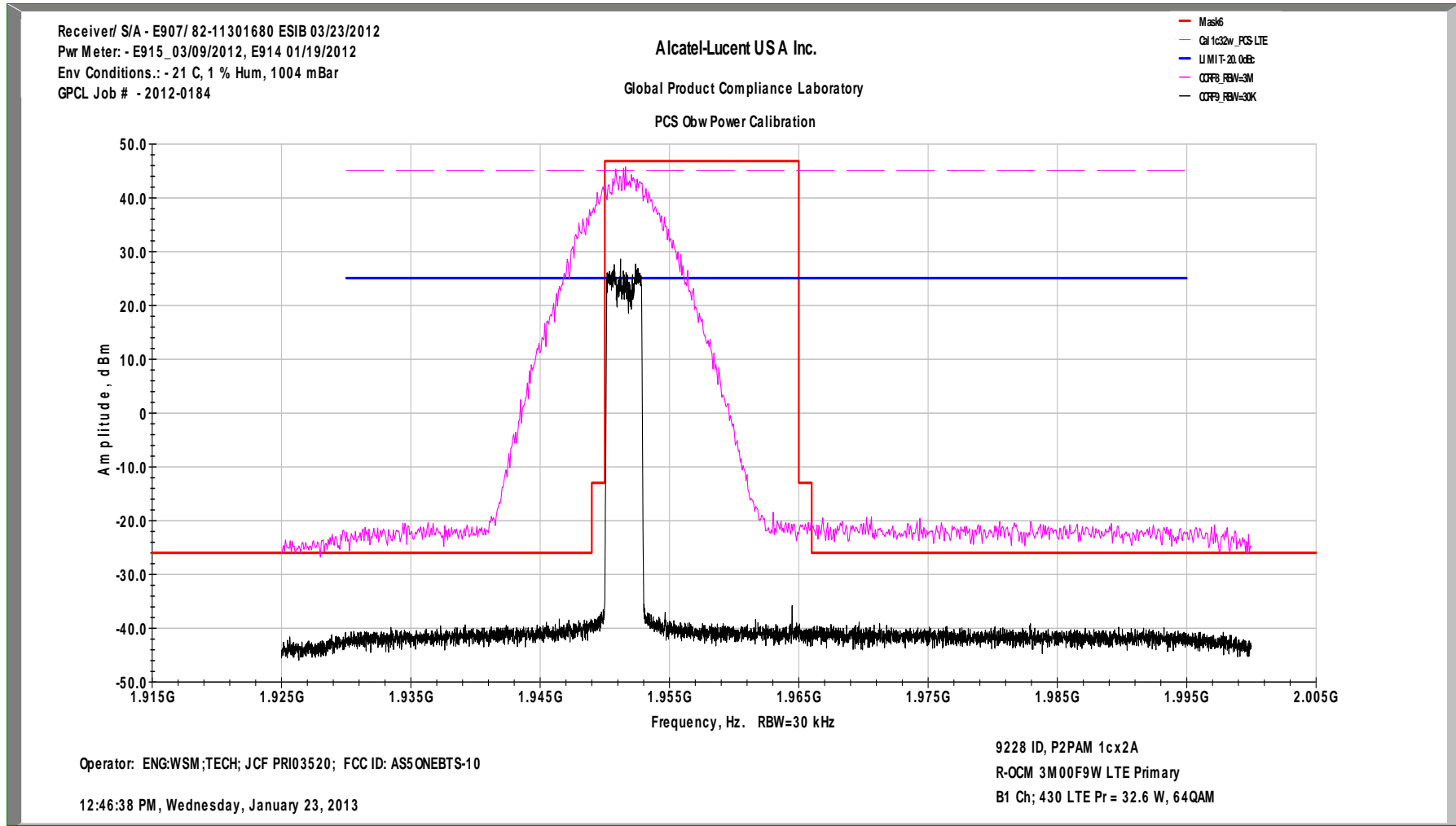

In-Band Intermodulation Graph LTE3 MHz Ch B-430 1cx2A 32W/c 64QAM Primary Tx1

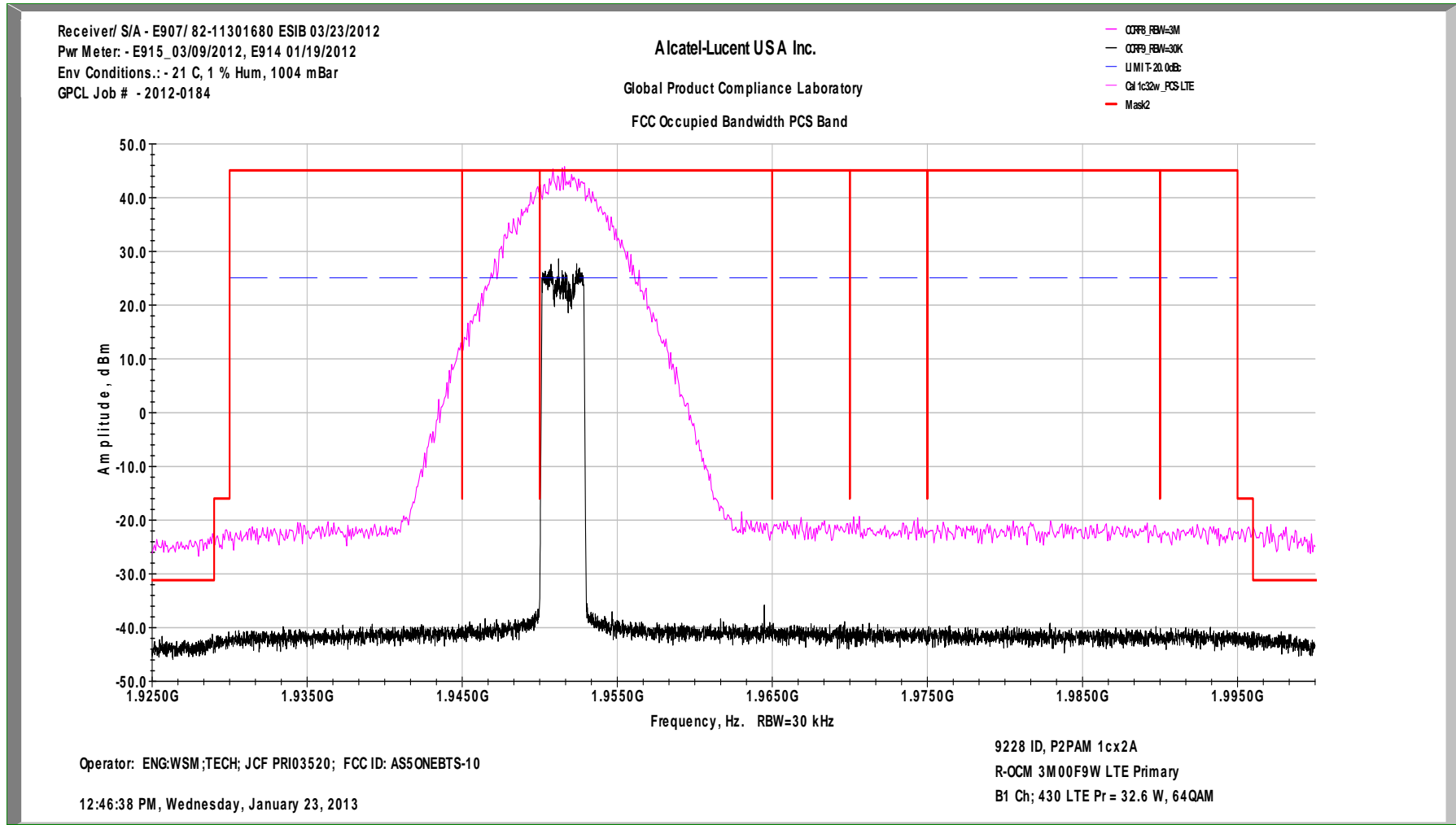

FCC Edge of Block Margin LTE3 MHz Ch B-430 1cx2A 32W/c 64QAM Primary Tx1

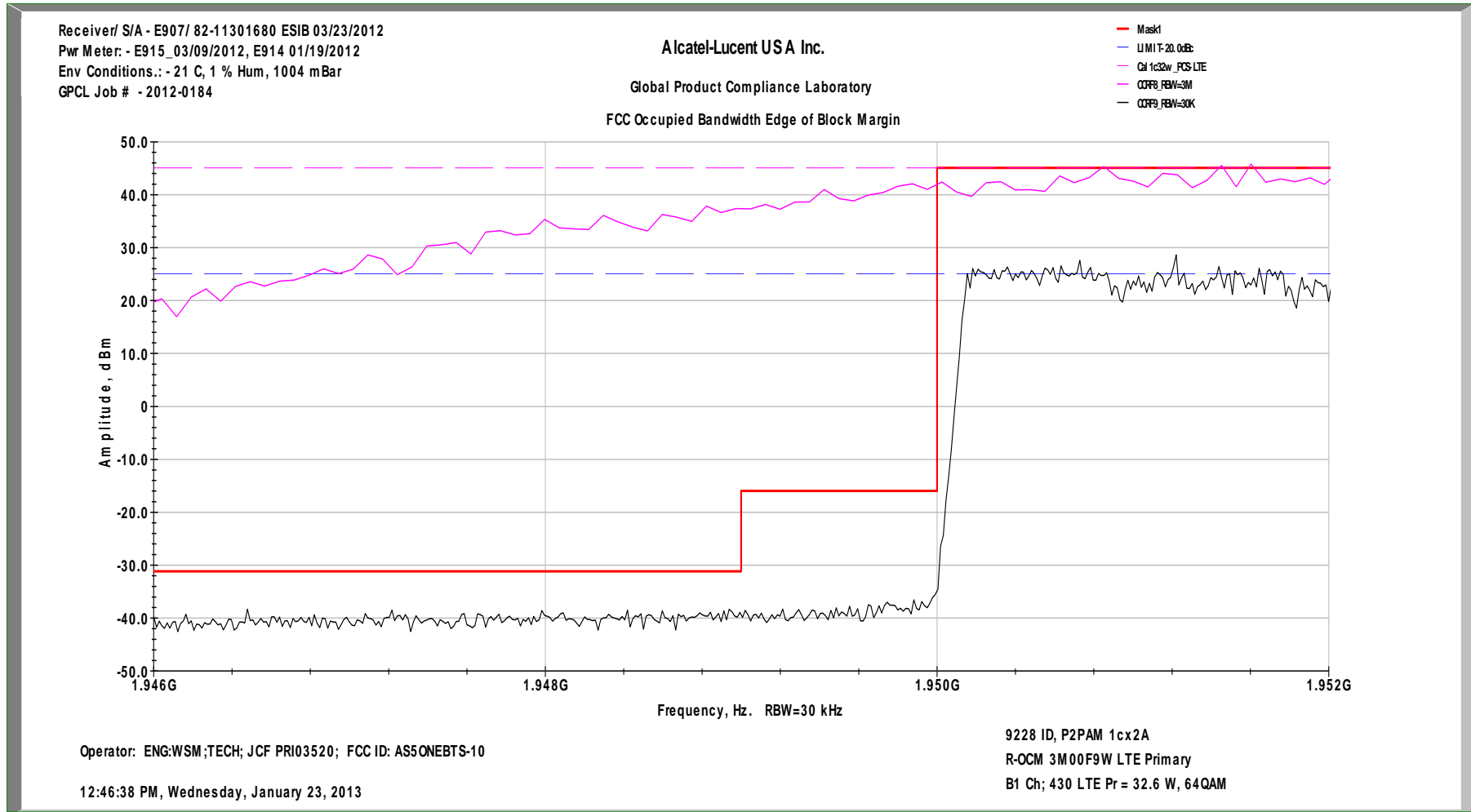

FCC Occupied Bandwidth w/ 3 Modulations LTE3 MHz Ch B-430 1cx2A 32W/c QPSK, 16QAM & 64QAM Primary Tx1

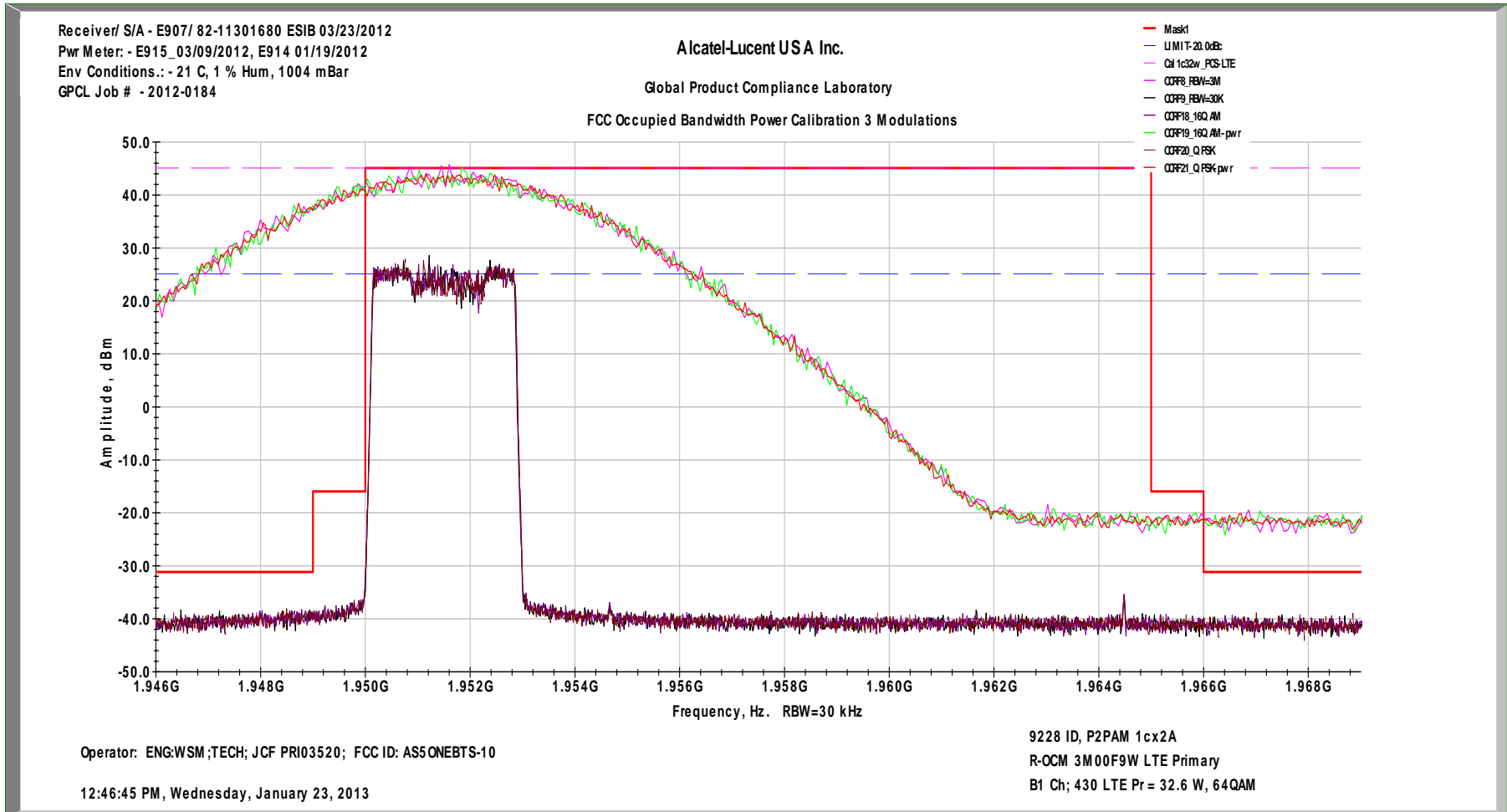

FCC Occupied Bandwidth Emissions LTE3 MHz Ch B-430 1cx1A 32W/c 64QAM Diversity Tx2

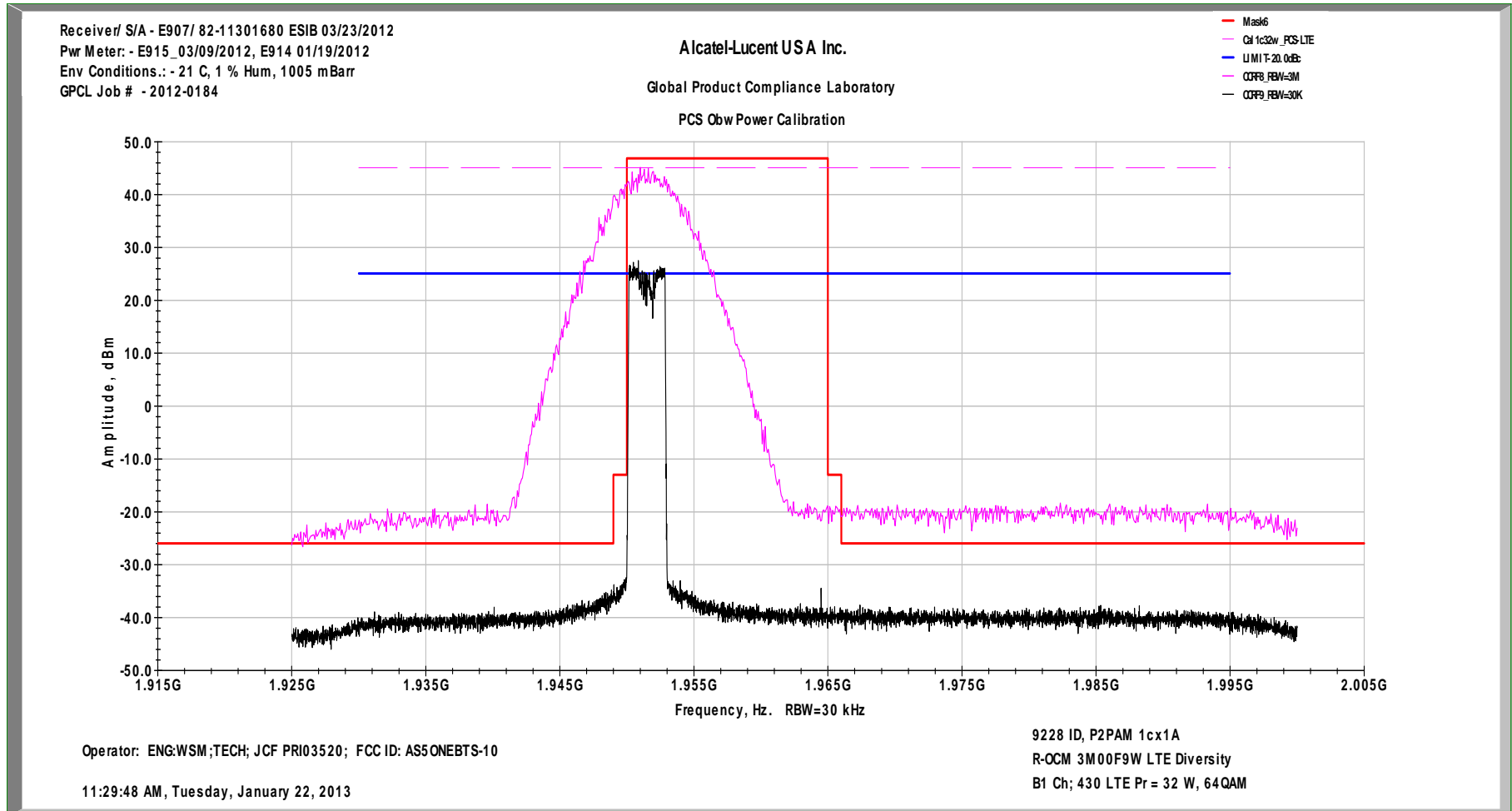

In-Band Intermodulation Graph LTE3 MHz Ch B-430 1cx1A 32W/c 64QAM Diversity Tx2

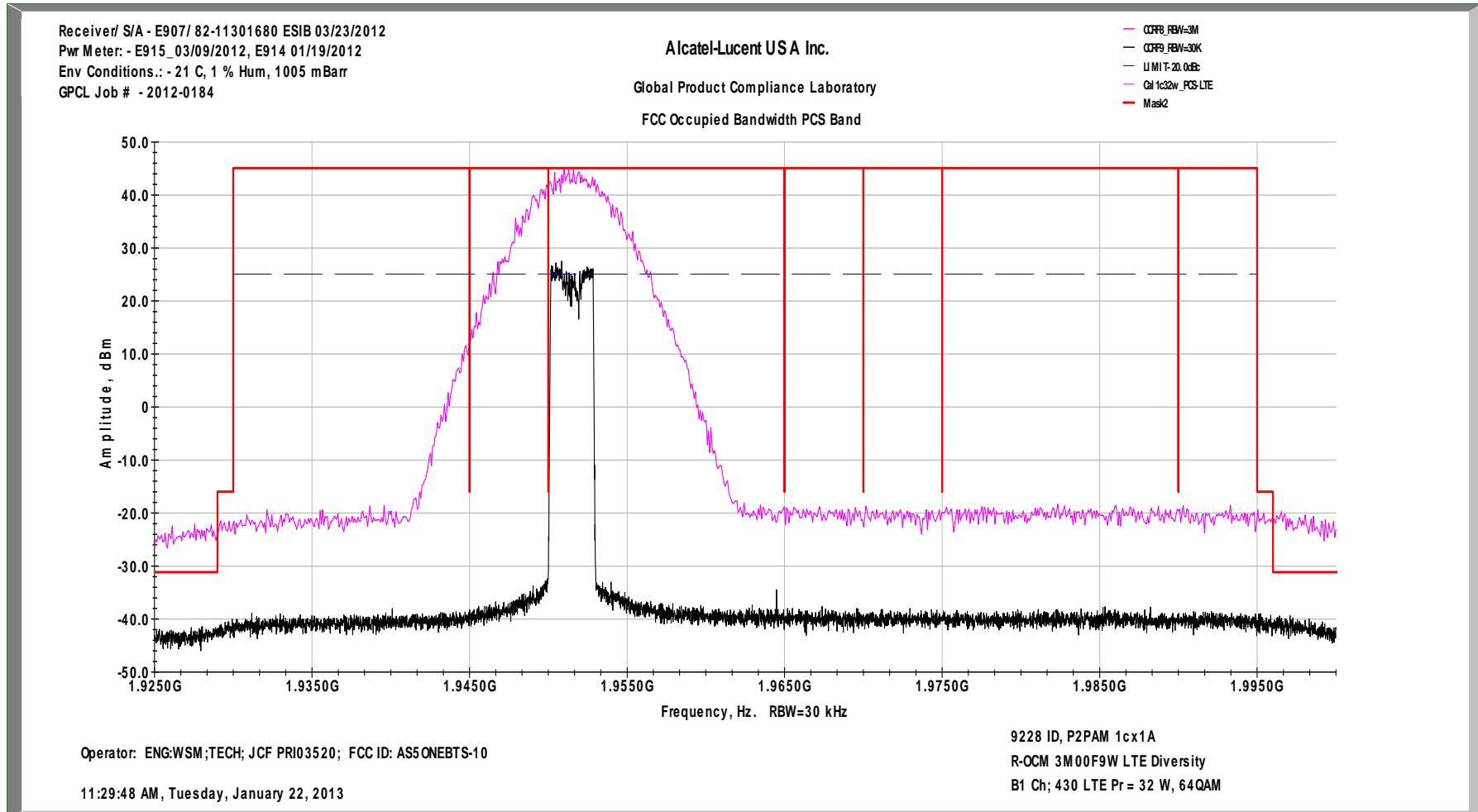

FCC Edge of Block Margin LTE3 MHz Ch B-430 1cx1A 32W/c 64QAM Diversity Tx2

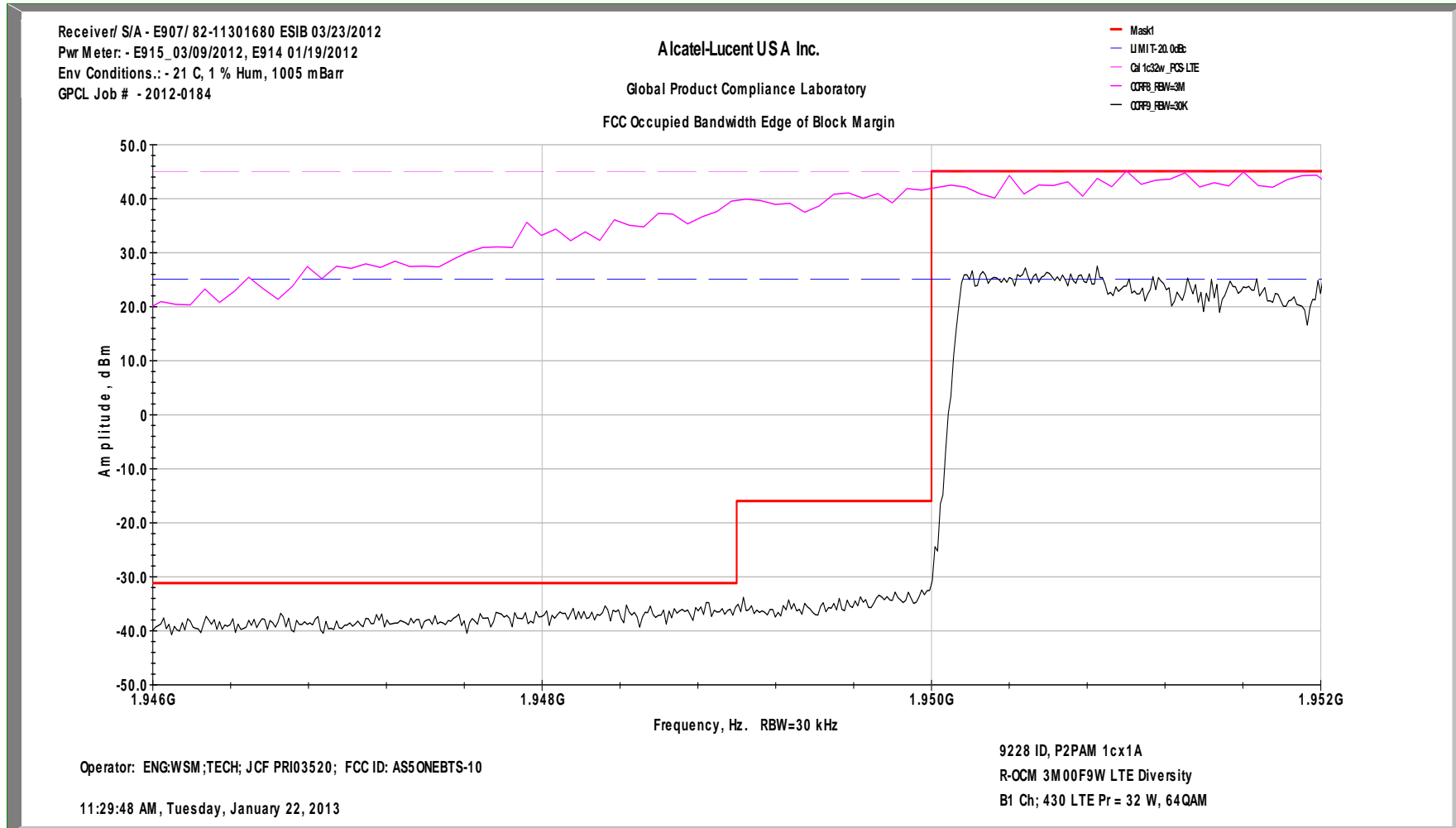

FCC Occupied Bandwidth w/ 3 Modulations LTE3 MHz Ch B-430 1cx1A 32W/c QPSK, 16QAM & 64QAM Diversity Tx2

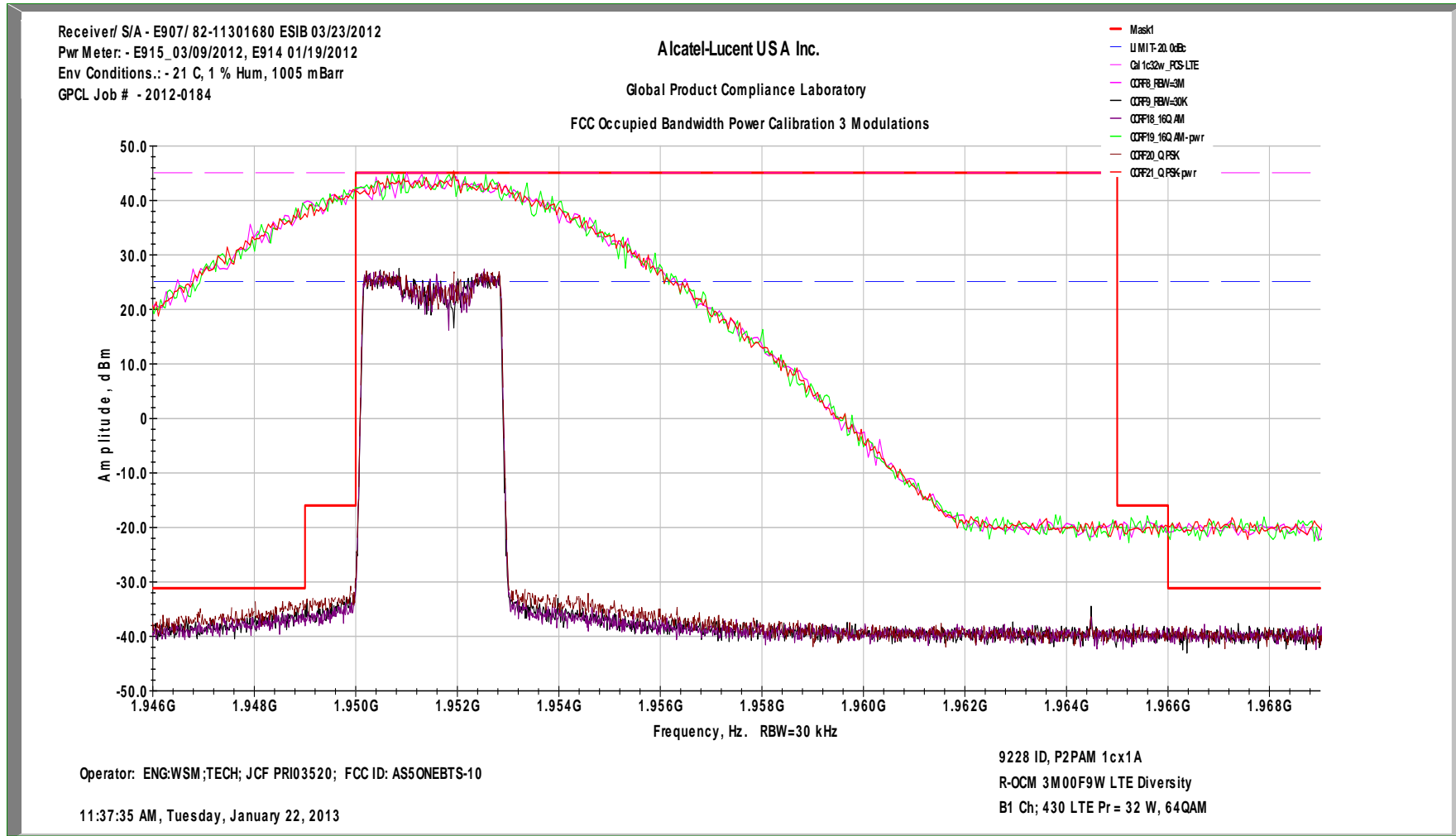

FCC Occupied Bandwidth Emissions LTE3 MHz Ch B-670 1cx2A 32W/c 64QAM Primary Tx1

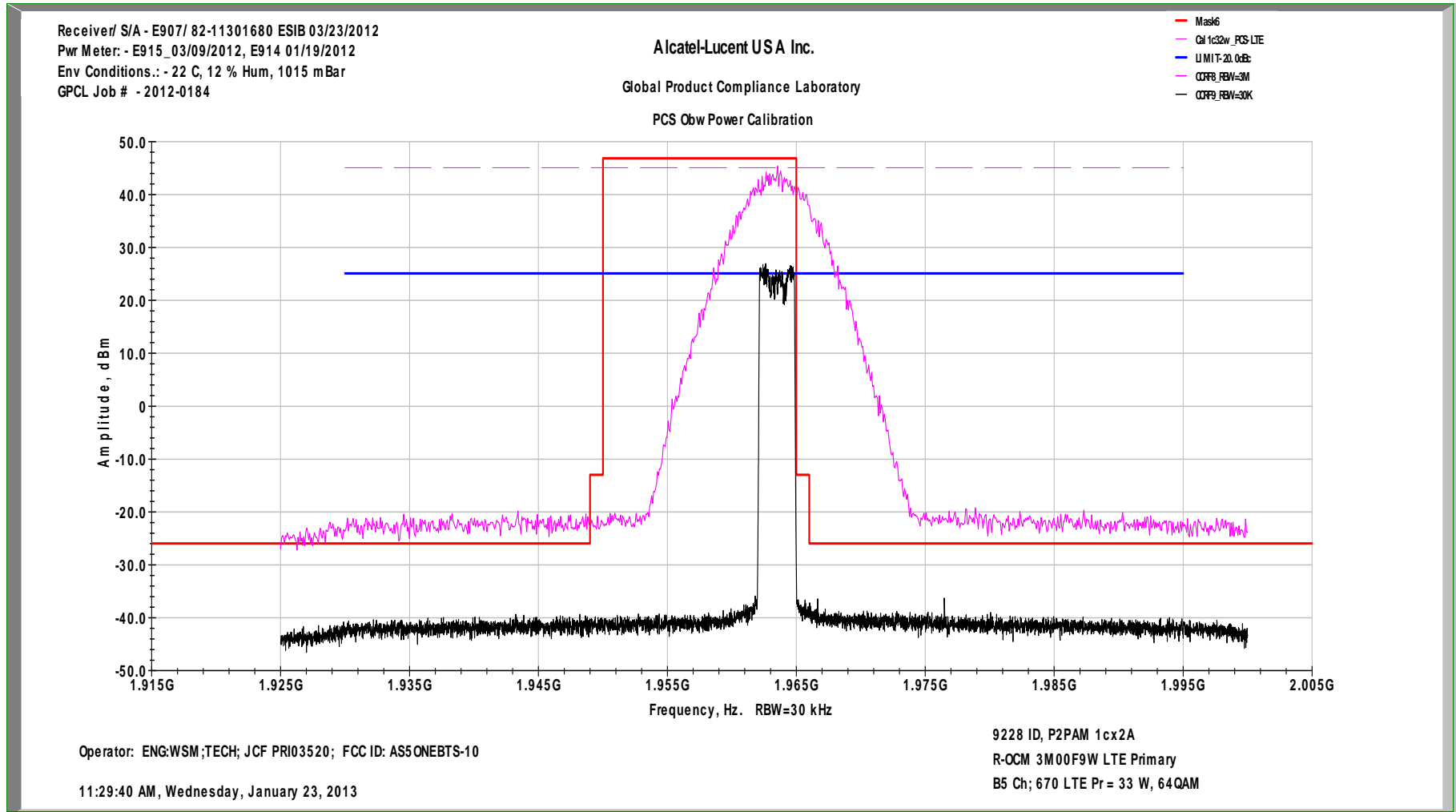

In-Band Intermodulation Graph LTE3 MHz Ch B-670 1cx2A 32W/c 64QAM Primary Tx1

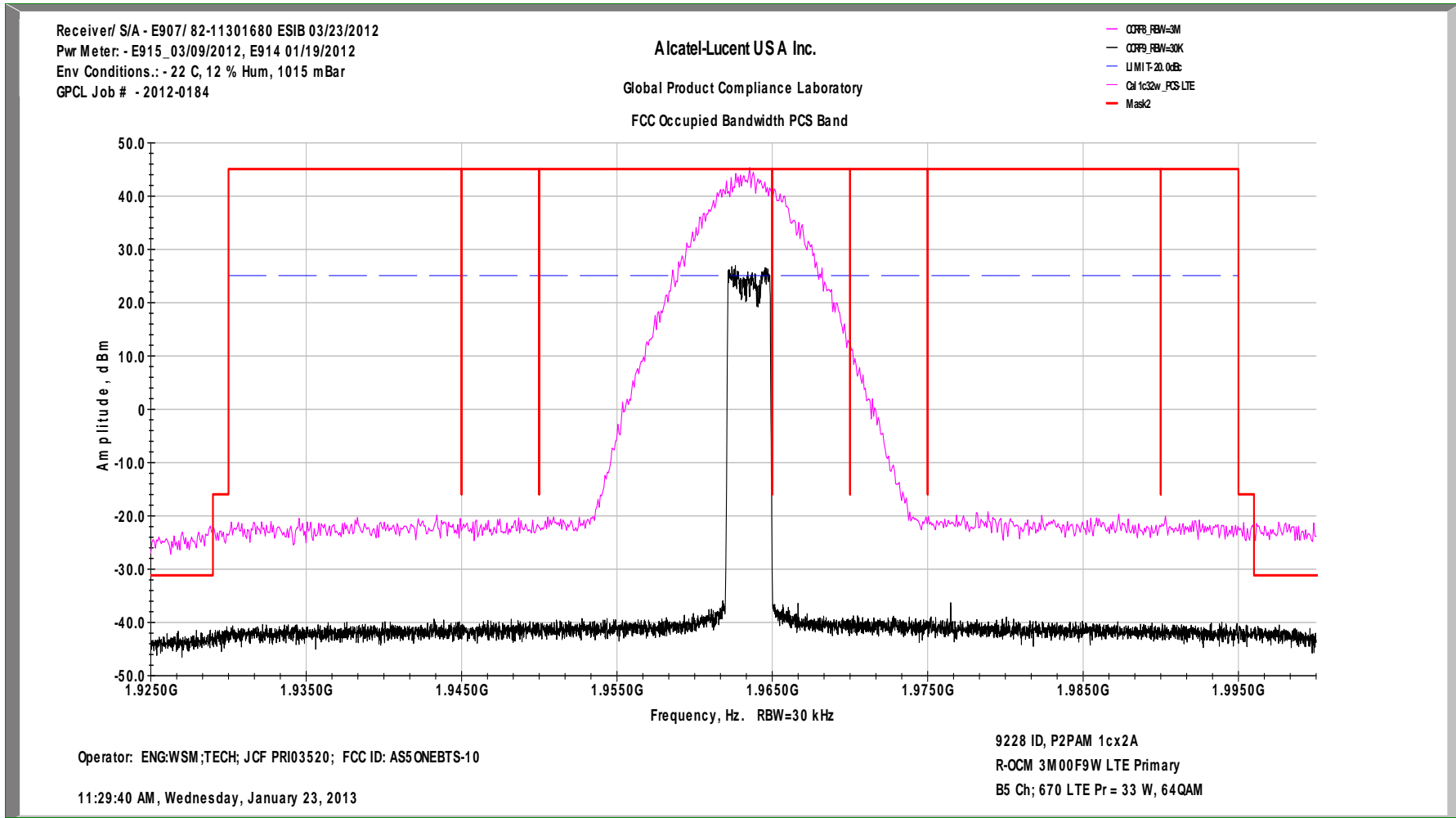

FCC Edge of Block Margin LTE3 MHz Ch B-670 1cx2A 32W/c 64QAM Primary Tx1

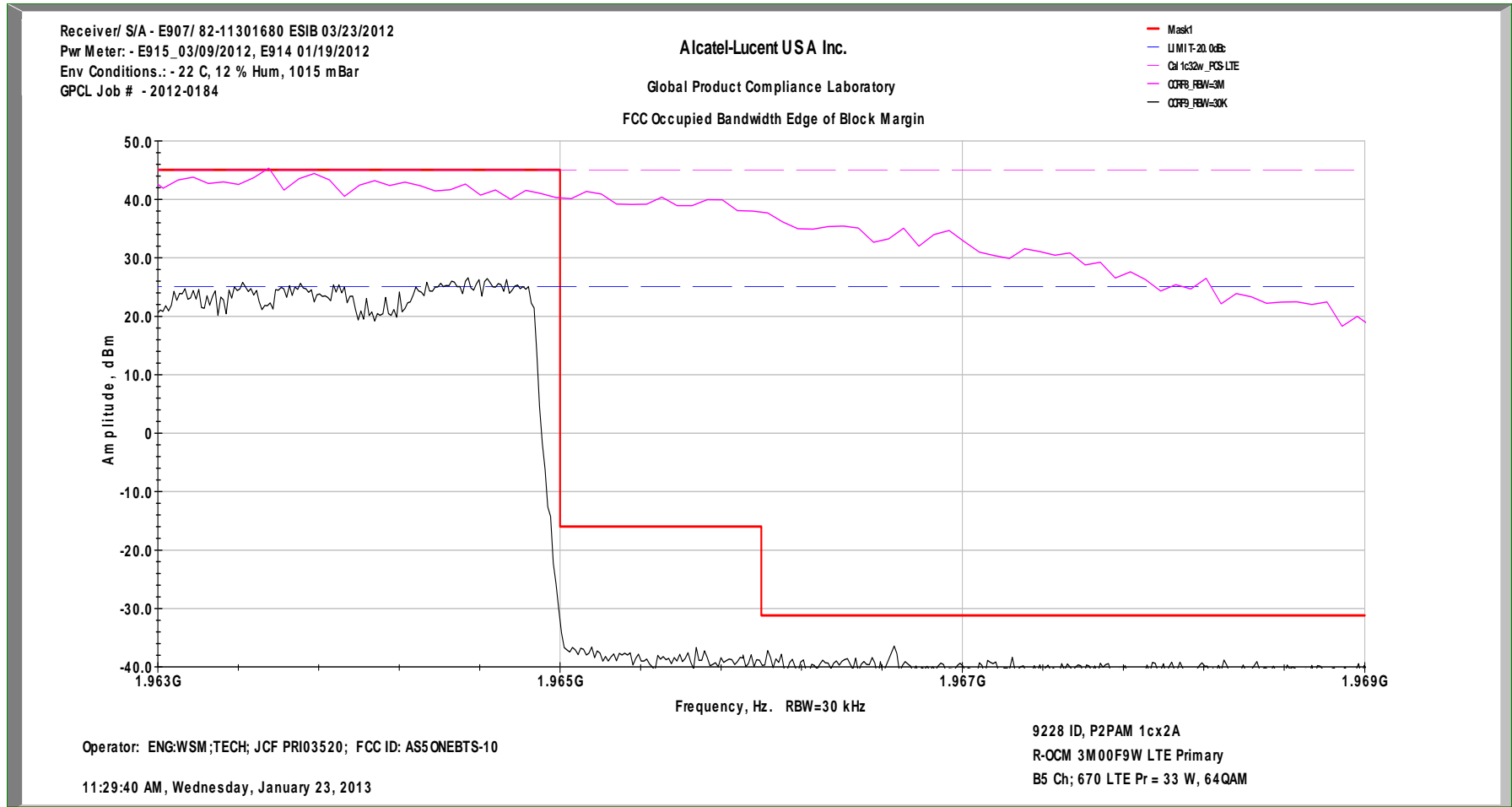

FCC Occupied Bandwidth w/ 3 Modulations LTE3 MHz Ch B-670 1cx2A 32W/c QPSK, 16QAM & 64QAM Primary Tx1

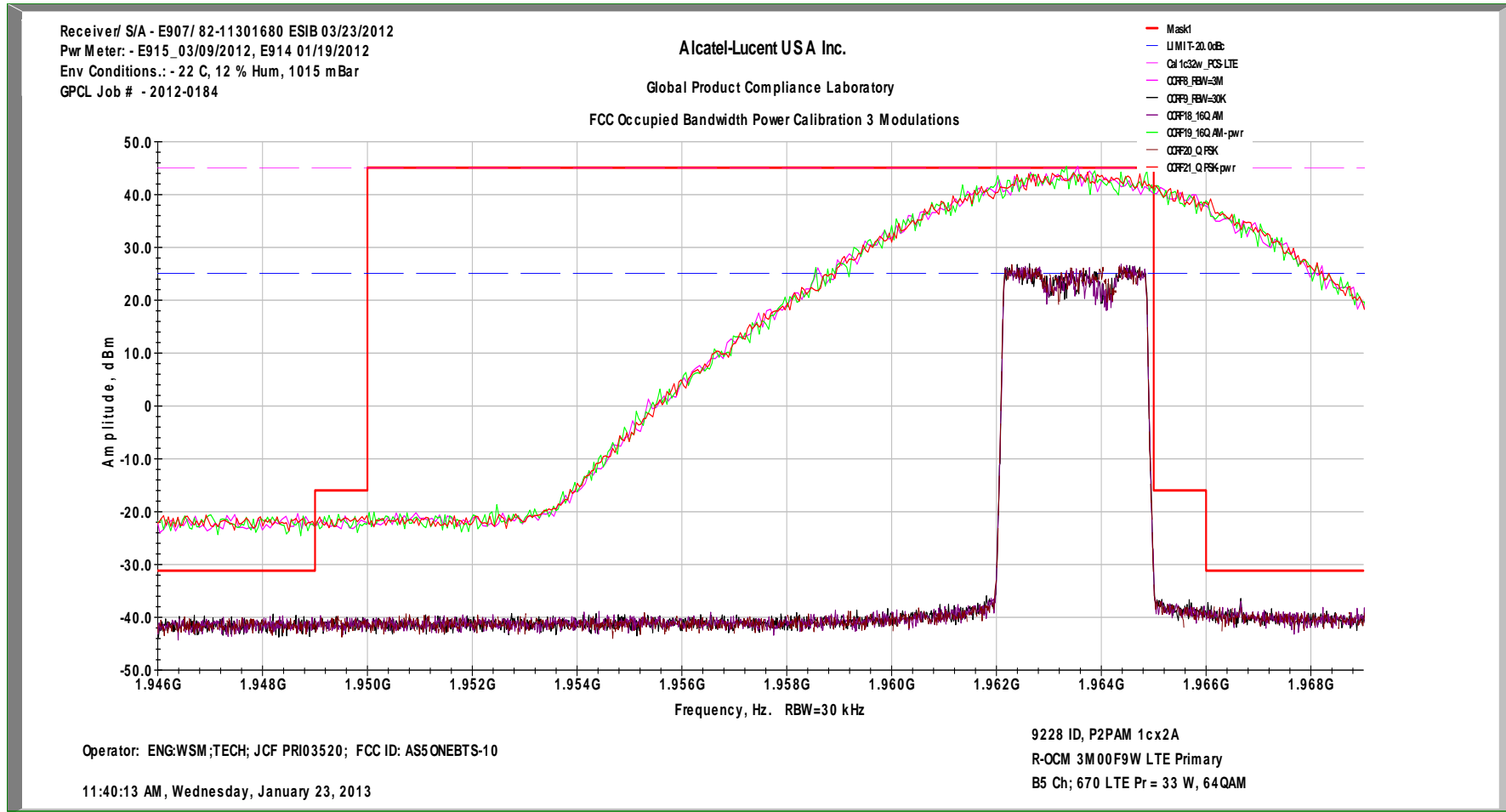

FCC Occupied Bandwidth Emissions LTE3 MHz Ch B-670 1cx1A 32W/c 64QAM Diversity Tx2

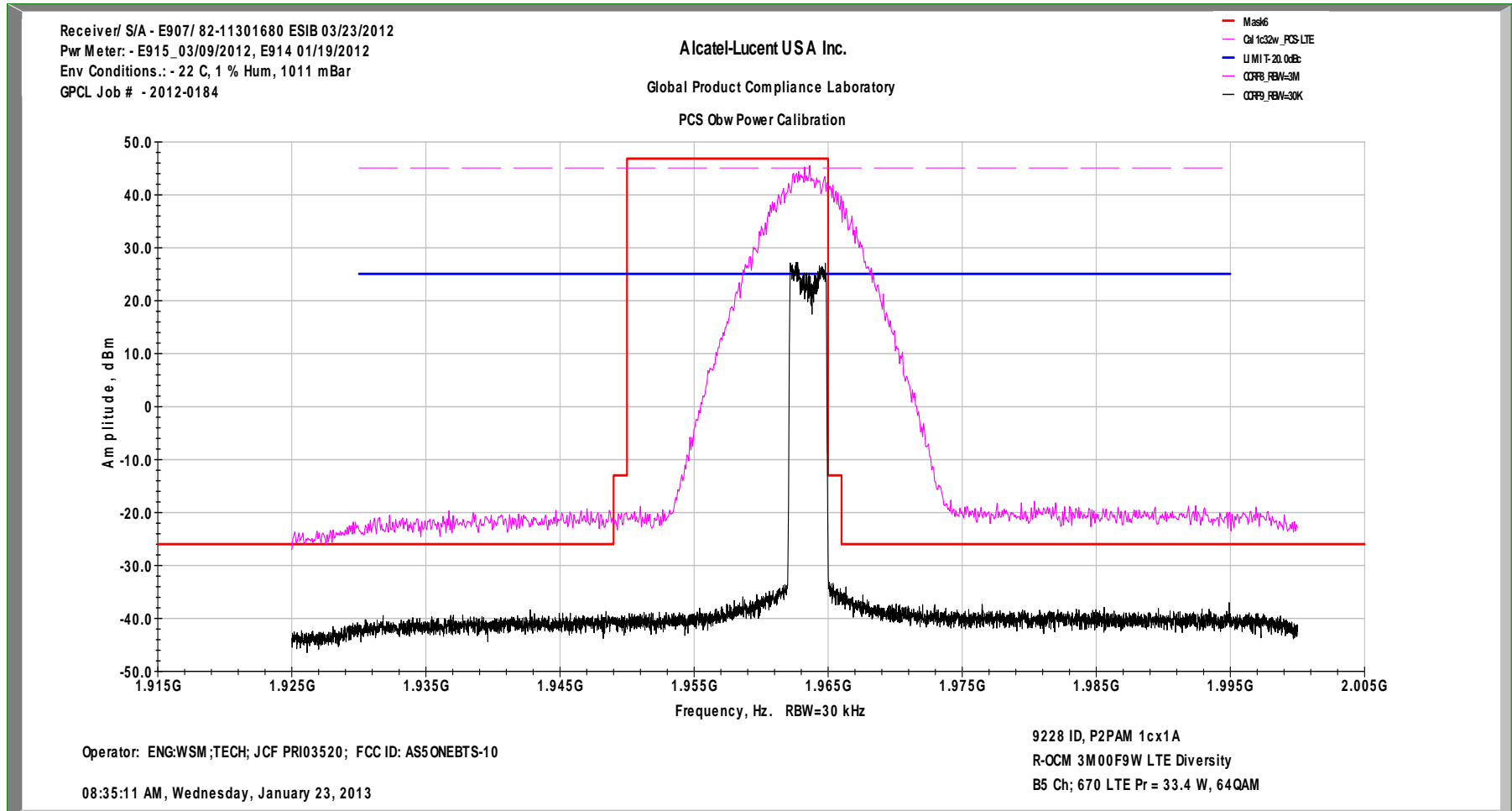

In-Band Intermodulation Graph LTE3 MHz Ch B-670 1cx1A 32W/c 64QAM Diversity Tx2

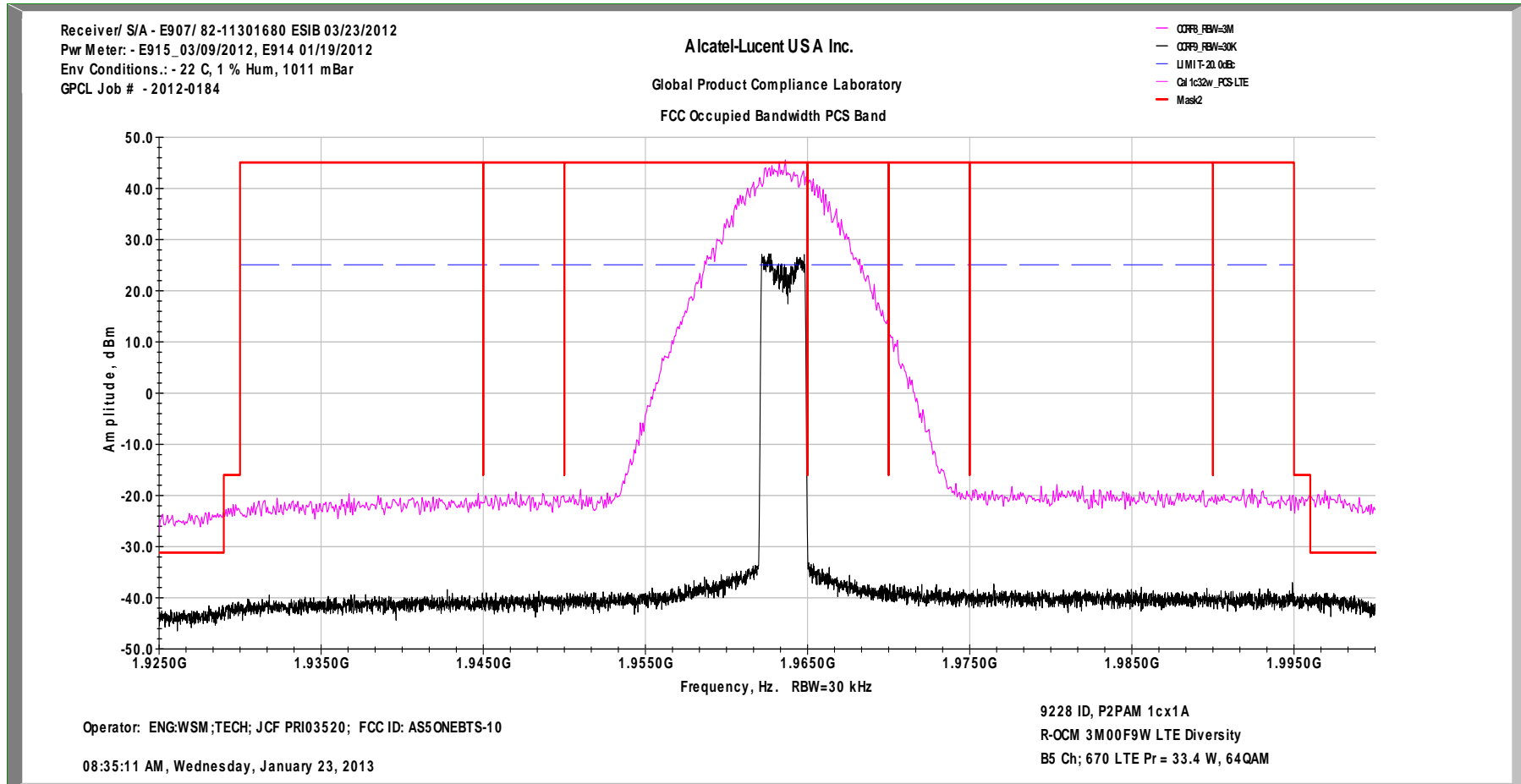

FCC Edge of Block Margin LTE3 MHz Ch B-670 1cx1A 32W/c 64QAM Diversity Tx2

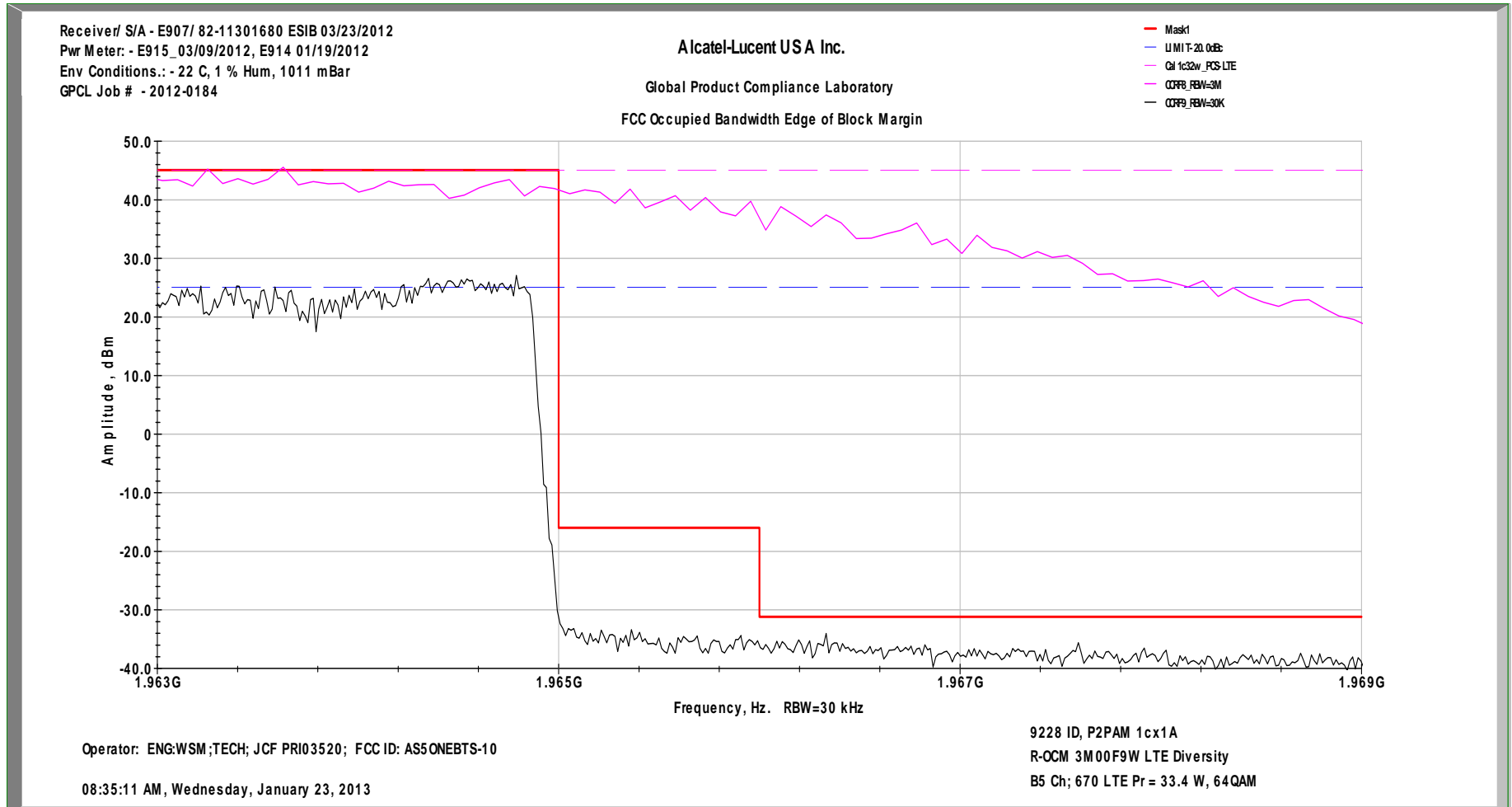

FCC Occupied Bandwidth w/ 3 Modulations LTE3 MHz Ch B-670 1cx1A 32W/c QPSK, 16QAM & 64QAM Diversity Tx2

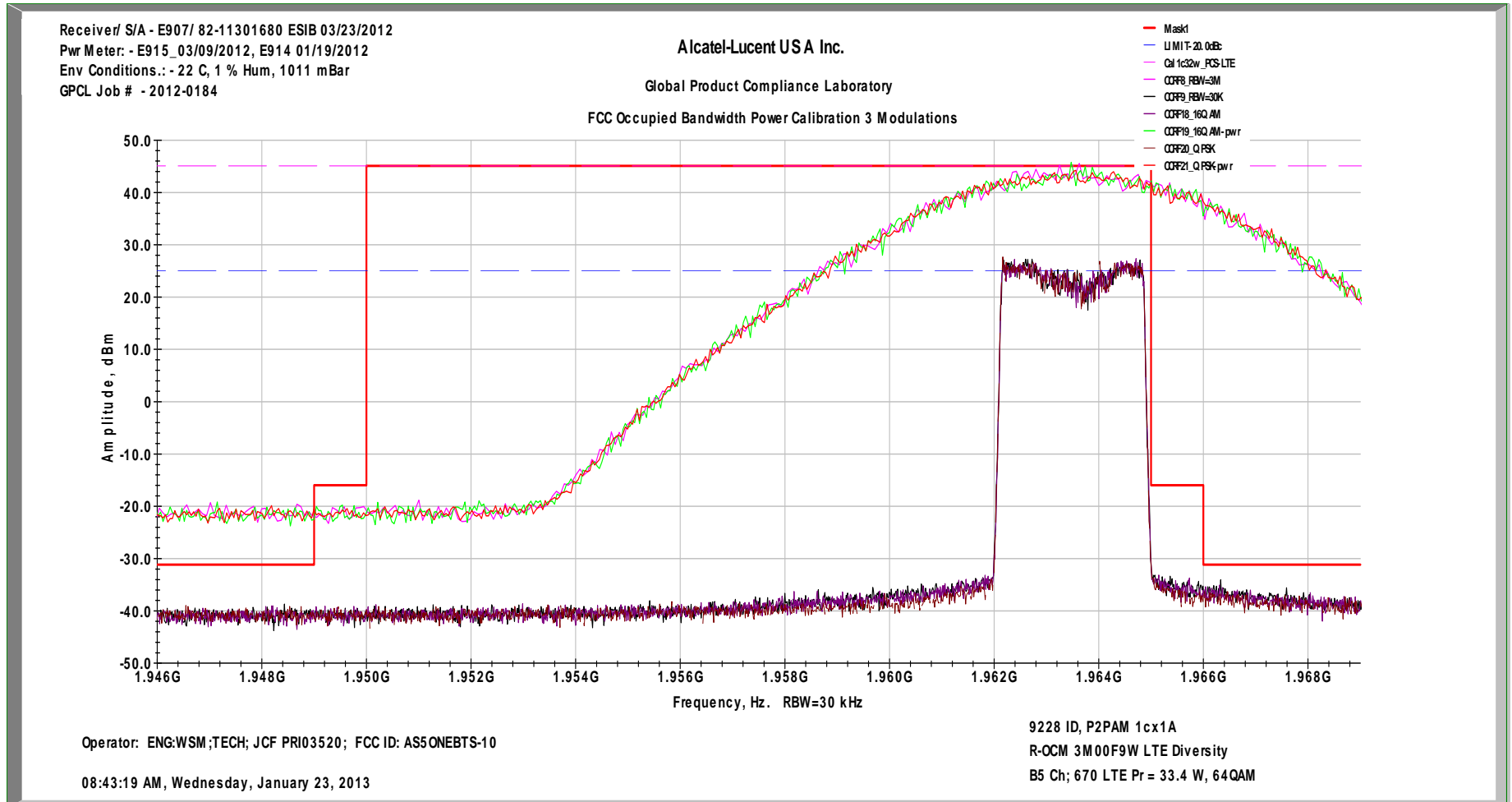

FCC Occupied Bandwidth Emissions LTE3 MHz Ch E-730 1cx2A 32W/c 64QAM Primary Tx1

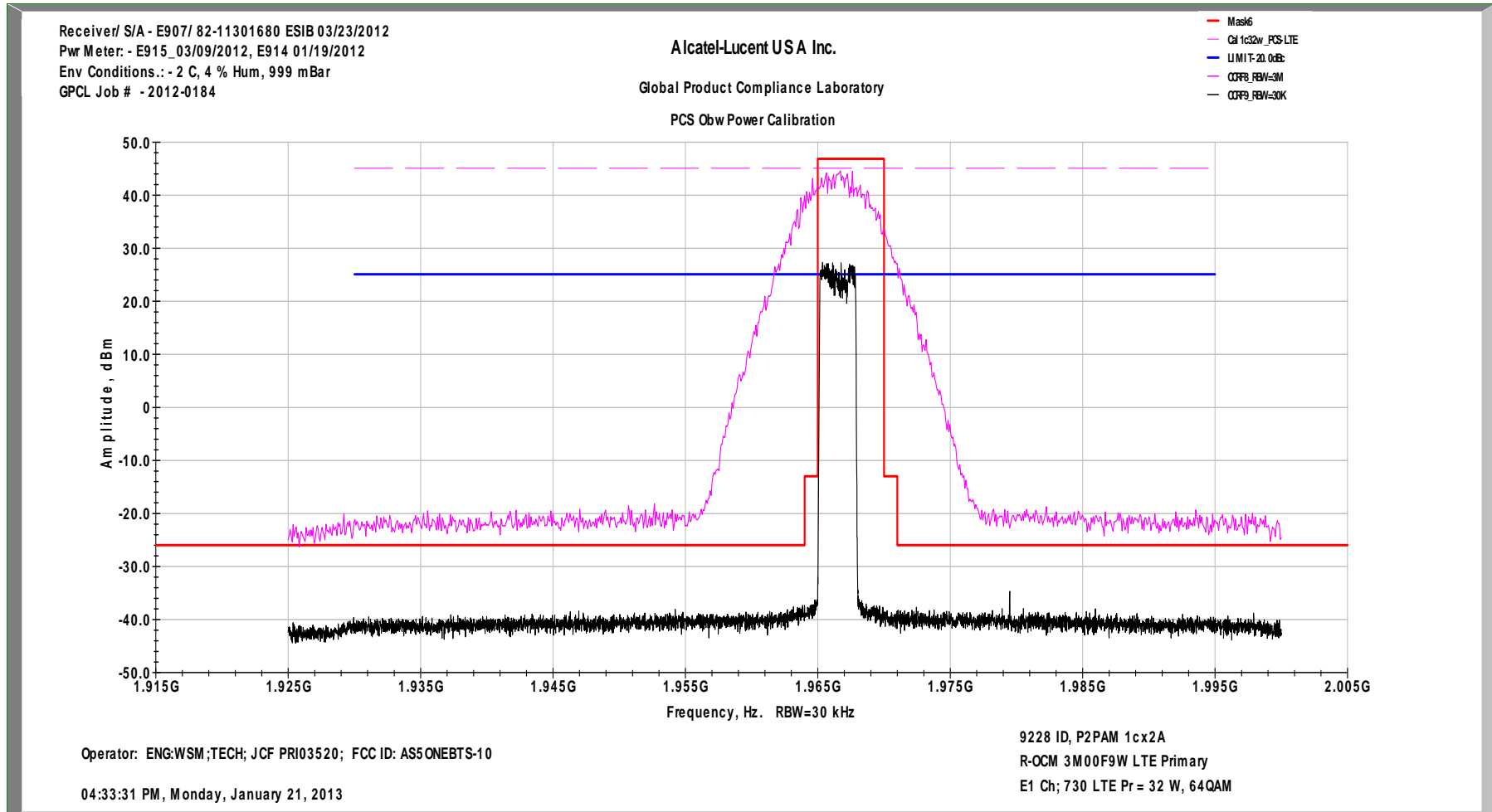

In-Band Intermodulation Graph LTE3 MHz Ch E-730 1cx2A 32W/c 64QAM Primary Tx1

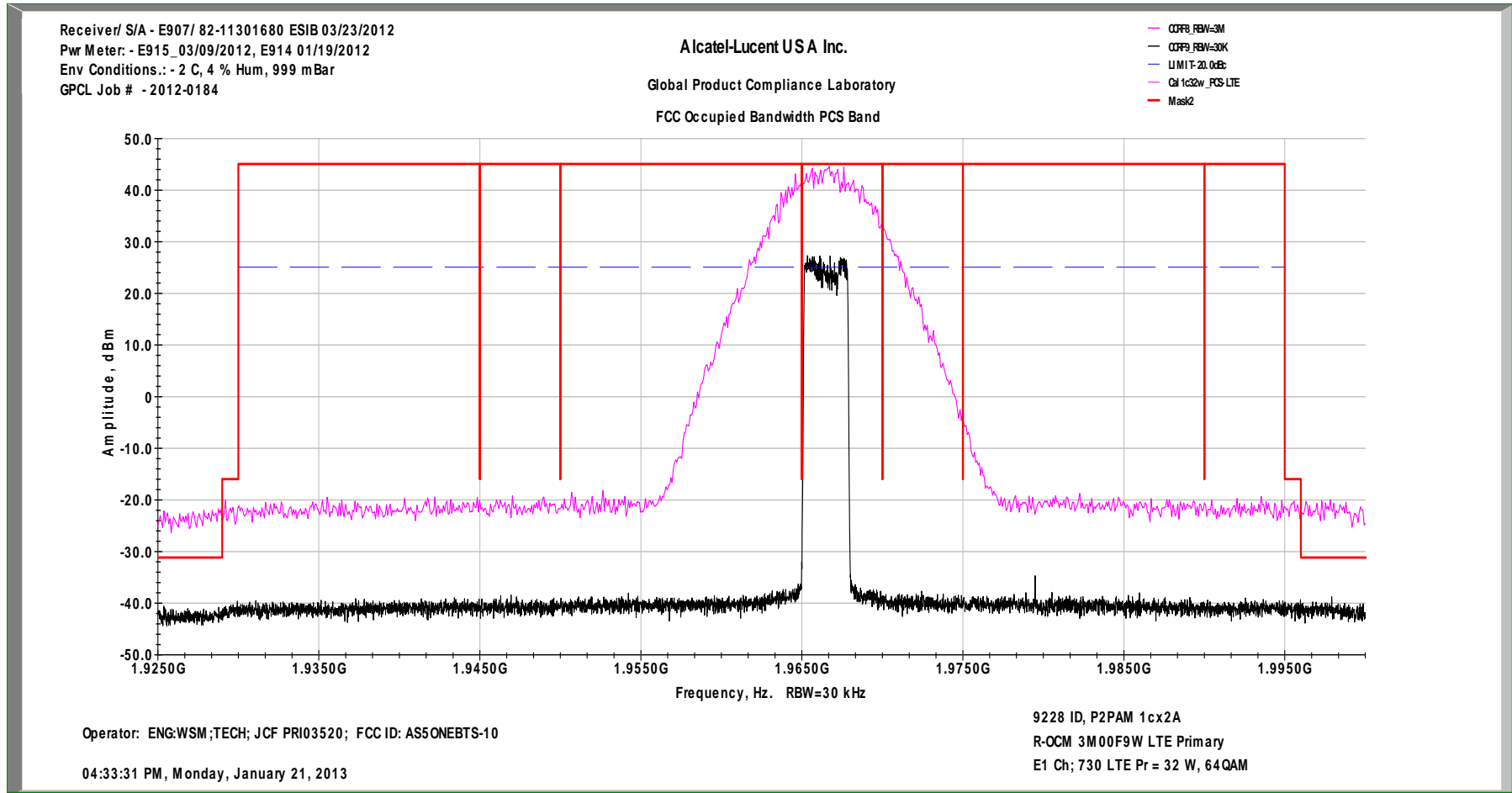

FCC Edge of Block Margin LTE3 MHz Ch E-730 1cx2A 32W/c 64QAM Primary Tx1

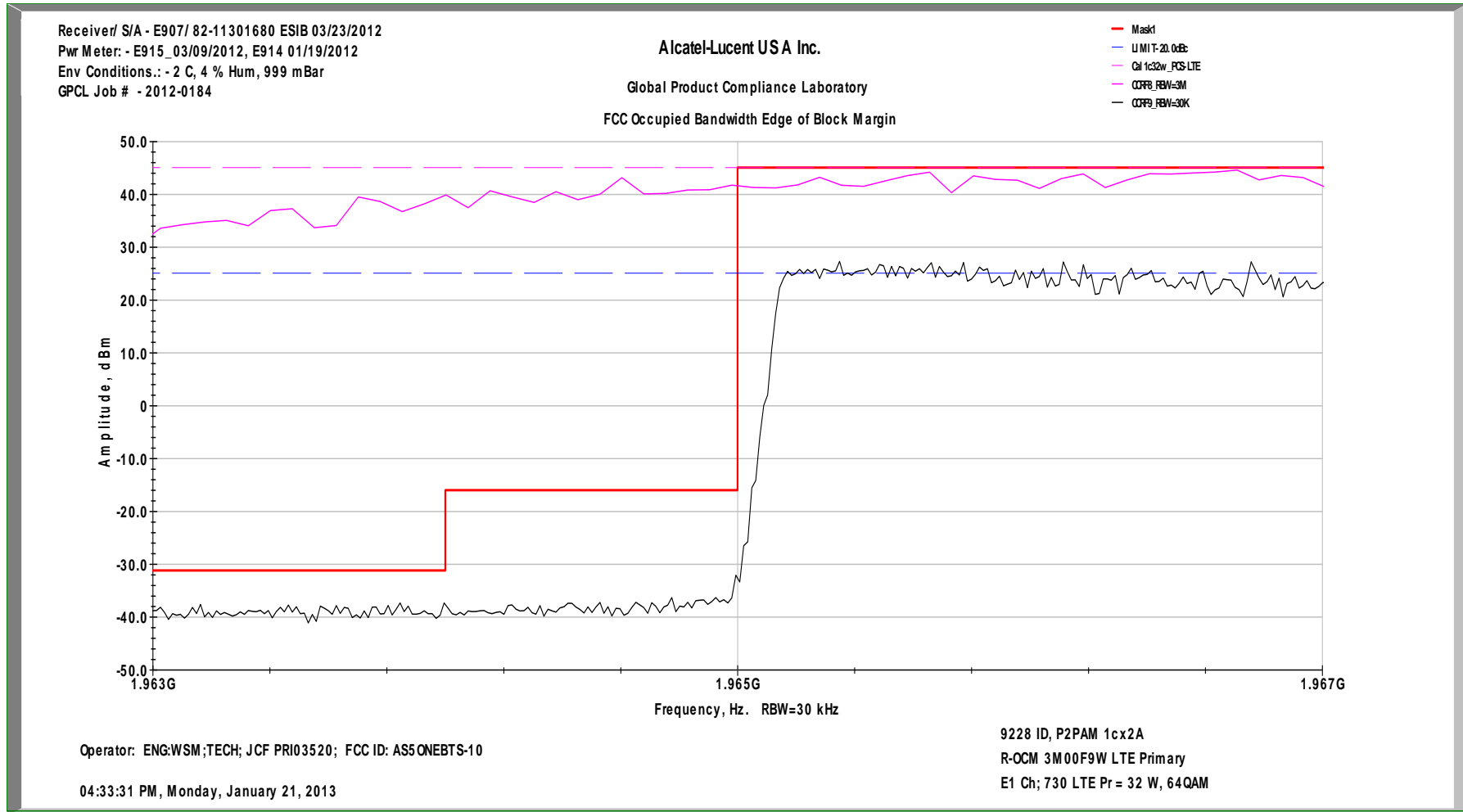

FCC Occupied Bandwidth w/ 3 Modulations LTE3 MHz Ch E-730 1cx2A 32W/c QPSK, 16QAM & 64QAM Primary Tx1

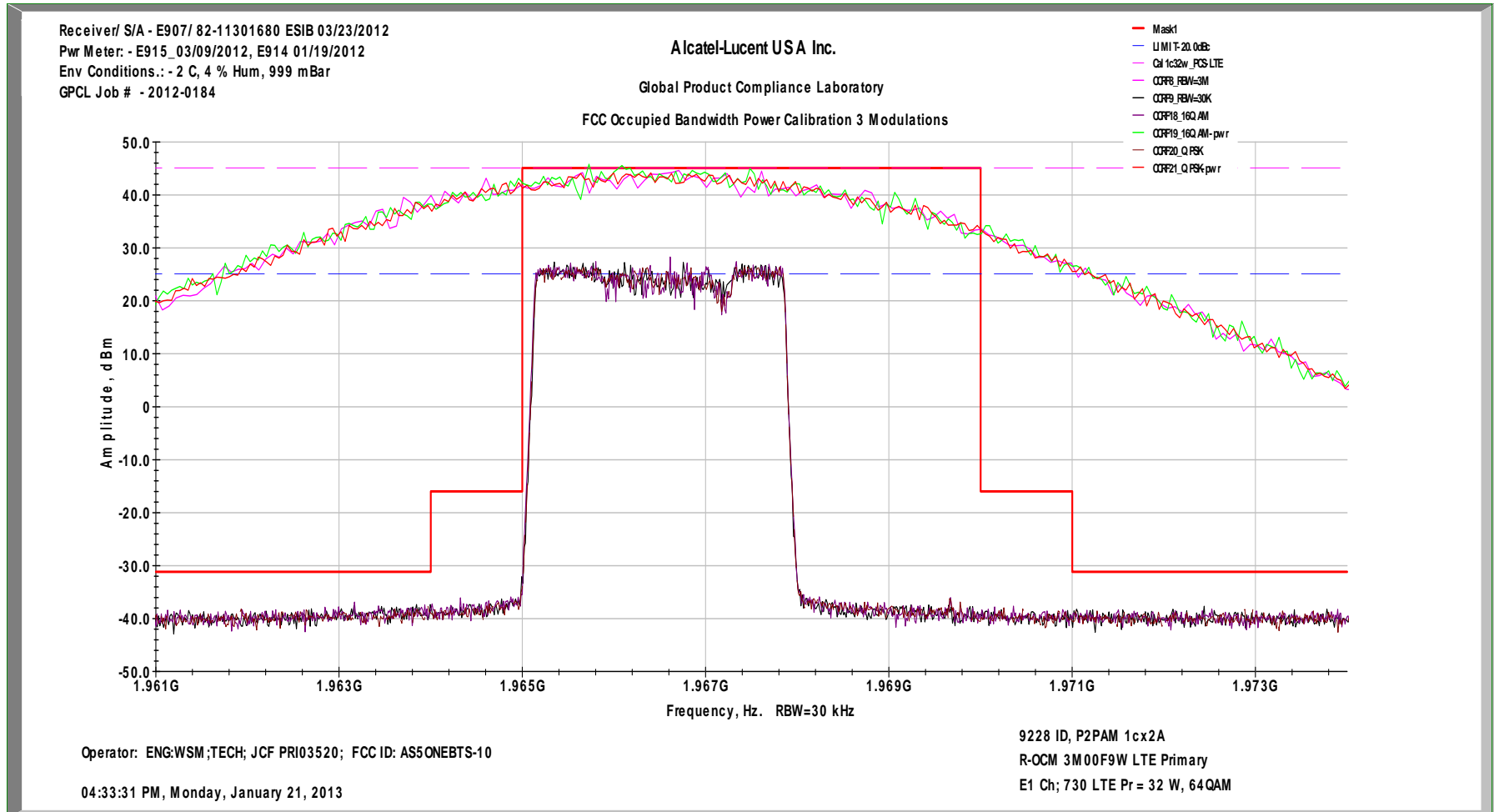

FCC Occupied Bandwidth Emissions LTE3 MHz Ch E-730 1cx1A 32W/c 64QAM Diversity Tx2

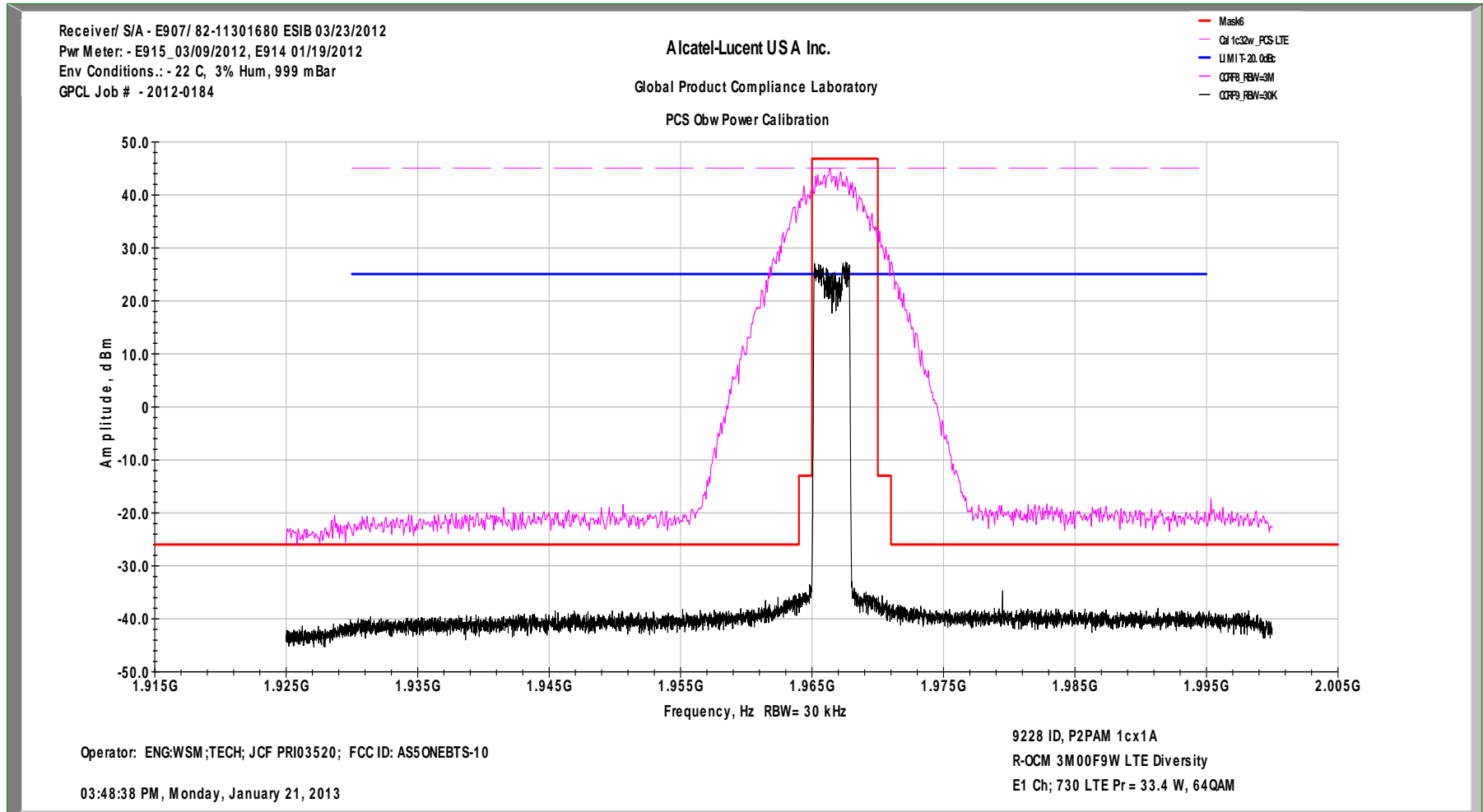

In-Band Intermodulation Graph LTE3 MHz Ch E-730 1cx1A 32W/c 64QAM Diversity Tx2

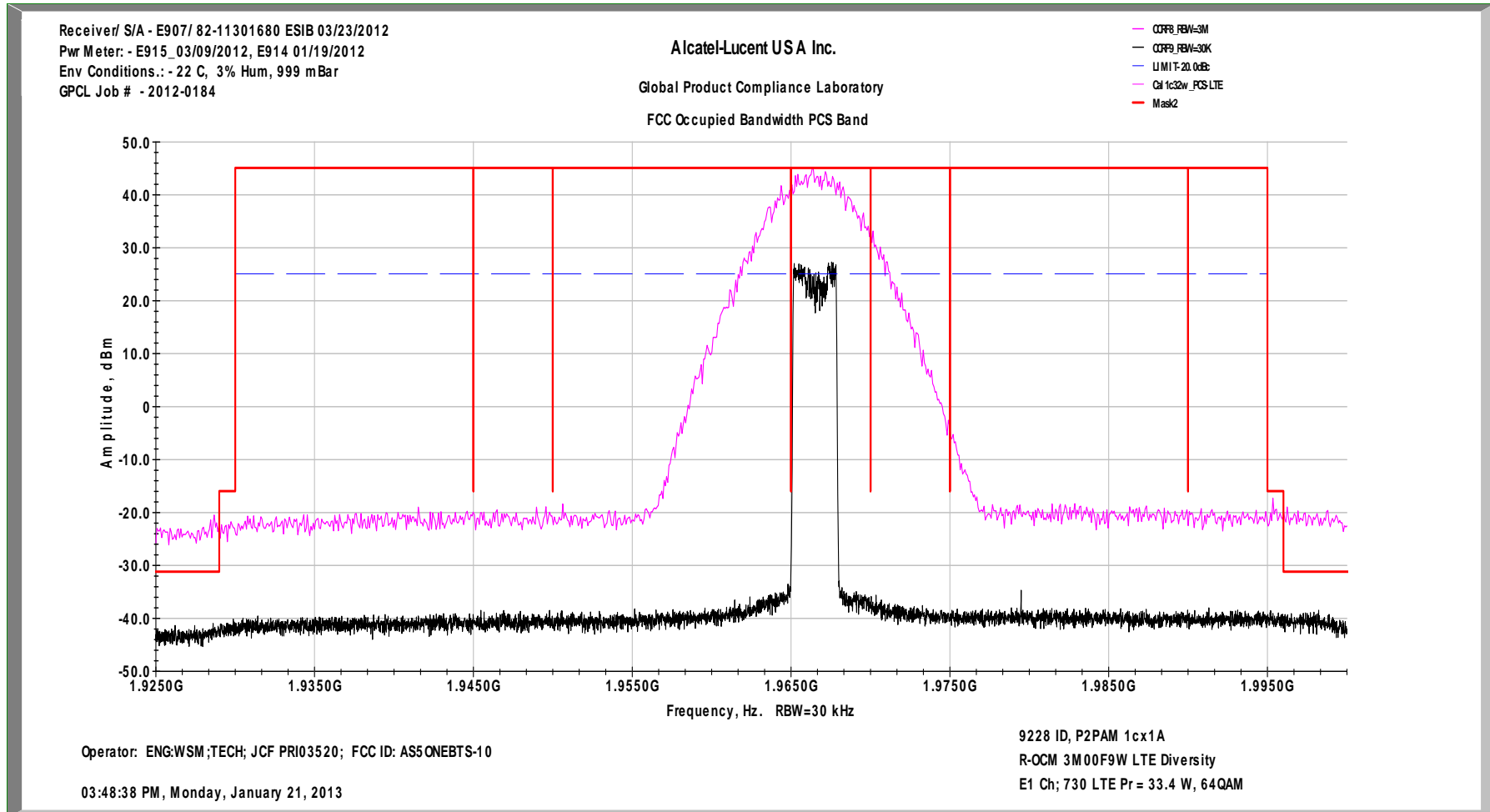

FCC Edge of Block Margin LTE3 MHz Ch E-730 1cx1A 32W/c 64QAM Diversity Tx2

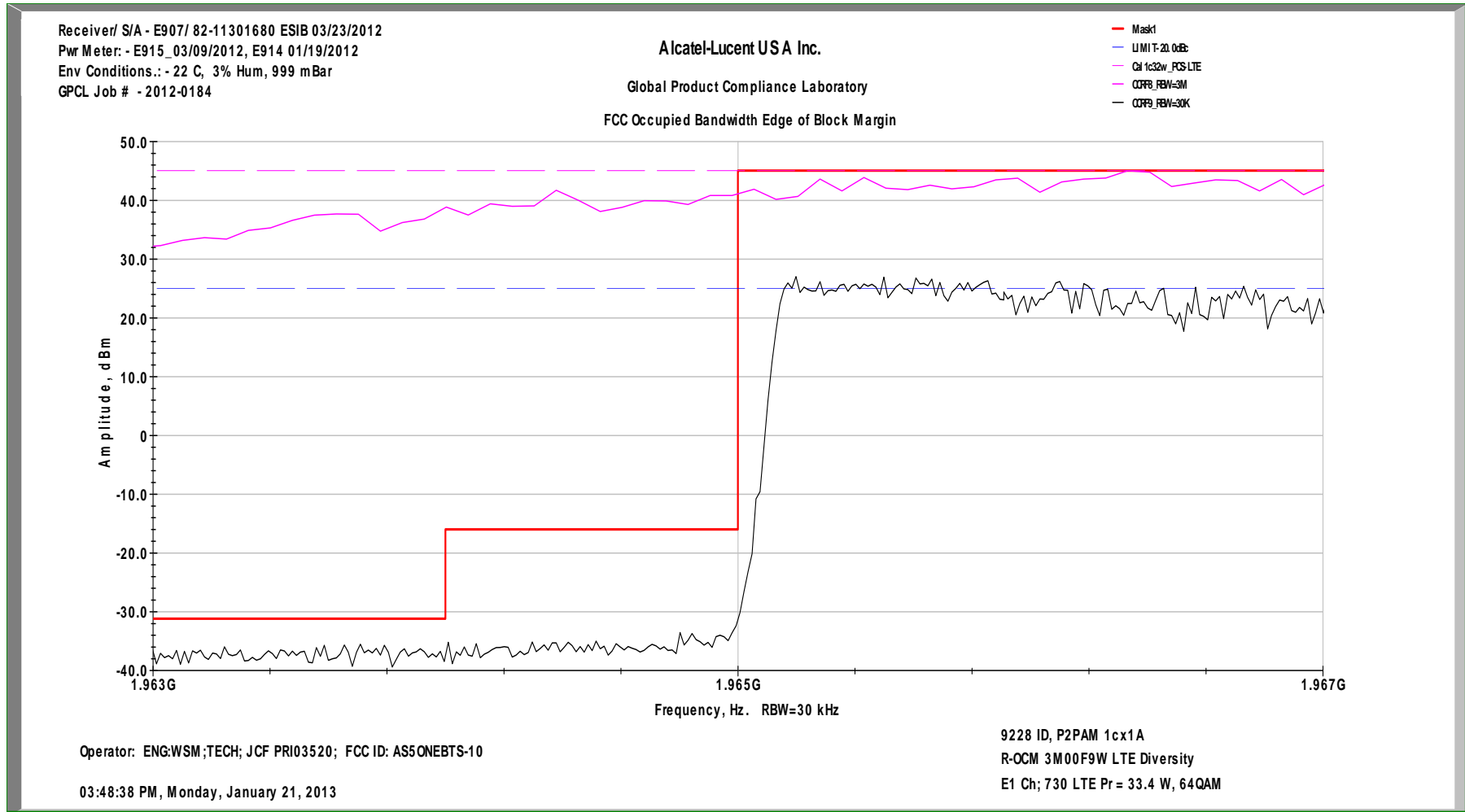

FCC Occupied Bandwidth w/ 3 Modulations LTE3 MHz Ch E-730 1cx1A 32W/c QPSK, 16QAM & 64QAM Diversity Tx2

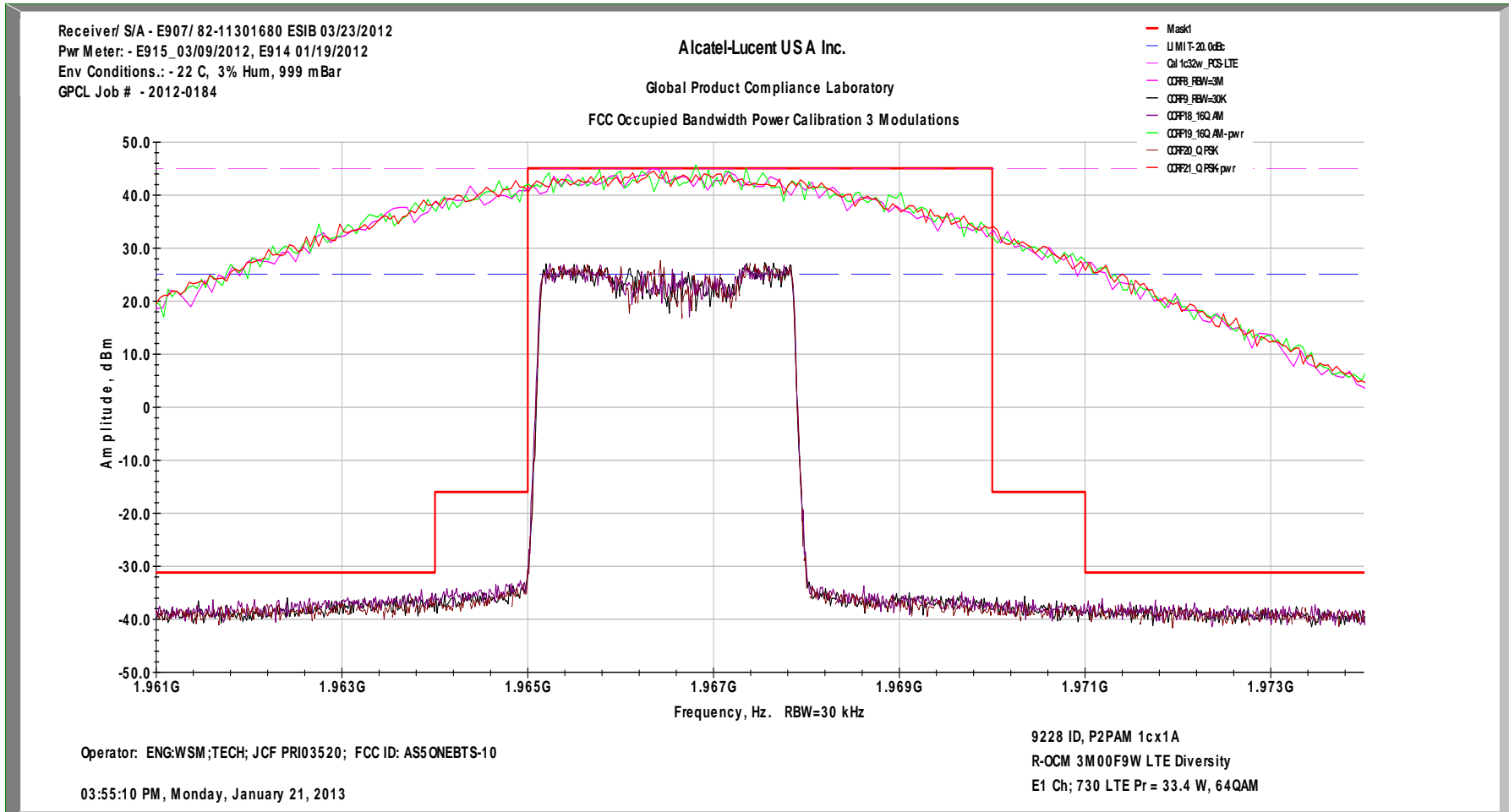

FCC Occupied Bandwidth Emissions LTE3 MHz Ch E-770 1cx2A 32W/c 64QAM Primary Tx1

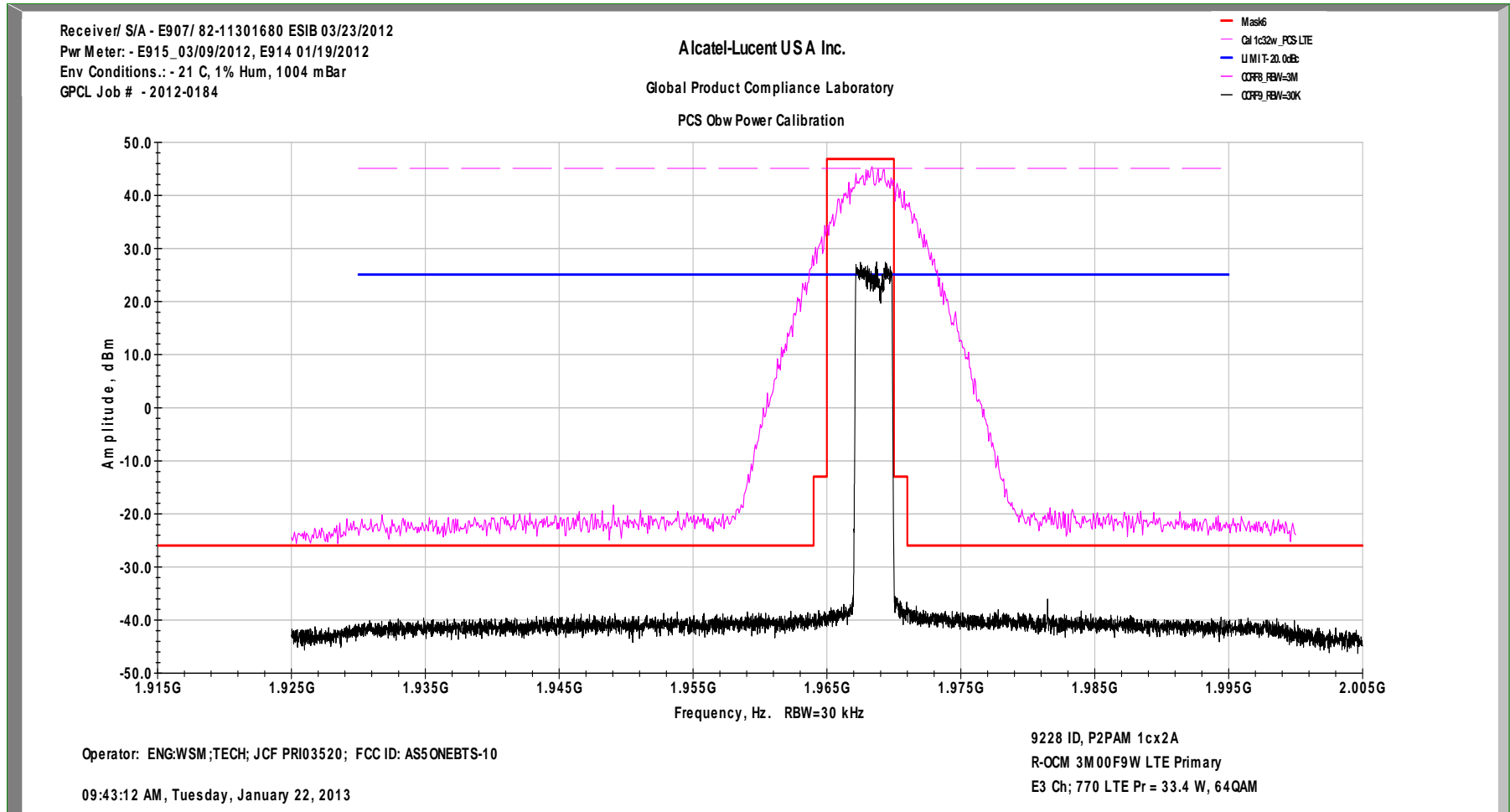

In-Band Intermodulation Graph LTE3 MHz Ch E-770 1cx2A 32W/c 64QAM Primary Tx1

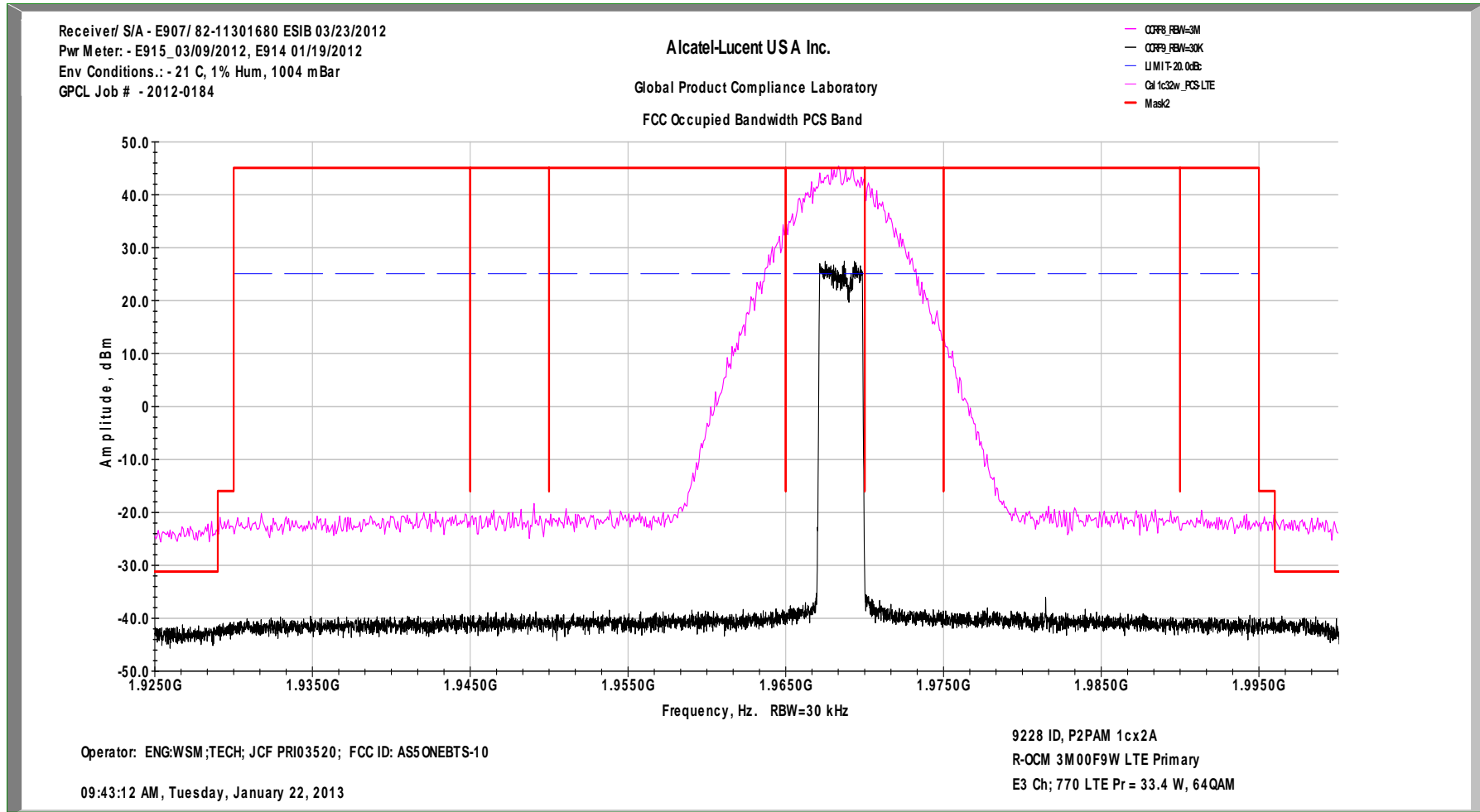

FCC Edge of Block Margin LTE3 MHz Ch E-770 1cx2A 32W/c 64QAM Primary Tx1

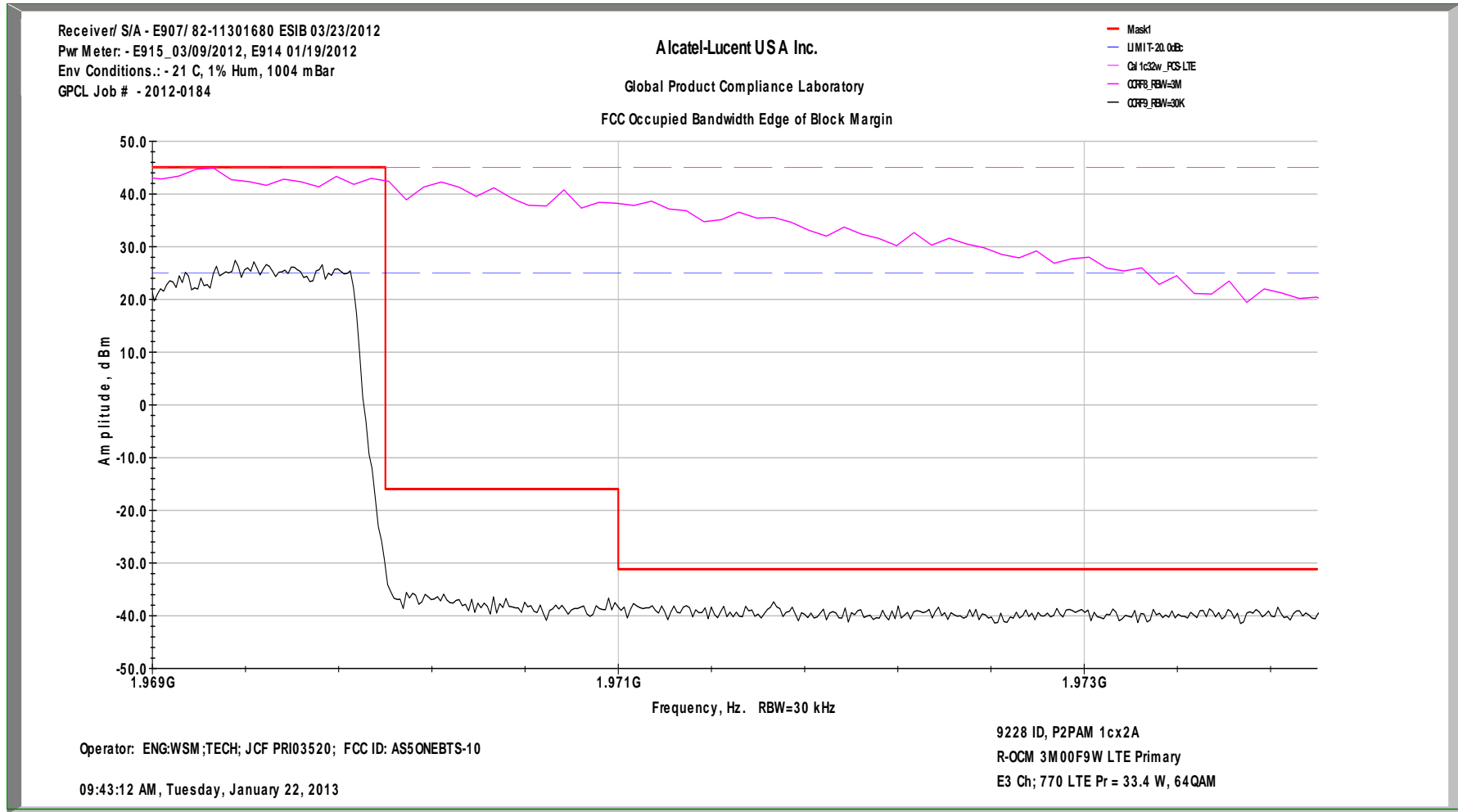

FCC Occupied Bandwidth w/ 3 Modulations LTE3 MHz Ch E-770 1cx2A 32W/c QPSK, 16QAM & 64QAM Primary Tx1

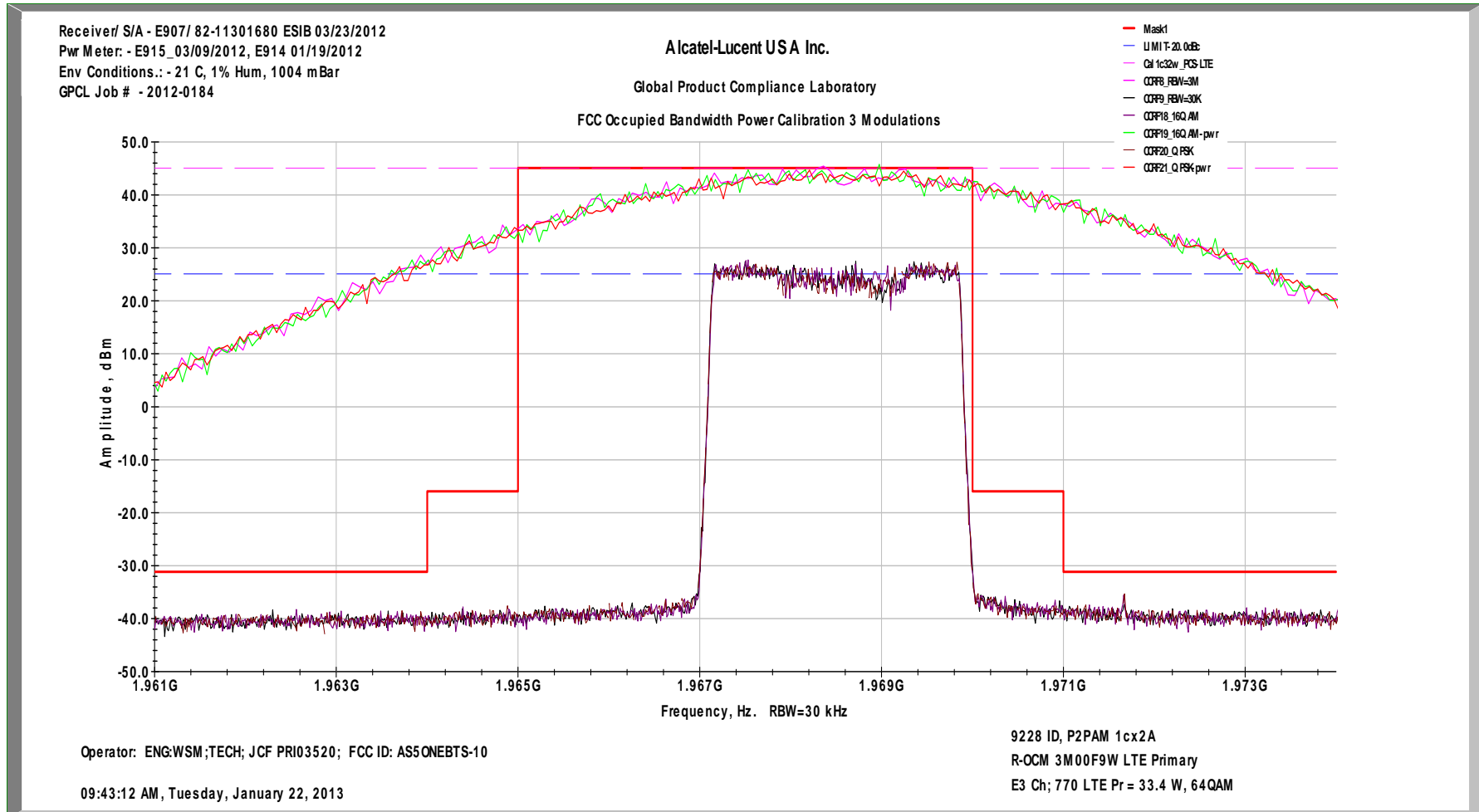

FCC Occupied Bandwidth Emissions LTE3 MHz Ch E-770 1cx1A 32W/c 64QAM Diversity Tx2

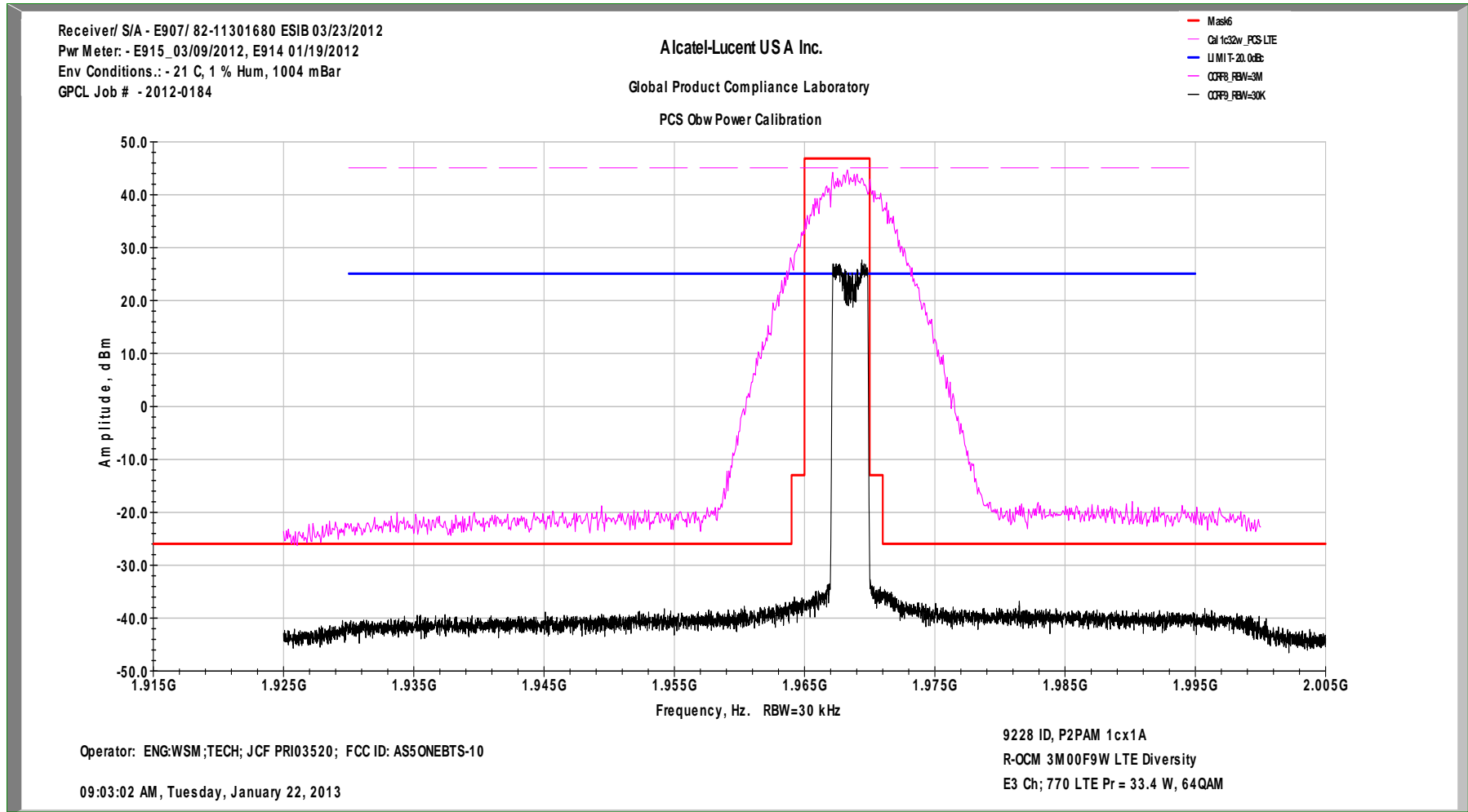

In-Band Intermodulation Graph LTE3 MHz Ch E-770 1cx1A 32W/c 64QAM Diversity Tx2

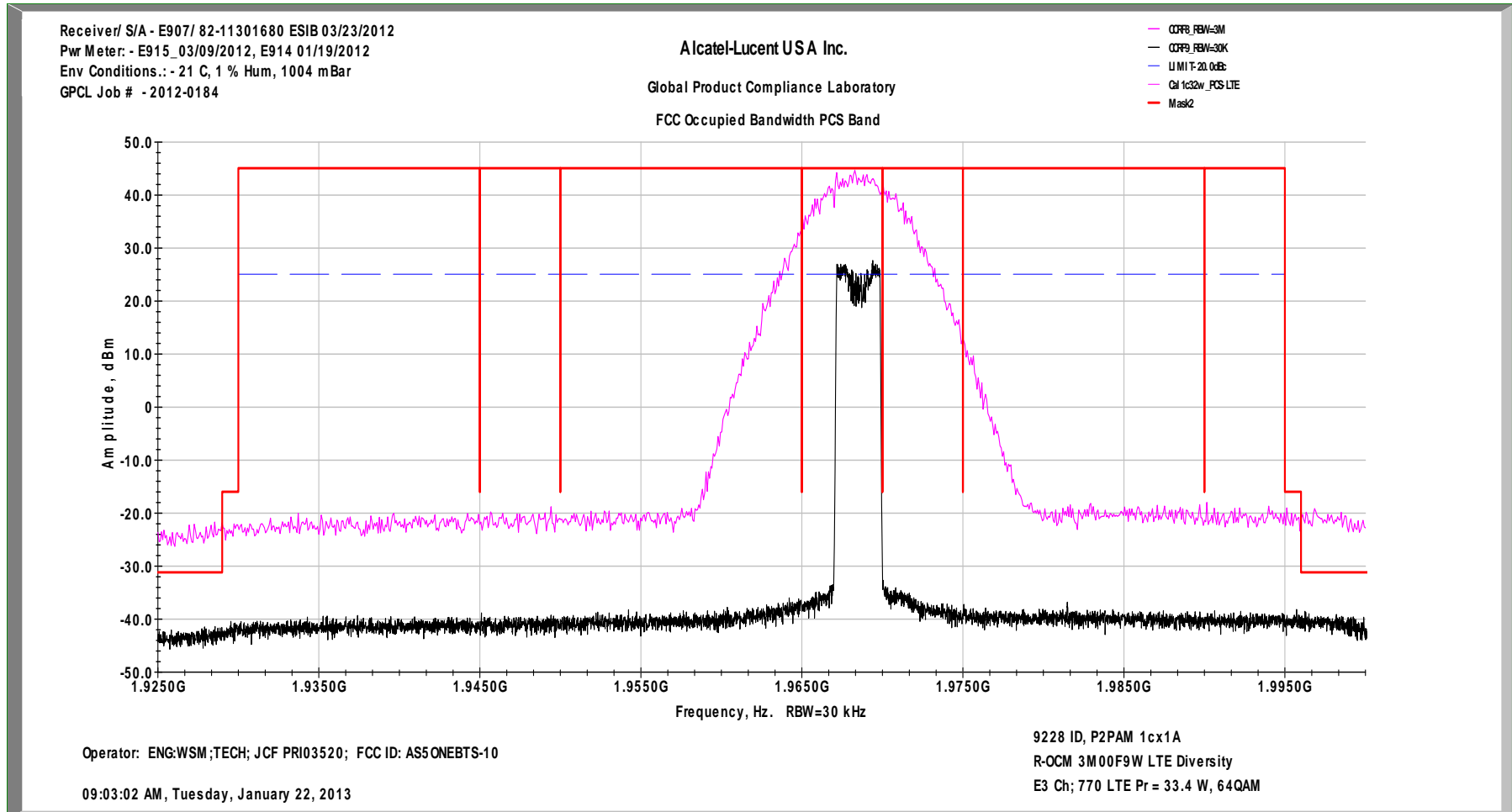

FCC Edge of Block Margin LTE3 MHz Ch E-770 1cx1A 32W/c 64QAM Diversity Tx2

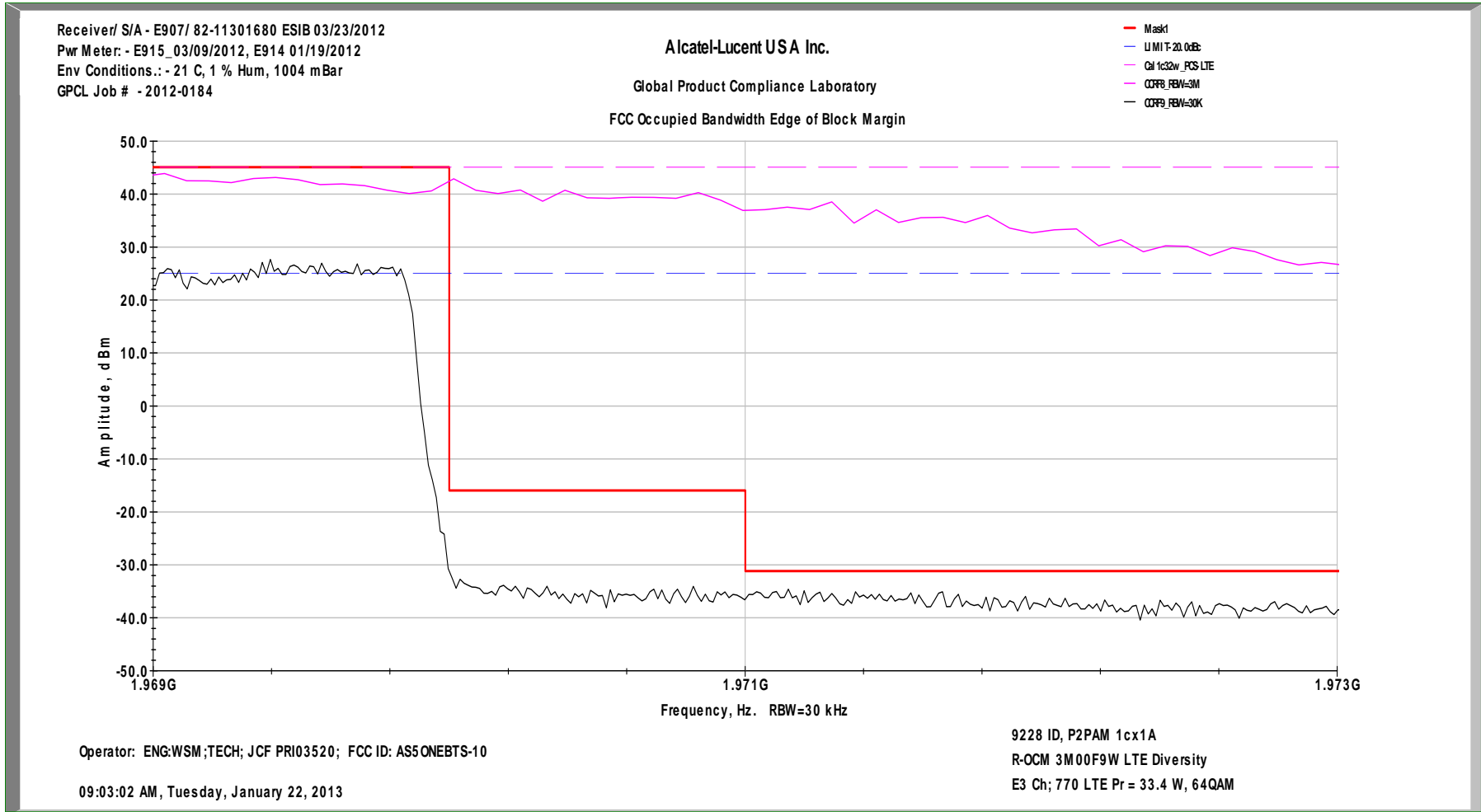

FCC Occupied Bandwidth w/ 3 Modulations LTE3 MHz Ch E-770 1cx1A 32W/c QPSK, 16QAM & 64QAM Diversity Tx2

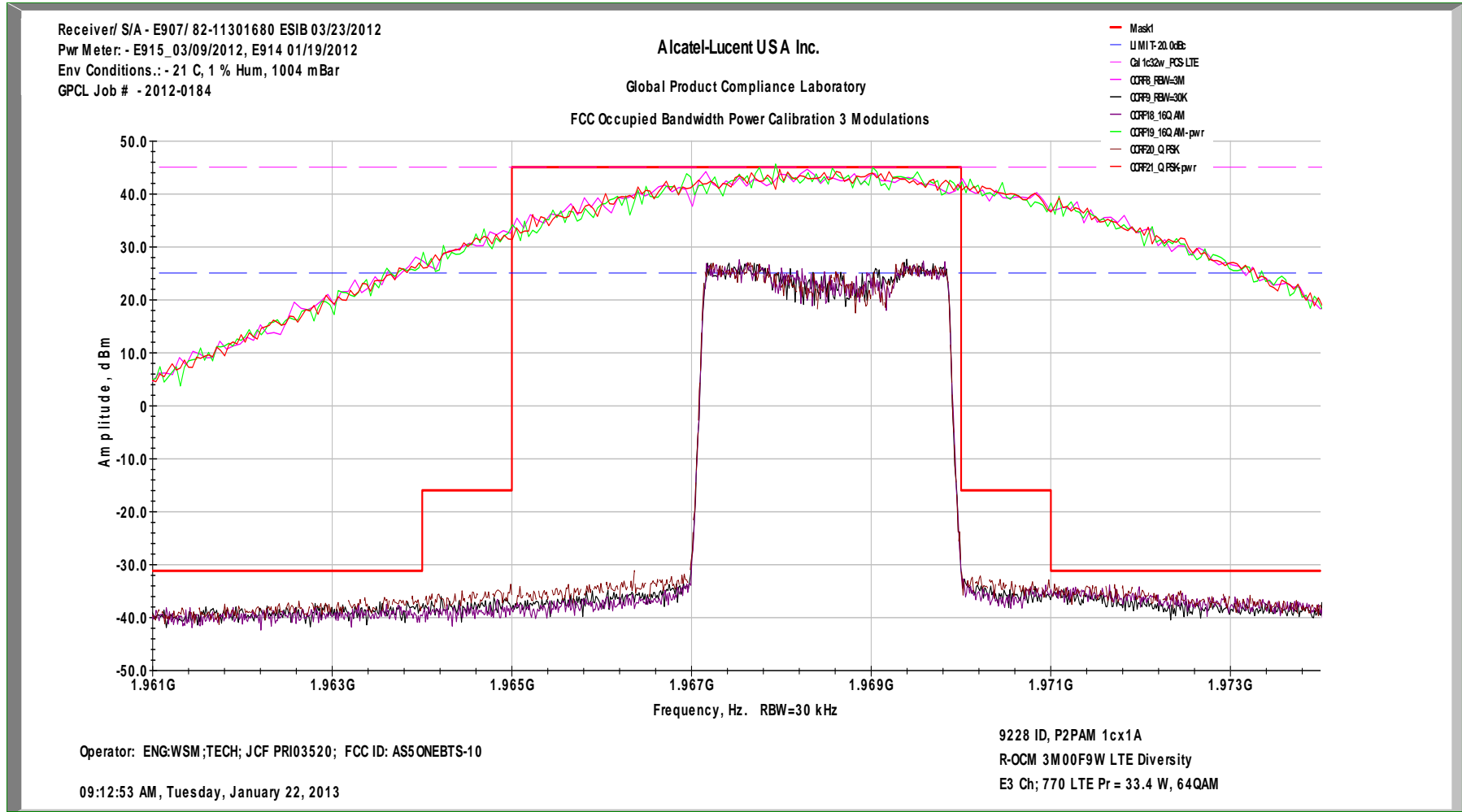

FCC Occupied Bandwidth Emissions LTE3 MHz Ch F-830 1cx2A 32W/c 64QAM Primary Tx1

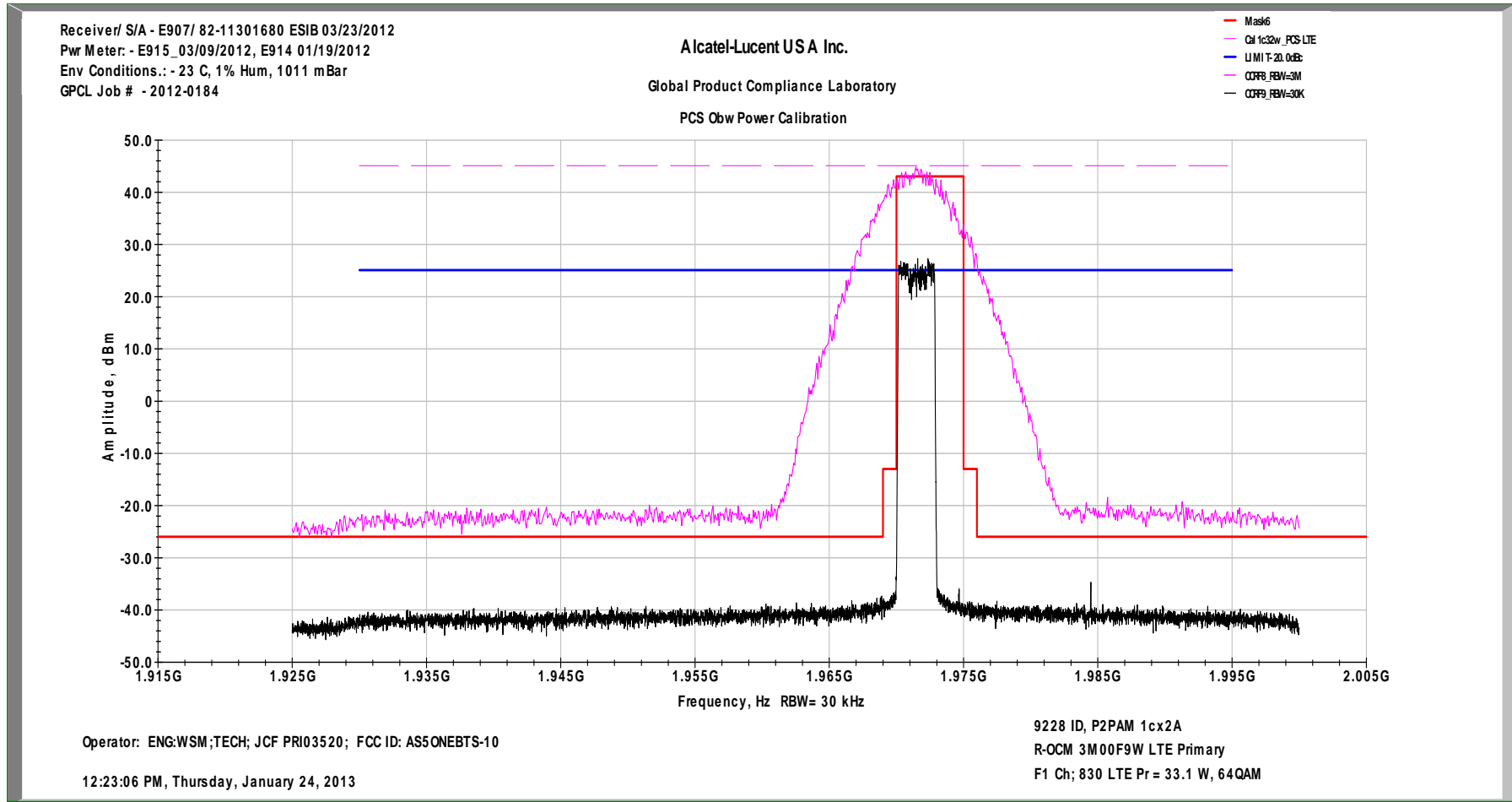

In-Band Intermodulation Graph LTE3 MHz Ch F-830 1cx2A 32W/c 64QAM Primary Tx1

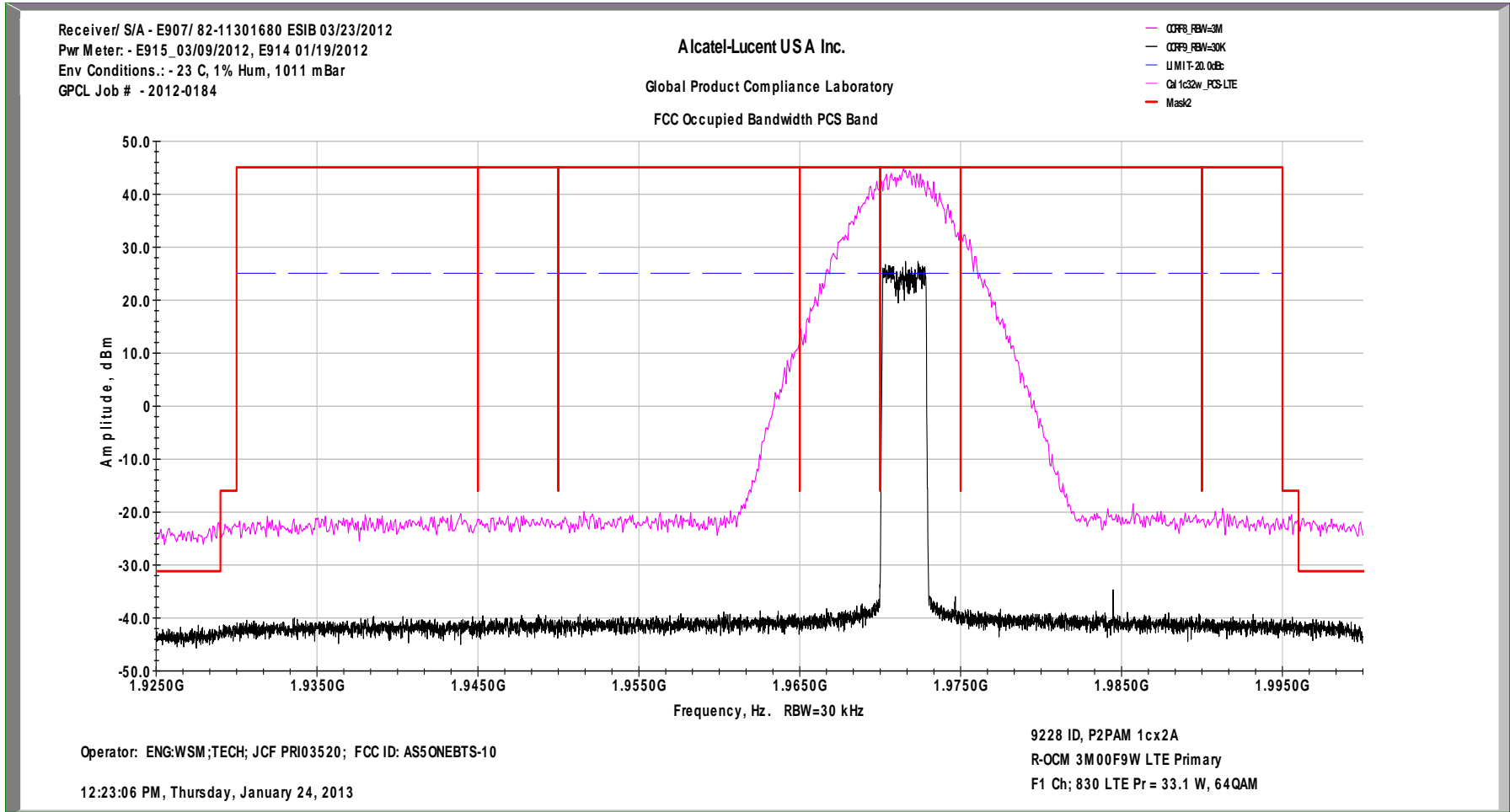

FCC Edge of Block Margin LTE3 MHz Ch F-830 1cx2A 32W/c 64QAM Primary Tx1

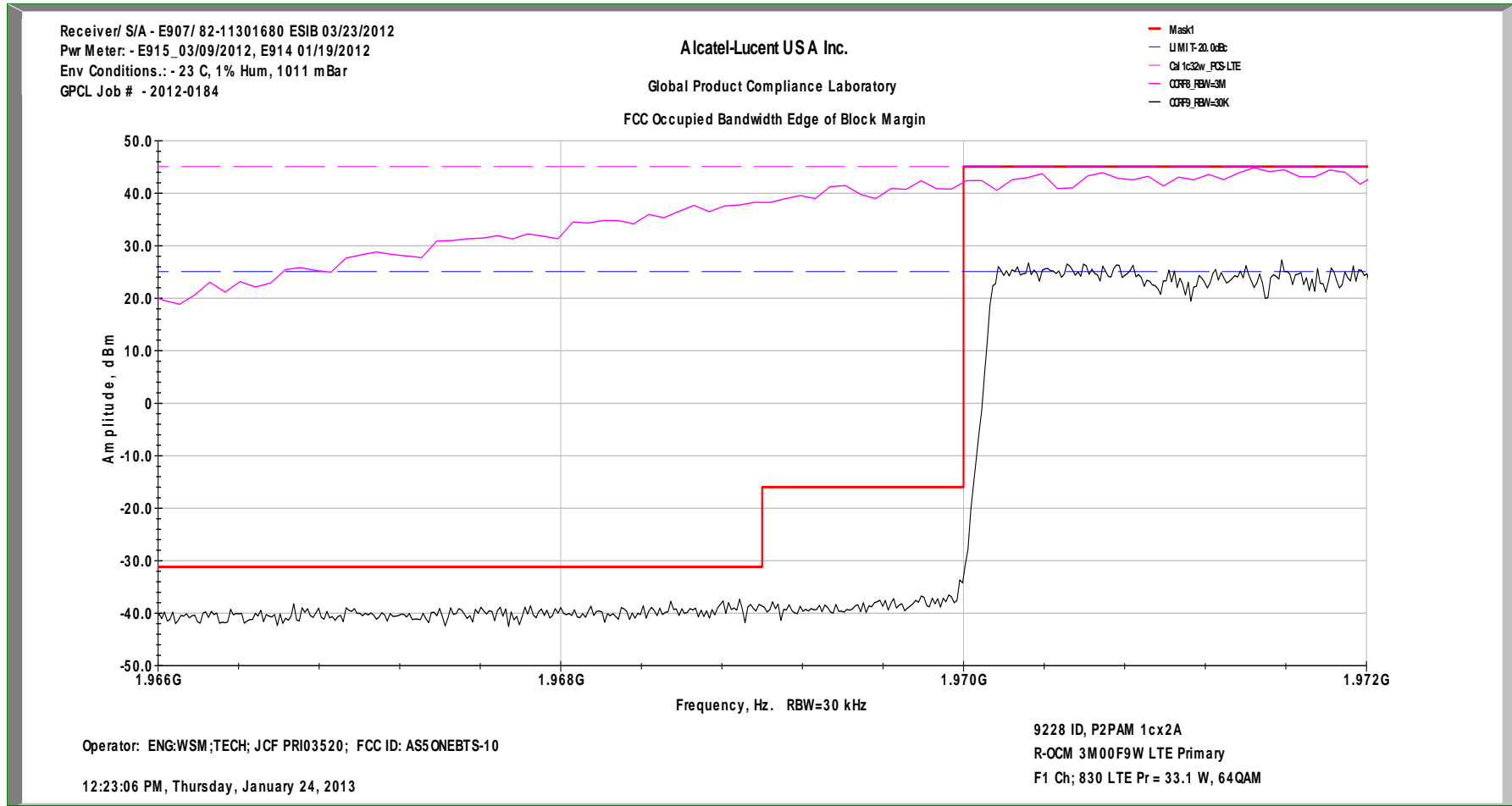

FCC Occupied Bandwidth w/ 3 Modulations LTE3 MHz Ch F-830 1cx2A 32W/c QPSK, 16QAM & 64QAM Primary Tx1

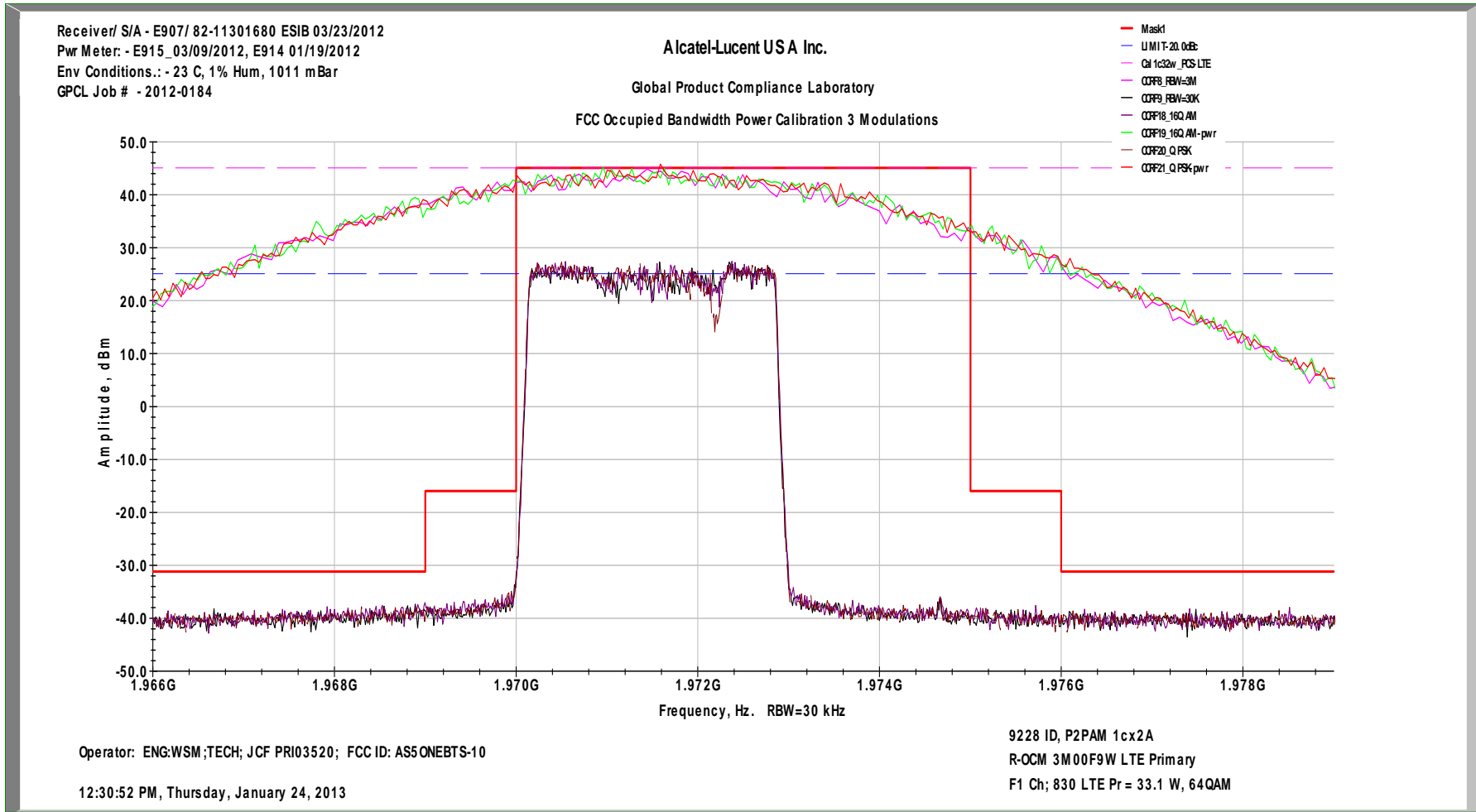

FCC Occupied Bandwidth Emissions LTE3 MHz Ch F-830 1cx1A 32W/c 64QAM Diversity Tx2

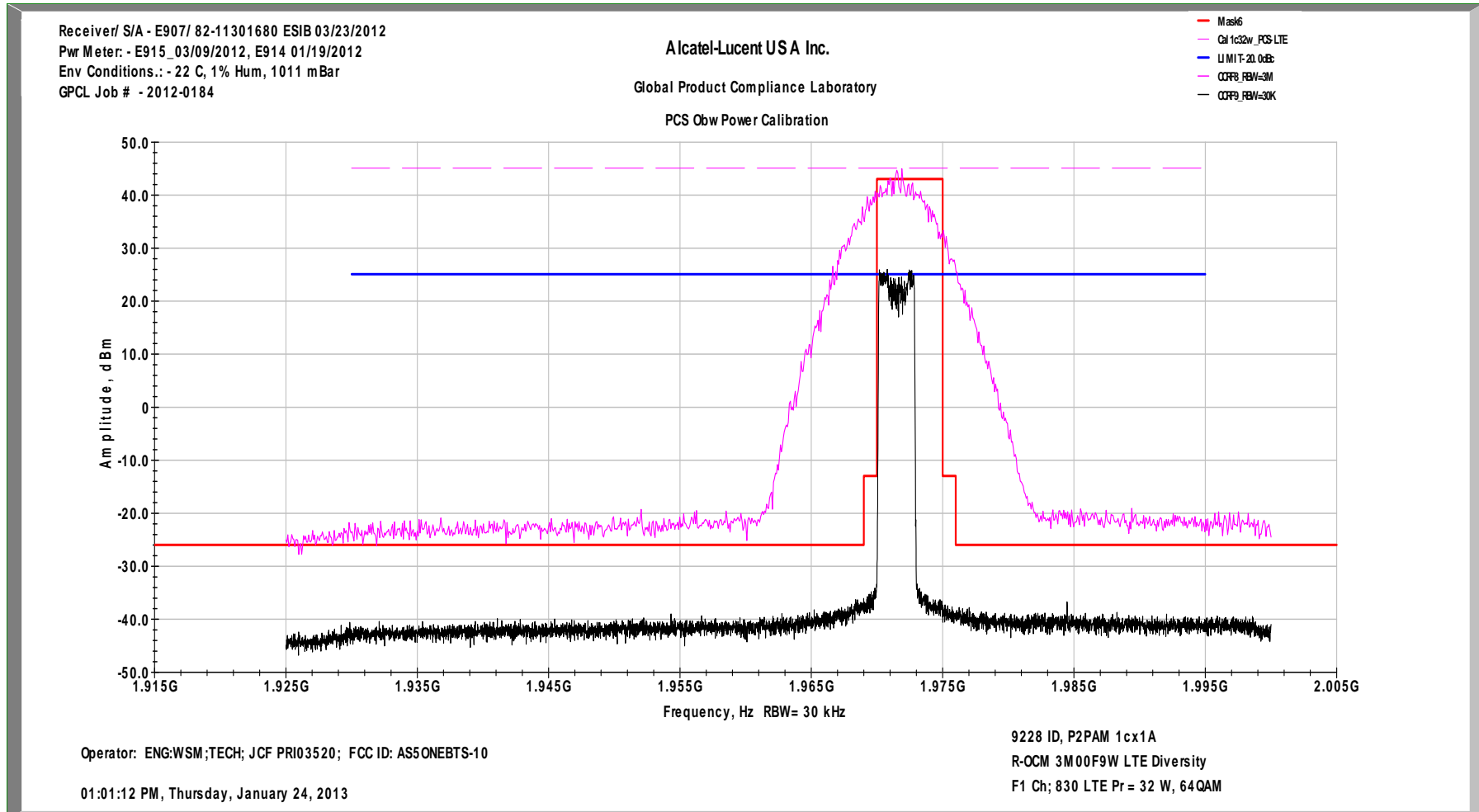

In-Band Intermodulation Graph LTE3 MHz Ch F-830 1cx1A 32W/c 64QAM Diversity Tx2

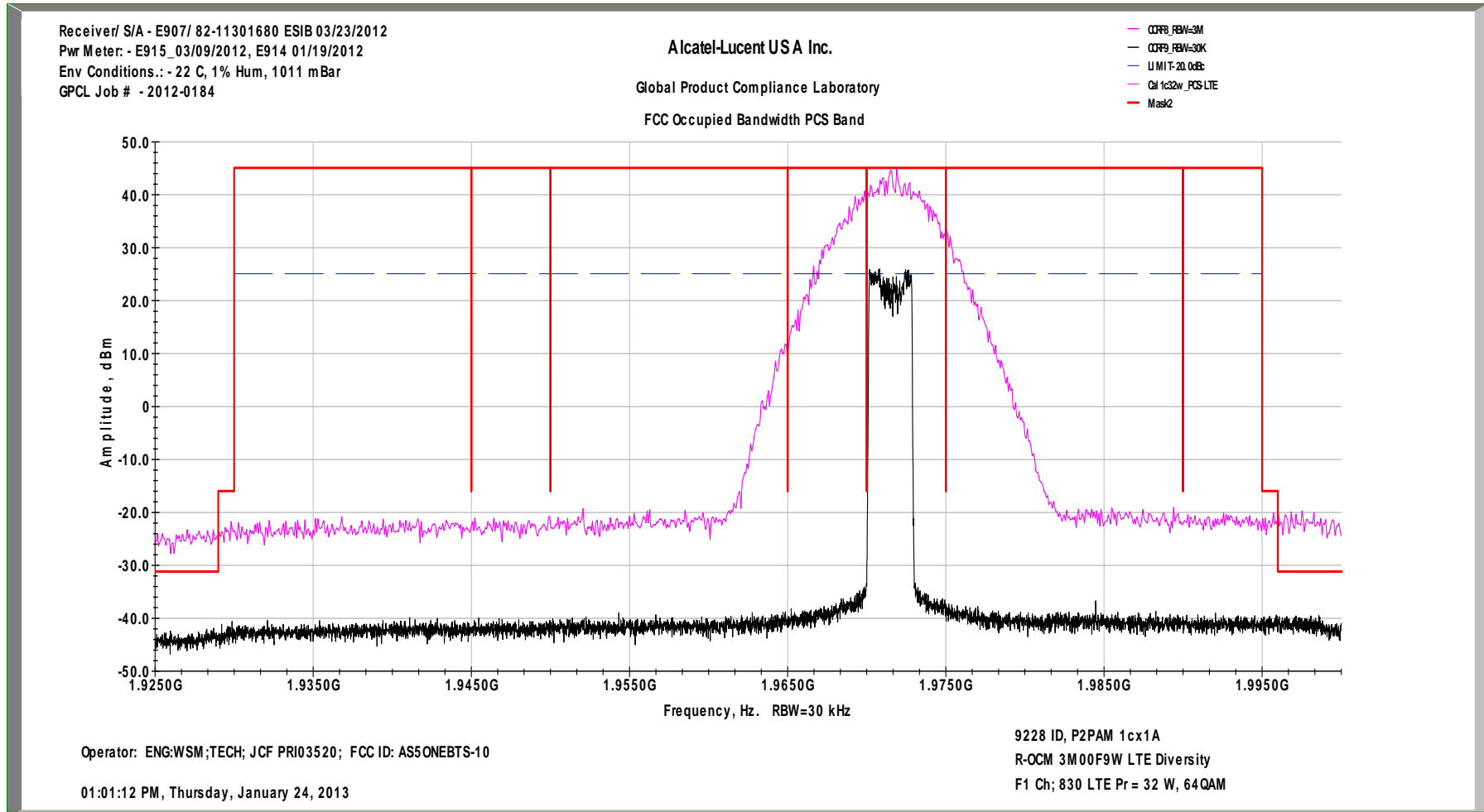

FCC Edge of Block Margin LTE3 MHz Ch F-830 1cx1A 32W/c 64QAM Diversity Tx2

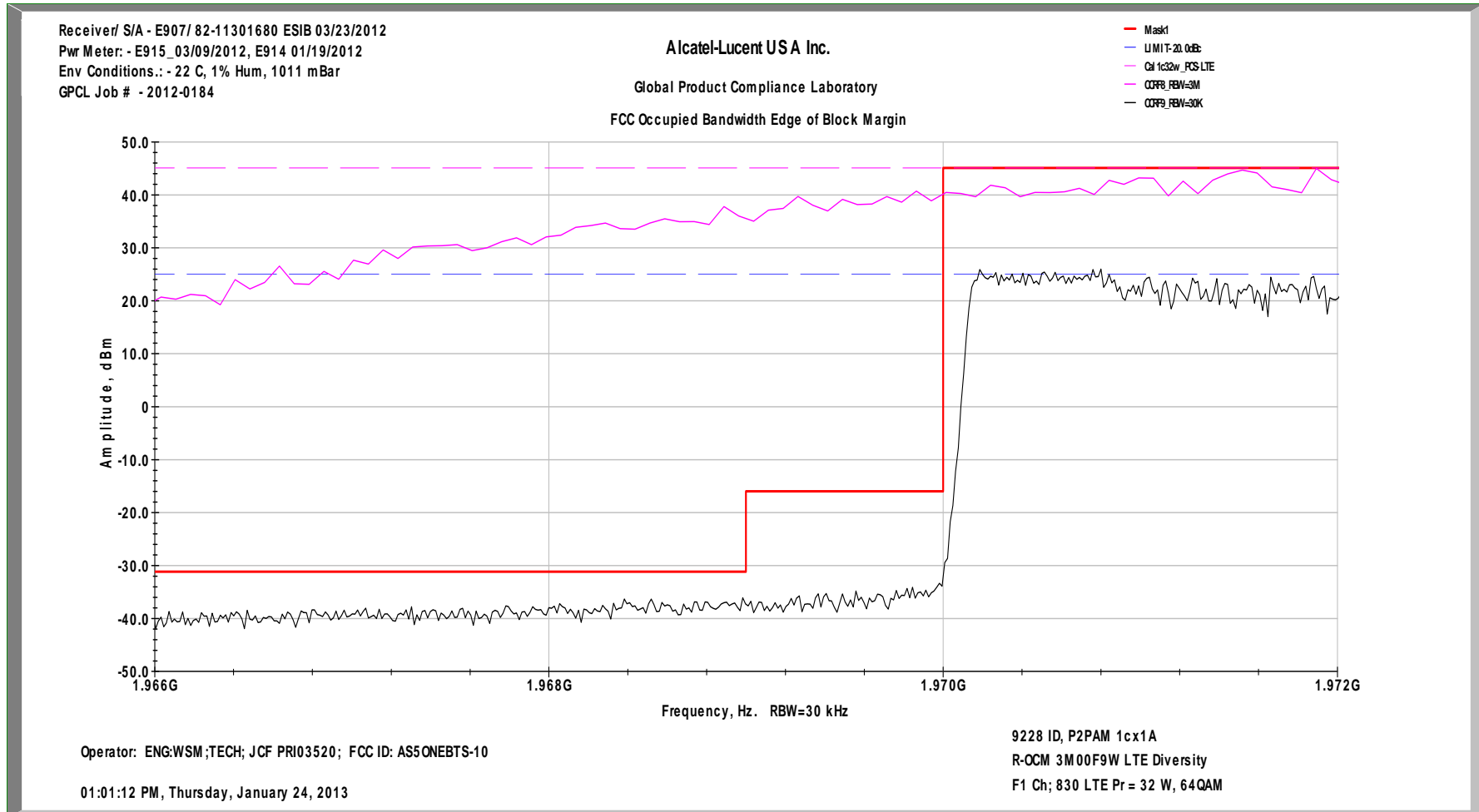

FCC Occupied Bandwidth w/ 3 Modulations LTE3 MHz Ch F-830 1cx1A 32W/c QPSK, 16QAM & 64QAM Diversity Tx2

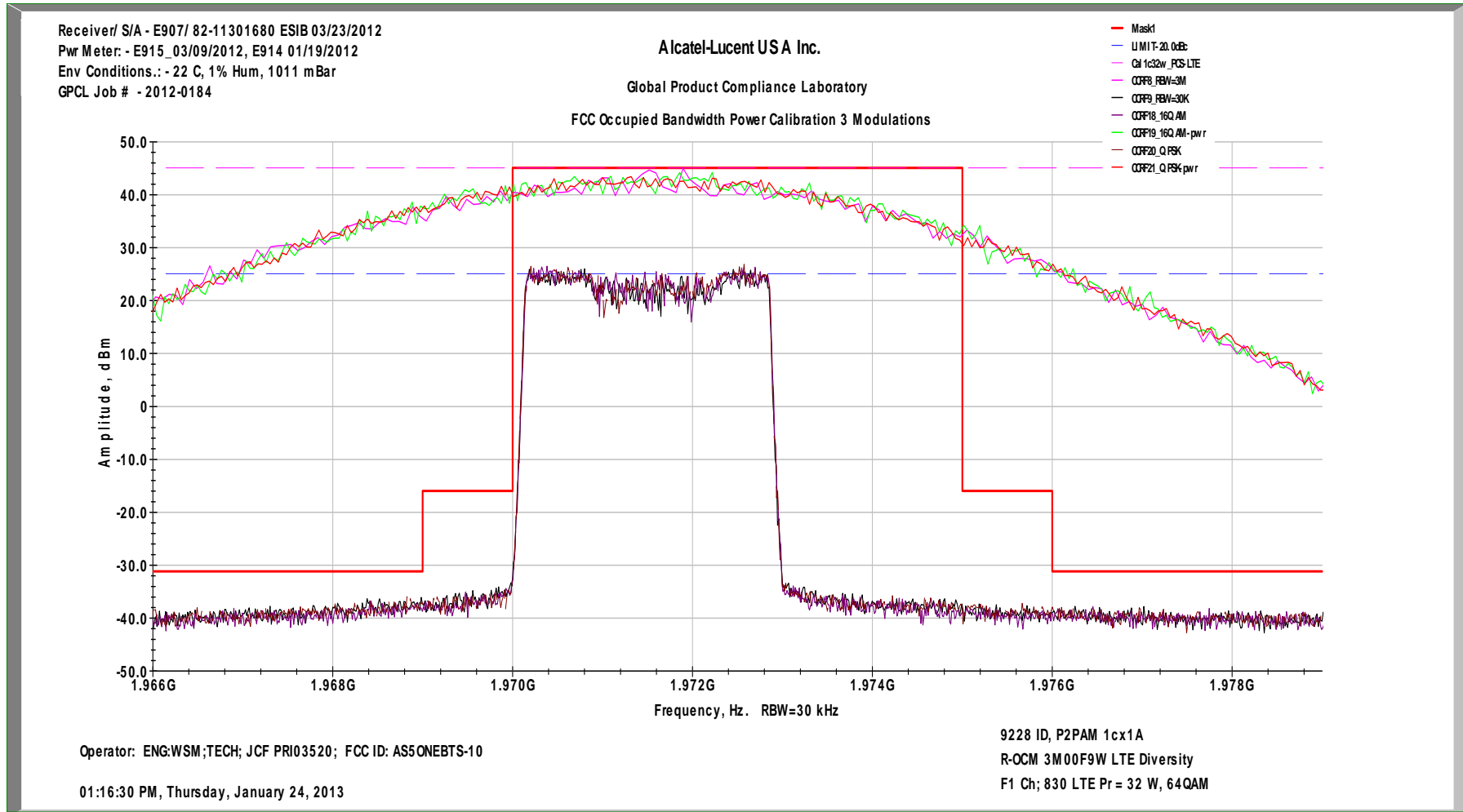

FCC Occupied Bandwidth Emissions LTE3 MHz Ch F-870 1cx2A 32W/c 64QAM Primary Tx1

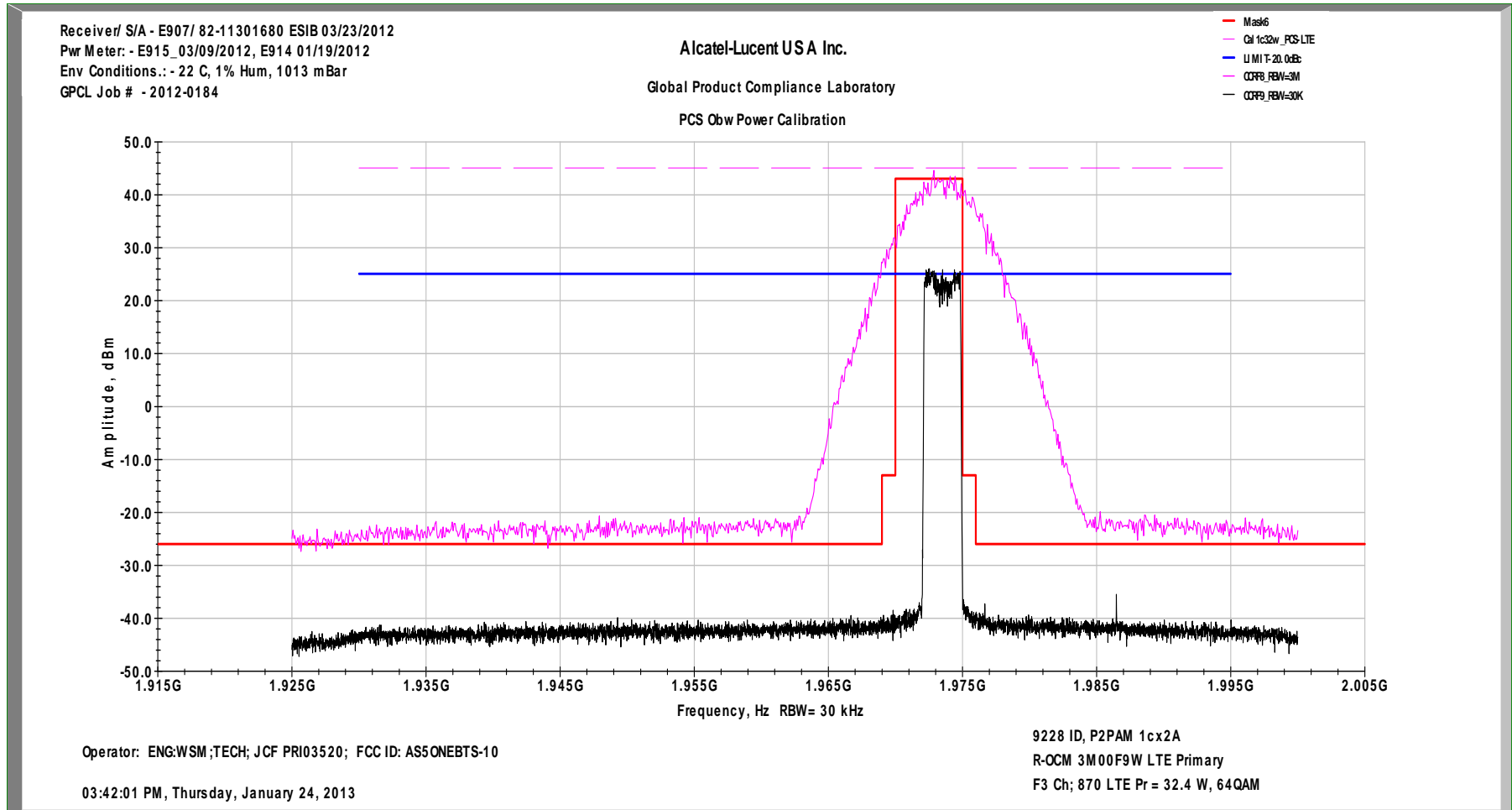

In-Band Intermodulation Graph LTE3 MHz Ch F-870 1cx2A 32W/c 64QAM Primary Tx1

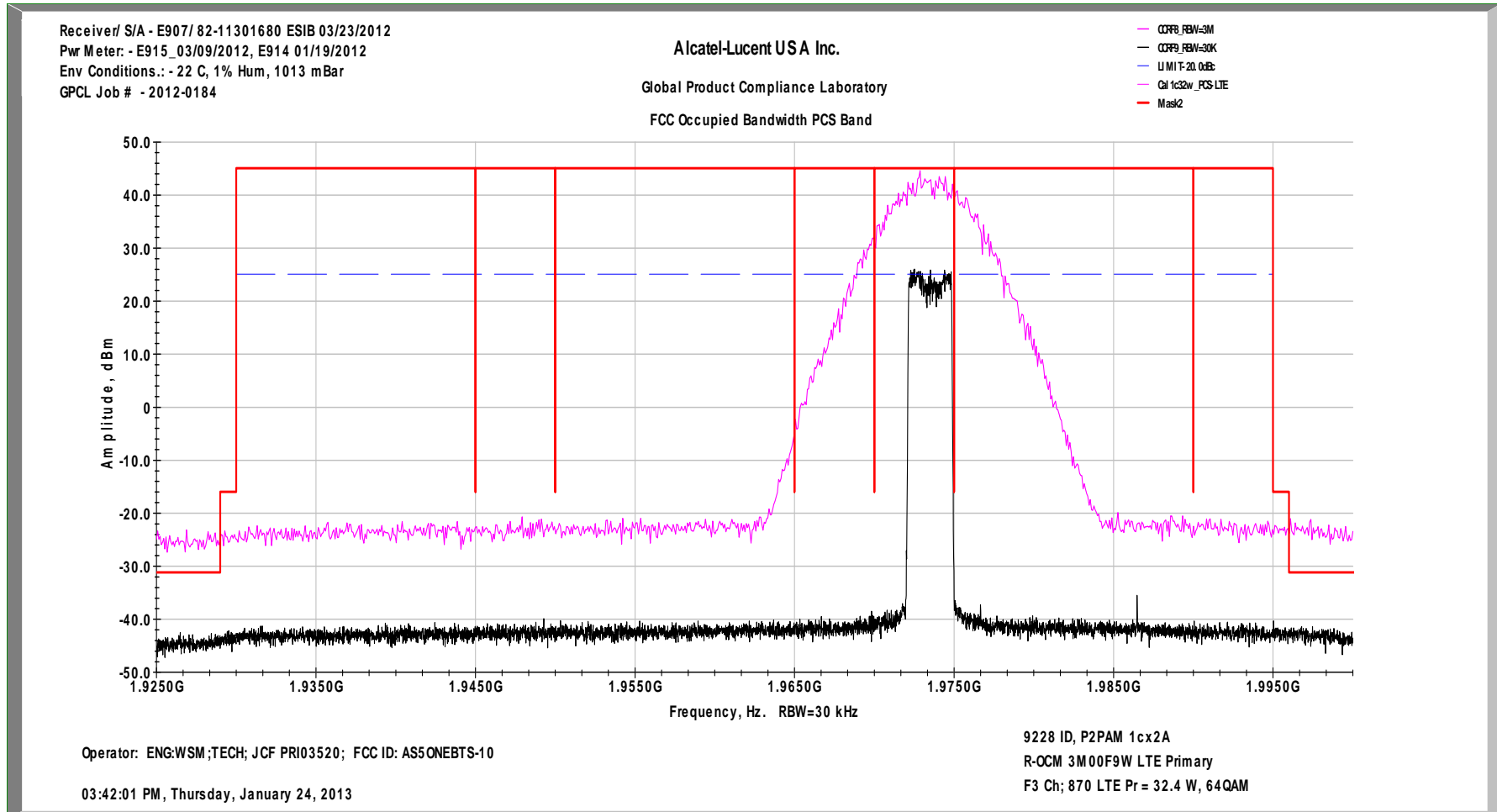

FCC Edge of Block Margin LTE3 MHz Ch F-870 1cx2A 32W/c 64QAM Primary Tx1

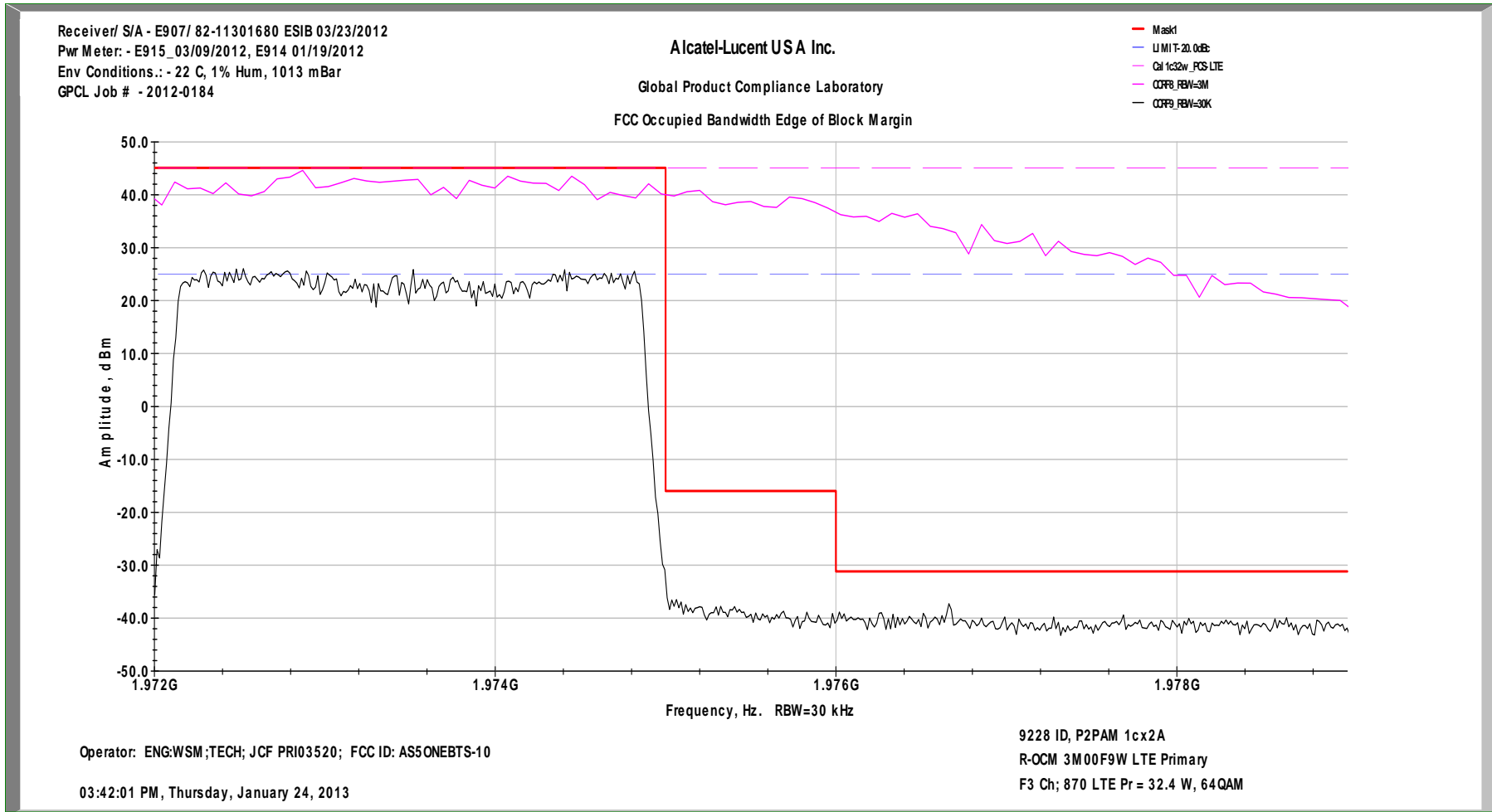

FCC Occupied Bandwidth w/ 3 Modulations LTE3 MHz Ch F-870 1cx2A 32W/c QPSK, 16QAM & 64QAM Primary Tx1

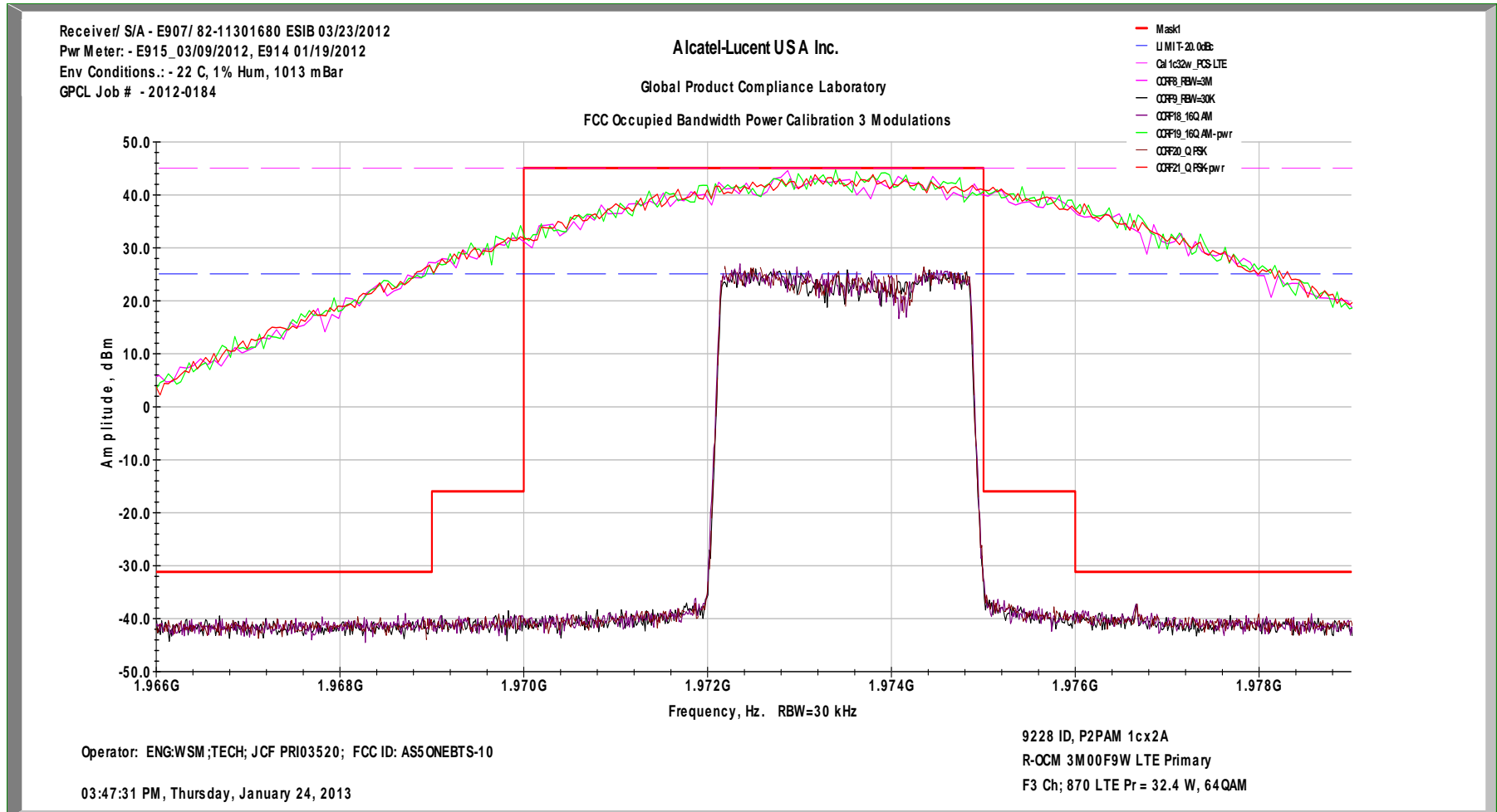

FCC Occupied Bandwidth Emissions LTE3 MHz Ch F-870 1cx1A 32W/c 64QAM Diversity Tx2

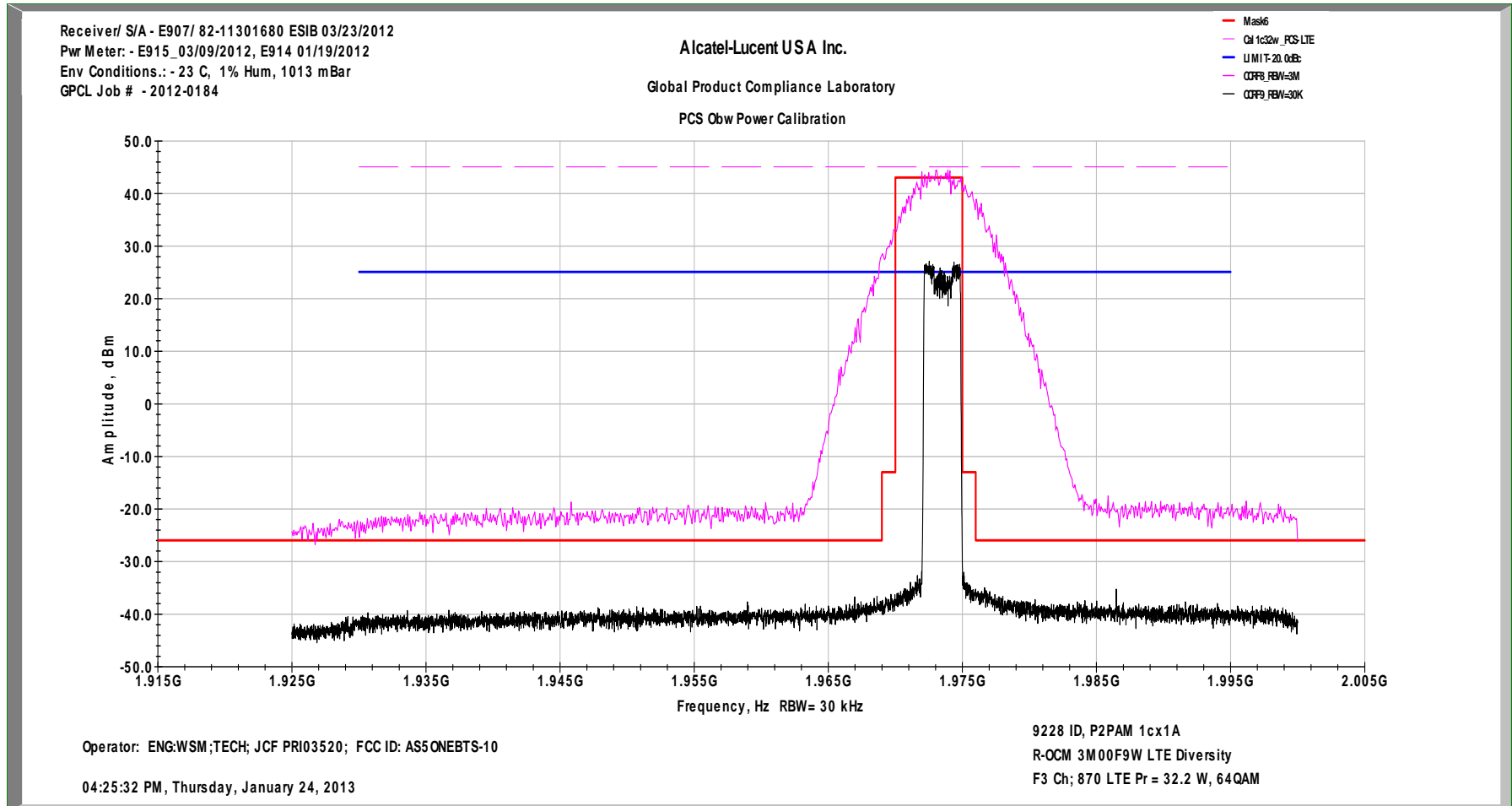

In-Band Intermodulation Graph LTE3 MHz Ch F-870 1cx1A 32W/c 64QAM Diversity Tx2

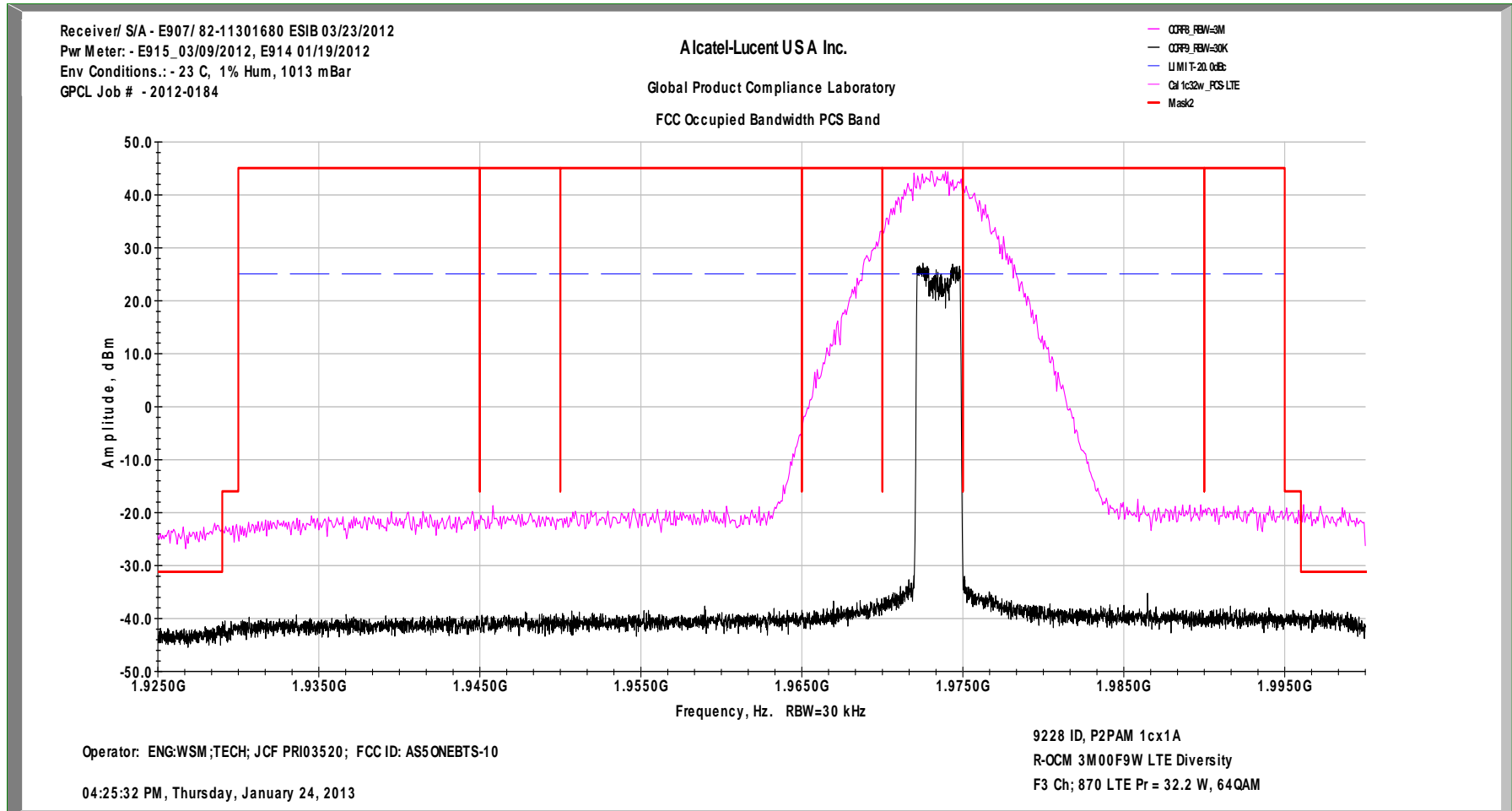

FCC Edge of Block Margin LTE3 MHz Ch F-870 1cx1A 32W/c 64QAM Diversity Tx2

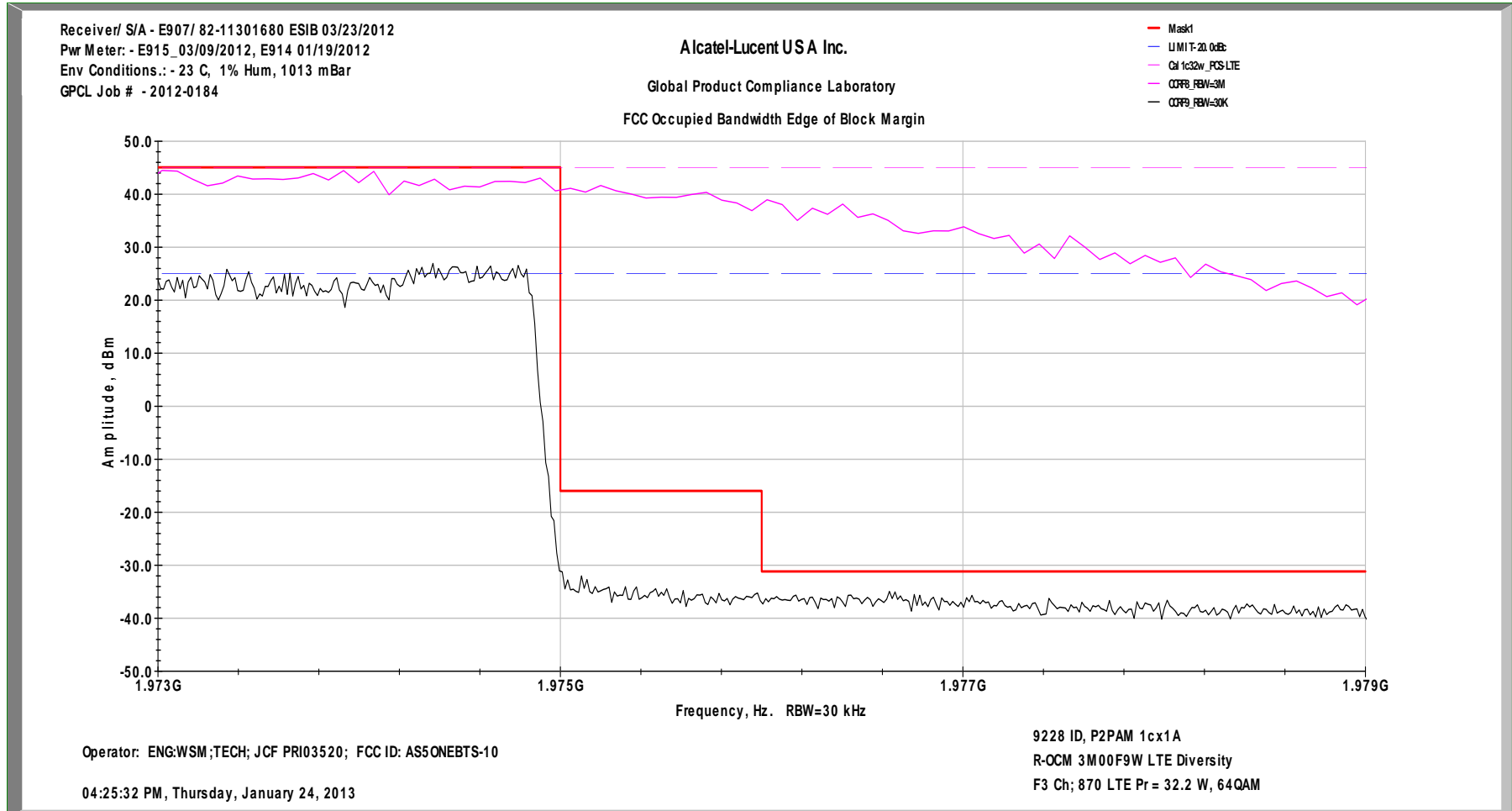

FCC Occupied Bandwidth w/ 3 Modulations LTE3 MHz Ch F-870 1cx1A 32W/c QPSK, 16QAM & 64QAM Diversity Tx2

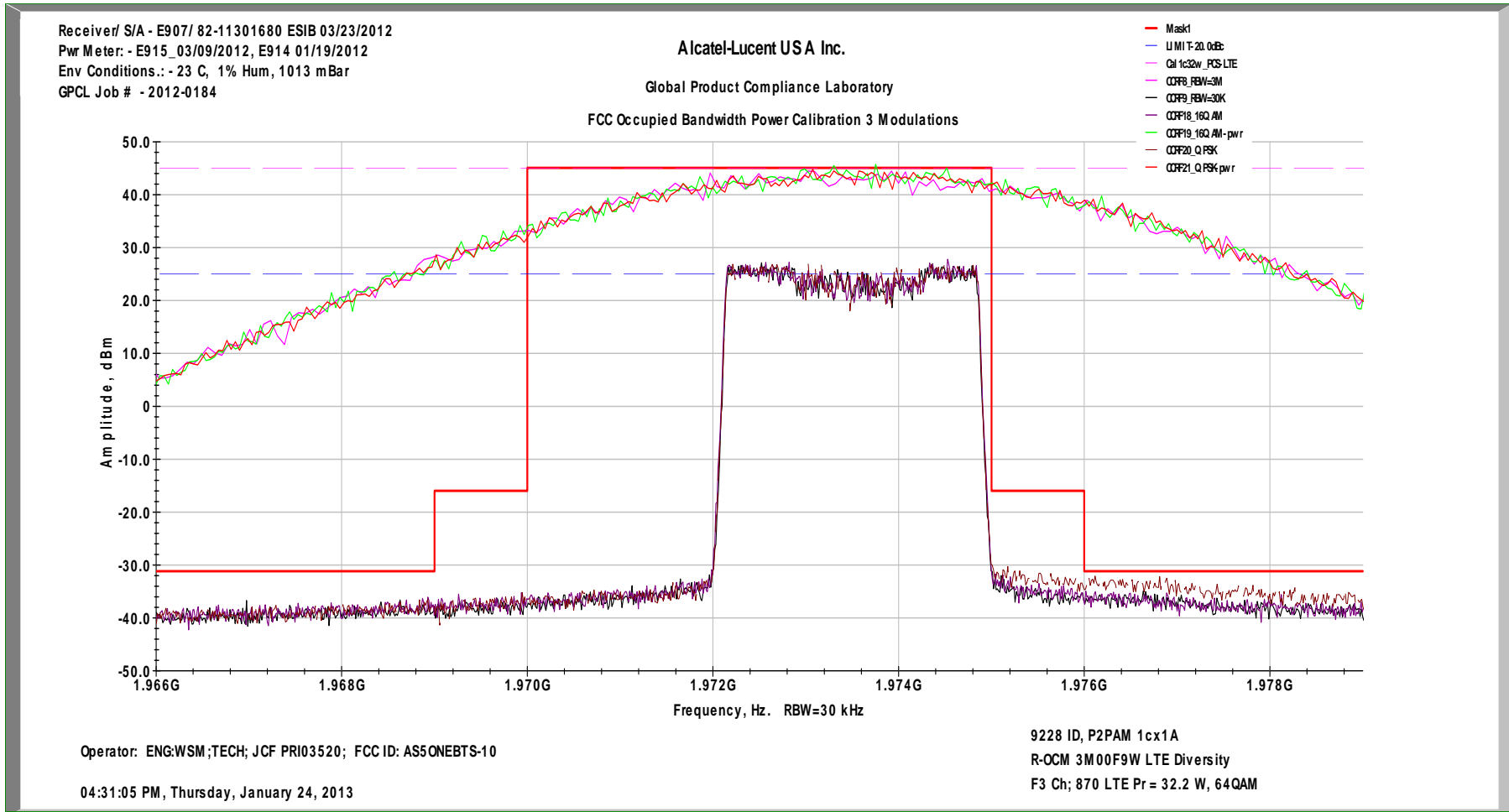

FCC Occupied Bandwidth Emissions LTE3 MHz Ch C-930 1cx2A 32W/c 64QAM PrimaryTx1

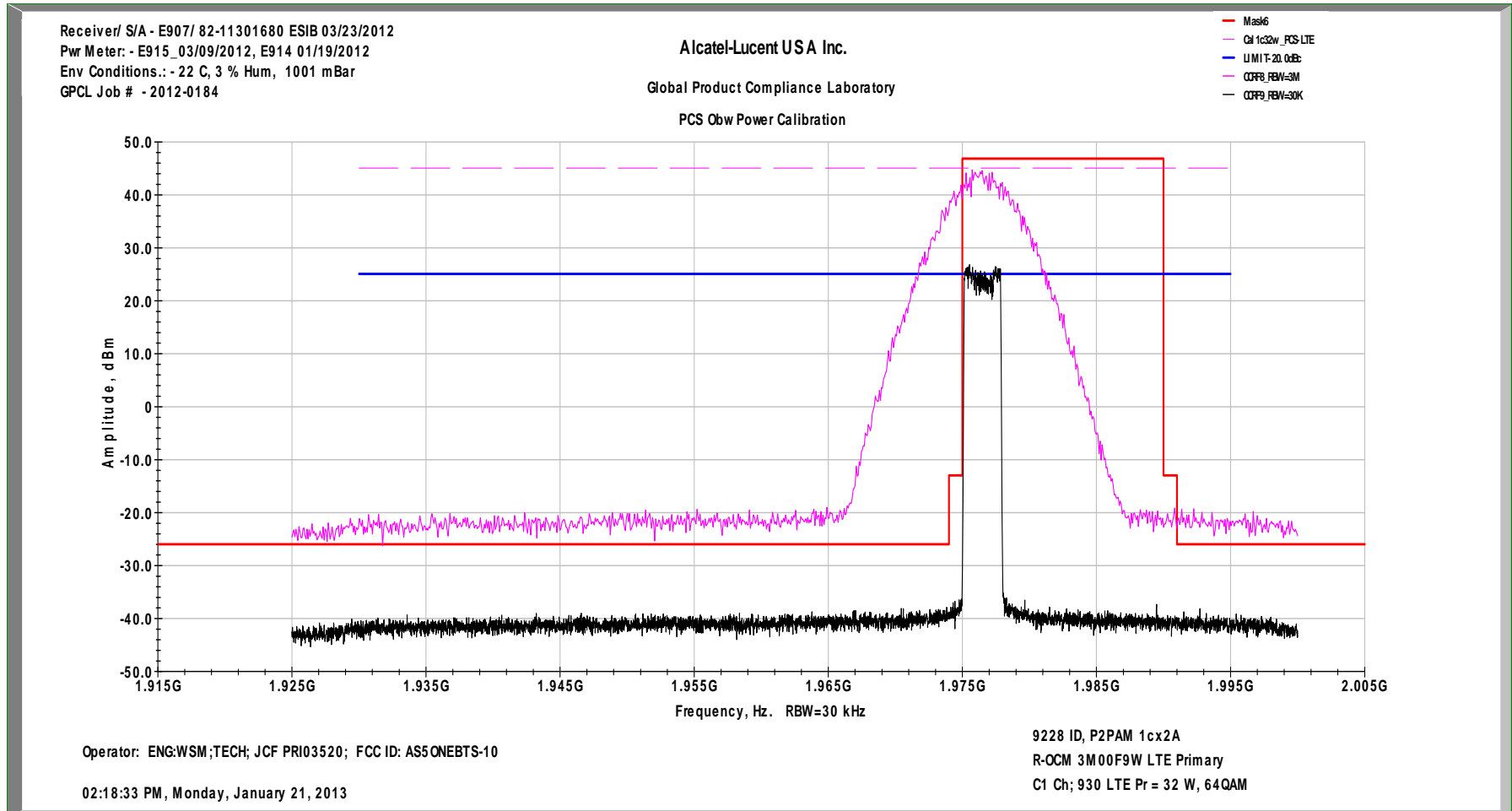

In-Band Intermodulation Graph LTE3 MHz Ch C-930 1cx2A 32W/c 64QAM PrimaryTx1

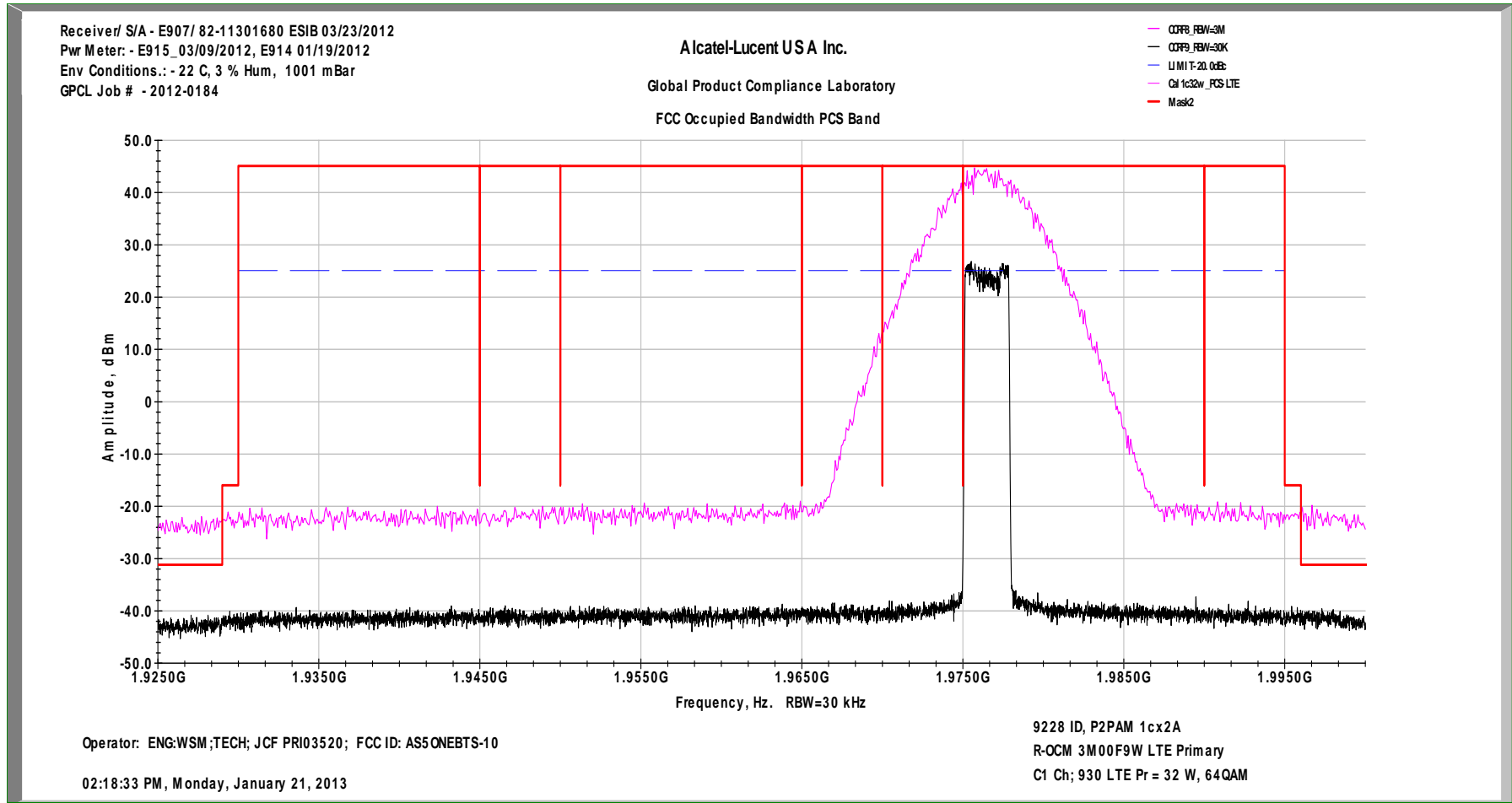

FCC Edge of Block Margin LTE3 MHz Ch C-930 1cx2A 32W/c 64QAM PrimaryTx1

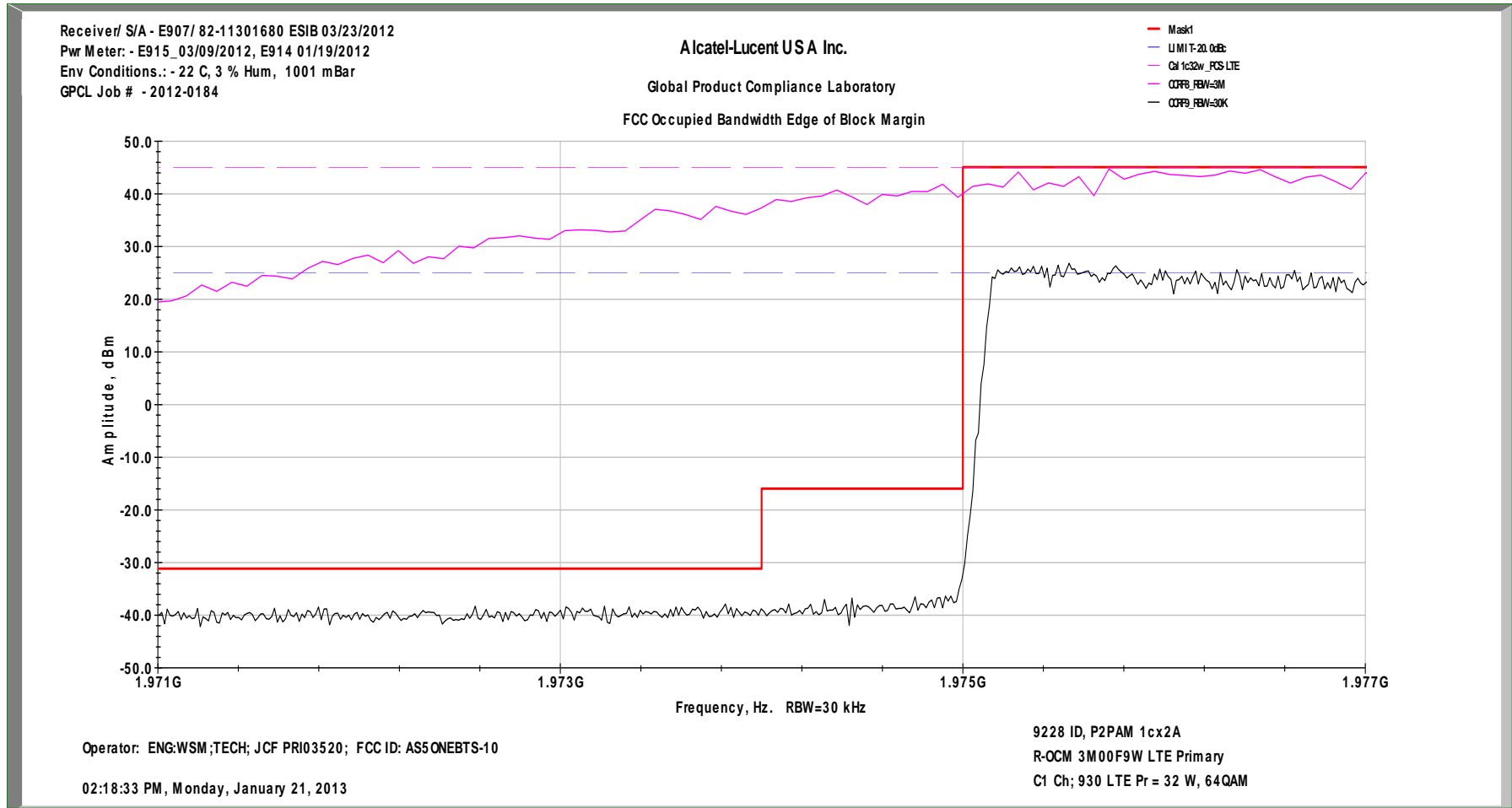

FCC Occupied Bandwidth w/ 3 Modulations LTE3 MHz Ch C-930 1cx2A 32W/c QPSK, 16QAM & 64QAM PrimaryTx1

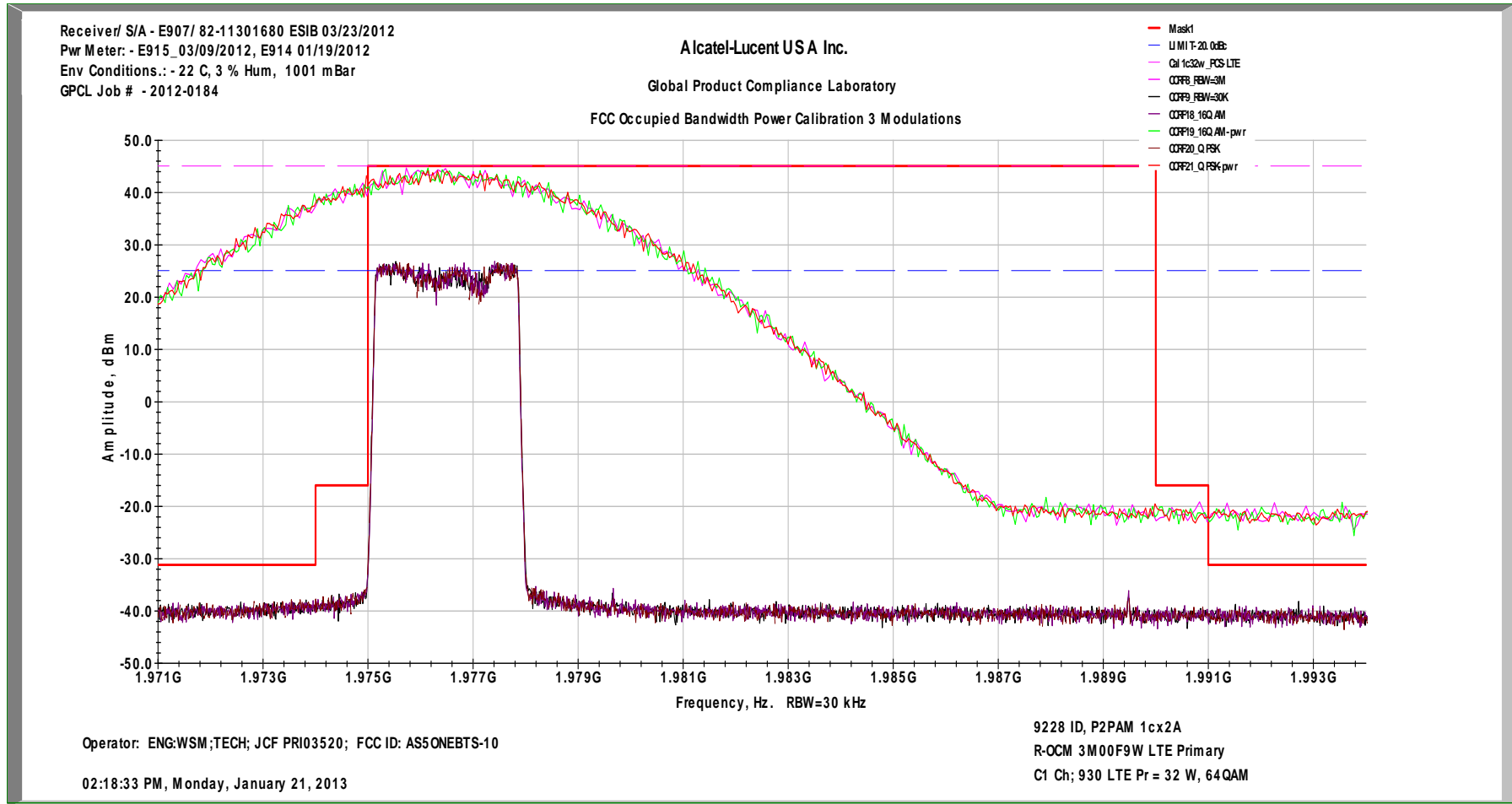

FCC Occupied Bandwidth Emissions LTE3 MHz Ch C-930 1cx1A 32W/c 64QAM Diversity Tx2

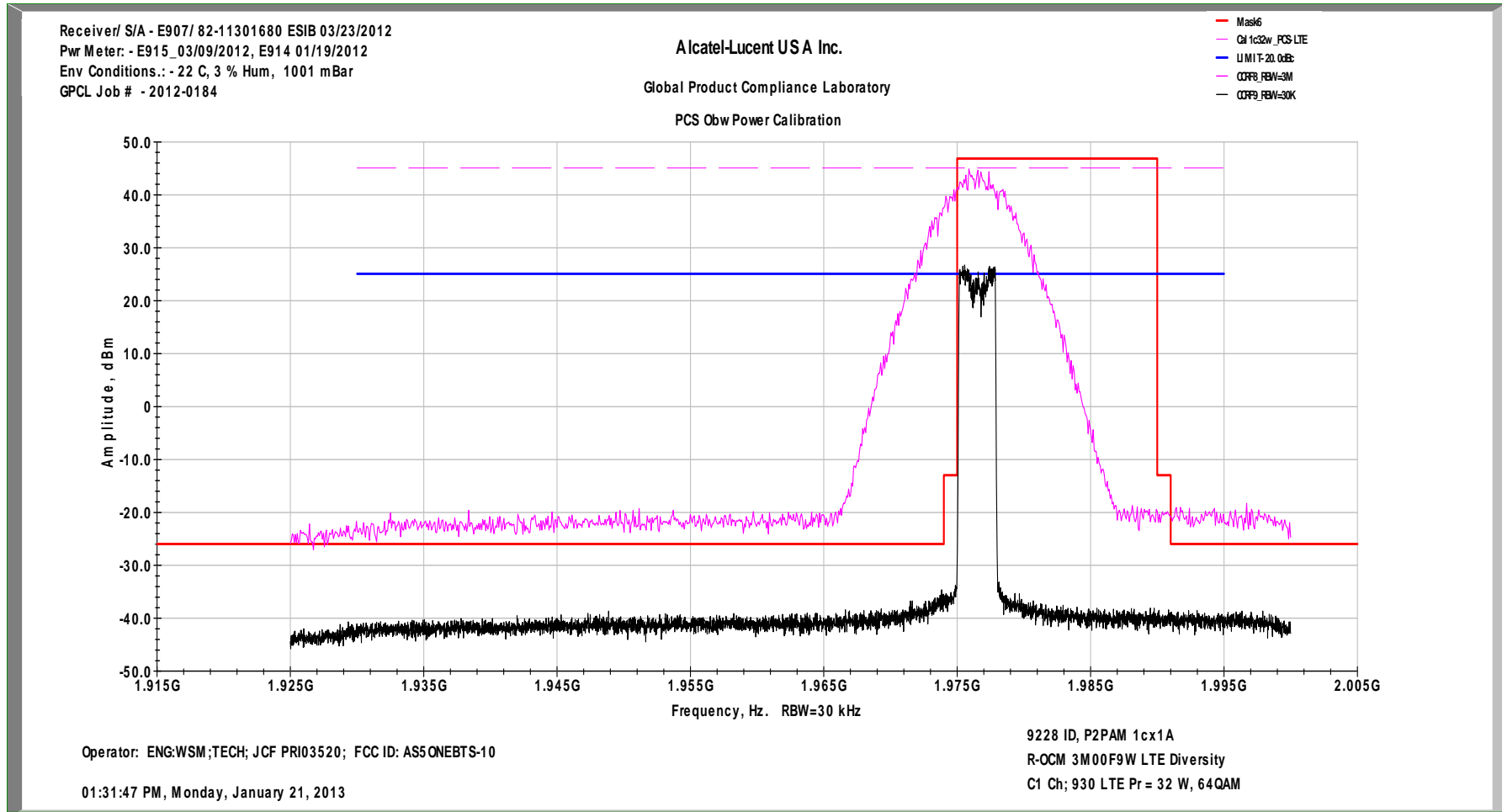

In-Band Intermodulation Graph LTE3 MHz Ch C-930 1cx1A 32W/c 64QAM Diversity Tx2

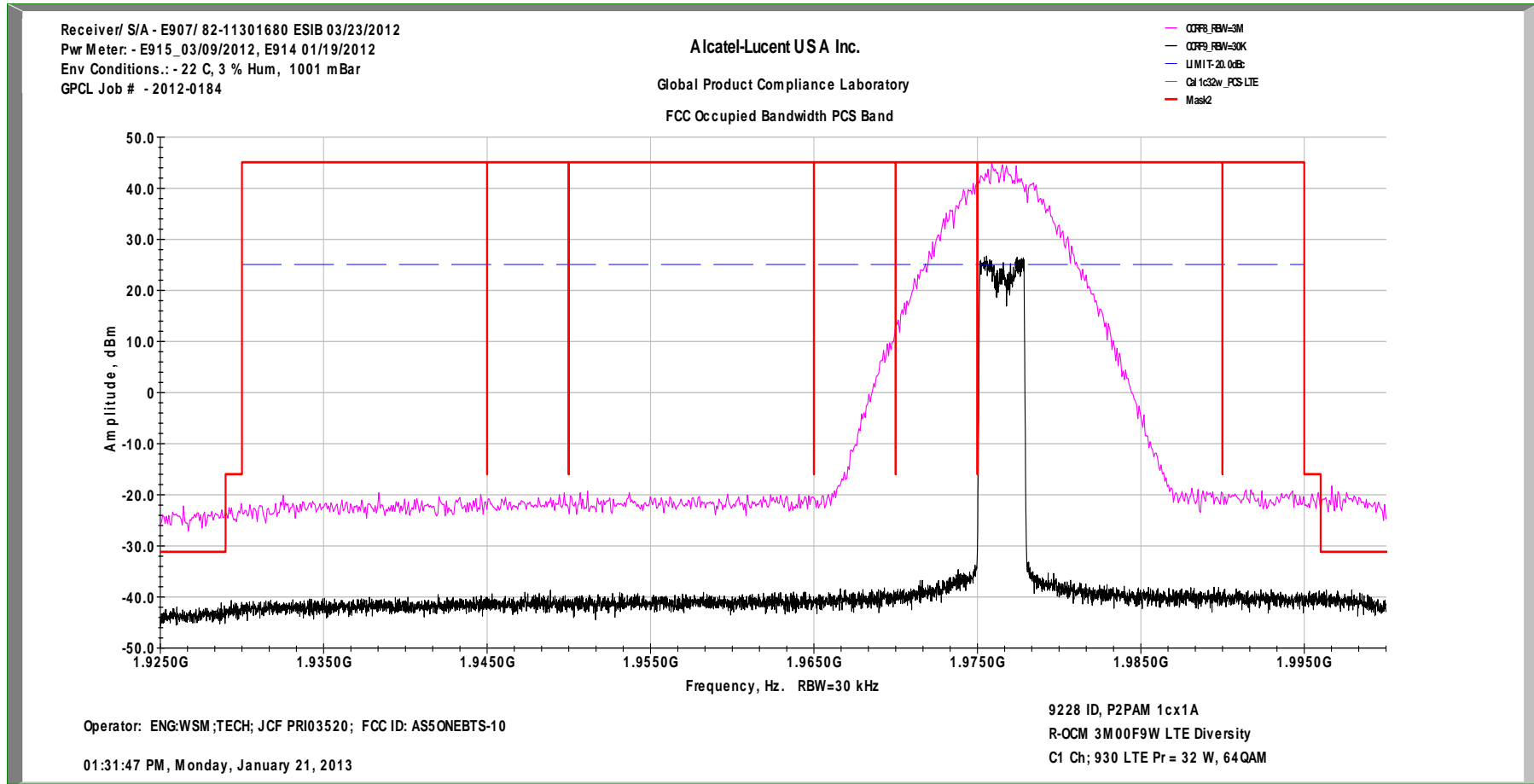

FCC Edge of Block Margin LTE3 MHz Ch C-930 1cx1A 32W/c 64QAM Diversity Tx2

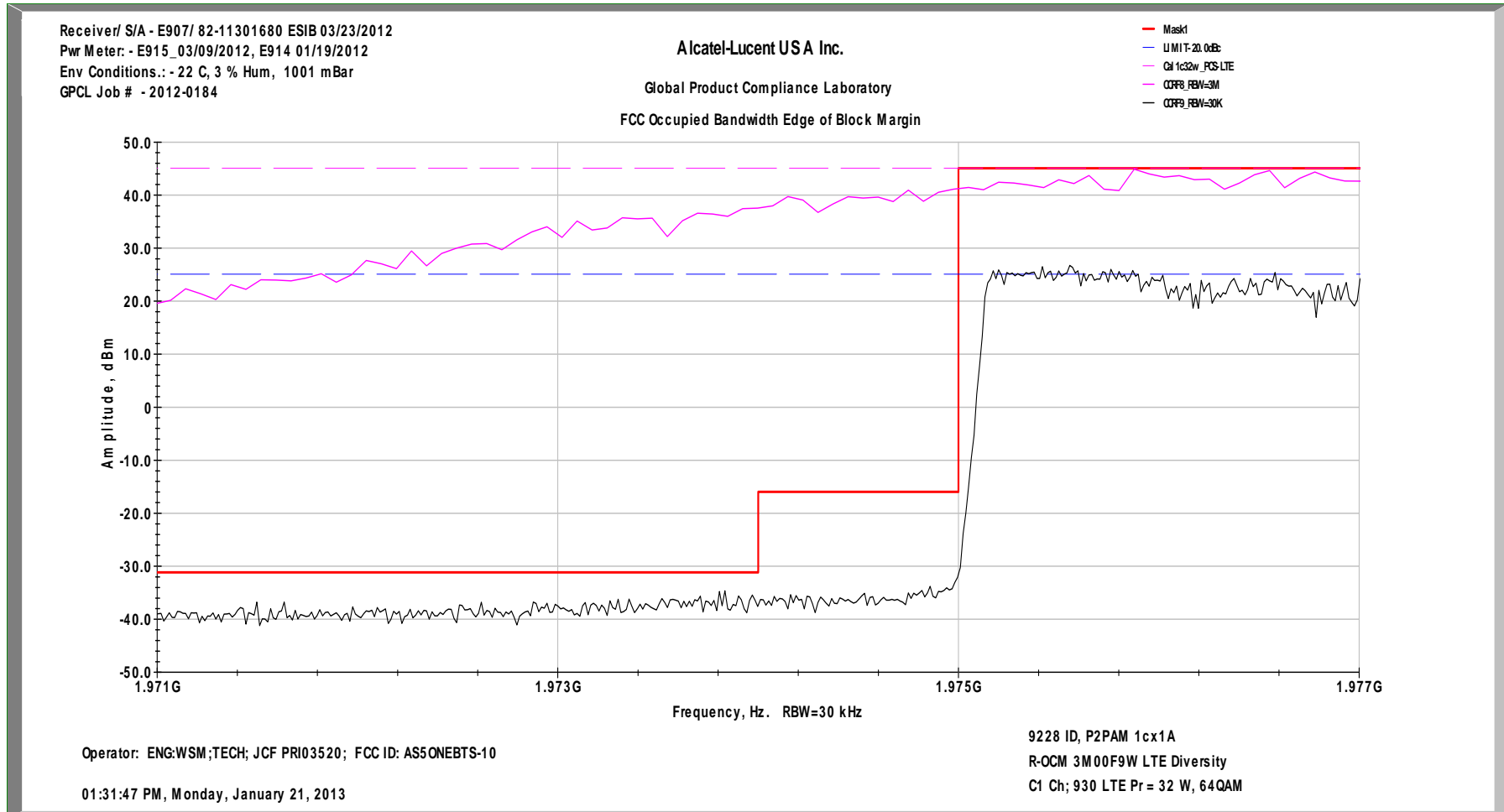

FCC Occupied Bandwidth w/ 3 Modulations LTE3 MHz Ch C-930 1cx1A 32W/c QPSK, 16QAM & 64QAM

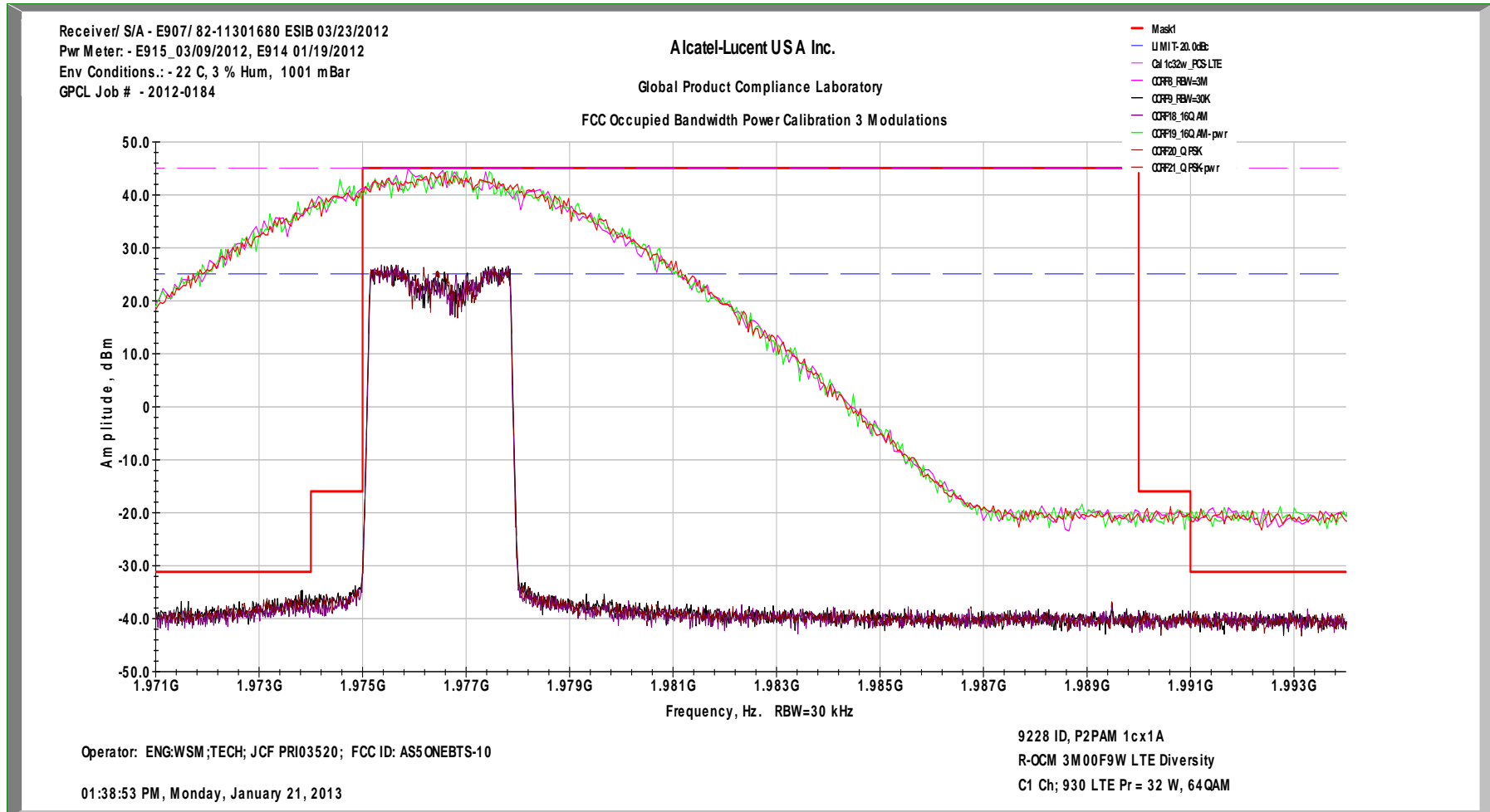

FCC Occupied Bandwidth Emissions LTE3 MHz Ch C-1170 1cx2A 32W/c 64QAM Primary Tx1

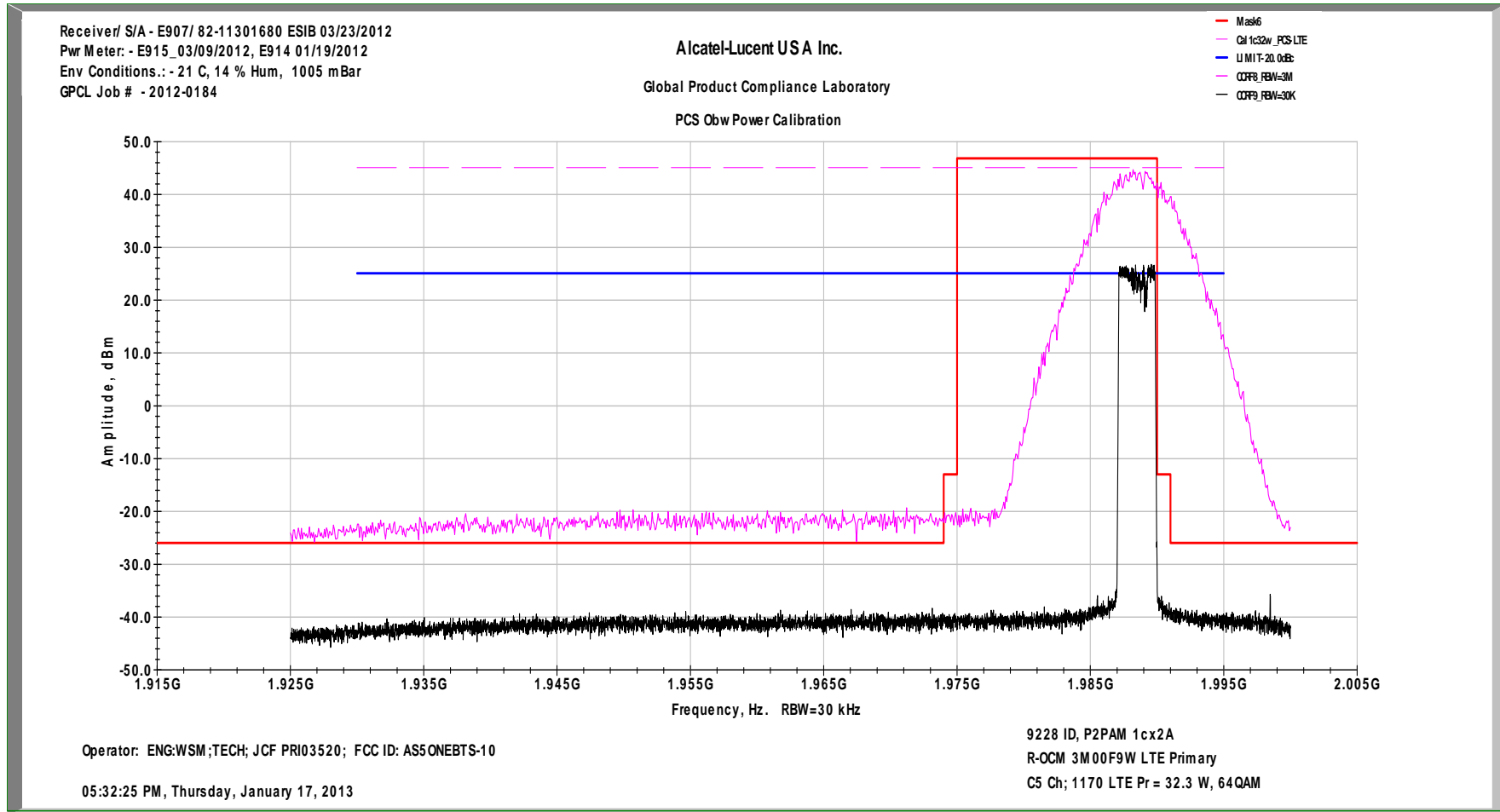

In-Band Intermodulation Graph LTE3 MHz Ch C-1170 1cx2A 32W/c 64QAM Primary Tx1

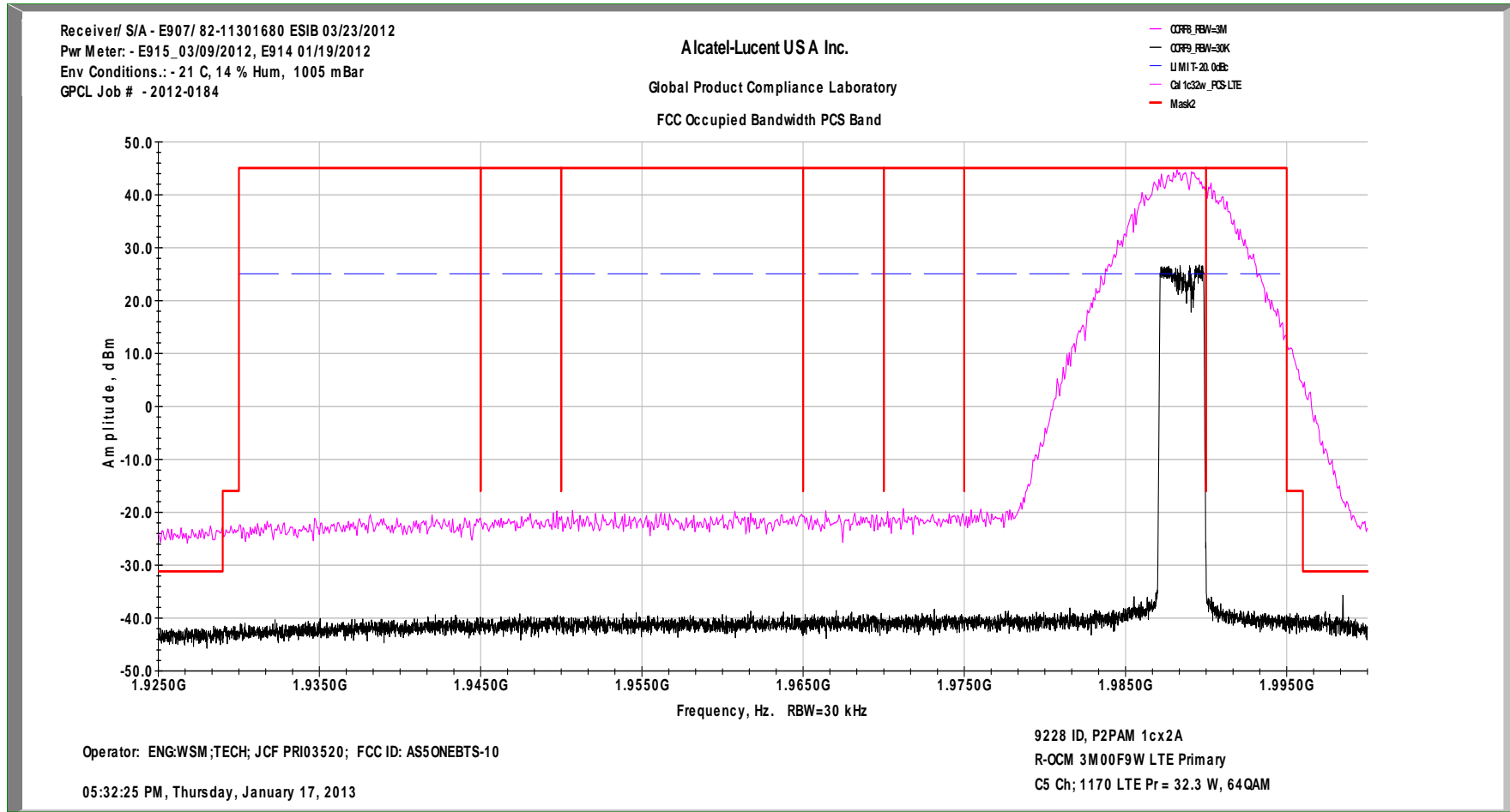

FCC Edge of Block Margin LTE3 MHz Ch C-1170 1cx2A 32W/c 64QAM Primary Tx1

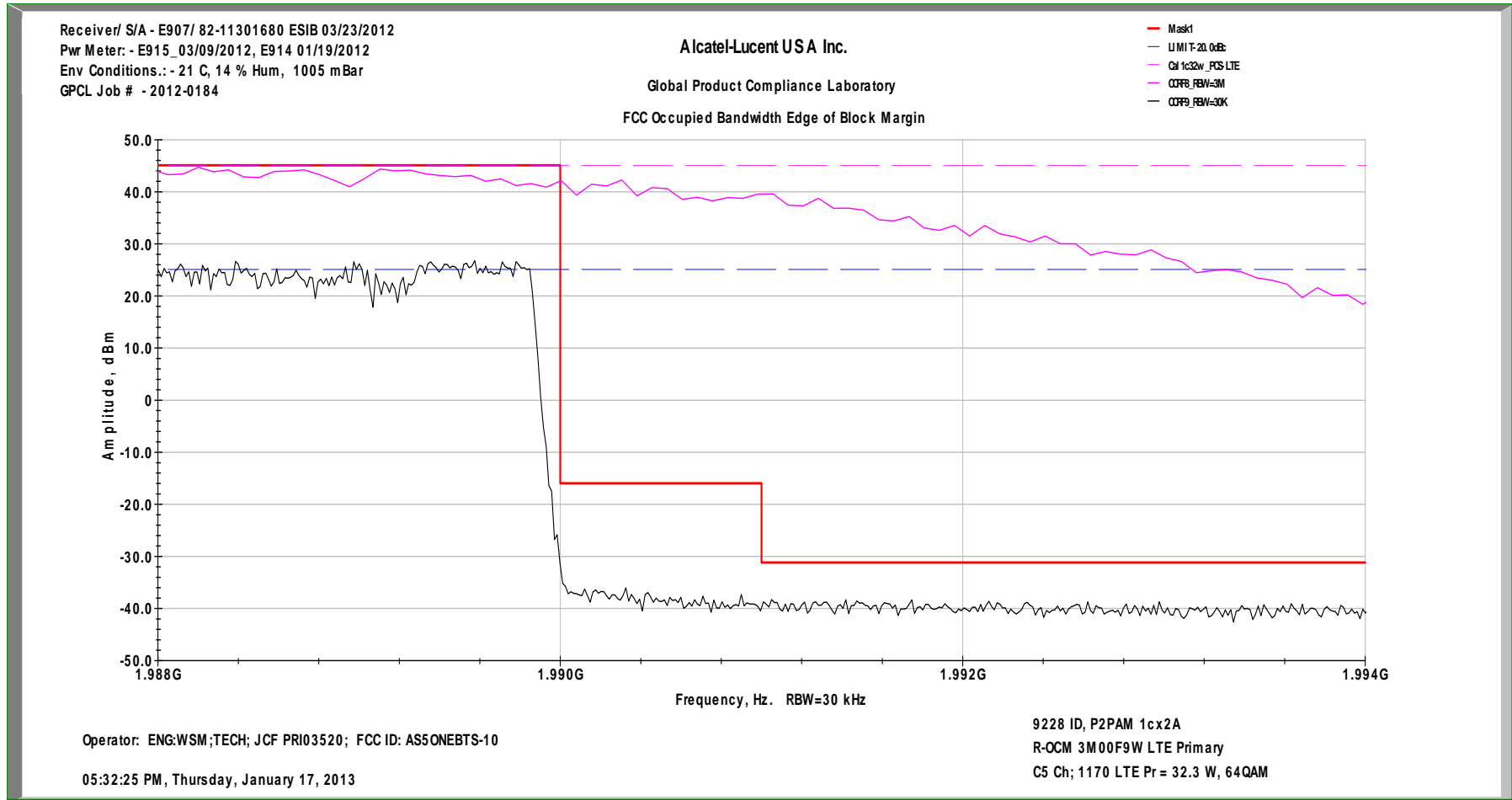

FCC Occupied Bandwidth w/ 3 Modulations LTE3 MHz Ch C-1170 1cx2A 32W/c QPSK, 16QAM & 64QAM Primary Tx1

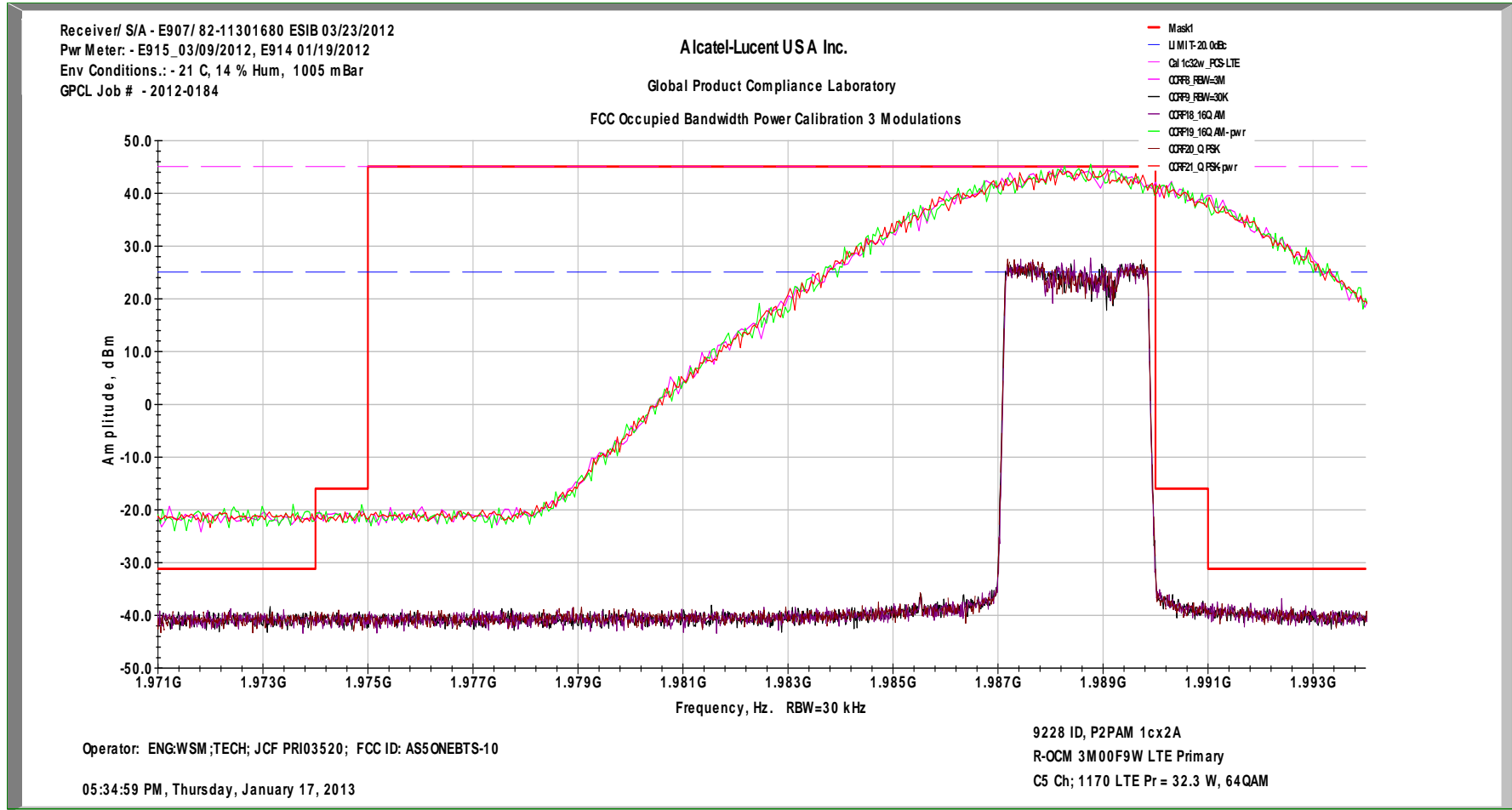

FCC Occupied Bandwidth Emissions LTE3 MHz Ch C-1170 1cx1A 32W/c 64QAM Diversity Tx2

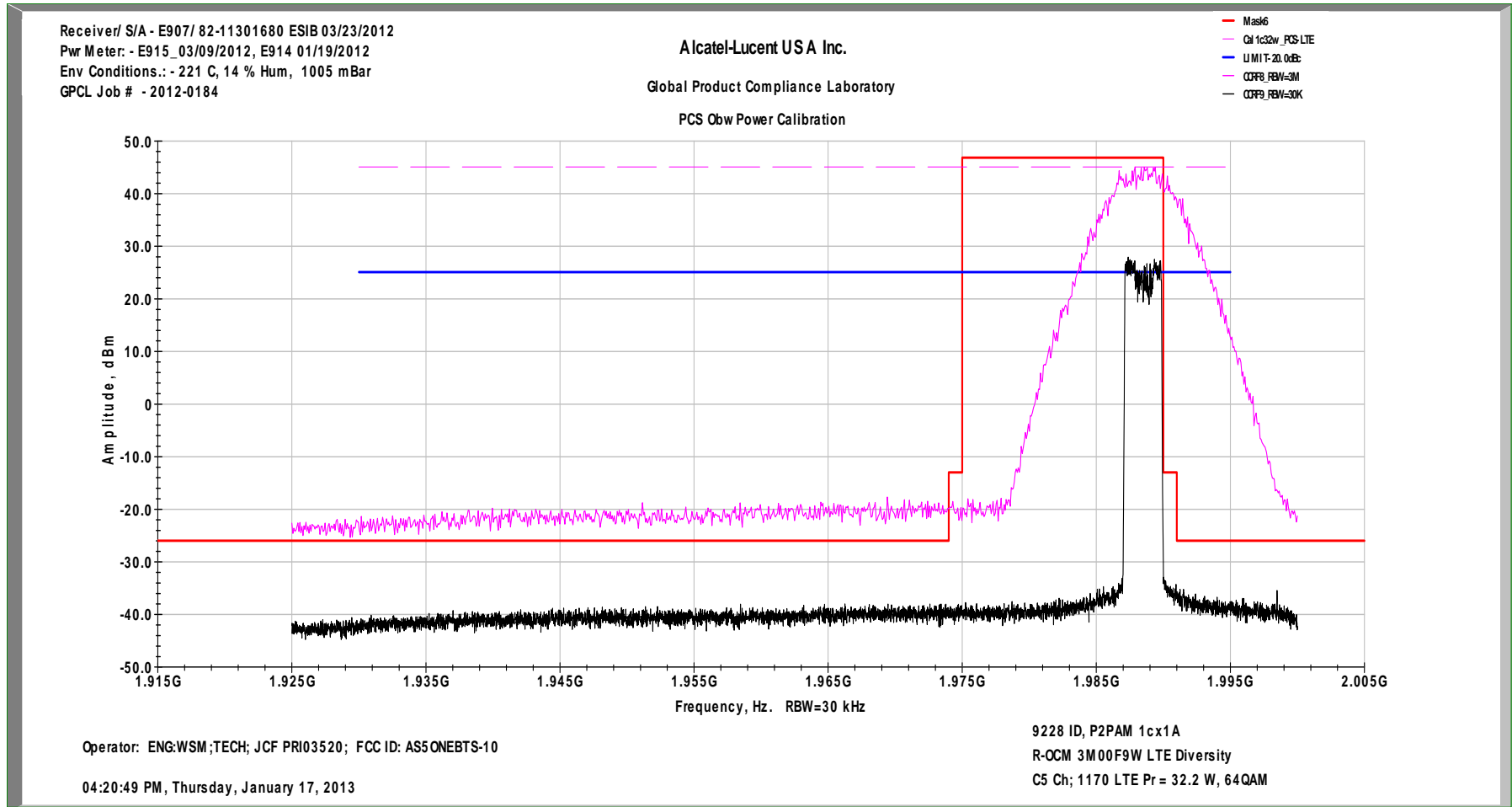

In-Band Intermodulation Graph LTE3 MHz Ch C-1170 1cx1A 32W/c 64QAM Diversity Tx2

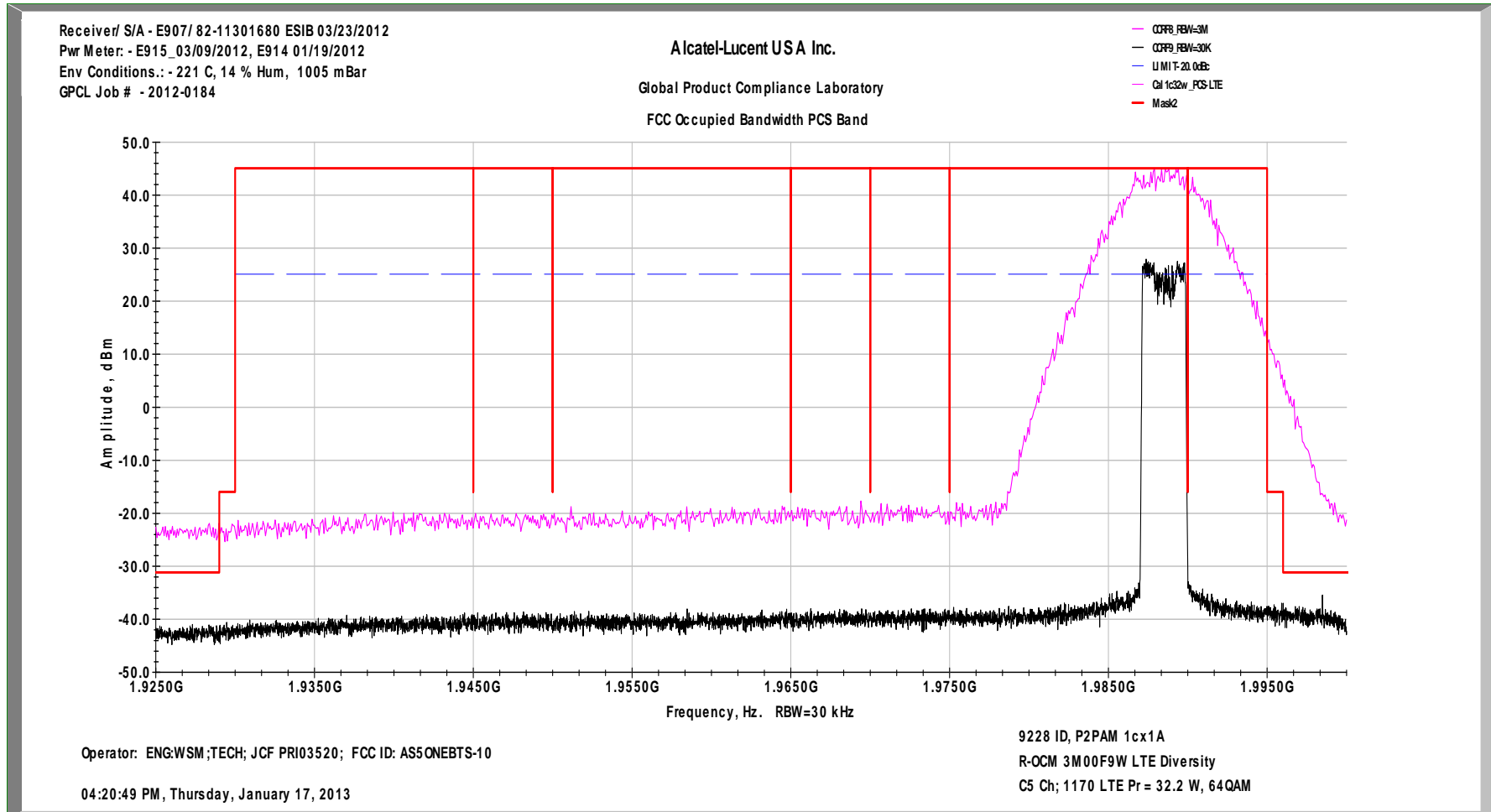

FCC Edge of Block Margin LTE3 MHz Ch C-1170 1cx1A 32W/c 64QAM Diversity Tx2

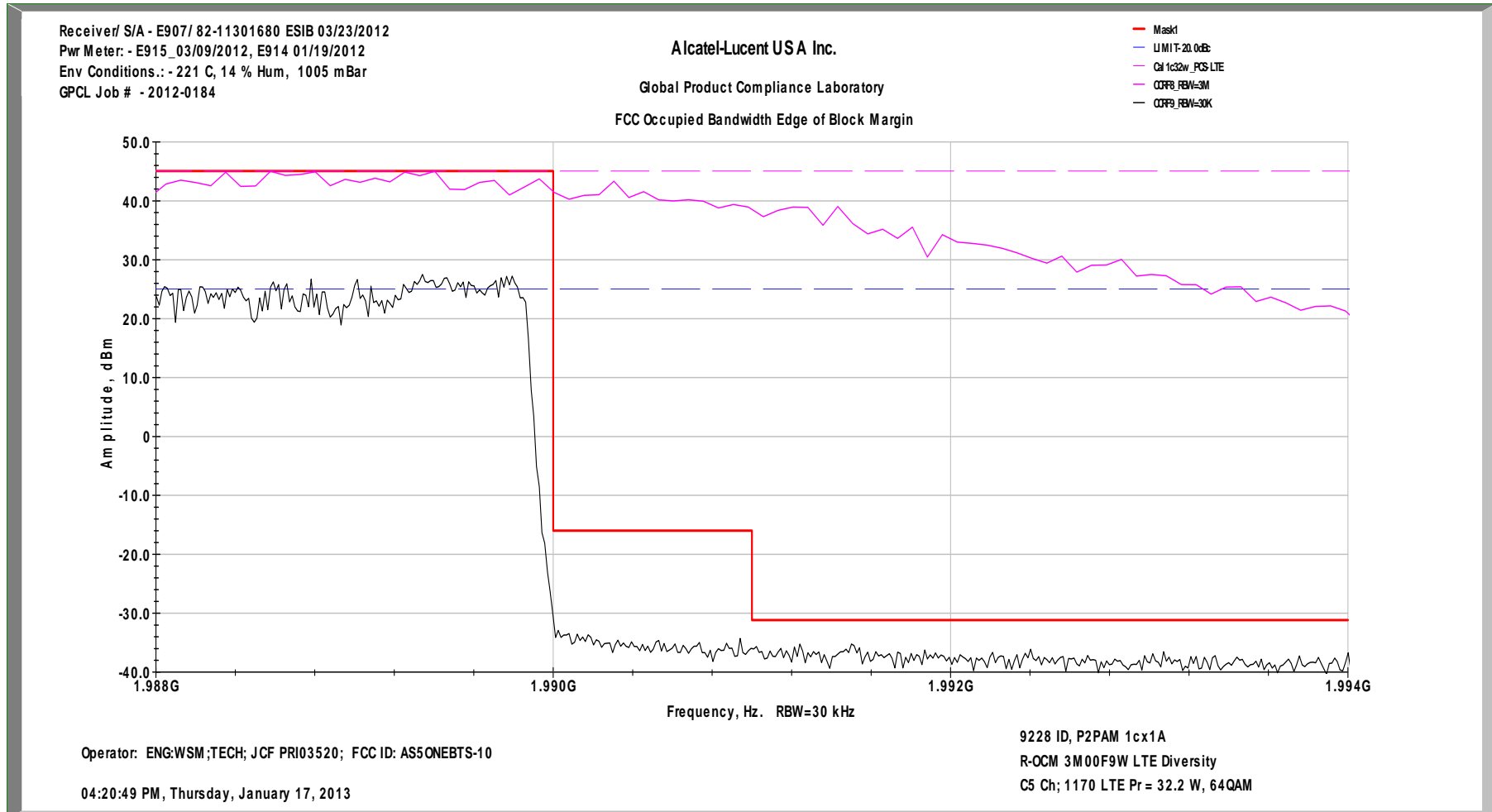

FCC Occupied Bandwidth w/ 3 Modulations LTE3 MHz Ch C-1170 1cx1A 32W/c QPSK, 16QAM & 64QAM Diversity Tx2

