

EXHIBIT 10: TEST REPORT**SYNOPSIS**

The test report attached to this exhibit demonstrates that the Lucent Technologies' Broadband PCS UMTS-CDMA "Multi-Carrier CDMA Radio" (MCR1900), Model BNJ64, which is designed to operate in the Lucent UMTS Flexent® OneBTS™ MCPA (External Multi-Carrier Power Amplifier) Wireless Base Station, is in full compliance with all requirements of the Rules of the Commission as specified in the Code of Federal Regulations (CFR), Title 47 – Telecommunication; Part 24, Subpart E – Broadband PCS; Section 24.238 - Emission Limits; effective October 1, 2004. All testing was performed in accordance with CFR 47, Part 2, Subpart J – Equipment Authorization Procedures; effective October 1, 2004. It also demonstrates compliance with the spurious emissions limitations specified in ETSI TS 125 141 V5.9.0 (2004-09): Universal Mobile Telecommunications System (UMTS); Base Station Conformance Testing (FDD), (3GPP TS 25.141, Version 5.9.0, Release 5), which is the standard used as a guideline in the design of the MCR1900 transceiver. The objective of this application is to obtain FCC Class II Permissive Change Authorization, under FCC ID: AS5ONEBTS-09, for operation in the Universal Mobile Telecommunications System (UMTS) with a single 5 MHz emission bandwidth carrier (4M10F9W) set to a maximum power level at the frame transmit terminal of 3.3 Milliwatts (3-second), over the entire Broadband PCS frequency spectrum 1930-1990 MHz. The MCR1900 was initially filed under AS5ONEBTS-09 for CDMA operation. The purpose of this Class II Change is to add the UMTS emission designator, 4M10F9W, to the initial filing.

The UMTS1900 UMTS-CDMA MCPA consists of the principle RF components: (1) Crystal Reference Oscillator Module (OMA) at 15 MHz, and (2) UMTS-CDMA "Multi-Carrier CDMA Radio" (MCR1900), Model BNJ64, which was previously authorized by the Federal Communications Commission under FCC ID: AS5ONEBTS-09, covering the PCS frequency spectrum: A thru C 1930-1990 MHz. The MCPA is configured for 3S1C operation with the output of the MCR1900 radio connected to the frame transmit terminal; the maximum single carrier power level is rated at 3.3 mW (+5.2 dBm). Two modulation variations were evaluated: 1) standard 5 MHz UMTS with QPSK modulation and 20 active channels, and 2) 5 MHz High Speed Downlink Packet Access (HSDPA) with QPSK + 16QAM modulation and 24 active channels.

All conducted RF characteristics and emissions measurements were performed at the MCPA frame transmit terminal, using a production MCPA equipment frame. All testing was performed in the Lucent Technologies, Whippany, NJ, compliance laboratory by J. C. Fidler and M. P. Farina during the period March 28 to April 11, 2005; in adherence to a test plan generated by M. P. Farina, in accordance with Lucent's ISO/TL9000 Registration. All measurement instrumentation utilized were also calibrated in compliance with Lucent's ISO/TL9000 Registration. The Whippany 3 & 10 Meter Open Area Test Site (OATS) is authorized by the Federal Communications Commission (FCC) under Registration Number: 90770, in compliance with the requirements of Section 2.948 of the Rules of the Commission.

Frequency stability measurements were previously performed by M. Coelho, Lucent Technologies, Swindon, United Kingdom, under the direction of M. P. Farina, and in adherence to the previously cited ISO/TL9000 test plan. This test program was conducted during the approximate interval February 3 to March 15, 2005.

Lucent Technologies
Bell Labs Innovations



67 Whippany Road
Whippany, NJ 07981

Subject: **Application for FCC Initial Authorization, under
FCC ID: AS5ONEBTS-10, Covering a Broadband
PCS UMTS-CDMA Transceiver System (1900),
Operating Over the Spectrum 1930-1990 MHz with
a 5 MHz Carrier Emission Bandwidth.**

Michael P. Farina
JW10D0000
Telephone: 973-386-4344
mpfarina@lucent.com

April 14, 2005

TEST REPORT

INTRODUCTION:

The exhibits presented in this test report demonstrate that the Lucent Technologies' Broadband PCS UMTS-CDMA "Multi-Carrier CDMA Radio" (MCR1900), Model BNJ64, which is designed to operate in the Lucent UMTS Flexent® OneBTS™ "External Multi-Carrier Power Amplifier" (MCPA) Wireless Base Station, is in full compliance with all requirements of the Rules of the Commission as specified in the Code of Federal Regulations (CFR), Title 47 – Telecommunication; Part 24, Subpart E – Broadband PCS; Section 24.238 - Emission Limits; effective October 1, 2004. All testing was performed in accordance with CFR 47, Part 2, Subpart J – Equipment Authorization Procedures; effective October 1, 2004. It also demonstrates compliance with the spurious emissions limitations specified in ETSI TS 125 141 V5.9.0 (2004-09): Universal Mobile Telecommunications System (UMTS); Base Station Conformance Testing (FDD), (3GPP TS 25.141, Version 5.9.0, Release 5). This standard was the guideline used in the design of the MCR1900 transceiver. The objective of this application is to obtain FCC Class II Permissive Change Authorization, under FCC ID: AS5ONEBTS-09, for operation in the Universal Mobile Telecommunications System (UMTS) with a single 5 MHz emission bandwidth carrier and adding the emission designator 4M10F9W to the initial filing. The maximum rated power level at the MCPA frame transmit terminal is 3.3 Milliwatts (3-second), over the Broadband PCS frequency spectrum 1930-1990 MHz. Two modulation variations were evaluated: 1) standard 5 MHz UMTS with QPSK modulation and 20 active channels, and 2) 5 MHz High Speed Downlink Packet Access (HSDPA) with QPSK + 16QAM modulation and 24 active channels.

The UMTS1900 MCPA Macrocell consists of the principle RF components: (1) Crystal Reference Oscillator Module (OMA) at 15 MHz, and (2) UMTS-CDMA "Multi-Carrier CDMA Radio" (MCR1900), Model BNJ64, which was previously authorized by the Federal Communications Commission under FCC ID: AS5ONEBTS-09, covering the PCS frequency spectrum: 1930-1990 MHz.

All conducted RF characteristics and emissions measurements were performed at the transmit antenna terminal, using a production MCPA equipment frame. All testing was performed in the Lucent Technologies, Whippany, NJ, compliance laboratory by J. C. Fidler and M. P. Farina during the period March 28 to April 11, 2005; in adherence to a test plan generated by M. P. Farina, in accordance with Lucent's ISO/TL9000 Registration. All measurement instrumentation utilized were also calibrated in compliance with Lucent's ISO/TL9000 Registration. The Whippany 3 & 10 Meter Open Area Test Site (OATS) is authorized by the Federal Communications Commission (FCC) under Registration Number: 90770, in compliance with the requirements of Section 2.948 of the Rules of the Commission.

Frequency stability measurements were previously performed by M. Coelho, Lucent Technologies, Swindon, United Kingdom, under the direction of M. P. Farina, and in adherence to the previously cited ISO/TL9000 test plan. This test program was conducted during the approximate interval February 3 to March 15, 2005.

This report fully documents all required tests and the test results, sufficient to show full compliance with the Rules of the Commission.

APPLICABLE FCC RULES AND INDUSTRY STANDARDS:

The exhibits presented in this test report demonstrate that the Lucent Technologies' Broadband PCS UMTS-CDMA "Multi-Carrier CDMA Radio" (MCR1900), Model BNJ64, which is designed to operate in the Lucent UMTS Flexent® OneBTS™ "External Multi-Carrier Power Amplifier" (MCPA) Wireless Base Station, is in full compliance with all requirements of the Rules of the Commission as specified in the Code of Federal Regulations (CFR), Title 47 – Telecommunication; Part 24, Subpart E – Broadband PCS; Section 24.238 - Emission Limits; effective October 1, 2004. All testing was performed in accordance with CFR 47, Part 2, Subpart J – Equipment Authorization Procedures; effective October 1, 2004. It also demonstrates compliance with the spurious emissions limitations specified in ETSI TS 125 141 V5.9.0 (2004-09): Universal Mobile Telecommunications System (UMTS); Base Station Conformance Testing (FDD), (3GPP TS 25.141, Version 5.9.0, Release 5). The specific test procedures that are both required for and are applicable to the UMTS1900 MCR1900 transceiver are:

Part 2.1046	RF Power Output	Pages 4 – 5
Part 2.1047	Modulation Characteristics	Pages 6-11
Part 2.1049	Occupied Bandwidth	Pages 12-26
Part 2.1051	Spurious Emissions at the Antenna Terminals.	Pages 27-38
Part 2.1053	Field Strength of Spurious Radiation	Pages 39
Part 2.1055	Frequency Stability	Pages 40-64
Part 2.1057	Frequency Spectrum to be Investigated	
Part 24	Personal Communications Services; Subpart E – Broadband PCS	
Part 24.238	Emission Limits	

ETSI TS 125 141 V5.9.0 (2004-09): Universal Mobile Telecommunications System (UMTS); Base Station Conformance Testing (FDD), (3GPP TS 25.141, Version 5.9.0, Release 5).

ANSI C63.4-2003 American National Standard for Methods of Measurement of Radio-Noise Emissions from Low-Voltage Electrical and Electronic in the Range of 9 kHz to 40 GHz; January 30, 2004

PART 2.1046 MEASUREMENTS REQUIRED: RF POWER OUTPUT

The Broadband PCS UMTS-CDMA “Multi-Carrier CDMA Radio” (MCR1900), Model BNJ64, transceiver, subject of this application for Class II Permissive Change Authorization, is designed to provide a maximum RF power level, per single 5 MHz emission bandwidth carrier, of 3.3 Milliwatts (+5.2 dBm) at the MCPA equipment frame transmit terminal. This System is designed to operate in the PCS frequency spectrum: 1930-1990 MHz. The MCPA does not contain power amplifiers and bandpass transmit filters; it is designed to interface with the customer’s external and pre-existing power amplifiers and transmit filters.

All conducted emission measurements are performed at the frame transmit terminal. Nine 5 MHz UMTS carrier channels were used throughout this test procedure, as tabulated below, to represent the lowest and the highest settable channels in the PCS A, B and C-Blocks, and the center frequency of D, E and F-Blocks. Each time the carrier was set to each of the channels, the power level is adjusted, by software control, to +5.0 dBm to + 5.2 dBm (nominally 3.3 mW at 3-second average) before performing each emission measurement. The carrier modulation was first set to the UMTS standard full 20 active channels, as required by ETSI Test Model 1; and then to the High Speed Downlink Packet Access (HSDPA) 24 active channels, as required by ETSI Test Model 5.

UMTS Frequency	PCS Frequency Block	Single Carrier Bandwidth	UMTS Channel Number	UMTS Carrier Center Frequency	Measured Power Level
A1	Lowest Settable Channel	5 MHz	12	1932.5 MHz	+5 dBm
A3	Highest Settable Channel	5 MHz	62	1942.5 MHz	+5 dBm
D	Block Center	5 MHz	87	1947.5 MHz	+5 dBm
B1	Lowest Settable Channel	5 MHz	112	1952.5 MHz	+5 dBm
B3	Highest Settable Channel	5 MHz	162	1962.5 MHz	+5 dBm
E	Block Center	5 MHz	187	1967.5 MHz	+5 dBm
F	Block Center	5 MHz	212	1972.5 MHz	+5 dBm
C3	Lowest Settable Channel	5 MHz	237	1977.5 MHz	+5 dBm
C5	Highest Settable Channel	5 MHz	287	1987.5 MHz	+5 dBm

These nine frequencies are used for all of the conducted emission tests that follow.

Results: The 5 MHz UMTS 1900 MCR1900 transceiver is compliant with the manufacturer’s rated power level at the frame transmit terminal for the above listed carrier frequencies.

Block Diagram Of The Power Measurement Test Set-Up And Test Equipment Configuration for the Lucent UMTS Flexent® OneBTS™ W1900M Wireless Base Station

3.3 Milliwatt (+5 dBm) Average at Antenna Terminal

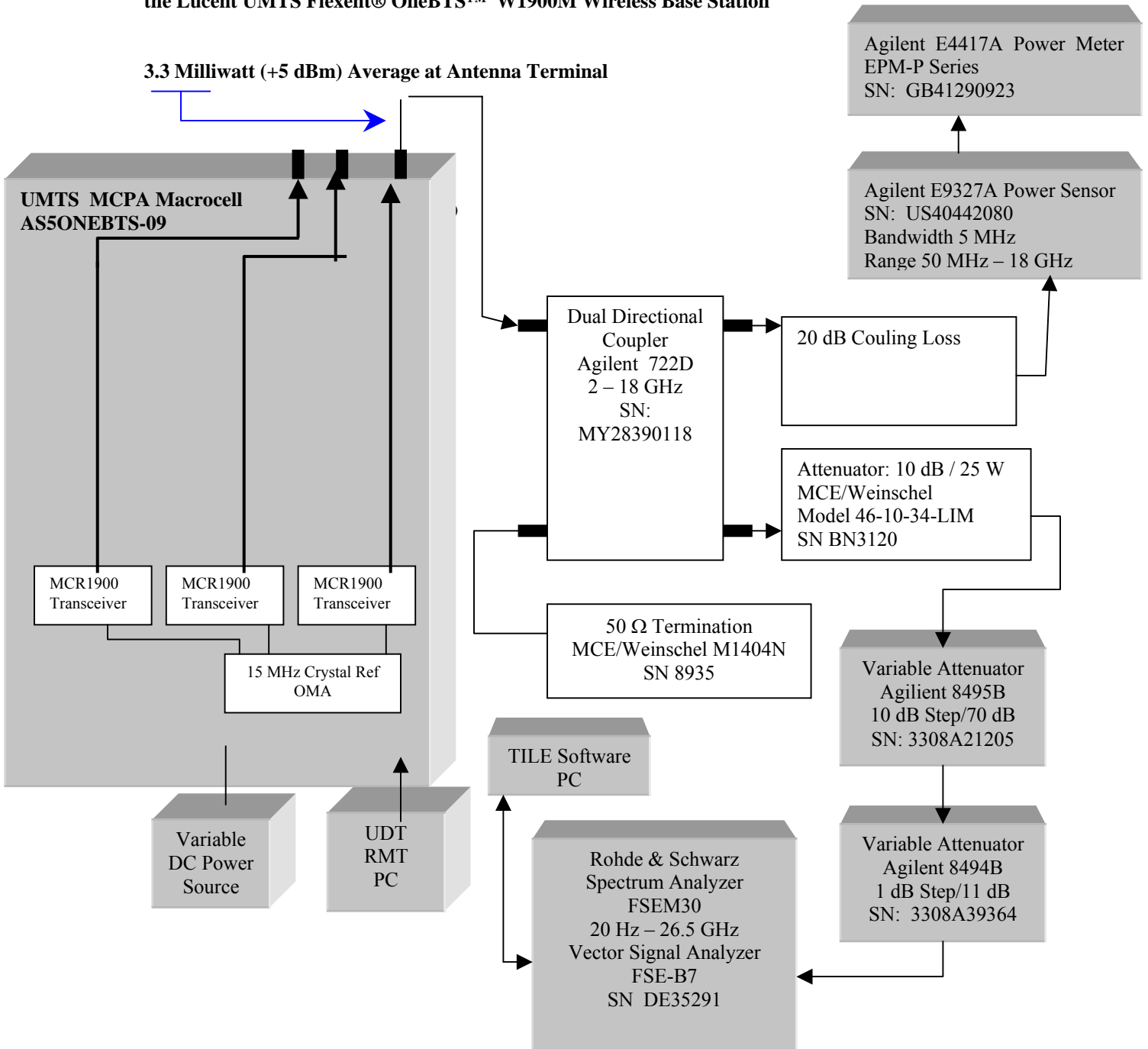

PART 2.1047 MEASUREMENTS REQUIRED: MODULATION CHARACTERISTICS

The modulation accuracy was measured at the MCPA Transmit Terminal for each of the nine UMTS 1900 carriers A1, A3, D, B1, B3, E, F, C3 and C5. The power level was set 3.3 Milliwatts (+5 dBm) and the modulation set to provide a single active channel/code (PCCPCH + SCH), as required for ETSI TS 25.141 Test Model 4 (TM4) modulation. The requirement is that the Error Vector Magnitude (EVM) be less than 17.5% rms. The test equipment used was an Agilent E4406A VSA Series Transmitter Tester (SN US41513199). In accordance with ETSI TS 25.141 Rel 5, this measurement with TM4 should be made with the power level set to $P_{max} - 18 \text{ dB} = 5 \text{ dBm} - 18 \text{ dB} = \text{nominally } -13 \text{ dBm}$.

RMS Error Vector Magnitude (EVM) Measurement Summary at the Antenna Terminal:

UMTS PCS Frequency Block	Broadband PCS Frequency Block	Power Level at Transmit Terminal	UMTS1900 Channel No.	UMTS 1900 Carrier Center Frequency MHz	Modulation Accuracy at Transmit Terminal: Error Vector Magnitude (EVM)
A1	Lowest Settable	-13.6 dBm	12	1932.5	2.41% rms
A3	Highest Settable	-13.8 dBm	62	1942.5	2.35 % rms
D	Center	-13.8 dBm	87	1947.5	2.19 % rms
B1	Lowest Settable	-13.9 dBm	112	1952.5	2.16 % rms
B3	Highest Settable	-13.8 dBm	162	1962.5	1.93 % rms
E	Center	-13.6 dBm	187	1967.5	1.92% rms
F	Center	-13.2 dBm	212	1972.5	1.82 % rms
C3	Lowest Settable	-13.2 dBm	237	1977.5	2.42 % rms
C5	Highest Settable	-13.5 dBm	287	1987.5	2.59 % rms

Minimum Standard Requirement: The minimum standard requirement is that the RMS Error Vector Magnitude (EVM) shall be less than 17.5%.

Test Set-up and Configuration: Same as previously used for Part 2.1046 RF Power Measurement, with exception that the FSEM30 Spectrum Analyzer is replaced by:

- 1) Agilent E4406A VSA Series Transmitter Tester, 7 MHz – 4.0 GHz, SN US41513199

RESULTS: The UMTS1900 UMTS-CDMA Transceiver System (1900) demonstrated full compliance with the modulation accuracy requirements specified in ETSI TS 25.141. All 9 channels were less than the 17.5% rms limitation. The plots for each channel are included in this exhibit as shown below.

Modulation Characteristics: Frequency Block A; Carrier Channel A1
UMTS1900 Ch 12; 1932.5 MHz at Tx Transmit Terminal at -13.6 dBm per single 5 MHz carrier

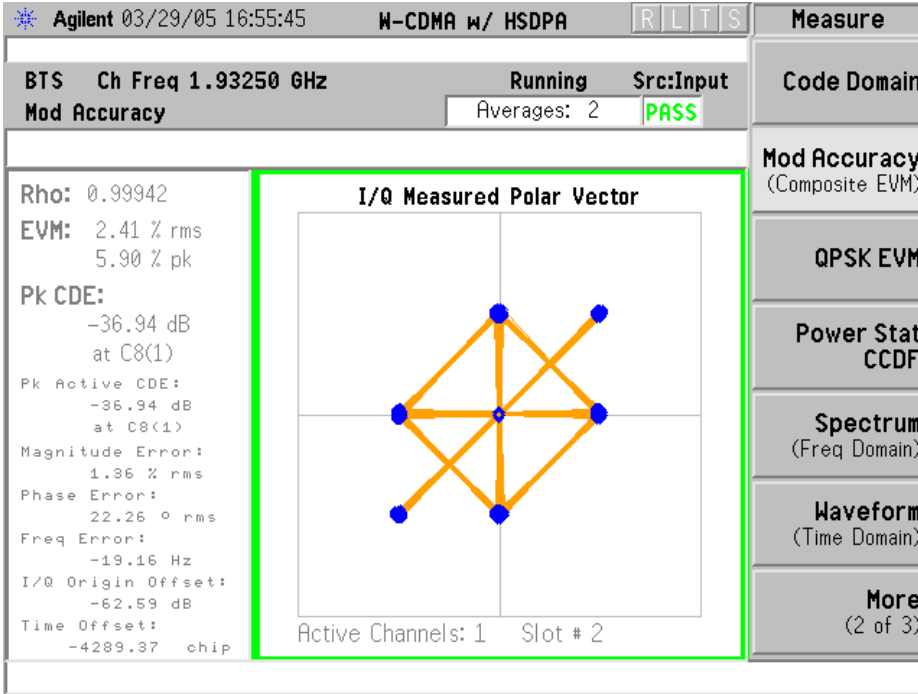

Modulation Characteristics: Frequency Block A; Carrier Channel A3
UMTS1900 Ch 62; 1942.5 MHz at Tx Transmit Terminal at -13.8 dBm per single 5 MHz carrier

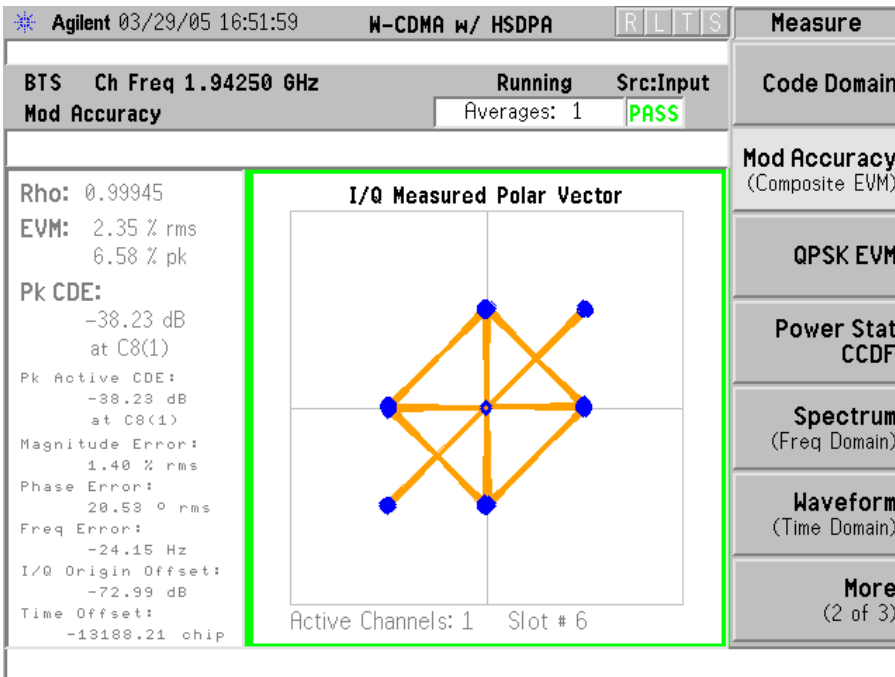

Modulation Characteristics: Frequency Block D, Carrier Channel D
UMTS1900 Ch 87; 1947.5 MHz at Tx Transmit Terminal at -13.8 dBm per single 5 MHz carrier

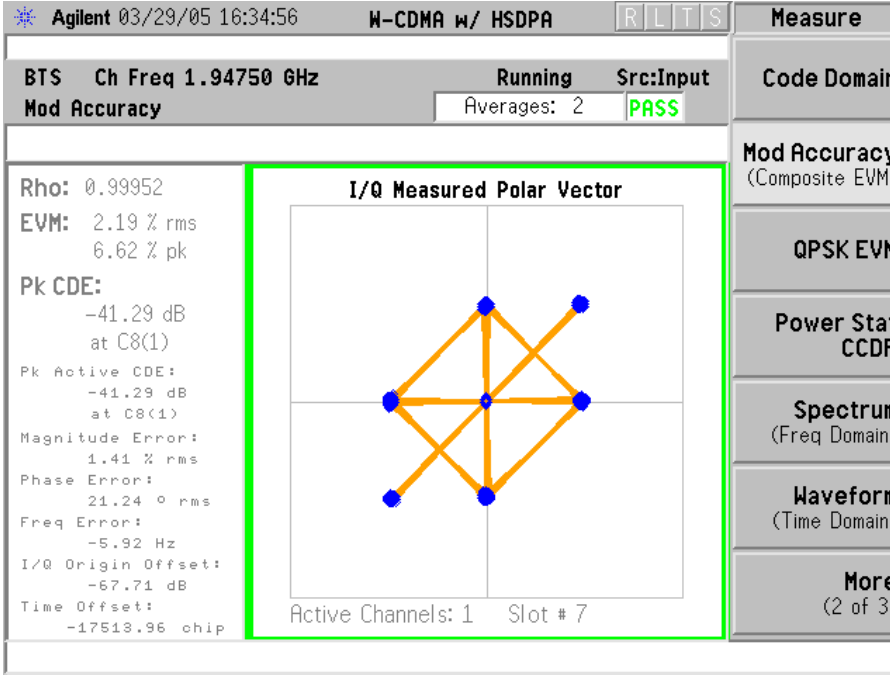

Modulation Characteristics: Frequency Block B, Carrier Channel B1
UMTS1900 Ch 112; 1952.5 MHz at Tx Transmit Terminal at -13.9 dBm per single 5 MHz carrier

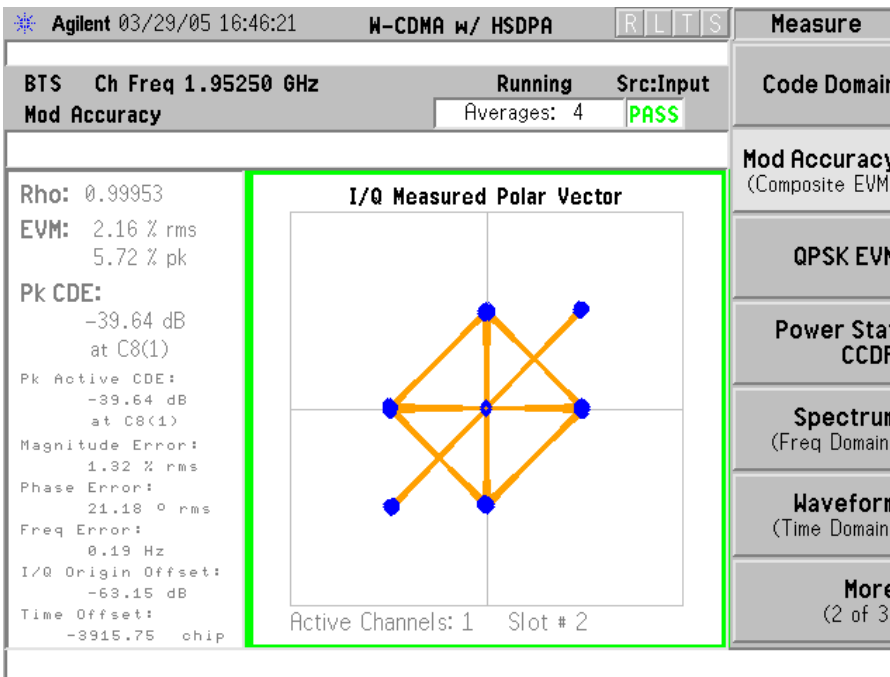

Modulation Characteristics: Frequency Block B, Carrier Channel B3
UMTS1900 Ch 162; 1962.5 MHz at Tx Transmit Terminal at -13.8 dBm per single 5 MHz carrier

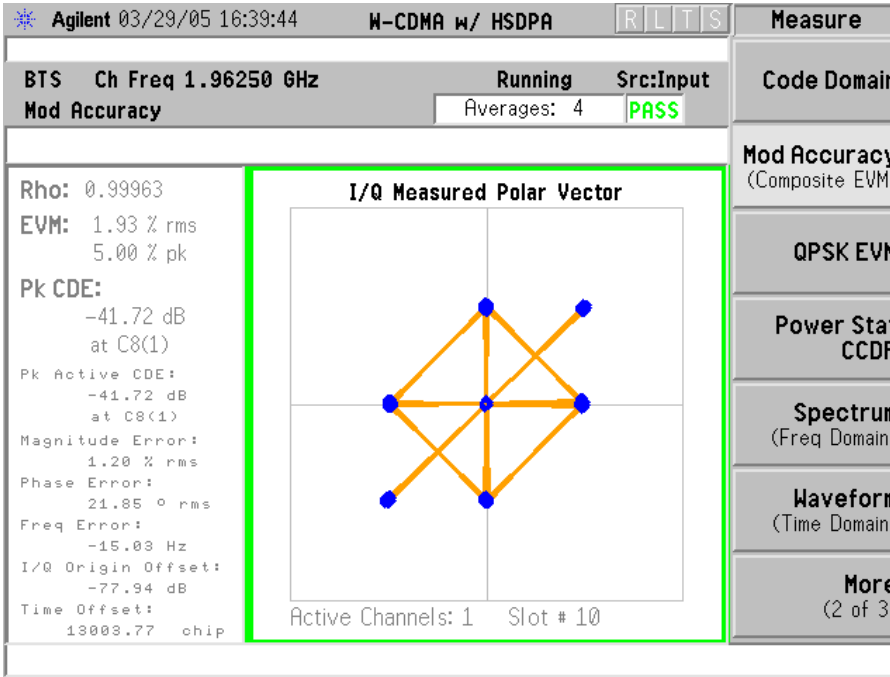

Modulation Characteristics: Frequency Block E, Carrier Channel E
UMTS1900 Ch 187; 1967.5 MHz at Tx Transmit Terminal at -13.6 dBm per single 5 MHz carrier

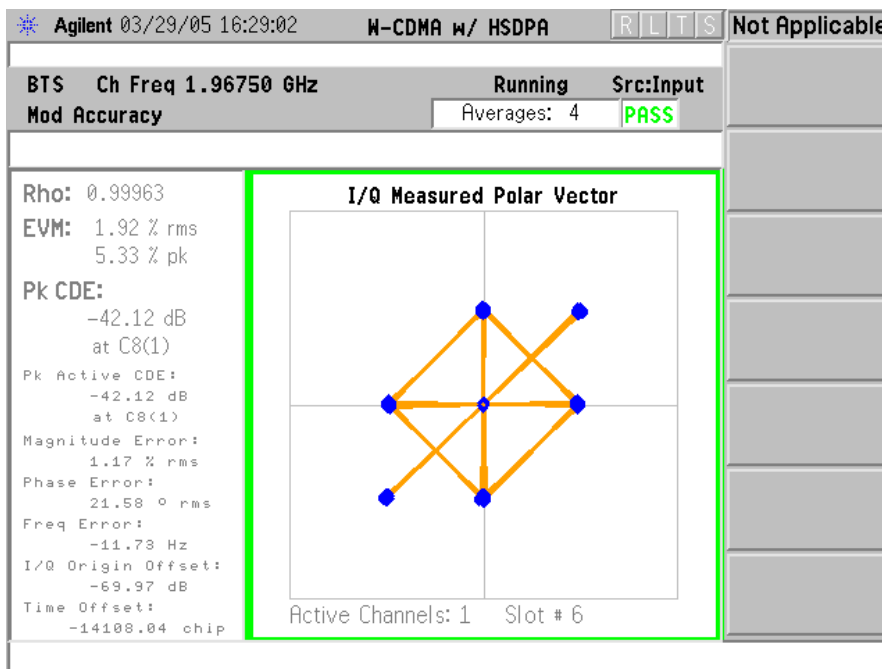

Modulation Characteristics: Frequency Block F, Carrier Channel F
UMTS1900 Ch 212; 1972.5 MHz at Tx Transmit Terminal at -13.2 dBm per single 5 MHz carrier

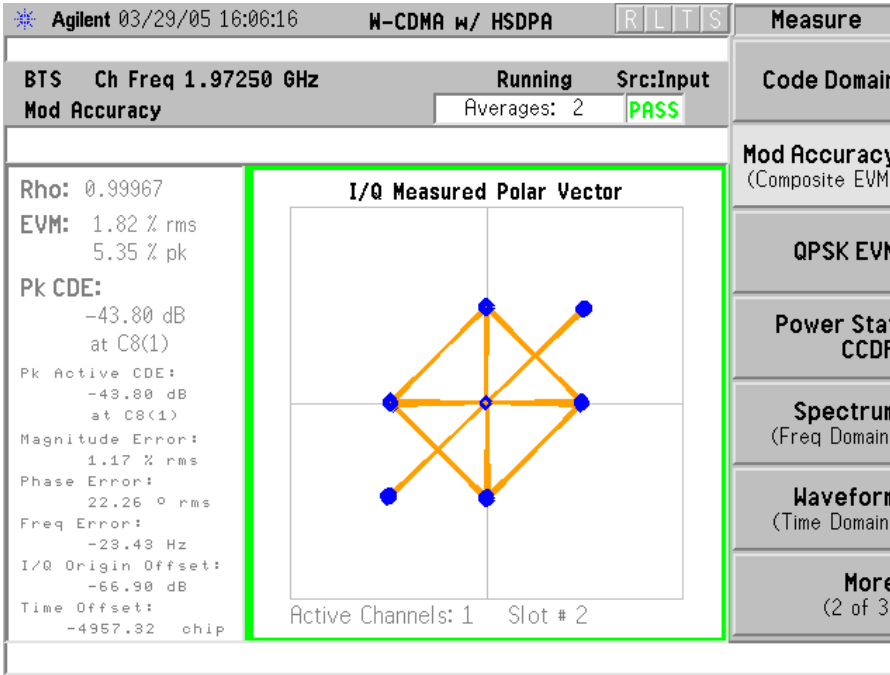

Modulation Characteristics: Frequency Block C, Carrier Channel C3
UMTS1900 Ch 237; 1977.5 MHz at Tx Transmit Terminal at -13.2 dBm per single 5 MHz carrier

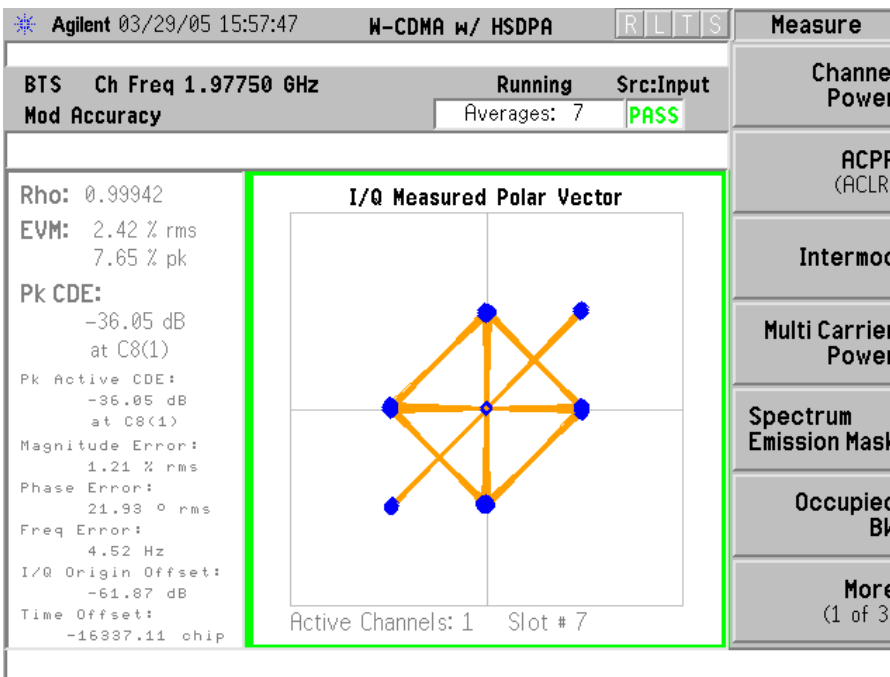

Modulation Characteristics: Frequency Block C, Carrier Channel C5
UMTS1900 Ch 287; 1987.5 MHz at Tx Transmit Terminal at -13.5 dBm per single 5 MHz carrier

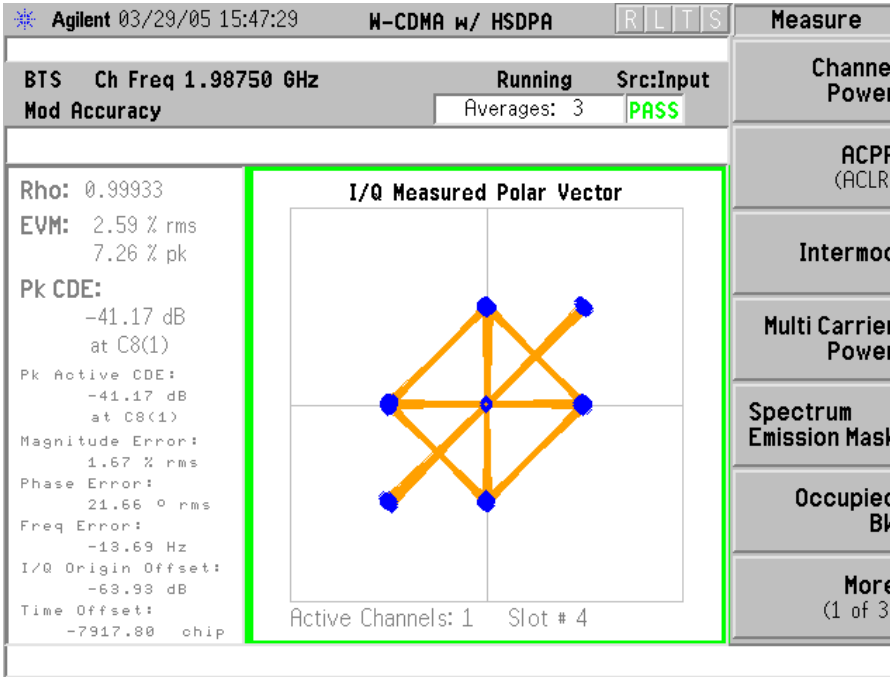

PART 2.1049 MEASUREMENTS REQUIRED: OCCUPIED BANDWIDTH

The occupied bandwidth was measured at the MCPA Transmit Terminal for each of the nine, UMTS 1900, 5 MHz carriers for both standard UMTS modulation and for HSDPA modulation. The power level was set to +5 dBm and the modulation first set to the full 20 active channels, as required for ETSI TS 25.141 Test Model 1 (TM1) modulation, and then to 24 active channels for TM5 modulation.

The occupied bandwidth was measured by two methods:

1. The carrier 99% power bandwidth, which is also the necessary bandwidth, using an Agilent E4406A VSA Series Transmitter Tester (SN US41513199).
2. Emission mask limitation using a Rohde & Schwarz: Spectrum Analyzer FSEM30 (SN DE35291), to demonstrate compliance with the ETSI TS 25.141 emission mask requirements and with Part 24.238.

Method 1: The carrier 99% power bandwidth was measured at the MCPA Transmit Terminal with the 5 MHz carrier set to +5 dBm and first modulated with the full 20 channels and then to 24 active channels for TM5. The measurement results show that the carrier is within the manufacturer’s rated 5 MHz bandwidth for all nine carriers, as tabulated below. Measurements were performed for 9 carriers in one sector, of this 3S1C equipment frame configuration, for both UMTS TM1 modulation and for HSDPA TM5 modulation. The data is shown below. However, for brevity, only the actual data plots for UMTS TM1 are attached to this exhibit, since there is no visible difference in the plots.

Measured Carrier 99% Power Bandwidth

UMTS PCS Carrier	Broadband PCS Frequency Block	Power Level at Transmit Terminal	UMTS1900 Channel No.	UMTS 1900 Carrier Center Frequency MHz	UMTS 20 Active Channels MHz	HSDPA 24 Active Channels MHz
A1	Lowest Settable	5 dBm	12	1932.5	4.0939	4.1026
A3	Highest Settable	5 dBm	62	1942.5	4.0848	4.0921
D	Center	5 dBm	87	1947.5	4.0968	4.0961
B1	Lowest Settable	5 dBm	112	1952.5	4.0925	4.0915
B3	Highest Settable	5 dBm	162	1962.5	4.0979	4.0995
E	Center	5 dBm	187	1967.5	4.1073	4.1051
F	Center	5 dBm	212	1972.5	4.0939	4.0969
C3	Lowest Settable	5 dBm	237	1977.5	4.0902	4.0985
C5	Highest Settable	5 dBm	287	1987.5	4.0919	4.1217

Results: For each UMTS1900 channel, the carrier does not exceed 5.0 MHz.
 The average and range of 99% power bandwidths/necessary bandwidths are:

	UMTS	UMTS + HSDPA
Average	4.0944 MHz	4.1004 MHz
Max	4.1073 MHz	4.1217 MHz
Min	4.0848 MHz	4.0915 MHz

Carrier Bandwidth Characteristics: Frequency Block A; Carrier Channel A1; Sector 3
UMTS1900 Ch 12; 1932.5 MHz at Tx Transmit Terminal at +5 dBm per single 5 MHz carrier

TM1 Modulation with 20 Active Channels

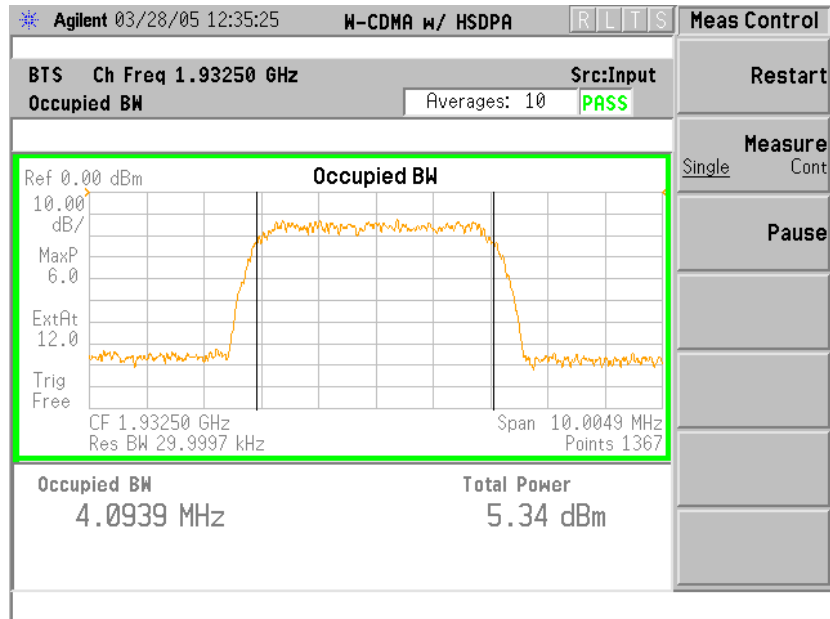

Carrier Bandwidth Characteristics: Frequency Block A; Carrier Channel A3; Sector 3
UMTS1900 Ch 62; 1942.5 MHz at Tx Transmit Terminal at +5 dBm per single 5 MHz carrier

TM1 Modulation with 20 Active Channels

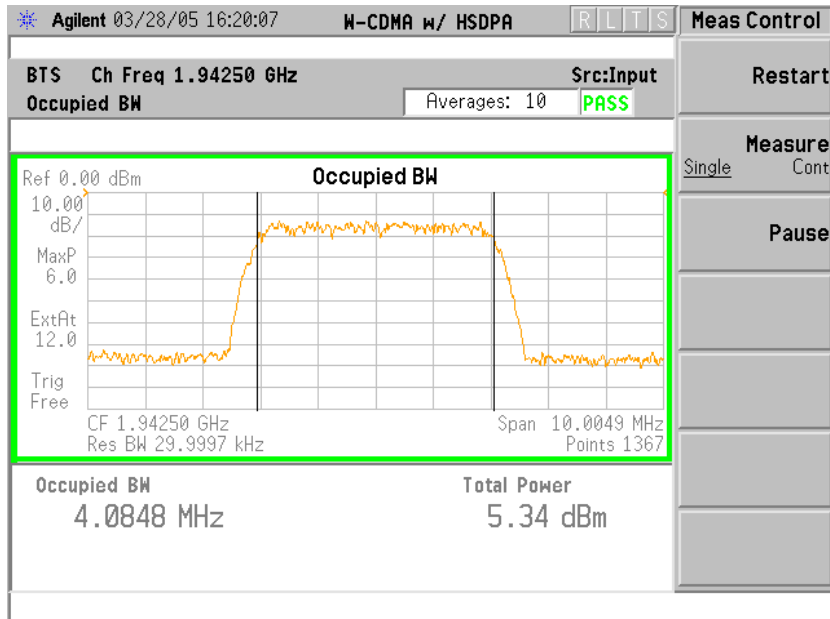

Carrier Bandwidth Characteristics: Frequency Block D; Carrier Channel D; Sector 3
UMTS1900 Ch 87; 1947.5 MHz at Tx Transmit Terminal at +5 dBm per single 5 MHz carrier

TM1 Modulation with 20 Active Channels

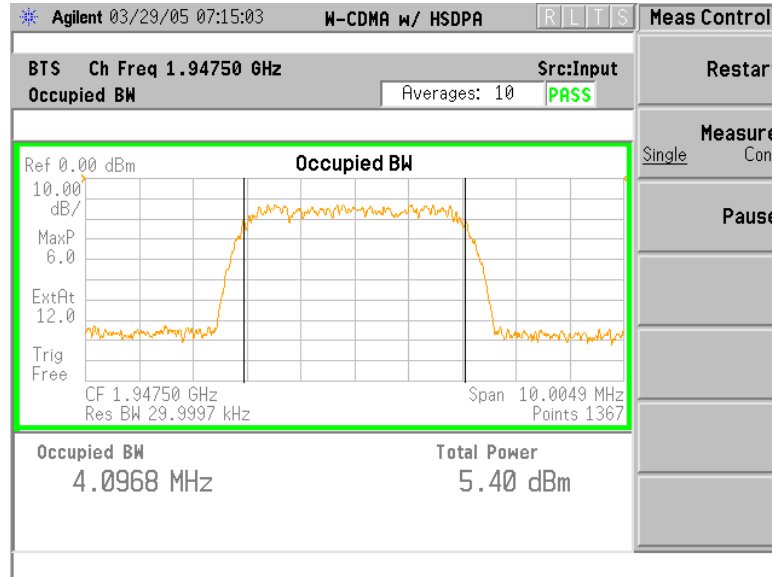

Carrier Bandwidth Characteristics: Frequency Block B, Carrier Channel B1; Sector 3
UMTS1900 Ch 112; 1952.5 MHz at Tx Transmit Terminal at +5 dBm per single 5 MHz carrier

TM1 Modulation with 20 Active Channels

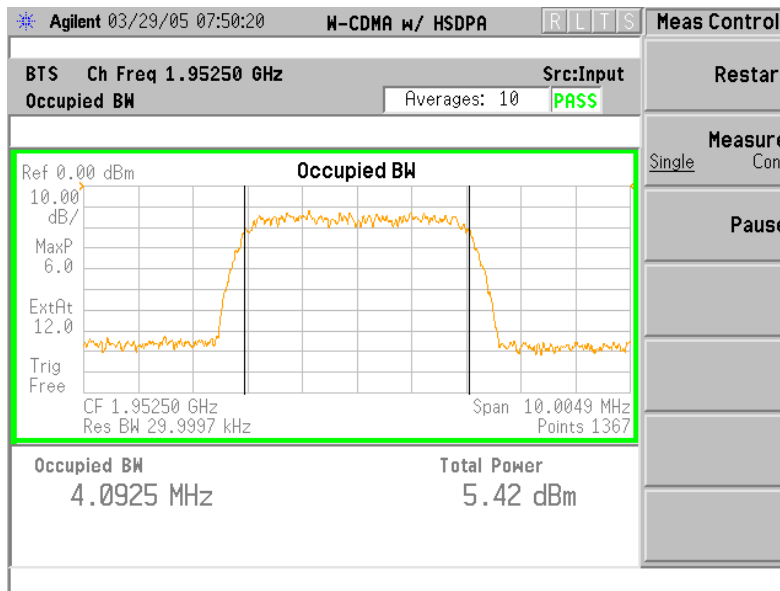

Carrier Bandwidth Characteristics: Frequency Block B, Carrier Channel B3; Sector 3
UMTS1900 Ch 162; 1962.5 MHz at Tx Transmit Terminal at +5 dBm per single 5 MHz carrier

TM1 Modulation with 20 Active Channels

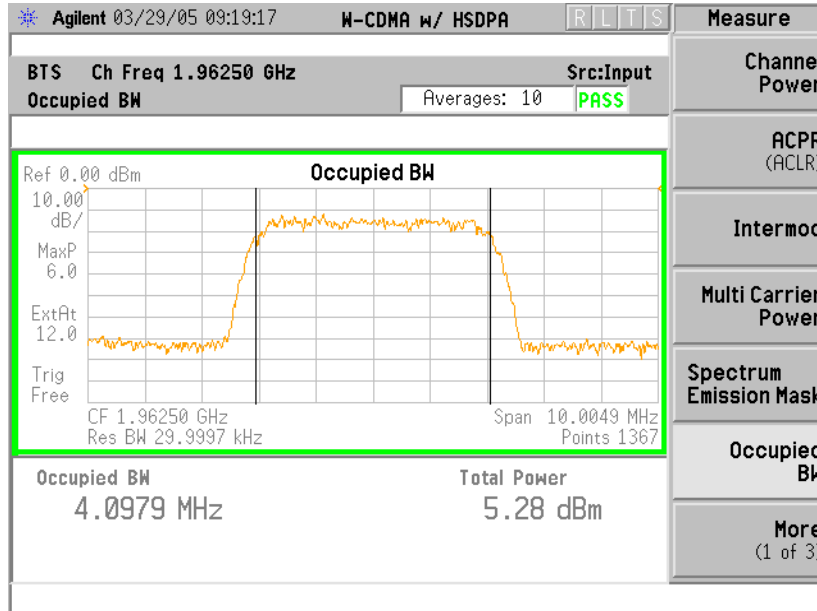

Carrier Bandwidth Characteristics: Frequency Block E, Carrier Channel E; Sector 3
UMTS1900 Ch 187; 1967.5 MHz at Tx Transmit Terminal at +5 dBm per single 5 MHz carrier

TM1 Modulation with 20 Active Channels

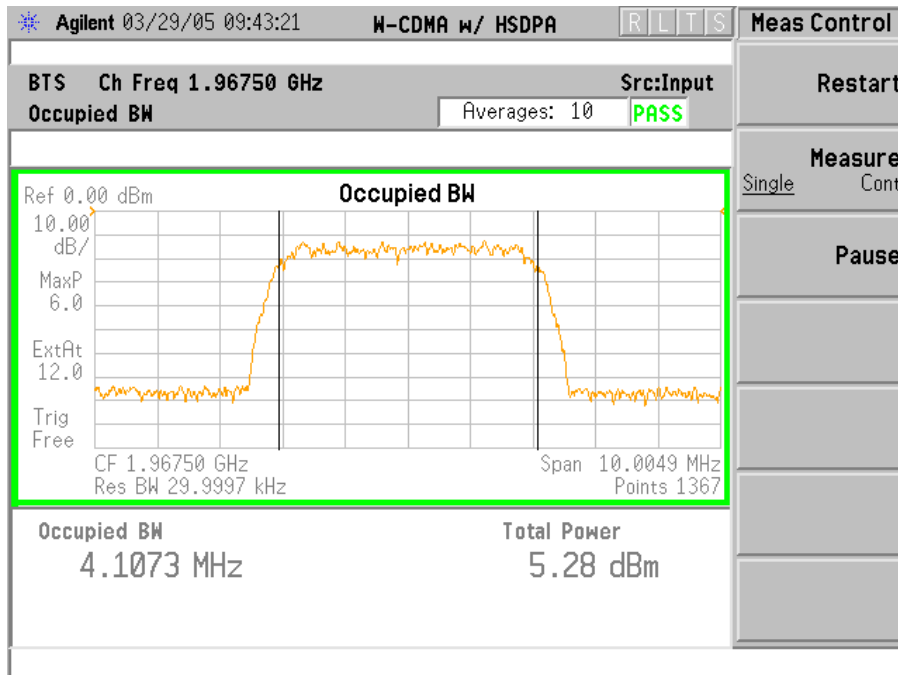

Carrier Bandwidth Characteristics: Frequency Block F, Carrier Channel F; Sector 3
UMTS1900 Ch 212; 1972.5 MHz at Tx Transmit Terminal at +5 dBm per single 5 MHz carrier

TM1 Modulation with 20 Active Channels

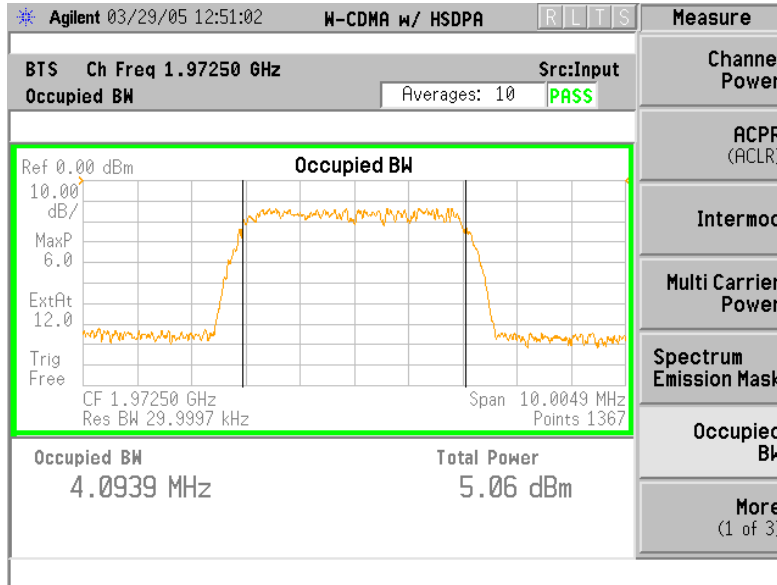

Carrier Bandwidth Characteristics: Frequency Block C, Carrier Channel C3; Sector 3
UMTS1900 Ch 237; 1977.5 MHz at Tx Antenna Terminal at +46 dBm per single 5 MHz carrier

TM1 Modulation with 20 Active Channels

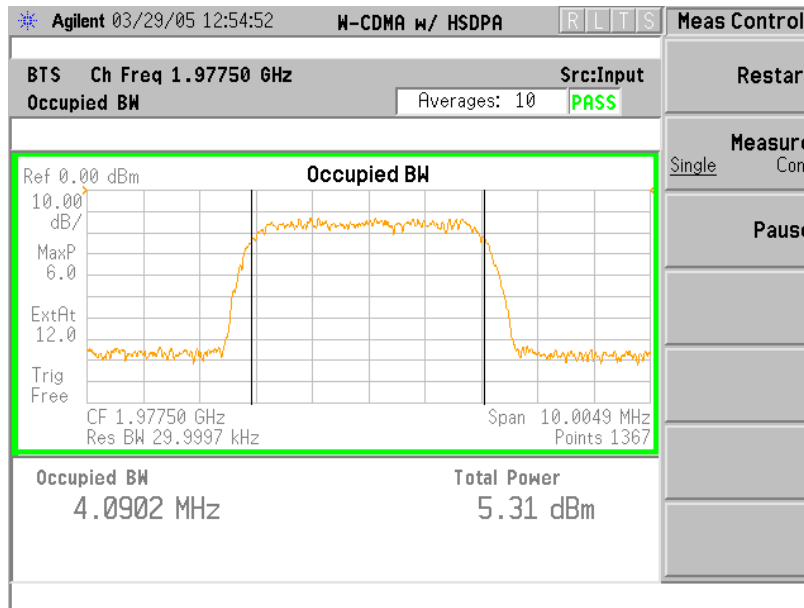

**Carrier Bandwidth Characteristics: Frequency Block C, Carrier Channel C5; Sector 3
UMTS1900 Ch 287; 1987.5 MHz at Tx Transmit Terminal at +5 dBm per single 5 MHz carrier**

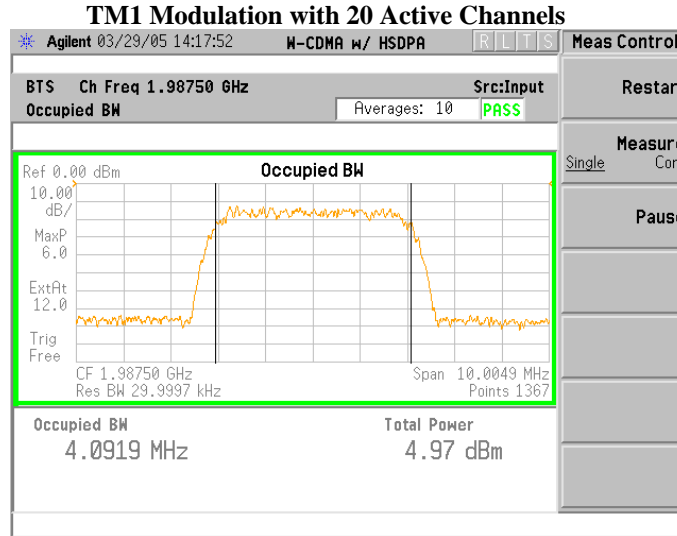

Method 2. Emission mask limitation using a Rohde & Schwarz: Spectrum Analyzer FSEM30 (SN DE35291) with Total Integrated Laboratory Environment (TILE) test software.

Measurement of the occupied bandwidth emission characteristics was performed at the MCPA Transmit Terminal with the 5 MHz carrier set to +5 dBm, and the modulation 1) first set to the full 20 channels/codes as required by ETSI TS 25.141, Test Model 1 (TM1), and then 2) set to TM5 for HSDPA with 24 active channels, for all frequency blocks and the nine carriers. In compliance with Part 24.238, A1/A3, B1/B3 and C3/C5 represented the lowest and the highest settable channels in their respective PCS frequency blocks. Since Blocks D, E and F are 5 MHz wide, a single channel was set to the respective block center frequency. The emission mask used to demonstrate compliance was as specified in ETSI TS 25.141 for P < 31 dBm. The mask attenuation values were based on a 30 kHz resolution bandwidth, which made the modulated 5 MHz carrier to be offset from +5 dBm by -22.2 dB, in accordance with the equation:

$$\text{Carrier Offset} = 10 \log (30 \text{ kHz}/5 \text{ MHz}) = -22.2 \text{ dB}$$

This series of measurements were performed using the EMC software:

Total Integrated Laboratory Environment (TILE)
By Quantum Change/EMC Systems, Inc.

The data/measurement plots for the nine channels, covering HSDPA at 24 active channels, are attached below. For brevity, only one sector plots with HSDPA, as the possible worst case, are shown. There is no visible difference between plots for UMTS TM1 and HSDPA TM5.

Test Set-up and Configuration: Same as previously used for Part 2.1046 RF Power Measurement.

RESULTS: The A1, A3, D, B1, B3, E, F, C3 and C5 channels all demonstrate compliance with the emission mask specified by ETSI TS 25.141 Rel 5; the carriers do not exceed the mask limitation. Compliance is also demonstrated for each PCS frequency block edge requirement specified in Part 24.238.

The data plots showing HSDPA (TM5), with 24 active channels, are attached below.

Occupied Bandwidth Characteristics: Frequency Block A; Carreir/Channel A1
UMTS1900 Ch 12; 1932.5 MHz at Tx Transmit Terminal at +5 dBm per single 5 MHz carrier

High Speed Downlink Packet Access (HSDPA) with 24 Active Channels

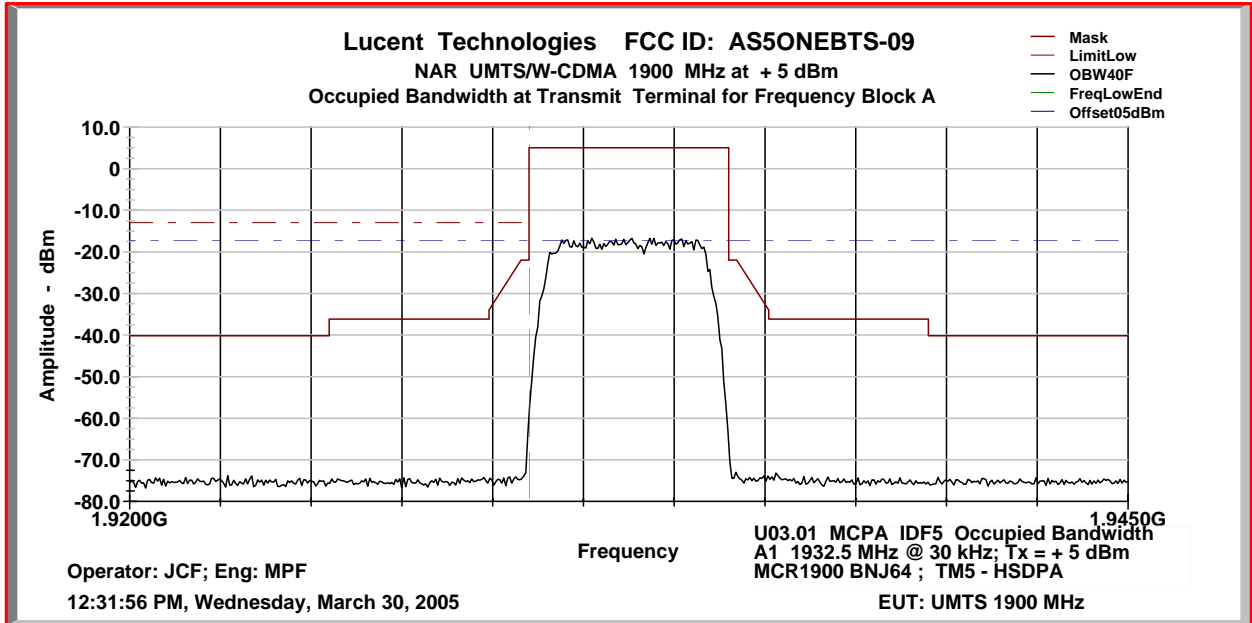

Occupied Bandwidth Characteristics Block A3
UMTS1900 Ch 62; 1942.5 MHz at Tx Transmit Terminal at +5 dBm per single 5 MHz carrier

High Speed Downlink Packet Access (HSDPA) with 24 Active Channels

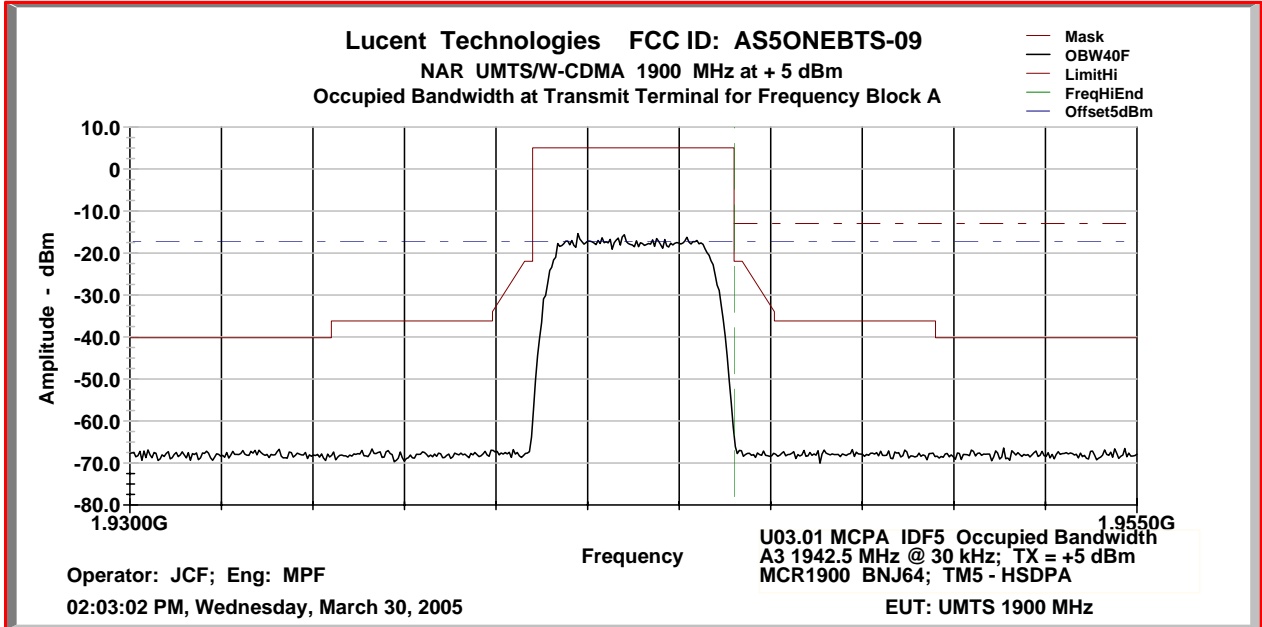

Occupied Bandwidth Characteristics: Frequency Block D; Carrier/Channel D
UMTS1900 Ch 87; 1947.5 MHz at Tx Transmit Terminal at +5 dBm per single 5 MHz carrier

High Speed Downlink Packet Access (HSDPA) with 24 Active Channels

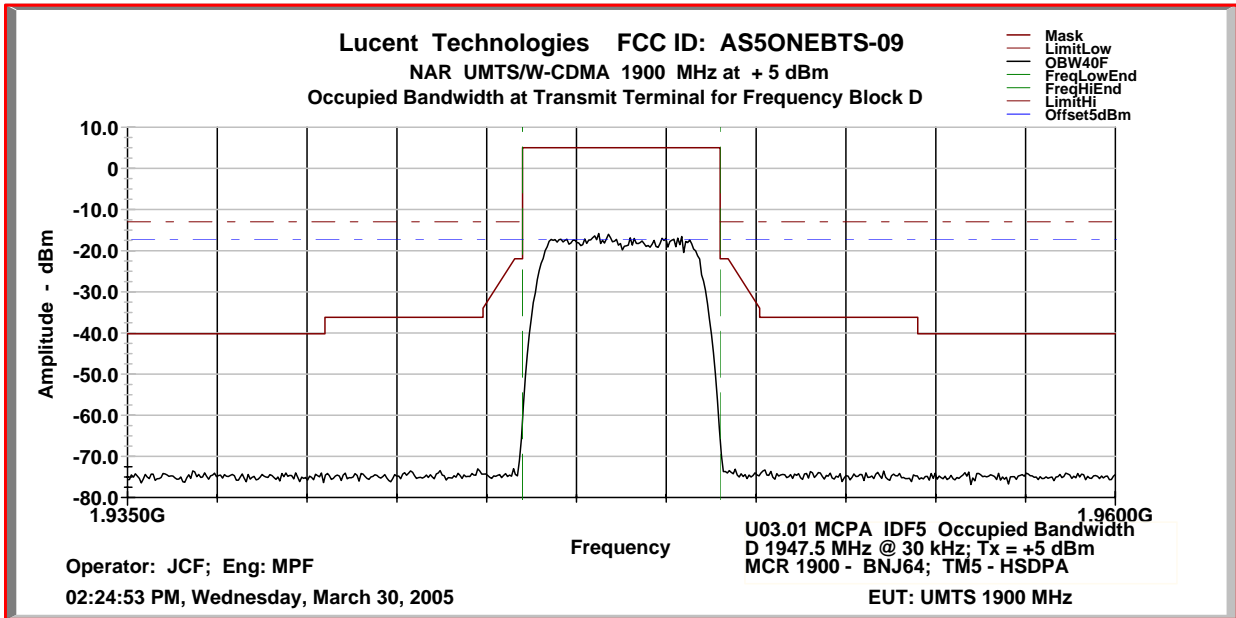

Occupied Bandwidth Characteristics: Frequency Block B, Carrier Channel B1
UMTS1900 Ch 112; 1952.5 MHz at Tx Transmit Terminal at +5 dBm per single 5 MHz carrier

High Speed Downlink Packet Access (HSDPA) with 24 Active Channels

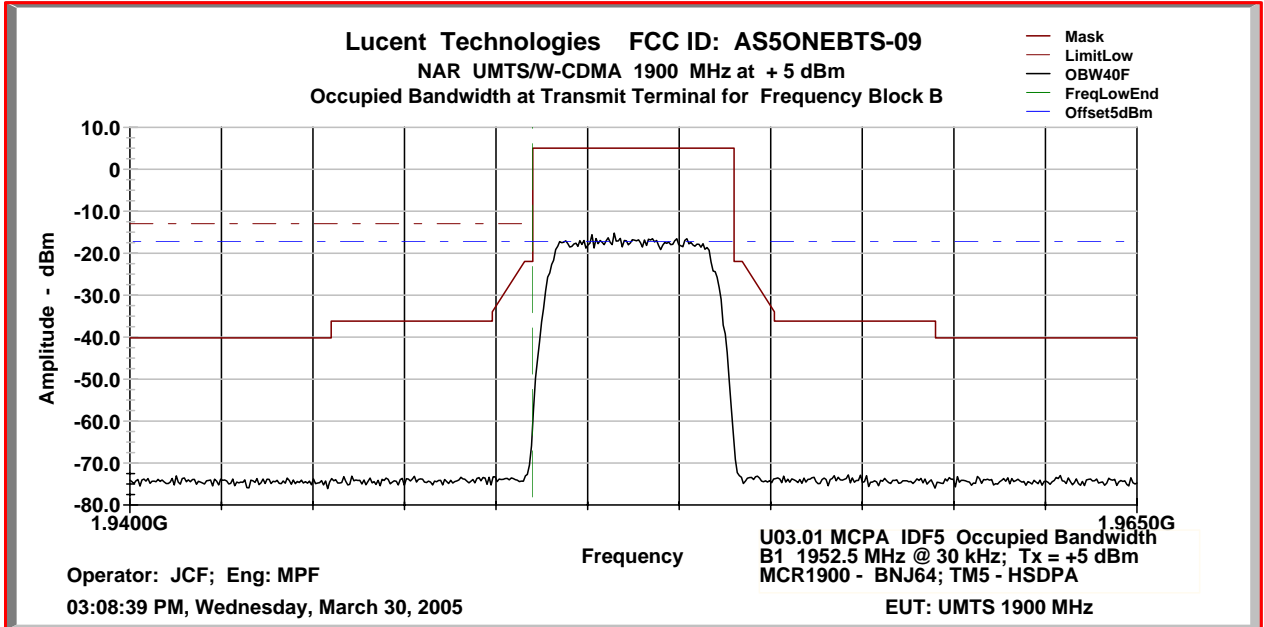

Occupied Bandwidth Characteristics: Frequency Block B, Carrier Channel B3
UMTS1900 Ch 162; 1962.5 MHz at Tx Transmit Terminal at +5 dBm per single 5 MHz carrier

High Speed Downlink Packet Access (HSDPA) with 24 Active Channels

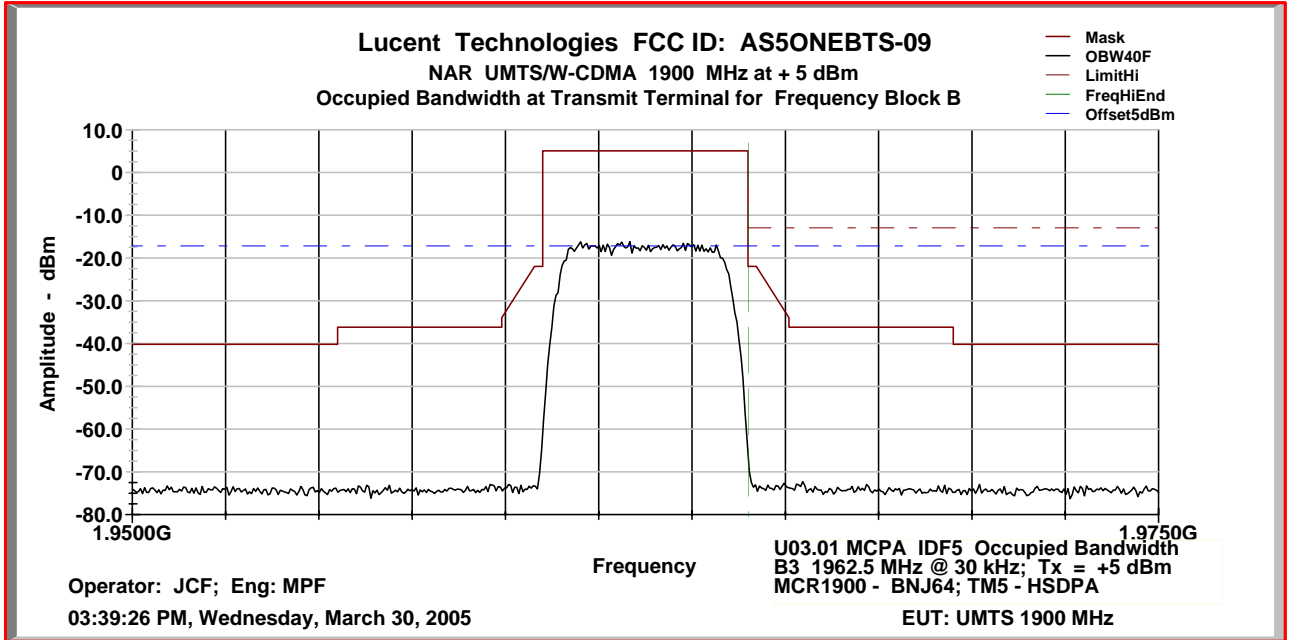

Occupied Bandwidth Characteristics: Frequency Block E, Carrier Channel E
UMTS1900 Ch 187; 1967.5 MHz at Tx Transmit Terminal at +5 dBm per single 5 MHz carrier

High Speed Downlink Packet Access (HSDPA) with 24 Active Channels

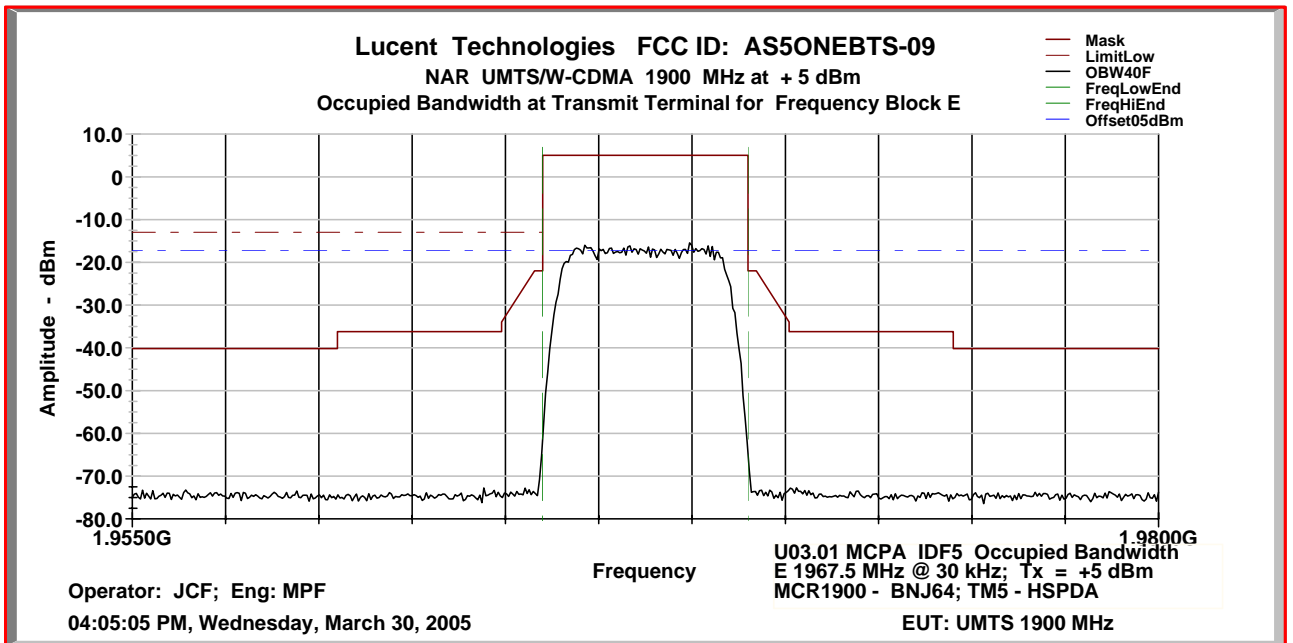

Occupied Bandwidth Characteristics: Frequency Block F, Carrier Channel F
UMTS1900 Ch 212; 1972.5 MHz at Tx Transmit Terminal at +5 dBm per single 5 MHz carrier

High Speed Downlink Packet Access (HSDPA) with 24 Active Channels

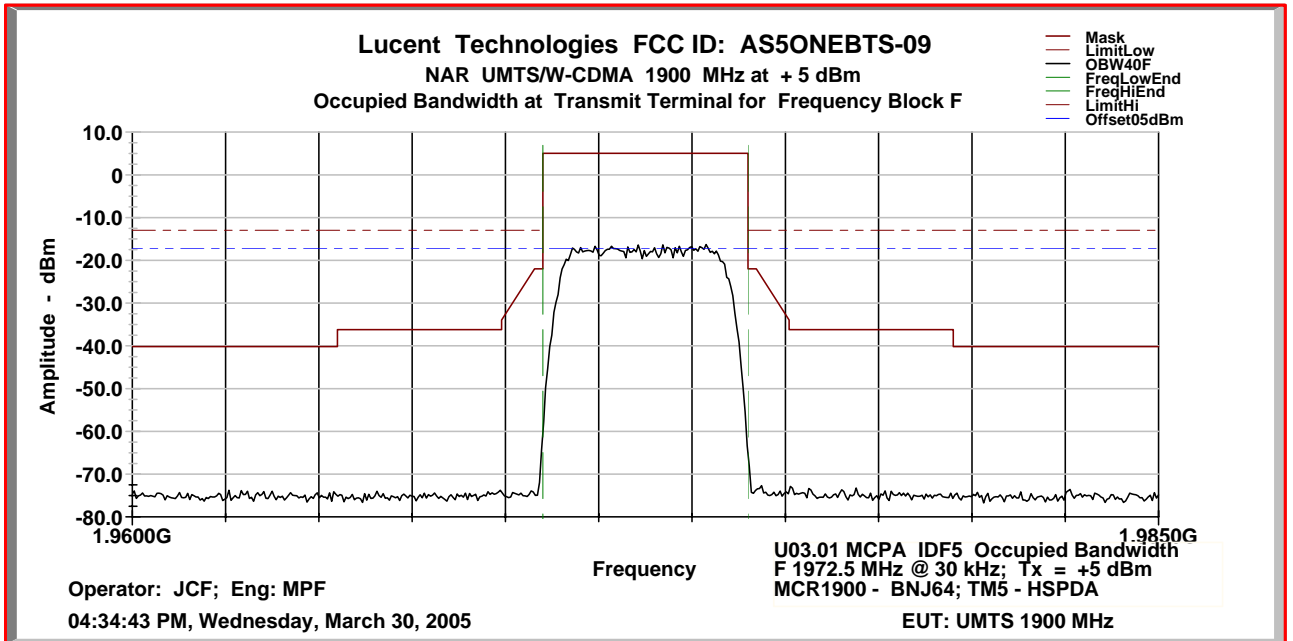

Occupied Bandwidth Characteristics: Frequency Block C, Carrier Channel C3
UMTS1900 Ch 237; 1977.5 MHz at Tx Transmit Terminal at +5 dBm per single 5 MHz carrier

High Speed Downlink Packet Access (HSDPA) with 24 Active Channels

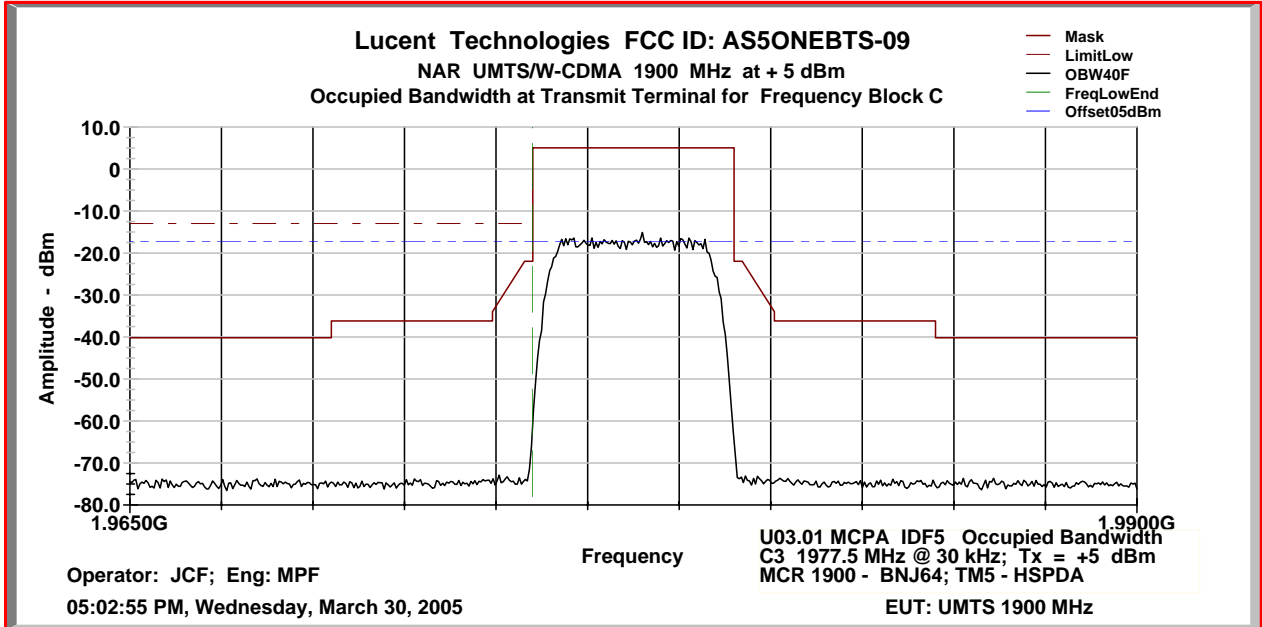

Occupied Bandwidth Characteristics: Frequency Block C, Carrier Channel C5
UMTS1900 Ch 287; 1987.5 MHz at Tx Transmit Terminal at +5 dBm per single 5 MHz carrier

High Speed Downlink Packet Access (HSDPA) with 24 Active Channels

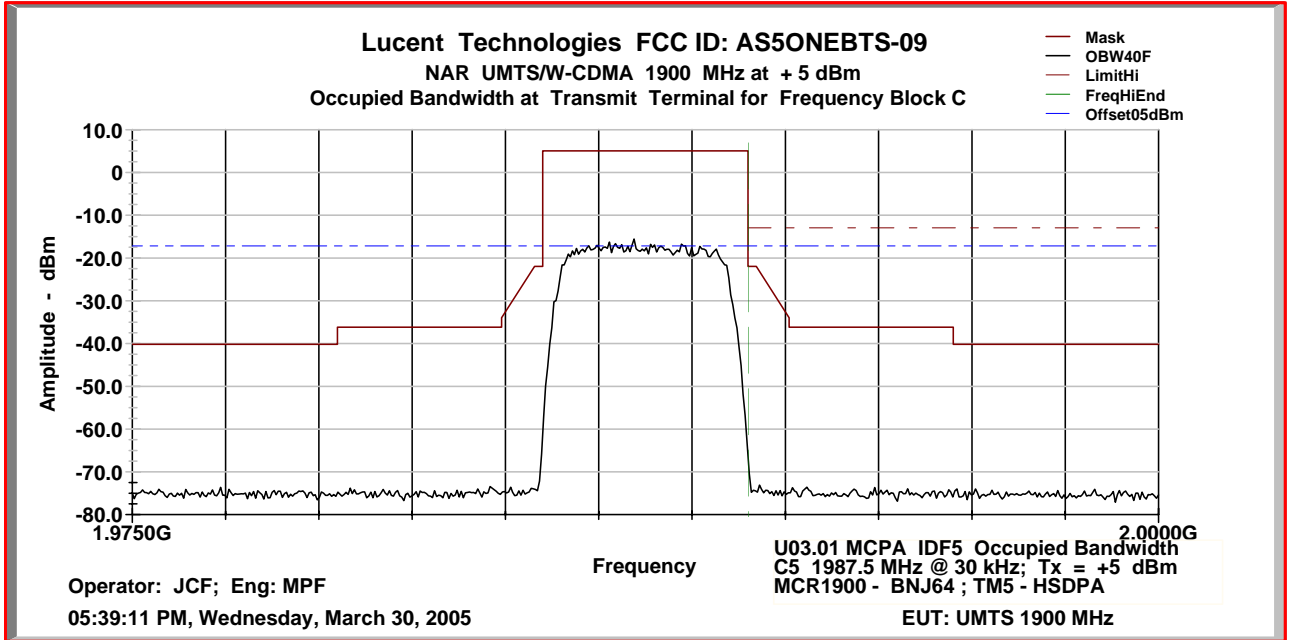

PART 2.1051 MEASUREMENTS REQUIRED: SPURIOUS EMISSIONS AT THE ANTENNA TERMINALS.

This test procedure is an extension of the occupied bandwidth measurement at the MCPA Equipment Transmit Connector Terminal, using the same carrier frequencies, power level setting procedure and modulated carrier offset procedure. In accordance with Part 2.1057(a), the required frequency spectrum to be investigated extends from the lowest RF signal generated to the 10th harmonic of the carrier at the EAC terminal. The emission limits at the transmit terminal (Tx) are specified in Part 24.238 (a) ... the power of any emission shall be attenuated below the transmitter power (P) by at least $43 + 10 \log (P)$ dBc. The power P is the average carrier power measured at the transmit terminal (Tx) in Watts. Setting the power level at Tx to 0.0033 Watts average, produces an emission attenuation below the carrier of 18 dBc. Part 24.238 (b) specifies the required Resolution Bandwidth (RBW) to be 1 MHz. In accordance with Part 2.1051, "the magnitude of spurious emissions which are attenuated more than 20 dB below the permissible value need not be specified"; i.e., these are not reportable. Hence, the measurement equipment must be adjusted and configured to provide an instrumentation noise floor that is at least 20 dB or more below the $43 + 10 \log (P)$ dBc limit, which equates to 38 dBc. The pertinent test parameters are:

1. Frequency Spectrum: 10 MHz to 20 GHz
2. Resolution Bandwidth: 1 MHz (Part 24.238)
3. Emission Limitation: $43 + 10 \log (P)$ dBc = $43 + 10 \log (3.3 \text{ Milliwatts}) = 18 \text{ dBc}$
4. Instrumentation Noise Floor: at least 20 dB greater than " $43 + 10 \log (P)$ dBc" = 38 dBc

Minimum Standard Requirement:

The emission limits at the transmit terminal are specified in Part 24.238 (a) ... the power of any emission shall be attenuated below the transmitter power (P) by at least $43 + 10 \log (P)$ dBc (i.e., attenuation below the unmodulated carrier). The power P is the average carrier power measured at the transmit terminal in Watts. The measurement equipment must be adjusted and configured to provide an instrumentation noise floor that is 20 dB or more below the $43 + 10 \log (P)$ dBc limit. In summary:

1. Carrier Power Level = 5 dBm
2. Emission Limitation = 5 dBm – 18 dBc = -13 dBm
3. Reportable Emission Limit = -13 dBm – 20 dBc = -33.0 dBm
4. Emission power levels less than -33 dBm are not reportable; i.e., at $\geq 38 \text{ dBc}$

Test Set-up and Configuration: Same as previously used for Part 2.1046 RF Power Measurement.

Method of Measurement:

In order to suppress the instrumentation noise floor sufficient to detect and measure spurious signals that have power levels as low as 20 dB below the required limit, or as low as -33 dBm (i.e., 38 dBc), an EMC software package was employed to drive the spectrum analyzer, collect and compile the acquired data, perform mathematical corrections to the data by incorporating (i.e., programming) pre-measured path losses into the software, and then generate a graphical display as shown in this exhibit. The software package is: *TILE/IC (Total Integrated Laboratory Environment/Instrument Control System)*; purchased and licensed from Quantum Change/EMC Systems, Inc. The instrumentation noise floor is suppressed by the software's ability to split the spectrum being measured into many small segments, perform the mathematical corrections to each segment, and then sequentially compile all the segments into a continuous graphical display.

Part 24.238 requires that emissions over the required spectrum 10 MHz to 20 GHz be measured using an instrumentation resolution bandwidth of 1 MHz. The TILE/IC software was able to sufficiently suppress the normally high noise floor associated with 1 MHz RBW by measuring the spectrum in a sequential series of short segments using a peak detector, in combination with an appropriate low-pass filter and then with an appropriate high-pass filter, installed at the input terminal of the spectrum analyzer, to prevent the carrier from over driving the spectrum analyzer. The spectrum portion 1.8 – 2.5 GHz, in close proximity to the carrier, was measured without filters.

The specific EMC test filters used were manufactured by TRILITHIC, Inc., Indianapolis, IN:

1. Low Pass Filter: Model 10LC1790-3-AA; SN 200033011; Product No. 23042
2. High Pass Filter: Model 5HC2850/18050-1-.8-KK; SN 9926050; Product No. 23042

Part 24.238 requires that this test be performed for the lowest settable and for the highest settable carrier frequencies in each PCS frequency block, which are summarized in the following table.

UMTS PCS Frequency Block	Broadband PCS Frequency Block	Power Level at Transmit Terminal	UMTS1900 Channel No.	UMTS 1900 Carrier Center Frequency
A1	Lowest Settable	5 dBm	12	1932.5 MHz
A3	Highest Settable	5 dBm	62	1942.5 MHz
D	Center	5 dBm	87	1947.5 MHz
B1	Lowest Settable	5 dBm	112	1952.5 MHz
B3	Highest Settable	5 dBm	162	1962.5 MHz
E	Center	5 dBm	187	1967.5 MHz
F	Center	5 dBm	212	1972.5 MHz
C3	Lowest Settable	5 dBm	237	1977.5 MHz
C5	Highest Settable	5 dBm	287	1987.5 MHz

Results: Each of the 9 UMTS1900 carriers, shown above, was measured for each of the 2 modulation methods previously discussed: 1) standard UMTS (TM1) QPSK modulation with 20 active channels, and 2) UMTS with TM5 “High Speed Downlink Packet Access” (HSDPA), QPSK + 16QAM modulation, with 24 active channels. The spectrum plots showed no visible distinction between TM1 and TM5. For brevity, the data plots for HSDPA, which could be considered as the worst case condition, are attached to this exhibit. For each UMTS carrier, there were no reportable emissions.

Conducted Emissions Characteristics: Frequency Block A; Carrier/Channel A1
UMTS1900 Ch 12; 1932.5 MHz at Tx Transmit Terminal at +5 dBm per single 5 MHz carrier

High Speed Downlink Packet Access (HSDPA) with 24 Active Channels

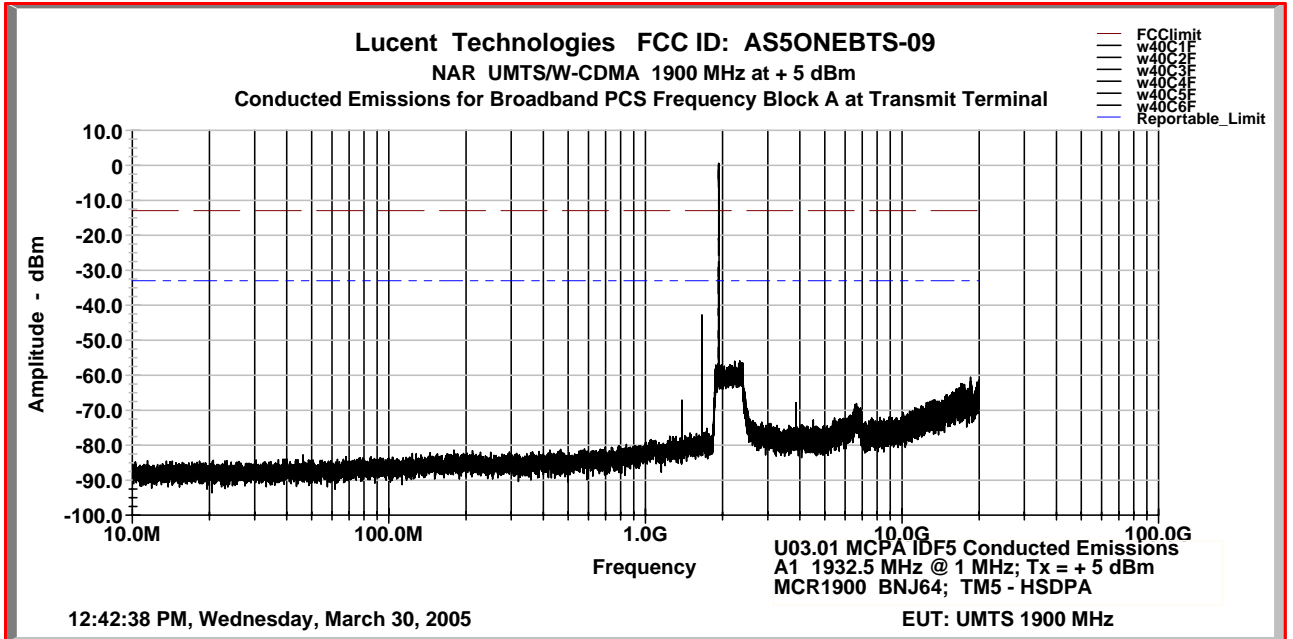

Conducted Emissions Characteristics: Frequency Block A; Carrier/Channel A3
UMTS1900 Ch 62; 1942.5 MHz at Tx Transmit Terminal at +5 dBm per single 5 MHz carrier

High Speed Downlink Packet Access (HSDPA) with 24 Active Channels

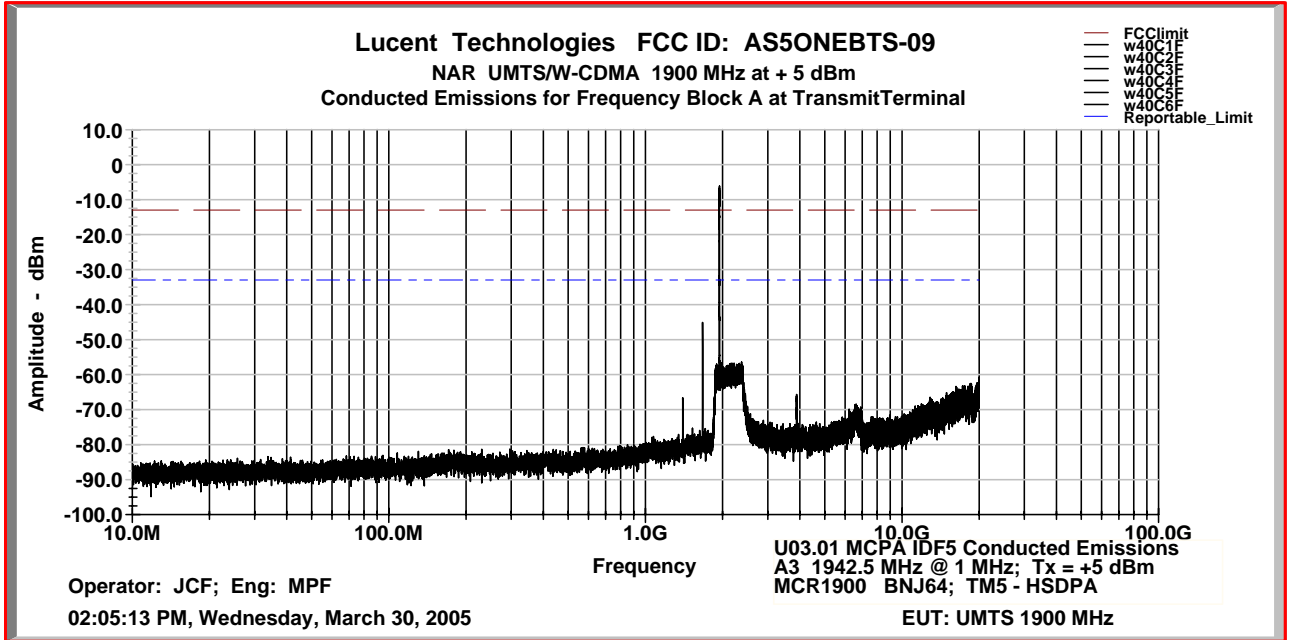

Conducted Emissions Characteristics: Frequency Block D; Carrier/Channel D
UMTS1900 Ch 87; 1947.5 MHz at Tx Transmit Terminal at +5 dBm per single 5 MHz carrier

High Speed Downlink Packet Access (HSDPA) with 24 Active Channels

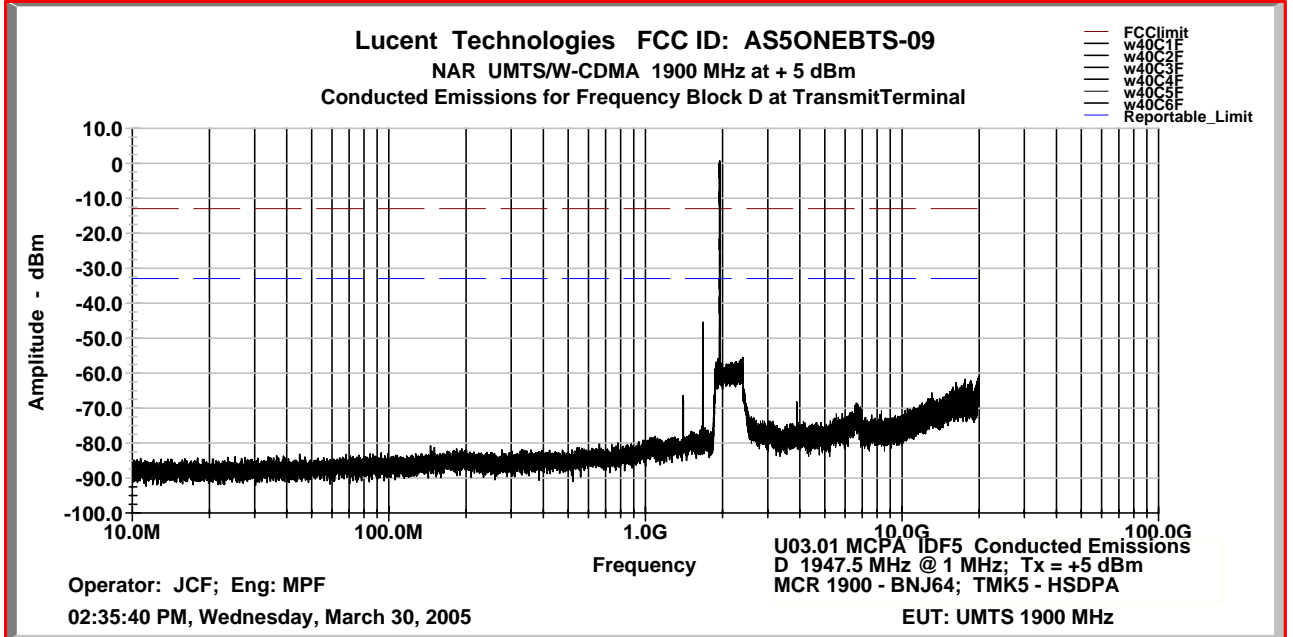

Conducted Emissions Characteristics: Frequency Block B, Carrier Channel B1
UMTS1900 Ch 112; 1952.5 MHz at Tx Transmit Terminal at +5 dBm per single 5 MHz carrier

High Speed Downlink Packet Access (HSDPA) with 24 Active Channels

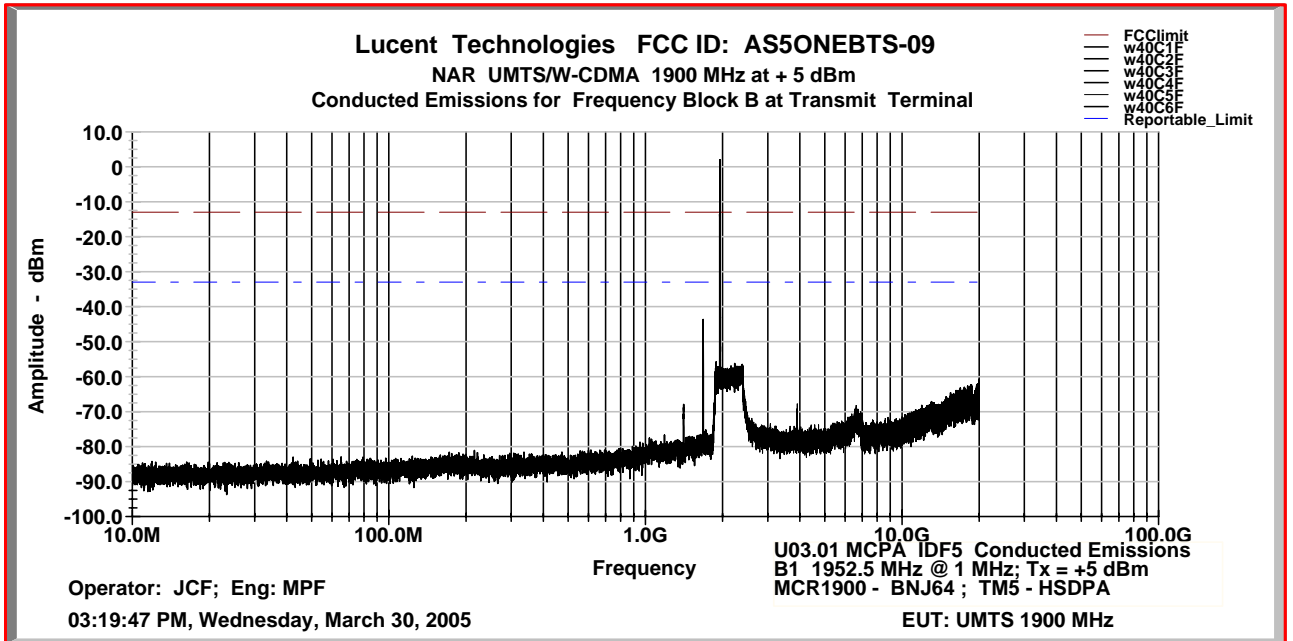

Conducted Emissions Characteristics: Frequency Block B, Carrier Channel B3
UMTS1900 Ch 162; 1962.5 MHz at Tx Transmit Terminal at +5 dBm per single 5 MHz carrier

High Speed Downlink Packet Access (HSDPA) with 24 Active Channels

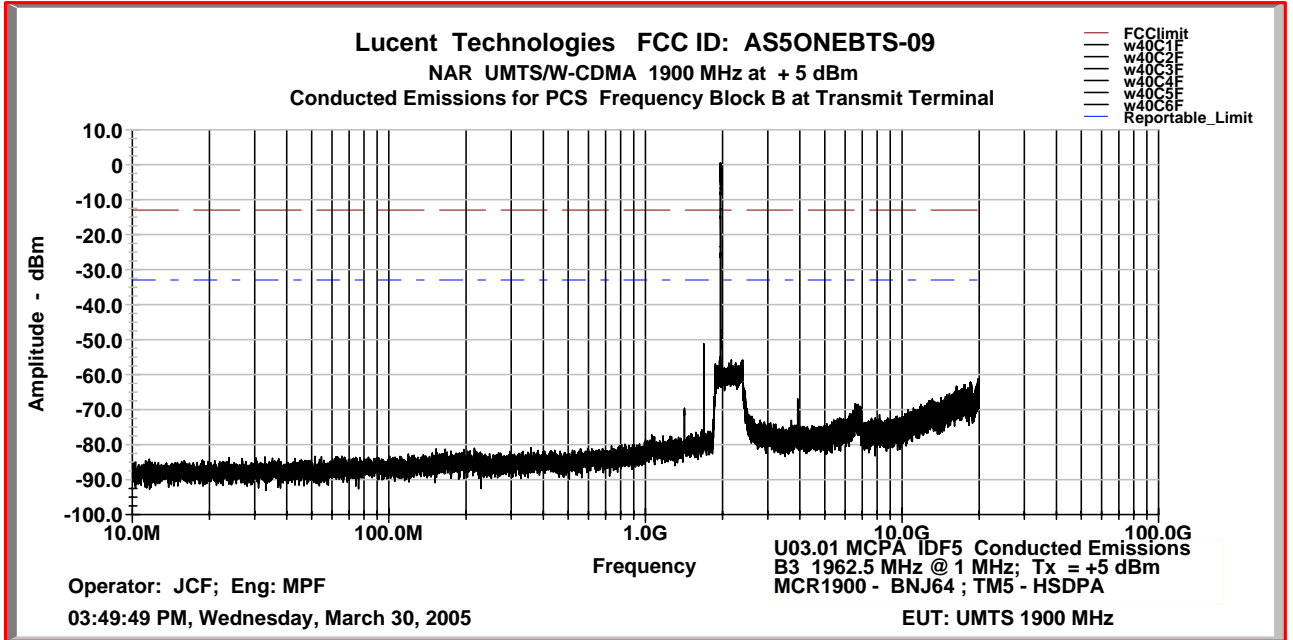

Conducted Emissions Characteristics: Frequency Block E, Carrier Channel E
UMTS1900 Ch 187; 1967.5 MHz at Tx Transmit Terminal at +5 dBm per single 5 MHz carrier

High Speed Downlink Packet Access (HSDPA) with 24 Active Channels

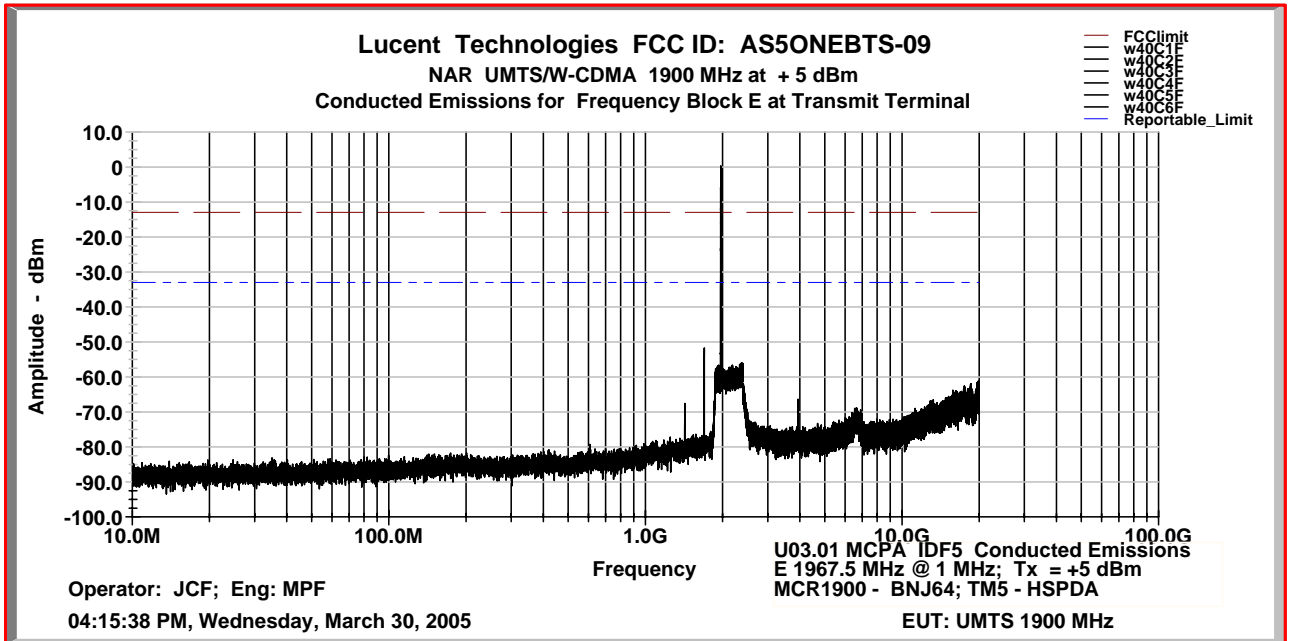

Conducted Emissions Characteristics: Frequency Block F, Carrier Channel F
UMTS1900 Ch 212; 1972.5 MHz at Tx Transmit Terminal at +5 dBm per single 5 MHz carrier

High Speed Downlink Packet Access (HSDPA) with 24 Active Channels

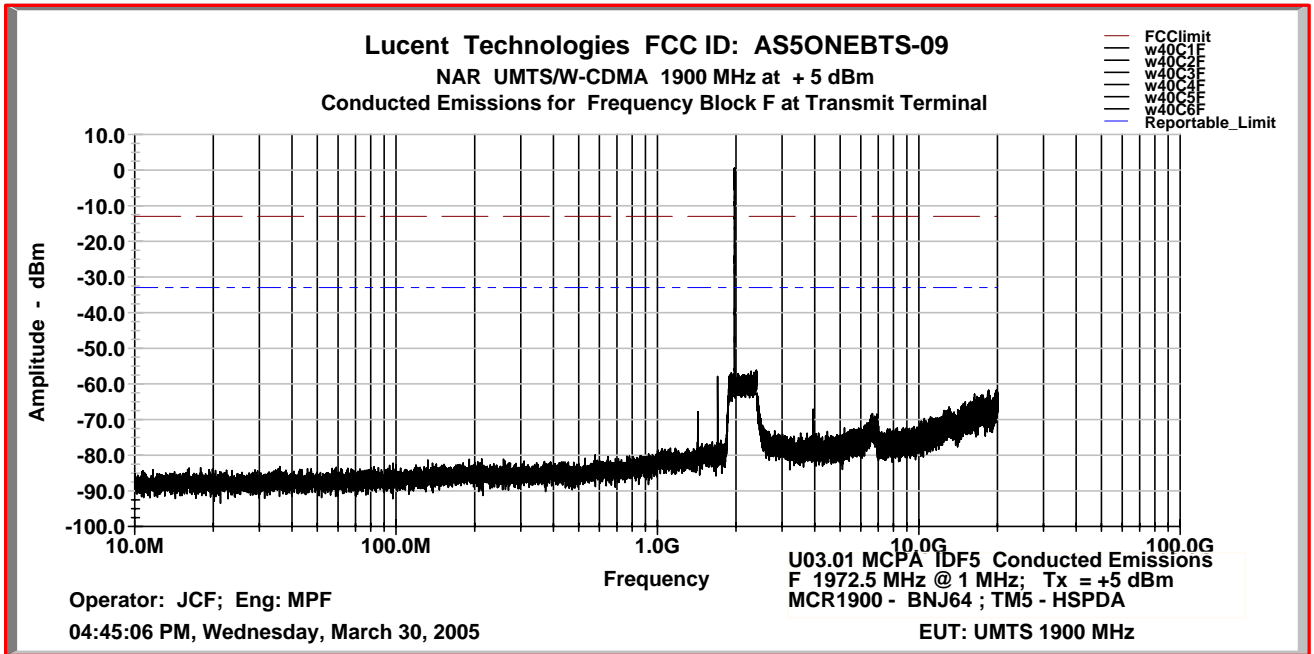

Conducted Emissions Characteristics: Frequency Block C, Carrier Channel C3
UMTS1900 Ch 237; 1977.5 MHz at Tx Transmit Terminal at +5 dBm per single 5 MHz carrier

High Speed Downlink Packet Access (HSDPA) with 24 Active Channels

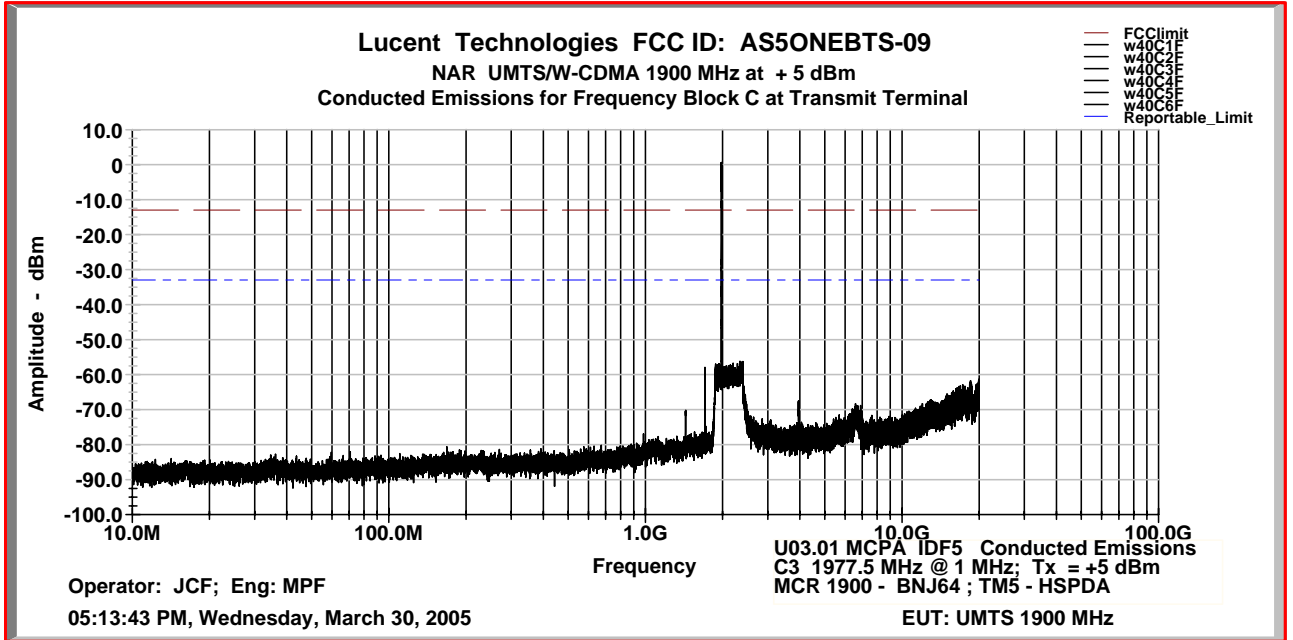

Conducted Emissions Characteristics: Frequency Block C, Carrier Channel C5
UMTS1900 Ch 287; 1987.5 MHz at Tx Transmit Terminal at +5 dBm per single 5 MHz carrier

High Speed Downlink Packet Access (HSDPA) with 24 Active Channels

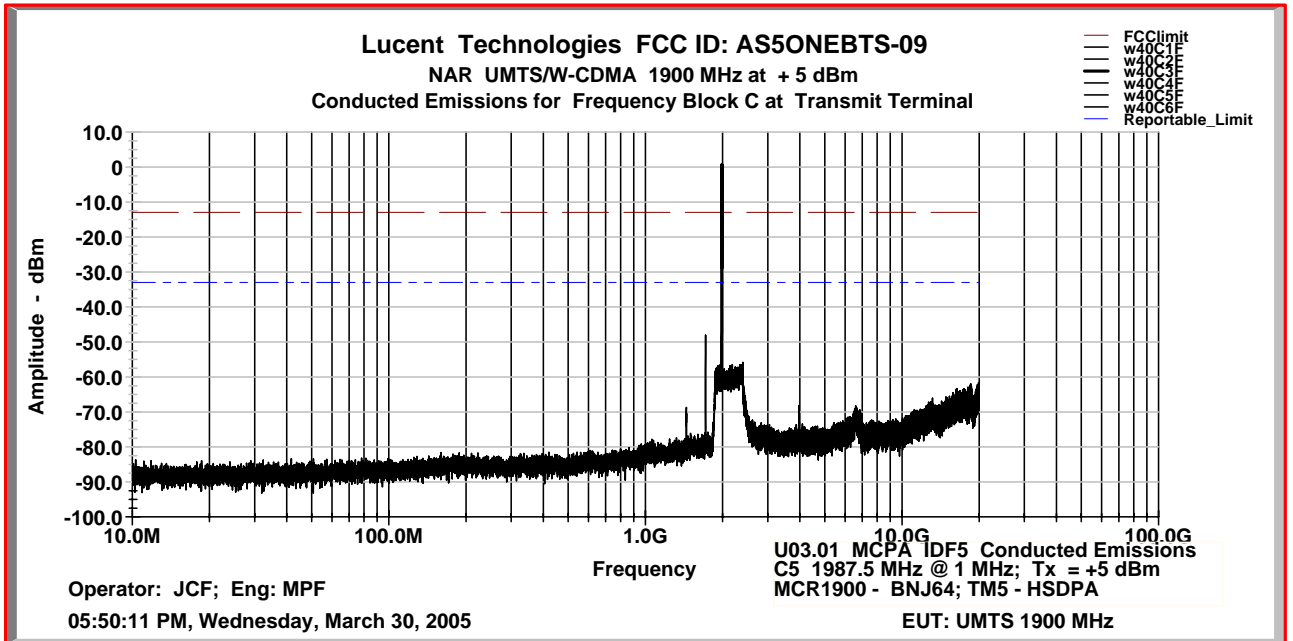

PART 2.1055 MEASUREMENTS REQUIRED: FREQUENCY STABILITY

The frequency stability was previously measured at the Equipment Antenna Terminal (EAC) and at the MCR1900 transceiver output terminal for a single carrier set B3 (1962.5 MHz). Frequency stability measurements were performed by M. Coelho, Lucent Technologies, Swindon, United Kingdom, under the direction of M. P. Farina, and in adherence to the previously cited ISO/TL9000 test plan. This test program was conducted during the approximate interval February 3 to March 15, 2005. These tests were performed twice for each of two crystal reference oscillator (OMA) manufacturers. The complete test reports are attached, which show the test results, test equipment configuration and photographs of the test set-up.

The procedure required by the FCC is specified in CFR 47, Part 2, Subpart J – Equipment Authorization Procedures, Section 2.1055 – Measurements Required: Frequency Stability, Effective: October 01, 2004. The requirements for base station/land station equipment, are summarized as:

Section 2.1055(a)(1): The frequency stability shall be measured with variation of ambient temperature from -30°C to $+50^{\circ}\text{C}$

Section 2.1055(b): Frequency measurements shall be made at the extremes of the specified temperature range and at intervals of not more than 10°C through the range. A period of time sufficient to stabilize all of the components of the oscillator circuit at each temperature level shall be allowed prior to frequency measurement. The short term transient effects on the frequency of the transmitter due to keying (except for broadcast transmitters) and any heating element cycling normally occurring at each ambient temperature level also shall be shown. (*Note: The term “keying” does not apply to base station/land station equipment. “Heating element” applies to “heat cartridges” if used .*) Only the portion or portions of the transmitter containing the frequency determining and stabilizing circuitry need be subjected to the temperature variation test.

Section 2.1055(d)(1): The frequency stability shall be measured with variation of primary supply voltage from 85% to 115% of the nominal value.

Frequency Stability Limitation:

The frequency stability is the measurement of the carrier center frequency deviation from its assigned value as a function of (1) temperature variation from -30°C to $+50^{\circ}\text{C}$, in $+10^{\circ}\text{C}$ increments, and (2) variation of supply voltage, at the equipment frame power input terminals, from 85% to 115% of the nominal value. This is a lengthy procedure and is performed one time with a single UMTS carrier set to the A1 channel (1932.5 MHz). The required tolerance limit for UMTS 1900 base station/land station equipment is specified in ETSI TS 25.141 as ± 0.05 ppm.

Results:

The PCS UMTS-CDMA “Multi-Carrier CDMA Radio” (MCR1900), Model BNJ64, the subject of this application for a Class II Permissive Change Authorization, under FCC ID: AS5ONEBTS-09, demonstrated full compliance with the requirements of FCC Rule Part 2.1055. The frequency stability for all measurements were well within the required ± 0.05 ppm, as shown in detail in the two attached Test Reports. The “External Multi-Carrier Power Amplifier” (MCPA) wireless base station equipment frame configuration is equally compliant.

UMTS
Node B Compliance
03.01
FEI OMA
Test Report

Flexent[®] UMTS Macrocell

FCC 47 CFR 2.1055

Number:
Issue: 0.01
Status: Draft

Author: Michael Coelho
Date: 25 February 2005

Summary

This report describes the FCC 47 CFR 2.1055 tests completed on the Flexent UMTS Macrocell to verify compliance of the FEI OMA.

Functional tests were scheduled during the thermal test conditioning.

The test results showed that when the equipment was powered up all functional tests passed. These were:

Frequency Error

OMA Frequency Stability

CONTENTS

1.	Summary.....	41
2.	Object.....	43
3.	Introduction.....	43
3.1	Glossary.....	43
3.2	Scope.....	43
3.3	Specifications.....	43
3.4	Standards.....	43
4.	Equipment.....	43
4.1	Under Test.....	43
4.2	Test Equipment.....	43
5.	Test Procedure.....	44
5.1	Test Set up.....	44
5.2	Test Parameters.....	44
5.3	Functional Tests.....	45
6.	Results.....	45
7.	Conclusions.....	46
	APPENDIX A.....	47
	APPENDIX B.....	48
	APPENDIX C.....	48
	APPENDIX D.....	49

Object

This test was carried out to determine the frequency stability of the FEI OMA in the Flexent® UMTS Macrocell Outdoor (3S1C 40 Watt) equipped cabinet over the temperature range -30°C to 50°C and at voltage extremes of +/- 15% from nominal (230V).

Introduction

This document contains the results of the FCC 47 CFR 2.1055 tests carried out on the Flexent® UMTS Macrocell to:

[3.3.1] Project Liberty NAR UMTS/W-CDMA 1900, Federal Communications Commission (FCC) Certification Test Plan For OneBTS UMTS/W-CDMA Wideband Transceiver UCR1900 Under FCC ID: AS5ONEBTS-01 And OneBTS UMTS/W-CDMA Power Amplifier PkLAM KS-24638 L1

Under FCC ID: AS5ONEBTS-02 by Michael P. Farina

Also included are lists showing the ancillary test equipment, equipment under test and functional tests conducted.

-22. Glossary

A/C	Alternating Current
°C	Degree Celsius
ETSI	European Telecommunications Standards Institution
HIOU	Hybrid Input Output Unit
Node B	UMTS Base Station
OMA	Oscillator Module
RH	Relative Humidity
RX	Receive
SRD	System Requirement Definition
TX	Transmit
MCR	Multi Carrier Radio
UCU	Universal Channel Unit
UDT	UMTS Diagnostic Tool
UMTS	Universal Mobile Telecommunication System
3S1C 40W	Three Sector, One Carrier, Forty Watt System

Scope

This test was applied to the Flexent® UMTS Macrocell as per product specification [3.3.2] (3S1C 40Watt) equipped cabinet. It was configured to released 03.01.

Specifications

[3.3.1] Project Liberty NAR UMTS/W-CDMA 1900, Federal Communications Commission (FCC), Certification Test Plan For OneBTS UMTS/W-CDMA Wideband Transceiver UCR1900, Under FCC ID: AS5ONEBTS-01 And OneBTS UMTS/W-CDMA Power Amplifier, PkLAM KS-24638 L1 Under FCC ID: AS5ONEBTS-02

[3.3.2] Agile - Document Number KS-24705 (L100) – OneBTS Compact Cell Outdoor Cabinet IRD-UTRAN-UTR-1 VERSION3.1

Standards

[3.4.3] ESTI TS 125 141 V5.8.0 (2003-12) Release 5

[3.4.4] Title 47--Telecommunication 47 Part 2 -- Frequency Allocations and Radio Treaty Matters; General Rules and Regulation, 2.1055 Measurements required: Frequency stability.

Equipment

-22. Under Test

The Flexent® UMTS Macrocell (3S1C 40Watt) equipped cabinet was equipped with hardware as listed in Appendix A - Table 4.0.

Appendix A contains the full list of equipment under test, together with their serial numbers.

-21. Test Equipment

The test equipment used to perform the investigation has been documented in Appendix B - Table 5.0

Figure 1.0 shows a schematic view of the test equipment layout

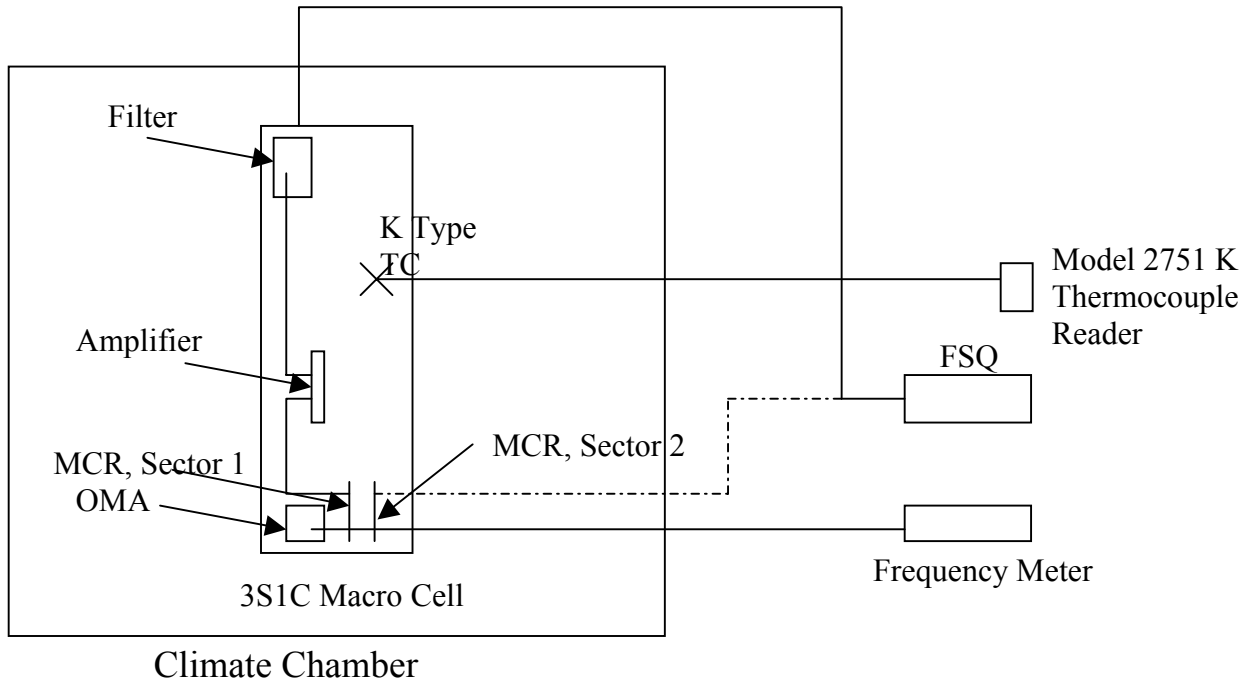

Figure 1.0 – Schematic Layout of Test Equipment

Test Procedure

-22. Test Set up

Prior to starting, the hardware was installed into the cabinet as per specification [3.3.2] and configured to U03.01 release.

Note: The cabinet was installed onto its plinth arrangement (optional) and then secured to a transportation pallet (for ease of installation and transportation into the thermal test chamber) during thermal test conditioning.

Test Parameters

- a) Points of Measurement:
 - i) The MCR measured at its RF output terminal
 - ii) The EAC transmit antenna terminal
 - iii) The Oscillator Module measured at its 15 MHz output terminal.
- b) Carrier Modulation:
 - Test Model 1 (Pmax = 46dBm)
 - Test Model 4 (Pmax – 18dB = 28dBm)
- c) Test Frequencies:
 - The FCC accepts a single test frequency, B3 - 1962.5 MHz
- d) Carrier Power Level:
 - The transmit EAC terminal with the power level adjusted to +46 dBm (40 W).
 - The transmit power level at the MCR TX port adjusted to +5 dBm (40 W).

e) Temperature Range Variation of ambient temperature from –30°C to +50°C. Stabilized at increments of 10°C.

f) Supply Voltage Variation:

Input Supply Voltage	AC Input Voltage
85 % of Nominal	195.5 Vac
100 % of Nominal	230.0 Vac
115 % of Nominal	264.5 Vac

Table 1 Supply Voltage Variation

Functional Tests

Functional tests were carried out during thermal conditioning at stabilized temperatures. Measurement of Frequency Error and OMA Frequency Stability were taken

The universal diagnostic tool (UDT) used to perform the tests was version 3.0.0.

Results

Stabilized Temperature °C	Meas. Freq. 85 % Nom. Hz	Deviation 85 % Nom. ppm	Meas. Freq. 100 % Nom. Hz	Deviation 100 % Nom. ppm	Meas. Freq. 115 % Nom. Hz	Deviation 115 % Nom. ppm
- 30°C	-0.03	-0.002	-0.03	-0.002	-0.03	-0.002
- 20°C	-0.03	-0.002	-0.03	-0.002	-0.03	-0.002
- 10°C	-0.03	-0.002	-0.03	-0.002	-0.03	-0.002
0°C	-0.03	-0.002	-0.03	-0.002	-0.03	-0.002
+ 10°C	-0.01	-0.0007	-0.01	-0.0007	-0.01	-0.0007
+ 20°C	-0.01	-0.0007	-0.01	-0.0007	-0.01	-0.0007
+ 30°C	-0.01	-0.0007	-0.01	-0.0007	-0.01	-0.0007
+ 40°C	-0.01	-0.0007	-0.01	-0.0007	-0.01	-0.0007
+ 50°C	-0.01	-0.0007	-0.01	-0.0007	-0.01	-0.0007

Table 2 FCC 47 CFR 2.1055 OMA Stability

Testing Temp	Voltage Variation	EAC		MCR2	
		TM1 Pmax	TM4 Pmax – 18dBm	TM1Pmax	TM4Pmax – 18dBm
-30 °C	- 15%	-31.7 Hz 46.0 dBm	-19.3Hz 27.4 dBm	-38 Hz 4.9 dBm	-36.5 Hz -13.1 Bm
	Nominal	-20.6 Hz 46.4 dBm	-19.2 Hz 27.3 dBm	44 Hz 4.9 dBm	-43 Hz -13.2 Bm
	+15%	-20.4 Hz 46.0 dBm	-23.4 Hz -27.3 Bm	-43 Hz 5.1 dBm	-43.1 Hz -13.3 Bm
-20 °C	- 15%	-16.4 Hz 45.9 dBm	-20.5 Hz 27.3 dBm	-28Hz 4.9 dBm	29.9 Hz -13.3 Bm
	Nominal	25.4 Hz 45.8 dBm	-22.1 Hz 27.3 dBm	25 Hz 4.8 dBm	-31.3 Hz -13.3 Bm
	+15%	-15.6 Hz 45.9 dBm	-20.2 Hz 27.4 dBm	-43 Hz 4.8 dBm	-42.4 Hz -13.2 Bm

-10 °C	- 15%	28.8 Hz 46.0 Bm	-22.6 Hz 27.3 dBm	26.7 Hz 4.8 dBm	28.6 Hz -13.2 Bm
	Nominal	22.0 Hz 45.4 dBm	-24.5 Hz 27.3 dBm	-32.0 Hz 4.8 dBm	-30.5 Hz -13.3 Bm
	+15%	17.8 Hz 46.0 Bm	-26.5 Hz 27.3 dBm	-30.4 Hz 4.8 dBm	32.6 Hz -13.3 Bm
0 °C	- 15%	-19.8 Hz 45.7 Bm	-19.0 Hz 27.3 dBm	24.5 Hz 4.8 dBm	28.3 Hz -13.3 Bm
	Nominal	18.6 Hz 46.0dBm	-14.7 Hz 27.3 dBm	-32.7Hz 4.8 Bm	-23.7 Hz -13.3 Bm
	+15%	19.4 Hz 45.9 Bm	19.2 Hz -27.2 Bm	-16.5 z 4.8 dBm	-27.4 Hz -13.3 Bm
10 °C	- 15%	-22.3 Hz 45.8 dBm	-18 Hz 27.4 dBm	31 Hz 5.0 dBm	-30.1 Hz -13.2 Bm
	Nominal	21.4 Hz 45.9 dBm	-20Hz 27.3 dBm	30 Hz 5.0 dBm	-38.8 Hz -13.2 Bm
	+15%	19.4 Hz 45.9 dBm	-23 Hz 27.3 dBm	30 Hz 5.0 dBm	-31.4 Hz -13.1 Bm
20 °C	- 15%	-17.4 Hz 45.9 dBm	-16 Hz 27.5 dBm	37 Hz 5.1 dBm	-35.5 Hz -13.0 Bm
	Nominal	-17.4 Hz 45.9 dBm	-17 Hz 27.5 dBm	34 Hz 5.0 dBm	-37.8 Hz -13.1 Bm
	+15%	15.7 Hz 45.9 dBm	-17 Hz 27.5 dBm	29 Hz 5.0 dBm	-31.4 Hz -13.0 Bm
30 °C	- 15%	-17.8 Hz 46.3 dBm	-16 Hz 28.1 dBm	35 Hz 4.9 dBm	-43.4 Hz -12.8 dBm
	Nominal	-17.8 Hz 46.3 dBm	-16 Hz 28.1 dBm	35 Hz 4.9 dBm	-43.4 Hz -12.8 dBm
	+15%	-17.8 Hz 46.3 dBm	-16 Hz 28.1 dBm	35 Hz 4.9 dBm	-43.4 Hz -12.8 dBm
40 °C	- 15%	17.7 Hz 46.6 dBm	-28 Hz 28.4 dBm	-39.6 Hz 5.0 dBm	40.3 Hz -12.8 dBm
	Nominal	17.7 Hz 46.6 dBm	-28 Hz 28.4 dBm	-39.6 Hz 5.0 dBm	40.3 Hz -12.8 dBm
	+15%	17.7 Hz 46.6 dBm	-28 Hz 28.4 dBm	-39.6 Hz 5.0 dBm	40.3 Hz -12.8 dBm
50 °C	- 15%	-22 Hz 46.8 dBm	22 Hz 28.3 dBm	-37.6 Hz 5.0 dBm	39.8 Hz -12.6 dBm
	Nominal	-22 Hz 46.8 dBm	-22 Hz 28.3 dBm	-37.6 Hz 5.0 dBm	39.8 Hz -12.6 dBm
	+15%	-22 Hz 46.8 dBm	-22 Hz 28.3 dBm	-37.6 Hz 5.0 dBm	39.8 Hz -12.6 dBm

Table 3 FCC 47 CFR 2.1055 Frequency Error Measurement

Conclusions

The FEI OMA meets the FCC Title 47 Part 2.1055 Frequency stability requirements.

APPENDIX A

Equipment Under Test

Table 4 details the Node B hardware.

BTS Element	Comcode	Serial number	Comment
Cabinet	848917933 01	HN4 0; 0133	---
Filter panel	408889947	04C812002170	Dual Duplexor #1
Filter panel	408805406	037D08005202	Dual Duplexor #2
Filter panel	408805406	037D08005299	Dual Duplexor #3
PAM	408837490	04BG58110011	PAM #1, Andrews
PAM	408837490	04BG58110023	PAM #2, Andrews
PAM	408837490	034X08501048	PAM #3 Andrews
MCR	201245289	04VC1U60C016	1900A BNJ 64 S0:8 P4.0
MCR	201245289	04VC1U60C011	1900A BNJ 64 S0:8 P4.0
MCR	201245289	04VC1U60C008	1900A BNJ 64 S0:8 P4.0
CTU	---	O2CE02133557	Agile, rev 004
UCU	201173276	03J601880025	UCU #1
UCU	201173276	03J601880014	UCU #2
URC	---	0060100088E5	Agile, rev 004
Oscillator Module	408886042	04P063087638	---
CPC-A	408646040	01T767002002	CPC-A #1
CPC-B	408646032	01T766001681	CPC-B #1
CPC-B	408646032	01T766001685	CPC-B #2

Table 4 – Equipment Under Test

APPENDIX B

Test Equipment

Table 5 details the test equipment used to conduct the testing.

Equipment	Make & Model Number	Serial Number	Calibration
Thermal Chamber	Design Environmental	84905	SEPT 05
Universal Frequency Counter	Fluke PM6685R	SM668746	DEC05
Signal Analyser	Rohde & Schwarz – FSQ 3	1155.5001.03	FEB 08
Power Signal Analyser	Agilent – E4440A	MY44303412	JAN 06

Table 5 – Test Equipment

APPENDIX C

Functional Tests

Lucent Technologies Inc. - Proprietary
Use pursuant to Company Instructions.

The following functional tests were carried out during thermal conditioning. These functional tests and the system configurations were extracted from the requirements

Test	Configuration	Functional Test	Notes
FCC 47 Part 2.1022	3S1C 40W <i>Cabinet A/C Powered</i> Note MCR Sector 2 will Tx@ 5dBm	TX: TM1 Max. Power Out; Frequency Error	Sector 1 (EAC)
		TX: TM 4 Pmax-18dBm Frequency Error	Sector 1 (EAC)
		TX:TM1 Max. Power Out Frequency Error	Sector 2 (TX1 MCR)
		TX: TM 4 Pmax-18dBm Frequency Error	Sector 2 (TX1 MCR)
		TX: OMA Frequency	OMA

Table 6 – Functional Tests

Functional Test	Pass / Fail Criteria
TX: Max. Power Out	+/- 2dB (+/-2.5dB*) from Manufactures Declared Power Output; 46dBm (40Watt System)
TX: Frequency Error	(50 Parts Per Billion = 0.05 Parts Per Million) TX Frequency B3 - 1962.5 MHz x 0.05 PPM = PPM (+/- 98.12Hz)
OMA Frequency Accuracy	(50 Parts Per Billion = 0.05 Parts Per Million) PPM = +/- 0.75Hz

Table 7 – Functional Tests Pass / Fail Criteria

All functional test Pass / Fail Criteria was extracted from Standards [3.4.3].

APPENDIX D

BTS Testing Photographs

Lucent Technologies Inc. - Proprietary
Use pursuant to Company Instructions.

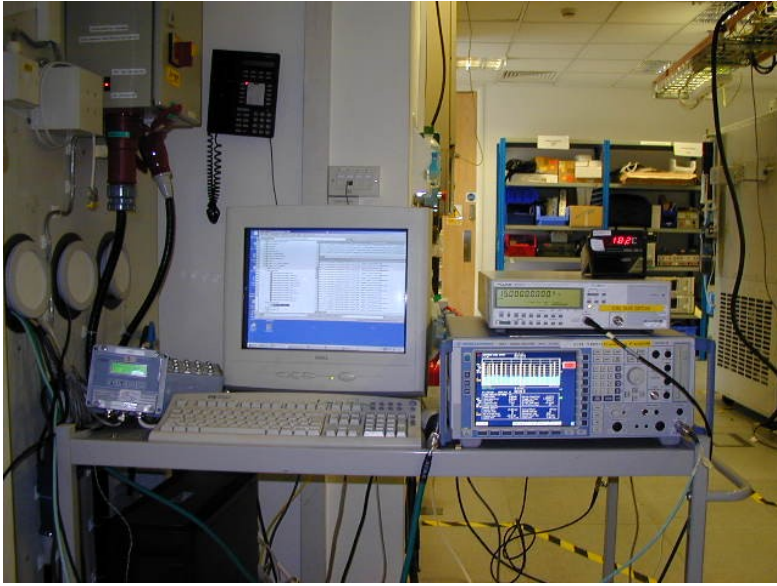

Figure 2 Test Equipment Used in measurement



Figure 3 Closed BTS under Test



Figure 4 Open BTS under Test

UMTS
Node B Compliance
03.01
Temex OMA
Test Report

Flexent[®] UMTS Macrocell

FCC 47 CFR 2.1055

Number:
Issue: 0.01
Status: Draft

Author: Michael Coelho
Date: 15 March 2005

Summary

This report describes the FCC 47 CFR 2.1055 tests completed on the Flexent UMTS Macrocell to verify compliance of the Temex OMA.

Functional tests were scheduled during the thermal test conditioning.

The test results showed that when the equipment was powered up all functional tests passed. These were:

Frequency Error

OMA Frequency Stability

CONTENTS

1.	Summary.....	41
2.	Object.....	43
3.	Introduction.....	43
3.1	Glossary.....	43
3.2	Scope.....	43
3.3	Specifications.....	43
3.4	Standards.....	43
4.	Equipment.....	43
4.1	Under Test.....	43
4.2	Test Equipment.....	43
5.	Test Procedure.....	44
5.1	Test Set up.....	44
5.2	Test Parameters.....	44
5.3	Functional Tests.....	45
6.	Results.....	45
7.	Conclusions.....	46
	APPENDIX A.....	47
	APPENDIX B.....	48
	APPENDIX C.....	48
	APPENDIX D.....	49

Object

This test was carried out to determine the frequency stability of the Temex OMA in the Flexent® UMTS Macrocell Outdoor (3S1C 40 Watt) equipped cabinet over the temperature range -30°C to 50°C and at voltage extremes of +/- 15% from nominal (230V).

Introduction

This document contains the results of the FCC 47 CFR 2.1055 tests carried out on the Flexent® UMTS Macrocell to:

[3.3.1] Project Liberty NAR UMTS/W-CDMA 1900, Federal Communications Commission (FCC) Certification Test Plan For OneBTS UMTS/W-CDMA Wideband Transceiver UCR1900 Under FCC ID: AS5ONEBTS-01 And OneBTS UMTS/W-CDMA Power Amplifier PkLAM KS-24638 L1

Under FCC ID: AS5ONEBTS-02 by Michael P. Farina

Also included are lists showing the ancillary test equipment, equipment under test and functional tests conducted.

-21. Glossary

A/C	Alternating Current
°C	Degree Celsius
ETSI	European Telecommunications Standards Institution
HIOU	Hybrid Input Output Unit
Node B	UMTS Base Station
OMA	Oscillator Module
RH	Relative Humidity
RX	Receive
SRD	System Requirement Definition
TX	Transmit
MCR	Multi Carrier Radio
UCU	Universal Channel Unit
UDT	UMTS Diagnostic Tool
UMTS	Universal Mobile Telecommunication System
3S1C 40W	Three Sector, One Carrier, Forty Watt System

Scope

This test was applied to the Flexent® UMTS Macrocell as per product specification [3.3.2] (3S1C 40Watt) equipped cabinet. It was configured to released 03.01.

Specifications

[3.3.1] Project Liberty NAR UMTS/W-CDMA 1900, Federal Communications Commission (FCC), Certification Test Plan For OneBTS UMTS/W-CDMA Wideband Transceiver UCR1900, Under FCC ID: AS5ONEBTS-01 And OneBTS UMTS/W-CDMA Power Amplifier, PkLAM KS-24638 L1 Under FCC ID: AS5ONEBTS-02

[3.3.2] Agile - Document Number KS-24705 (L100) – OneBTS Compact Cell Outdoor Cabinet IRD-UTRAN-UTR-1 VERSION3.1

Standards

[3.4.3] ESTI TS 125 141 V5.8.0 (2003-12) Release 5

[3.4.4] Title 47--Telecommunication 47 Part 2 -- Frequency Allocations and Radio Treaty Matters; General Rules and Regulation, 2.1055 Measurements required: Frequency stability.

Equipment

-20. Under Test

The Flexent® UMTS Macrocell (3S1C 40Watt) equipped cabinet was equipped with hardware as listed in Appendix A - Table 4.0.

Appendix A contains the full list of equipment under test, together with their serial numbers.

-19. Test Equipment

The test equipment used to perform the investigation has been documented in Appendix B - Table 5.0

Figure 1.0 shows a schematic view of the test equipment layout

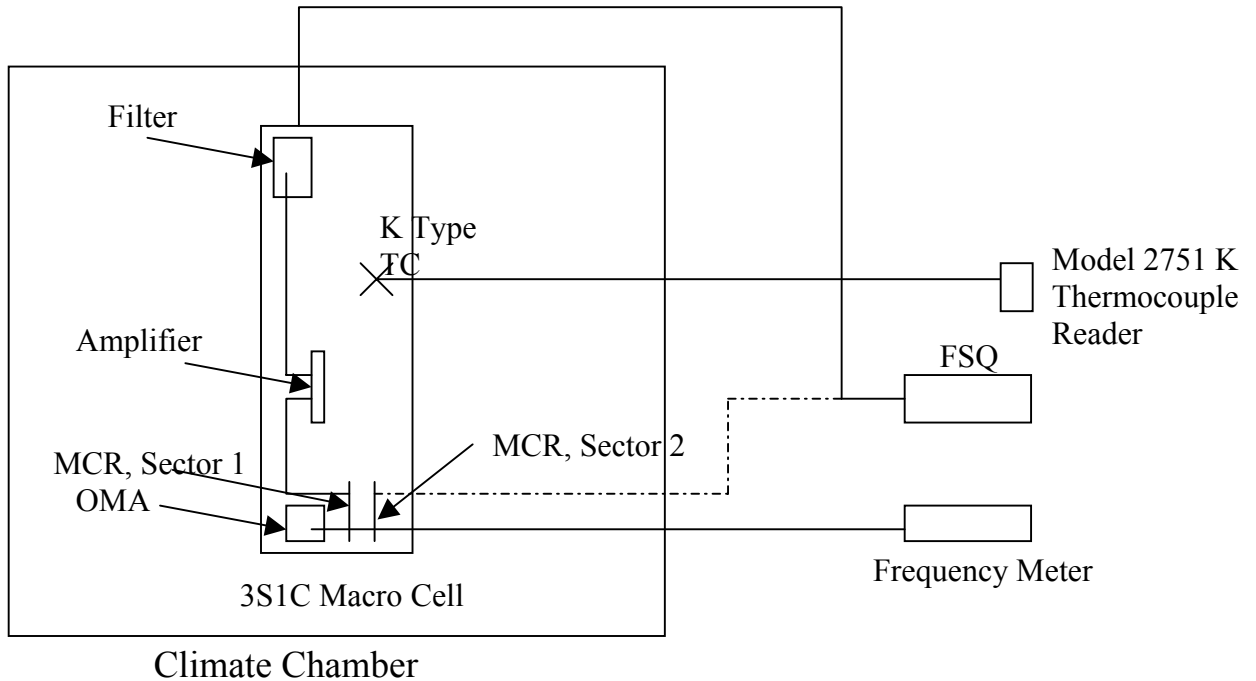

Figure 1.0 – Schematic Layout of Test Equipment

Test Procedure

-18. Test Set up

Prior to starting, the hardware was installed into the cabinet as per specification [3.3.2] and configured to U03.01 release.

Note: The cabinet was installed onto its plinth arrangement (optional) and then secured to a transportation pallet (for ease of installation and transportation into the thermal test chamber) during thermal test conditioning.

Test Parameters

- a) Points of Measurement:
 - i) The MCR measured at its RF output terminal
 - ii) The EAC transmit antenna terminal
 - iii) The Oscillator Module measured at its 15 MHz output terminal.
- b) Carrier Modulation:
 - Test Model 1 (Pmax = 46dBm)
 - Test Model 4 (Pmax – 18dB = 28dBm)
- c) Test Frequencies:
 - The FCC accepts a single test frequency, B3 - 1962.5 MHz
- d) Carrier Power Level:
 - The transmit EAC terminal with the power level adjusted to +46 dBm (40 W).
 - The transmit power level at the MCR TX port adjusted to +5 dBm (40 W).
- e) Temperature Range
 - Variation of ambient temperature from –30°C to +50°C. Stabilized at increments of 10°C.

Lucent Technologies Inc. - Proprietary
Use pursuant to Company Instructions.

f) Supply Voltage Variation:

Input Supply Voltage	AC Input Voltage
85 % of Nominal	195.5 Vac
100 % of Nominal	230.0 Vac
115 % of Nominal	264.5 Vac

Table 1 Supply Voltage Variation

Functional Tests

Functional tests were carried out during thermal conditioning at stabilized temperatures. Measurement of Frequency Error and OMA Frequency Stability were taken

The universal diagnostic tool (UDT) used to perform the tests was version 3.0.0.

Results

Stabilized Temperature °C	Meas. Freq. 85 % Nom. Hz	Deviation 85 % Nom. ppm	Meas. Freq. 100 % Nom. Hz	Deviation 100 % Nom. ppm	Meas. Freq. 115 % Nom. Hz	Deviation 115 % Nom. ppm
-30°C	-0.01	-0.0007	-0.01	-0.0007	-0.01	-0.0007
-20°C	-0.01	-0.0007	-0.01	-0.0007	-0.01	-0.0007
-10°C	-0.01	-0.0007	-0.01	-0.0007	-0.01	-0.0007
0°C	-0.01	-0.0007	-0.01	-0.0007	-0.01	-0.0007
+10°C	-0.01	-0.0007	-0.01	-0.0007	-0.01	-0.0007
+20°C	-0.01	-0.0007	-0.00	No Error	-0.01	-0.0007
+30°C	-0.01	-0.0007	-0.01	-0.0007	-0.01	-0.0007
+40°C	-0.01	-0.0007	-0.01	-0.0007	-0.01	-0.0007
+50°C	-0.01	-0.0007	-0.01	-0.0007	-0.01	-0.0007

Table 2 FCC 47 CFR 2.1055 OMA Stability

Testing Temp	Voltage Variation	EAC		MCR2	
		TM1 Pmax	TM4 Pmax – 18dBm	TM1Pmax	TM4Pmax – 18dBm
-30 °C	-15%	-28.96 Hz 45.6 dBm	-24.36 Hz 27.4 dBm	23.86Hz 5.2 dBm	31.54 Hz -12.9 dBm
	Nominal	-27.19 Hz 45.5 dBm	-21.66 Hz 27.6dBm	-7.32Hz 5.0 dBm	31.81 Hz -12.9 dBm
	+15%	-24.36 Hz 45.6 dBm	-23.55 Hz 27.6 dBm	25.89Hz 5.1 dBm	-26.76 Hz -12.9 dBm
-20 °C	-15%	-29.80 Hz 45.6 dBm	-27.55 Hz 27.2 dBm	-7.58Hz 5.0 dBm	26.24 Hz -12.8 dBm
	Nominal	-29.77 Hz 45.7 dBm	-29.15 Hz 27.4dBm	-2.08Hz 5.1 dBm	25.87 Hz -12.8 dBm
	+15%	-24.35 Hz 45.7 dBm	-28.79 Hz 27.4 dBm	29.58Hz 5.1 dBm	-23.47 Hz -12.9 dBm
-10 °C	-15%	-30.45 Hz 45.5 dBm	-23.90 Hz 27.0 dBm	-40.87Hz 5.2 dBm	-30.13 Hz -12.8 dBm
	Nominal	-29.48 Hz 45.5 dBm	-22.34 Hz 27.5 dBm	35.49Hz 5.2dBm	-31.99 Hz -12.8 dBm
	+15%	-35.47 Hz 45.4 dBm	-24.13 Hz 27.2 dBm	27.56Hz 5.0 dBm	-33.32 Hz -12.8 dBm

0 °C	- 15%	-27.84 Hz 45.6 dBm	-22.69 Hz 26.6 dBm	-24.53Hz 5.2 dBm	-29.37 Hz -12.8 dBm
	Nominal	-25.98 Hz 45.8 dBm	-25.69 Hz 26.5 dBm	-7.58Hz 5.2 Bm	-25.81 Hz -12.8 dBm
	+15%	25.84 Hz 45.7 dBm	-24.95 Hz 26.5 dBm	-1.55Hz 5.1 dBm	-30.81 Hz -12.8 dBm
10 °C	- 15%	-29.73 Hz 44.4 dBm	25.50 Hz 26.6 dBm	-28.26Hz 4.8 dBm	-28.29 Hz -13.0 dBm
	Nominal	-31.69 Hz 45.2 dBm	-32.98 Hz 26.6 dBm	-4.56Hz 4.9dBm	-31.72 Hz -12.9 dBm
	+15%	25.26 Hz 44.9 dBm	-27.88 Hz 26.3 dBm	-6.29Hz 5.0 dBm	-25.54 Hz -13.0 dBm
20 °C	- 15%	24.13 Hz 45.7 dBm	25.69 Hz 27.3 dBm	-34.27Hz 4.9 dBm	31.84 Hz -12.9 dBm
	Nominal	-37.73 Hz 45.4 dBm	-25.88 Hz 27.5 dBm	-7.70Hz 4.9dBm	-31.20 Hz -13.0 dBm
	+15%	-35.16 Hz 45.6 dBm	-31.99 Hz 27.5 dBm	-1.39Hz 4.9 dBm	-34.12 Hz -13.0 dBm
30 °C	- 15%	32.34Hz 45.6 dBm	-32.56 Hz 27.3dBm	-2.14Hz 5.0 dBm	29.72 Hz -12.9 dBm
	Nominal	28.97Hz 45.6 dBm	-47.61 Hz 27.4dBm	32.66Hz 5.0 dBm	35.10 Hz -12.9 dBm
	+15%	-30.9 Hz 46.0 dBm	40.27 Hz 27.1dBm	30.74Hz 5.0 dBm	-31.93 Hz -12.9 dBm
40 °C	- 15%	29.28 Hz 46.4 dBm	-33.12 Hz 27.7dBm	-1.52Hz 5.0 dBm	34.91 Hz -12.9 dBm
	Nominal	-36.14 Hz 46.4 dBm	-35.43 Hz 27.7dBm	-7.14Hz 5.0 dBm	-34.33 Hz -12.9 dBm
	+15%	-34.09 Hz 46.4 dBm	31.05 Hz 27.7dBm	-7.52Hz 5.0 dBm	30.59 Hz -12.9 dBm
50 °C	- 15%	-44.30 Hz 46.4 dBm	-35.94 Hz 27.7 dBm	-8.89Hz 5.0 dBm	30.01 Hz -12.9 dBm
	Nominal	-39.09 Hz 46.4 dBm	-39.06 Hz 27.7dBm	-2.12Hz 5.0 dBm	44.35 Hz -12.9 dBm
	+15%	-39.09 Hz 46.0 dBm	-39.81 Hz 27.6 dBm	-9.35Hz 5.1 dBm	32.87 Hz -12.9 dBm

Table 3 FCC 47 CFR 2.1055 Frequency Error Measurement

Conclusions

The Temex OMA meets the FCC Title 47 Part 2.1055 Frequency stability requirements.

APPENDIX A

Equipment Under Test

Table 4 details the Node B hardware.

BTS Element	Comcode	Serial number	Comment
Cabinet	848917933 01	HN4 0; 0133	---
Filter panel	408889947	04C812002170	Dual Duplexor #1
Filter panel	408805406	037D08005202	Dual Duplexor #2
Filter panel	408805406	037D08005299	Dual Duplexor #3
PAM	408837490	04BG58110011	PAM #1, Andrews
PAM	408837490	04BG58110023	PAM #2, Andrews
PAM	408837490	034X08501048	PAM #3 Andrews
MCR	201245289	04VC1U60C016	1900A BNJ 64 S0:8 P4.0
MCR	201245289	04VC1U60C011	1900A BNJ 64 S0:8 P4.0
MCR	201245289	04VC1U60C008	1900A BNJ 64 S0:8 P4.0
CTU	---	O2CE02133557	Agile, rev 004
UCU	201173276	03J601880025	UCU #1
UCU	201173276	03J601880014	UCU #2
URC	---	0060100088E5	Agile, rev 004
Oscillator Module	408886042	05TM02050508	
CPC-A	408646040	01T767002002	CPC-A #1
CPC-B	408646032	01T766001681	CPC-B #1
CPC-B	408646032	01T766001685	CPC-B #2

Table 4 – Equipment Under Test

APPENDIX B

Test Equipment

Table 5 details the test equipment used to conduct the testing.

Equipment	Make & Model Number	Serial Number	Calibration
Thermal Chamber	Design Environmental	84905	SEPT 05
Universal Frequency Counter	Fluke PM6685R	SM668746	DEC05
Signal Analyser	Rohde & Schwarz – FSQ 3	1155.5001.03	FEB 08
Power Signal Analyser	Agilent – E4440A	MY44303412	JAN 06

Table 5 – Test Equipment

APPENDIX C

Functional Tests

Lucent Technologies Inc. - Proprietary
Use pursuant to Company Instructions.

The following functional tests were carried out during thermal conditioning. These functional tests and the system configurations were extracted from the requirements

Test	Configuration	Functional Test	Notes
FCC 47 Part 2.1022	3S1C 40W <i>Cabinet A/C Powered</i> Note MCR Sector 2 will Tx@ 5dBm	TX: TM1 Max. Power Out; Frequency Error	Sector 1 (EAC)
		TX: TM 4 Pmax-18dBm Frequency Error	Sector 1 (EAC)
		TX:TM1 Max. Power Out Frequency Error	Sector 2 (TX1 MCR)
		TX: TM 4 Pmax-18dBm Frequency Error	Sector 2 (TX1 MCR)
		TX: OMA Frequency	OMA

Table 6 – Functional Tests

Functional Test	Pass / Fail Criteria
TX: Max. Power Out	+/- 2dB (+/-2.5dB*) from Manufactures Declared Power Output; 46dBm (40Watt System)
TX: Frequency Error	(50 Parts Per Billion = 0.05 Parts Per Million) TX Frequency B3 - 1962.5 MHz x 0.05 PPM = PPM (+/- 98.12Hz)
OMA Frequency Accuracy	(50 Parts Per Billion = 0.05 Parts Per Million) PPM = +/- 0.75Hz

Table 7 – Functional Tests Pass / Fail Criteria

All functional test Pass / Fail Criteria was extracted from Standards [3.4.3].

APPENDIX D

BTS Testing Photographs

Lucent Technologies Inc. - Proprietary
Use pursuant to Company Instructions.

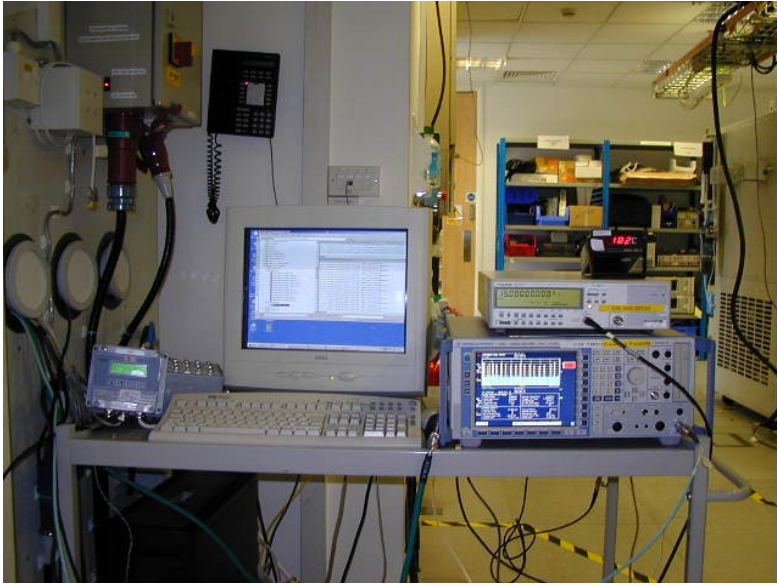

Figure 2 Test Equipment used in Measurement



Figure 3 Closed BTS under Test



Figure 4 Open BTS under Test