

**FCC
Product Certification Test Report
for
Lucent Technologies Inc.**

**PCS CDMA-EDPD Transceiver
i.e**

**FLEXENT® OneBTS™ PCS CDMA
4.0 Modular Cell
with Enhanced Digital Predistortion
(EDPD)**

Exhibits 11 - 17

W. Steve Majkowski
Lucent Technologies Inc.
Whippany FCC Compliance Laboratory
majkowski@lucent.com

Exhibit 11

SECTION 2.1033(c)(14)

Required Test Data

The data required by Section 2.1046 through 2.1057, inclusive, measured in accordance with the procedures set out in Section 2.1041.

RESPONSE:

The lowest clock frequency in the **FLEXENT® OneBTS PCS 4.0 Modular Cell with Enhanced Digital Predistortion (EDPD)** is the 10 MHz signal in the rubidium reference oscillator. Conducted spurious measurements were performed over the range of 10 kHz to 20GHz which is above the tenth harmonic of the transmit frequency range.

The following pages include the data required for the Product Certification authorization of the **PCS CDMA-EDPD Transceiver / FCC ID: AS5ONEBTS-07**, measured in accordance with the procedures set out in Section 2.1041 of the Rules.

Exhibit 12	Section 2.1046	Measurement of Radio Frequency Power Output
Exhibit 13	Section 2.1047	Measurement of Modulation Characteristics
Exhibit 14	Section 2.1049	Measurement of Occupied Bandwidth
Exhibit 15	Section 2.1051	Measurement of Spurious Emissions at Antenna
Exhibit 16	Section 2.1053	Field Strength of Spurious Radiation
Exhibit 17	Section 2.1055	Measurement of Frequency Stability

Exhibit 12

SECTION 2.1046

MEASUREMENT OF RADIO FREQUENCY POWER OUTPUT

The test arrangements used to measure the radio frequency power output of the **PCS CDMA-EDPD Transceiver/ AS5ONEBTS-07** is on the following pages. Measurements were made respectively at each frequency where Occupied Bandwidth measurements were performed. The use of the **PCS CDMA-EDPD Transceiver** is for one to three CDMA carriers. This requires that the J4 power level be calibrated for the specific channel of use. The test configuration, Figure 12a, allowed the measurement of output power for each channel investigated for Occupied Bandwidth. These included the upper and lower Block edges for each PCS Block.

The **PCS CDMA-EDPD Transceiver** system has a maximum power output at the antenna terminals of 20.0 Watts (43.01 dBm) +2 / -4 dB, it also has a minimum power output at the antenna terminals of 0.010 Watts (10.01 dBm +2 / -4 dB, across the PCS downlink Band (1930.00-1990.00 MHz). The signal applied to the **PCS CDMA-EDPD Transceiver** is defined in Table 12.1 and is "**Table 6.5.2-1 Base Station Test Model, Nominal**" from **3GPP2 C.S0010-0, December 1999, Recommended Minimum Performance Standards for cdma2000 Spread Spectrum Base Stations,**. The power was reset to a minimum of 20.0 Watts at each measurement frequency to verify the spectral performance at that power level at each specific frequency of interest. The attenuation range was also verified. The specific Frequencies and channels and set power level was documented on each "Occupied Bandwidth" sheet.

Type	Number of Channels	Fraction of Power (Linear)	Fraction of Power (dB)	Comments
Pilot	1	0.2000	-7.0	Walsh 0
Sync	1	0.0471	-13.3	Walsh 32, always 1/8 rate
Paging	1	0.1882	-7.3	Walsh 1, full rate only
Traffic	6	0.09412 each	-10.3 each	Variable Walsh Assignments, full rate only

TABLE 12.1 Base Station Test Model, Nominal

RESULTS:

The **PCS CDMA-EDPD Transceiver/ AS5ONEBTS-07** was configured in the test setup shown in Figure 12A. For each of the PCS channels tested the **PCS CDMA-EDPD Transceiver/ AS5ONEBTS-07** delivered a minimum of 20.0 Watts +2/-0 dB when measured at the J4 output connection. This data is recorded on the Occupied Bandwidth Data Sheets for "Left edge" and "Right Edge" of each frequency Block. Data is presented for all PCS Blocks.

Exhibit 12 RF Power Test Configuration

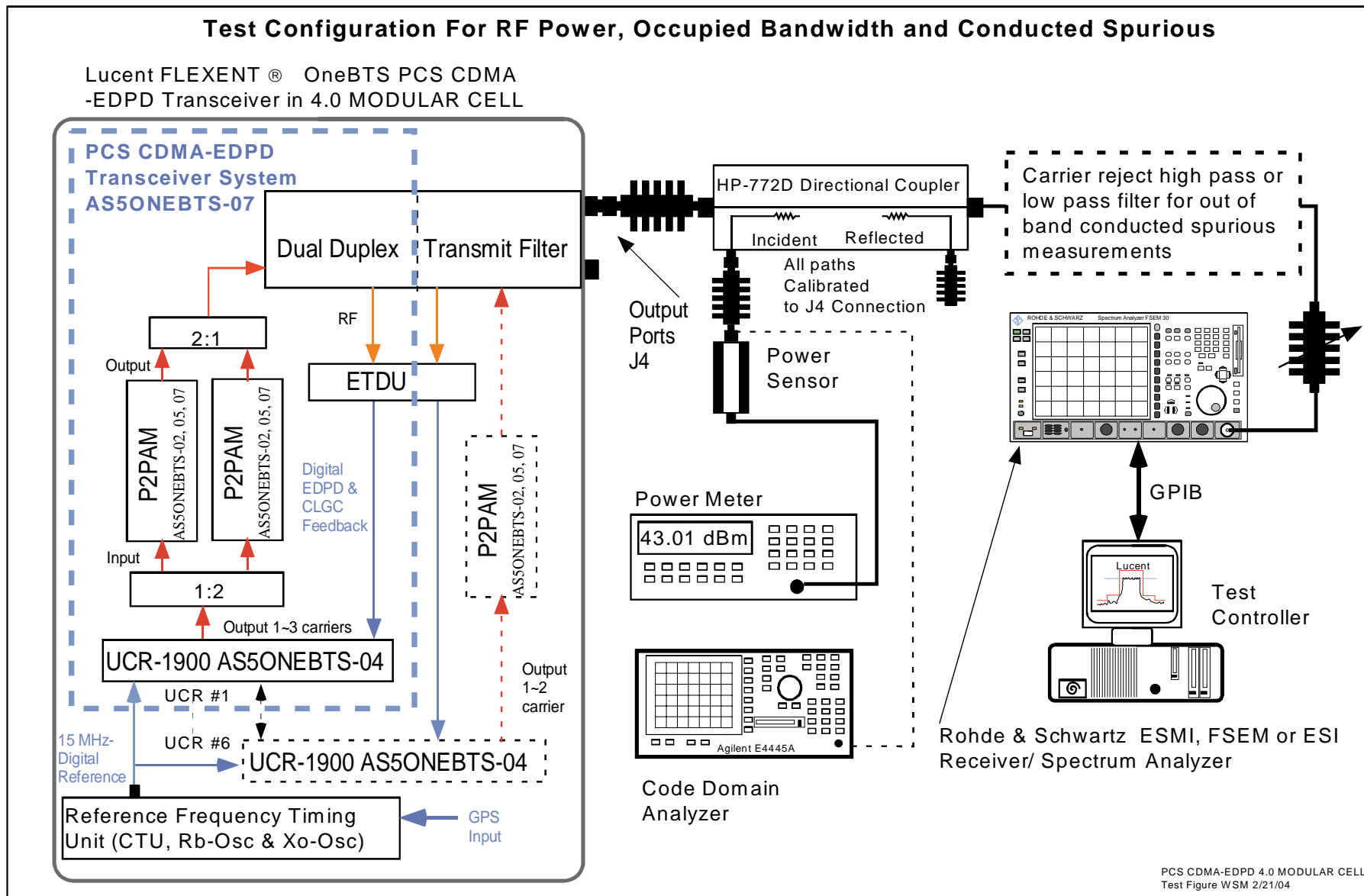

Exhibit 12 *continued*

Measurement Equipment used in Figure 12 For Measurement of RF Power

<u>Equipment</u>	<u>Description</u>
Product Frame:	PCS Outdoor Flexent OneBTS Modular Cell 4.0 with 6 UCR-1900 and 12 P2PAM amplifiers configured for EDPD
UCR-1900	UMTS-CDMA Baseband Radio (FCC ID: AS5ONEBTS-04)
P2PAM:	Power Amplifier Module, (FCC ID: AS5ONEBTS-02 & 05)
Transmit Filter:	PCS Dual Duplex Transmit Filter appropriate for the investigated Blocks
Directional Coupler:	HP 778D and 772D Dual Directional Coupler
Power Meter:	Agilent E4419B Power Meter with EPC-E18A Power Sensor or HP Model 437 Power Meter with HP-8481A Power Sensor
Test Cables:	Low loss test cables custom mfg. for Lucent FCC Laboratory
Plotter:	HP Model 7470A Plotter
Printer:	HP Model 4500DN Printer
Attenuator, Variable	HP 8494B and 8495B DC-18 GHz digital attenuators
Attenuator, Fixed	Weinschel Corp DC-18 GHz, various values
Band Pass Filters:	Various 10 MHz-20 GHz, Custom manufactured for Lucent FCC Laboratory
Spectrum Analyzer:	Rohde & Schwarz ESMI EMI Test Receiver or Rohde & Schwarz FSEM Spectrum Analyzer
Code Domain Analyzer	H-P and Agilent E4406A VSA Series Transmitter Tester
Computer Controller:	EG Technology, Custom Mfg for FCC Laboratory, Intel™ Pentium III & IV, 550 and 1600 MHz controllers with TILE™ software

Exhibit 13

SECTION 2.1047

MEASUREMENT OF MODULATION CHARACTERISTICS

The modulation characteristics and accuracy of the **PCS CDMA-EDPD Transceiver/ AS5ONEBTS-07** output signal is a function of the signal provided by the **UCR-1900/ AS5ONEBTS-04**, Granted 24 September 2002. The following documents the requirements and measurement performed.

SECTION 2.1047- Modulation Description

The modulation methods used in CDMA are completely different from those used in a FM analog system. The methods used in evaluating the UMTS CDMA Radio (PCS) (UCR) are described in the pertinent standards documents which include **TIA/EIA-97-C** “recommended Minimum performance Standards for Base Stations Supporting Dual-Mode Wideband Spread Spectrum Cellular Mobile Stations” and **3GPP2 C.S0010-0**, December 1999, *Recommended Minimum Performance Standards for cdma2000 Spread Spectrum Base Stations*. The modulation quantify criteria are as follows:

13.1 Modulation Requirements – Section 4.2 of TIA/EIA-97-C and 3GPP2 C.S0010-0

4.2 Modulation Requirements

Waveform quality is tested by measuring the waveform quality ρ , as defined in 6.4.2.1, and code domain power as defined in 6.4.2.2. The range of values for the transmit waveform quality is from 1.0 for a perfect CDMA waveform to 0.0 for a non-CDMA signal. As an example, a base station with a 0.5 dB degradation in its transmit waveform would have a quality, ρ , of $10^{-(0.5/10)} = 0.89$.

13.2 Required Results

Per Section 4.2.2.3 of **3GPP2 C.S0010-0**

4.2.2.3 Minimum Standard

The normalized cross correlation coefficient, ρ , shall be greater than 0.912 (excess power < 0.4 dB).

The test method and diagrams are shown in Figure 13.

The signal applied to UCR is as shown in Table.

13.3 Minimum Standard

The normalized cross correlation coefficient, ρ , shall be greater than 0.912 (excess power \leq 0.4 dB).

13.4 Results

The test verified that the waveform quality factor, the normalized cross correlation coefficient, ρ , is \geq 0.998. It also verified that the frequency offset is less than (+0.05 PPM) of the frequency assignment.

Exhibit 13 continued

Figure 13 Modulation Quality Measurement

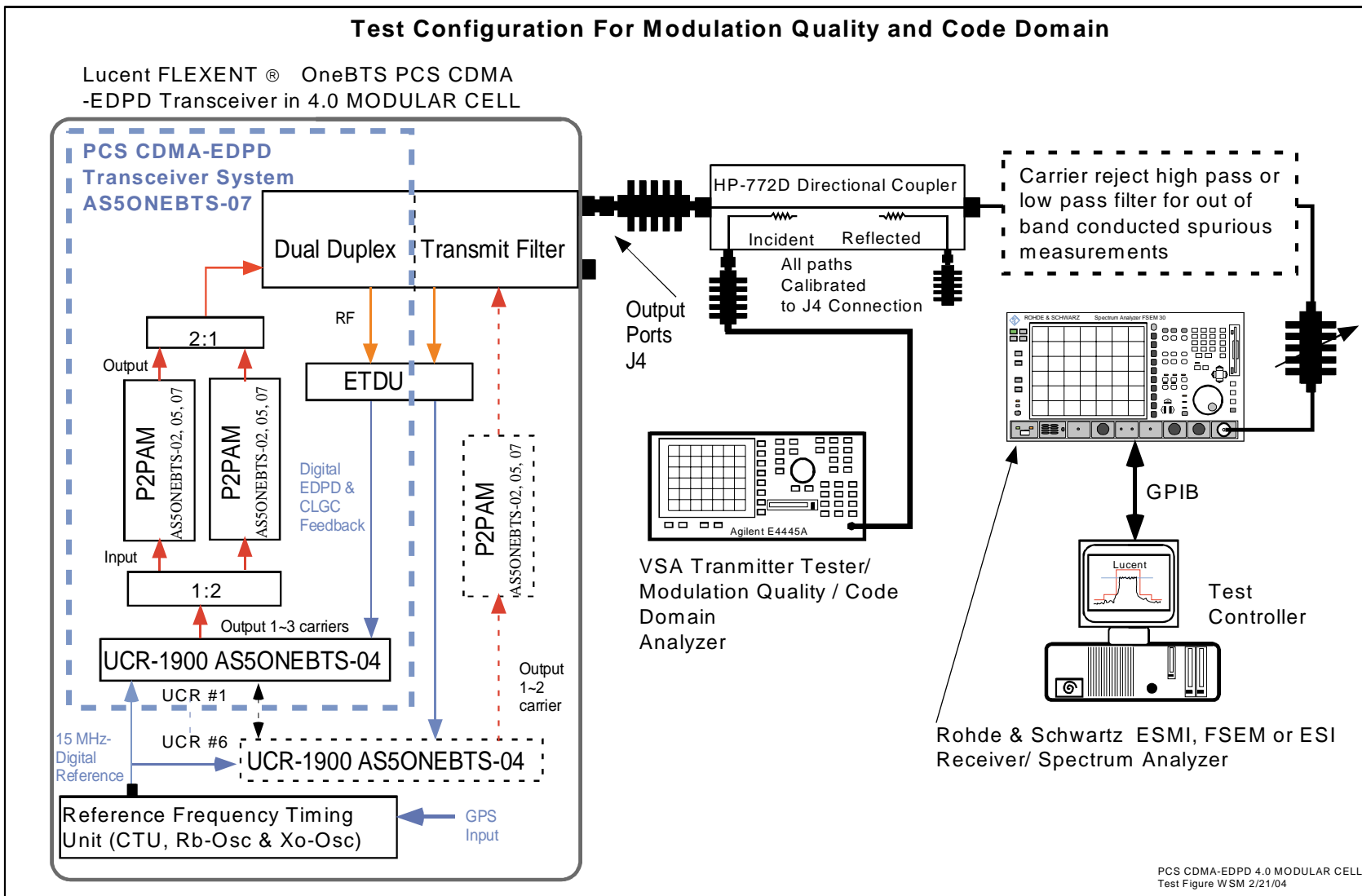

Exhibit 14

SECTION 2.1049 MEASUREMENT OF OCCUPIED BANDWIDTH

Because of the Multi Carrier application of the **PCS CDMA-EDPD Transceiver**, occupied bandwidth measurements were performed for both of the **P2PAM/MCA** configurations. This documents the typical performance of the **PCS CDMA-EDPD Transceiver** while supplied with single, dual and three CDMA carriers. Since the **P2PAM** is a fixed gain device all power adjustments were performed via the **UCR-1900 / FCC ID: AS5ONEBTS-04**.

The occupied bandwidth of the **PCS CDMA-EDPD Transceiver/ FCC ID: AS5CMP-36** was measured using a Rohde & Schwarz FSEM-30 Spectrum Analyzer, a PC based instrumentation controller using TILE™ software and calibrated RF equipment. The RF power level was measured and adjusted via the test setup in Figure 14A. The calibrated RF output from the transmitter was reduced (to an amplitude usable by the spectrum analyzer) by using a calibrated broadband attenuator. This attenuation was offset on the display and the signal adjusted to the -16.2 dBc level corresponding to the corrected RF power level for a 30 kHz resolution bandwidth (RBW). This set-point was performed as follows:

The power calibration was individually verified at each carrier using a power meter in the Figure 14A setup. Additionally a power calibration was performed to calibrate the setting of the measured 30 kHz Occupied Bandwidth signal at the -16.2 dBc line and a 3 MHz RBW measurement against the “Top of Mask” limit which corresponds to the output power at an RBW setting of ≥ 1.25 MHz. These measurements were performed prior to each Occupied Bandwidth measurement. The signals measured at RBW’s of 3 MHz and 30 kHz were plotted and a digital attenuation was adjusted to place the 3 MHz RBW signal at the “Top of Mask”. The carrier was measured with a 30 kHz RBW and used the same attenuation. These two graphs are co-plotted and shown in Figure 14C Typical Power Calibration.

This test procedure above calibrates the carrier power to the “Top of Mask” and accurately places the 30 kHz RBW measured carrier at the -16.2 dBc line. This process also documents the carrier power at the specified power level of 20 watts per carrier / 43.01 dBm. All of the plots are presented with a 7.5 MHz span and the center frequency of the specific Sub-Block of interest. This allows for ease of comparison of the single, dual and three carrier performance. This data was electronically recorded using the TILE™ software and electronically placed in the Occupied Bandwidth Data Sheets. These sheets contain data for “Left Edge of Block”, and “Right Edge of Block” for each PCS frequency Block in the application.

Block Organization and Tests Performed

The FLEXENT PCS Modular cell product line uses transmit filters which combine a 15 MHz PCS Blocks (A, B and C) with an adjacent 5 MHz Blocks (D, E & F) into 3 basic Filters. These 20 MHz wide Filters along with low spurious of EDPD performance allow for compliance at the edges of standard PCS Blocks. These Filter Blocks are A/D, B/E and F/C. Measurements were performed at the edges of the standard PCS Blocks.

All of the **PCS CDMA-EDPD Transceiver’s** – filters combinations tests were performed for the one, two and three carrier operational configurations of the **PCS CDMA-EDPD Transceiver**. When a second source manufacturers is to be qualified for a granted block, the tests are performed and the source approved via a Class I change to the applicable filings.

Applied Signal

The applied signal, from a UCR-1900 FCC ID: AS5ONEBTS-04, met the recommended characteristics per "**Table 6.5.2-1 Base Station Test Model, Nominal**" from **3GPP2 C.S0010-0, December 1999**, Recommended Minimum Performance Standards for cdma2000 Spread Spectrum Base Stations, as defined below.

Type	Number of Channels	Fraction of Power (Linear)	Fraction of Power (dB)	Comments
Pilot	1	0.1490	-8.3	Walsh 0
Sync	1	0.015/p	-18.3	Walsh 32, always 1/8 rate
Paging	1	0.054	-12.7	Walsh 1, full rate only
Traffic	6	0.13 each	-8.8 each	Variable Walsh Assignments, full rate only

TABLE 14.1 Base Station Test Model, Nominal

Exhibit 14 *continued*

Measurement Offset

The spectrum analysis output plots shows the peak of the CDMA channel signal 16.19 dB below the Mask reference / “zero dBc line” of the spectrum analyzer for the following reason: For the CDMA system there is no carrier without modulation. Since the CDMA signal is Broadband and 1.25 MHz wide, all measurements performed at narrower resolution bandwidths need be adjusted for the reduction in signal energy. The following relationship was used to provide the correct level for an unmodulated carrier vs. the modulated signal.

$$10*\log (\text{Resolution Bandwidth/ Transmit Bandwidth}) = \text{Signal Offset} \quad (1)$$

For the peak of the 1.25 MHz CDMA signal measured with a RBW of 30 kHz the signal offset is:

$$\text{Signal Offset} = 10*\log (30 \text{ kHz} / 1.25 \text{ MHz}) = -16.19 \text{ dB}$$

Limits which are specified as appropriate at a given RBW can be measured and evaluated at other RBW’s if the limit is adjusted per equation (1)

Require Levels

The minimum standard presented in **3GPP2 C.S0010-0**, Dec. 1999, *Recommended Minimum Performance Standards for cdma2000 Spread Spectrum Base Stations, Section 4.4.1.3* was followed for Suppression Inside the Licensee’s Frequency Block(s)

Signals that are within the base station transmit band of 1930.000 to 1990.000 MHz and are within the specific block(s) allocated to the operator's system, the total conducted spurious emissions in any 30 kHz band greater than 885 kHz from the CDMA channel center frequency shall not exceed a level of -45 dBc....

The Limit in 47 CFR 24.238(a)(b) for emissions in the 1 MHz band immediately outside and adjacent to a licensee's frequency block is:

Emissions ≤ 1 MHz outside the Block *when measured with a RBW of 1%* of the emissions Bandwidth shall be attenuated by :

$$-\{43+10\log (\text{mean power output in watts})\} = -13 \text{ dBm}$$

The Limit in 47 CFR 24.238(a) for emissions outside a licensee's frequency block is:

Emissions > 1 MHz outside the Block, *when measured with a RBW of 1 MHz*, shall be attenuated by :

$$-\{43+10\log (\text{mean power output in watts})\} = -13 \text{ dBm.}$$

Measurement at a Resolution Bandwidth of 30 kHz is based on our experience with 47 CFR 24.238 and lacking other guidance.

Adjusted Levels

The following levels apply when measurements of the above limits are performed with an RBW of 30 kHz. Measurement at a Resolution Bandwidth of 30 kHz is based on our experience with 47 CFR 24.238 and lacking other guidance.

1. On any frequency removed from the carrier center frequency by greater than 885 kHz up to 1.25 MHz - at least 45 decibels below the carrier; and
2. On any frequency removed from the carrier center frequency by greater than 1.25 MHz to 2.25 MHz the level shall not exceed -9.2 dBm/-52.21 dBc when measured in a 30 kHz resolution bandwidth (Note 2 below); and
3. From the edge of the Block to the 10th harmonic of the carrier at least:

$$-\{43+10\log (\text{mean power output in watts})\} \text{ dBm,}$$

whichever is the lesser attenuation. For 20 Watts the required level is -71.24 dBc / -28.2 dBm as measured with a 30 kHz resolution bandwidth (see Note 3). This is equal to -13 dBm measured with a 1 MHz resolution bandwidth.

Exhibit 14 *continued*

Note 2: The -9.2 dBm/-52.21 dBc level was computed as follows: The limit is specified as

$$-\{43+10\log(\text{mean power output in watts})\} \text{ dB} = -13 \text{ dBm}$$
 When measured in a resolution bandwidth not less than 1% of the signal bandwidth.
 Since the carrier is a 1.25 MHz bandwidth signal, the limit is adjusted to

$$-13 + 10\text{LOG}(30\text{kHz}/12.5 \text{ kHz}) \text{ dBm} = -9.2 \text{ dBm} / -52.21 \text{ dBc}$$

Note 3: The -28.2 dBm / -71.24 dBc level is computed from -13 dBm measured with a 1 MHz resolution bandwidth adjusted by :

$$-13 + 10\text{LOG}(30\text{kHz}/1.0 \text{ MHz}) \text{ dBm} = -28.2 \text{ dBm} / -71.21 \text{ dBc}$$

Mask Description for Single Carrier

The Mask limits are identical for the left and right side of the PCS Blocks and are as follows.

Figure 14B shows the Mask limit for PCS channel 925 which is the left block edge for Block C and shows limits levels identical for the band edge of the PCS band. The Spectrum Analyzer reference level is set above the Signal Reference to allow for the necessary dynamic range of a three CDMA carrier presentation.

- The top of a typical 43.01 dBm single carrier CDMA signal viewed at a resolution bandwidth of 30 kHz is shown at the 26.81 dBm/ -16.2 dBc line. This line is based on equation 1, and the ratio of the 1.25 MHz bandwidth and the 30 kHz resolution bandwidth of the spectrum analyzer.
- The vertical line from a to b (i.e. a-b) is at 885 kHz from the center of channel 925 (i.e. Fc), per *3GPP2 C.S0010-0*. The horizontal line b-c is 45 dB below the 43.01 dBm/ 0 dBc reference level.
- The vertical line c-d is at 1.25 MHz from the center of the channel.
- The placement of line d-e is derived from evaluation of the signal and 12.5 kHz (1%) resolution bandwidth, using the suggested value in section 24.238 of the rules. The ratio of 30 kHz to 12.5 kHz in equation (1) gives 3.8 dB. Adjusting the tolerance line to reflect this difference puts the -13 dBm limit line at -9.2 dBm or -52.21 dBc below the reference line.
- The vertical line, e-f is at 2.25 MHz from the center of channel 925.
- The horizontal line f-g is drawn at -71.21 dBc below the 0 dBc / 43.01 dBm reference because the rules require a 1 MHz resolution bandwidth for measurements 1 MHz or greater outside the PCS band. Again, equation (1) and the ratio of 1 MHz to 1.25 MHz provides this value. The same logic was used in determining the other block and band edge tolerances.

Mask Description for Multiple Carrier

The mask for multiple carriers only adjusts the width of the carrier portion of the mask.

For the example given above...with multiple carriers there would be no adjustments made to the "Left Edge of Block" requirements. The specified "Right Edge Limit" is treated as an expansion of the non Block edge corner **bb** to be the required + 885 kHz from the center of the "right most" channel. The "Right Edge of Block" limits were derived consistently.

Measurement

All of the tolerance lines for the output are referenced to the top of the Occupied Bandwidth mask, which is defined as 43.01 dBm/ zero dBc. For all measurements of the **PCS CDMA-EDPD Transceiver** Occupied Bandwidth, the output power was measured / adjusted individually to the 20 W level for each carrier and this is the 43.01 dBm value at the 0 dBc reference line.

In order to depict the tolerance lines that are required by Sec 24.238 of the FCC Rules and 3GPP2 C.S0010-0, all measurements were made with a resolution bandwidth of 30 kHz and the limits were adjusted using equation (1). An average detector was employed using minimum of 25 sweeps per trace.

Exhibit 14 continued

PCS Block -Channel	Number of carriers	Number of P2PAM's in MCA	Test Results Occupied BW
A- 25	1	1 & 2	Compliant
A-25, 50	2	1 & 2	Compliant
A- 25, 50, 75	3	2	Compliant
A-275	1	1 & 2	Compliant
A-250, 275	2	1 & 2	Compliant
A- 225, 250, 275	3	2	Compliant
B- 425	1	1 & 2	Compliant
B-425, 450	2	1 & 2	Compliant
B- 425, 450, 475	3	2	Compliant
B-675	1	1 & 2	Compliant
B-650, 675	2	1 & 2	Compliant
B- 625, 650, 675	3	2	Compliant
C- 925	1	1 & 2	Compliant
C-925, 950	2	1 & 2	Compliant
C- 925, 950, 975	3	2	Compliant
C-1175	1	1 & 2	Compliant
C-1150, 1175	2	1 & 2	Compliant
C- 1125, 1150, 1175	3	2	Compliant
D- 325	1	1 & 2	Compliant
D-325, 350	2	1 & 2	Compliant
D-325, 350, 375	3	2	Compliant
E- 725	1	1 & 2	Compliant
E-725, 750	2	1 & 2	Compliant
E- 725, 750, 775	3	2	Compliant
F- 825	1	1 & 2	Compliant
F-825, 850	2	1 & 2	Compliant
F- 825, 850, 875	3	2	Compliant

(1) The Single Amplifier configurations supports 1 and 2 carrier transmit configurations. The dual amplifier MCA supports 1, 2 or 3 carrier transmit configurations

TABLE 15.2 PCS Occupied Bandwidth Compliance Tabulation

Presented Results

The Block designation, PCS channels, frequencies and Measured RF Power are tabulated on each plot. Input and output signals are plotted for each frequency/ channel of interest. Plots are provided for Left Edge and Right Edge of each PCS Block evaluated. These frequencies were chosen to show the occupied bandwidth at the edges of each of the PCS Blocks in which this product can be operated, in compliance with Section 24.229 and 24.238 (c) of the Commission code. The signal used to show the occupied bandwidth is defined in table 14.1. This is the signal recommended in 3GPP2 C.S0010-0, December 1999, Recommended Minimum Performance Standards for cdma2000 Spread Spectrum Base Stations, Paragraph 6.5.2, Test Model for Base Station. The power output level was adjusted to provide the documented value on each chart.

RESULTS: The following exhibits illustrate the spectrums investigated and document compliance.

W. Steve Majkowski NCE

Exhibit 14 *continued*

Test Equipment and Results

Table 14-2 Equipment used for Measurement of RF Transmit Power, Occupied Bandwidth and Conducted Spurious Emissions

<u>Equipment</u>	<u>Description</u>
Product Frame:	PCS Outdoor Flexent OneBTS Modular Cell 4.0 with 6 UCR-1900 and 12 P2PAM amplifiers configured for EDPD
UCR-1900	UMTS-CDMA Baseband Radio (FCC ID: AS5ONEBTS-04)
P2PAM:	Power Amplifier Module, (FCC ID: AS5ONEBTS-02 & 05)
OM 1&2 :	Oscillator Module, 15 MHz Rubidium and Crystal types
Transmit Filter:	PCS Dual Duplex Transmit Filter appropriate for the investigated Blocks
Directional Coupler:	HP 778D and 772D Dual Directional Coupler
Power Meter:	Agilent E4419B Power Meter with EPC-E18A Power Sensor or HP Model 437 Power Meter with HP-8481A Power Sensor
Test Cables:	Low loss test cables custom mfg. for Lucent FCC Laboratory
Printer:	HP Model 4500DN Printer
Attenuator, Variable	HP 8494B and 8495B DC-18 GHz digital attenuators
Attenuator, Fixed	Weinschel Corp Low intermod type, DC-18 GHz, various values
Attenuator, Variable	HP 8494B and 8495B DC-18 GHz digital attenuators
Attenuator, Fixed	Weinschel Corp DC-18 GHz, various values
High Pass Filters:	2.5-20 GHz, Custom manufactured for Lucent FCC Laboratory
Low Pass Filters:	10MHz –1.8 GHz, Custom manufactured for Lucent FCC Laboratory
Spectrum Analyzer:	Rohde & Schwarz ESMI EMI Test Receiver or Rohde & Schwarz FSEM Spectrum Analyzer
Code Domain Analyzer	H-P and Agilent E4406A VSA Series Transmitter Tester
Computer Controller:	EG Technology, Custom Mfg for FCC Laboratory, Intel™ Pentium III & IV, 550 and 1600 MHz controllers with TILE™ software

Figure 14A Test Setup for Antenna Port Measurement of Transmit Power, Occupied Bandwidth and Conducted Spurious Emissions

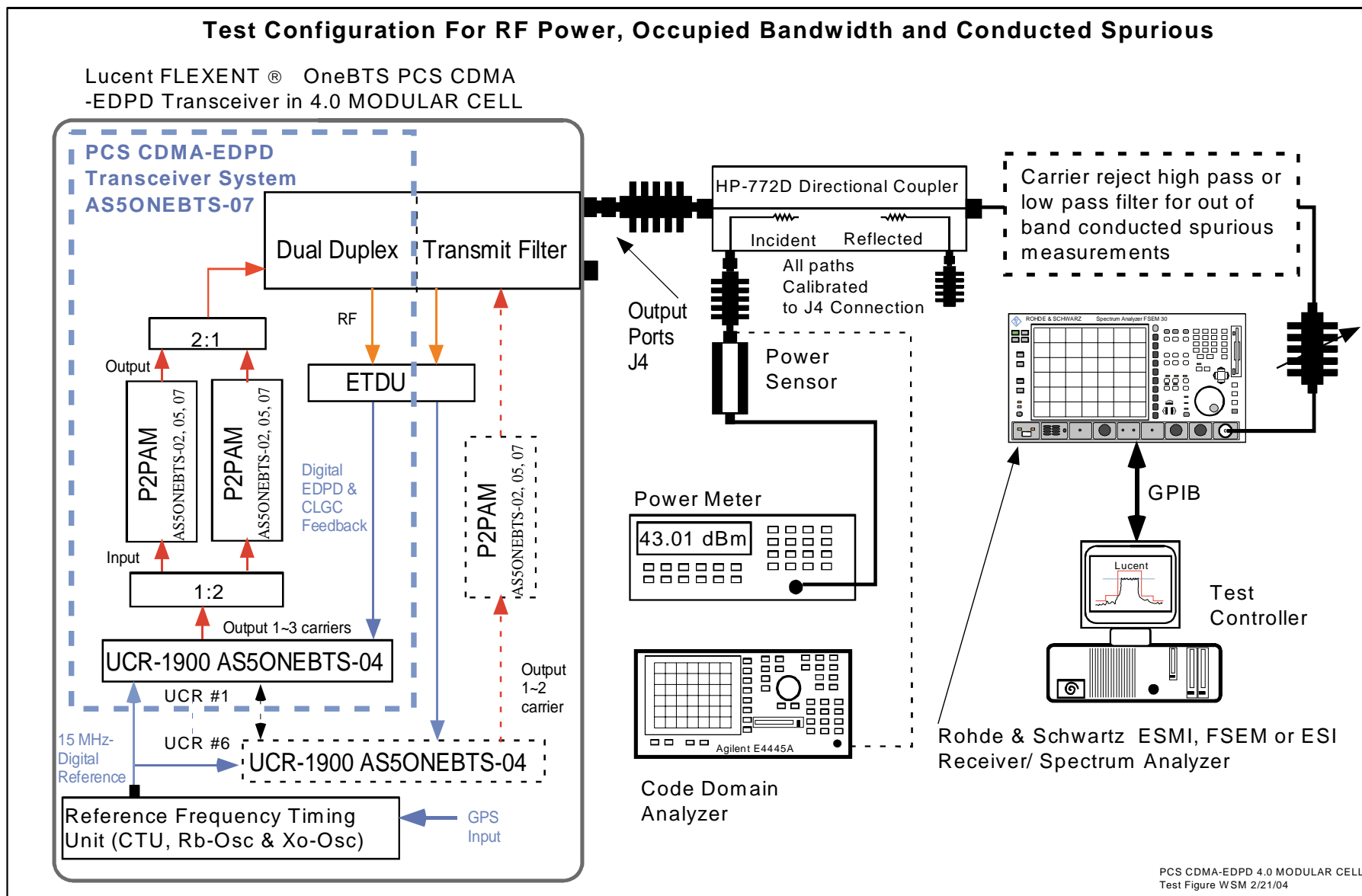

Figure 14B Typical Occupied Bandwidth Mask

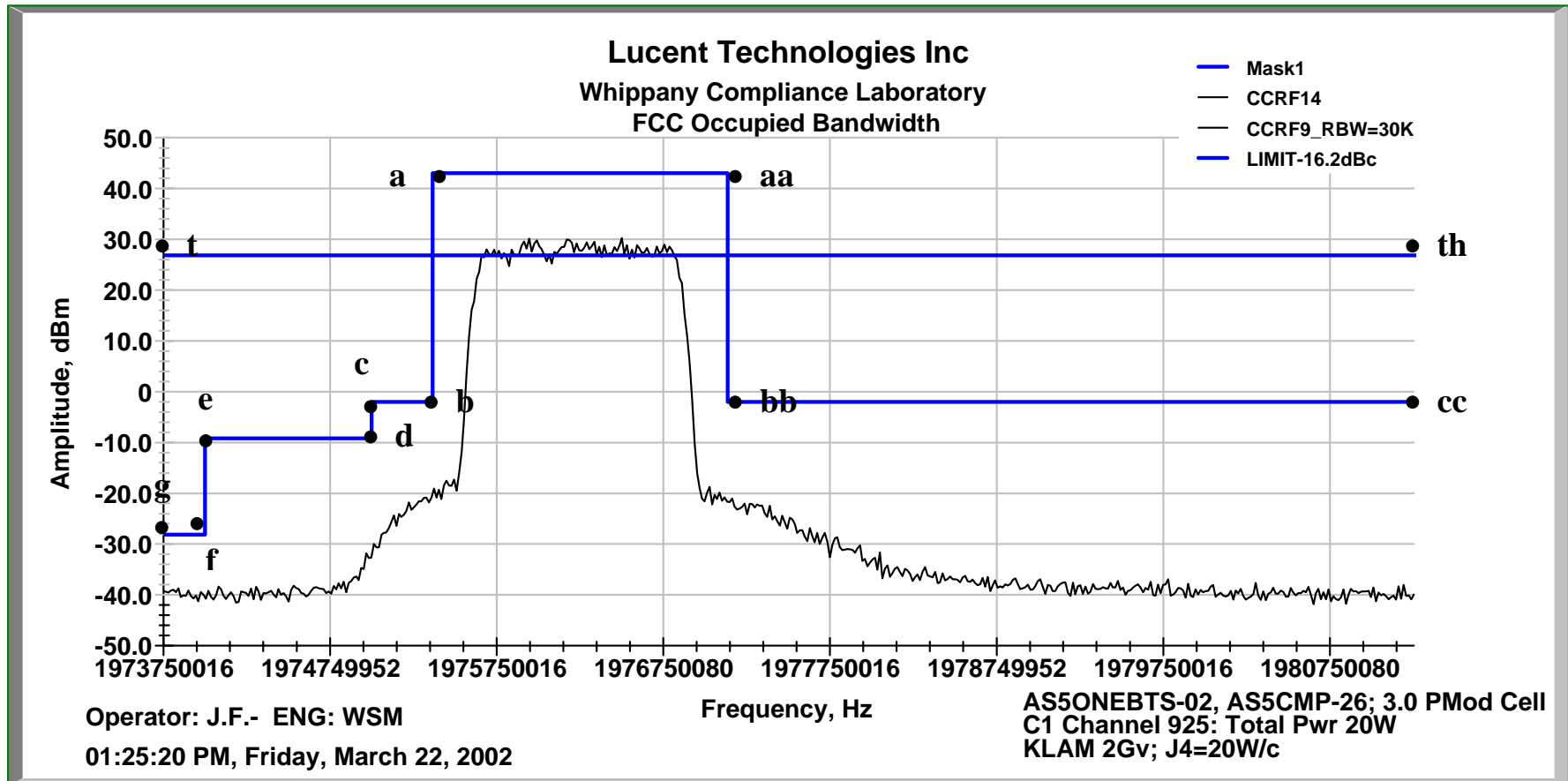
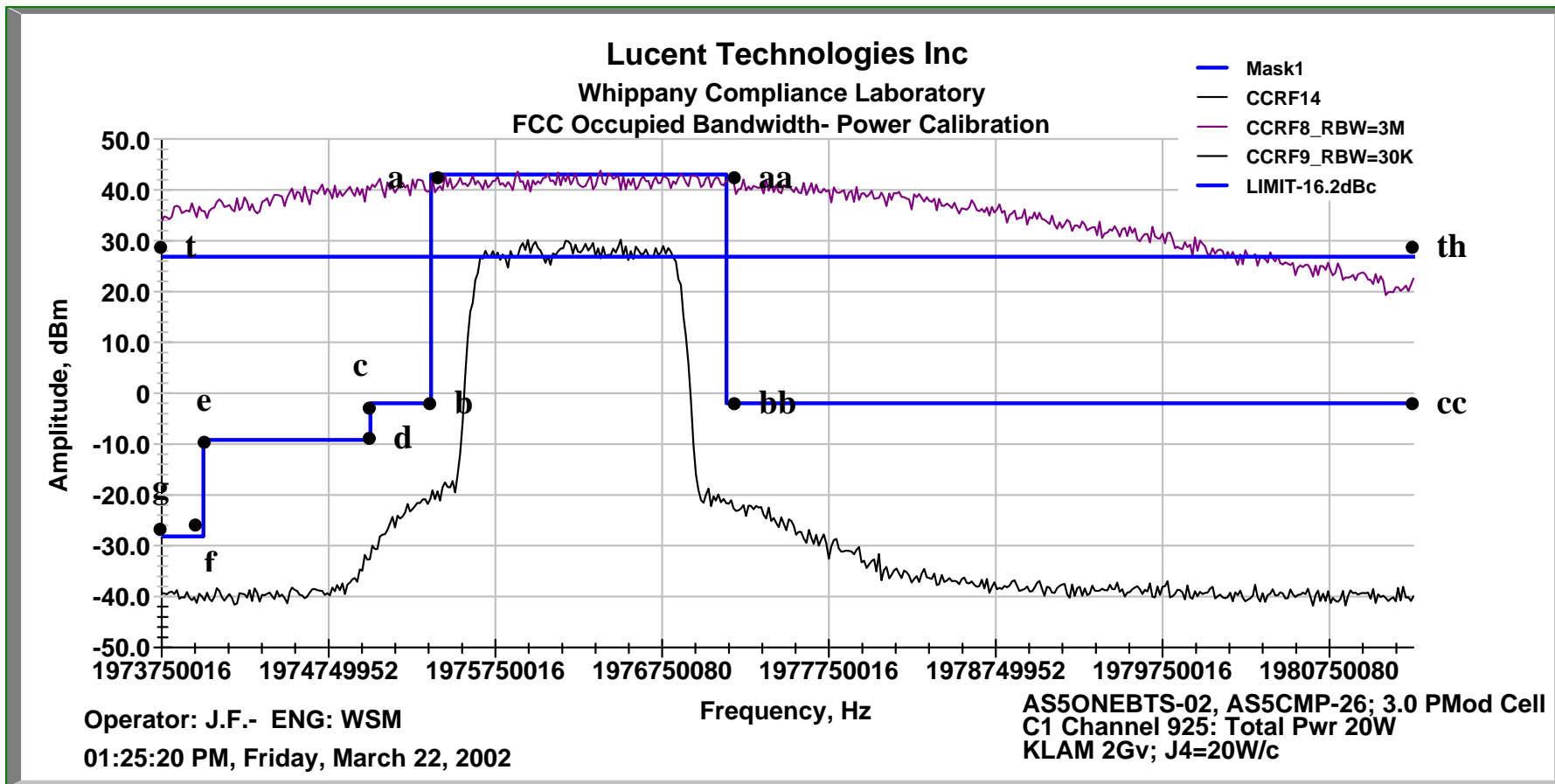

Figure 14C Typical Power Calibration



**FCC Measurements
of
Lucent Technologies Inc.**

**PCS CDMA Enhanced Digital PreDistortion Transceiver
(EDPD)**

as installed in

FLEXENT® OneBTS™ PCS CDMA 4.0 Modular Cell

W. Steve Majkowski NCE
Lucent Technologies Inc.
Whippany FCC Compliance Laboratory
majkowski@lucent.com

FCC Occupied Bandwidth Data, A Band 1-P2Pam/1c Ch 25 @ 20W EDPD

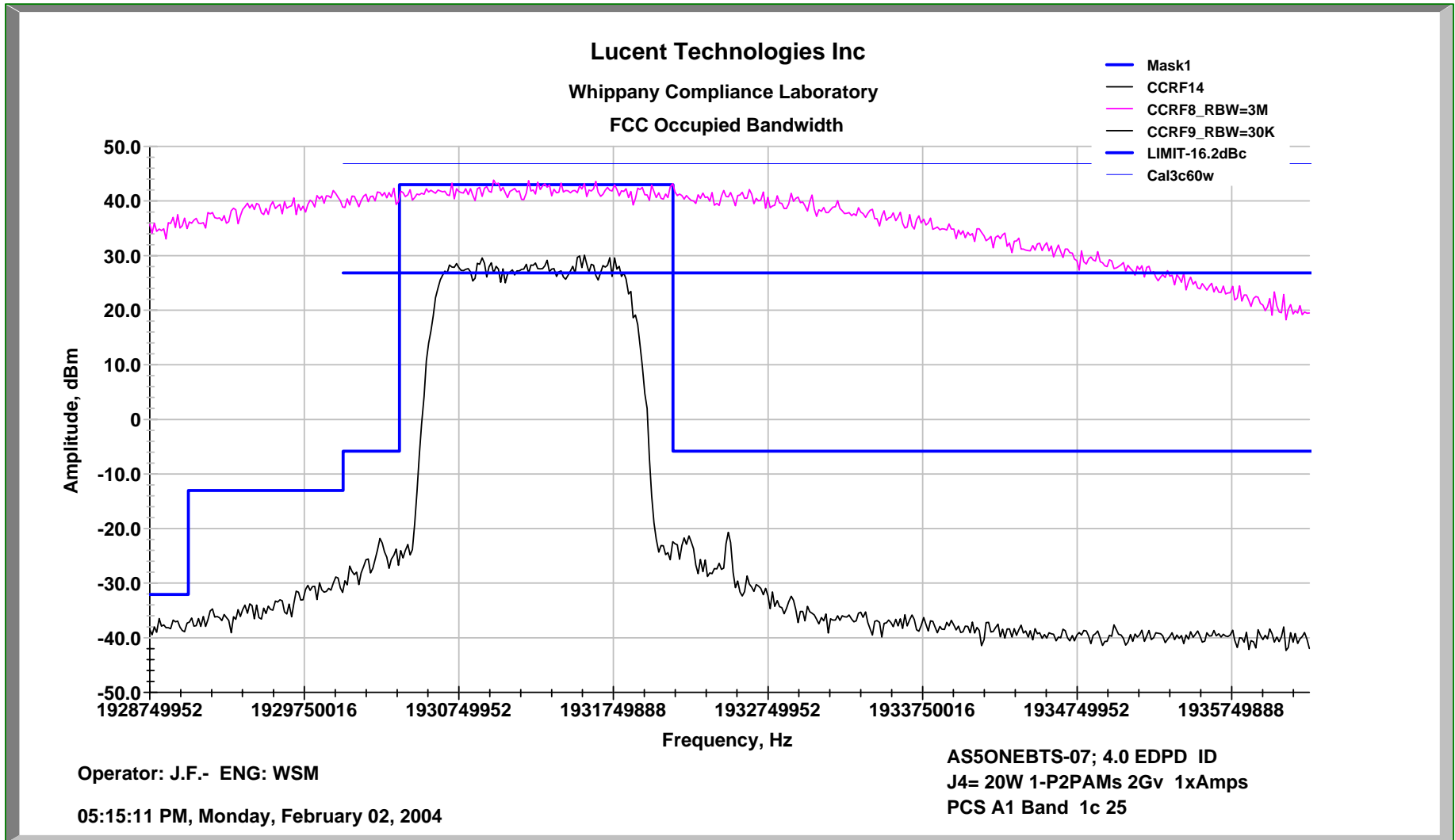

FCC Occupied Bandwidth Data, D Band 1-P2Pam/1c Ch 325 @ 20W EDPD

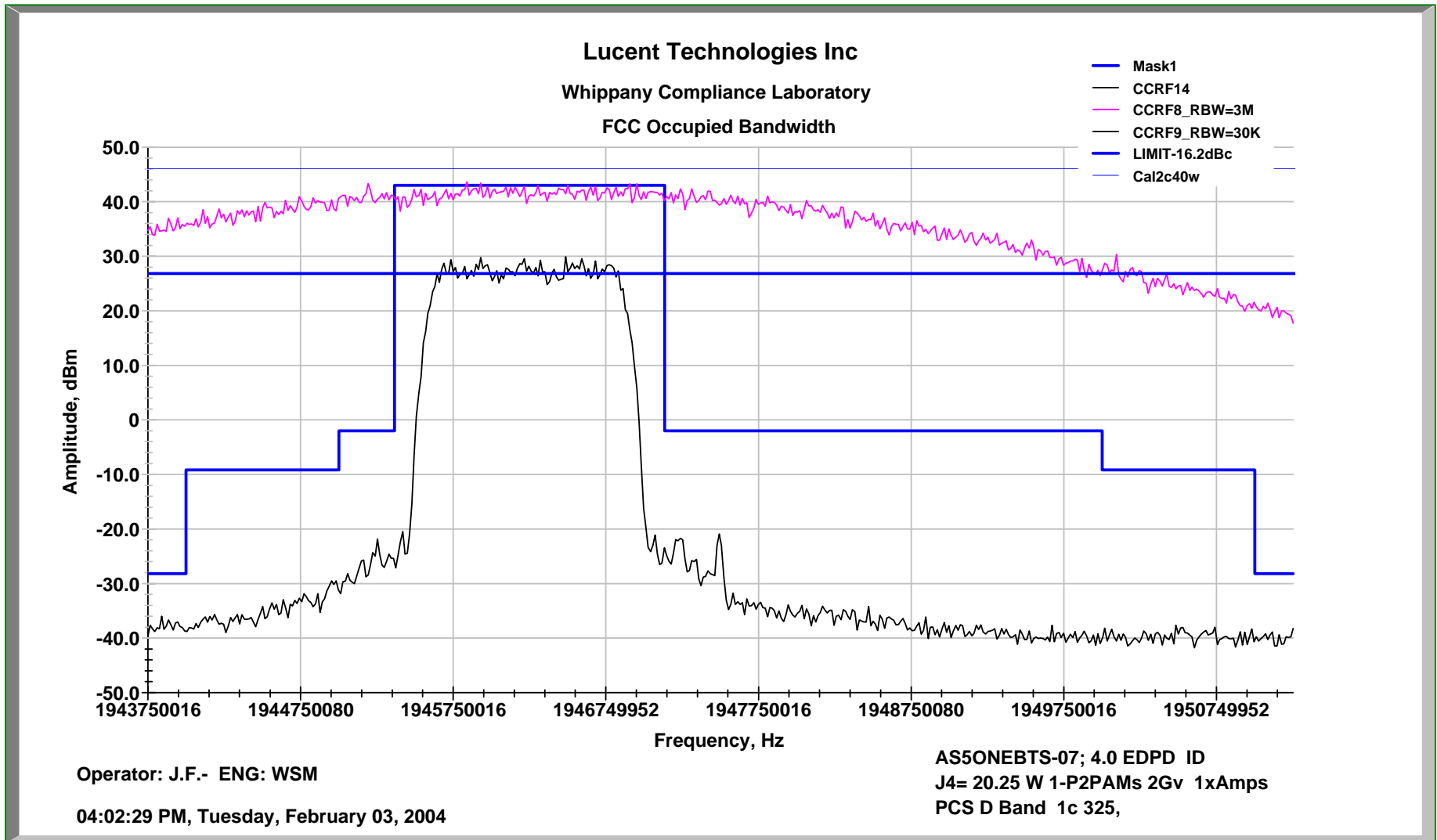

FCC Occupied Bandwidth Data, B Band 1-P2Pam/1c Ch 425 @ 20W EDPD

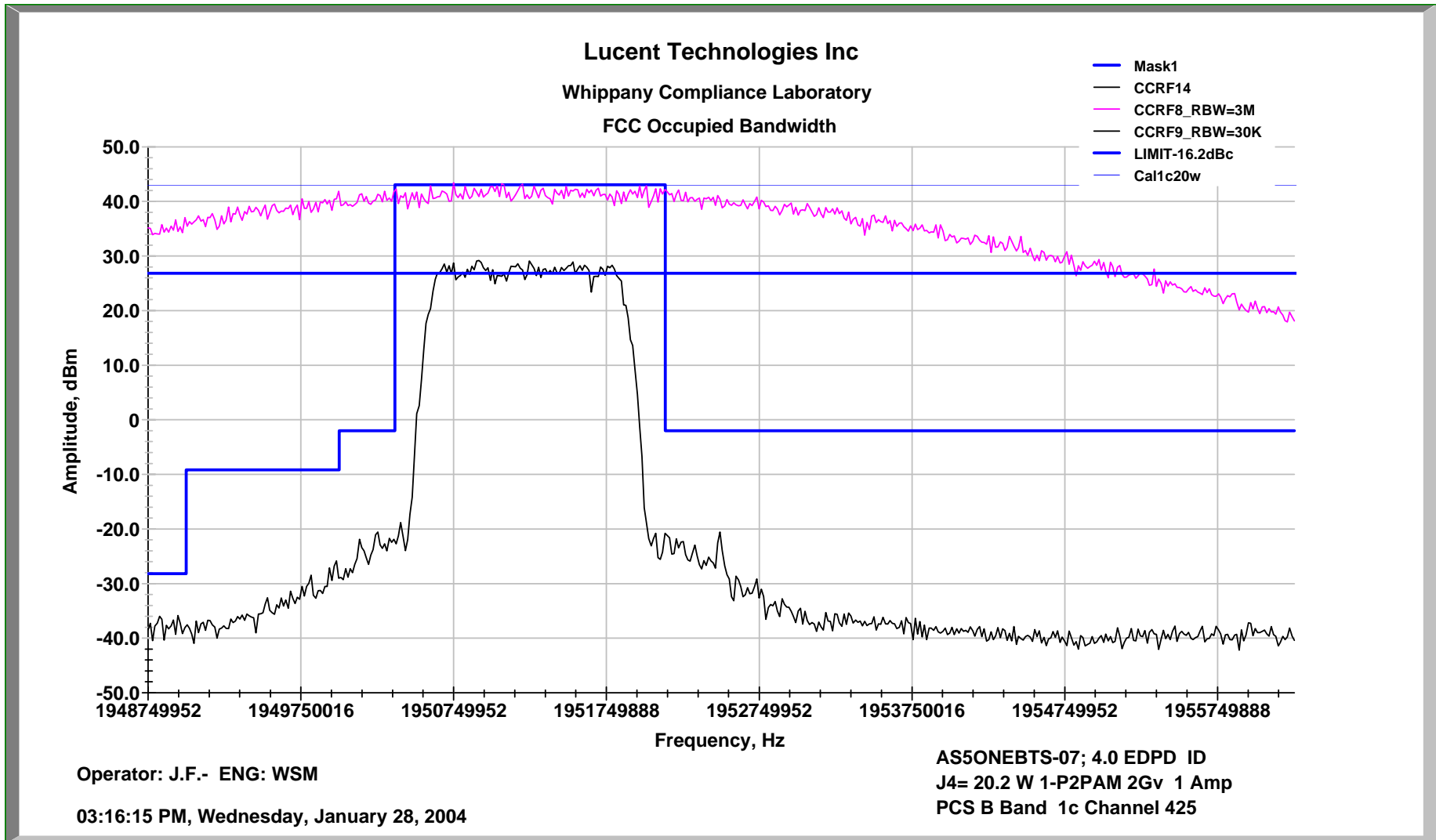

FCC Occupied Bandwidth Data, E Band 1-P2Pam/1c Ch 725 @ 20W EDPD

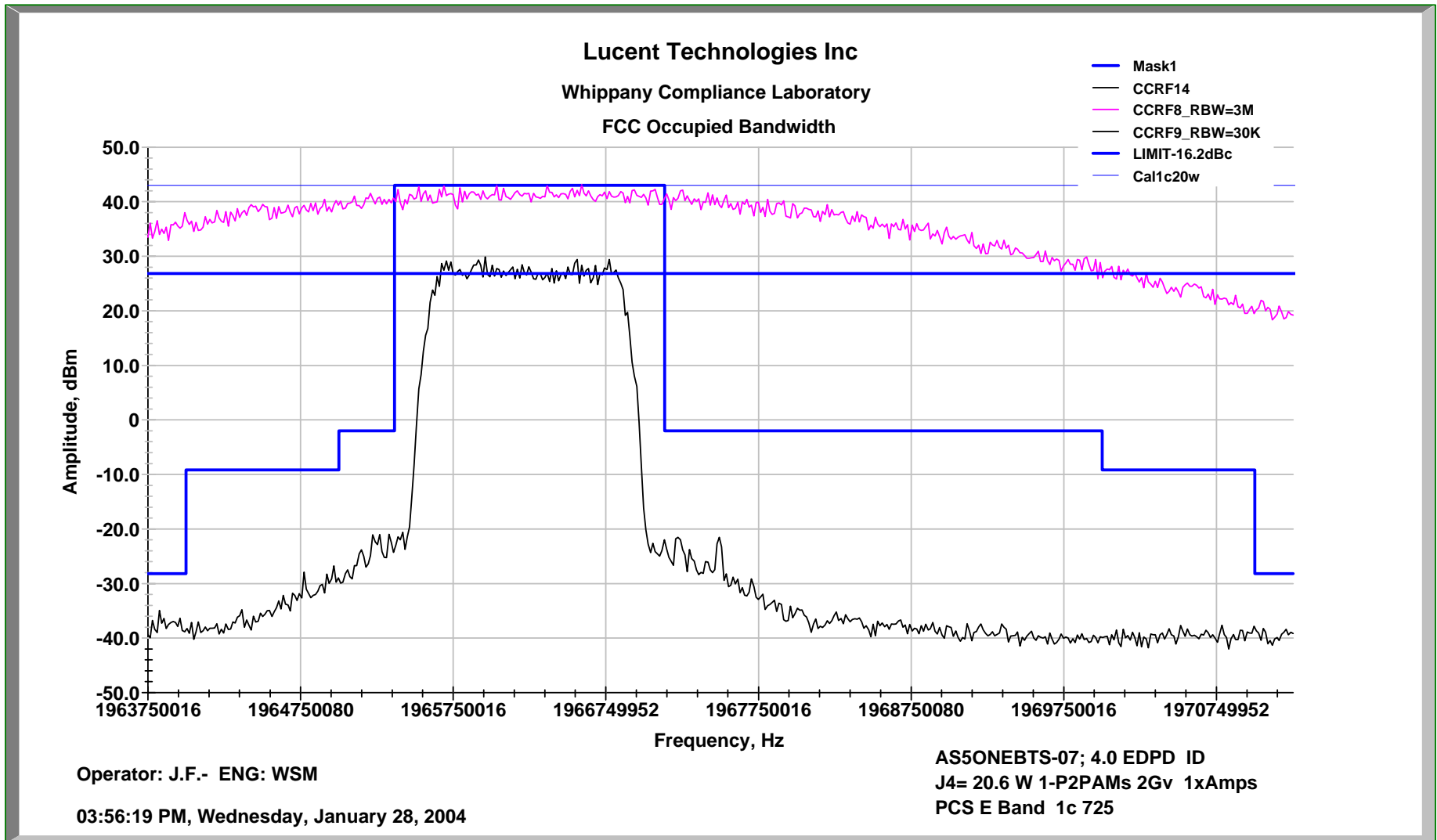

FCC Occupied Bandwidth Data, F Band 1-P2Pam/1c Ch 825 @ 20W EDPD

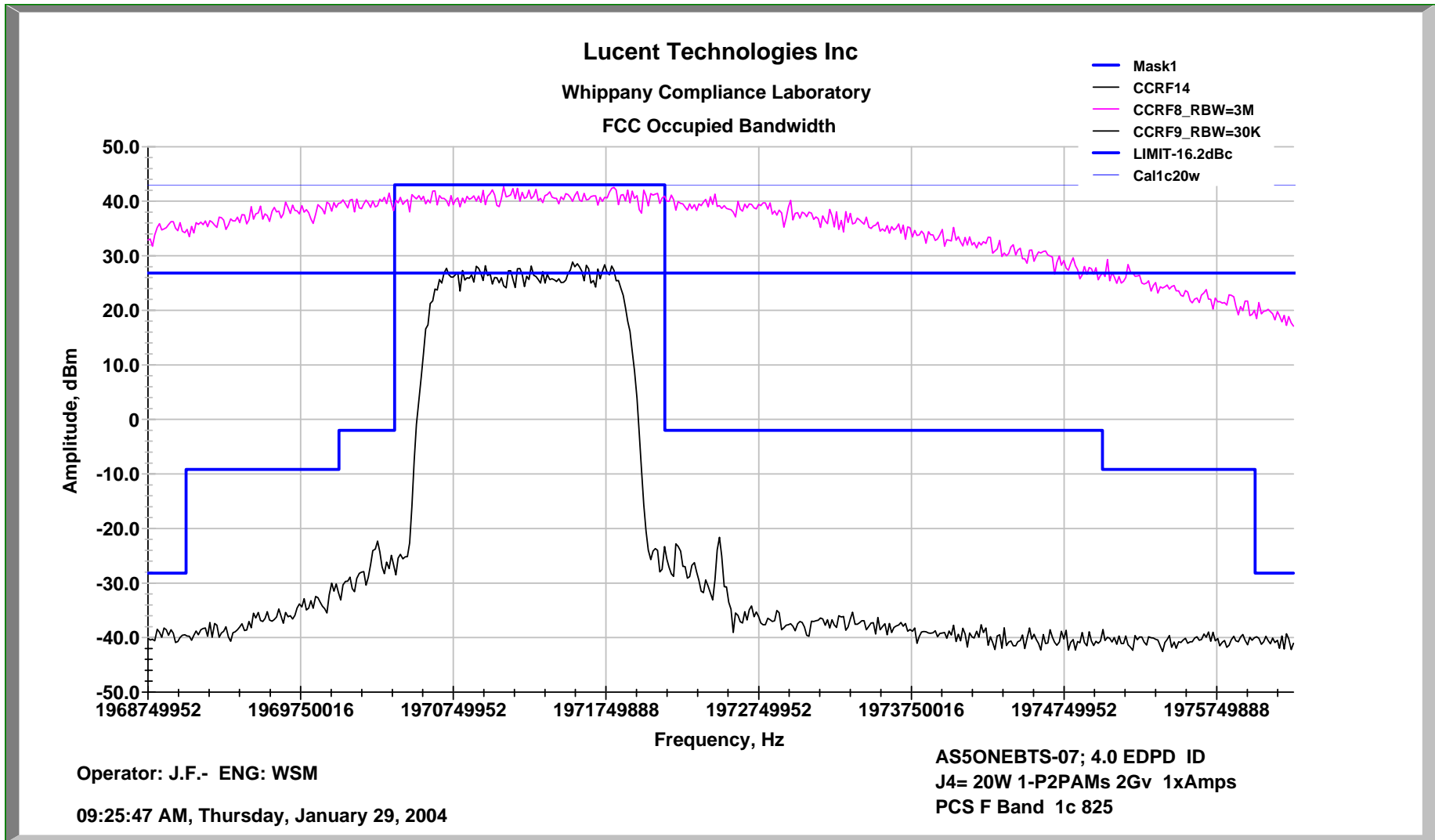

FCC Occupied Bandwidth Data, C Band 1-P2Pam/1c Ch 925 @ 20W EDPD

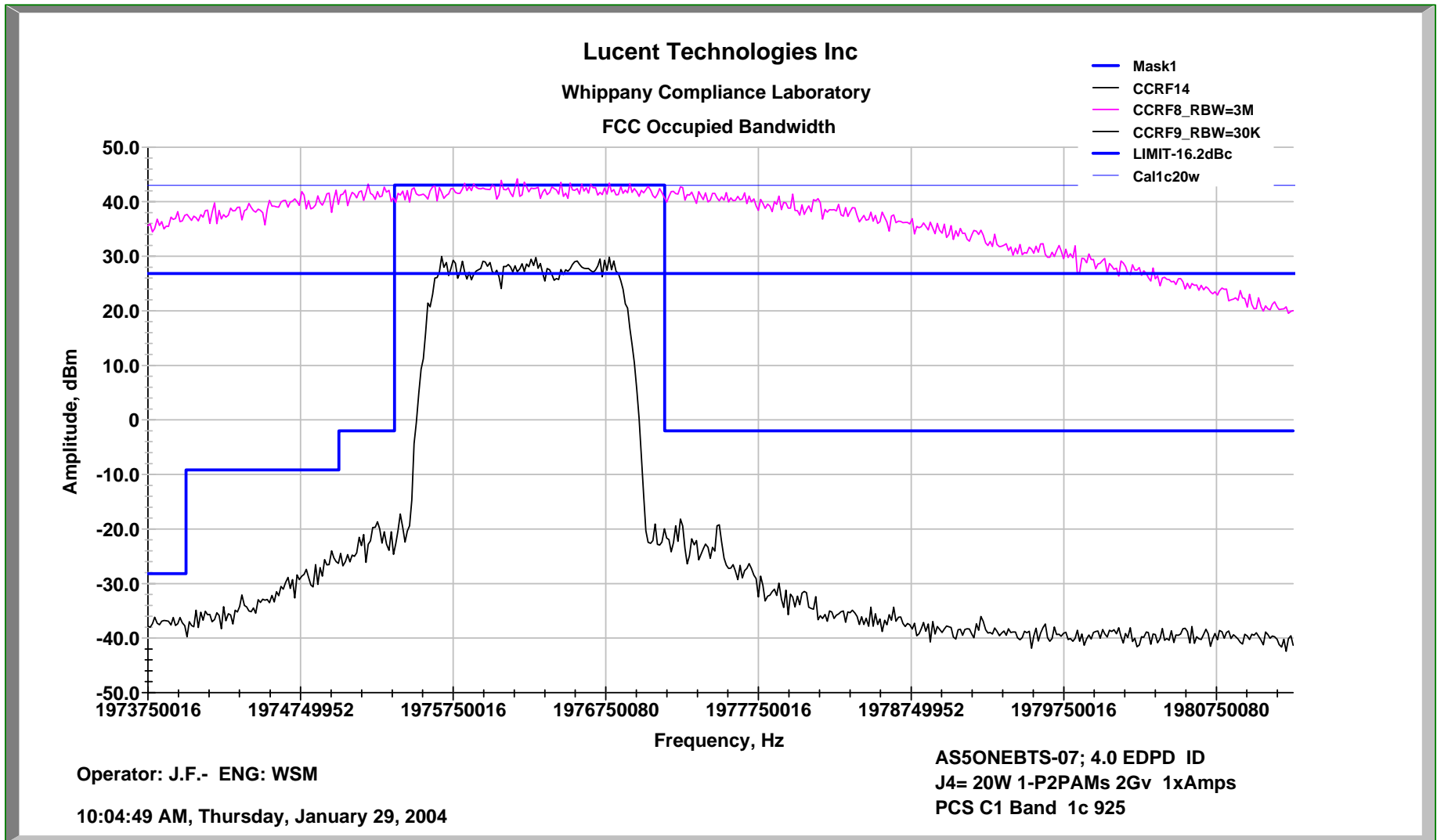

FCC Occupied Bandwidth Data, A Band 1-P2Pam/2c Ch 25, 50 @ 40W EDPD

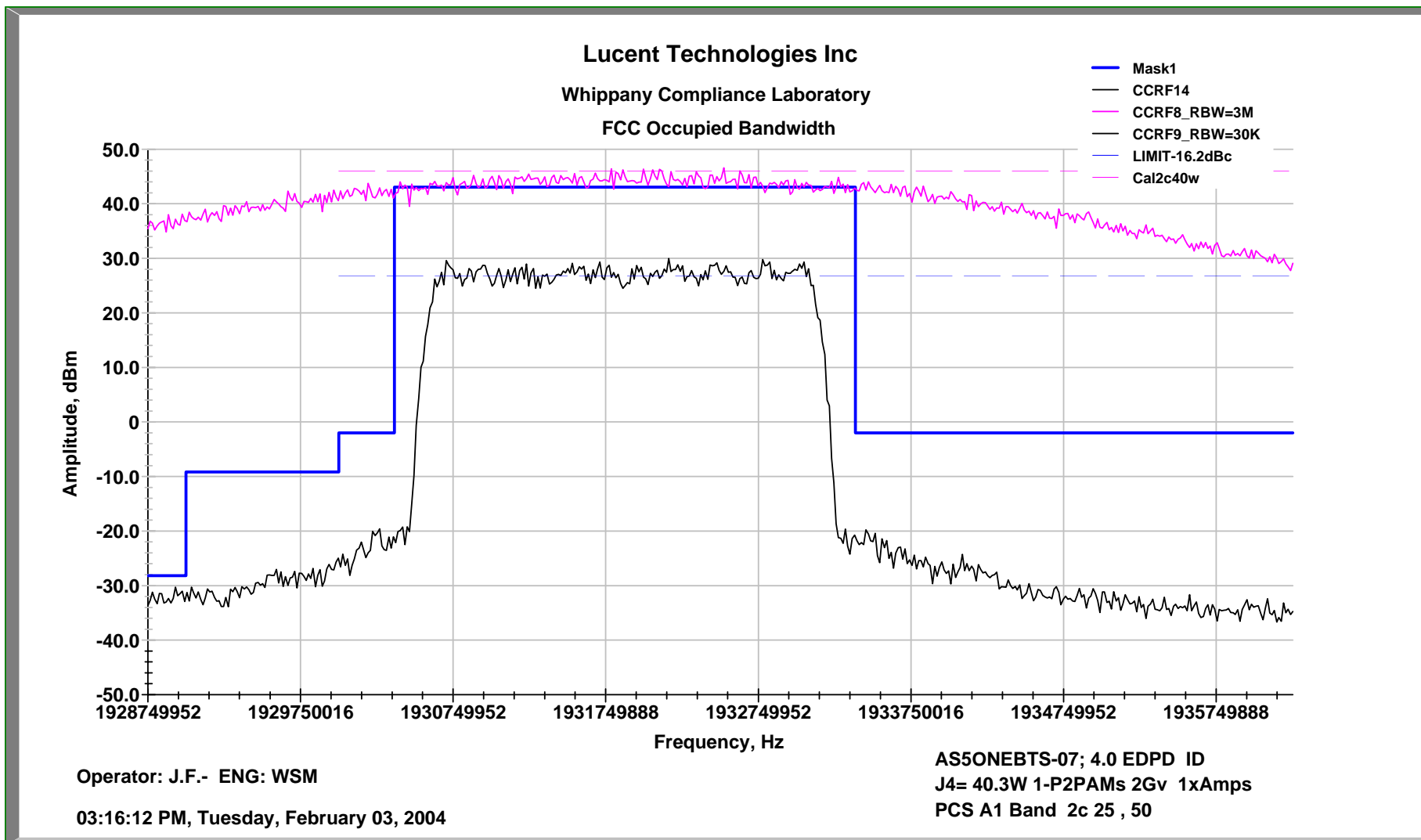

FCC Occupied Bandwidth Data, D Band 1-P2Pam/2c Ch 325, 350 @ 40W EDPD

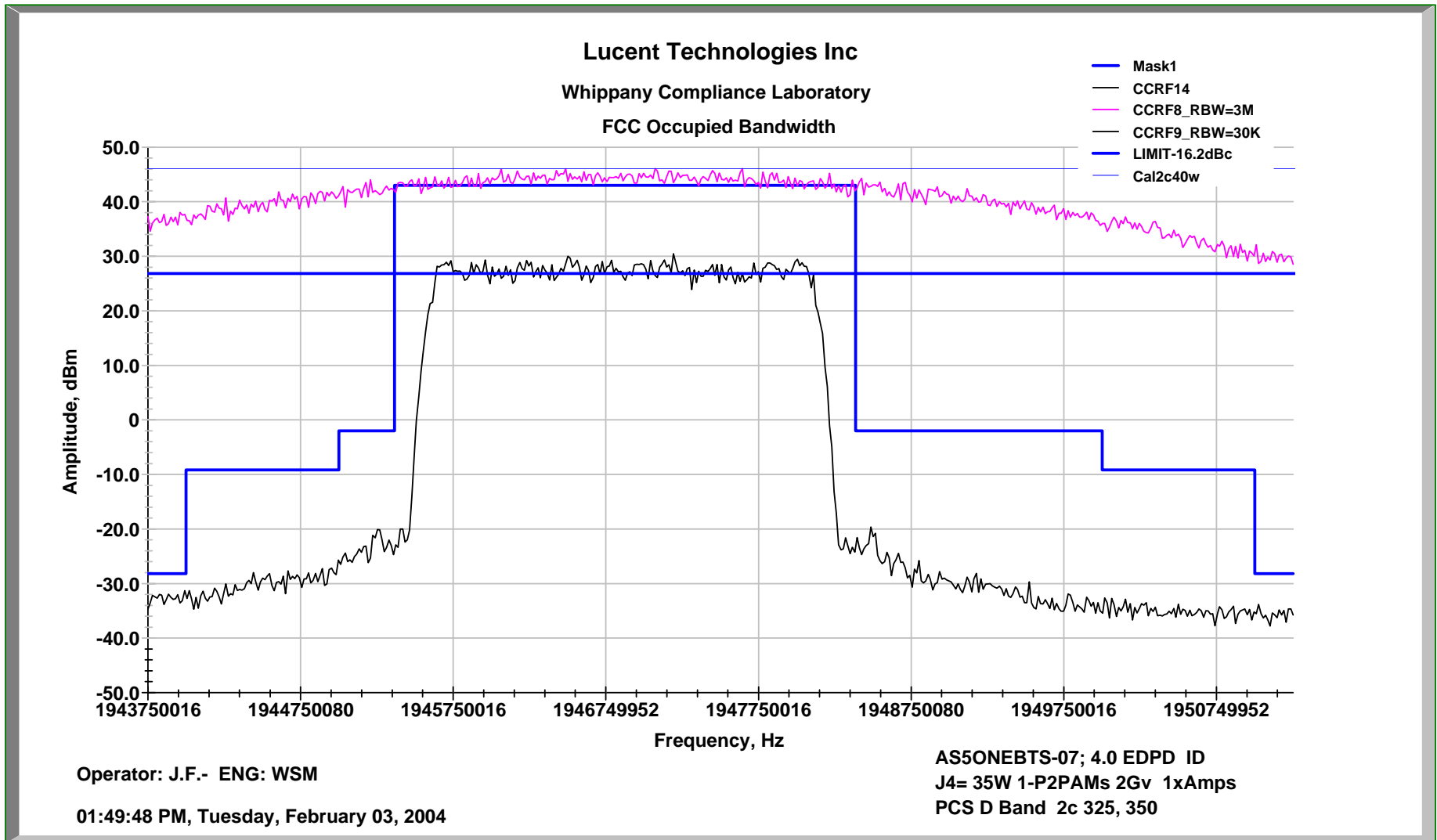

FCC Occupied Bandwidth Data, B Band 1-P2Pam/2c Ch 425, 450 @ 40W EDPD

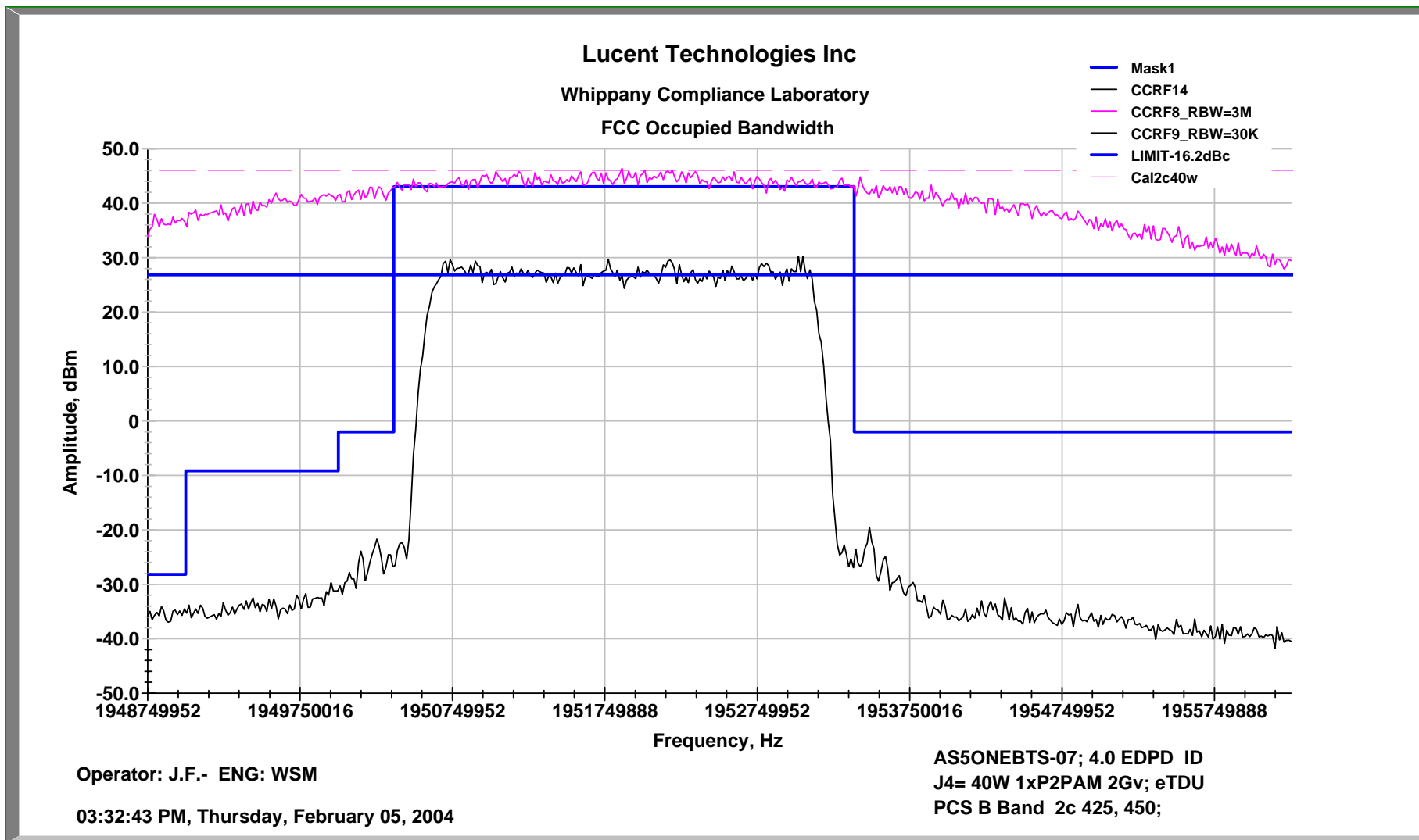

FCC Occupied Bandwidth Data, E Band 1-P2Pam/2c Ch 725, 750 @ 40W EDPD

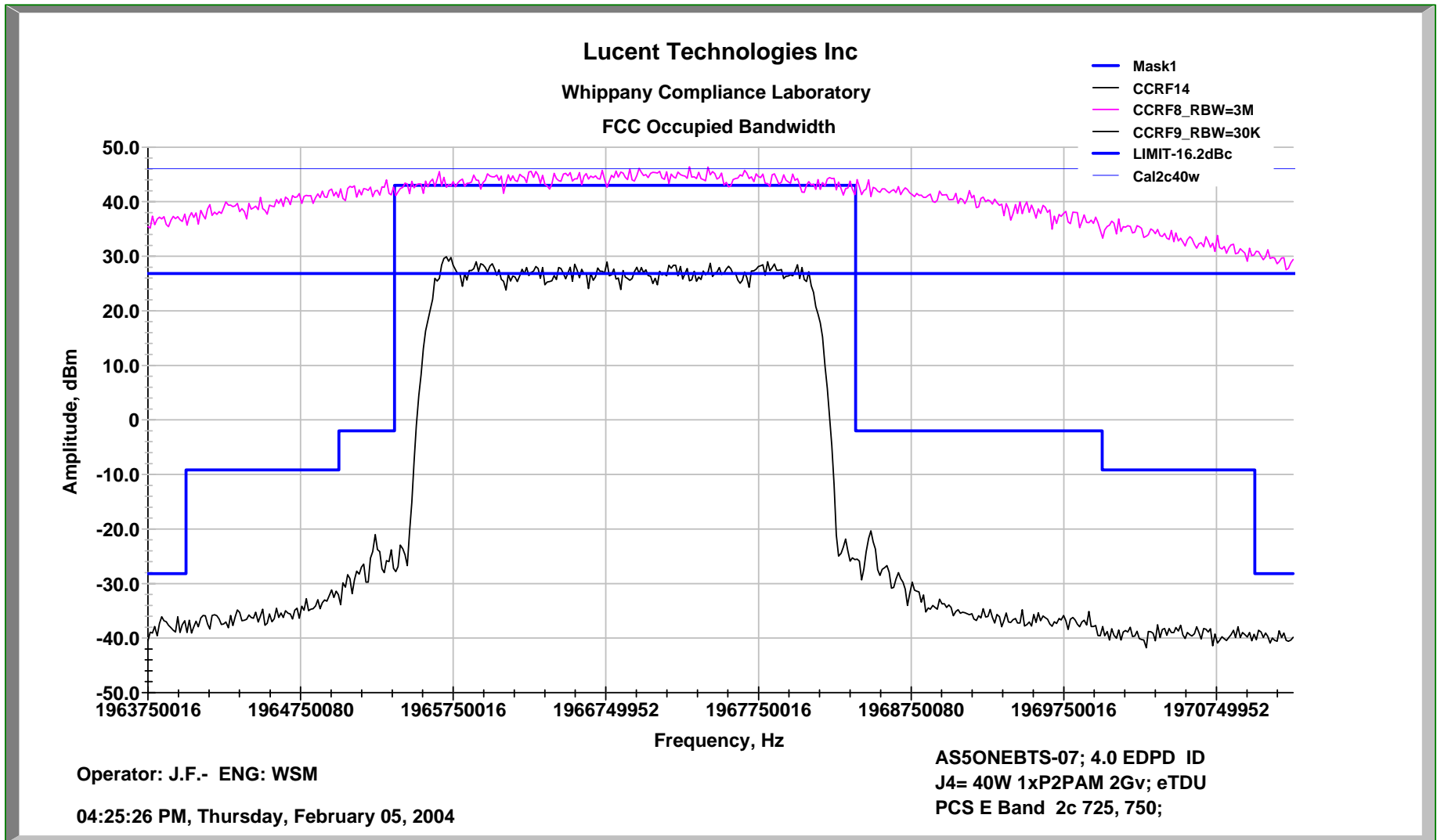

FCC Occupied Bandwidth Data, F Band 1-P2Pam/2c Ch 825, 850 @ 40W EDPD

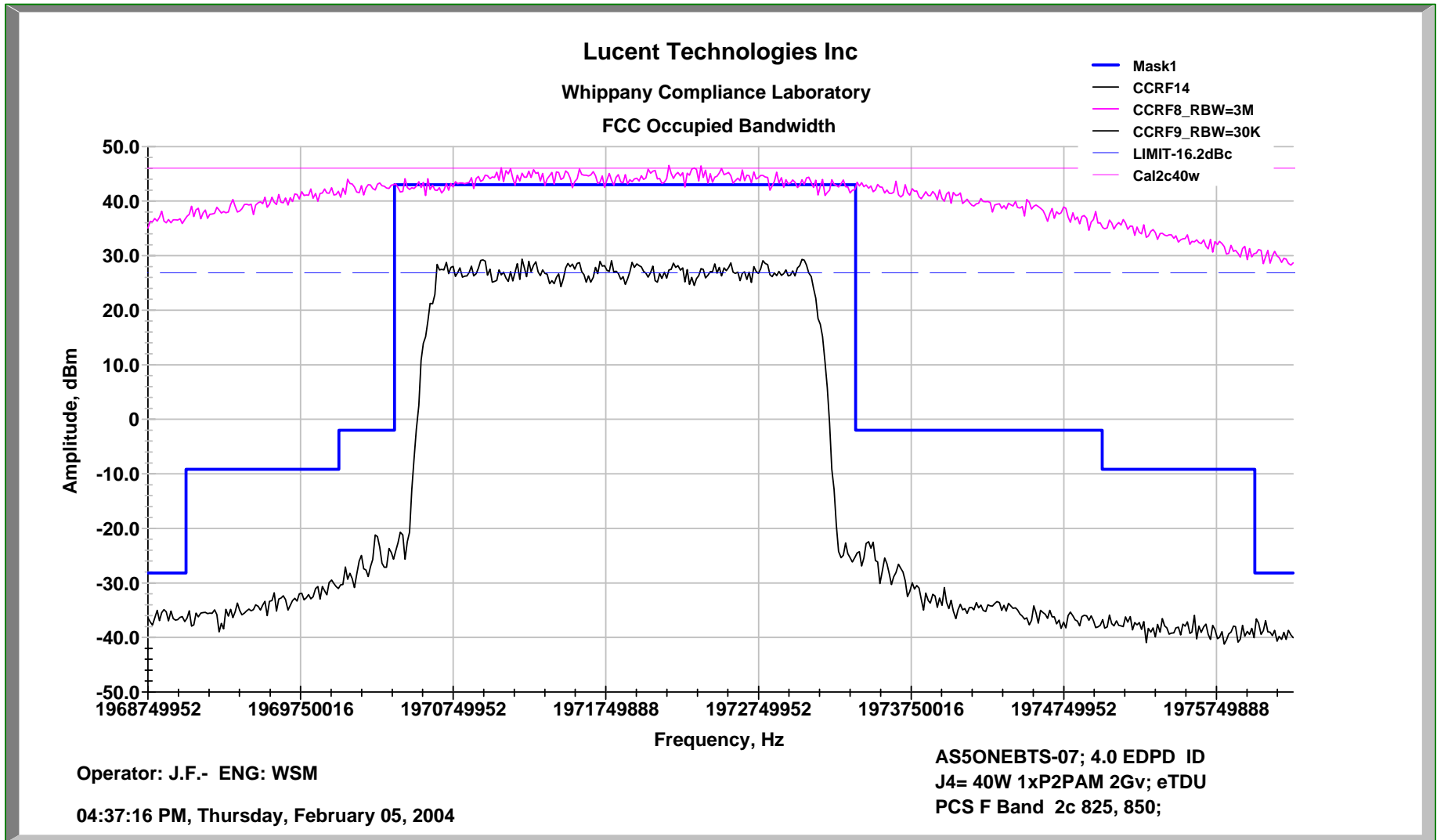

FCC Occupied Bandwidth Data, C Band 1-P2Pam/2c Ch 925, 950 @ 40W EDPD

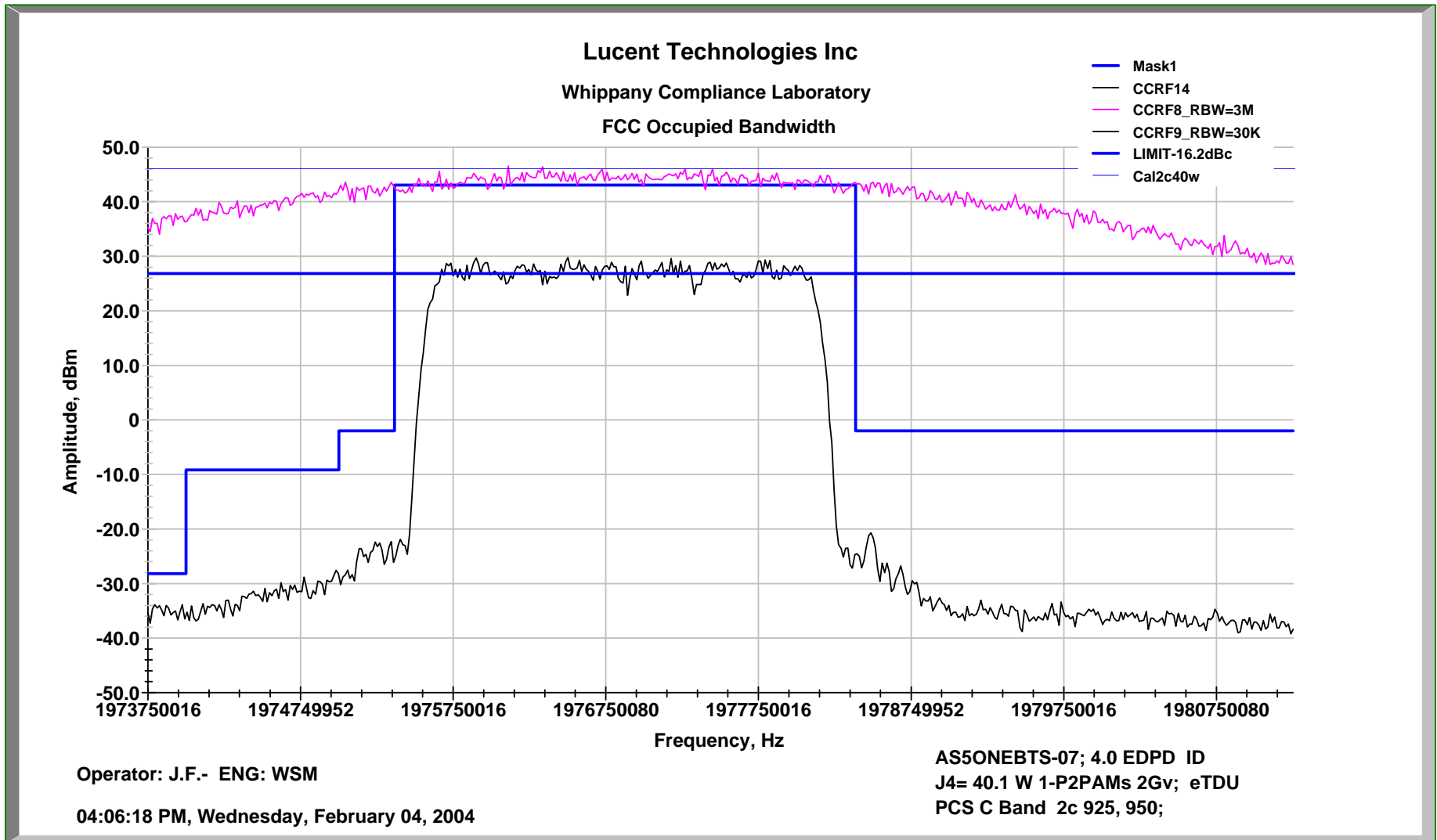

FCC Occupied Bandwidth Data, A Band 2-P2Pam/1c Ch 25 @ 20W EDPD

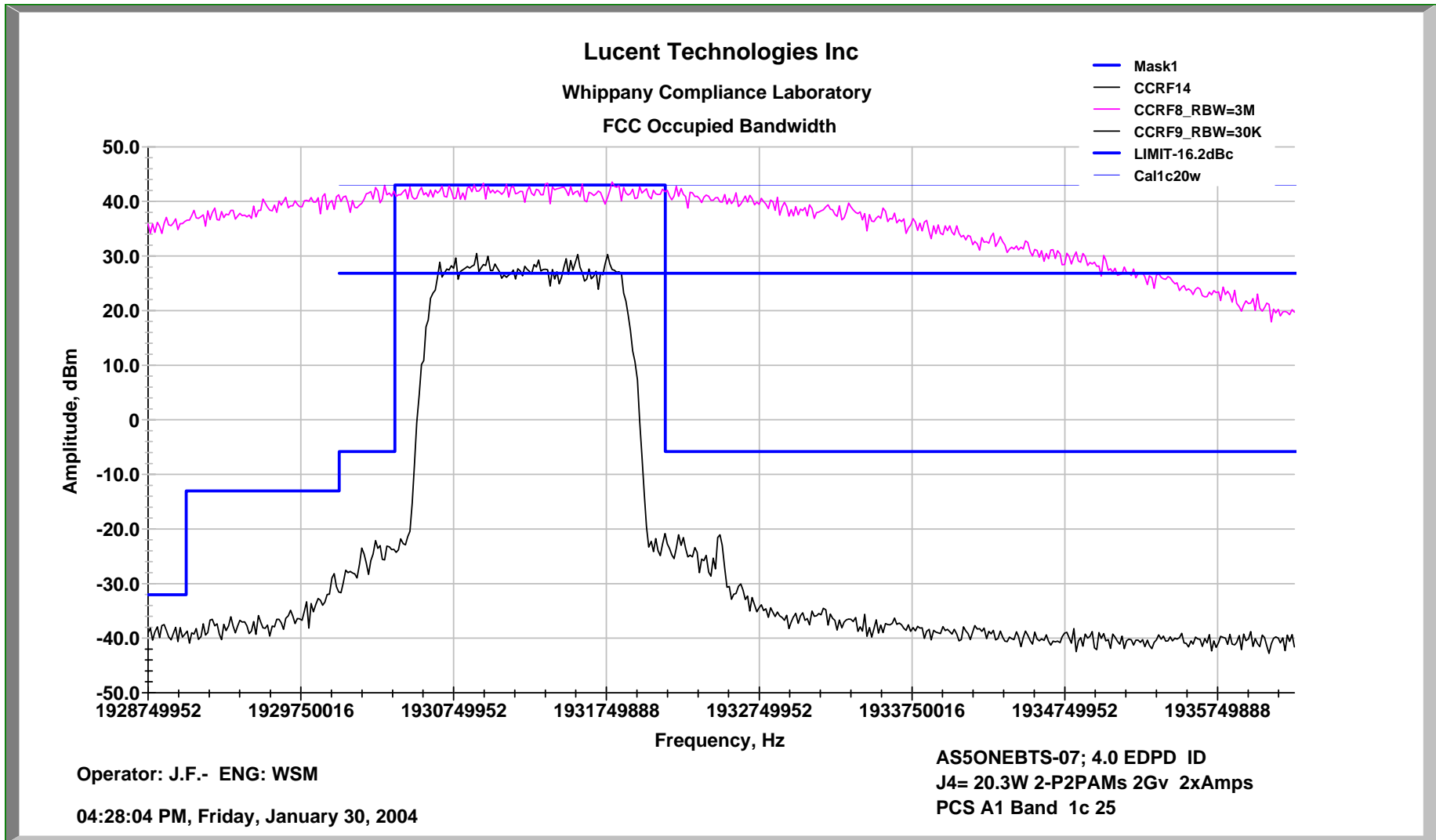

FCC Occupied Bandwidth Data, D Band 2-P2Pam/1c Ch 325 @ 20W EDPD

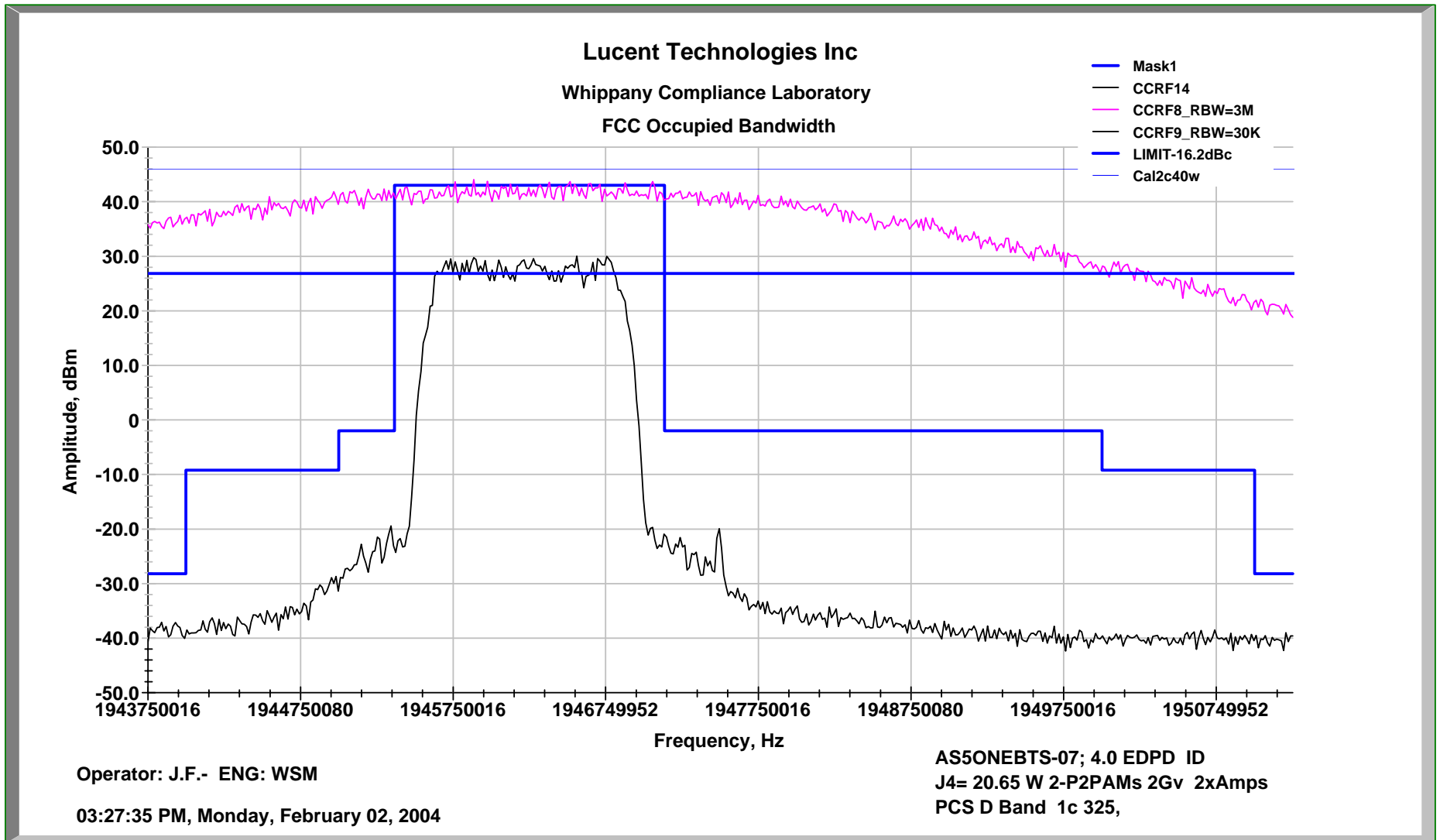

FCC Occupied Bandwidth Data, B Band 2-P2Pam/1c Ch 425 @ 20W EDPD

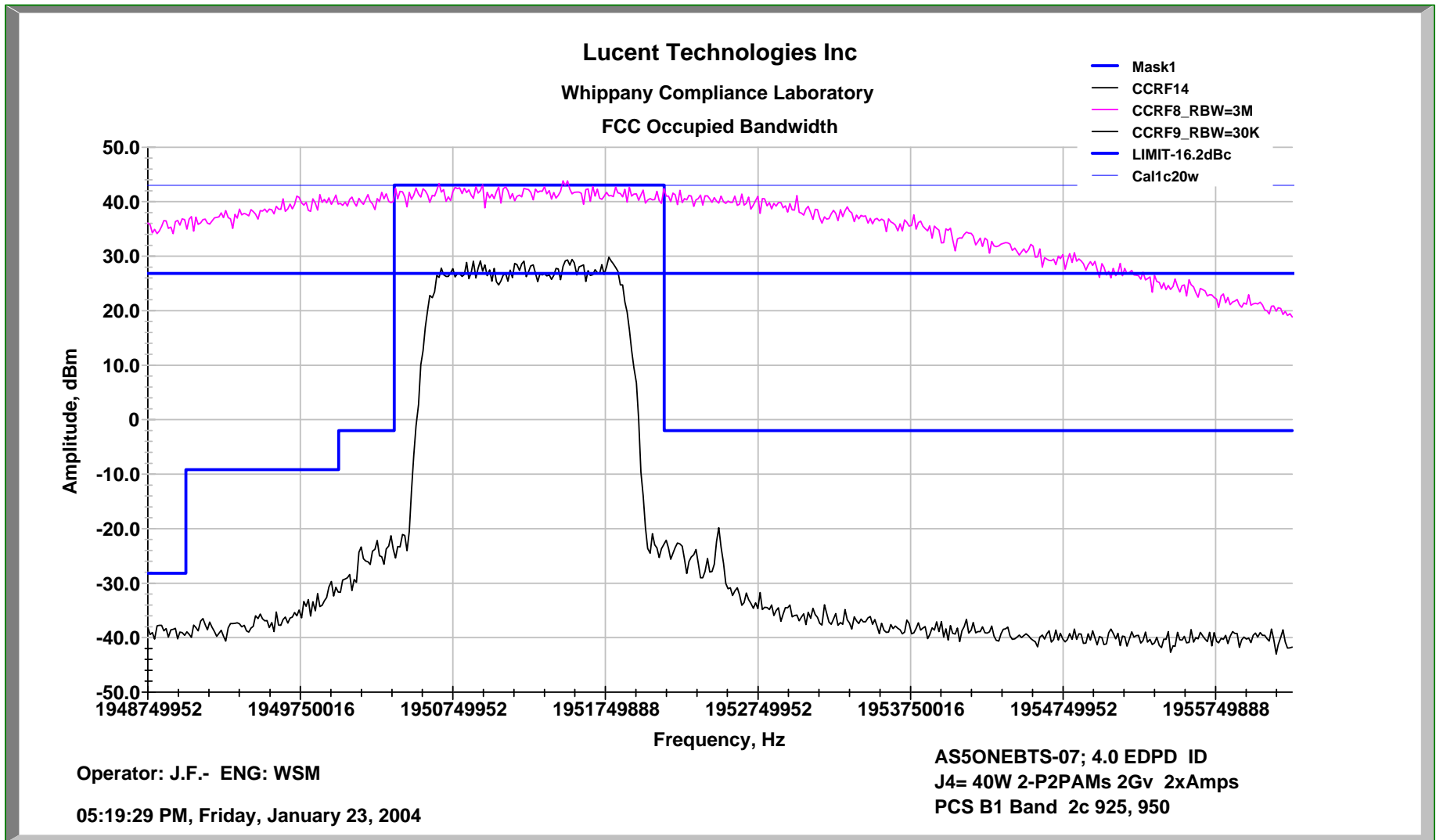

FCC Occupied Bandwidth Data, E Band 2-P2Pam/1c Ch 725 @ 20W EDPD

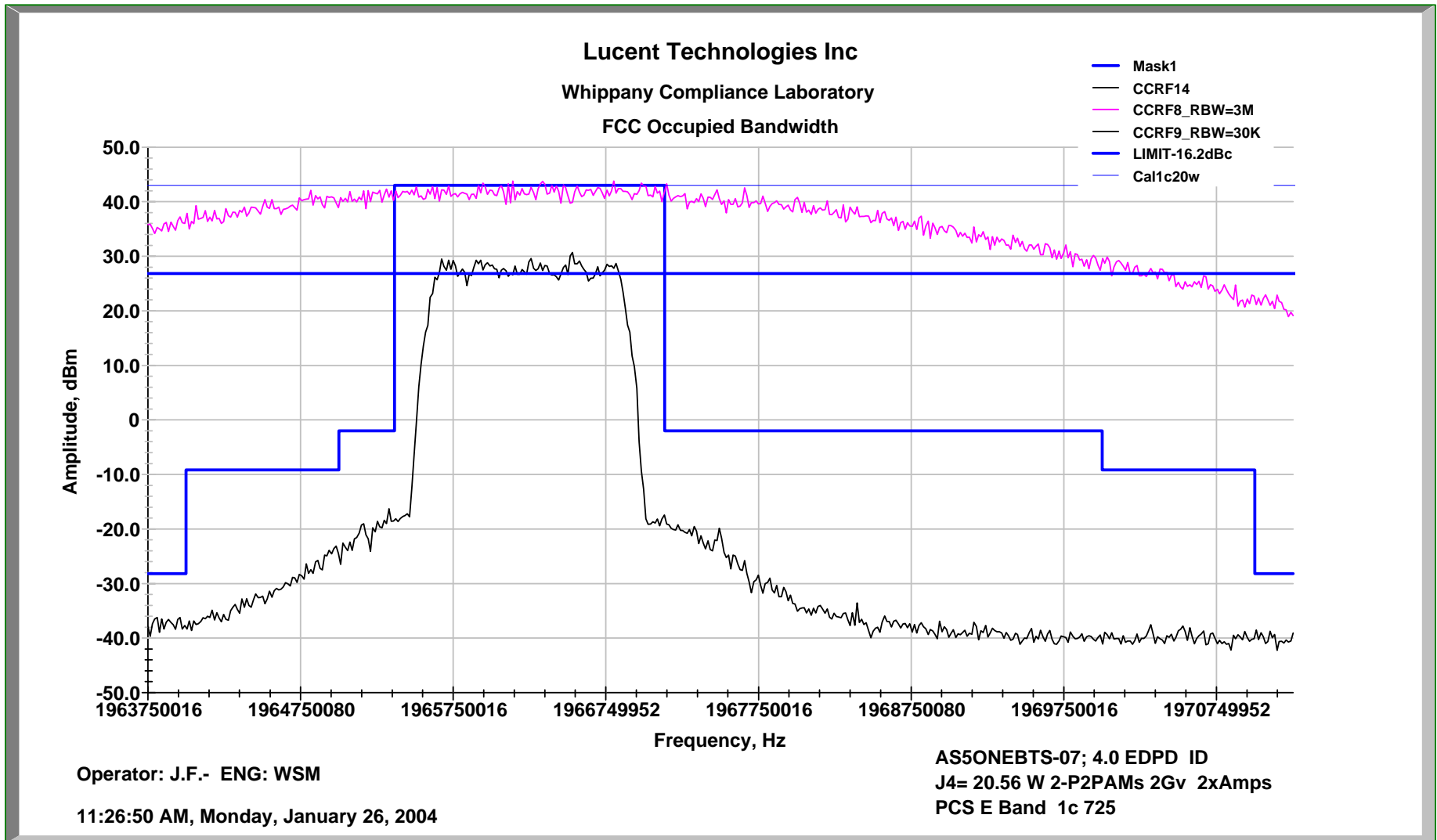

FCC Occupied Bandwidth Data, F Band 2-P2Pam/1c Ch 825 @ 20W EDPD

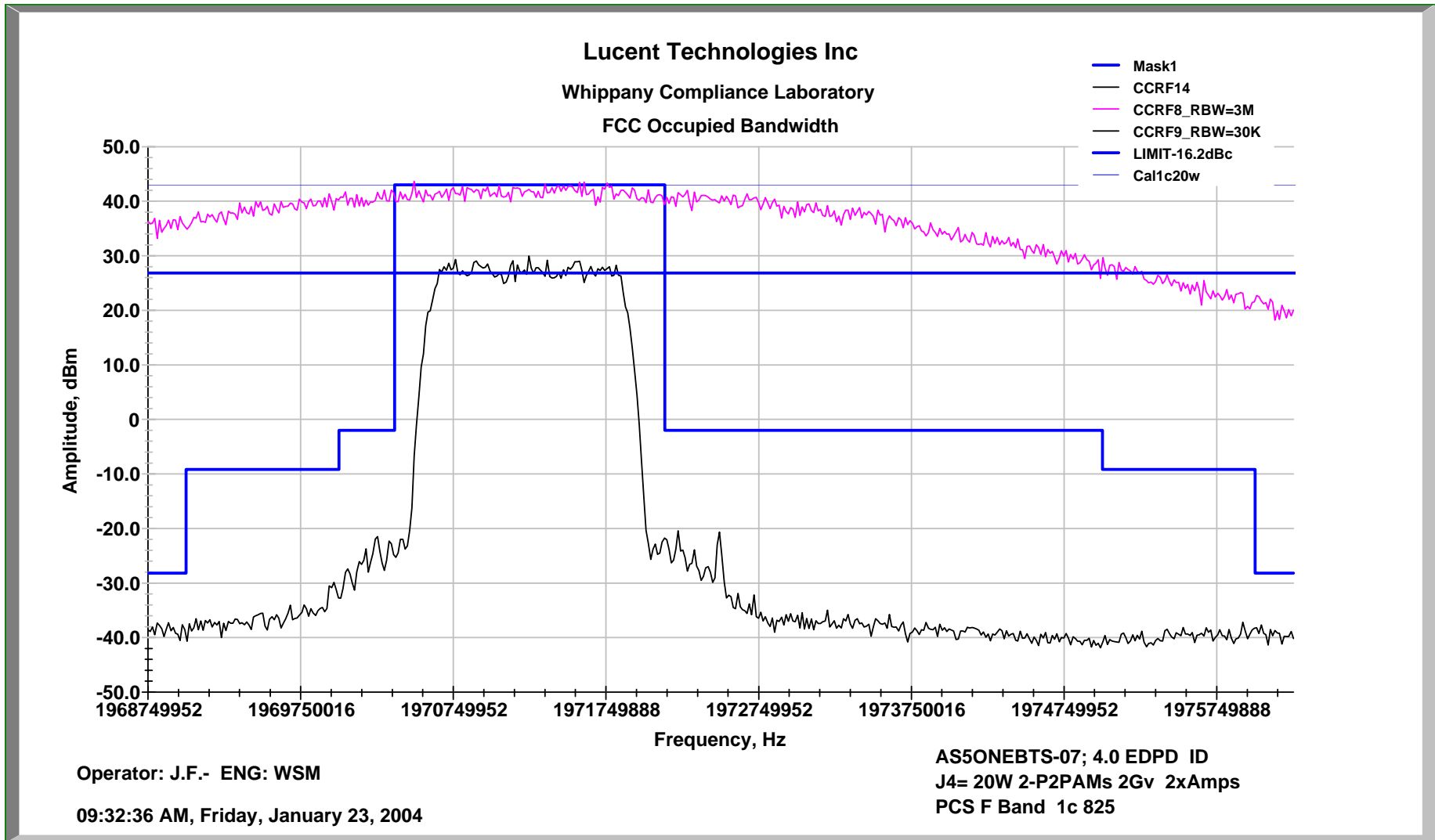

FCC Occupied Bandwidth Data, C Band 2-P2Pam/1c Ch 925 @ 20W EDPD

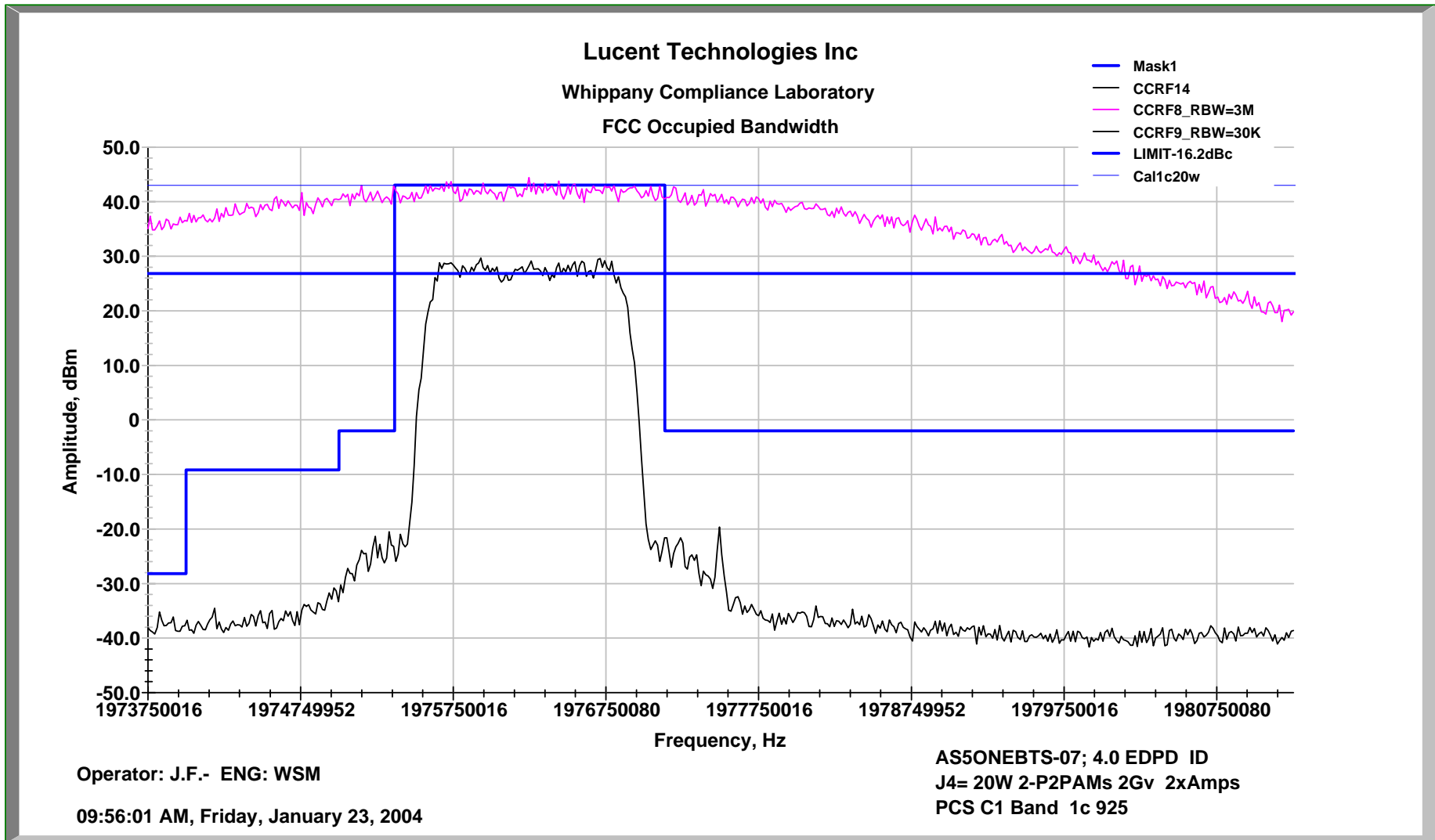

FCC Occupied Bandwidth Data, A Band 2-P2Pam/2c Ch 25,50 @ 40W EDPD

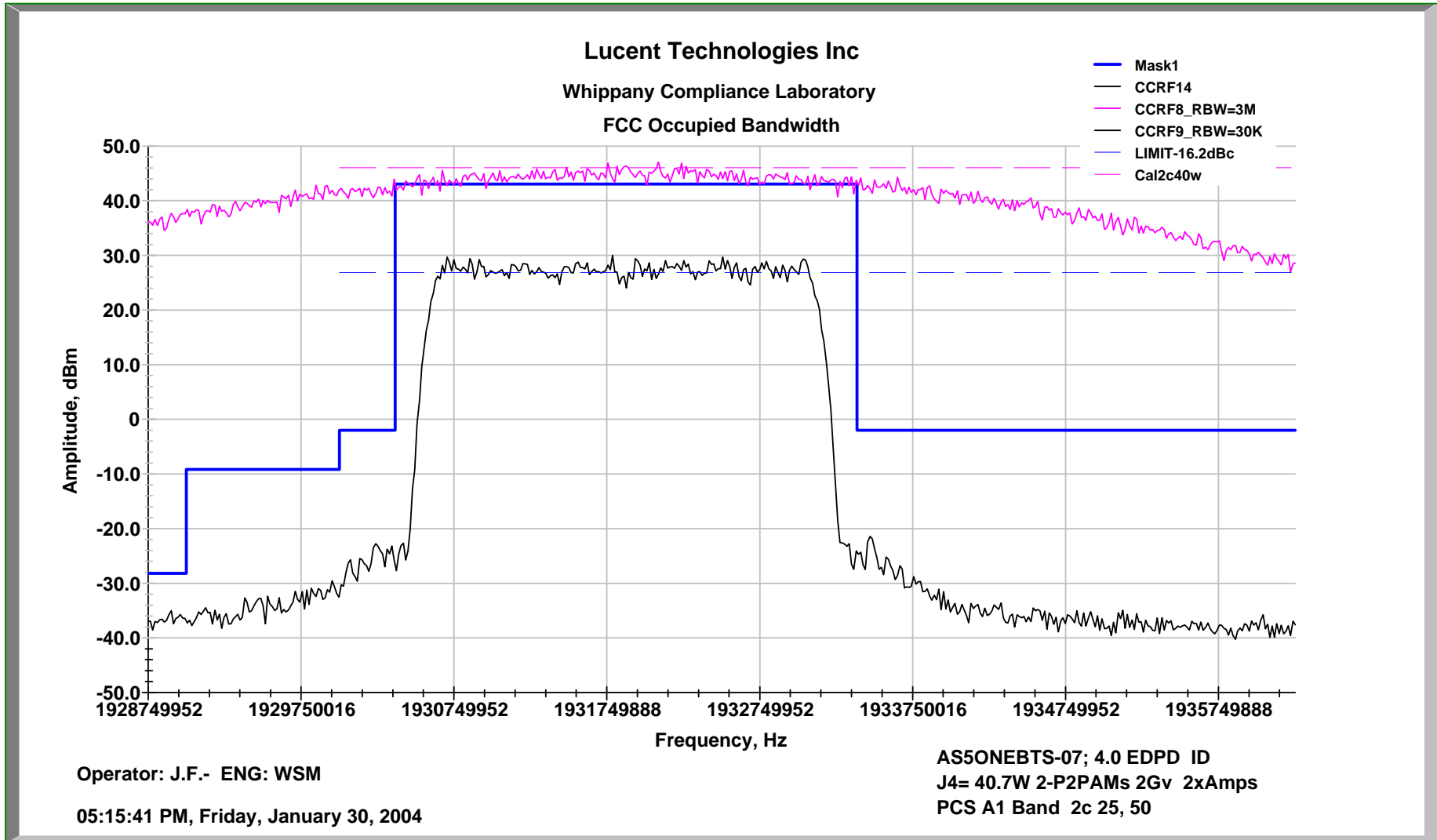

FCC Occupied Bandwidth Data, D Band 2-P2Pam/2c Ch 325, 350 @ 40W EDPD

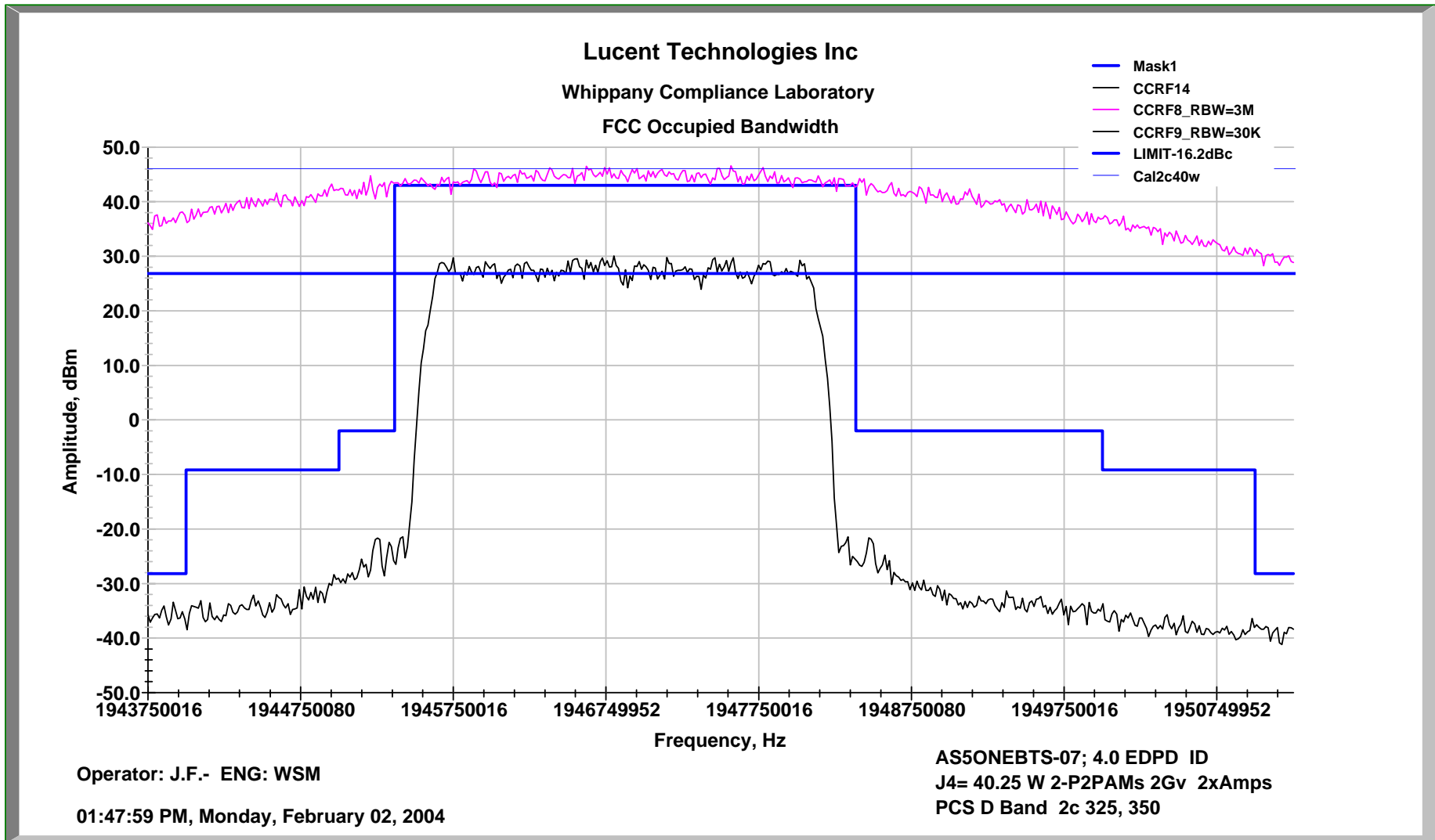

FCC Occupied Bandwidth Data, B Band 2-P2Pam/2c Ch 425,450 @ 40W EDPD

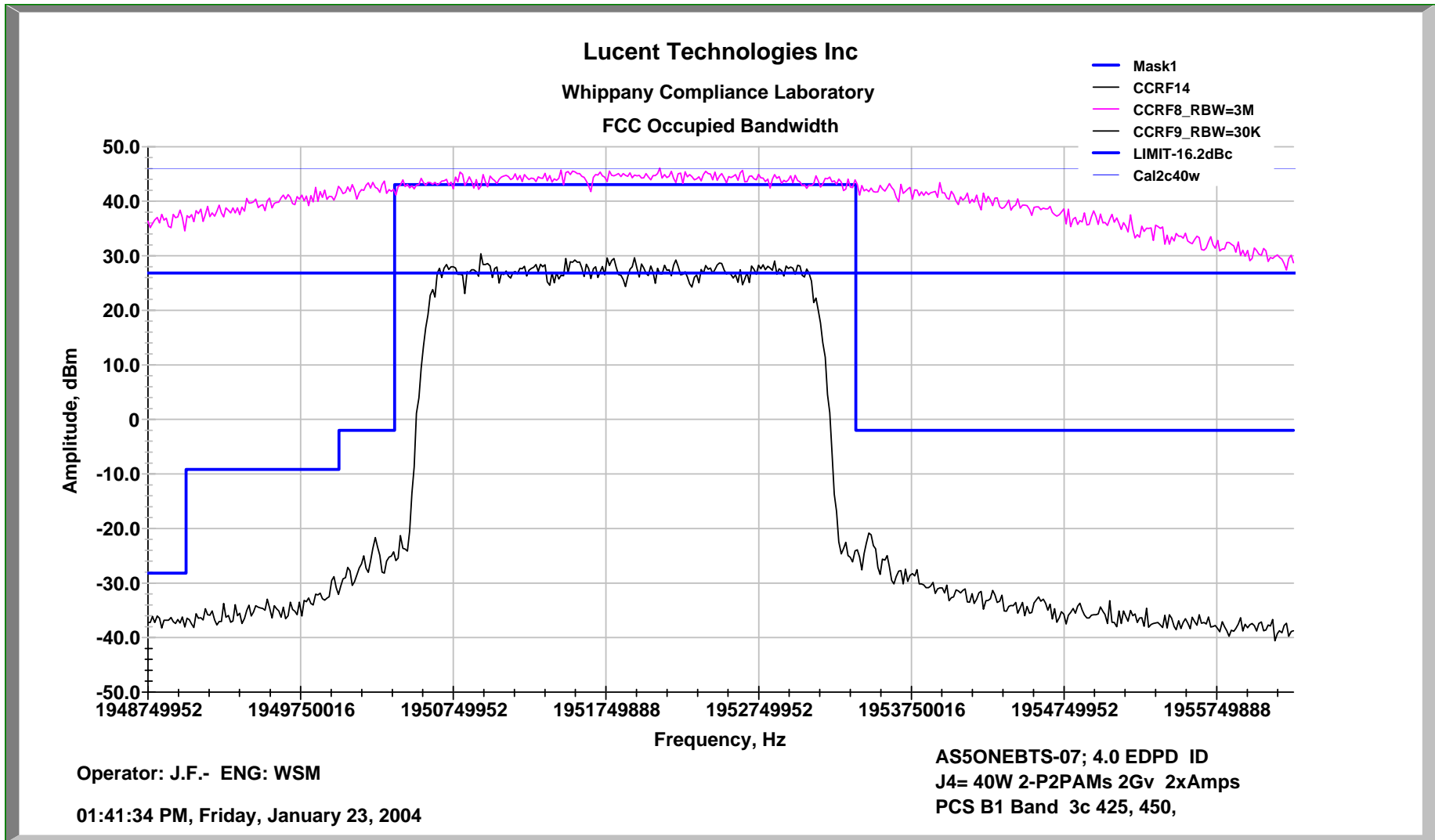

FCC Occupied Bandwidth Data, E Band 2-P2Pam/2c Ch 725, 750 @ 40W EDPD

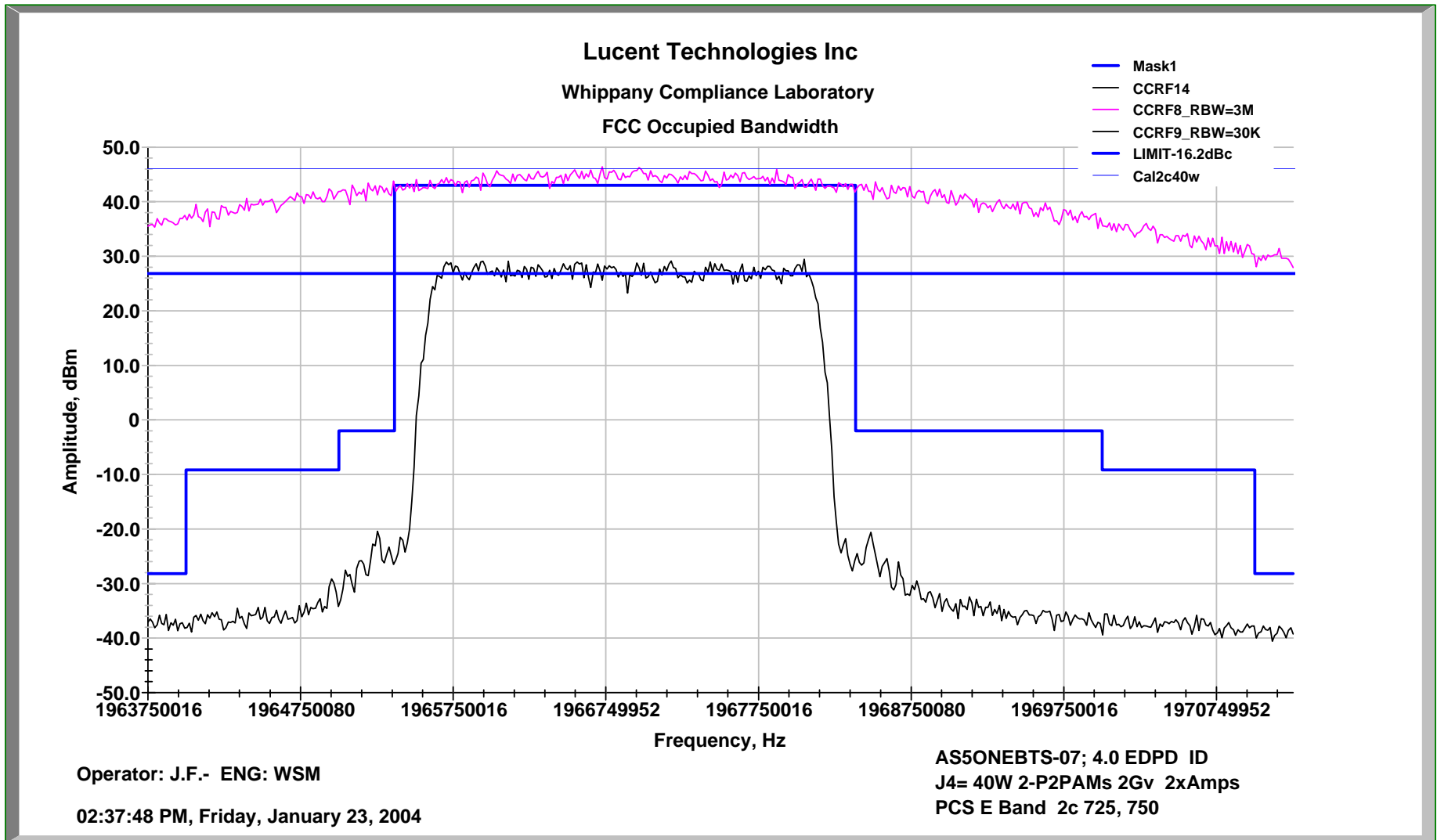

FCC Occupied Bandwidth Data, F Band 2-P2Pam/2c Ch 825, 850 @ 40W EDPD

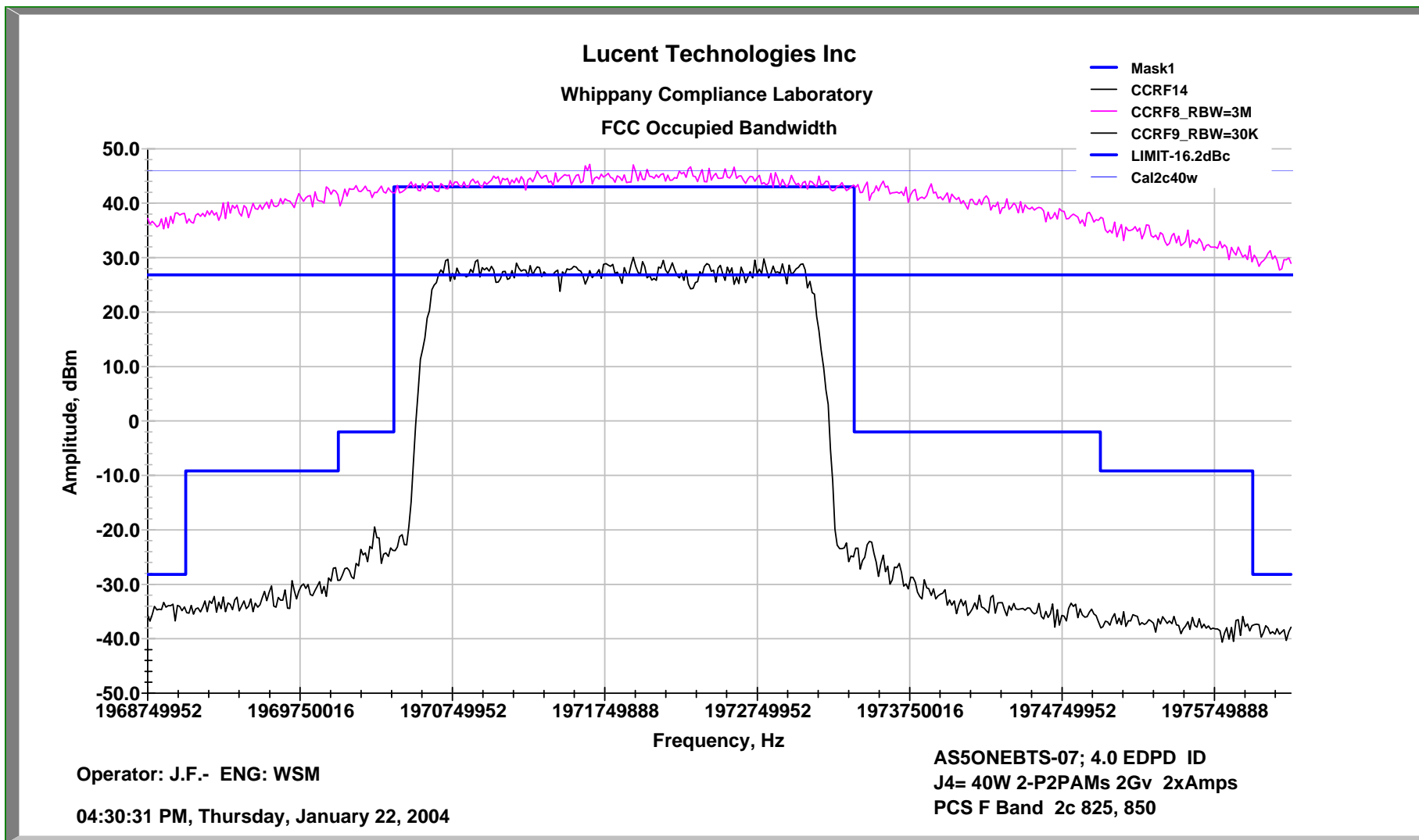

FCC Occupied Bandwidth Data, C Band 2-P2Pam/2c Ch 925, 950 @ 40W EDPD

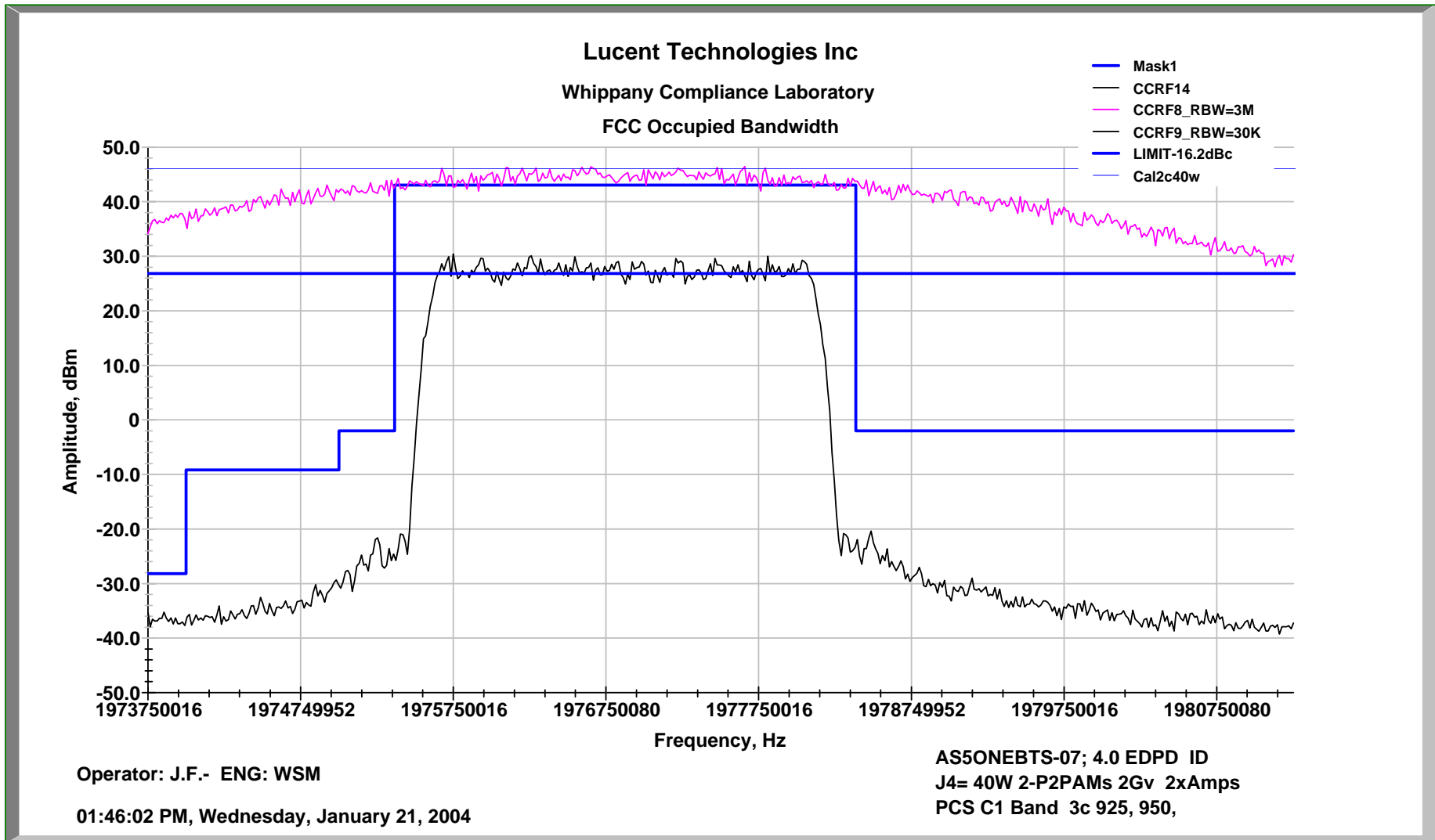

FCC Occupied Bandwidth Data, A Band 2-P2Pam/3c Ch 25,50, 75 @ 60W EDPD

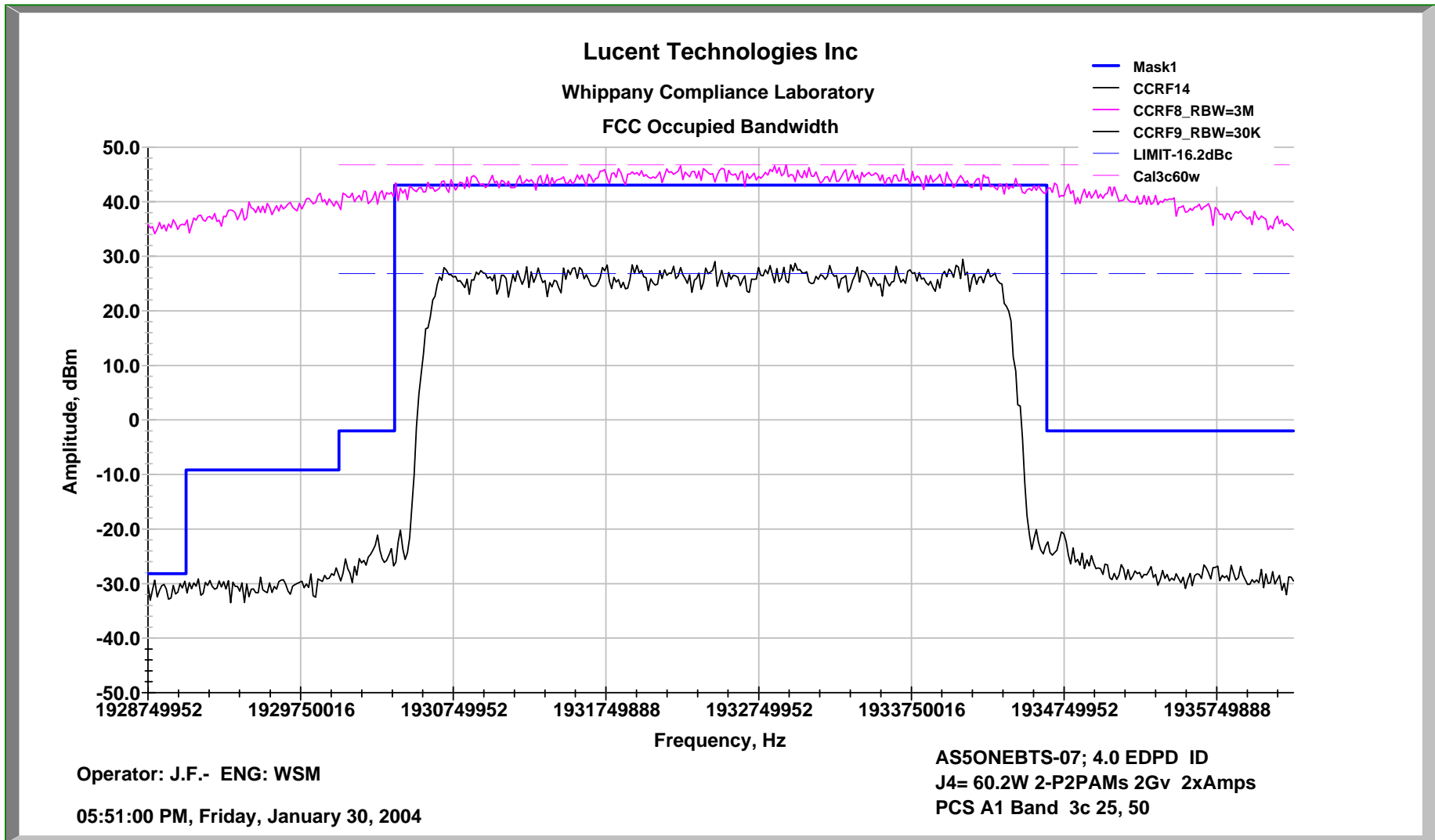

FCC Occupied Bandwidth Data, D Band 2-P2Pam/3c Ch 325, 350, 375 @ 60W EDPD

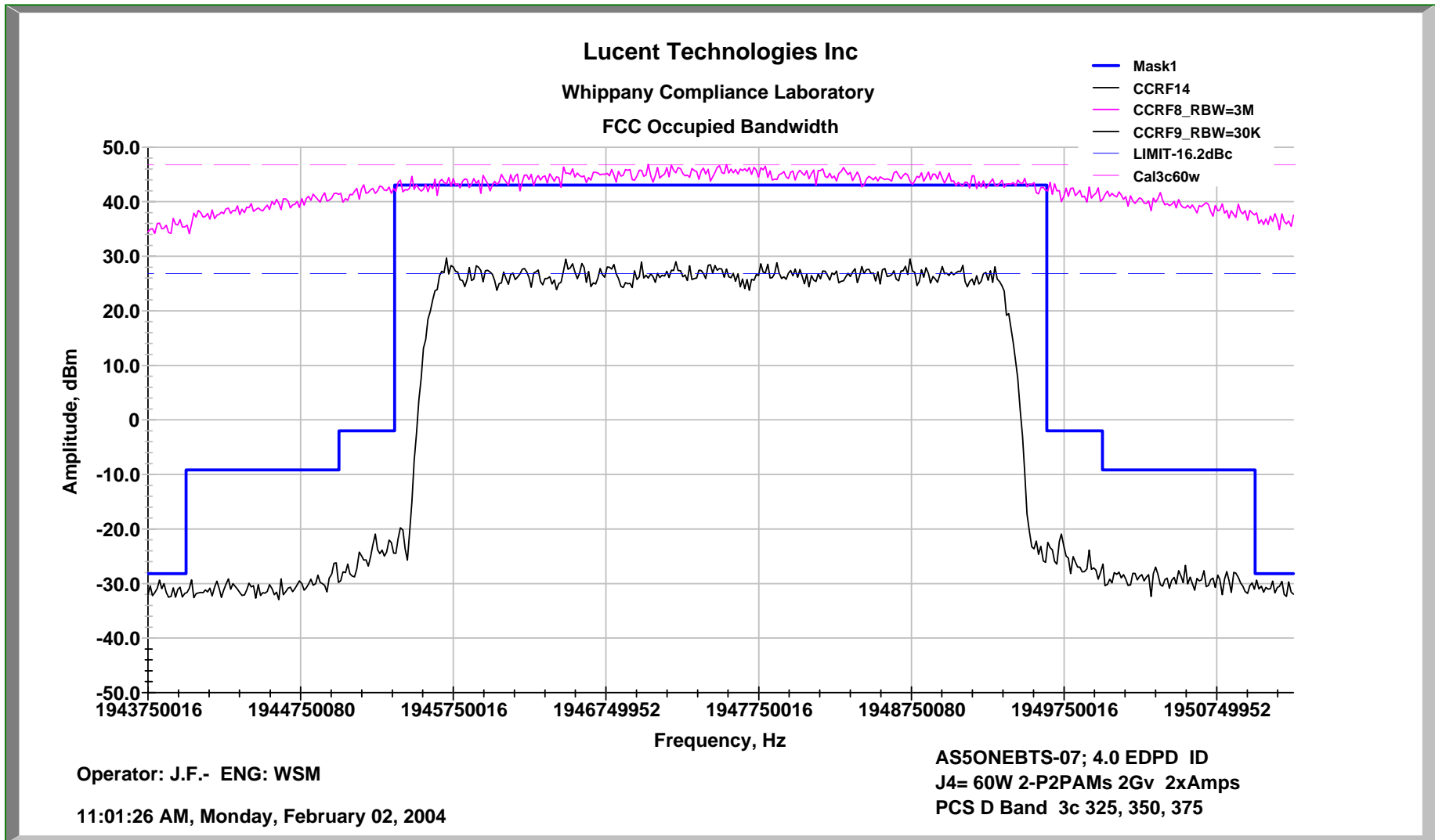

FCC Occupied Bandwidth Data, B Band 2-P2Pam/3c Ch 425,450, 475 @ 60W EDPD

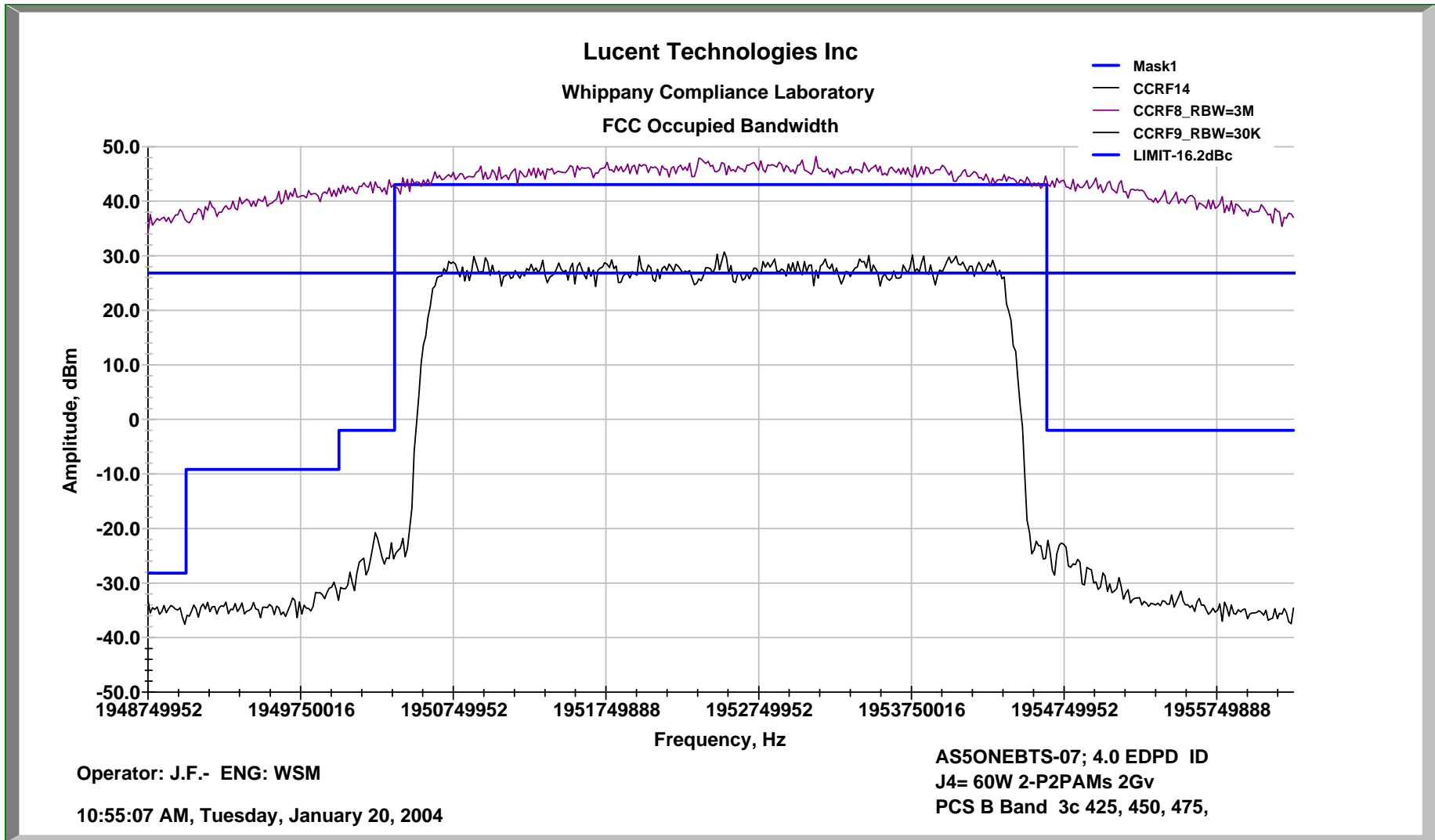

FCC Occupied Bandwidth Data, E Band 2-P2Pam/3c Ch 725, 750, 775 @ 60W EDPD

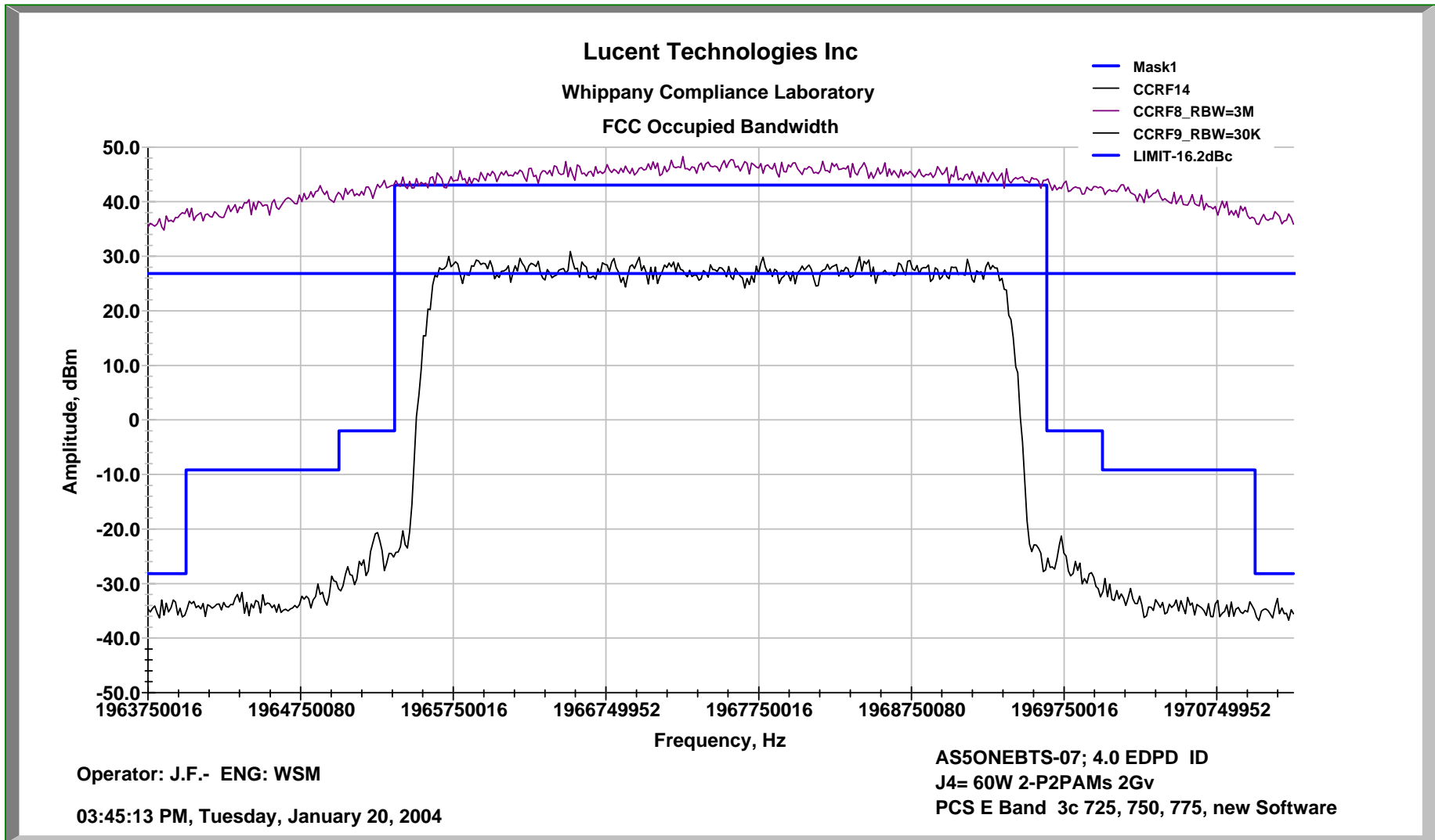

FCC Occupied Bandwidth Data, F Band 2-P2Pam/3c Ch 825, 850, 875 @ 60W EDPD

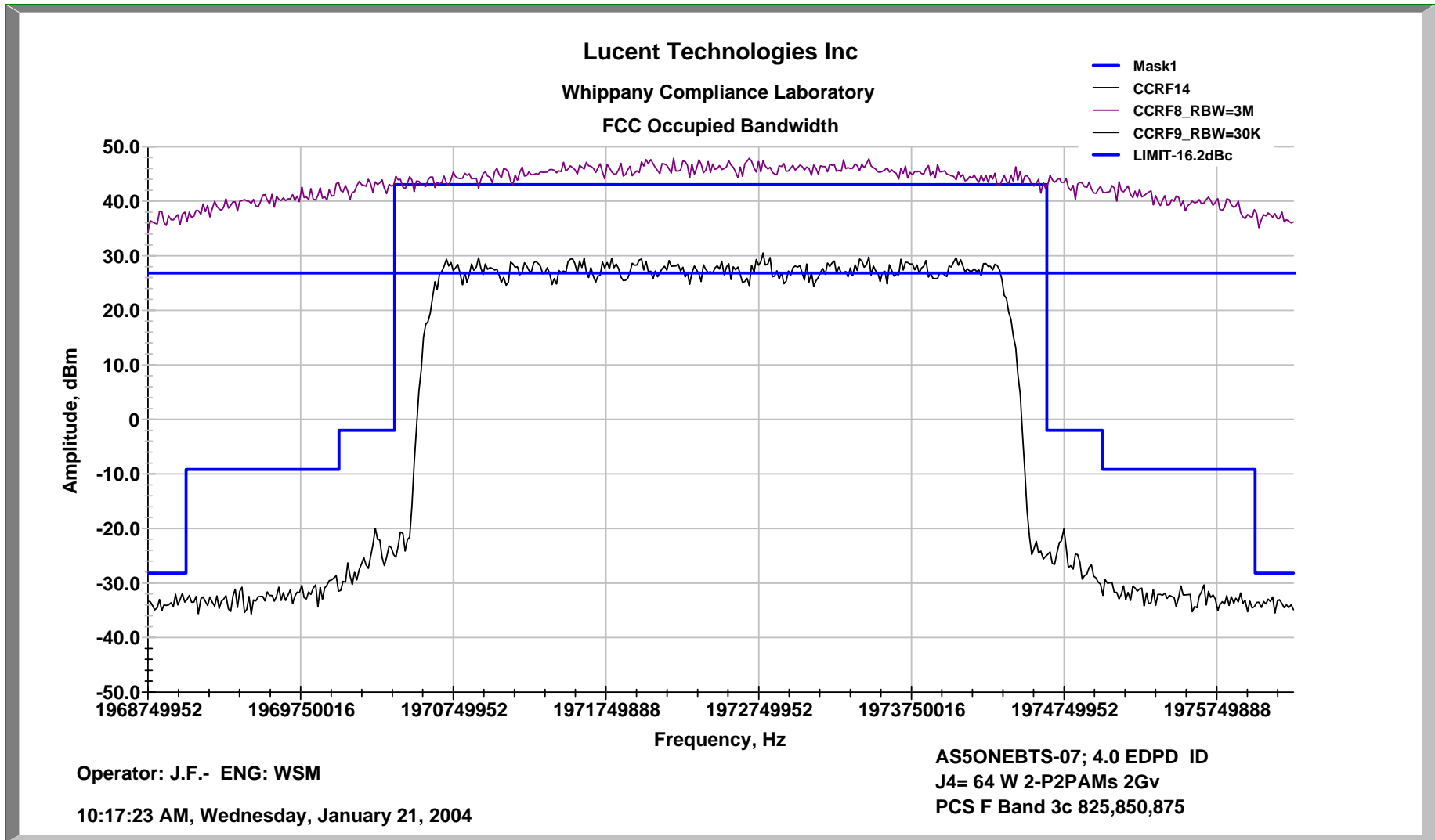

FCC Occupied Bandwidth Data, C Band 2-P2Pam/3c Ch 925, 950, 975 @ 60W EDPD

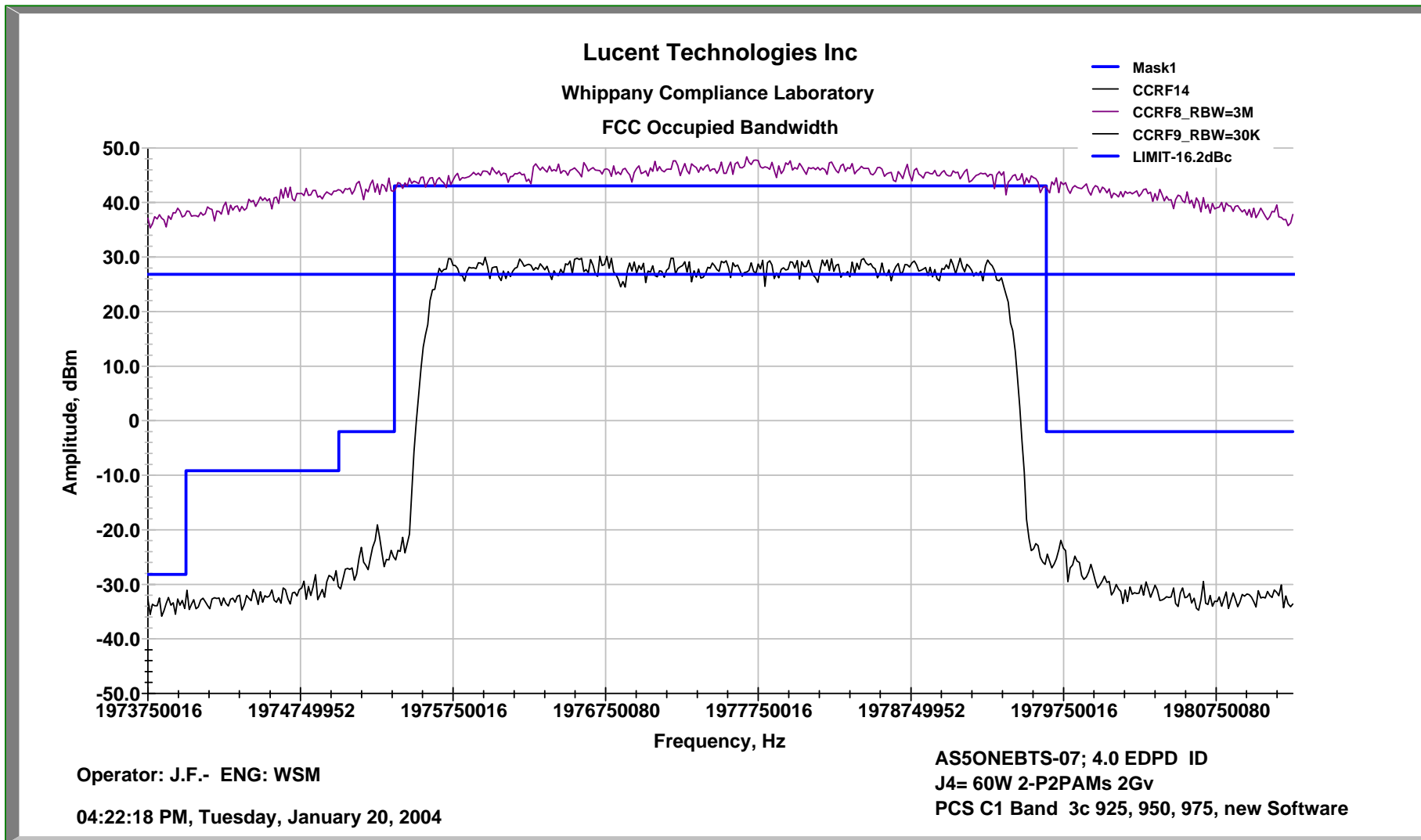

Exhibit 15:

Section 2.1051

Spurious Emissions at Antenna Terminals

Spurious Emissions at the antenna terminals were investigated over the frequency range of 10 MHz to 20 GHz which is beyond the 10th harmonic of the carrier frequency. The RF output from the transmitter was reduced, to an amplitude usable by the spectrum analyzer, by use of a broadband attenuator. The complete RF path was calibrated over the 10 MHz-20 GHz range. The RF power level was measured and monitored prior and during the test via the test setup in Figure 15A. The spurious measurements were made using an automated test system. The test system consists of a Rohde & Schwarz FSEM Spectrum Analyzer (or ESMI Test Receiver), a PC based computer test controller, calibrated test hardware and a TILE™ software program to acquire the test data. This system allows measurement and presentation of the data in an accurate and compact form for FCC review. The volume of collected data is greater than 2×10^5 data points over the frequency range of 10 MHz to 20 GHz.

The required emission limitation specified in Section 24.238 of the Code was applied to these tests. Based upon the criterion given in Section 24.238 of the Code and as developed in Exhibit 14, the required emission limit is -13 dBm when measured with a resolution bandwidth of 1 MHz. The measurements of the spurious signals were therefore made using a resolution bandwidth of 1 MHz. All spurious and harmonics of the CDMA Carrier was also shown to be lower than -13 dBm limit.

The carrier signal shown on these plots was measured at a resolution Bandwidths of 3 MHz. This was done so that the carrier plot correctly and accurately depicts the carrier output power in relation to the spurious signals and the defined limit.

The applied signal met the recommended characteristics per *3GPP2 C.S0010-0, December 1999, Recommended Minimum Performance Standards for cdma2000 Spread Spectrum Base Stations, Paragraph 6.5.2, Test Model for Base Station* as defined below.

Type	Number of Channels	Fraction of Power (Linear)	Fraction of Power (dB)	Comments
Pilot	1	0.1490	-8.3	Walsh 0
Sync	1	0.015/p	-18.3	Walsh 32, always 1/8 rate
Paging	1	0.054	-12.7	Walsh 1, full rate only
Traffic	6	0.13 each	-8.8 each	Variable Walsh Assignments, full rate only

TABLE 15.1 Base Station Test Model, Nominal

Test Results Summary:

Measurements were performed while transmitting at the upper and lower channels in each PCS Block tested. Measurement were additionally performed for the single, dual and three carrier PCS CDMA-EDPD Transceiver / MCA transmit configurations at each PCS Block Edge.

The attached spectral plots are samples which depicting the PCS CDMA-EDPD Transceiver’s compliance for representative single, dual and three carrier PCS CDMA-EDPD Transceiver / MCA transmit configurations. Table 15.2 documents the results of the performed measurements. The performance charts show that there are no harmonics or spurious emissions above the applicable limit of -13 dBm. The attached data plots document the results for single, dual and

Exhibit 15: *continued*

three carrier **PCS CDMA-EDPD Transceiver** test configurations for PCS sub-block A1. Table 15.2 lists the other PCS blocks that were tested and for which data is not attached. The data plots for these PCS blocks also show that there are no harmonics or spurious emissions above the applicable limit of -13 dBm, and demonstrate the **PCS CDMA-EDPD Transceiver's** compliance.

PCS Block -Channel	Number of carriers	Number of P2PAM's in MCA	Test Results
A- 25	1	1 & 2	Compliant
A-25, 50	2	1 & 2	Compliant
A- 25, 50, 75	3	2	Compliant
A-275	1	1 & 2	Compliant
A-250, 275	2	1 & 2	Compliant
A- 225, 250, 275	3	2	Compliant
B- 425	1	1 & 2	Compliant
B-425, 450	2	1 & 2	Compliant
B- 425, 450, 475	3	2	Compliant
B-675	1	1 & 2	Compliant
B-650, 675	2	1 & 2	Compliant
B- 625, 650, 675	3	2	Compliant
C- 925	1	1 & 2	Compliant
C-925, 950	2	1 & 2	Compliant
C- 925, 950, 975	3	2	Compliant
C-1175	1	1 & 2	Compliant
C-1150, 1175	2	1 & 2	Compliant
C- 1125, 1150, 1175	3	2	Compliant
D- 325	1	1 & 2	Compliant
D-325, 350	2	1 & 2	Compliant
D-325, 350, 375	3	2	Compliant
E- 725	1	1 & 2	Compliant
E-725, 750	2	1 & 2	Compliant
E- 725, 750, 775	3	2	Compliant
F- 825	1	1 & 2	Compliant
F-825, 850	2	1 & 2	Compliant
F- 825, 850, 875	3	2	Compliant

(1) The Single Amplifier configurations supports 1 and 2 carrier transmit configurations. The dual amplifier MCA supports 1, 2 or 3 carrier transmit configurations

TABLE 15.2 PCS Conducted Spurious Compliance Tabulation

Conducted Spurious tests on the Receiver antenna terminal additionally documented compliance with the 2 nW requirement of 47CFR Part 15 section 15.111.

Exhibit 15 continued

Figure 15

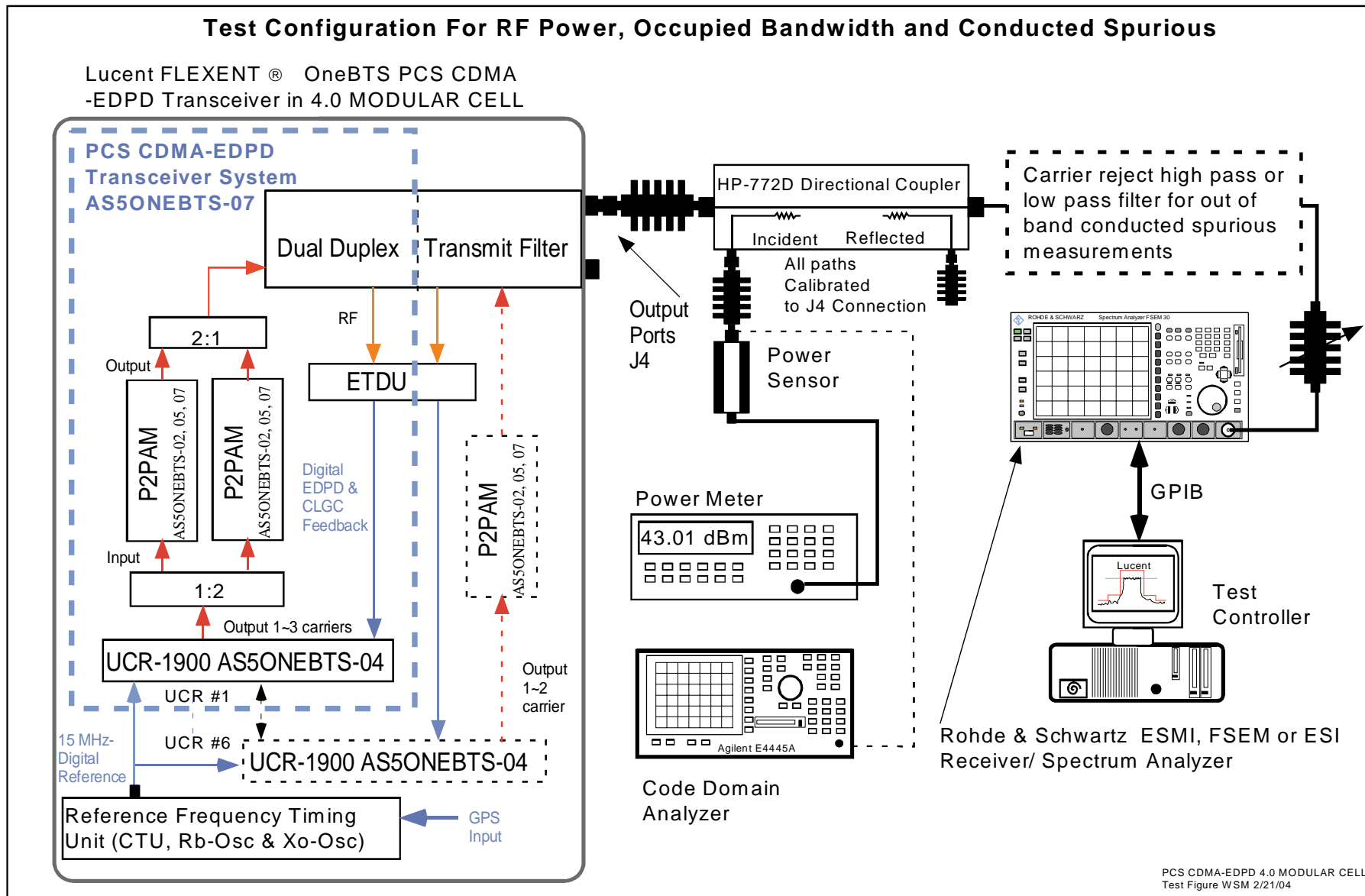

**FCC Conducted Spurious Measurements
of
Lucent Technologies Inc.**

**PCS CDMA Enhanced Digital PreDistortion Transceiver
(EDPD)**

installed in

FLEXENT® OneBTS™ PCS CDMA 4.0 Modular Cell

Sample Data

**W.Steve Majkowski NCE
Lucent Technologies Inc.
Whippany FCC Compliance Laboratory
majkowski@lucent.com**

FCC Conducted Spurious Data. A Band 1-P2Pam/1c Ch 25 @ 20W EDPD

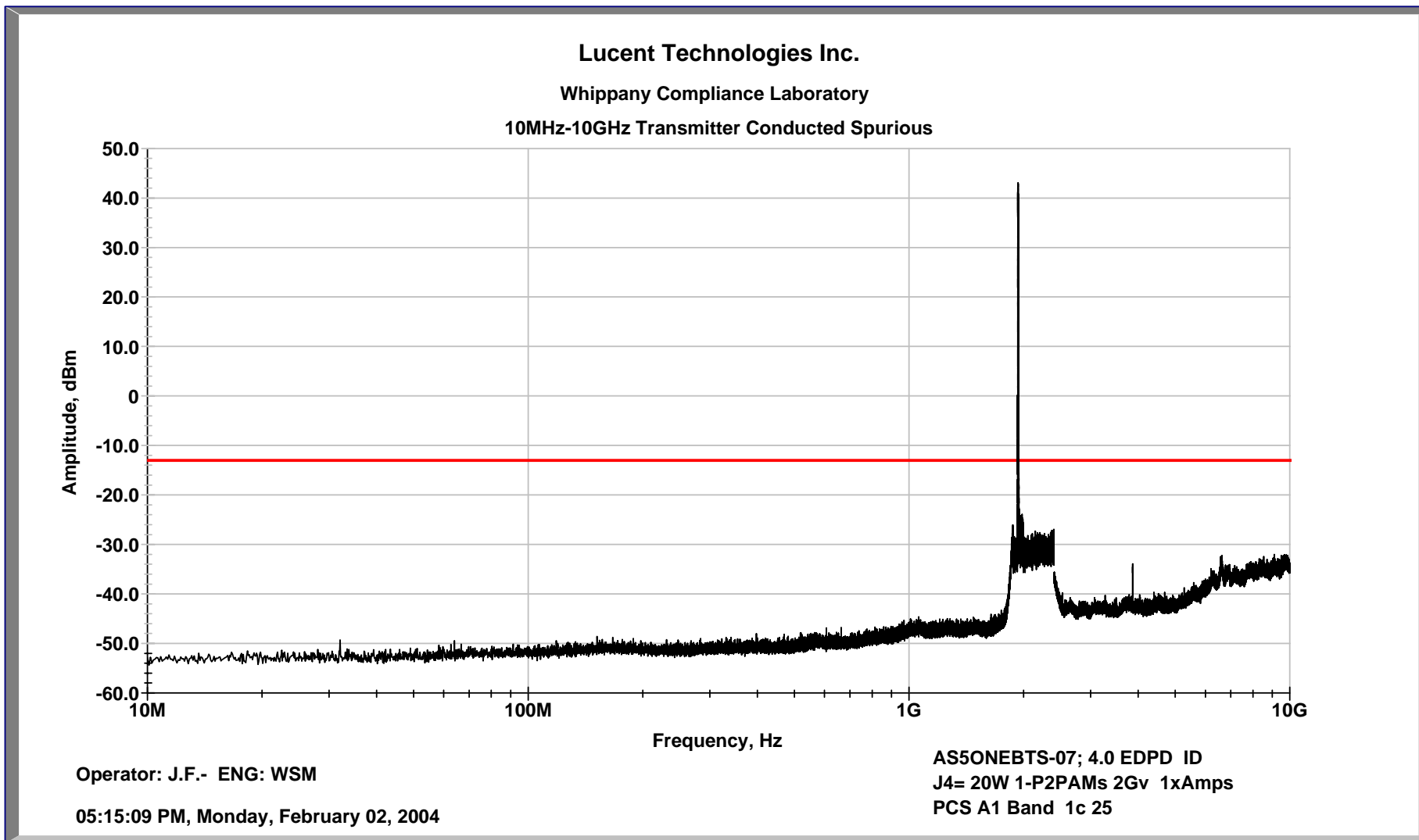

FCC Conducted Spurious Data. A Band 1-P2Pam/1c Ch 25 @ 20W EDPD

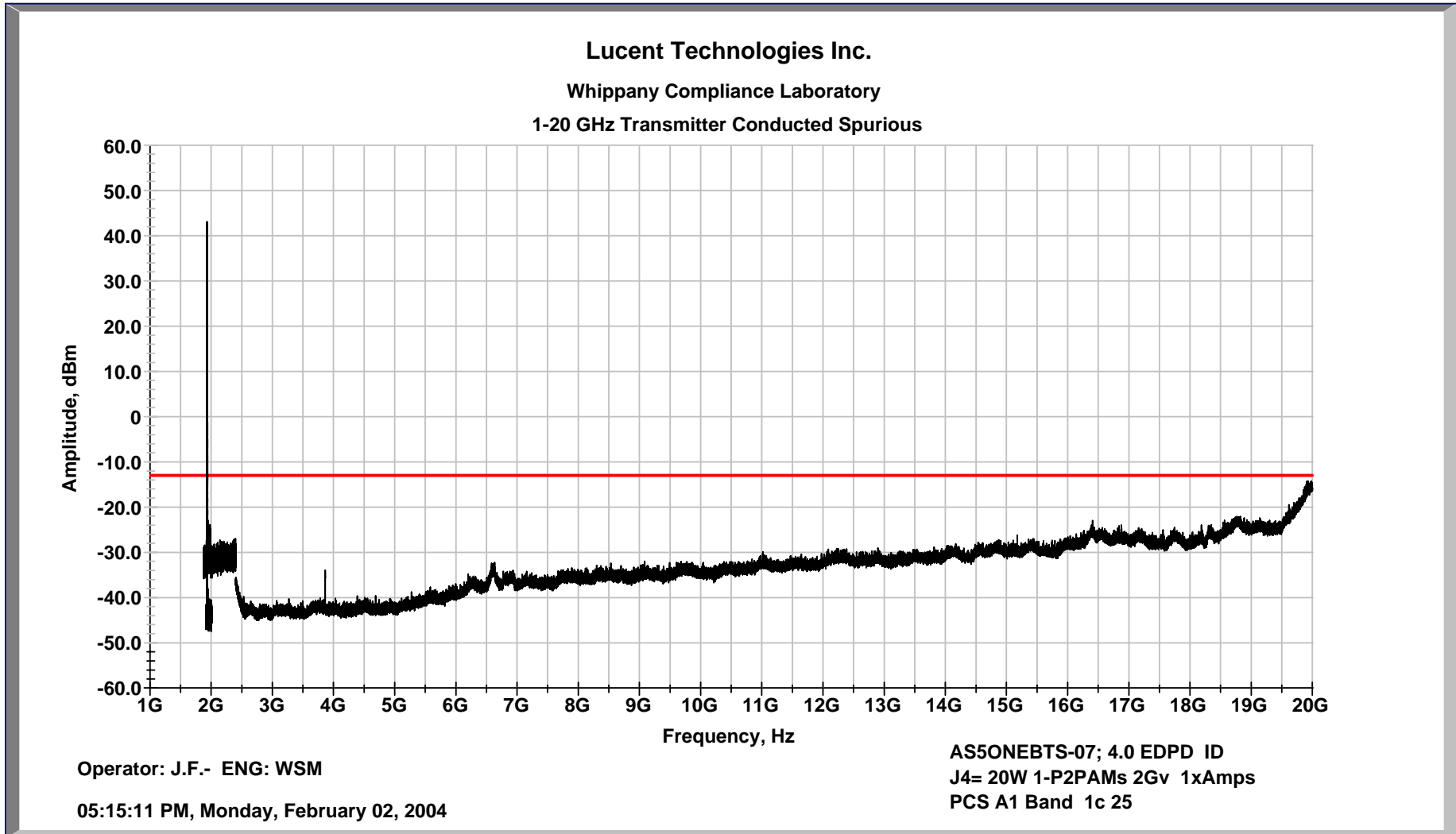

FCC Conducted Spurious Data. A Band 1-P2Pam/2c Ch 25, 50 @ 40W EDPD

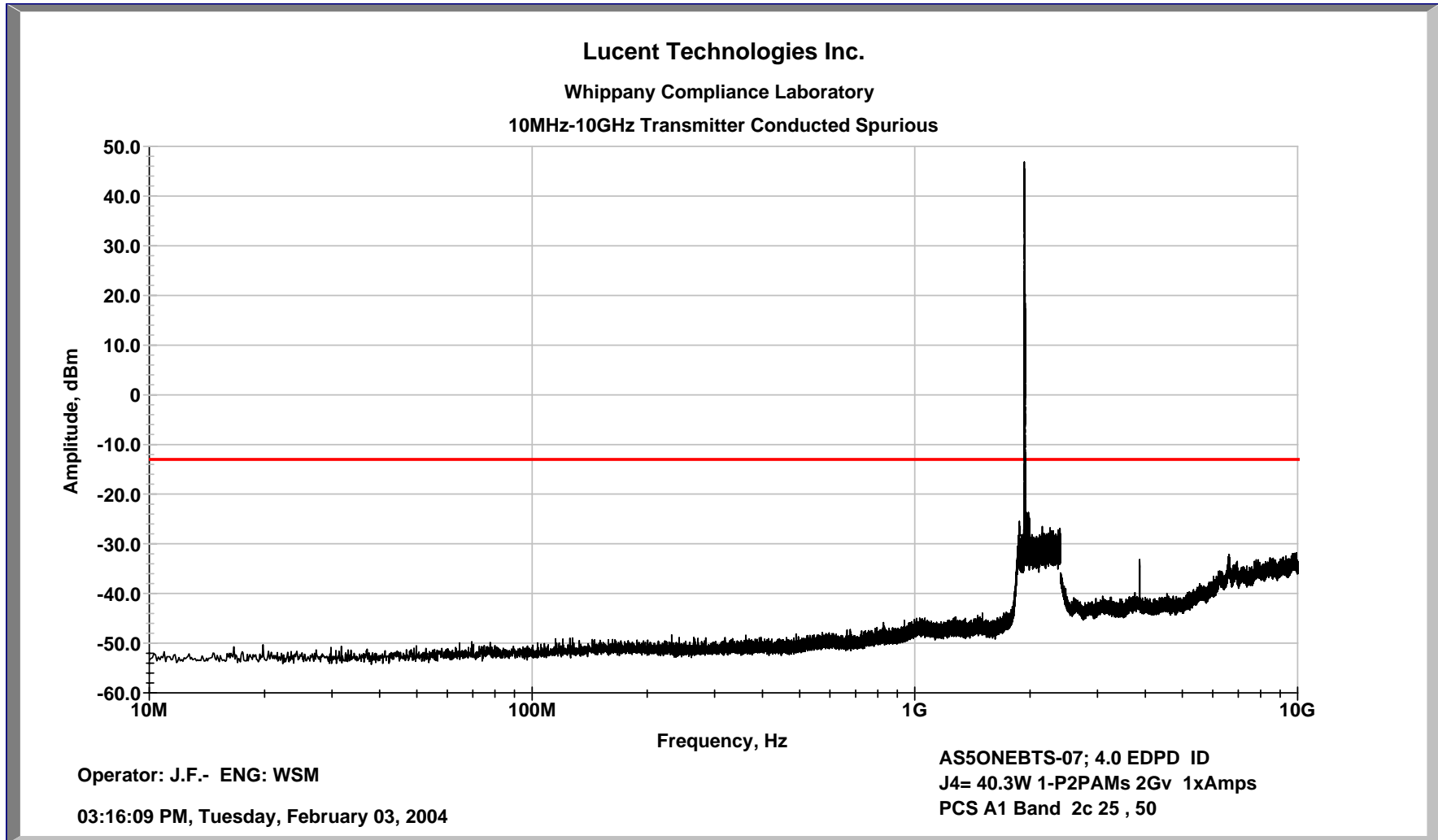

FCC Conducted Spurious Data. A Band 1-P2Pam/2c Ch 25, 50 @ 40W EDPD

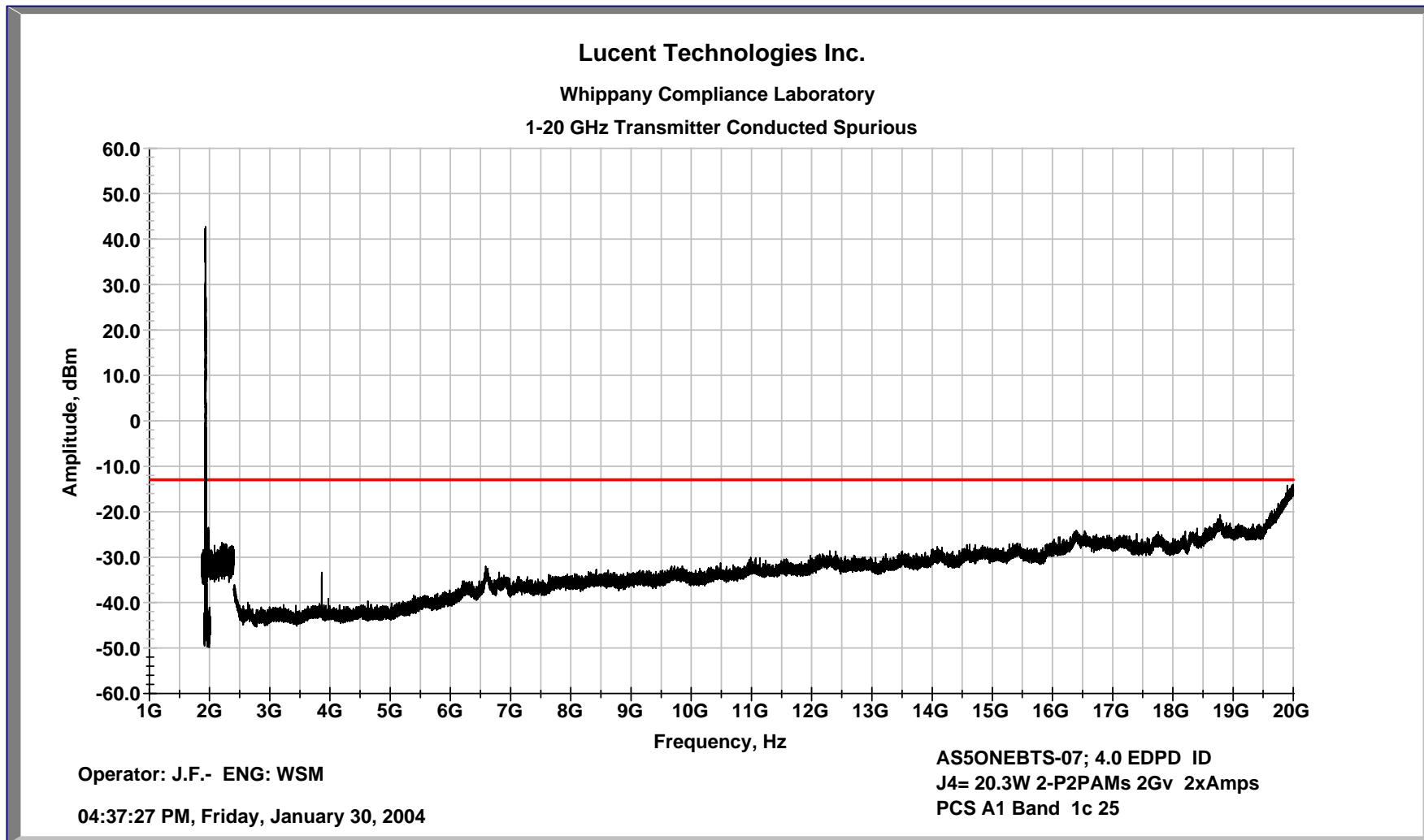

FCC Conducted Spurious Data. A Band 2-P2Pam/3c Ch 25, 50, 75 @ 60W EDPD

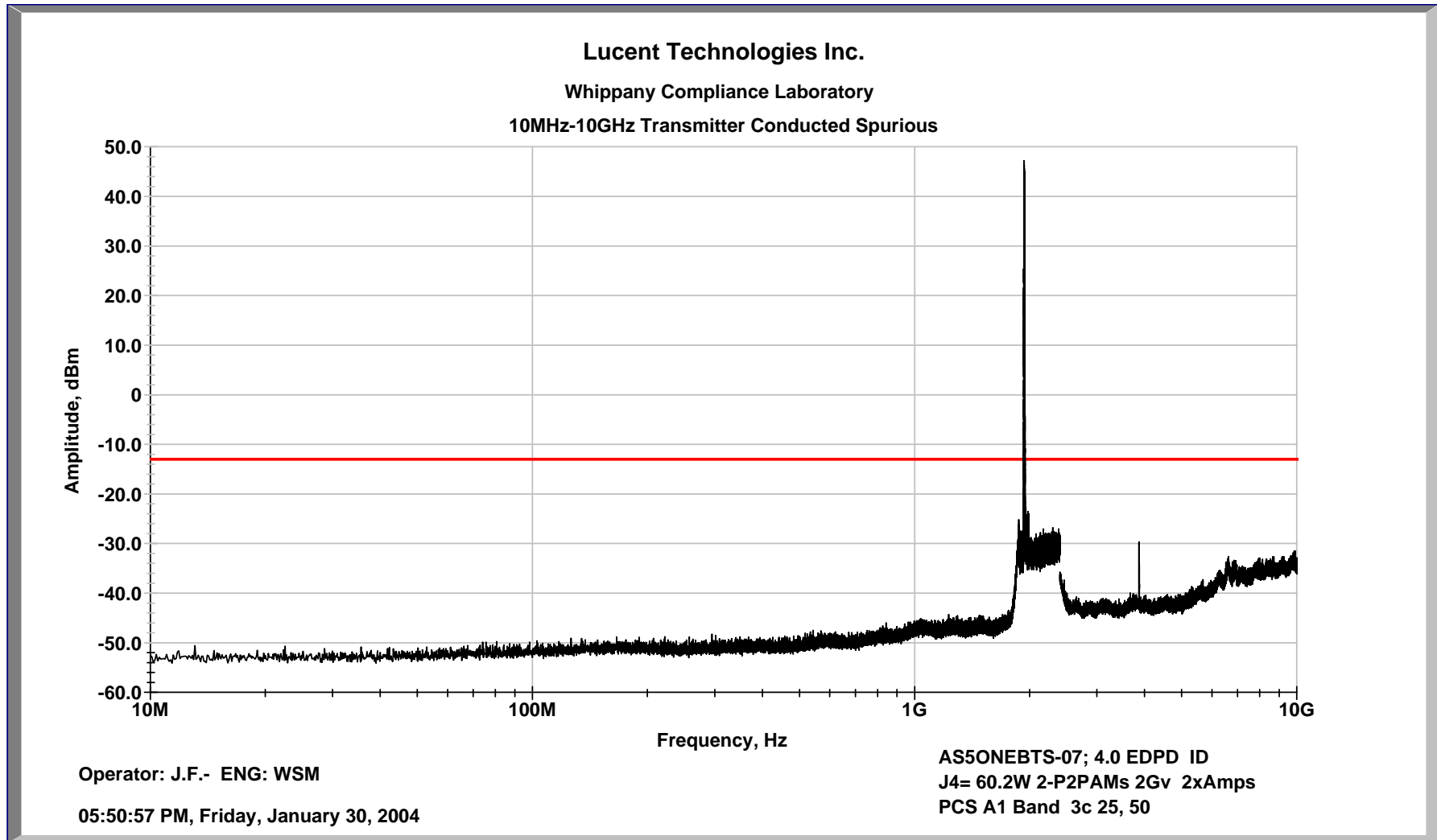

FCC Conducted Spurious Data. A Band 2-P2Pam/3c Ch 25, 50, 75 @ 60W EDPD

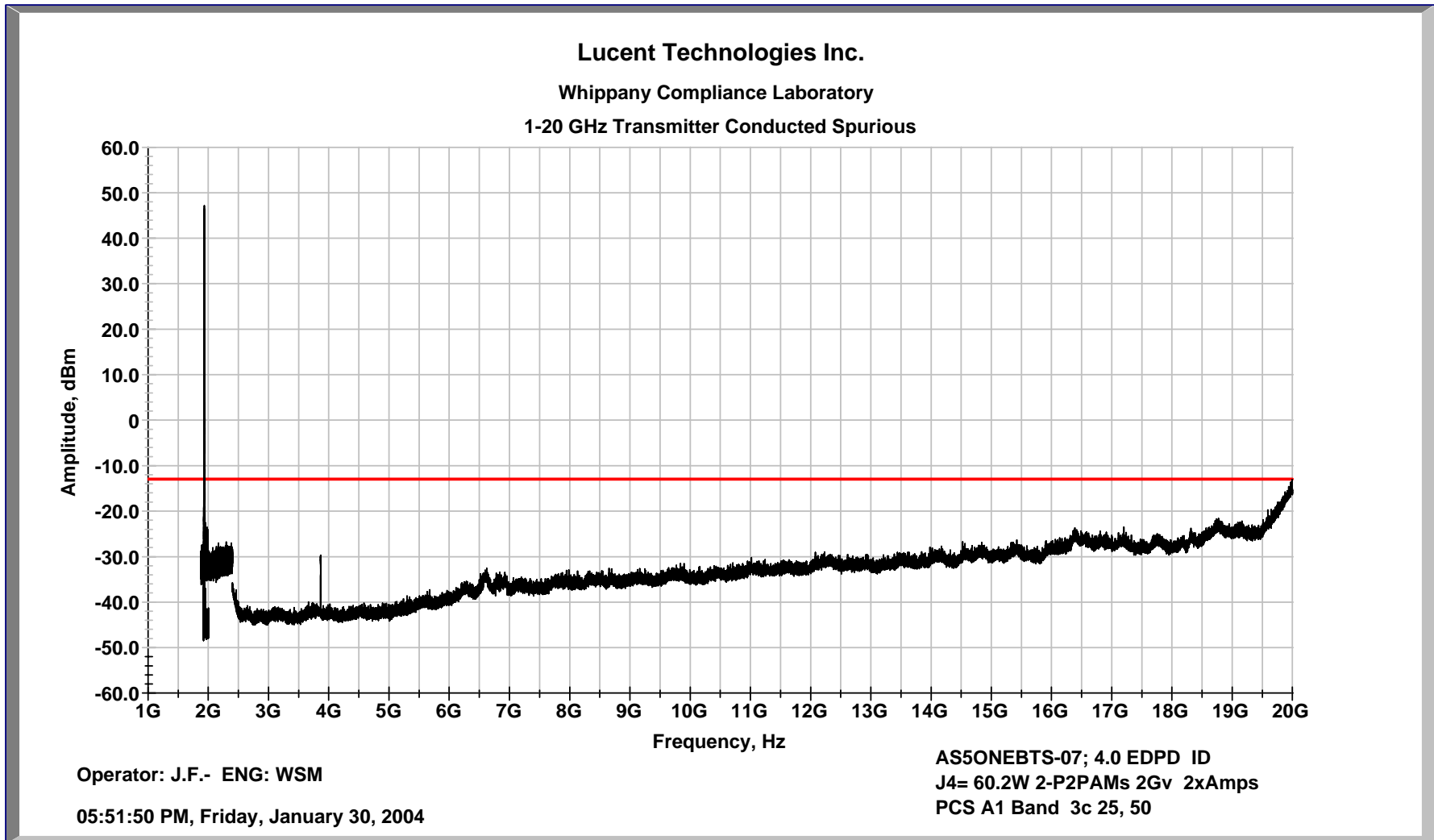

FCC Conducted Spurious Data. C Band 1-P2Pam/1c Ch 925 @ 20W EDPD

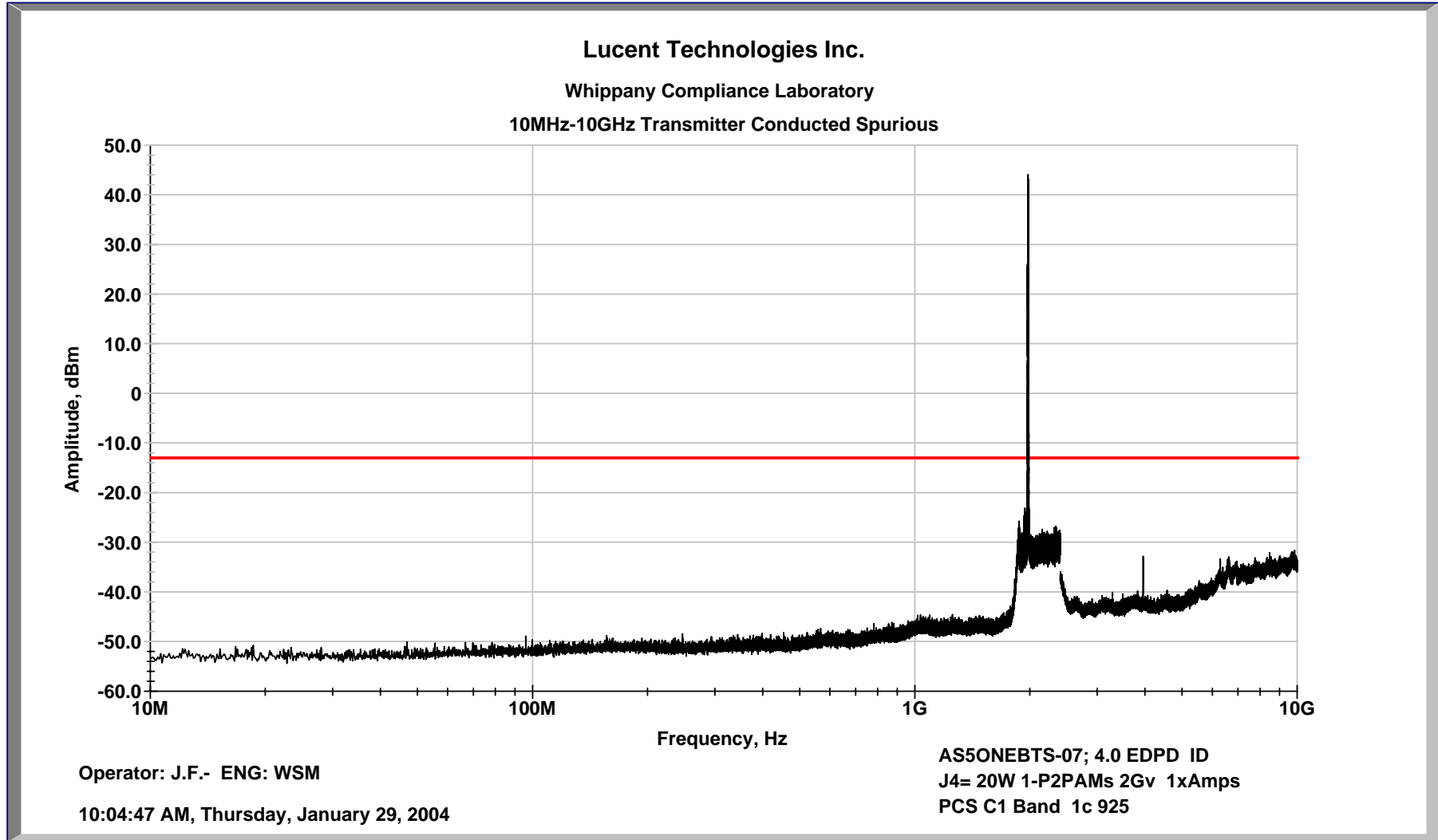

FCC Conducted Spurious Data. C Band 1-P2Pam/1c Ch 925 @ 20W EDPD

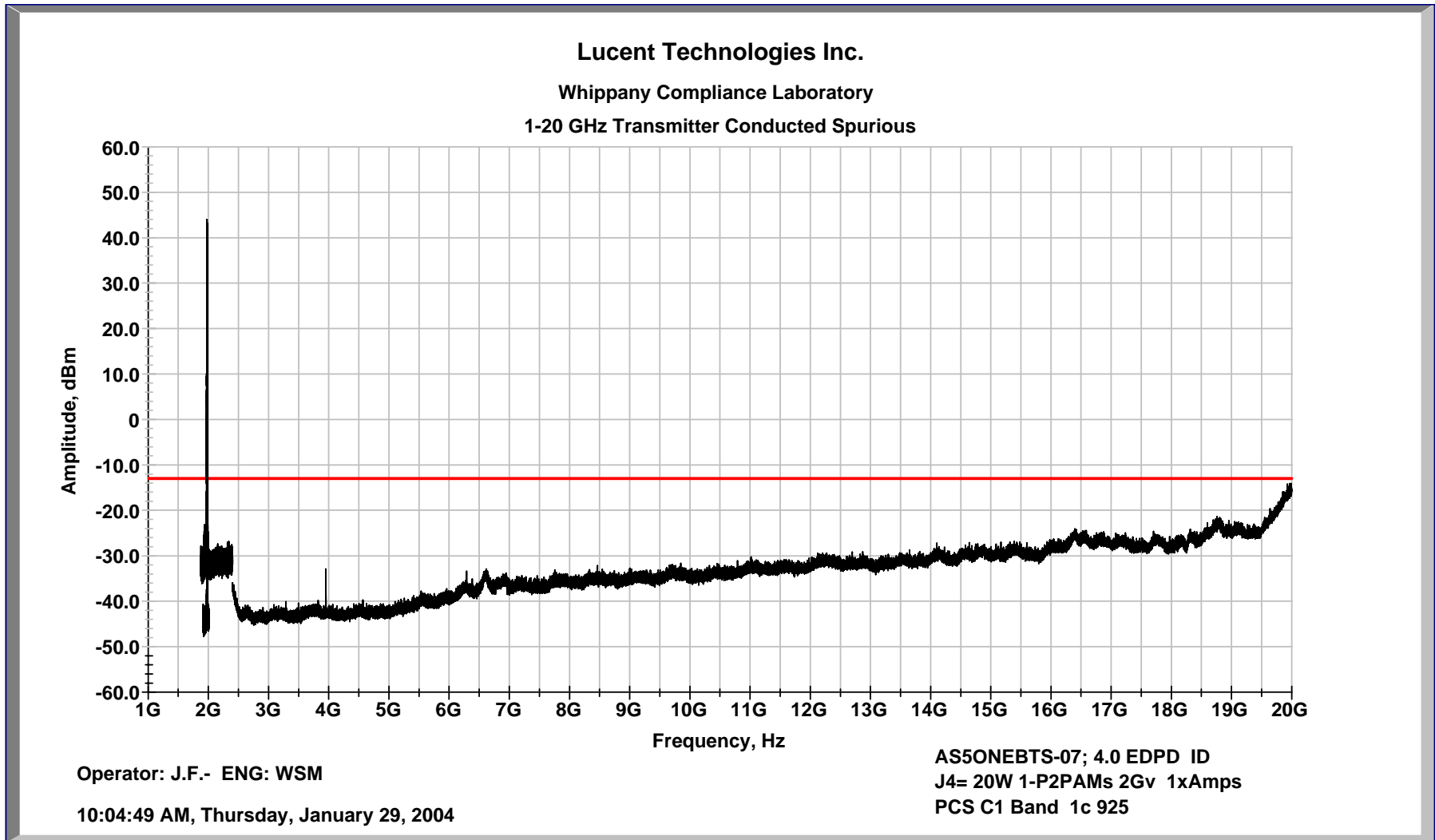

FCC Conducted Spurious Data. C Band 1-P2Pam/2c Ch 925, 950 @ 40W EDPD

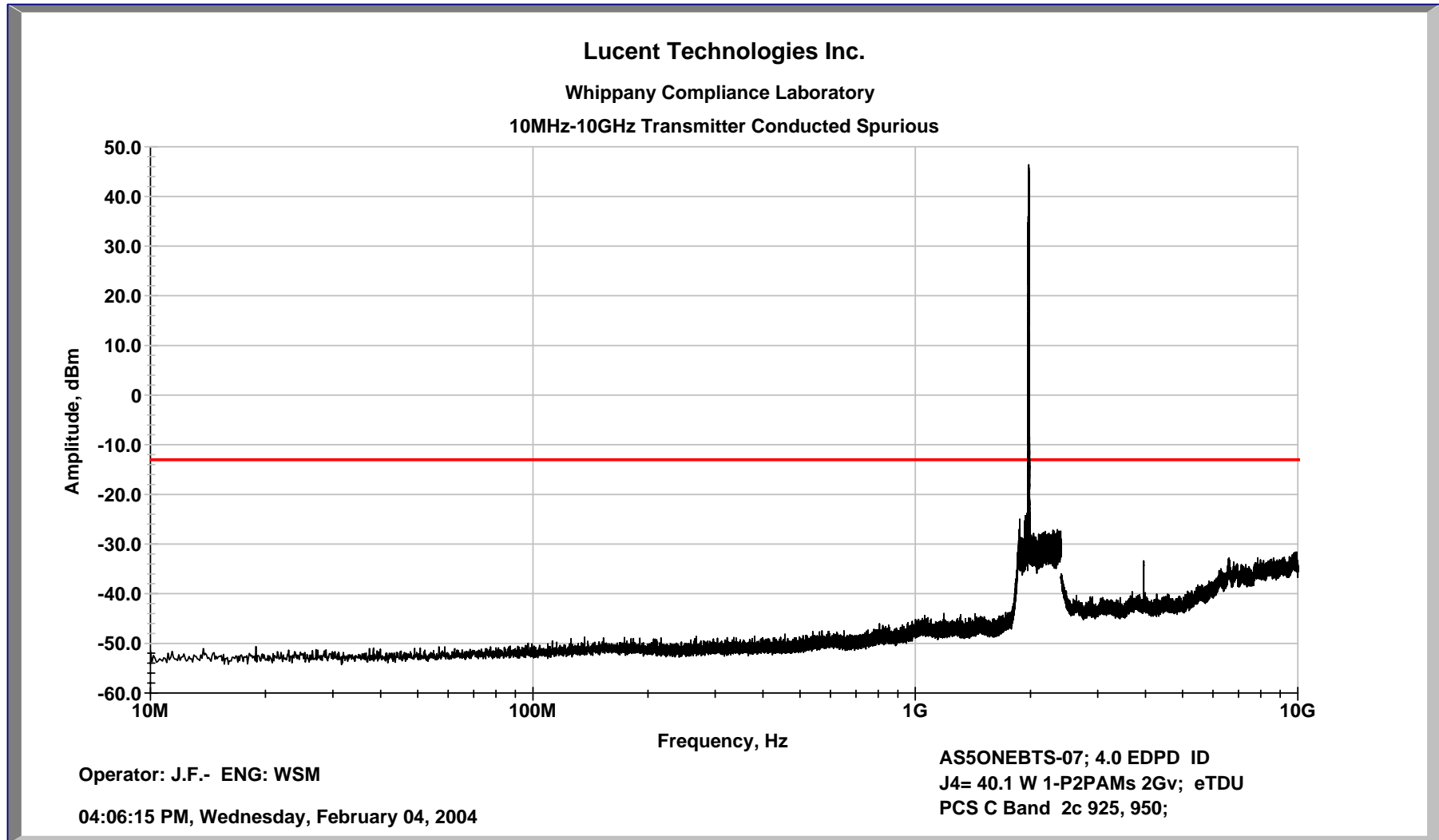

FCC Conducted Spurious Data. C Band 1-P2Pam/2c Ch 925, 950 @ 40W EDPD

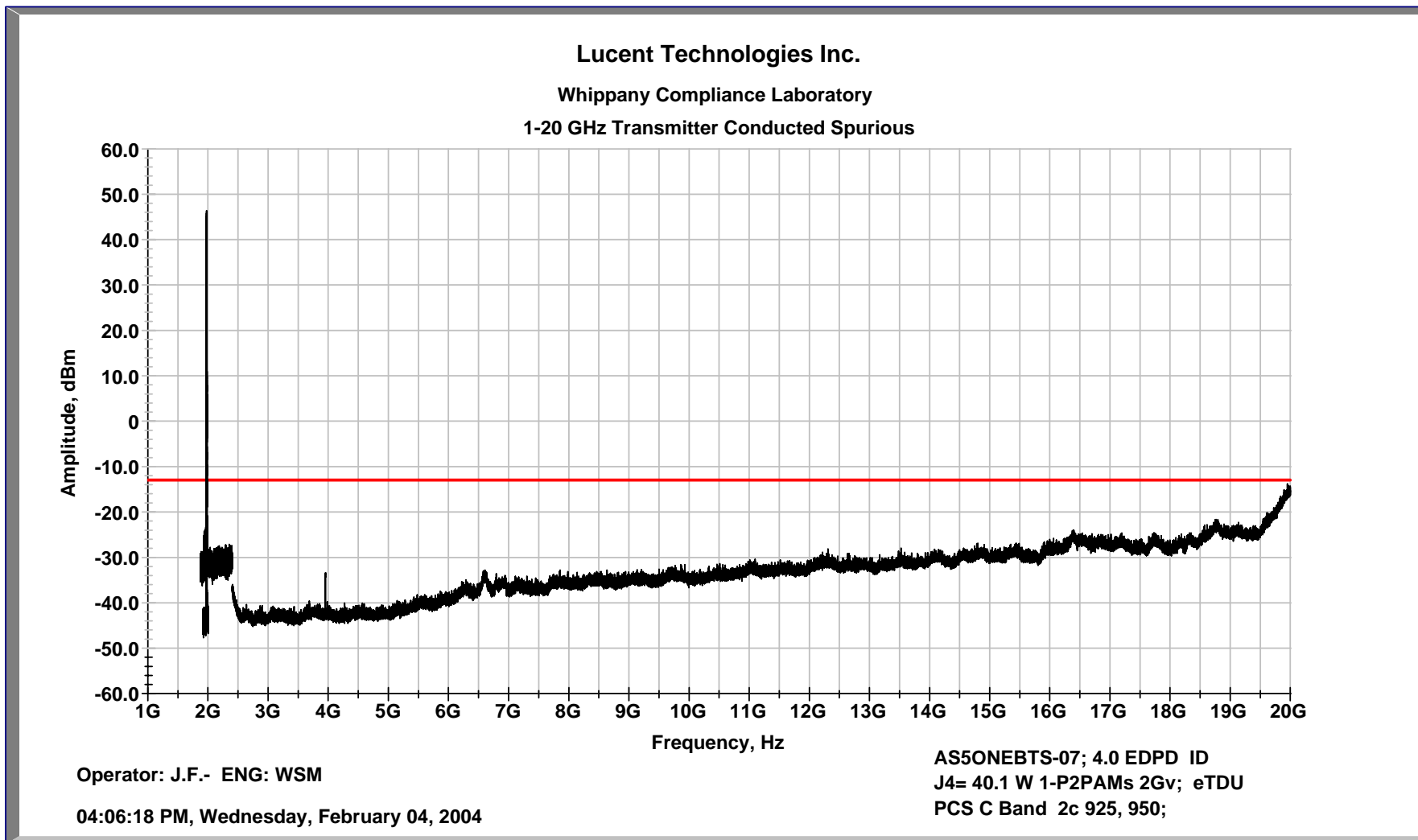

FCC Conducted Spurious Data. C Band 2-P2Pam/3c Ch 925, 950, 975 @ 60W EDPD

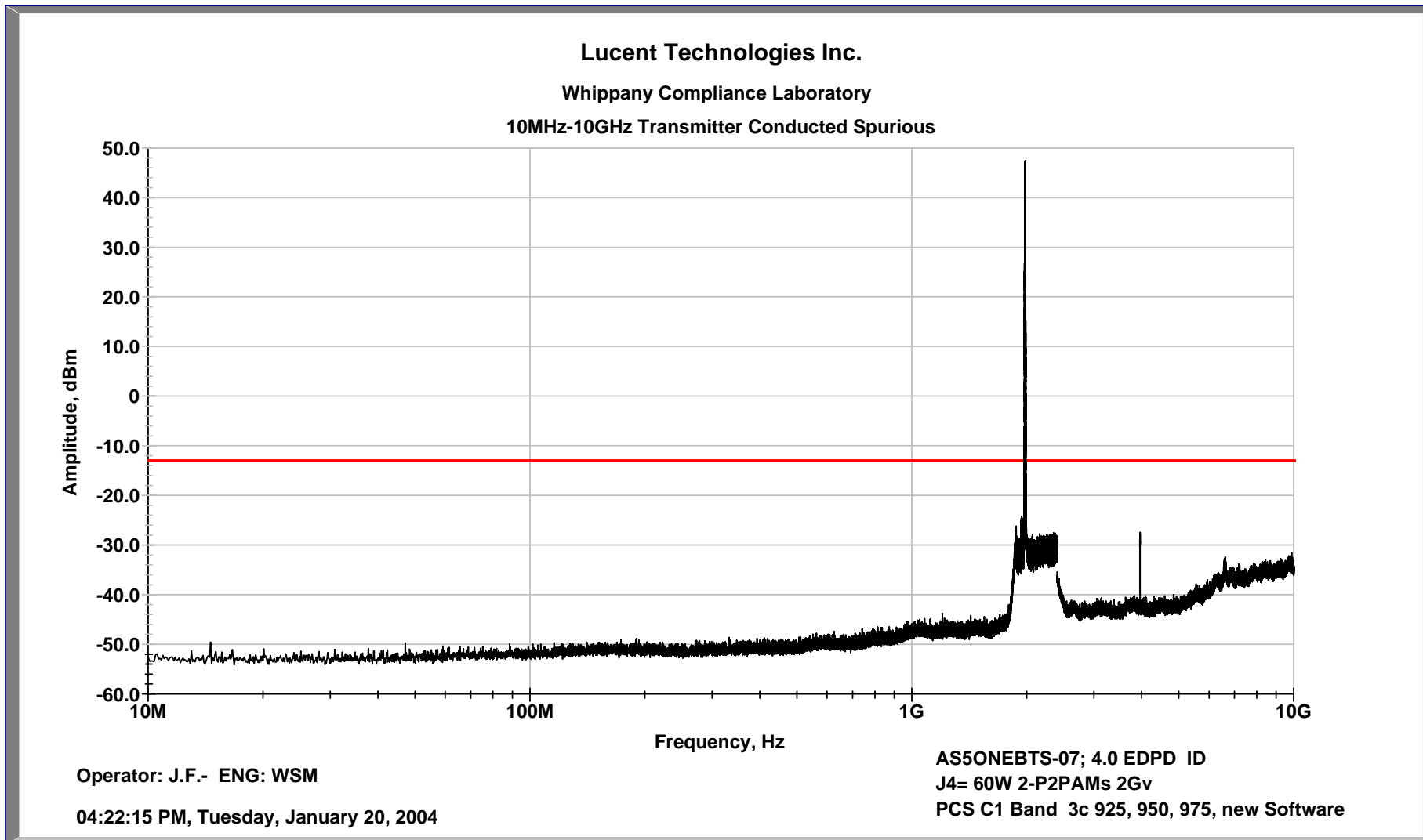

FCC Conducted Spurious Data. C Band 2-P2Pam/3c Ch 925, 950, 975 @ 60W EDPD

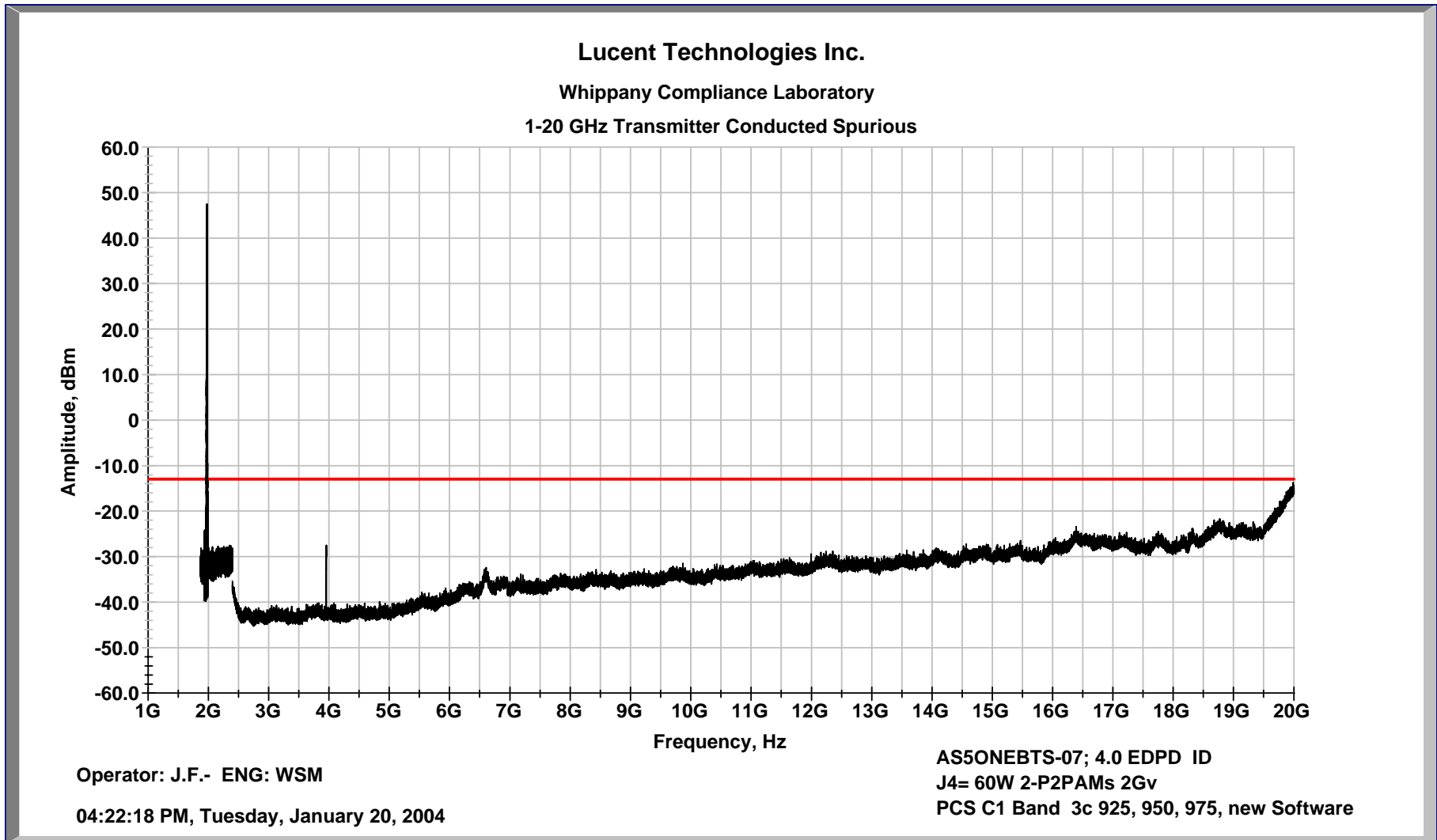

Exhibit 16

SECTION 2.1053

FIELD STRENGTH OF SPURIOUS RADIATION

Field strength measurements of radiated spurious emissions were made at a ten meter test site (open field) maintained by Lucent Technologies Bell Laboratories FCC Compliance Laboratory in Whippany, New Jersey. A complete description and full measurement data for the site have been placed on file with the Commission.

The **6 UCR-1900's** were configured with **12 P2PAM's** to provide **6 PCS CDMA-EDPD Transceivers** and all other associated equipment in a **PCS Indoor FLEXENT ® OneBTS Modular Cell 4.0**. The spectrum from 10 MHz to the tenth harmonic of the carrier was searched for spurious radiation. Measurements were made using both horizontally and vertically polarized antennas. The emissions which were more than 20 dB below the specification limit were considered not reportable (Section 2.1053).

The calculated emission levels were found by:

$$P_{meas} \text{ (dBm)} + \text{Cable Loss(dB)} + \text{Antenna Factor(dB)} + 107 \text{ (dB}\mu\text{V/dBm)} - \text{Amplifier Gain (dB)} \\ = \text{Field Strength (dB}\mu\text{V/m)}$$

Section 24.238 and 2.1053 contains the requirements for the levels of spurious radiation as a function of the EIRP of the unmodulated carrier. The reference level for the unmodulated carrier is calculated as the field produced by an isotropic radiator excited by the transmitter output power according to the following relation taken from Reference Data for Radio Engineers, page 27-7, 6th edition, IT&T Corp.

$$E = (120\pi P)^{1/2} = [(30 * P)^{1/2}] / R$$

$$20 \log (E * 10^6) - (43 + 10 \log P) = 71.77 \text{ dB } \mu\text{V/meter}$$

Where: E = Field Intensity in Volts/ meter
 P = Transmitted Power in watts = 20 W/ Carrier
 R = Distance in meters = 10 m

RESULTS:

For this particular test, the field strength of any spurious radiation is required to be less than 71.8 dBμV/meter. Reportable measurements are equal to or greater than 51.8 dB μV/meter. Over the spectrum investigated, 10 MHz to tenth harmonic of the carrier, no reportable spurious emissions were detected. This demonstrates that the **PCS CDMA-EDPD Transceivers**, the subject of this application, complies with Sections 2.1053, 24.238 and 2.1057 of the Rules.

Additional testing to 47CFR Part 15 documented compliance with the Class B requirements. Conducted Spurious tests on the receiver antenna terminal documented compliance with the 2 nW requirement of 47CFR Part 15.

Exhibit 17

SECTION 2.1055 MEASUREMENT OF FREQUENCY STABILITY

RESPONSE:

The frequency stabilization and accuracy of the CDMA signal of the **PCS CDMA-EDPD Transceiver** is a function of the signal provided by the **UCR (FCC ID: AS5ONEBTS-04)** and disciplined by the **TFU**. The Time Frequency Unit (**TFU**) provides the time and frequency reference used by the **UCR (FCC ID: AS5ONEBTS-04)**. The **TFU** is a highly accurate time and frequency unit which relies upon a signal lock of GPS satellite signals to provide the primary discipline of system timing. In the event of loss of GPS lock the Rubidium or Crystal Oscillator Modules (**OM-Rb & OM-Xo**) can provide up to 24 hours of flywheel operation. The system provides for automatic timing synchronization upon reacquisition of GPS lock. These units are typically powered by an AC-DC power converter with battery backup to provide immunity to power fluctuations and failures. Additional DC-DC power converter in the Modular Cell and on Circuit packs provide additional immunity to power fluctuations.

This system complies with the frequency stability requirements necessary for **FLEXENT®** system compliance with FCC Rules for frequency stability. These devices are compliant with FCC Part 15 rules when powered by and installed in a Lucent Technologies Inc. **FLEXENT®** Modular Cell.

The following frequency stability test data for the **TFU, UCR** and **OM** was measured as installed and tested, per Figure 17A, in a **FLEXENT®** Modular Cell. The entire Modular Cell was subjected to the FCC specified environments while operating at full rated power. Both carrier center frequency and reference oscillator deviations were measured. Voltage variance was applied to the DC input of the Modular Cell.

RESULTS:

The frequency stability performance for the PCS CDMA-EDPD Transceiver / FCC ID AS5ONEBTS-07 when operated in a FLEXENT® Modular Cell is equivalent or better to the performance presented in the original filing for UCR (FCC ID: AS5ONEBTS-04) and is compliant with FCC requirements. The data provided below documents that the maximum frequency deviation measured for the RF carrier frequency (1952.5 MHz) at the transmit antenna port was -0.0015 ppm (-2.95 Hz). The specification for FCC compliance is +/- 0.05 ppm (+/-97.62 Hz). The maximum frequency deviation measured for the OM-RB output (15MHz) was -0.00003 ppm (-5 x10⁻⁴ Hz). The specification for FCC compliance is +/- 0.05 ppm (+/-0.75 Hz).

The measured data is attached below.

Exhibit 17 continued

Figure 17 Test Figure for Frequency Stability

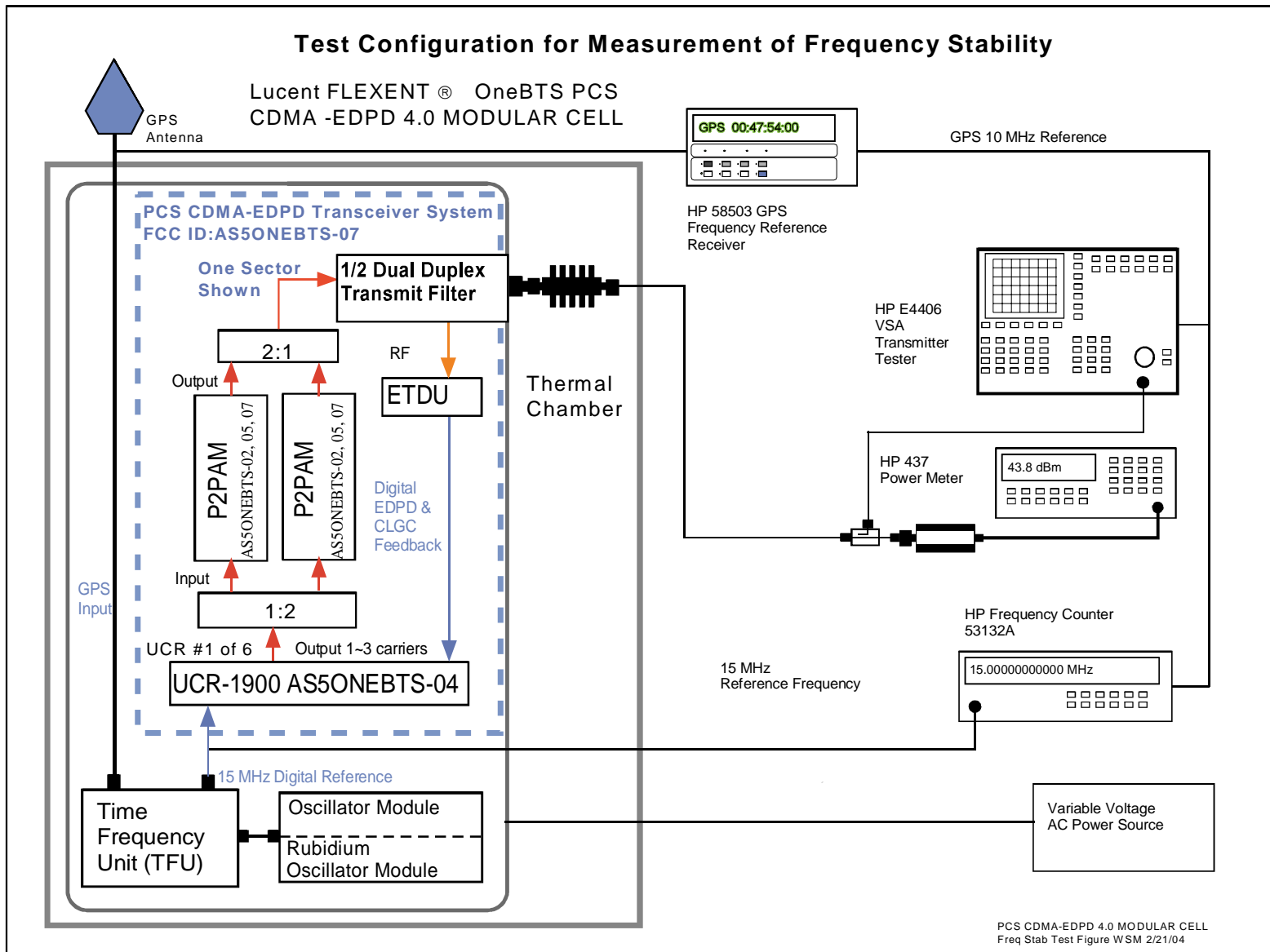

Exhibit 17: Measurement of Frequency Stability of FLEXENT™ PCS Modular Cell

PCS Block Tested: B, PCS Channel 450, 1952.5MHz

Baseline Measurement at +20°C

Reference and Transmit Frequency Deviation From GPS at +20°C at 100% of Nominal Voltage, 24VDC		
Time (minutes)	15 MHz Deviation from GPS (x10 ⁻⁴ Hz)	Transmit Carrier Deviation (Hz)
0	-3	1.20
0.5	-4	2.86
1.0	-1	0.42
1.5	-1	1.88
2.0	-4	2.56
2.5	-2	-0.46
3.0	-0	-2.37
FCC SPECIFICATION	+/- 15.0 MHz (+/- 0.05 ppm) +/-0.05 ppm = +/-0.75 Hz	+/-1952.5 MHz (+/- 0.05 ppm) +/-0.05 ppm = +/-97.62 Hz
FCC RESULT	PASS	PASS

Reference and Transmit Frequency Deviation From GPS at +20°C at 85% of Nominal Voltage, 20.4VDC		
Time (minutes)	15 MHz Deviation from GPS (x10 ⁻⁴ Hz)	Transmit Carrier Deviation (Hz)
0	3	2.51
0.5	2	1.62
1.0	2	2.21
1.5	3	1.82
2.0	0	-1.62
2.5	-3	-2.63
3.0	2	-0.95
FCC SPECIFICATION	+/- 15.0 MHz (+/- 0.05 ppm) +/-0.05 ppm = +/-0.75 Hz	+/-1952.5 MHz (+/- 0.05 ppm) +/-0.05 ppm = +/-97.62 Hz
FCC RESULT	PASS	PASS

Reference and Transmit Frequency Deviation From GPS at +20°C at 115% of Nominal Voltage, 27.6VDC		
Time (minutes)	15 MHz Deviation from GPS (x10 ⁻⁴ Hz)	Transmit Carrier Deviation (Hz)
0	3	-1.52
0.5	3	0.64
1	5	1.83
1.5	3	-2.63
2	3	-2.41
2.5	4	-0.42
3	3	1.58
FCC SPECIFICATION	+/- 15.0 MHz (+/- 0.05 ppm) +/-0.05 ppm = +/-0.75 Hz	+/-1952.5 MHz (+/- 0.05 ppm) +/-0.05 ppm = +/-97.62 Hz
FCC RESULT	PASS	PASS

Exhibit 17: Measurement of Frequency Stability of FLEXENT™ PCS Modular Cell

Reference and Transmit Frequency Deviation From GPS at -40°C at 100% of Nominal Voltage, 24VDC		
Time (minutes)	15 MHz Deviation from GPS (x10 ⁻⁴ Hz)	Transmit Carrier Deviation (Hz)
0	3	2.54
0.5	3	2.15
1	-2	1.13
1.5	-3	-1.54
2	2	-1.67
2.5	1	1.32
3	-3	2.76
FCC SPECIFICATION	+/- 15.0 MHz (+/- 0.05 ppm) +/-0.05 ppm = +/-0.75 Hz	+/-1952.5 MHz (+/- 0.05 ppm) +/-0.05 ppm = +/-97.62 Hz
FCC RESULT	PASS	PASS

Reference and Transmit Frequency Deviation From GPS at -40°C at 85% of Nominal Voltage, 20.4VDC		
Time (minutes)	15 MHz Deviation from GPS (x10 ⁻⁴ Hz)	Transmit Carrier Deviation (Hz)
0	2	2.91
0.5	2	0.92
1	3	1.67
1.5	1	-2.22
2	-3	-1.37
2.5	-2	0.81
3	3	2.84
FCC SPECIFICATION	+/- 15.0 MHz (+/- 0.05 ppm) +/-0.05 ppm = +/-0.75 Hz	+/-1952.5 MHz (+/- 0.05 ppm) +/-0.05 ppm = +/-97.62 Hz
FCC RESULT	PASS	PASS

Reference and Transmit Frequency Deviation From GPS at -40°C at 115% of Nominal Voltage, 27.6VDC		
Time (minutes)	15 MHz Deviation from GPS (x10 ⁻⁴ Hz)	Transmit Carrier Deviation (Hz)
0	4	-2.35
0.5	4	-0.48
1	4	1.38
1.5	3	2.46
2	4	0.91
2.5	3	-1.52
3	1	2.34
FCC SPECIFICATION	+/- 15.0 MHz (+/- 0.05 ppm) +/-0.05 ppm = +/-0.75 Hz	+/-1952.5 MHz (+/- 0.05 ppm) +/-0.05 ppm = +/-97.62 Hz
FCC RESULT	PASS	PASS

Exhibit 17: Measurement of Frequency Stability of FLEXENT™ PCS Modular Cell

Reference and Transmit Frequency Deviation From GPS at -30°C at 100% of Nominal Voltage, 24VDC		
Time (minutes)	15 MHz Deviation from GPS (x10 ⁻⁴ Hz)	Transmit Carrier Deviation (Hz)
0	-4	1.54
0.5	-5	-0.83
1	-4	1.95
1.5	-3	-1.44
2	-1	0.87
2.5	-5	1.42
3	-3	2.31
FCC SPECIFICATION	+/- 15.0 MHz (+/- 0.05 ppm) +/-0.05 ppm = +/-0.75 Hz	+/-1952.5 MHz (+/- 0.05 ppm) +/-0.05 ppm = +/-97.62 Hz
FCC RESULT	PASS	PASS

Reference and Transmit Frequency Deviation From GPS at -30°C at 85% of Nominal Voltage, 20.4VDC		
Time (minutes)	15 MHz Deviation from GPS (x10 ⁻⁴ Hz)	Transmit Carrier Deviation (Hz)
0	-3	-2.37
0.5	-3	-1.53
1	3	-2.18
1.5	2	-2.52
2	3	-0.81
2.5	-2	-1.67
3	3	-1.33
FCC SPECIFICATION	+/- 15.0 MHz (+/- 0.05 ppm) +/-0.05 ppm = +/-0.75 Hz	+/-1952.5 MHz (+/- 0.05 ppm) +/-0.05 ppm = +/-97.62 Hz
FCC RESULT	PASS	PASS

Reference and Transmit Frequency Deviation From GPS at -30°C at 115% of Nominal Voltage, 27.6VDC		
Time (minutes)	15 MHz Deviation from GPS (x10 ⁻⁴ Hz)	Transmit Carrier Deviation (Hz)
0	2	-0.64
0.5	2	1.55
1	3	2.37
1.5	3	2.18
2	2	1.21
2.5	2	-0.72
3	4	-1.61
FCC SPECIFICATION	+/- 15.0 MHz (+/- 0.05 ppm) +/-0.05 ppm = +/-0.75 Hz	+/-1952.5 MHz (+/- 0.05 ppm) +/-0.05 ppm = +/-97.62 Hz
FCC RESULT	PASS	PASS

Exhibit 17: Measurement of Frequency Stability of FLEXENT™ PCS Modular Cell

Reference and Transmit Frequency Deviation From GPS at -20°C at 100% of Nominal Voltage, 24VDC		
Time (minutes)	15 MHz Deviation from GPS (x10 ⁻⁴ Hz)	Transmit Carrier Deviation (Hz)
0	5	1.53
0.5	5	0.54
1	6	0.47
1.5	5	0.48
2	4	0.33
2.5	4	1.21
3	4	1.13
FCC SPECIFICATION	+/- 15.0 MHz (+/- 0.05 ppm) +/-0.05 ppm = +/-0.75 Hz	+/-1952.5 MHz (+/- 0.05 ppm) +/-0.05 ppm = +/-97.62 Hz
FCC RESULT	PASS	PASS

Reference and Transmit Frequency Deviation From GPS at -20°C at 85% of Nominal Voltage, 20.4VDC		
Time (minutes)	15 MHz Deviation from GPS (x10 ⁻⁴ Hz)	Transmit Carrier Deviation (Hz)
0	3	-1.24
0.5	3	-0.23
1	3	-0.37
1.5	2	0.84
2	2	0.58
2.5	3	-0.45
3	2	-0.57
FCC SPECIFICATION	+/- 15.0 MHz (+/- 0.05 ppm) +/-0.05 ppm = +/-0.75 Hz	+/-1952.5 MHz (+/- 0.05 ppm) +/-0.05 ppm = +/-97.62 Hz
FCC RESULT	PASS	PASS

Reference and Transmit Frequency Deviation From GPS at -20°C at 115% of Nominal Voltage, 27.6VDC		
Time (minutes)	15 MHz Deviation from GPS (x10 ⁻⁴ Hz)	Transmit Carrier Deviation (Hz)
0	3	0.25
0.5	3	0.31
1	3	0.47
1.5	2	0.36
2	2	0.21
2.5	1	-0.84
3	2	-0.93
FCC SPECIFICATION	+/- 15.0 MHz (+/- 0.05 ppm) +/-0.05 ppm = +/-0.75 Hz	+/-1952.5 MHz (+/- 0.05 ppm) +/-0.05 ppm = +/-97.62 Hz
FCC RESULT	PASS	PASS

Exhibit 17: Measurement of Frequency Stability of FLEXENT™ PCS Modular Cell

Reference and Transmit Frequency Deviation From GPS at -10°C at 100% of Nominal Voltage, 24VDC		
Time (minutes)	15 MHz Deviation from GPS (x10 ⁻⁴ Hz)	Transmit Carrier Deviation (Hz)
0	2	1.22
0.5	-2	1.14
1	-2	0.21
1.5	2	0.35
2	-2	0.48
2.5	-2	0.87
3	-3	-1.37
FCC SPECIFICATION	+/- 15.0 MHz (+/- 0.05 ppm) +/-0.05 ppm = +/-0.75 Hz	+/-1952.5 MHz (+/- 0.05 ppm) +/-0.05 ppm = +/-97.62 Hz
FCC RESULT	PASS	PASS

Reference and Transmit Frequency Deviation From GPS at -10°C at 85% of Nominal Voltage, 20.4VDC		
Time (minutes)	15 MHz Deviation from GPS (x10 ⁻⁴ Hz)	Transmit Carrier Deviation (Hz)
0	-2	0.34
0.5	-2	-1.88
1	-2	-1.67
1.5	-3	-1.54
2	-1	-1.69
2.5	-1	0.38
3	-3	-0.28
FCC SPECIFICATION	+/- 15.0 MHz (+/- 0.05 ppm) +/-0.05 ppm = +/-0.75 Hz	+/-1952.5 MHz (+/- 0.05 ppm) +/-0.05 ppm = +/-97.62 Hz
FCC RESULT	PASS	PASS

Reference and Transmit Frequency Deviation From GPS at -10°C at 115% of Nominal Voltage, 27.6VDC		
Time (minutes)	15 MHz Deviation from GPS (x10 ⁻⁴ Hz)	Transmit Carrier Deviation (Hz)
0	2	-0.64
0.5	2	-0.87
1	2	-1.11
1.5	4	-1.45
2	4	-0.68
2.5	4	-0.98
3	3	-2.13
FCC SPECIFICATION	+/- 15.0 MHz (+/- 0.05 ppm) +/-0.05 ppm = +/-0.75 Hz	+/-1952.5 MHz (+/- 0.05 ppm) +/-0.05 ppm = +/-97.62 Hz
FCC RESULT	PASS	PASS

Exhibit 17: Measurement of Frequency Stability of FLEXENT™ PCS Modular Cell

Reference and Transmit Frequency Deviation From GPS at 0°C at 100% of Nominal Voltage, 24VDC		
Time (minutes)	15 MHz Deviation from GPS (x10 ⁻⁴ Hz)	Transmit Carrier Deviation (Hz)
0	2	1.14
0.5	4	1.25
1	3	0.65
1.5	3	-1.11
2	2	-0.54
2.5	3	0.63
3	2	0.51
FCC SPECIFICATION	+/- 15.0 MHz (+/- 0.05 ppm) +/-0.05 ppm = +/-0.75 Hz	+/-1952.5 MHz (+/- 0.05 ppm) +/-0.05 ppm = +/-97.62 Hz
FCC RESULT	PASS	PASS

Reference and Transmit Frequency Deviation From GPS at 0°C at 85% of Nominal Voltage, 20.4VDC		
Time (minutes)	15 MHz Deviation from GPS (x10 ⁻⁴ Hz)	Transmit Carrier Deviation (Hz)
0	-3	0.25
0.5	-3	-0.77
1	-2	-1.26
1.5	-2	0.55
2	-2	1.24
2.5	-3	0.64
3	-2	0.35
FCC SPECIFICATION	+/- 15.0 MHz (+/- 0.05 ppm) +/-0.05 ppm = +/-0.75 Hz	+/-1952.5 MHz (+/- 0.05 ppm) +/-0.05 ppm = +/-97.62 Hz
FCC RESULT	PASS	PASS

Reference and Transmit Frequency Deviation From GPS at 0°C at 115% of Nominal Voltage, 27.6VDC		
Time (minutes)	15 MHz Deviation from GPS (x10 ⁻⁴ Hz)	Transmit Carrier Deviation (Hz)
0	3	1.23
0.5	3	0.92
1	2	0.63
1.5	3	-0.87
2	2	-1.42
2.5	3	-1.15
3	3	-0.81
FCC SPECIFICATION	+/- 15.0 MHz (+/- 0.05 ppm) +/-0.05 ppm = +/-0.75 Hz	+/-1952.5 MHz (+/- 0.05 ppm) +/-0.05 ppm = +/-97.62 Hz
FCC RESULT	PASS	PASS

Exhibit 17: Measurement of Frequency Stability of FLEXENT™ PCS Modular Cell

Reference and Transmit Frequency Deviation From GPS at +10°C at 100% of Nominal Voltage, 24VDC		
Time (minutes)	15 MHz Deviation from GPS (x10 ⁻⁴ Hz)	Transmit Carrier Deviation (Hz)
0	1	0.94
0.5	1	0.54
1	0	0.27
1.5	0	0.37
2	-2	0.45
2.5	-2	0.68
3	0	-0.37
FCC SPECIFICATION	+/- 15.0 MHz (+/- 0.05 ppm) +/-0.05 ppm = +/-0.75 Hz	+/-1952.5 MHz (+/- 0.05 ppm) +/-0.05 ppm = +/-97.62 Hz
FCC RESULT	PASS	PASS

Reference and Transmit Frequency Deviation From GPS at +10°C at 85% of Nominal Voltage, 20.4VDC		
Time (minutes)	15 MHz Deviation from GPS (x10 ⁻⁴ Hz)	Transmit Carrier Deviation (Hz)
0	4	1.67
0.5	4	2.23
1	3	0.67
1.5	3	0.47
2	3	-0.23
2.5	4	-1.14
3	2	-0.48
FCC SPECIFICATION	+/- 15.0 MHz (+/- 0.05 ppm) +/-0.05 ppm = +/-0.75 Hz	+/-1952.5 MHz (+/- 0.05 ppm) +/-0.05 ppm = +/-97.62 Hz
FCC RESULT	PASS	PASS

Reference and Transmit Frequency Deviation From GPS at +10°C at 115% of Nominal Voltage, 27.6VDC		
Time (minutes)	15 MHz Deviation from GPS (x10 ⁻⁴ Hz)	Transmit Carrier Deviation (Hz)
0	-3	0.35
0.5	-3	0.92
1	-4	-0.47
1.5	-3	-0.23
2	-3	-1.28
2.5	-2	-0.63
3	-2	0.71
FCC SPECIFICATION	+/- 15.0 MHz (+/- 0.05 ppm) +/-0.05 ppm = +/-0.75 Hz	+/-1952.5 MHz (+/- 0.05 ppm) +/-0.05 ppm = +/-97.62 Hz
FCC RESULT	PASS	PASS

Exhibit 17: Measurement of Frequency Stability of FLEXENT™ PCS Modular Cell

Reference and Transmit Frequency Deviation From GPS at +20°C at 100% of Nominal Voltage, 24VDC		
Time (minutes)	15 MHz Deviation from GPS (x10 ⁻⁴ Hz)	Transmit Carrier Deviation (Hz)
0	3	1.47
0.5	4	0.52
1	3	-1.38
1.5	1	-2.37
2	-3	-0.85
2.5	-2	1.19
3	3	2.61
FCC SPECIFICATION	+/- 15.0 MHz (+/- 0.05 ppm) +/-0.05 ppm = +/-0.75 Hz	+/-1952.5 MHz (+/- 0.05 ppm) +/-0.05 ppm = +/-97.62 Hz
FCC RESULT	PASS	PASS

Reference and Transmit Frequency Deviation From GPS at +20°C at 85% of Nominal Voltage, 20.4VDC		
Time (minutes)	15 MHz Deviation from GPS (x10 ⁻⁴ Hz)	Transmit Carrier Deviation (Hz)
0	0	-2.95
0.5	1	-1.11
1	-2	1.39
1.5	-2	2.15
2	1	-0.48
2.5	1	1.84
3	-2	0.62
FCC SPECIFICATION	+/- 15.0 MHz (+/- 0.05 ppm) +/-0.05 ppm = +/-0.75 Hz	+/-1952.5 MHz (+/- 0.05 ppm) +/-0.05 ppm = +/-97.62 Hz
FCC RESULT	PASS	PASS

Reference and Transmit Frequency Deviation From GPS at +20°C at 115% of Nominal Voltage, 27.6VDC		
Time (minutes)	15 MHz Deviation from GPS (x10 ⁻⁴ Hz)	Transmit Carrier Deviation (Hz)
0	2	1.42
0.5	3	2.51
1	3	0.48
1.5	2	-1.57
2	3	-0.97
2.5	1	1.55
3	3	1.27
FCC SPECIFICATION	+/- 15.0 MHz (+/- 0.05 ppm) +/-0.05 ppm = +/-0.75 Hz	+/-1952.5 MHz (+/- 0.05 ppm) +/-0.05 ppm = +/-97.62 Hz
FCC RESULT	PASS	PASS

Exhibit 17: Measurement of Frequency Stability of FLEXENT™ PCS Modular Cell

Reference and Transmit Frequency Deviation From GPS at +30°C at 100% of Nominal Voltage, 24VDC		
Time (minutes)	15 MHz Deviation from GPS (x10 ⁻⁴ Hz)	Transmit Carrier Deviation (Hz)
0	-4	2.13
0.5	-4	0.68
1	-4	-1.15
1.5	-5	-2.62
2	-5	-0.84
2.5	-3	2.58
3	-2	1.48
FCC SPECIFICATION	+/- 15.0 MHz (+/- 0.05 ppm) +/-0.05 ppm = +/-0.75 Hz	+/-1952.5 MHz (+/- 0.05 ppm) +/-0.05 ppm = +/-97.62 Hz
FCC RESULT	PASS	PASS

Reference and Transmit Frequency Deviation From GPS at +30°C at 85% of Nominal Voltage, 20.4VDC		
Time (minutes)	15 MHz Deviation from GPS (x10 ⁻⁴ Hz)	Transmit Carrier Deviation (Hz)
0	2	-2.23
0.5	3	-0.86
1	3	1.67
1.5	4	1.31
2	2	-2.03
2.5	5	1.38
3	3	-1.53
FCC SPECIFICATION	+/- 15.0 MHz (+/- 0.05 ppm) +/-0.05 ppm = +/-0.75 Hz	+/-1952.5 MHz (+/- 0.05 ppm) +/-0.05 ppm = +/-97.62 Hz
FCC RESULT	PASS	PASS

Reference and Transmit Frequency Deviation From GPS at +30°C at 115% of Nominal Voltage, 27.6VDC		
Time (minutes)	15 MHz Deviation from GPS (x10 ⁻⁴ Hz)	Transmit Carrier Deviation (Hz)
0	-3	0.42
0.5	2	1.56
1	5	-2.13
1.5	-4	-2.91
2	2	-1.62
2.5	3	-2.33
3	5	0.87
FCC SPECIFICATION	+/- 15.0 MHz (+/- 0.05 ppm) +/-0.05 ppm = +/-0.75 Hz	+/-1952.5 MHz (+/- 0.05 ppm) +/-0.05 ppm = +/-97.62 Hz
FCC RESULT	PASS	PASS

Exhibit 17: Measurement of Frequency Stability of FLEXENT™ PCS Modular Cell

Reference and Transmit Frequency Deviation From GPS at +40°C at 100% of Nominal Voltage, 24VDC		
Time (minutes)	15 MHz Deviation from GPS (x10 ⁻⁴ Hz)	Transmit Carrier Deviation (Hz)
0	-4	2.41
0.5	-4	0.57
1	-5	-1.84
1.5	-3	-0.67
2	-3	-2.35
2.5	-2	-0.48
3	3	1.64
FCC SPECIFICATION	+/- 15.0 MHz (+/- 0.05 ppm) +/-0.05 ppm = +/-0.75 Hz	+/-1952.5 MHz (+/- 0.05 ppm) +/-0.05 ppm = +/-97.62 Hz
FCC RESULT	PASS	PASS

Reference and Transmit Frequency Deviation From GPS at +40°C at 85% of Nominal Voltage, 20.4VDC		
Time (minutes)	15 MHz Deviation from GPS (x10 ⁻⁴ Hz)	Transmit Carrier Deviation (Hz)
0	4	1.47
0.5	4	2.38
1	3	0.42
1.5	1	-1.56
2	3	-1.81
2.5	-3	0.97
3	-4	1.58
FCC SPECIFICATION	+/- 15.0 MHz (+/- 0.05 ppm) +/-0.05 ppm = +/-0.75 Hz	+/-1952.5 MHz (+/- 0.05 ppm) +/-0.05 ppm = +/-97.62 Hz
FCC RESULT	PASS	PASS

Reference and Transmit Frequency Deviation From GPS at +40°C at 115% of Nominal Voltage, 27.6VDC		
Time (minutes)	15 MHz Deviation from GPS (x10 ⁻⁴ Hz)	Transmit Carrier Deviation (Hz)
0	4	-2.94
0.5	5	-1.36
1	5	-0.91
1.5	4	1.56
2	3	3.18
2.5	3	2.41
3	1	0.67
FCC SPECIFICATION	+/- 15.0 MHz (+/- 0.05 ppm) +/-0.05 ppm = +/-0.75 Hz	+/-1952.5 MHz (+/- 0.05 ppm) +/-0.05 ppm = +/-97.62 Hz
FCC RESULT	PASS	PASS

Exhibit 17: Measurement of Frequency Stability of FLEXENT™ PCS Modular Cell

Reference and Transmit Frequency Deviation From GPS at +50°C at 100% of Nominal Voltage, 24VDC		
Time (minutes)	15 MHz Deviation from GPS (x10 ⁻⁴ Hz)	Transmit Carrier Deviation (Hz)
0	-3	1.87
0.5	-3	-0.44
1	-4	-2.34
1.5	-4	-2.93
2	2	-2.15
2.5	4	0.68
3	3	2.18
FCC SPECIFICATION	+/- 15.0 MHz (+/- 0.05 ppm) +/-0.05 ppm = +/-0.75 Hz	+/-1952.5 MHz (+/- 0.05 ppm) +/-0.05 ppm = +/-97.62 Hz
FCC RESULT	PASS	PASS

Reference and Transmit Frequency Deviation From GPS at +50°C at 85% of Nominal Voltage, 20.4VDC		
Time (minutes)	15 MHz Deviation from GPS (x10 ⁻⁴ Hz)	Transmit Carrier Deviation (Hz)
0	-2	2.22
0.5	-2	1.54
1	4	2.63
1.5	-3	0.91
2	-5	-2.28
2.5	2	-1.55
3	-3	-2.49
FCC SPECIFICATION	+/- 15.0 MHz (+/- 0.05 ppm) +/-0.05 ppm = +/-0.75 Hz	+/-1952.5 MHz (+/- 0.05 ppm) +/-0.05 ppm = +/-97.62 Hz
FCC RESULT	PASS	PASS

Reference and Transmit Frequency Deviation From GPS at +50°C at 115% of Nominal Voltage, 27.6VDC		
Time (minutes)	15 MHz Deviation from GPS (x10 ⁻⁴ Hz)	Transmit Carrier Deviation (Hz)
0	-5	0.42
0.5	-5	2.31
1	-6	1.52
1.5	-4	0.62
2	-4	-1.68
2.5	-5	-2.84
3	4	-2.16
FCC SPECIFICATION	+/- 15.0 MHz (+/- 0.05 ppm) +/-0.05 ppm = +/-0.75 Hz	+/-1952.5 MHz (+/- 0.05 ppm) +/-0.05 ppm = +/-97.62 Hz
FCC RESULT	PASS	PASS

Exhibit 17: Measurement of Frequency Stability of FLEXENT™ PCS Modular Cell

Upon return to +20°C.

Reference and Transmit Frequency Deviation From GPS at +20°C at 100% of Nominal Voltage, 24VDC		
Time (minutes)	15 MHz Deviation from GPS (x10 ⁻⁴ Hz)	Transmit Carrier Deviation (Hz)
0	-2	0.67
0.5	-2	-1.27
1	0	0.88
1.5	3	-0.47
2	2	1.35
2.5	-2	0.51
3	0	-1.24
FCC SPECIFICATION	+/- 15.0 MHz (+/- 0.05 ppm) +/-0.05 ppm = +/-0.75 Hz	+/-1952.5 MHz (+/- 0.05 ppm) +/-0.05 ppm = +/-97.62 Hz
FCC RESULT	PASS	PASS

Reference and Transmit Frequency Deviation From GPS at +20°C at 85% of Nominal Voltage, 20.4VDC		
Time (minutes)	15 MHz Deviation from GPS (x10 ⁻⁴ Hz)	Transmit Carrier Deviation (Hz)
0	3	-1.87
0.5	3	-0.24
1	2	0.86
1.5	3	0.57
2	2	-0.71
2.5	3	1.37
3	2	0.49
FCC SPECIFICATION	+/- 15.0 MHz (+/- 0.05 ppm) +/-0.05 ppm = +/-0.75 Hz	+/-1952.5 MHz (+/- 0.05 ppm) +/-0.05 ppm = +/-97.62 Hz
FCC RESULT	PASS	PASS

Reference and Transmit Frequency Deviation From GPS at +20°C at 115% of Nominal Voltage, 27.6VDC		
Time (minutes)	15 MHz Deviation from GPS (x10 ⁻⁴ Hz)	Transmit Carrier Deviation (Hz)
0	2	-0.72
0.5	2	1.13
1	0	0.82
1.5	0	-0.47
2	-2	1.24
2.5	-2	0.63
3	-3	-0.45
FCC SPECIFICATION	+/- 15.0 MHz (+/- 0.05 ppm) +/-0.05 ppm = +/-0.75 Hz	+/-1952.5 MHz (+/- 0.05 ppm) +/-0.05 ppm = +/-97.62 Hz
FCC RESULT	PASS	PASS