

Exhibit 11: Listing of Required Measurements

SECTION 2.1033(c)(14)

The data required by Section 2.1046 through 2.1057, inclusive, measured in accordance with the procedures set out in Section 2.1041.

RESPONSE:

The lowest clock frequency in the **Flexent OneBTS Cellular Modular Cell 4.0** is the 10 MHz rubidium reference oscillator. Conducted spurious measurements were performed over the range of 10 MHz to 10GHz which is above the tenth harmonic of the transmit frequency range.

The following pages include the data required for the Product Certification authorization of the **UCR-850 / FCC ID: ASSONEBTS-01**, measured in accordance with the procedures set out in Section 2.1041 of the Rules.

Each required measurement and its corresponding exhibit number are:

Exhibit 12	Section 2.1046	Measurement of Radio Frequency Power Output
Exhibit 13	Section 2.1047	Measurement of Modulation Characteristics
Exhibit 14	Section 2.1049	Measurement of Occupied Bandwidth
Exhibit 15	Section 2.1051	Measurement of Spurious Emissions at Antenna
Exhibit 16	Section 2.1053	Field Strength of Spurious Radiation
Exhibit 17	Section 2.1055	Measurement of Frequency Stability

Exhibit 12: Measurement of Radio Frequency Power Output

SECTION 2.1046

MEASUREMENT OF RADIO FREQUENCY POWER OUTPUT

The test arrangements used to measure the radio frequency power output of the **UCR-850/AS5ONEBTS-01** is on the following page. Measurements were made respectively at each frequency where Occupied Bandwidth measurements were performed. The use of the **UCR-850** requires that the J4 power level be calibrated for the specific channel of use. The test configuration, Figure 12a, allowed the measurement of output power for each channel investigated for Occupied Bandwidth. These included the upper and lower Block edges and at the center channel for each Block.

The **UCR-850** has a maximum power output at its terminals of 0.0033 Watts (5.2 dBm) for a single carrier, 0.0066 Watts (8.2 dBm) for two carriers (5.2 dBm per carrier), and a maximum power output of 0.010 Watts (+10.0 dBm) for three carriers (5.2 dBm per carrier). The steady state range of power adjustment at the output is 30 dB. The minimum power is therefore 30 dB below the maximum (-24.8 dBm) for a single carrier across the Cellular down-link Band (869.00-894.00 MHz).

The **UCR-850** output signal parameters used for testing is defined in Table 12.1 below. For each measurement frequency the channel and power was set in the manner in which the equipment would be installed in actual use. The actual power level necessary for operation is dependant upon a number of factors including number of carriers, operating frequency amplifier gain and filter loss. The spectral performance at that power level for each specific frequency of interest was verified. The attenuation range was also verified. The maximum output power was verified over the Cellular down-link Band and is tabulated in Table 12.3. The specific Frequencies, channels and set power level was also documented on each "Occupied Bandwidth" data sheet for the typical integrated product. When operated with a Lucent Technologies transmit power amplifier, the overall integrated transmitter will maintain its rated output power with an accuracy of +2 / -4 dB.

Applied Signal

The applied signal met the recommended characteristics per ANSI/TIA/EIA-97-D section 6.5.2 as defined below.

Type	Number of Channels	Fraction of Power (Linear)	Fraction of Power (dB)	Comments
Pilot	1	0.2	-7	Code channel W_0^{128}
Sync	1	0.0471	-13.3	Code channel W_{32}^{64} ; always 1/8 rate
Paging	1	0.1882	-7.3	Code channel W_1^{64} ; full rate only
Traffic	6	0.09412	-10.3	Variable code channel assignments; full rate only

TABLE 12.1 Base Station Test Model, Nominal for Main Path

Exhibit 12 *continued*

Type	Number of Channels	Fraction of Power (Linear)	Fraction of Power (dB)	Comments
Transmit Diversity Pilot	1	0.2	-7	Code channel W_{16}^{128}
Traffic	6	0.09412	-10.3	Variable code channel assignments; full rate only

TABLE 12.2 Base Station Test Model, Nominal for Transmit Diversity Path

RESULTS:

The **UCR-850 / ASSONEBTS-01** was configured in the test setup shown in Figure 12A. When measured at each of the Cellular channels tested the **UCR-850/ ASSONEBTS-01** delivered a minimum of 0.0033 Watts per carrier (5.2 dBm/carrier) +2/-0 dB when measured at its output connection.

This data is recorded on the Occupied Bandwidth Data Sheets for all of the Cellular Channels tested and these include the “Left edge”, and “Right Edge” channels for each frequency Band.

The **UCR-850** maximum transmit power compliance data verified over the Cellular down-link band is shown in table 12.3 below. The table shows the channel(s), number of carriers, measured power per carrier, and the total **UCR-850** transmit power. The compliance status for Occupied Bandwidth and Conducted Spurious Emissions is also shown in table 12.3.

Transmit Channel(s)	Number of Carriers	Measured Carrier Power Level	Measured Total Power Level	Occupied Bandwidth	Conducted Spurious Emissions
1019	1	+5.2 dBm	+5.2 dBm	Compliant	Compliant
37	1	+5.2 dBm	+5.2 dBm	Compliant	Compliant
384	1	+5.2 dBm	+5.2 dBm	Compliant	Compliant
384.425	2	+5.2 dBm	+8.2 dBm	Compliant	Compliant
384. 425, 466	3	+5.2 dBm	+10.0 dBm	Compliant	Compliant
746	1	+5.2 dBm	+5.2 dBm	Compliant	Compliant
770	1	+5.2 dBm	+5.2 dBm	Compliant	Compliant
777	1	+5.2 dBm	+5.2 dBm	Compliant	Compliant

TABLE 12.3 UCR-850 Maximum Transmit Power Compliance Data

Exhibit 12 *continued***Measurement Equipment used in Figure 12 For Measurement of RF Power**

<u>Equipment</u>	<u>Description</u>
Product Frame:	Cellular Indoor Flexent OneBTS Modular Cell 4.0 with 6 UCR's and 12 mLAMs
UCR:	UMTS CDMA Radio (FCC ID: AS5ONEBTS-01)
mLAM:	Linear Amplifier Module, Model m (FCC ID: AS5ONEBTS-03)
Transmit Filter:	Cellular Band Transmit Filter appropriate for the investigated Band
Directional Coupler:	HP 778D and 772D Dual Directional Coupler
Power Meter:	HP E4419A Power Meter with EPC-E18A Power Head
Test Cables:	Low loss test cables custom mfg. for Lucent FCC Laboratory
Printer:	HP Model 4500DN Printer
Attenuator, Variable	HP 8494B and 8495B DC-18 GHz digital attenuators
Attenuator, Fixed	Weinschel Corp DC-18 GHz, various values
Low & High Pass Filters:	Trialthic, Various 10 MHz-20 GHz, Custom manufactured for Lucent FCC Laboratory
Spectrum Analyzer:	Rohde & Schwarz ESIB EMI Test Receiver or Rohde & Schwarz FSEM Spectrum Analyzer
Code Domain Analyzer	Agilent E4445A PSA Series Spectrum Analyzer
Computer Controller:	EG Technology, Custom Mfg for FCC Laboratory Intel™ Pentium III & IV, 550 and 1600 MHz controllers with TILE™ software

Exhibit 12

Figure 12A/14A/15A Test Configuration For RF Power, Occupied Bandwidth and Conducted Spurious

Lucent FLEXENT® OneBTS
Cellular CDMA 4.0 MODULAR CELL

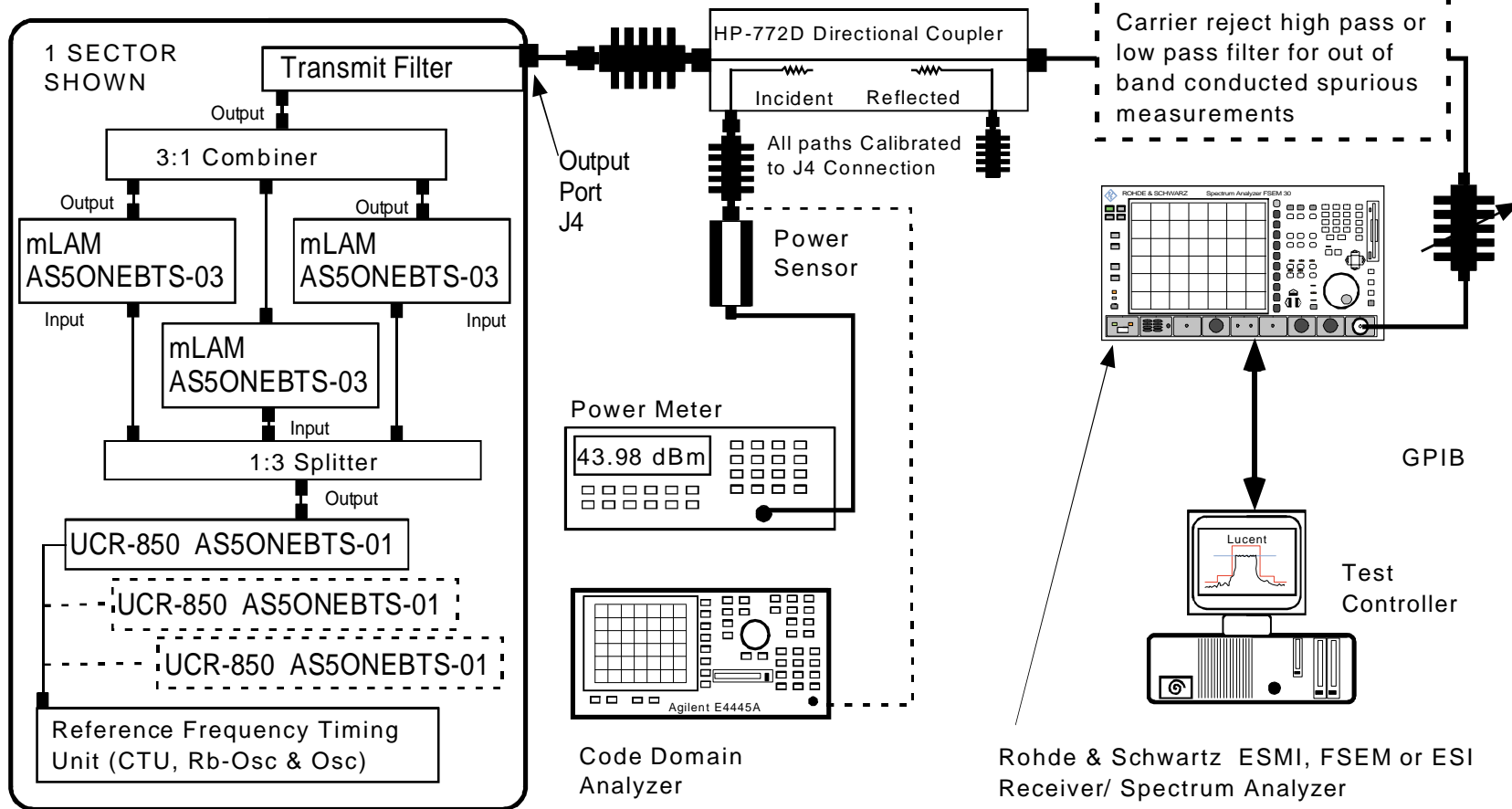

Cellular 850 4.0 Modular Cell UCR Test Figure
WSM/DTD 7/29/02

Exhibit 13: Measurement of Modulation Characteristics

SECTION 2.1047

MEASUREMENT OF MODULATION CHARACTERISTICS

The **UCR-850 / AS5ONEBTS-01** was configured in the test setup shown in Figure 13A. The **UCR-850** was configured with its pilot channel and the modulation quality measured with a Agilent -E4445A PSA Series Spectrum Analyzer.

Measurements were performed at Cellular Channels 1019, 37, 384, 746 and 770.

For each of the Cellular channels tested, the **UCR-850/ AS5ONEBTS-01** modulation quality factor, rho, was measured to be ≥ 0.98 . The **UCR-850** transmit signal modulation parameters and constellation for channel 384 is shown in Figure 13B below. The data for channel 1019 is representative of the data recorded for the remaining channels listed above and was taken utilizing the Agilent -E4445A PSA Series Spectrum Analyzer

Exhibit 13

Figure 13A Test Configuration For RF Modulation Quality

Lucent FLEXENT® OneBTS
Cellular CDMA 4.0 MODULAR CELL

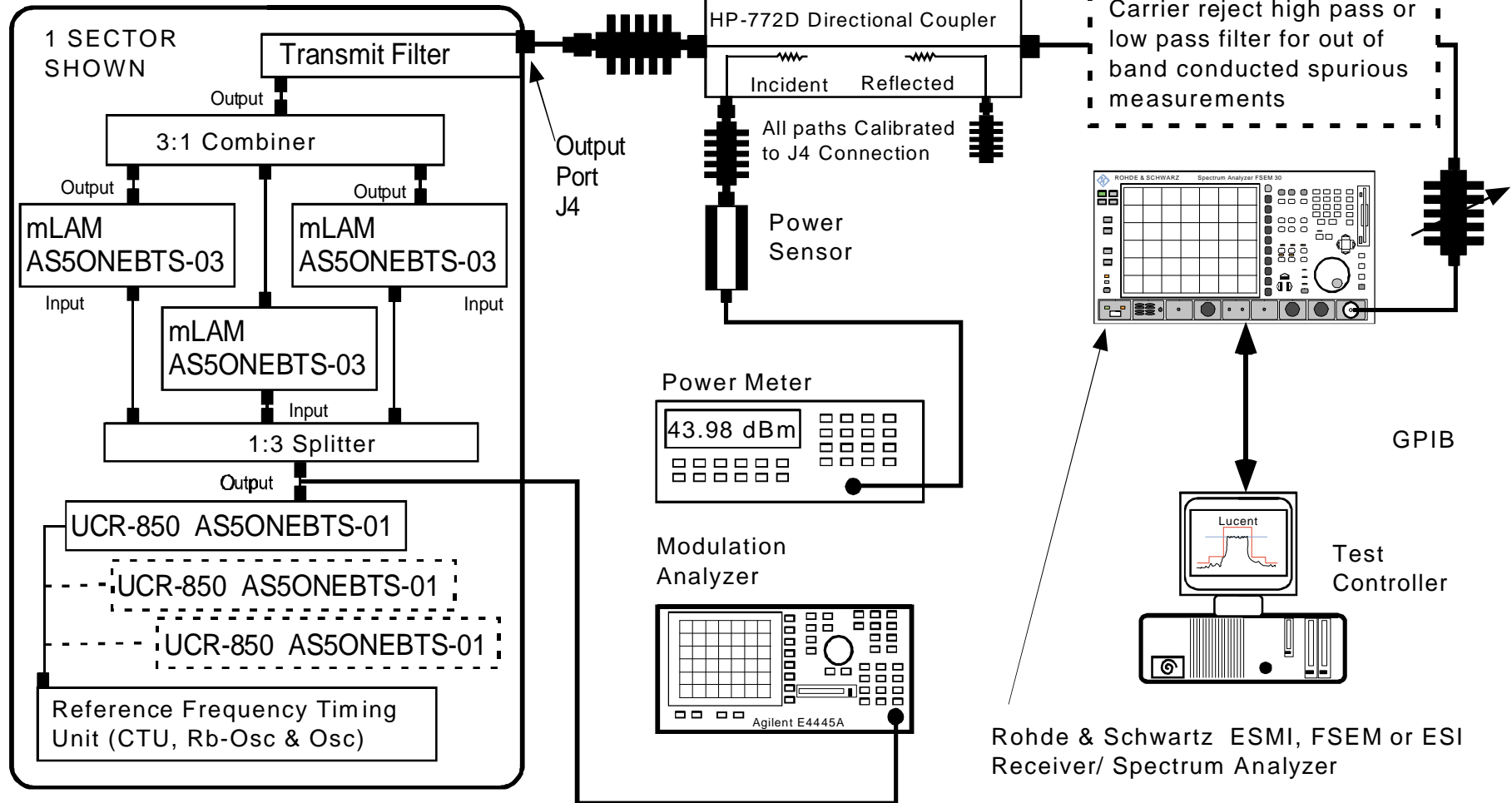

Cellular 850 4.0 Modular Cell UCR Test Figure
WSM/DTD 7/29/02

Figure 13B UCR-850 Measured Transmit Signal Modulation Parameters for Channel 384

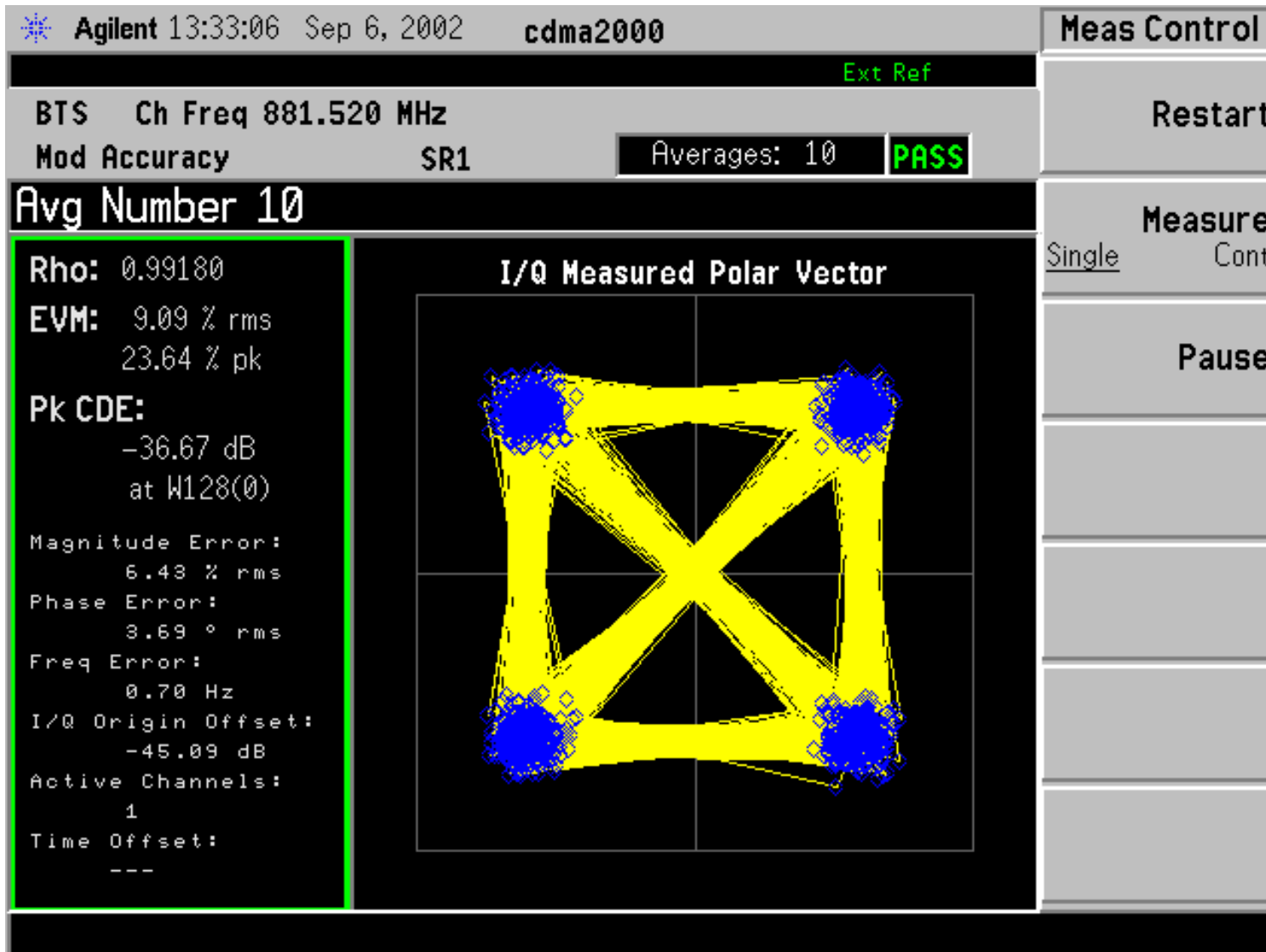

Exhibit 14 Measurement of Occupied Bandwidth

SECTION 2.1049 MEASUREMENT OF OCCUPIED BANDWIDTH

The **UCR-850** is designed to transmit one, two, or three contiguous 1.23 MHz CDMA channels. This exhibit documents the typical performance of the **UCR-850** when transmitting one, two or three CDMA carriers.

The occupied bandwidth of the **UCR-850/ FCC ID: AS5ONEBTS-01** was measured using a Rohde & Schwarz FSEM spectrum analyzer, a PC based instrumentation controller using TILE™ software and calibrated RF equipment. The RF power level was measured and adjusted via the test setup in Figure 14A. The calibrated RF output from the transmitter was reduced (to an amplitude usable by the spectrum analyzer) by using a calibrated broadband attenuator. The total attenuation was set to avoid overdrive of the spectrum analyzer and still allow high dynamic range measurements. Because of the broadband nature of the CDMA signal and the required 30 kHz resolution bandwidth, a power calibration was performed to validate the accuracy of the -16.2 dBc setpoint. The -16.2 dBc level corresponds to the corrected RF power level for a 1.25 MHz signal measured with a 30 kHz resolution bandwidth (RBW). This set-point was performed as follows:

The power calibration was individually verified at each carrier using a power meter in the Figure 14A setup. Additionally a power calibration was performed to calibrate the setting of the measured 30 kHz Occupied Bandwidth signal at the -16.2 dBc line and a 3 MHz resolution bandwidth (RBW) measurement against the “Top of Mask” limit which corresponds to the output power at an RBW setting of ≥ 1.25 MHz. These measurements were performed prior to each Occupied Bandwidth measurement. The single carrier signal was measured with RBW's of 3 MHz and 30 kHz and is co-plotted and shown in Figure 14C: Typical Power Calibration. To avoid the discrepancy and offset between different detector types the Calibrated power meter value is used as the reference. The digital attenuation is therefore set to place the 3 MHz RBW signal at the “Top of Mask”. The multi-carrier measurements were performed with the required 30 kHz RBW and used the same exact attenuation values.

This test procedure above calibrates the carrier power to the “Top of Mask” and accurately places the 30 kHz RBW measured carrier at the -16.2 dBc line. This process also documents the carrier power at the specified power level of 25 watts per carrier / 43.98 dBm. All of the plots are presented with a 7.5 MHz span and the center frequency of the specific Sub-Block of interest. This allows for ease of comparison of the single, dual and three carrier signals performance. The data was electronically recorded, corrected and plotted using the TILE™ software and is shown in the Occupied Bandwidth Data Sheets. These sheets contain data for Cellular frequency Blocks A3, B1, and B' in the application.

Block Organization and Tests Performed

For Cellular Band A, Sub-Block filter A3 is designed for a maximum of one carrier and is placed for the “Left Edge of Cellular Band”. Block B is partitioned differently as the B1 Sub-Block filter is for the “Middle of Cellular Band” and is designed for as many as three carriers. Sub-Block filter B' is designed for a maximum of one carrier and is placed for the “Right Edge of Cellular Band”.

(Note: Because of the extreme narrowness of the B' band the right edge of the cellular band is only 705 kHz from the signal center frequency.)

When operated in the multi-carrier configuration the B1 Occupied Bandwidth plots present one, two and three center channel performance charts at the Left Edge of Block for B1 (“Middle of Cellular Band”). The A3 and B' Plots present the one carrier performance for their respective bands.

Exhibit 14 *continued*

Filter combination tests were performed for the one, two and three carrier operational configurations of the UCR-850 where applicable. When a second source manufacturer is to be qualified for a granted block, the tests are performed and the source approved via a Class I change to each of the applicable filings.

Applied Signal

The applied signal met the recommended characteristics per ANSI/TIA/EIA-97-D section 6.5.2 as defined below.

Type	Number of Channels	Fraction of Power (Linear)	Fraction of Power (dB)	Comments
Pilot	1	0.2	-7	Code channel W_0^{128}
Sync	1	0.0471	-13.3	Code channel W_{32}^{64} ; always 1/8 rate
Paging	1	0.1882	-7.3	Code channel W_1^{64} ; full rate only
Traffic	6	0.09412	-10.3	Variable code channel assignments; full rate only

TABLE 14.1 Base Station Test Model, Nominal for Main Path

Type	Number of Channels	Fraction of Power (Linear)	Fraction of Power (dB)	Comments
Transmit Diversity Pilot	1	0.2	-7	Code channel W_{16}^{128}
Traffic	6	0.09412	-10.3	Variable code channel assignments; full rate only

TABLE 14.2 Base Station Test Model, Nominal for Transmit Diversity Path

The minimum standard presented in IS-97-D Section 4.5.1.3.1 was followed.

“Suppression inside the licensee’s frequency band(s)”

For all frequencies within the base station transmit band of 869 – 894 MHz that are within the specific block(s) allocated to the operator's system, the total conducted spurious emissions in any 30kHz band greater than 750 kHz for the CDMA channel center frequency shall not exceed a level of -45 dBc....

Measurement at a Resolution Bandwidth of 30 kHz is based on our experience with Section 22.917 of The Code and lacking other guidance.

The spectrum analysis output plots shows the peak of the CDMA channel signal 16.2 dB below the Mask reference / “zero dBc line” of the spectrum analyzer for the following reason: For the CDMA system there is no carrier without modulation. The following relationship was used to provide the correct level for an unmodulated carrier vs. the modulated signal.

Exhibit 14 *continued*

Equation (1): Signal Offset = $10 \cdot \log$ (Measured resolution bandwidth/ Transmit signal bandwidth)

For the peak of the CDMA signal measured with a resolution bandwidth of 30 kHz the signal offset is:

$$\text{Signal Offset} = 10 \cdot \log (30 \text{ kHz} / 1.25 \text{ MHz}) = -16.2 \text{ dB}$$

Adjusted Levels

All of the tolerance lines for the output are referenced to the top of the Occupied Bandwidth mask, which is defined as 43.98 dBm/ zero dBc. For all measurements of the **UCR-850's** Occupied Bandwidth, the output power was measured / adjusted individually to the 25 W level for each carrier and this is the 43.98 dBm value at the 0 dBc reference line.

In order to depict the tolerance lines that are required by Sec 22.917 of the FCC Rules IS-97-D, all measurements were made with a resolution bandwidth of 30 kHz and the limits were adjusted using equation (1). An average detector was employed using minimum of 25 sweeps per trace.

Mask Description for Single Carrier

The Mask limits are identical for the left and right side of the Cellular Band and are as follows. Figure 14-B shows the Mask limit for Cellular channel 37 which is at the left Band edge for A Band. The Spectrum Analyzer reference level is set above the Signal Reference to allow for the necessary dynamic range of a CDMA carrier presentation. The top of a typical 43.98 dBm single carrier CDMA signal viewed at a resolution bandwidth of 30 kHz is shown at the 27.78 dBm/ -16.2 dBc line. This line is based on equation 1, and the ratio of the 1.25 MHz bandwidth and the 30 kHz resolution bandwidth of the spectrum analyzer. The vertical line from a to b (i.e. a-b) is at 750 kHz from the center of channel 37 (i.e. F_c), per IS-97-D. The horizontal line b-c is 45 dB below the 43.98 dBm/ 0 dBc reference level. The vertical line c-d on this chart is at 869 MHz which is the left band edge for the 869-894 MHz Cellular Band. When the subblock is entirely inside the cellular band the line c-d can alternately be set at +/- 1.98 MHz from the carrier center frequency per ANSI/TIA/EIA-97-D-2001. The placement of line d-e is the out of band limit level of -13 dBm appropriate for a 25 watt signal. This limit is specified in 47CFR22.917 as an attenuation from the transmitted signal of:

$$\text{Equation (2) Attenuation} = 43 + 10 \text{ LOG (P)} \quad \text{Where P is the power in watts.}$$

The out of band limit of -13 dBm is specified to be measured with an RBW of 30 KHz. The same logic was used in determining the other block and band edge tolerances.

Mask Description for Multiple Carrier

The mask for multiple carriers only adjusts the width of the carrier portion of the mask. For the example given with multiple carriers there would be no adjustments made to the "Left Edge of Block" requirements. The specified "Right Edge Limit" is treated as an expansion of the non Block edge corner **aa** to be the required + 750 kHz from the center of the "right most" channel. The "Right Edge of Block" limits were derived consistently.

Exhibit 14 *continued***Measurement**

All of the tolerance lines for the output are referenced to the top of the Occupied Bandwidth mask, which is defined as 43.98 dBm/ zero dBc. For all measurements of the **UCR-850's** Occupied Bandwidth, the output power was measured / adjusted individually to the 25 W level for each carrier and this is the 43.98 dBm value at the 0 dBc reference line.

In order to depict the tolerance lines that are required by Sec 22.917 of the FCC Rules , all measurements were made with a resolution bandwidth of 30 kHz and the limits were adjusted using equation (1). An average detector was employed using minimum of 25 sweeps per trace.

Presented Results

The frequencies and channels used are tabulated on the bottom of each plot. Input and output signals are plotted at each frequency/ channel. Plots are provided for Left Edge, Center and Right Edge of the Cellular Band in compliance with Section 22.917 of the Commission code. There are no SAT or Wide band data signals associated with CDMA. The signal used to show the occupied bandwidth is defined in table 14.1. This is the signal recommended in IS-97-D. The power output level was adjusted to provide the documented power levels at the bottom of each chart.

RESULTS: The following exhibits illustrate the spectrums investigated and document compliance.

Daniel. T. Donohue

Exhibit 14 *continued*

Test Equipment and Results

Table 14-2 Equipment used for Measurement of RF Transmit Power, Occupied Bandwidth and Conducted Spurious Emissions

<u>Equipment</u>	<u>Description</u>
Product Frame:	Cellular Indoor FLEXENT™ OneBTS Modular Cell 4.0 with 6 UCR's and 12 mLAMs
UCR:	UMTS CDMA Radio (FCC ID: AS5ONEBTS-01)
mLAM:	Linear Amplifier Module, Model m (FCC ID: AS5ONEBTS-03)
OMR&OMQ :	Oscillator Module, 15 MHz Rubidium and Crystal types
Transmit Filter:	Cellular Band Transmit Filter appropriate for the investigated Block
Directional Coupler:	HP 778D and 772D Dual Directional Coupler
Power Meter:	Agilent E4419B Power Meter with EPC-E18A Power Sensor or
Test Cables:	W.L. Gore; Low loss test cables custom mfg. for Lucent FCC Laboratory
Printer:	HP Model 4500DN Printer
Attenuator, Variable	HP 8494B and 8495B DC-18 GHz digital attenuators
Attenuator, Fixed	Weinschel Corp DC-18 GHz, various values
High Pass Filters:	Trialithic, 1-18 GHz, Custom manufactured for Lucent FCC Laboratory
Low Pass Filters:	Trialithic, 10MHz –900 MHz, Custom manufactured for Lucent FCC Laboratory
Spectrum Analyzer:	Rohde & Schwarz ESIB EMI Test Receiver or Rohde & Schwarz FSEM Spectrum Analyzer
Code Domain Analyzer	Agilent E4445A PSA Series Spectrum Analyzer
Computer Controller:	EG Technology, Custom Mfg for FCC Laboratory, Intel™ Pentium III & IV, 550 and 1600 MHz controllers with TILE™ software

Exhibit 14

Figure 12A/14A/15A Test Configuration For RF Power, Occupied Bandwidth and Conducted Spurious

Lucent FLEXENT® OneBTS
Cellular CDMA 4.0 MODULAR CELL

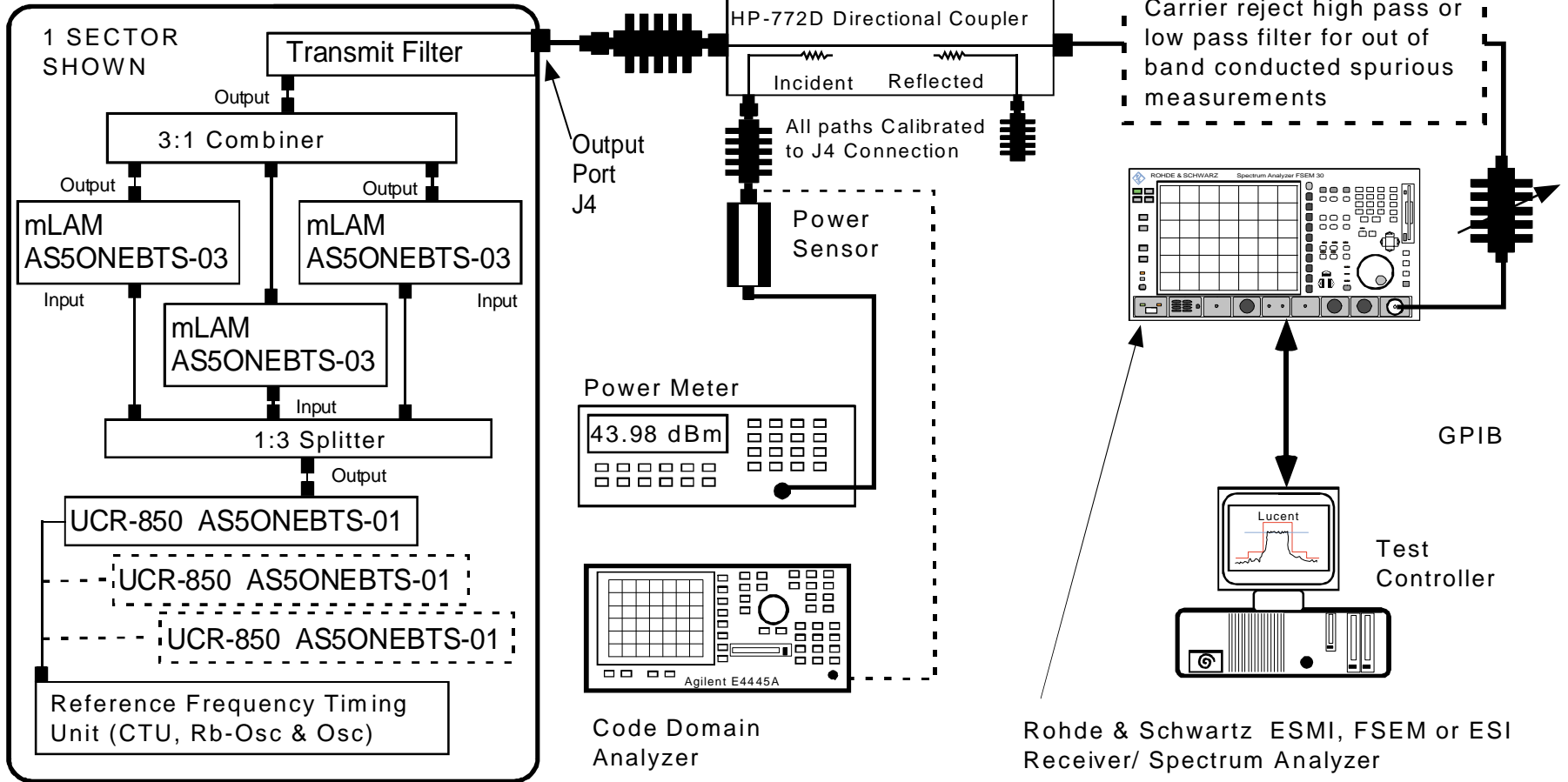

Cellular 850 4.0 Modular Cell UCR Test Figure
WSM/DTD 7/29/02

Figure 14B Occupied Bandwidth Mask

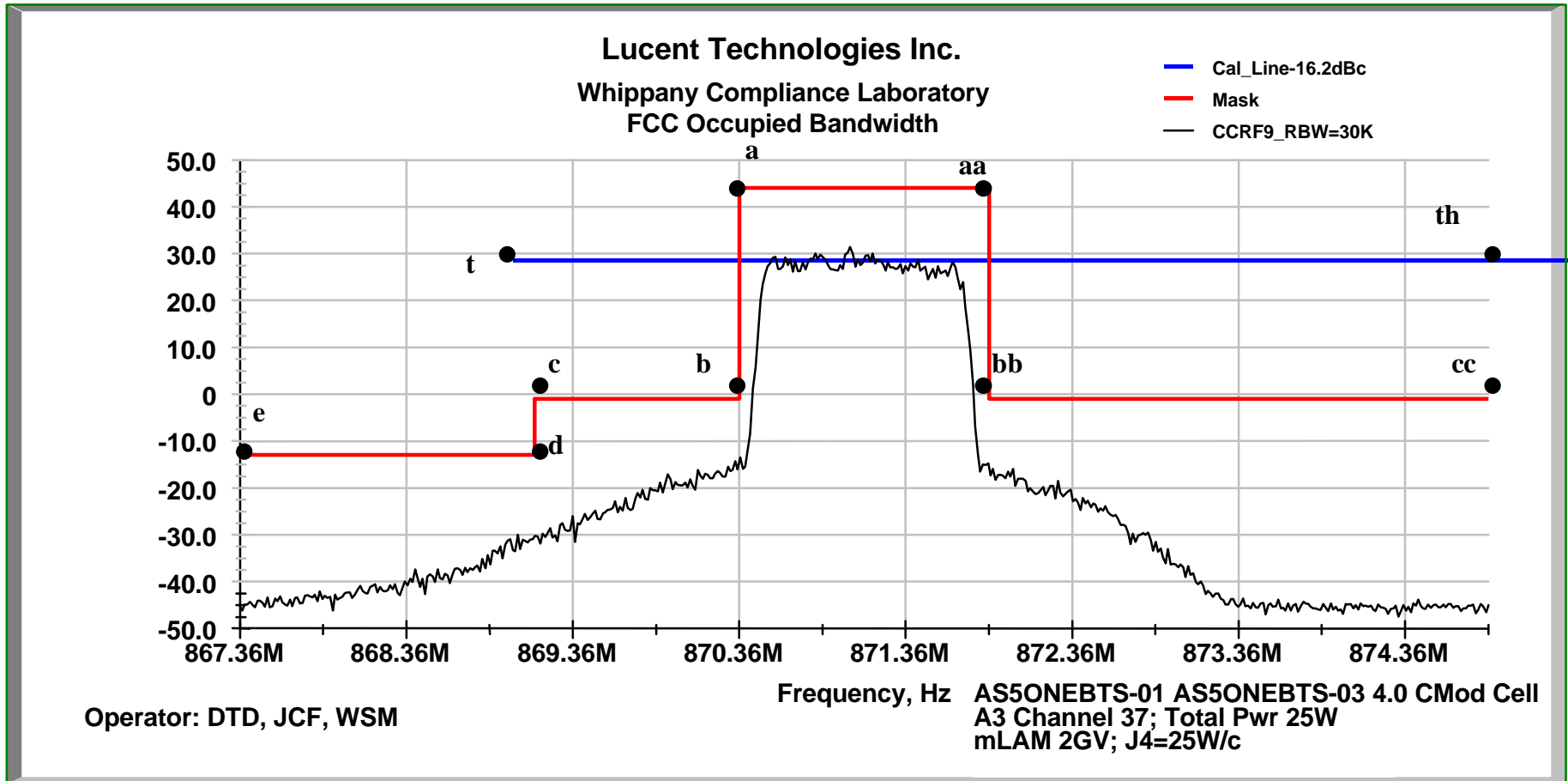

Figure 14C Typical Power Calibration

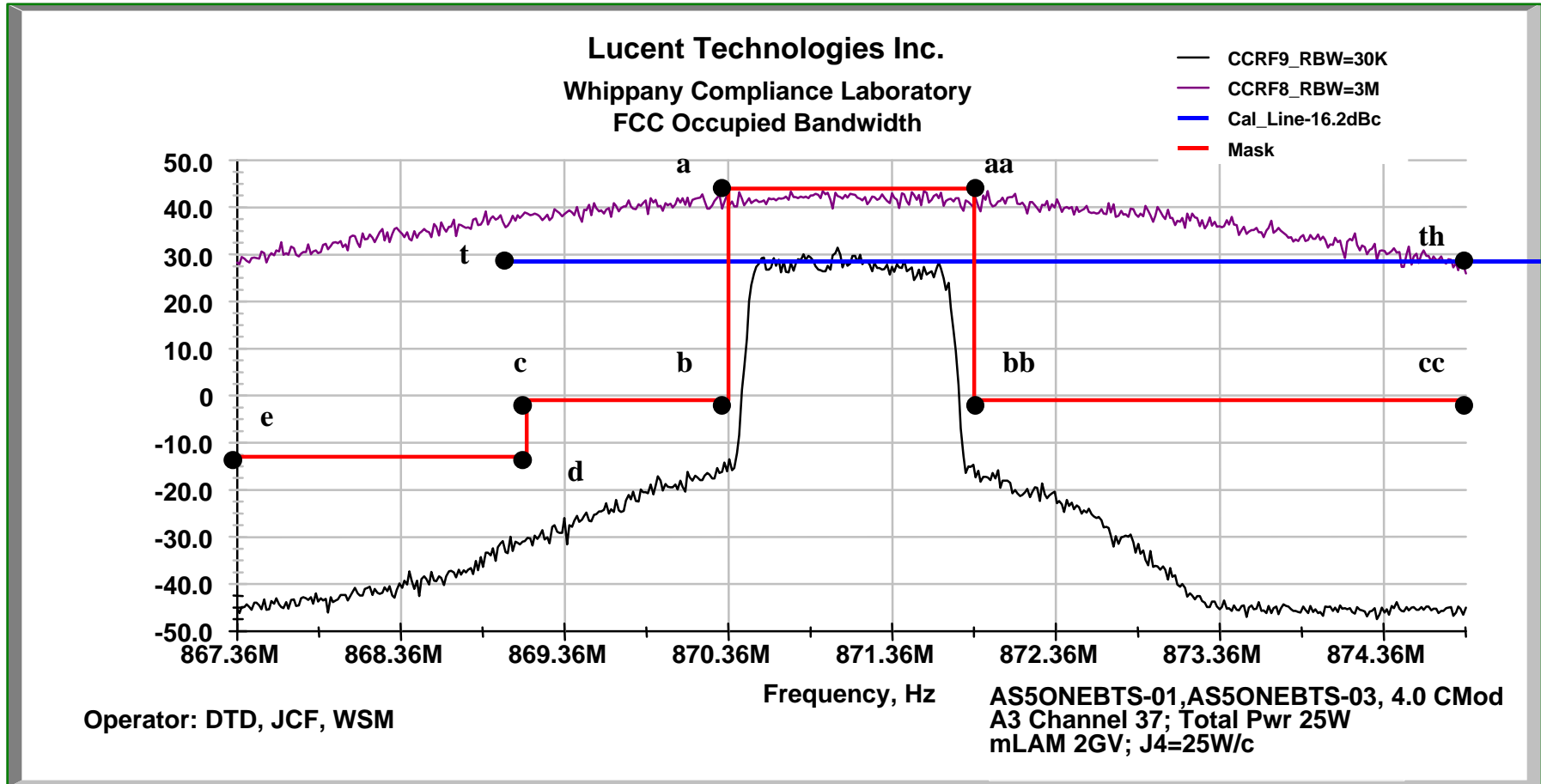

Exhibit 14 *Continued*

**FCC
Occupied Bandwidth Data Scans
of
Lucent Technologies Inc.
Cellular 850 ONEBTS Modular Cell 4.0
Incorporating
Cellular 850 UMTS CDMA Radio
UCR-850 Filed under AS5ONEBTS-01
with
Cellular 850 Linear Amplifier Module, Model m
mLAM, FCC ID: AS5ONEBTS-03
Single, Dual and Three Carrier Configurations**

Exhibit 14 Continued

FCC Occupied Bandwidth: UCR-850 Output - Left edge of "A" Band; Channels 1019, 37 and 78; 3 Carrier Configuration

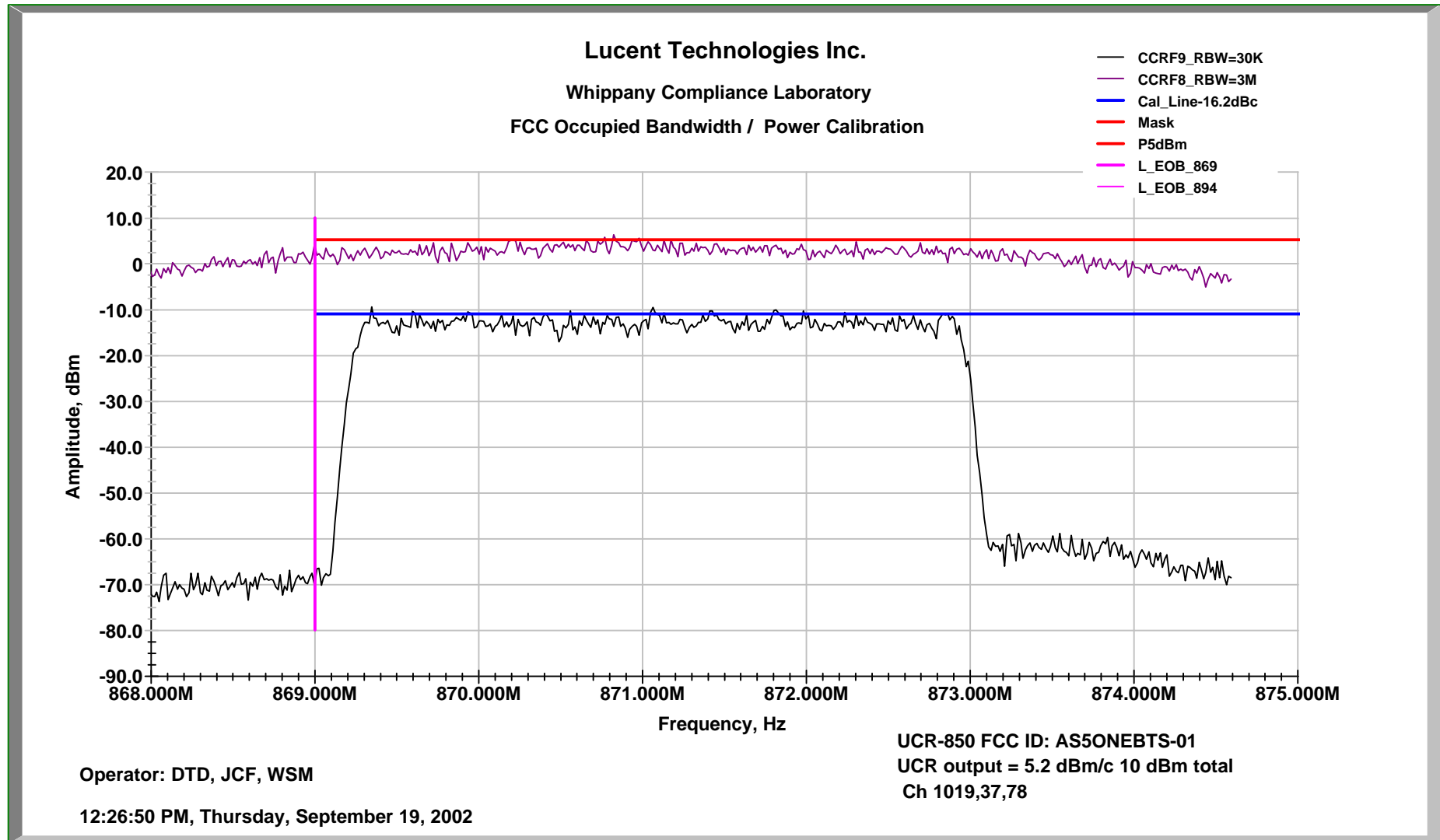

Exhibit 14 Continued

FCC Occupied Bandwidth: UCR Output / mLAM Input - Cellular A Block, Sub-Block A3, Single Carrier Configuration

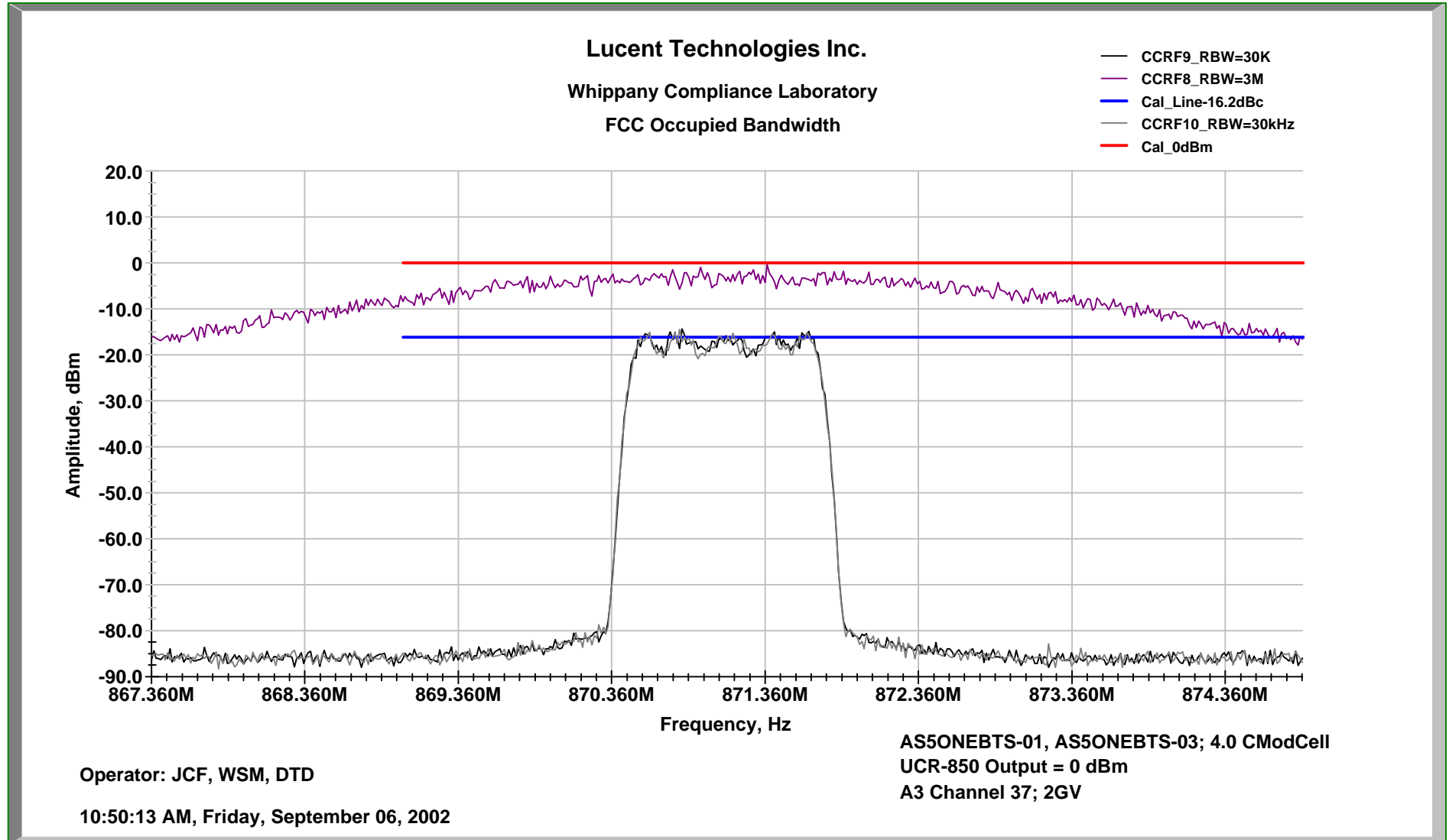

Exhibit 14 *Continued*

FCC Occupied Bandwidth: Output Chart - Cellular A Block, Sub-Block A3, Single Carrier Configuration mLAM/MCA

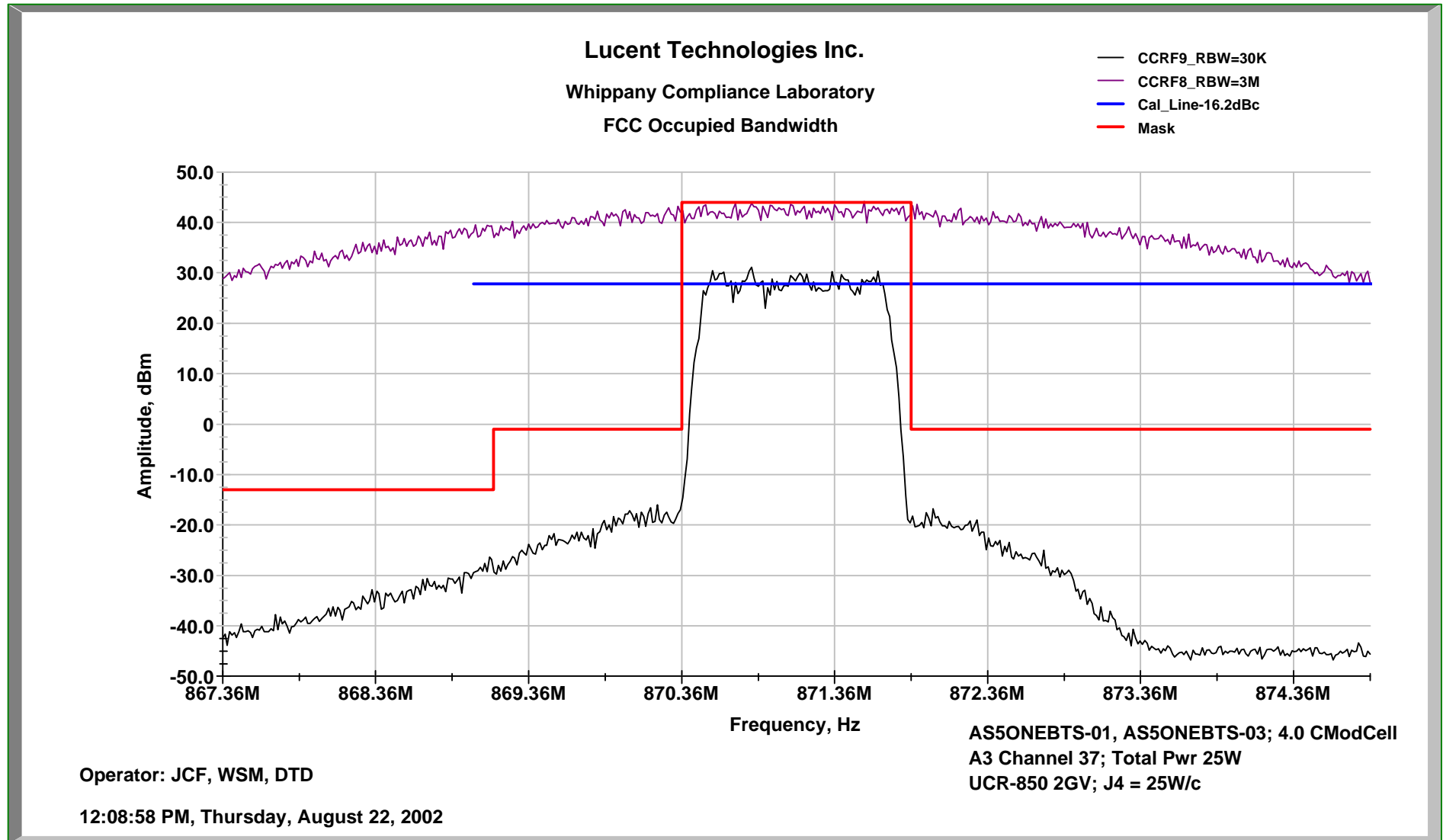

Exhibit 14 Continued

FCC Occupied Bandwidth: UCR Output / mLAM Input - Cellular B Block, Sub-Block B1, Single Carrier Configuration

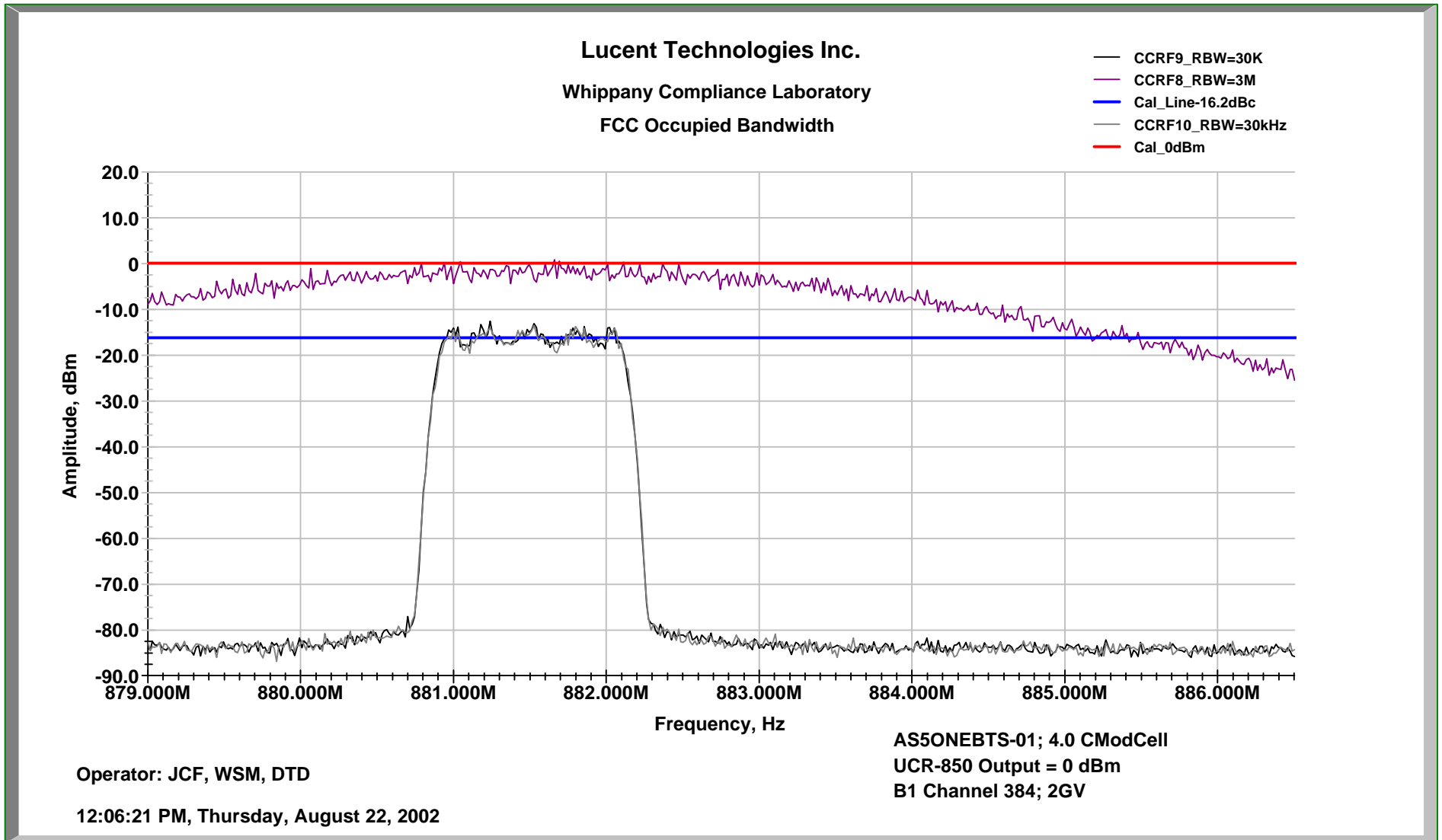

Exhibit 14 Continued

FCC Occupied Bandwidth: Output Chart - Cellular B Block, Sub-Block B1, Single Carrier Configuration mLAM/MCA

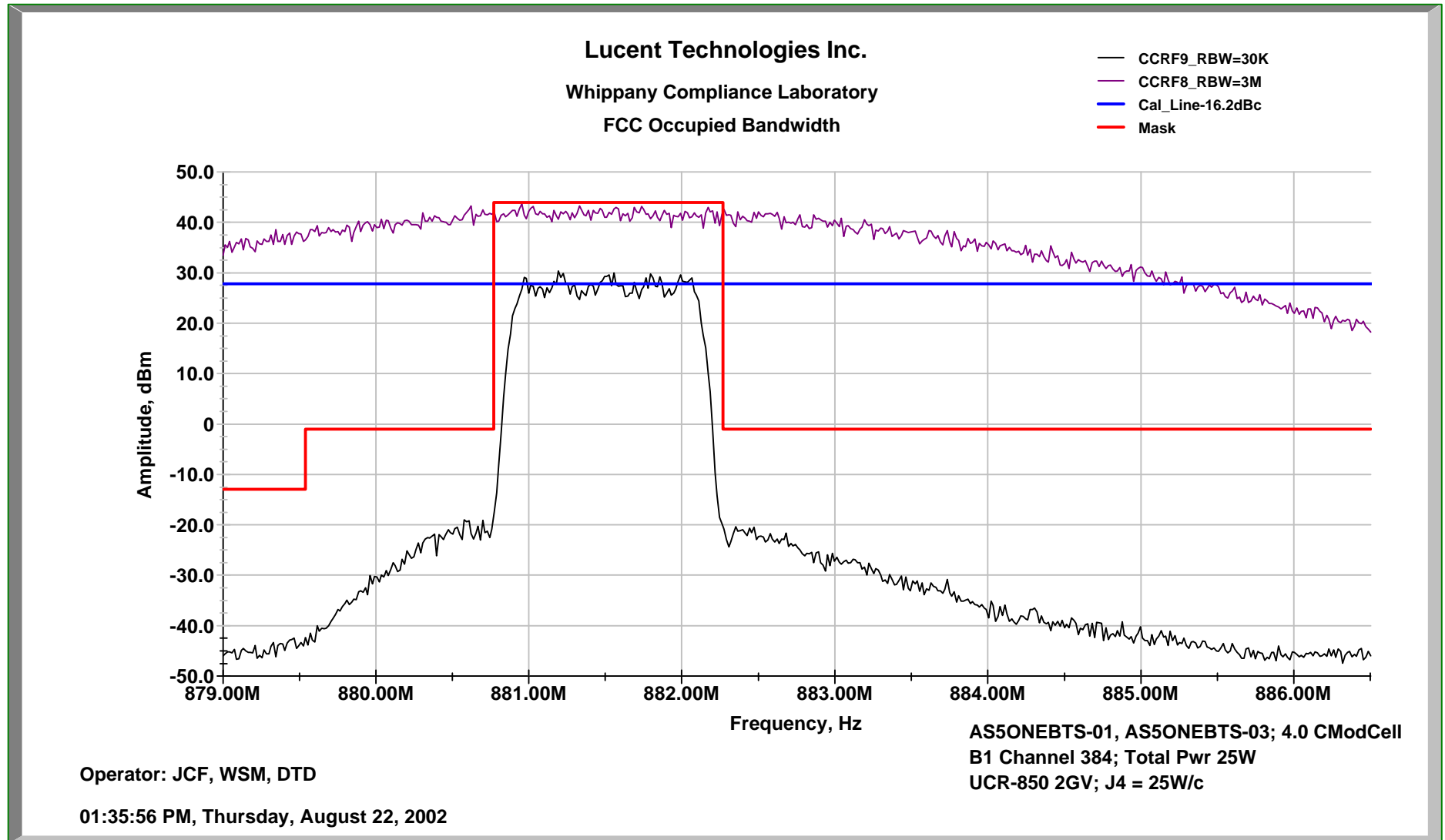

Exhibit 14 Continued

FCC Occupied Bandwidth: UCR Output / mLAM Input - Cellular B Block, Sub-Block B1, Dual Carrier Configuration

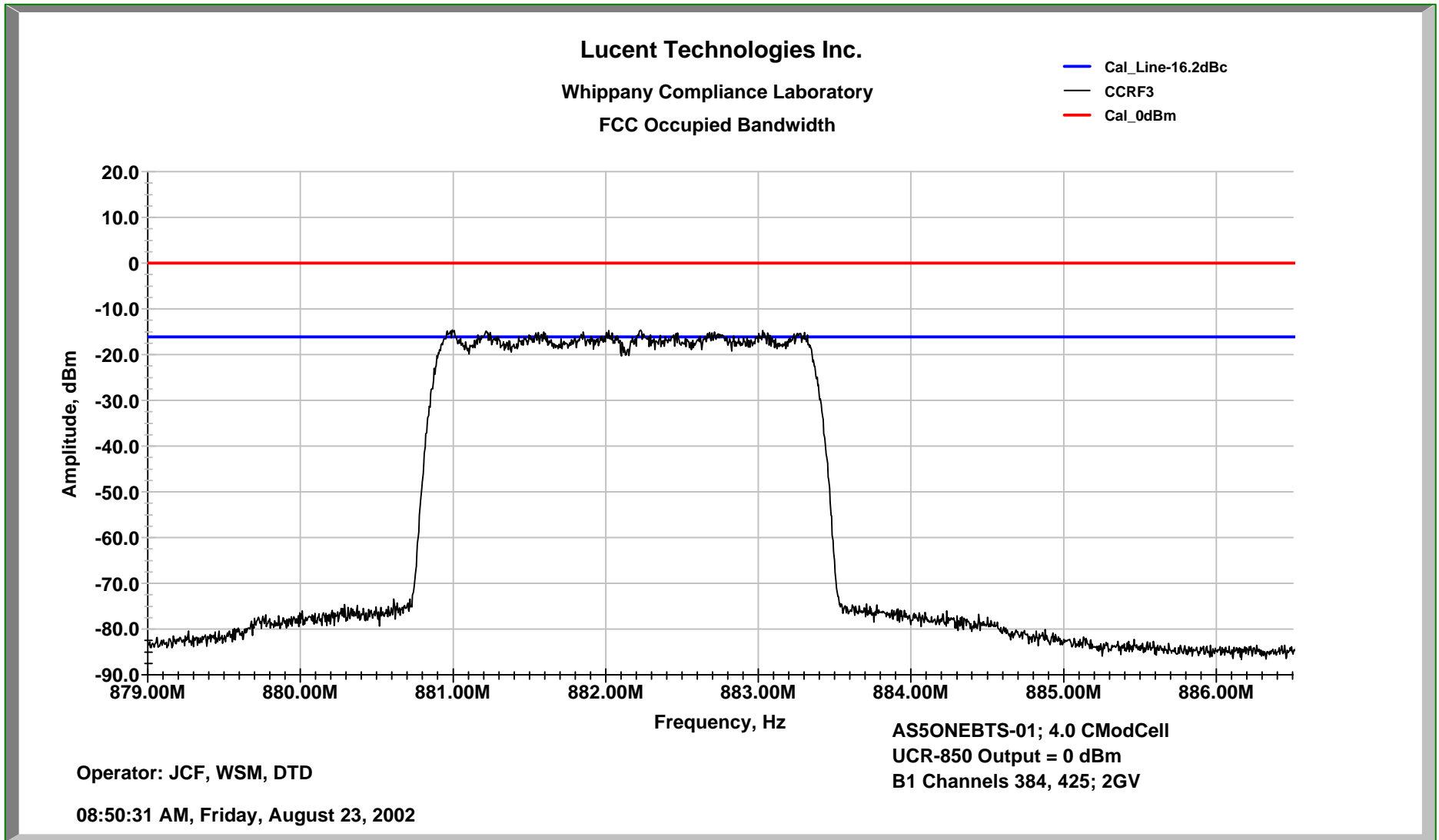

Exhibit 14 Continued

FCC Occupied Bandwidth: Output Chart - Cellular B Block, Sub-Block B1, Dual Carrier Configuration mLAM/MCA

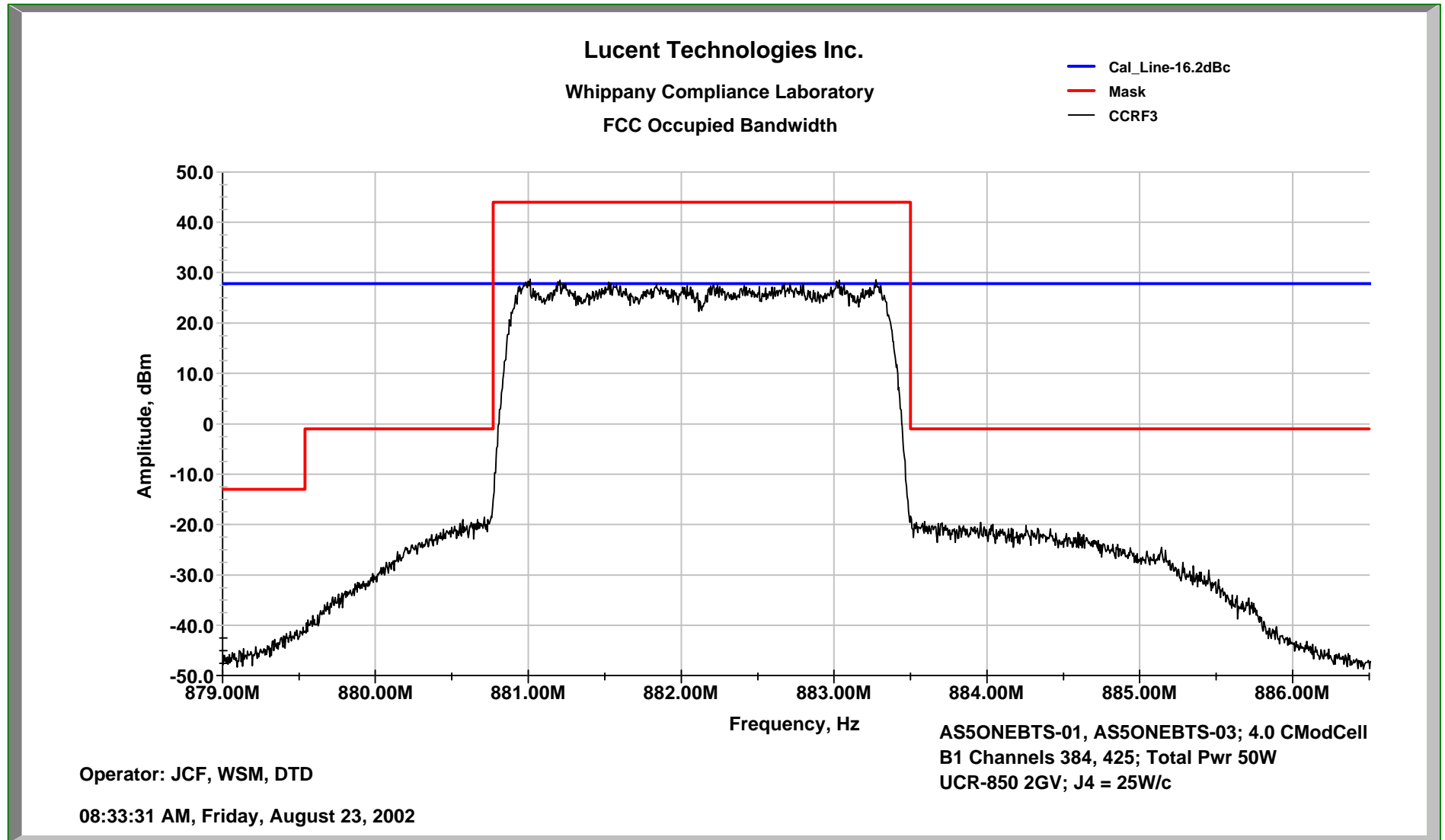

Exhibit 14 *Continued*

FCC Occupied Bandwidth: UCR Output / mLAM Input - Cellular B Block, Sub-Block B1, Three Carrier Configuration

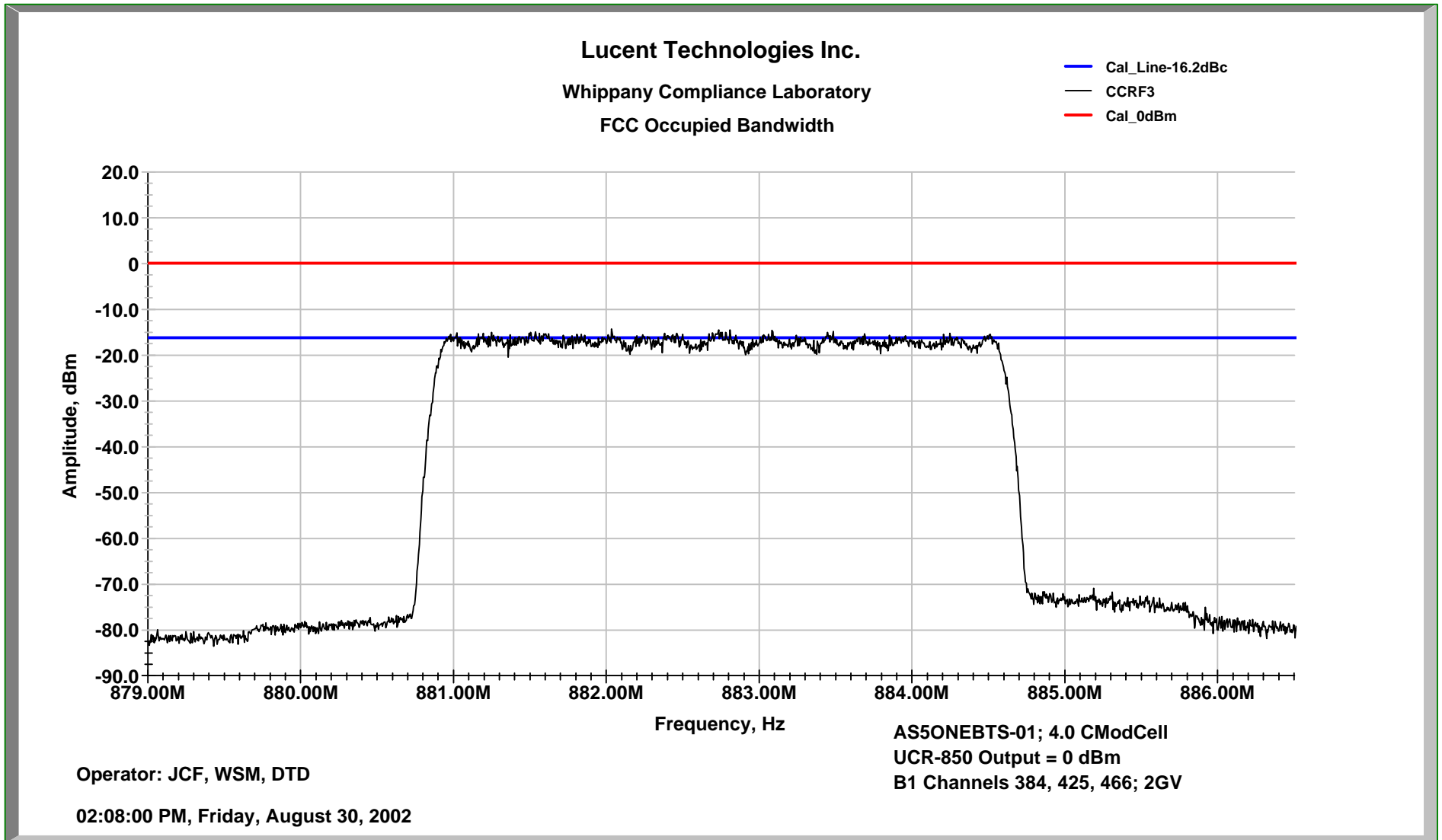

Exhibit 14 Continued

FCC Occupied Bandwidth: Output Chart - Cellular B Block, Sub-Block B1, Three Carrier Configuration mLAM/MCA

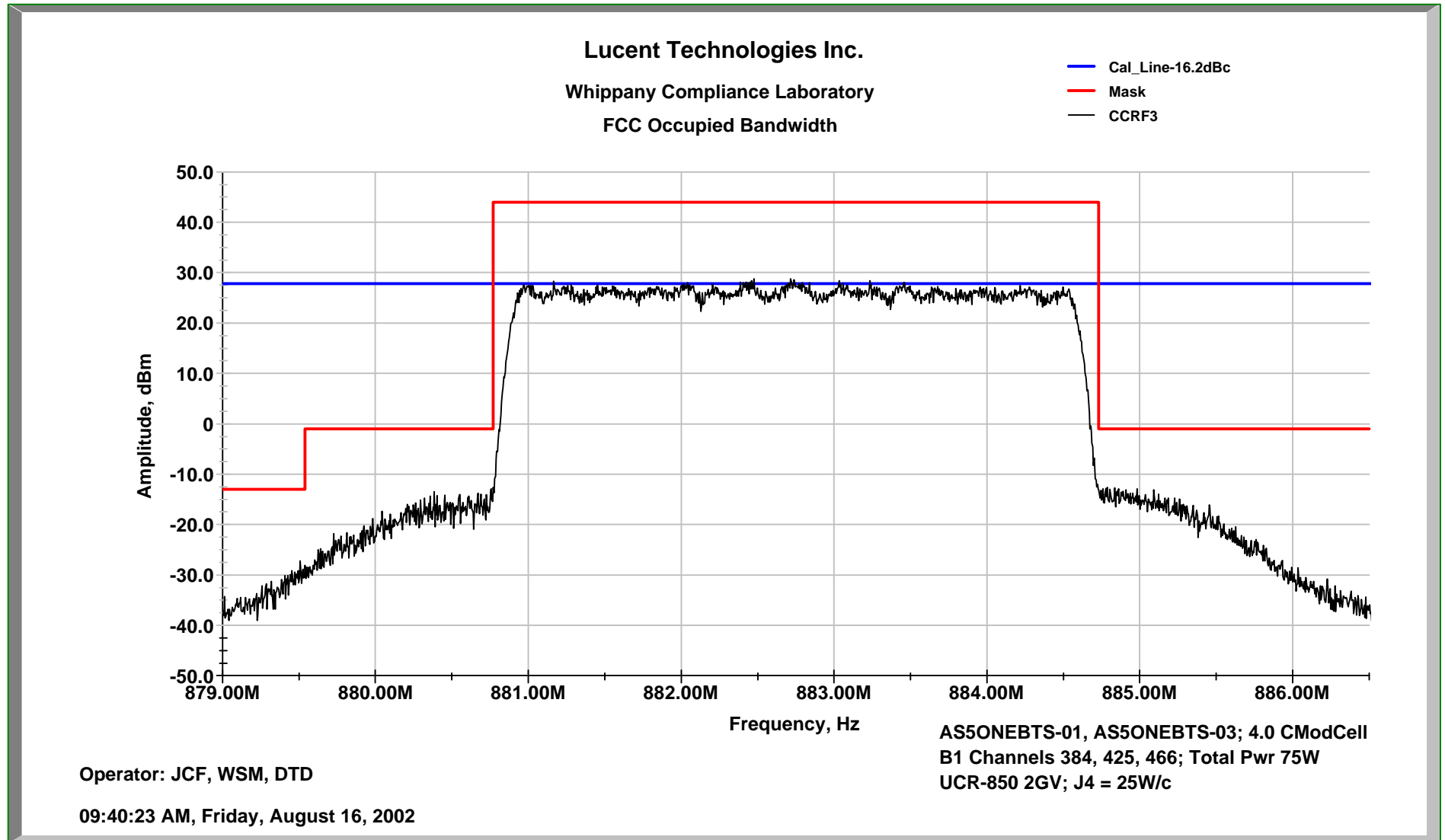

Exhibit 14 *Continued*

FCC Occupied Bandwidth: UCR Output / mLAM Input - Cellular B Block, Sub-Block B', Single Carrier Configuration

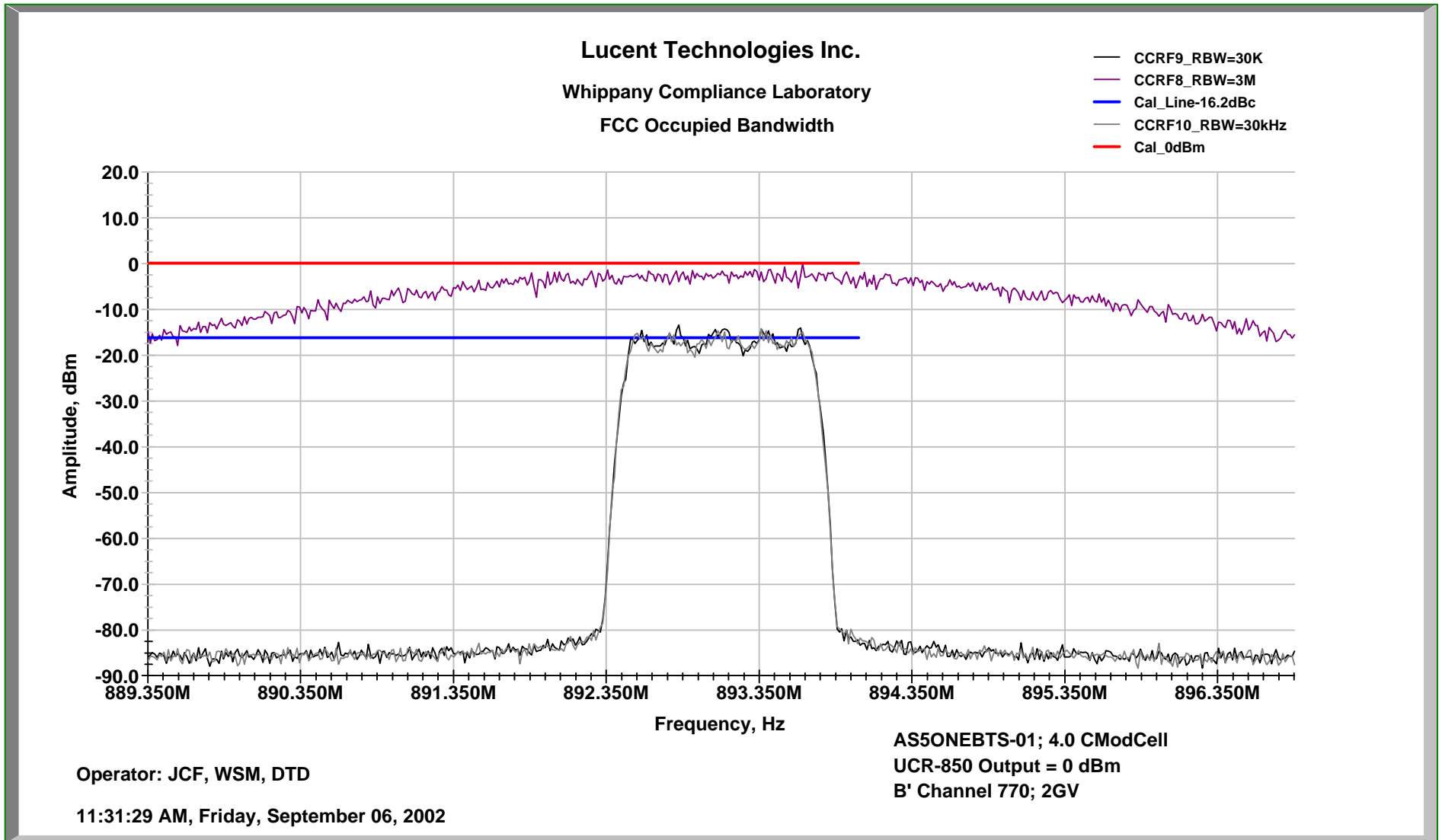

Exhibit 14 Continued

FCC Occupied Bandwidth: Output Chart - Cellular B Block, Sub-Block B', Single Carrier Configuration mLAM/MCA

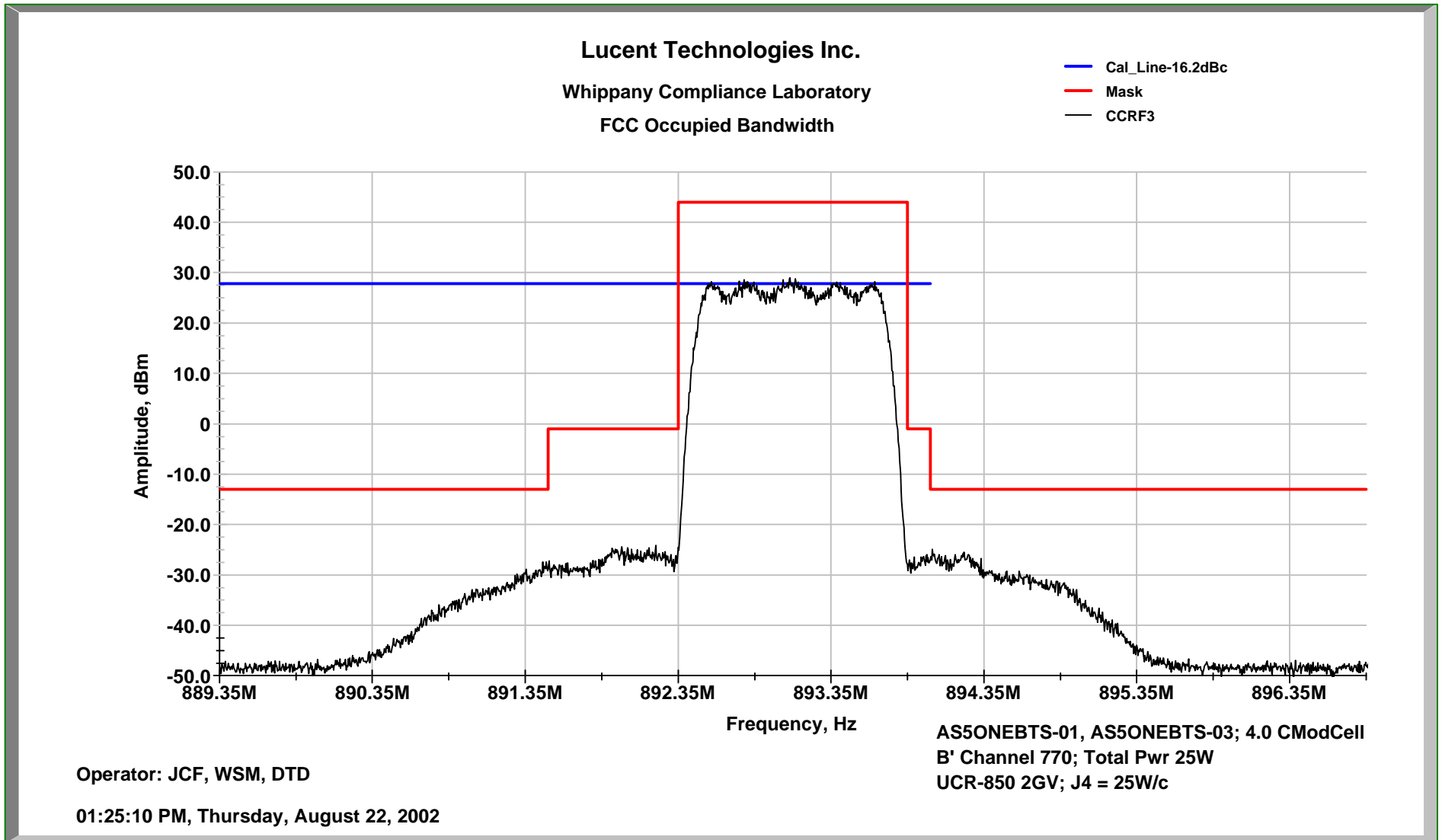

Exhibit 14 *Continued*

FCC Occupied Bandwidth: UCR-850 with mLAM Output - Right edge of "B" Band; Channel 770; 1 Carrier Configuration

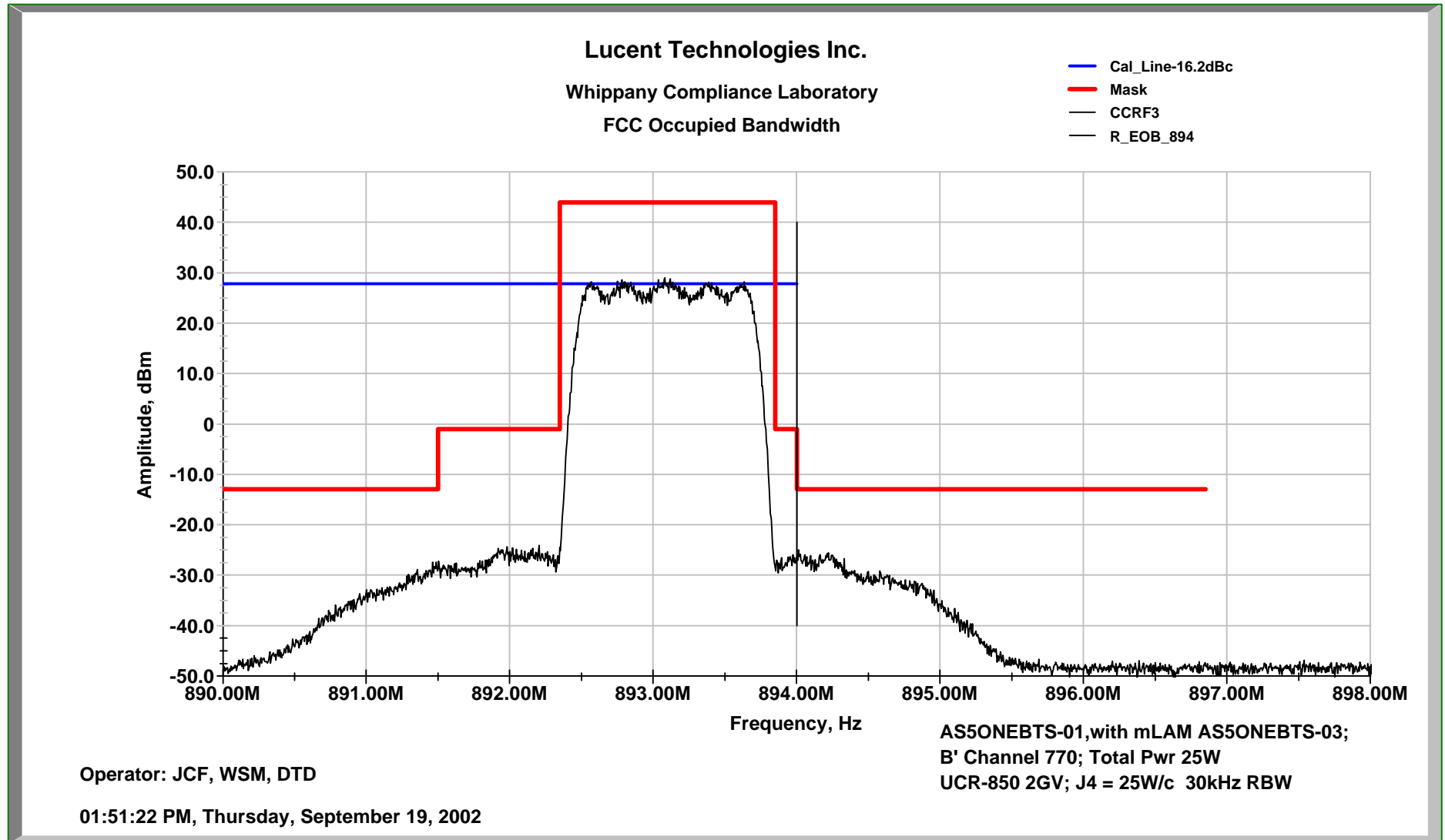

Exhibit 15: Measurement of Spurious Emissions at Antenna Terminals**Section 2.1051 Spurious Emissions at Antenna Terminals**

The **UCR-850** will typically be utilized with a FCC Product Certified Cellular power amplifier such as the **mLAM (AS5ONEBTS-03)** or **MLAC (AS5CMP-13)**. Data was collected for the **UCR-850** alone and for the typical case in the **FLEXENT OneBTS 4.0 Modular Cell** where the **UCR-850** is integrated with the **mLAM/ FCC ID: AS5ONEBTS-03**. The FCC Conducted Spurious emissions from the **UCR-850** integrated with the **mLAM FCC ID: AS5ONEBTS-03**, are compliant and within the parameters as previously filed with the FCC. The test methodology is described below and the test results are attached.

Spurious Emissions at the antenna terminals were investigated over the frequency range of 10 MHz to beyond the 10th harmonic of the carrier frequency. The RF output from the transmitter was reduced (to an amplitude usable by the spectrum analyzer) by using a attenuator calibrated over the 10 MHz-10GHz range. The RF power level was measured during setup and monitored continuously during the test via the test setup in Figure 15A.

Measurements were made using a Rohde & Schwarz FSEM Spectrum Analyzer, a PC based computer test controller, specialized RF components and a TILE™ software program to acquire the test data. This system allows measurement and presentation of the data in an accurate and compact form for FCC review. The volume of collected data is greater than 2×10^6 data points over the frequency range of 10 MHz to 10 GHz.

The use of a High-Pass Carrier reject filter allows for rapid and accurate acquisition of CDMA broadband spurious without desensitization or spurious generation by the carrier in the front end of the spectrum analyzer. The high pass filter and the entire RF test setup is calibrated as a unit over the frequency range.

The required emission limitation specified in Section 22.917(H) of the Code was applied to these tests. Based upon the criterion given in Section 22.917(H) of the Code the required out of band emission limit is equal to -56.98 dBc or -13 dBm. The -13 dBm limit holds for all signals when measured with the specified 30 kHz resolution bandwidth. The measurements of the spurious signals on the attached charts in this section were made using a minimum resolution bandwidth of 30 kHz and a step size appropriate to acquire all spurious emissions. The carrier signal shown on these plots is the sum of measurements at resolution Bandwidths of 120 kHz and 1 MHz. This was done so that the carrier plot correctly and accurately depicts the carrier output power in relation to the spurious signals and the defined limit. There were no adjustments made to any signals for resolution bandwidth.

The measurements of the spurious signals close to the carrier can also be evaluated in the Occupied Bandwidth plots, which were made using a resolution bandwidth of 30 kHz. Harmonics of the CDMA Carrier must be shown to be lower than -13 dBm as specified in 47CFR 22.917(H). The measurement of narrow-band spurious signals, such as clocks, oscillators and other pure tone types of signals are unchanged by variation of the analyzers resolution bandwidth. Per 47CFR 22.917(H) the -13 dBm limit is therefore appropriate for all narrowband or broadband signals.

Exhibit 15:continued

The applied signal met the recommended characteristics per IS-97-D section 6.5.2 as defined below.

Type	Number of Channels	Fraction of Power (Linear)	Fraction of Power (dB)	Comments
Pilot	1	0.2	-7	Code channel W_0^{128}
Sync	1	0.0471	-13.3	Code channel W_{32}^{64} ; always 1/8 rate
Paging	1	0.1882	-7.3	Code channel W_1^{64} ; full rate only
Traffic	6	0.09412	-10.3	Variable code channel assignments; full rate only

TABLE 15.1 Base Station Test Model, Nominal for Main Path

Type	Number of Channels	Fraction of Power (Linear)	Fraction of Power (dB)	Comments
Transmit Diversity Pilot	1	0.2	-7	Code channel W_{16}^{128}
Traffic	6	0.09412	-10.3	Variable code channel assignments; full rate only

TABLE 15.2 Base Station Test Model, Nominal for Transmit Diversity Path

Test Results Summary:

Measurements were performed while transmitting at the upper, lower, and middle channels of the cellular band. The attached spectral plots document the typical performance and shows that there are no emissions above the applicable limit of -13. dBm for harmonics and spurious. The attached data plots also document the results for the **UCR-850** integrated with an external power amplifier, **mLAM/ FCC ID: AS5ONEBTS-03**, for single, dual and three carrier test configurations.

Conducted Spurious tests on the Receiver antenna terminal documented compliance with the **2 nW requirement of 47CFR Part 15 section 15.**

Figure 12A/14A/15A Test Configuration For RF Power, Occupied Bandwidth and Conducted Spurious

Lucent FLEXENT® OneBTS
 Cellular CDMA 4.0 MODULAR CELL

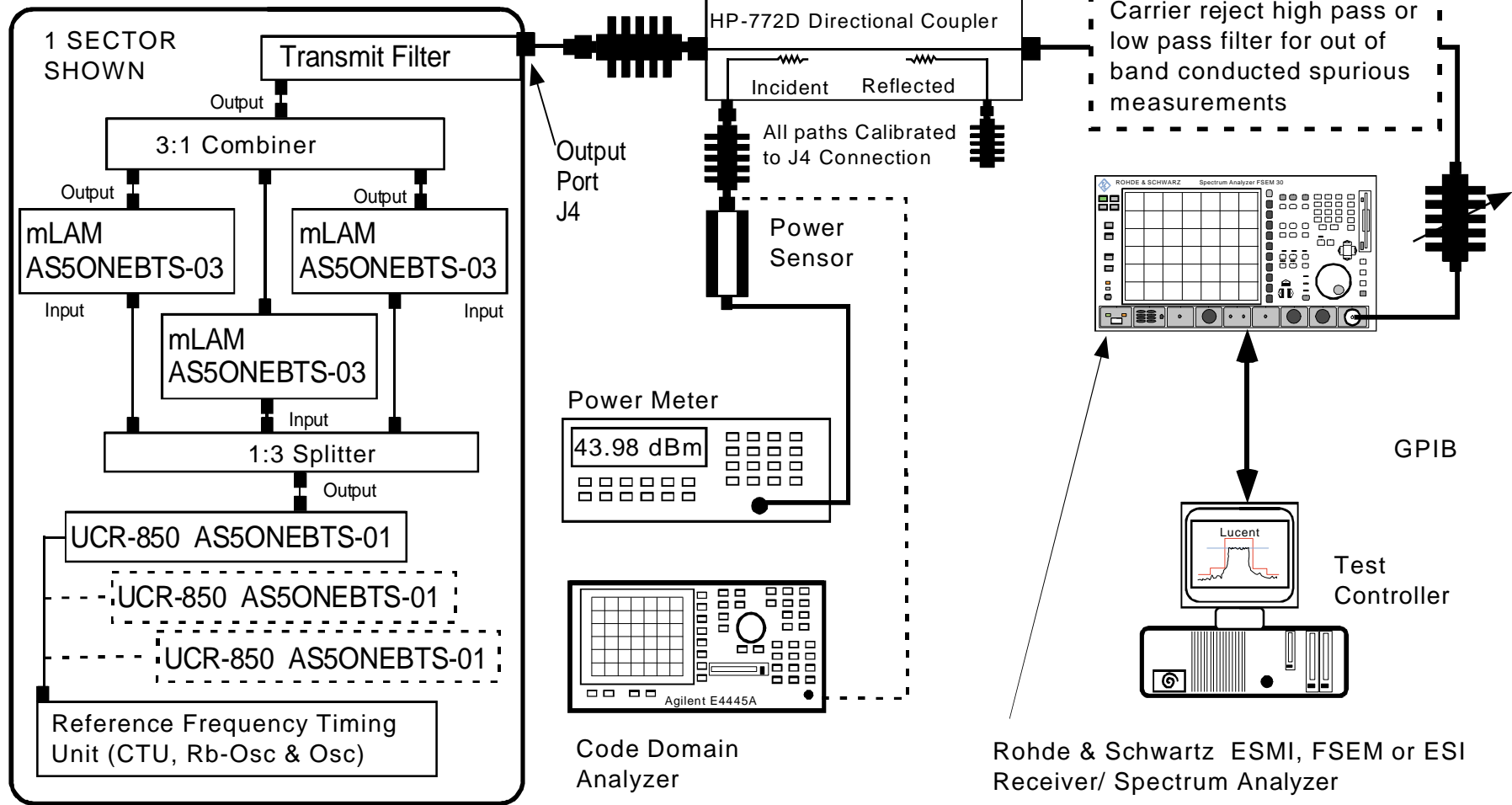

Cellular 850 4.0 Modular Cell UCR Test Figure
 WSM/DTD 7/29/02

Exhibit 15 continued

**FCC Conducted Spurious Data
at
Transmitter Output
for
Lucent Technologies Inc.
Cellular 850 ONEBTS Modular Cell 4.0
Incorporating
Cellular 850 UMTS CDMA Radio (UCR-850)
Filed under FCC ID: AS5ONEBTS-01
with
Cellular 850 Linear Amplifier Module, Model m
mLAM, FCC ID: AS5ONEBTS-03
Single, Dual and Three Carrier Configurations**

Exhibit 15 *continued*

Band A, Sub-Block A3, 1 Carrier Configuration 10 MHz -10GHz

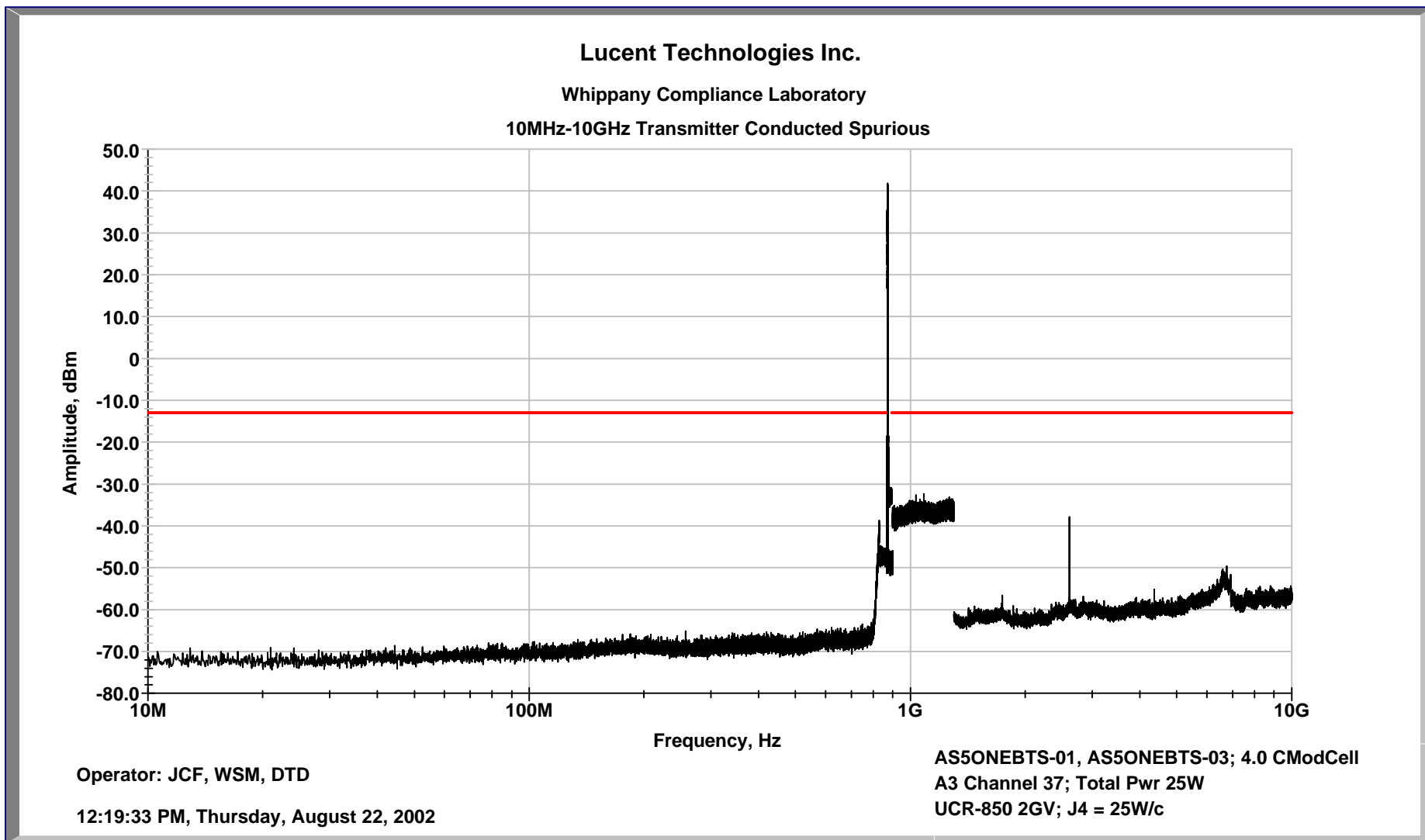

Exhibit 15 *continued*

Band B, Sub-Block B1, 1 Carrier Configuration 10 MHz -10GHz

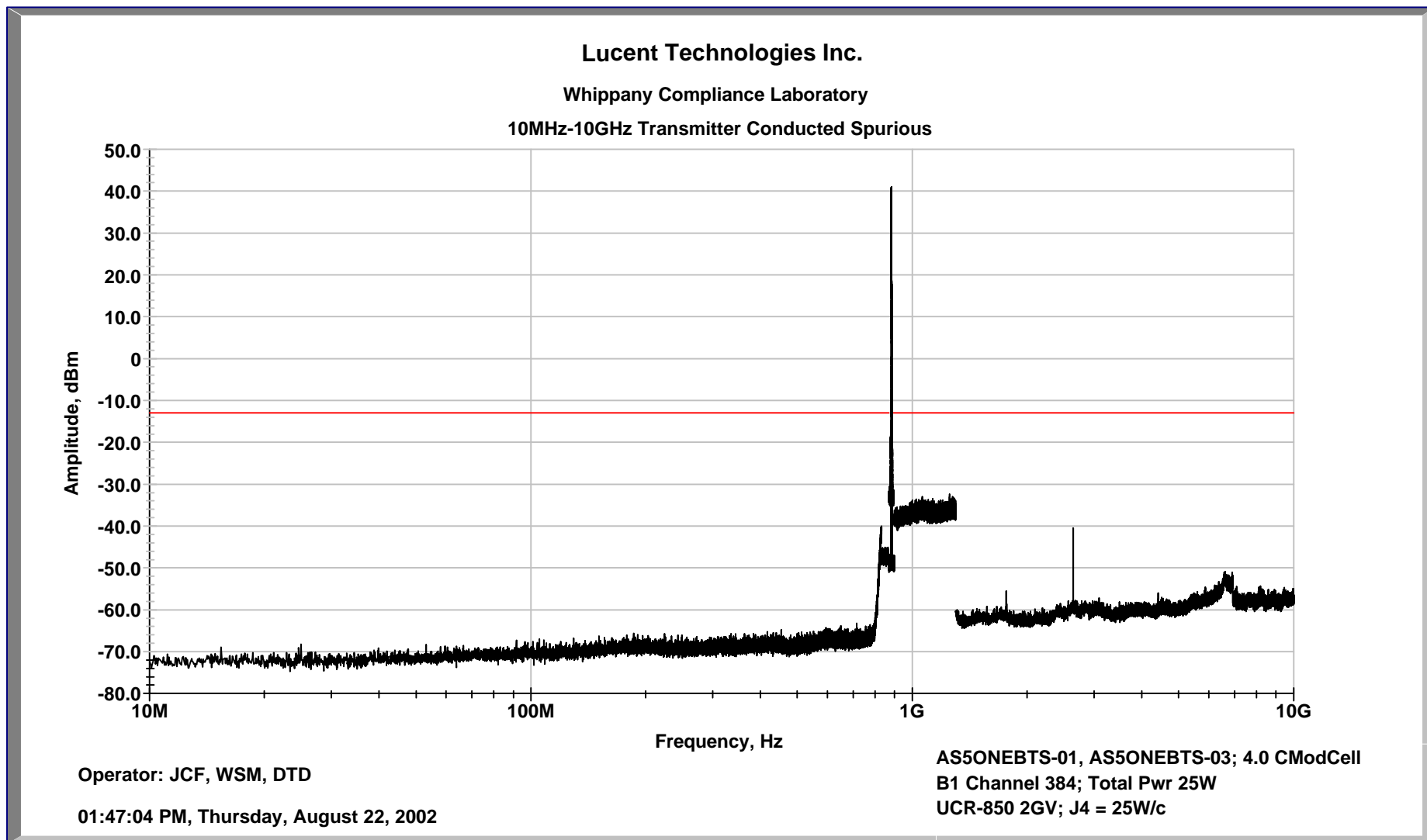

Exhibit 15 *continued*

Band B, Sub-Block B1, 2 Carrier Configuration 10 MHz -10GHz

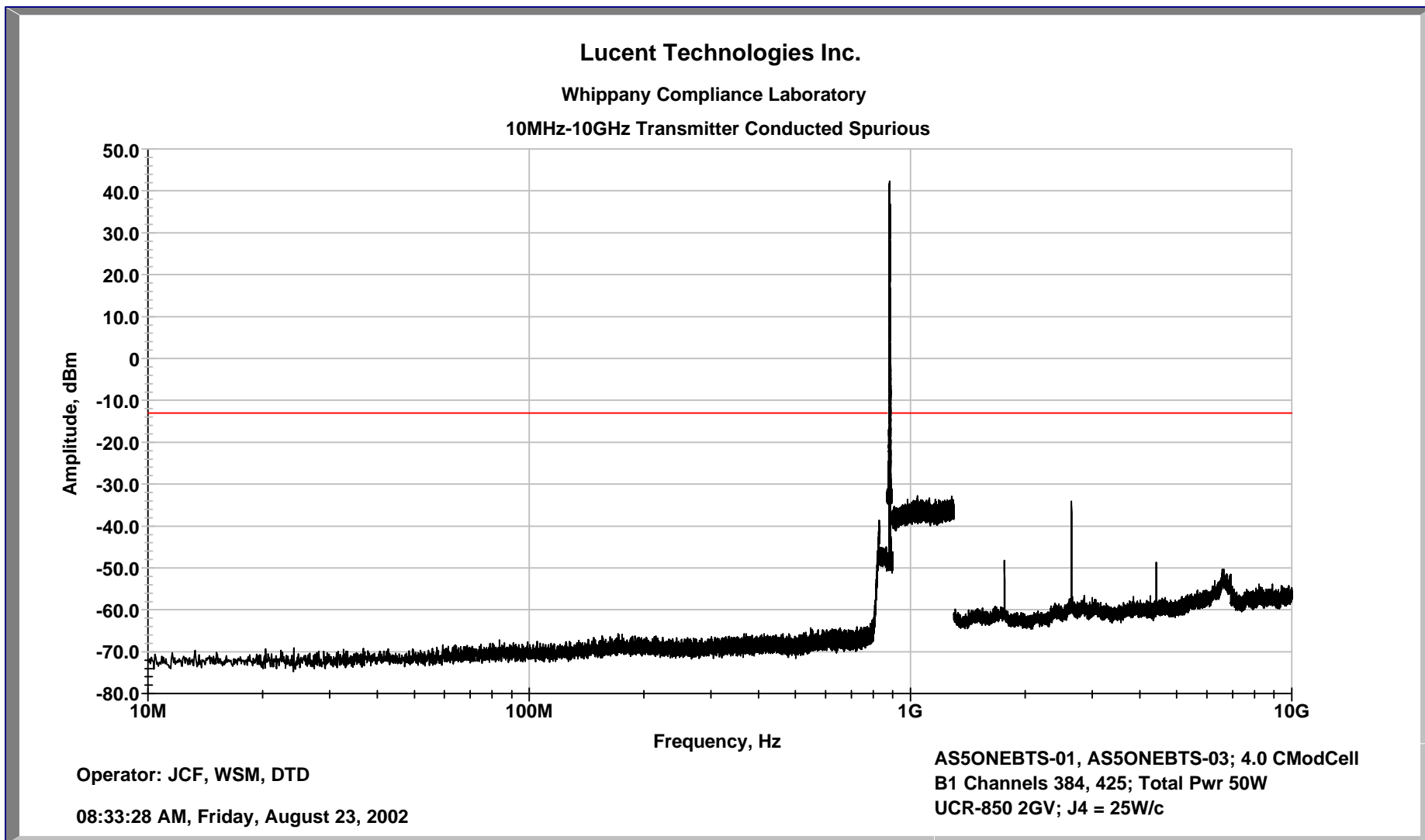

Exhibit 15 *continued*

Band B, Sub-Block B1, 3 Carrier Configuration 10 MHz -10GHz

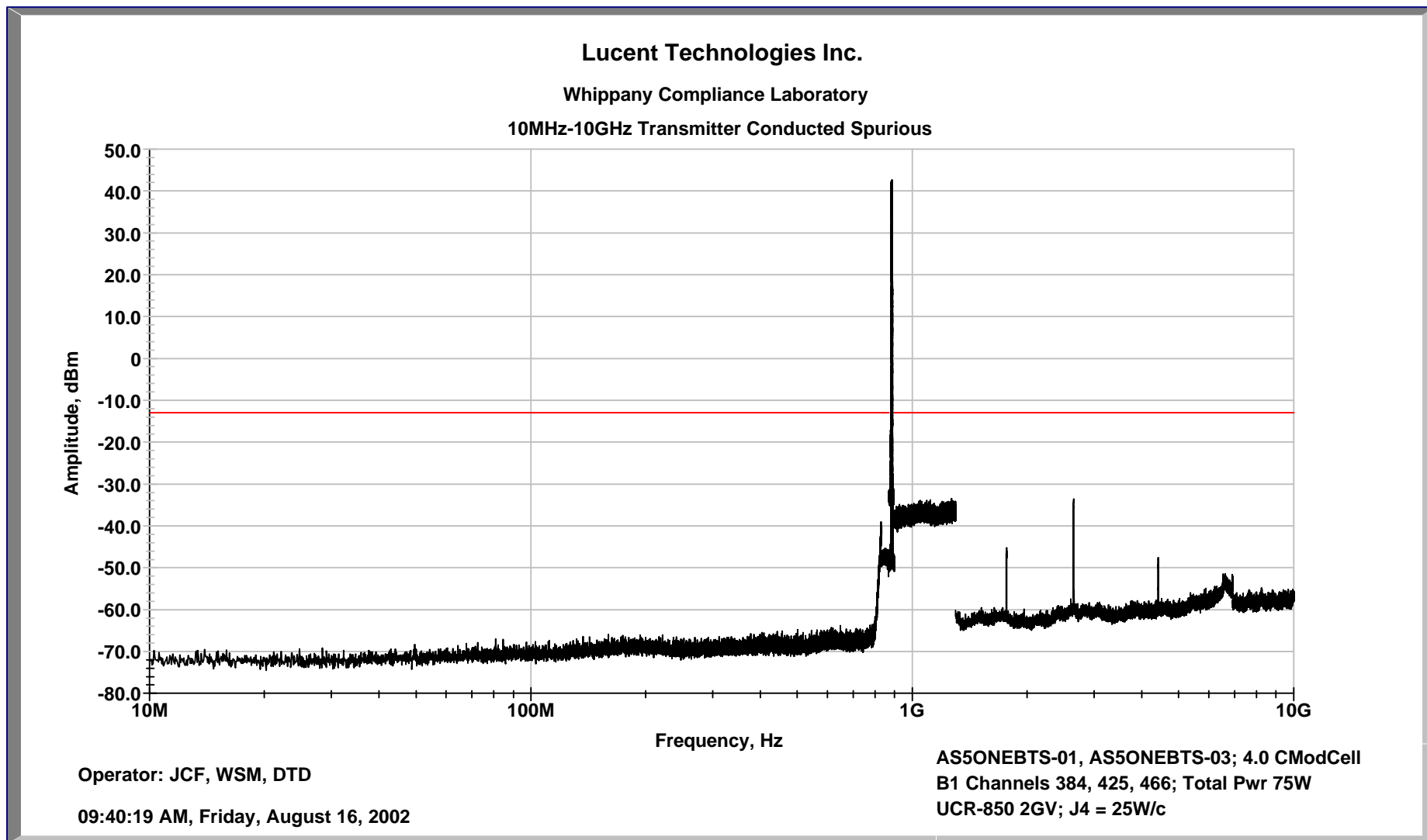

Exhibit 15 *continued*

Band B, Sub-Block B', 1 Carrier Configuration 10 MHz -10GHz

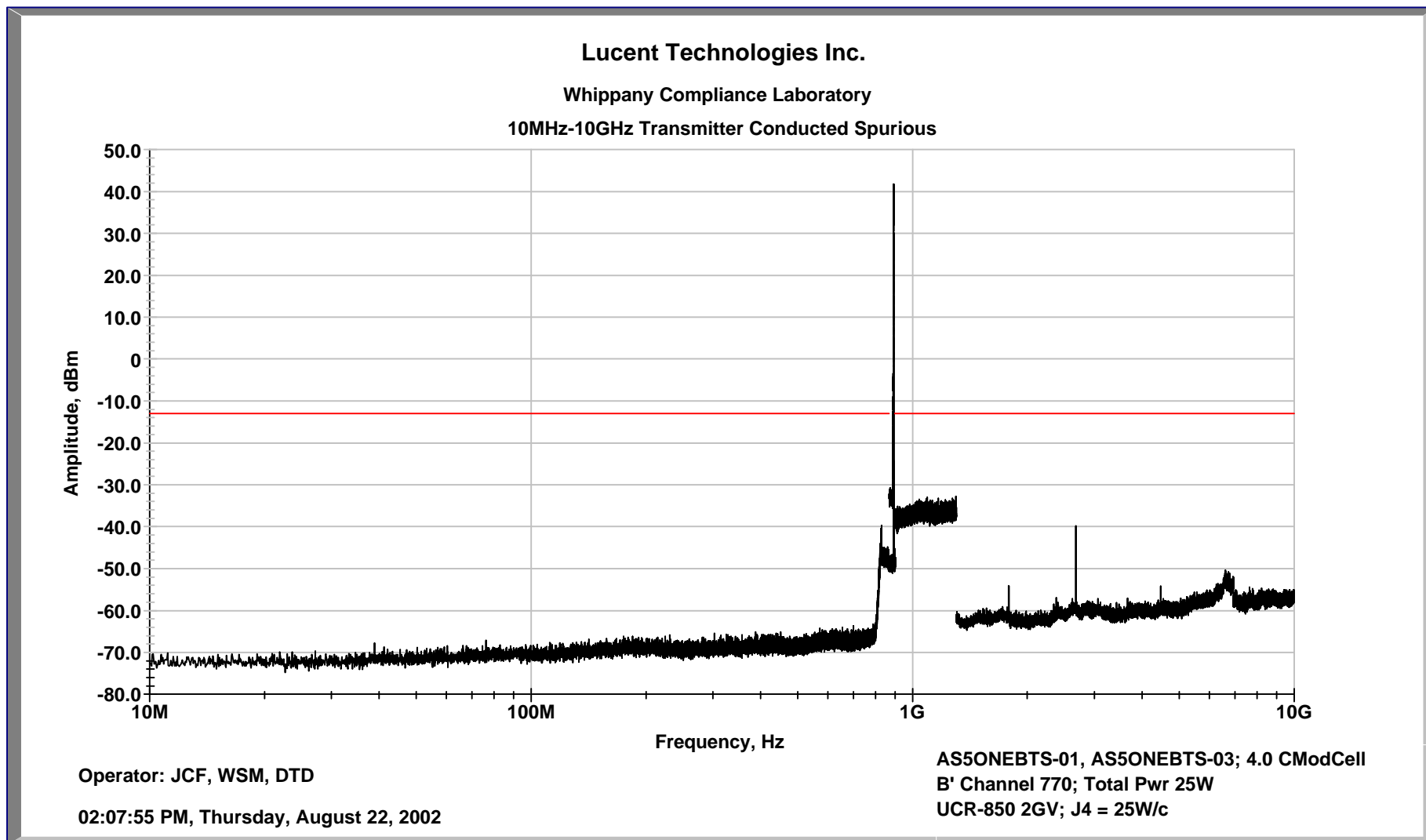

Exhibit 16: Measurement of Field Strength of Spurious Radiation

SECTION 2.1053 Measurement of Field Strength of Spurious Radiation

Field strength measurements of radiated spurious emissions were evaluated at a ten meter Open Air Test Site (OATS) and a 3 meter semi-Anechoic precompliance chamber maintained by Lucent Technologies Bell Laboratories Wireless Compliance Laboratory in Whippany, New Jersey. A complete description and full measurement data for the open air test site have been placed on file with the Commission.

Six UCR-850's FCC ID: AS5ONEBTS-01 were assembled with twelve mLAM's FCC ID: AS5ONEBTS-03 and all other associated equipment in a FLEXENT ® OneBTS Cellular 850 Modular Cell 4.0. The spectrum from 10 MHz to the tenth harmonic of the carrier (10 GHz) was searched for spurious radiation. Measurements were made using both horizontally and vertically polarized antennas. All emissions more than 20 dB below the specification limit are considered not reportable (Section 2.1053).

The calculated emission levels were found by:

$$P_{\text{measured}} \text{ (dBm)} + \text{Cable Loss(dB)} + \text{Antenna Factor(dB)} + 107 \text{ (dB}\mu\text{V/dBm)} - \text{Amplifier Gain (dB)} \\ = \text{Field Strength (dB}\mu\text{V/m)}$$

Section 22.917 and 2.1053 contains the requirements for the levels of spurious radiation as a function of the level of the unmodulated carrier. The reference level for the unmodulated carrier can be calculated from either a dipole antenna or an isotropic radiator. The isotropic radiator calculation is the more severe requirement and is used herein. The reference level for the unmodulated carrier is calculated as the field produced by an isotropic radiator excited by the transmitter output power according to the following relation taken from Reference Data for Radio Engineers, page 27-7, 6th edition, IT&T Corp.

$$P = P_t / 4\pi R^2 \quad \text{Watts/meter}^2$$

$$E = (120\pi P)^{1/2} = [(30 * P_t)^{1/2}] / R$$

$$20 \log (E * 10^6) - (43 + 10 \log P) = 71.77 \text{ dB } \mu\text{V/meter}$$

- Where:
- E = Field Intensity in Volts/ meter
 - P_t = Transmitted Power in watts = 25 W/ Carrier
 - P = Power density in Watts/meter²
 - R = Distance in meters = 10 m

RESULTS:

For this particular test, the field strength of any spurious radiation is required to be less than 71.8 dBμV/meter. Reportable measurements are equal to or greater than 51.8 dB μV/meter. Outside the transmit band of 869-894 MHz and over the spectrum investigated, 10 MHz to tenth harmonic of the carrier, no reportable spurious emissions were detected. This demonstrates that the **Cellular UMTS CDMA Radio (UCR-850)**, the subject of this application, complies with Sections 2.1053, 24.238 and 2.1057 of the Rules.

Additional testing to 47CFR Part 15 documented compliance with the Class B requirements.

Exhibit 17 Measurement of Frequency Stability**SECTION 2.995 Measurement of Frequency Stability**

The following frequency stability test data for the **UCR-850/ AS5ONEBTS-01** was measured as installed and tested, per Figure 17A, in a **FLEXENT ® OneBTS Cellular 850 Indoor Modular Cell 4.0**. The **Cellular 850 Indoor Modular Cell 4.0** was subjected to the FCC specified environments over its maximum allowable temperature range of -5 deg F to +50 deg F while operating at full rated power. When an outdoor version of the **Cellular 850 Modular Cell 4.0** is available the frequency stability data for the full FCC required range of -30 ~ +50 deg F will be reported to the FCC.

Software and hardware controls internal to the **Modular Cell 4.0** will disable the transmitter should either the internal temperatures exceed the maximum range or the frequency stability of the transmitter be compromised.

The frequency stabilization and accuracy of the CDMA signal amplified by the **mLAM** and measured at the **Cellular 850 Indoor Modular Cell 4.0** J4 connector is a function of the input signal from the **UCR-850 (FCC ID: AS5ONEBTS-01)**. The Common Timing Unit (**CTU**) provides the time and frequency reference used by the **UCR-850 (FCC ID: AS5ONEBTS-01)**. The **CTU** is a highly accurate time and frequency unit which relies upon a signal lock of GPS satellite signals to provide the primary discipline of system timing. In the event of loss of GPS lock the Rubidium Reference Oscillator (**OMU-RB**) or the Crystal Oscillator Module (**OMU-XO**) can provides up to eight hours of flywheel operation. The system provides for automatic timing synchronization upon reacquisition of GPS lock. The system is powered by an AC-DC power converter with battery backup to provide immunity to power fluctuations and failures.

RESULTS:

The measured data below is the FCC Frequency Stability Test Results for the UCR-850, FCC ID: AS5ONEBTS-01. The data was recorded at the **Cellular 850 Modular Cell 4.0** transmitter output (J4 connector) as required by Sec 2.1055 of the FCC Rules.

This system exceeds the frequency stability requirements necessary for **FLEXENT ® OneBTS** system compliance with FCC Rules for frequency stability. The **UCR-850** is compliant with **FCC Part 2 and 22 rules** when powered by and installed in a Lucent Technologies Inc. **FLEXENT ® OneBTS Cellular 850 Modular Cell 4.0**.

The data provided below documents that the maximum frequency deviation measured for the RF carrier frequency (882.75 MHz) at the transmit antenna port was +0.0039 ppm (3.47 Hz). The specification for FCC compliance is +/- 0.05 ppm (+/- 44.14 Hz). The maximum frequency deviation measured for the **OMU-RB** output (15MHz) was -0.00004 ppm (6×10^{-4} Hz). The specification for FCC compliance is +/- 0.05 ppm (+/-0.75 Hz).

The measured data is attached below.

Exhibit 17

Figure 17A. Test Configuration For Frequency Stability

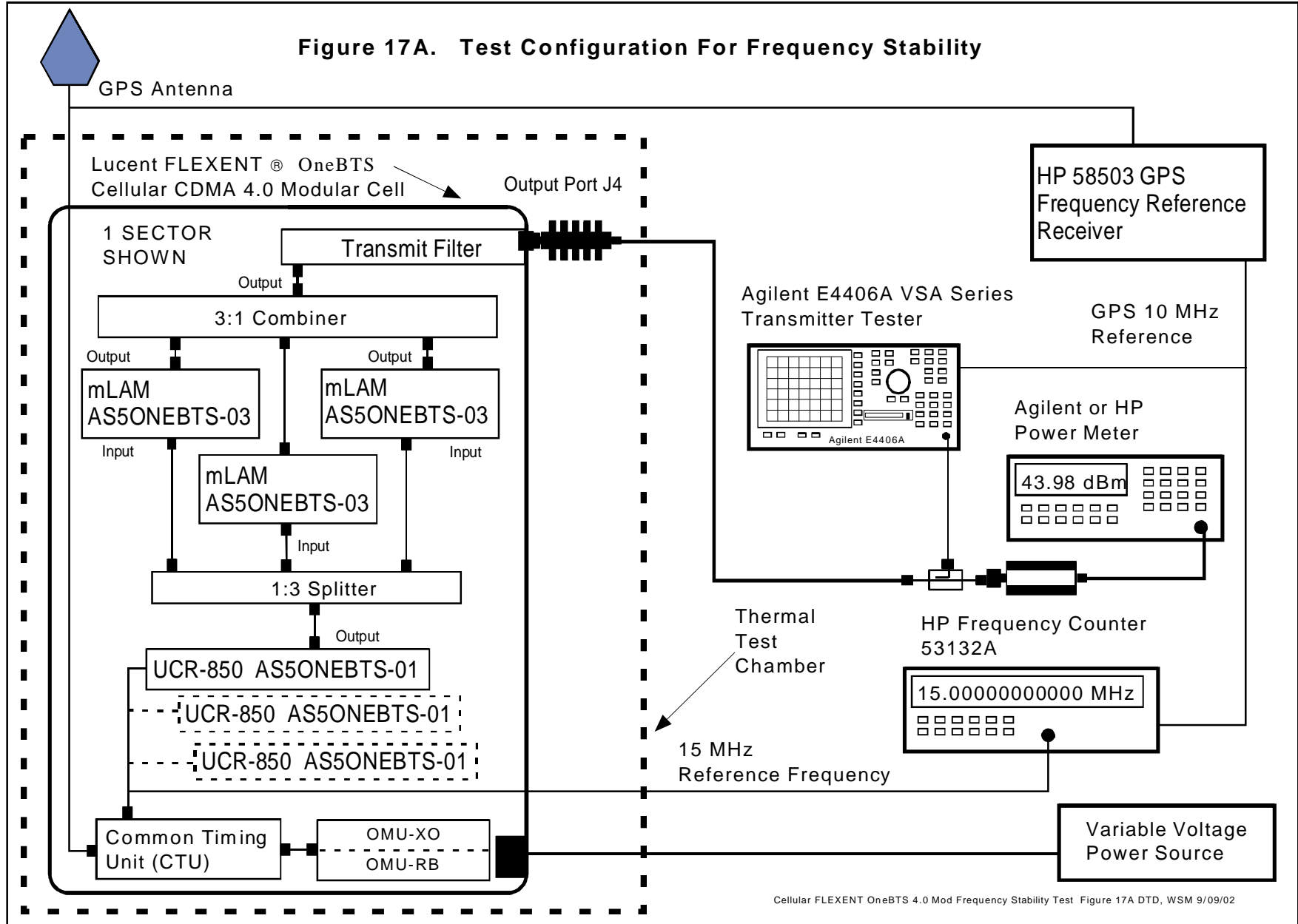

Cellular FLEXENT OneBTS 4.0 Mod Frequency Stability Test Figure 17A DTD, WSM 9/09/02

Cellular Block Tested: *BI, Cellular Channel 425, 882.75MHz*

Baseline Measurement at +20°C

Reference and Transmit Frequency Deviation From GPS at +20°C at 100% of Nominal Voltage, 24VDC		
Time (minutes)	15 MHz Deviation from GPS (x10 ⁻⁴ Hz)	Transmit Carrier Deviation (Hz)
0	-2	2.42
0.5	-1	1.37
1.0	-2	0.82
1.5	-2	-1.42
2.0	-1	0.97
2.5	-2	1.63
3.0	-3	-2.35
FCC SPECIFICATION	±15.0 MHz(±0.05 ppm) ±0.05ppm = ±0.75Hz	±882.75 MHz (±0.05ppm) ±0.05ppm = ±44.1Hz
FCC RESULT	PASS	PASS

Reference and Transmit Frequency Deviation From GPS at +20°C at 85% of Nominal Voltage, 20.4VDC		
Time (minutes)	15 MHz Deviation from GPS (x10 ⁻⁴ Hz)	Transmit Carrier Deviation (Hz)
0	2	1.87
0.5	-1	0.86
1.0	-1	-1.85
1.5	-1	2.23
2.0	2	1.65
2.5	-2	1.84
3.0	-1	-0.93
FCC SPECIFICATION	±15.0 MHz(±0.05 ppm) ±0.05ppm = ±0.75Hz	±882.75 MHz (±0.05ppm) ±0.05ppm = ±44.1Hz
FCC RESULT	PASS	PASS

Reference and Transmit Frequency Deviation From GPS at +20°C at 115% of Nominal Voltage, 27.6VDC		
Time (minutes)	15 MHz Deviation from GPS (x10 ⁻⁴ Hz)	Transmit Carrier Deviation (Hz)
0	0	-2.54
0.5	1	1.43
1.0	-2	1.82
1.5	1	-1.96
2.0	1	-1.52
2.5	-2	2.78
3.0	0	0.43
FCC SPECIFICATION	±15.0 MHz(±0.05 ppm) ±0.05ppm = ±0.75Hz	±882.75 MHz (±0.05ppm) ±0.05ppm = ±44.1Hz
FCC RESULT	PASS	PASS

Reference and Transmit Frequency Deviation From GPS at -5°C at 100% of Nominal Voltage, 24VDC		
Time (minutes)	15 MHz Deviation from GPS (x10 ⁻⁴ Hz)	Transmit Carrier Deviation (Hz)
0	-3	3.47
0.5	-1	2.56
1.0	-1	0.64
1.5	-2	1.87
2.0	-3	-1.42
2.5	-2	2.67
3.0	-3	-0.63
FCC SPECIFICATION	±15.0 MHz(±0.05 ppm) ±0.05ppm = ±0.75Hz	±882.75 MHz (±0.05ppm) ±0.05ppm = ±44.1Hz
FCC RESULT	PASS	PASS

Reference and Transmit Frequency Deviation From GPS at -5°C at 85% of Nominal Voltage, 20.4VDC		
Time (minutes)	15 MHz Deviation from GPS (x10 ⁻⁴ Hz)	Transmit Carrier Deviation (Hz)
0	-3	2.21
0.5	-2	0.62
1.0	-2	-1.52
1.5	-3	1.22
2.0	-1	0.93
2.5	-2	3.28
3.0	-3	1.47
FCC SPECIFICATION	±15.0 MHz(±0.05 ppm) ±0.05ppm = ±0.75Hz	±882.75 MHz (±0.05ppm) ±0.05ppm = ±44.1Hz
FCC RESULT	PASS	PASS

Reference and Transmit Frequency Deviation From GPS at -5°C at 115% of Nominal Voltage, 27.6VDC		
Time (minutes)	15 MHz Deviation from GPS (x10 ⁻⁴ Hz)	Transmit Carrier Deviation (Hz)
0	-1	0.44
0.5	-2	1.86
1.0	0	1.44
1.5	1	2.33
2.0	-1	1.68
2.5	2	0.72
3.0	0	-1.29
FCC SPECIFICATION	±15.0 MHz(±0.05 ppm) ±0.05ppm = ±0.75Hz	±882.75 MHz (±0.05ppm) ±0.05ppm = ±44.1Hz
FCC RESULT	PASS	PASS

Reference and Transmit Frequency Deviation From GPS at 0°C at 100% of Nominal Voltage, 24VDC		
Time (minutes)	15 MHz Deviation from GPS (x10 ⁻⁴ Hz)	Transmit Carrier Deviation (Hz)
0	6	1.82
0.5	4	-0.77
1.0	4	1.64
1.5	-3	0.66
2.0	4	-1.44
2.5	-3	1.65
3.0	-3	0.88
FCC SPECIFICATION	±15.0 MHz(±0.05 ppm) ±0.05ppm = ±0.75Hz	±882.75 MHz (±0.05ppm) ±0.05ppm = ±44.1Hz
FCC RESULT	PASS	PASS

Reference and Transmit Frequency Deviation From GPS at 0°C at 85% of Nominal Voltage, 20.4VDC		
Time (minutes)	15 MHz Deviation from GPS (x10 ⁻⁴ Hz)	Transmit Carrier Deviation (Hz)
0	4	2.11
0.5	4	1.45
1.0	3	1.52
1.5	4	0.87
2.0	3	1.86
2.5	3	2.36
3.0	3	0.56
FCC SPECIFICATION	±15.0 MHz(±0.05 ppm) ±0.05ppm = ±0.75Hz	±882.75 MHz (±0.05ppm) ±0.05ppm = ±44.1Hz
FCC RESULT	PASS	PASS

Reference and Transmit Frequency Deviation From GPS at 0°C at 115% of Nominal Voltage, 27.6VDC		
Time (minutes)	15 MHz Deviation from GPS (x10 ⁻⁴ Hz)	Transmit Carrier Deviation (Hz)
0	1	2.25
0.5	0	-1.53
1.0	2	-0.87
1.5	2	1.41
2.0	1	1.82
2.5	2	0.81
3.0	2	-0.96
FCC SPECIFICATION	±15.0 MHz(±0.05 ppm) ±0.05ppm = ±0.75Hz	±882.75 MHz (±0.05ppm) ±0.05ppm = ±44.1Hz
FCC RESULT	PASS	PASS

Reference and Transmit Frequency Deviation From GPS at +10°C at 100% of Nominal Voltage, 24VDC		
Time (minutes)	15 MHz Deviation from GPS (x10 ⁻⁴ Hz)	Transmit Carrier Deviation (Hz)
0	-4	0.47
0.5	-3	-1.17
1.0	-3	0.46
1.5	-4	1.77
2.0	-2	0.82
2.5	-3	-0.62
3.0	-3	-1.53
FCC SPECIFICATION	±15.0 MHz(±0.05 ppm) ±0.05ppm = ±0.75Hz	±882.75 MHz (±0.05ppm) ±0.05ppm = ±44.1Hz
FCC RESULT	PASS	PASS

Reference and Transmit Frequency Deviation From GPS at +10°C at 85% of Nominal Voltage, 20.4VDC		
Time (minutes)	15 MHz Deviation from GPS (x10 ⁻⁴ Hz)	Transmit Carrier Deviation (Hz)
0	-2	1.82
0.5	-2	1.12
1.0	-2	1.93
1.5	-3	0.67
2.0	-2	-1.22
2.5	-2	-1.87
3.0	-3	-1.53
FCC SPECIFICATION	±15.0 MHz(±0.05 ppm) ±0.05ppm = ±0.75Hz	±882.75 MHz (±0.05ppm) ±0.05ppm = ±44.1Hz
FCC RESULT	PASS	PASS

Reference and Transmit Frequency Deviation From GPS at +10°C at 115% of Nominal Voltage, 27.6VDC		
Time (minutes)	15 MHz Deviation from GPS (x10 ⁻⁴ Hz)	Transmit Carrier Deviation (Hz)
0	1	2.37
0.5	2	1.84
1.0	2	0.92
1.5	2	1.15
2.0	3	1.36
2.5	1	0.64
3.0	1	1.28
FCC SPECIFICATION	±15.0 MHz(±0.05 ppm) ±0.05ppm = ±0.75Hz	±882.75 MHz (±0.05ppm) ±0.05ppm = ±44.1Hz
FCC RESULT	PASS	PASS

Reference and Transmit Frequency Deviation From GPS at +20°C at 100% of Nominal Voltage, 24VDC		
Time (minutes)	15 MHz Deviation from GPS (x10 ⁻⁴ Hz)	Transmit Carrier Deviation (Hz)
0	1	0.63
0.5	0	1.74
1.0	-1	2.21
1.5	-1	1.59
2.0	-2	0.82
2.5	0	-0.43
3.0	-3	.1.62
FCC SPECIFICATION	±15.0 MHz(±0.05 ppm) ±0.05ppm = ±0.75Hz	±882.75 MHz (±0.05ppm) ±0.05ppm = ±44.1Hz
FCC RESULT	PASS	PASS

Reference and Transmit Frequency Deviation From GPS at +20°C at 85% of Nominal Voltage, 20.4VDC		
Time (minutes)	15 MHz Deviation from GPS (x10 ⁻⁴ Hz)	Transmit Carrier Deviation (Hz)
0	-1	-1.65
0.5	-1	-0.42
1.0	-1	1.24
1.5	-2	1.87
2.0	-2	1.32
2.5	-1	0.66
3.0	-2	-0.68
FCC SPECIFICATION	±15.0 MHz(±0.05 ppm) ±0.05ppm = ±0.75Hz	±882.75 MHz (±0.05ppm) ±0.05ppm = ±44.1Hz
FCC RESULT	PASS	PASS

Reference and Transmit Frequency Deviation From GPS at +20°C at 115% of Nominal Voltage, 27.6VDC		
Time (minutes)	15 MHz Deviation from GPS (x10 ⁻⁴ Hz)	Transmit Carrier Deviation (Hz)
0	1	-2.56
0.5	0	-1.95
1.0	1	-2.21
1.5	1	-1.22
2.0	-1	0.67
2.5	0	1.28
3.0	1	1.87
FCC SPECIFICATION	±15.0 MHz(±0.05 ppm) ±0.05ppm = ±0.75Hz	±882.75 MHz (±0.05ppm) ±0.05ppm = ±44.1Hz
FCC RESULT	PASS	PASS

Reference and Transmit Frequency Deviation From GPS at +30°C at 100% of Nominal Voltage, 24VDC		
Time (minutes)	15 MHz Deviation from GPS (x10 ⁻⁴ Hz)	Transmit Carrier Deviation (Hz)
0	3	1.87
0.5	3	0.63
1.0	4	1.15
1.5	3	2.78
2.0	4	3.12
2.5	2	2.55
3.0	3	1.17
FCC SPECIFICATION	±15.0 MHz(±0.05 ppm) ±0.05ppm = ±0.75Hz	±882.75 MHz (±0.05ppm) ±0.05ppm = ±44.1Hz
FCC RESULT	PASS	PASS

Reference and Transmit Frequency Deviation From GPS at +30°C at 85% of Nominal Voltage, 20.4VDC		
Time (minutes)	15 MHz Deviation from GPS (x10 ⁻⁴ Hz)	Transmit Carrier Deviation (Hz)
0	3	2.17
0.5	3	1.53
1.0	2	2.33
1.5	3	1.57
2.0	2	1.89
2.5	3	2.16
3.0	2	1.74
FCC SPECIFICATION	±15.0 MHz(±0.05 ppm) ±0.05ppm = ±0.75Hz	±882.75 MHz (±0.05ppm) ±0.05ppm = ±44.1Hz
FCC RESULT	PASS	PASS

Reference and Transmit Frequency Deviation From GPS at +30°C at 115% of Nominal Voltage, 27.6VDC		
Time (minutes)	15 MHz Deviation from GPS (x10 ⁻⁴ Hz)	Transmit Carrier Deviation (Hz)
0	1	1.47
0.5	1	1.95
1.0	0	1.25
1.5	1	0.67
2.0	1	1.86
2.5	0	2.25
3.0	1	1.73
FCC SPECIFICATION	±15.0 MHz(±0.05 ppm) ±0.05ppm = ±0.75Hz	±882.75 MHz (±0.05ppm) ±0.05ppm = ±44.1Hz
FCC RESULT	PASS	PASS

Reference and Transmit Frequency Deviation From GPS at +40°C at 100% of Nominal Voltage, 24VDC		
Time (minutes)	15 MHz Deviation from GPS (x10 ⁻⁴ Hz)	Transmit Carrier Deviation (Hz)
0	2	2.27
0.5	2	3.19
1.0	3	2.84
1.5	2	2.46
2.0	3	2.54
2.5	3	2.05
3.0	2	2.13
FCC SPECIFICATION	±15.0 MHz(±0.05 ppm) ±0.05ppm = ±0.75Hz	±882.75 MHz (±0.05ppm) ±0.05ppm = ±44.1Hz
FCC RESULT	PASS	PASS

Reference and Transmit Frequency Deviation From GPS at +40°C at 85% of Nominal Voltage, 20.4VDC		
Time (minutes)	15 MHz Deviation from GPS (x10 ⁻⁴ Hz)	Transmit Carrier Deviation (Hz)
0	4	2.49
0.5	4	2.17
1.0	5	1.84
1.5	4	2.63
2.0	5	2.18
2.5	3	2.68
3.0	4	1.75
FCC SPECIFICATION	±15.0 MHz(±0.05 ppm) ±0.05ppm = ±0.75Hz	±882.75 MHz (±0.05ppm) ±0.05ppm = ±44.1Hz
FCC RESULT	PASS	PASS

Reference and Transmit Frequency Deviation From GPS at +40°C at 115% of Nominal Voltage, 27.6VDC		
Time (minutes)	15 MHz Deviation from GPS (x10 ⁻⁴ Hz)	Transmit Carrier Deviation (Hz)
0	2	0.42
0.5	2	1.29
1.0	3	-0.87
1.5	2	-1.54
2.0	2	-2.44
2.5	3	-1.67
3.0	2	-0.98
FCC SPECIFICATION	±15.0 MHz(±0.05 ppm) ±0.05ppm = ±0.75Hz	±882.75 MHz (±0.05ppm) ±0.05ppm = ±44.1Hz
FCC RESULT	PASS	PASS

Reference and Transmit Frequency Deviation From GPS at +50°C at 100% of Nominal Voltage, 24VDC		
Time (minutes)	15 MHz Deviation from GPS (x10 ⁻⁴ Hz)	Transmit Carrier Deviation (Hz)
0	2	3.17
0.5	3	3.44
1.0	2	2.91
1.5	2	2.53
2.0	3	2.98
2.5	5	2.62
3.0	-3	2.57
FCC SPECIFICATION	±15.0 MHz(±0.05 ppm) ±0.05ppm = ±0.75Hz	±882.75 MHz (±0.05ppm) ±0.05ppm = ±44.1Hz
FCC RESULT	PASS	PASS

Reference and Transmit Frequency Deviation From GPS at +50°C at 85% of Nominal Voltage, 20.4VDC		
Time (minutes)	15 MHz Deviation from GPS (x10 ⁻⁴ Hz)	Transmit Carrier Deviation (Hz)
0	-2	2.44
0.5	-2	1.87
1.0	-2	1.55
1.5	-1	-2.30
2.0	-1	-1.57
2.5	0	-2.33
3.0	-2	1.46
FCC SPECIFICATION	±15.0 MHz(±0.05 ppm) ±0.05ppm = ±0.75Hz	±882.75 MHz (±0.05ppm) ±0.05ppm = ±44.1Hz
FCC RESULT	PASS	PASS

Reference and Transmit Frequency Deviation From GPS at +50°C at 115% of Nominal Voltage, 27.6VDC		
Time (minutes)	15 MHz Deviation from GPS (x10 ⁻⁴ Hz)	Transmit Carrier Deviation (Hz)
0	-3	-0.94
0.5	-3	1.18
1.0	-2	-1.26
1.5	0	-2.61
2.0	1	-1.87
2.5	2	-1.52
3.0	-1	-0.42
FCC SPECIFICATION	±15.0 MHz(±0.05 ppm) ±0.05ppm = ±0.75Hz	±882.75 MHz (±0.05ppm) ±0.05ppm = ±44.1Hz
FCC RESULT	PASS	PASS

Upon return to +20°C.

Reference and Transmit Frequency Deviation From GPS at +20°C at 100% of Nominal Voltage, 24VDC		
Time (minutes)	15 MHz Deviation from GPS (x10 ⁻⁴ Hz)	Transmit Carrier Deviation (Hz)
0	3	1.87
0.5	4	2.62
1.0	4	2.15
1.5	2	1.42
2.0	5	0.87
2.5	-3	-2.21
3.0	-4	-1.95
FCC SPECIFICATION	±15.0 MHz(±0.05 ppm) ±0.05ppm = ±0.75Hz	±882.75 MHz (±0.05ppm) ±0.05ppm = ±44.1Hz
FCC RESULT	PASS	PASS

Reference and Transmit Frequency Deviation From GPS at +20°C at 85% of Nominal Voltage, 20.4VDC		
Time (minutes)	15 MHz Deviation from GPS (x10 ⁻⁴ Hz)	Transmit Carrier Deviation (Hz)
0	3	2.33
0.5	3	2.14
1.0	3	1.66
1.5	2	-0.42
2.0	2	-1.53
2.5	-2	0.78
3.0	-3	1.86
FCC SPECIFICATION	±15.0 MHz(±0.05 ppm) ±0.05ppm = ±0.75Hz	±882.75 MHz (±0.05ppm) ±0.05ppm = ±44.1Hz
FCC RESULT	PASS	PASS

Reference and Transmit Frequency Deviation From GPS at +20°C at 115% of Nominal Voltage, 27.6VDC		
Time (minutes)	15 MHz Deviation from GPS (x10 ⁻⁴ Hz)	Transmit Carrier Deviation (Hz)
0	2	0.47
0.5	4	1.58
1.0	3	-1.27
1.5	3	-2.15
2.0	-4	-0.85
2.5	3	1.82
3.0	2	0.83
FCC SPECIFICATION	±15.0 MHz(±0.05 ppm) ±0.05ppm = ±0.75Hz	±882.75 MHz (±0.05ppm) ±0.05ppm = ±44.1Hz
FCC RESULT	PASS	PASS