

Lucent Technologies
Bell Labs Innovations



**Global Product Compliance Laboratory
Specific Absorption Rate (SAR) Test Report
9631A Pocket Phone**

November 18, 1998

Prepared by:

Lucent Technologies
Global Product Compliance Laboratory
101 Crawford's Corner Road
PO Box 3030
Holmdel, NJ 07733-3030

Client:

Joel Emmanuel
Lucent Technologies
101 Crawford's Corner Road,
Holmdel, NJ 07733

Prepared by:

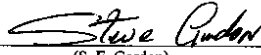

(S. E. Gordon)
GPCL Compliance Engineer

Date:

11/18/98

Reviewed by:

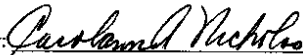

(C. A. Nicholas)
GPCL SAR Reviewer

Date:

11-18-98

Lucent Technologies Global Product Compliance Laboratory represents to the client that testing was done in accordance with standard procedures as applicable and that reported test results are accurate within generally accepted commercial ranges of accuracy. Lucent Technologies Global Product Compliance reports only apply to the specific samples tested. This report is the property of the client. This report shall not be reproduced except in full without the written approval of the Lucent Technologies Global Product Compliance Laboratory

Lucent Technologies Global Product Compliance Laboratory at Holmdel is recognized under the US Department of Commerce National Institute of Standards and Technology's National Voluntary Laboratory Accreditation Program (NVLAP) for satisfactory compliance with criteria established in Title 15, Part 7 Code of Federal Regulations for offering test services for selected test methods in Electromagnetic Compatibility; Voluntary Control Council for Interference (VCCI), Japan; Australian Communications Authority (ACA); Norges Elektriske Materiekkontroll (NEMKO), Norwegian Board for Testing and Approval of Electrical Equipment. The laboratory is ISO 9002:1994 Certified.

Lucent Technologies Global Product Compliance Laboratory is an accredited test facility recognized by ITI, a competent body in the United Kingdom, and by NMI (formerly AKZO EMC Services), a competent body in the Netherlands.

TABLE OF CONTENTS

TABLE OF CONTENTS 2

SAR COMPLIANCE TEST REPORT 3

ENGINEER'S REPORT 4

 1.1 INTRODUCTION 4

 1.2 COMPLIANCE STATEMENT 4

 1.3 EQUIPMENT UNDER TEST (EUT) INFORMATION 4

 1.4 ELECTRICAL MODES OF OPERATION 5

 1.5 SAR TEST INFORMATION AND SUMMARY 6

 1.6 TEST PROCEDURES 6

 1.7 SAR TEST PROCEDURE 6

 1.8 TWIN PHANTOM INFORMATION 6

 1.9 E-FIELD PROBE 7

 1.10 MOUNTING DEVICE 8

 1.11 ABSORBER-LINED SHIELDED CHAMBER 8

 1.12 SAR DETERMINATION 8

 1.13 DATA ACQUISITION AND ANALYSIS 9

 1.14 DATA EVALUATION AND VISUALIZATION 10

PRODUCT EQUIPMENT LIST 11

CUSTOMER PROVIDED AUXILLARY EQUIPMENT 11

SAR SPECIAL TEST CONSIDERATIONS 12

SAR TEST SUMMARY SHEET 13

SAR DATA 14

PHOTOGRAPH(S) (COPY) OF EUT ARRANGEMENT DURING SAR TEST 39

TEST EQUIPMENT CALIBRATION LIST 44

BRAIN TISSUE SIMULATING LIQUID DATA 45

SYSTEM DIAGRAM 46

SYSTEM UNCERTAINTY DATA 47

DOSIMETRIC ASSESSMENT SYSTEM CALIBRATION DATA 48

SYSTEM VALIDATION DATA/DIPOLE VALIDATION KIT 54

PROBE CALIBRATION DATA 63

KEMA ISO 9002 CERTIFICATE 72

NVLAP CERTIFICATE 73

SAR COMPLIANCE TEST REPORT

Equipment Under Test (EUT): 9631A Pocket Phone
Model Number: 9631A

Serial Number: H4.10

Company: Lucent Technologies
101 Crawfords Corner Road
Holmdel, NJ 07733

Manufacturer: Lucent Technologies
101 Crawfords Corner Road
Holmdel, NJ 07733

Measurement Procedure: ANSI / IEEE C95.1 (1991)

Test Requirements: FCC Rule Section 2.1091 and 2.1093

Date Received: 11/06/98

Test Date(s): 11/09/98, 11/10/98

TEST PERFORMED BY : Lucent Technologies
Bell Labs Innovations
Global Product Compliance Laboratory
101 Crawfords Corner Road
Holmdel, New Jersey 07733-3030 (USA)
(732) 332-6000, Fax (732) 332-5997

Lucent Technologies , Global Product Compliance Laboratories is recognized under the National Voluntary Laboratory Accreditation Program (NVLAP[®]) for satisfactory compliance with the criteria established in Title 15, Part 285 Code of Federal Regulations. These criteria encompass the requirements of ISO/IEC Guide 25 and the relevant requirements of ISO 9002 as suppliers of calibration or test results.

NVLAP LAB CODE: 100275-0
Product Engineer(s): Joel Emanuele

TEST RESULTS:

The 9631A Pocket Phone as tested did meet the Specific Absorption Rate test requirements of the above listed specifications. The maximum Specific Absorption Rate was (0.0223) mW/g over any 1g tissue.

Please note that the manufacturer or party responsible must also follow the Code Of Federal Regulations 47 requirements for supplying the appropriate Labeling Information and/or Information to the user.

ENGINEER'S REPORT

1.1 INTRODUCTION

Specific Absorption Rate (SAR) measurements were performed on the **9631A Pocket Phone**, hereinafter referred to as the EUT. Testing was performed at the Lucent Technologies, Global Product Compliance Laboratory, (GPCL) located in Holmdel, New Jersey.

1.2 COMPLIANCE STATEMENT

This is to certify that the **9631A Pocket Phone** complies with the FCC Rule section 2.1091 and 2.1093, based on the test data obtained by using DASY2 dosimetric assessment system, ET3DV4 3D E-field probe and twin phantom for dosimetric measurements commercially available from Schmid & Partner Engineering AG (SPEAG), Switzerland.

<u>Frequency (MHz)</u>	<u>Test Data (mW/g)</u>	<u>Limits (mW/g)</u>	<u>Margin (mW/g)</u>
1924.375	0.0223	1.6	1.5777

The test was limited to the use of the simulated human head phantom filled with the appropriate brain tissue simulation solution so that the spatial peak SAR on the hands, wrists, feet, ankles and the whole-body cannot be performed. However, based on our current knowledge and experience, simulated hands in place will only reduce the SAR measurement. The averaged SAR over the whole human body is extremely small (much less 0.08 W/kg) for the personal mobile stations as the stronger RF exposure is concentrated in the area around the phone antenna connection.

1.3 EQUIPMENT UNDER TEST (EUT) INFORMATION

The **9631A Pocket Phone** is a pocket size, portable phone that provides wireless mobility as well as access to full business features and many DEFINITY ECS features. The functionality of the phone is similar to that of the DWBS 9601 Pocket phone.

The **9631A Pocket Phone** provides either two or three call appearances and a four-line by 16 character liquid crystal display (LCD) plus a row of icons indicating the following: message waiting, signal strength, lock, vibrator, battery, silent, mute, and next.

The **9631A Pocket Phone** contains the following hard keys (buttons) on the keypad: On/Off, Redial, Menu, Next, Silent, Conf, and Hold; it also contains a mute button on the side. In addition, the phone contains a dial pad and four soft key buttons.

The **9631A Pocket Phone** is not physically connected by a cord to the DEFINITY ECS or any other DWBS component. Instead, the phone is wireless and communicates via a radio link to a network of Wireless Fixed Bases (WFBs), which in turn connect the phone to the DEFINITY ECS. The **9631A Pocket Phone** is designed to be compatible with existing and future releases of the DWBS.

1.4 ELECTRICAL MODES OF OPERATION

The 9631A Pocket Phone was powered by a Nickel-Metal Hydride Rechargeable battery supplied by the customer. For testing purposes, the EUT was transmitting in the Normal Operating Mode. The EUT has an output power of 19.6 dBm. To set transmission frequency, depress any of the 0 thru 7 keys.

System Frequency	Frequency (MHz)	Depress Keys
F0	1929.375	0
F1	1928.125	1
F2	1926.875	2
F3	1925.625	3
F4	1924.375	4
F5	1923.125	5
F6	1921.875	6
F7	1920.625	7

The 9631A Pocket Phone has two antennas, position 0 and position 1. The EUT is tested to comply with SAR for both antenna positions.

1.5 SAR TEST INFORMATION AND SUMMARY

SAR measurements were performed in an absorber-lined shielded chamber at the Global Product Compliance Laboratory in Holmdel, New Jersey. A summary of the SAR measurement results and test information is presented in the SAR Test Summary Sheet.

1.6 TEST PROCEDURES

All tests were performed in accordance with the following procedures:

ANSI/IEEE C95.1(1991) entitled: "IEEE Standard for Safety Levels with Respect to Human Exposure to Radio Frequency Electromagnetic Fields, 3 kHz to 300 GHz", American National Standards Institute, Institute of Electrical and Electronic Engineers, Inc., New York, NY 10017-2394, USA.

1.7 SAR TEST PROCEDURE

SAR tests were performed in an appropriate absorber lined shielded test chamber. Prior to the SAR tests being performed, the brain tissue simulating liquid is calibrated to determine if the conductivity and relative dielectricity is in tolerance with the specifications. Prior to the test, a systems calibration is performed to validate the system. For testing, the EUT is configured, installed, arranged, and operated in a manner that is most representative of the equipment as typically used. The DASY software is used to systematically scan, locate the maximum SAR position and record the measurement.

A coarse scan is performed over the inside surface of the entire phantom within the defined border. When the coarse scan is finished, the location of the interpolated maximum is provided by the system. A cubic scan is performed over the peak area. The spatial peak SAR results - value for 1 and 10 grams is evaluated after the cube measurements have been done

1.8 TWIN PHANTOM INFORMATION

The twin phantom is designed for left and right-hand users. The shape of the head in the ear region is 16 X 15 cm. The phantom shell is made from fiberglass with a thickness of 2 ± 0.2 mm, the ear was simulated by adding a spacer on the shell to obtain the 10% thickness of the ear between the tissue simulating liquid and the mouthpiece of the phone. Since the precise placement of the device with respect to the phantom is very critical, a special positioning device has been constructed by SPEAG, which enables the rotation of the MTE by $\pm 180^\circ$ around the axis of the auditory canal and from 75° to 105° with respect to the axis normal to the axis of the auditory canal.

1.9 E-FIELD PROBE

One of the most critical component of the dosimetric assessment system is the E-field probe. The probe requirements are:

- High sensitivity and linear response over a broad frequency range, High spatial resolution,
- Isotropy in different media,
- Low interaction with the measuring field, and
- Small in size

For optimal performance of SAR measurement in liquids with high permittivity, Schmid & Partner Engineering AG designed and developed the triangular E-Field probe. The probe has a smaller outline and is installed a surface detector in the center of the probe. The triangular design is very compact to ensure a high spatial resolution. The distance between the probe tip and the dipole center is 2.7 mm. This distance between the dipole centers is less than 2 mm. The surface detection unit enables the probe tip reach the phantom surface at 1mm distance with the accuracy +/- 0.2 mm.

Each probe consists of three small dipoles (3mm) directly loaded with a Schottky diode and connected with high resistive lines to the data acquisition unit. The theory of this type of probe has been discussed in various publications, such as *Electric Field Probes - A Review*, IEEE Trans. Antennas Propagation, vol. 31, no. 5, pp. 710-718, Sept 1983 by H. I. Bassen and G.S. Smith.

There are several possible secondary modes of reception in the probe. One is produced by normal mode signals coupled into the resistive lines and rectified in the diode. Another mode is produced by common mode signals coupled into the lines and converted at the diode into normal mode signals by asymmetrical loading of the dipole halves due to constructional asymmetries. These mode signals are reduced by introducing a distributed filter between the dipole and the resistive lines in the probe, ET3DV4 by Schmid & Partner Engineering AG. Also the high degree of constructional symmetry improves the efficiency of the filter for secondary reception modes. The thick film technique is used for the construction of the dipole and lines on the probe. This permits the use of lines with different sheet resistance on the same substrate, and the production of much higher sheet resistance than the thin film technique.

Any dielectric material around electric dipoles have an effect on the local signal strength. It's been verified by Schmid & Partner Engineering AG that the triangular probe has better isotropy in the solutions which simulate the electric properties of tissues with high water content. Although proved to be unusable in air, all the SAR measurement tests are performed in the tissue simulation solution. The maximum error introduced by the lack of isotropy is much less than the deviation of +/- 0.6 dB in the solution.

The disturbance caused by the probe in homogeneous fields depends on the probe material/geometry and the field itself. This problem is corrected by measuring the SAR at different distances from the surface and extrapolating the SAR values to the surface. The extrapolation procedure is also necessary because of the separation of the dipole center from the probe tip.

1.10 MOUNTING DEVICE

Since the precise positioning of the EUT with respect to the phantom is very critical, a special positioning device is used with the following properties:

The EUT can easily be mounted in such a way that the ear-piece is positioned precisely over the auditory canal opening of the shell phantom with a repeatability for horizontal positioning of ± 1 mm. The holder enables the rotation of the EUT by $\pm 180^\circ$ around the axis of the auditory canal and from 65° up to 105° with respect to the axis normal to the axis of the auditory canal. The positioning device has been constructed such that the EUTs are held from the side, similar to how the human hand holds the EUT. This will ensure that any future designs can also be properly mounted.

The total measurement uncertainty of the DASY2 system from SPEAG for the spatial peak SAR values of less than 20% (rss value of the worst-case errors). The detail error analysis is given in the paper, *Dosimetric Evaluation of Handheld Mobile Communications Equipment with Known Precision* by Niels Kuster, Ralph Kastle and Thomas Schmid, IEICE Transactions on Communications Vol. E80-B, No 5 May 1997.

1.11 ABSORBER-LINED SHIELDED CHAMBER

The Absorber-Lined Shielded Chamber is a steel constructed 12 foot wide x 12 foot long x 12 foot high shielded chamber with inner surfaces lined with pyramidal absorber along the walls and ceiling. Finger-stock gasketing is placed along the edge of the door to provide a good bond between the chamber and the door. The floor is constructed of specially reinforced absorber made of fiberglass-foam laminate material. RF Line Filters are installed to the outer walls with the line coming through pipe nipples into the room to remove RF ambients on the power input lines. These filters are encased in shielded electrical enclosures.

1.12 SAR DETERMINATION

The SAR can be determined by measuring the total RMS electric field (E_{tot} in the unit V / m) at a point inside the exposed tissue

$$\text{SAR} = E_{\text{tot}}^2 \sigma / \rho$$

where σ is the conductivity (S / m) and ρ is the density (kg / m^3) of the tissue at the site of measurement.

The SAR distribution is determined by measuring the electric field with miniaturized E-field probes. Measurements are performed in the shell phantom filled with tissue simulating solution. As we know, different head and body simulating shell phantom and different phone positions as of the shape of the phantom may give different SAR measurement results. The simplified body and head phantom designed by Schmid & Partner Engineering AG was used in all the SAR tests.

The SAR calculation formula can be rewritten as

$$\text{SAR} = E_{\text{tot}}^2 \sigma / 1000\rho = E_{\text{tot}}^2 \sigma / 1000$$

where E_{tot} is the total field strength in V / m, σ is the conductivity in Siemens (mho) and ρ is the density (kg / m^3) of the tissue at the site of measurement. The density is normally set to 1 to account for the actual brain density rather than the density of the simulation solution.

1.13 DATA ACQUISITION AND ANALYSIS

The improved probe characteristics are obtained by the improved signal amplifier. The probes have source impedance of 5 to 8 M Ω due to the high resistive lines and the decoupling filters. The rectified signals range from 1 μV to 200 mV. Signal noise is reduced by using separated battery power data acquisition unit and connected with fiber-optic links to the main data evaluation system.

The data acquisition system is semi-automatic. Data acquisition, surface detection, robot control, administration of all calibration parameters of the system, evaluation and visualization of the measured data are performed by the DASY2 V2.3d software.

The robot which controls the movement of the probe is completely controlled by the software and its movements can be monitored on the screen. Several measuring options allow users completely measure in user defined coarse volumes or planes. After the coarse measurement, the probe can then be moved to the maximum SAR area and performed pre-defined fine grid volume SAR measurement. The filtered raw data is stored in data files together with all the calibration parameters. The data can be interpolated and extrapolated to find the maximum SAR value.

The data acquisition system takes 2600 complete field measurements per second for 3-D probes. The program reads and filters the incoming data during the measuring or surface detection cycle. Depending on the received signal strength, the program switches the gain of the amplifier unit and launches calibration cycles accordingly. The program calculates an accuracy estimate of the filtered signal and stops the measuring cycle upon reaching the desired accuracy. The measuring time per grid point varies with the desired accuracy and the received signal-to-noise ratio.

Because of the low cutoff frequency the system can not follow pulsed HF signals, but provides an average value of the rectified signal. As long as the signal strength stays within the square law range of the detector diode, the reading is the average of the absorbed power. If the peak signal strength is higher, the compression of the diode is compensated by the software depending on the duty cycle parameter. The system then calculates the peak power, compensates for the diode compression and gives the new average value. The formula for each channel can be given as:

$$V_i = U_i + U_i^2 \times (dc / 2 \text{ DCP})$$

where V_i is the compensated signal of channel x, y or z., U_i is the input signal of channel x, y or z, dc is the duty cycle of the RF field (DASY2 system parameter), DCP is the diode compression point in microvolts (DASY2 system parameter). From the compensated input signals the primary field data for each channel is evaluated as follows,

$$E_i = (V_i / (\text{Norm}_i \times \text{ConvF}))^{1/2}$$

where E_i is the measured channel electric field strength in V/m of channel x, y or z, V_i is the compensated signal of channel x, y or z, $Norm_i$ is the sensor sensitivity of channel x, y or z in $\mu V/(V/m)^2$, $ConvF$ is the sensitivity enhancement in solution. The total field strength can be calculated by taking the RMS value of the channel field components.

$$E_{tot} = (E_x^2 + E_y^2 + E_z^2)^{1/2}$$

1.14 DATA EVALUATION and VISUALIZATION

The program evaluates the raw data with the calibration parameters and can produce a two-dimensional or three-dimensional output with interpolated isolines. SAR values can be numerically integrated over 1 g or 10 g of simulated tissue.

$$SAR_{1g} \approx \int_{1g \text{ Cubic}} SAR \, dVol \approx 1/1000 \times \sum_{1000} SAR$$

A thorough error analysis made by Eidgenössische Technische Hochschule (ETH) shows that the measurement uncertainty of DASY2 system is less than 20% for the spatial peak SAR values. The long term stability and the proper functioning of the system is ensured by means of an easy-to-use validation kit, which has a reproducibility of better than 5%.

The algorithm that finds the maximal averaged volume is divided into three stages,

First, the data between the dipole center of the probe and the surface of the phantom is extrapolated. This data can not be measured, since the center of the dipoles is 2.7 mm away from the tip of the probe and the distance between the surface and the lowest measuring pint is 1mm. The extrapolated data from a cube measurement can be visualized in graphics.

Then, the maximal interpolated value is searched with a straight-forward algorithm. Around this maximum the SAR - values averaged over the spatial volumes (1 or 10 g) are computed using the 3d-spline interpolation algorithm. If the volume can not be evaluated (i.e., if a part of the grid was cut off by the boundary of the measurement area) the evaluation will be started on the corners of the bottom plane of the cube.

Thirdly, all neighboring volumes are evaluated until no neighboring volume with a higher average value is found.

Extrapolation is based on the least square. Through the points in one z-axis a polynomial of order four is calculated. This polynomial is then used to evaluate the points between the surface and the probe tip. The points, calculated from the surface, have a distance of 1mm from one another.

Interpolation of the points is done with a 3d-spline. The 3d-spline is composed of three one-dimensional splines with the "Not a knot"-condition.

For volume averaging, the size of the cube is first calculated. The volume is integrated with the trapezoidal algorithm. 1000 points (10x10x10) are interpolated to calculate the average.

PRODUCT EQUIPMENT LIST

List of all equipment associated with test including peripherals	Serial Number	FCC ID Number	Sample type prototype (P) tool-made (T) production (M)
9631A Pocket Phone	H4.10	N/A	P

Footnote: Customer assumes responsibility for verification and operation of all equipment.

CUSTOMER PROVIDED AUXILLARY EQUIPMENT

List of all equipment associated with test including peripherals	Serial Number	FCC ID Number
None	None	None

Footnote: Customer assumes responsibility for verification and operation of all equipment.

SAR SPECIAL TEST CONSIDERATIONS

This page discusses any special test procedures or considerations.

- There were no special test considerations.
- The following special considerations occurred during the test.

SPECIFIC NOTES:

MITIGATION APPLIED TO EUT TO ATTAIN COMPLIANCE:

- No mitigation required for compliance.
- The following mitigation was applied to obtain compliance:

SAR TEST SUMMARY SHEET

Official Name of the EUT: 9631A Pocket Phone	Serial Number: H4.10
Test Date: 11/9/98 - 11/10/98	Test facility used: SAR Room
Operating Frequency: 1920.625 -1929.375 MHz	
EUT Ambient Temperature: 27°C	EUT Relative Humidity: 39%
Product Engineer: Joel Emanuele	EMC Engineer: S. E. Gordon

Phantom Side	Frequency MHz	Antenna Position	Reading (mW/g) over 1g tissue	Limit (mW/g) over 1g tissue	Margin mW/g
Left	1920.625	1	0.0194	1.6	1.5806
Left	1920.625	0	0.0189	1.6	1.5811
Left	1924.375	1	0.0142	1.6	1.5858
Left	1924.375	0	0.0195	1.6	1.5805
Left	1929.375	1	0.0140	1.6	1.5860
Left	1929.375	0	0.0182	1.6	1.5818
Right	1920.625	1	0.0220	1.6	1.5780
Right	1920.625	0	0.0155	1.6	1.5845
Right	1924.375	1	0.0223	1.6	1.5777
Right	1924.375	0	0.0199	1.6	1.5801
Right	1929.375	1	0.0187	1.6	1.5813
Right	1929.375	0	0.0167	1.6	1.5833

Complete SAR profile for all configurations are provided as the data plots on the following pages.

SAR DATA

9631 Handset, F=1929.375 MHz, Antenna=0, RightSide, 11/10/98.MEA

$\sigma = 1.77$ [mho/m] $\epsilon_r = 41.2$ $\rho = 1.00$ [g/cm³]

Coarse Grid DX = 15.0 Dy = 15.0 Dz = 0.0 [mm]

SAR [mW/g] Max: 0.02

Max at (96.00, 73.50, 4.00)

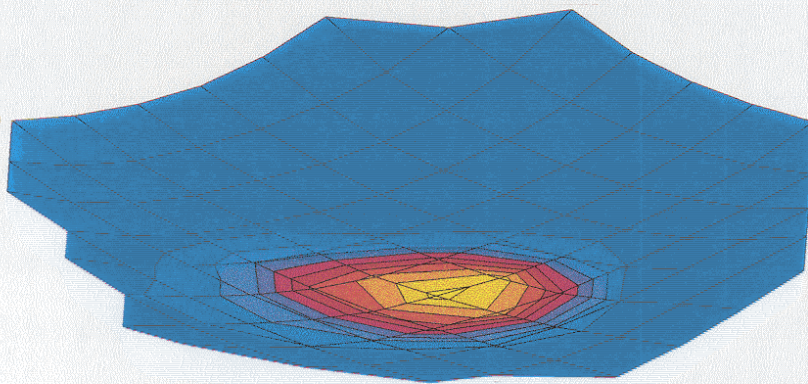

SAR [mW/g]

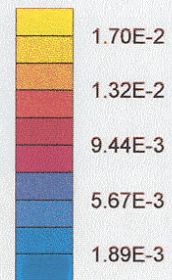

9631 Handset, F=1929.375 MHz, Antenna=0, RightSide, 11/10/98.MEA

$\sigma = 1.77$ [mho/m] $\epsilon_r = 41.2$ $\rho = 1.00$ [g/cm³]

Cube 5x5x7 Dx = 8.0 Dy = 8.0 Dz = 5.0 [mm]

SAR [mW/g] Max: 0.03

SAR (1g): 0.0167 [mW/g] SAR (10g): 0.0094 [mW/g]

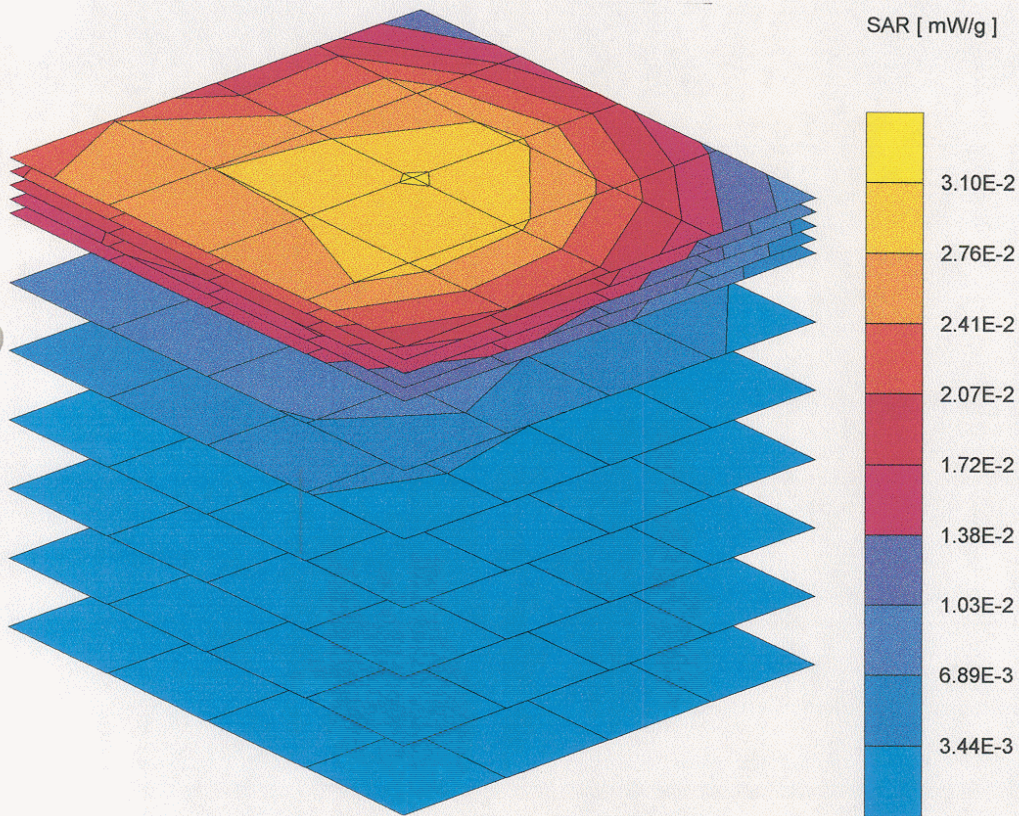

9631 Handset, F=1929.375 MHz, Antenna=1, RightSide, 11/10/98.MEA

$\sigma = 1.77$ [mho/m] $\epsilon_r = 41.2$ $\rho = 1.00$ [g/cm³]

Coarse Grid $\Delta x = 15.0$ $\Delta y = 15.0$ $\Delta z = 0.0$ [mm]

SAR [mW/g] Max: 0.02

Max at (91.50,93.00,4.00)

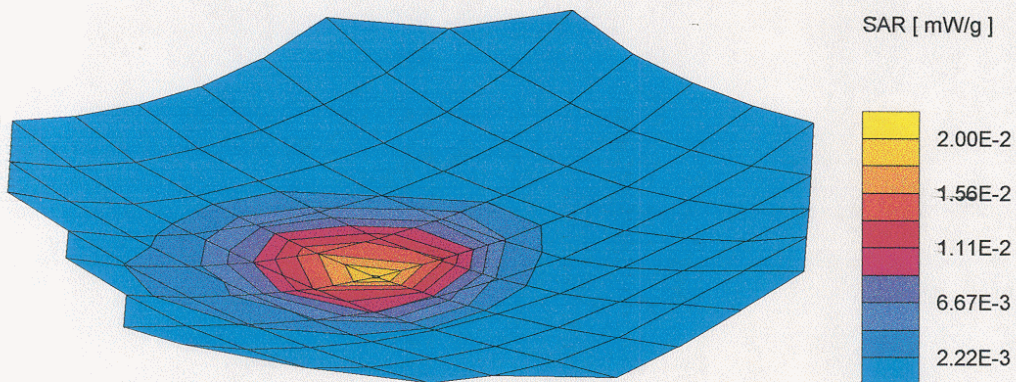

9631 Handset, F=1929.375 MHz, Antenna=1, RightSide, 11/10/98.MEA

$\sigma = 1.77$ [mho/m] $\epsilon_r = 41.2$ $\rho = 1.00$ [g/cm³]

Cube 5x5x7 DX = 8.0 DY = 8.0 DZ = 5.0 [mm]

SAR [mW/g] Max: 0.03

SAR (1g): 0.0187 [mW/g] SAR (10g): 0.0102 [mW/g]

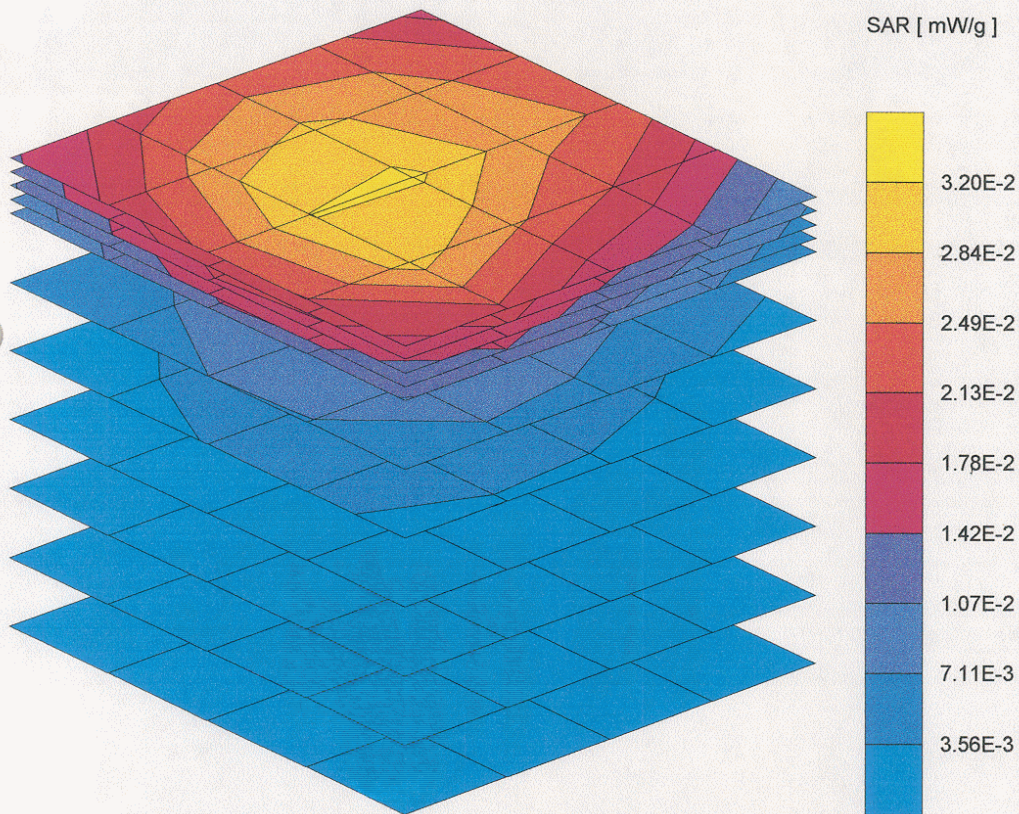

9631 Handset, F=1924.375 MHz, Antenna=1, RightSide, 11/10/98.MEA

$\sigma = 1.77$ [mho/m] $\epsilon_r = 41.2$ $\rho = 1.00$ [g/cm³]

Coarse Grid DX = 15.0 Dy = 15.0 Dz = 0.0 [mm]

SAR [mW/g] Max: 0.02

Max at (90.00, 93.00, 4.00)

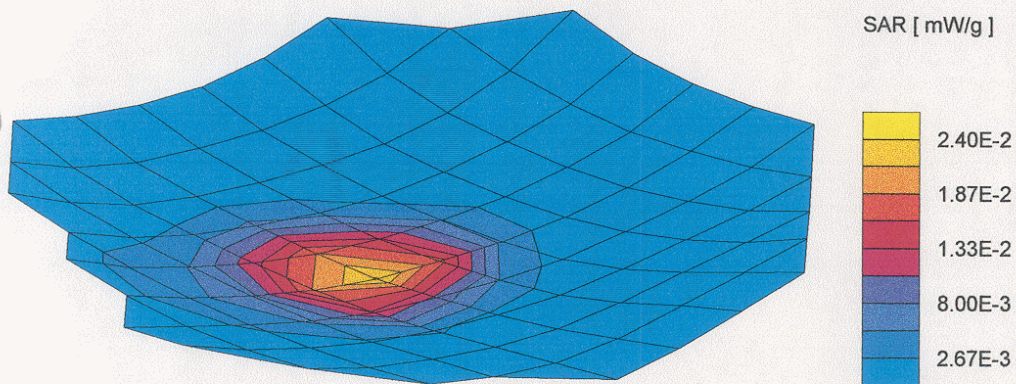

9631 Handset, F=1924.375 MHz, Antenna=1, RightSide, 11/10/98.MEA

$\sigma = 1.77$ [mho/m] $\epsilon_r = 41.2$ $\rho = 1.00$ [g/cm³]

Cube 5x5x7 Dx = 8.0 Dy = 8.0 Dz = 5.0 [mm]

SAR [mW/g] Max: 0.04

SAR (1g): 0.0223 [mW/g] SAR (10g): 0.0124 [mW/g]

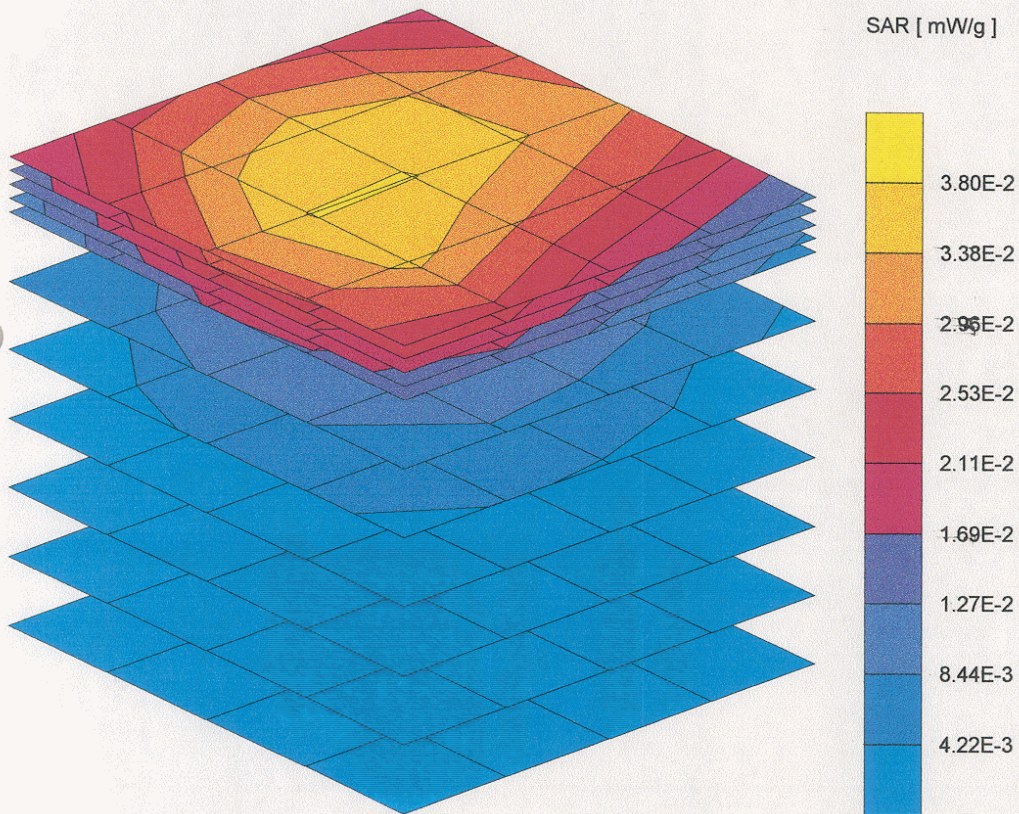

9631 Handset, F=1924.375 MHz, Antenna=0, RightSide, 11/10/98.MEA

$\sigma = 1.77$ [mho/m] $\epsilon_r = 41.2$ $\rho = 1.00$ [g/cm³]

Coarse Grid Dx = 15.0 Dy = 15.0 Dz = 0.0 [mm]

SAR [mW/g] Max: 0.02

Max at (88.50, 73.50, 4.00)

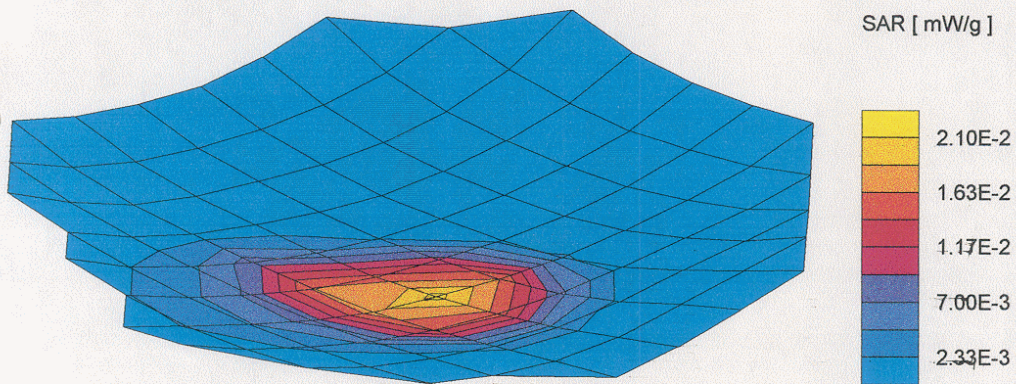

9631 Handset, F=1924.375 MHz, Antenna=0, RightSide, 11/10/98.MEA

$\sigma = 1.77$ [mho/m] $\epsilon_r = 41.2$ $\rho = 1.00$ [g/cm³]

Cube 5x5x7 DX = 8.0 DY = 8.0 DZ = 5.0 [mm]

SAR [mW/g] Max: 0.04

SAR (1g): 0.0199 [mW/g] SAR (10g): 0.0112 [mW/g]

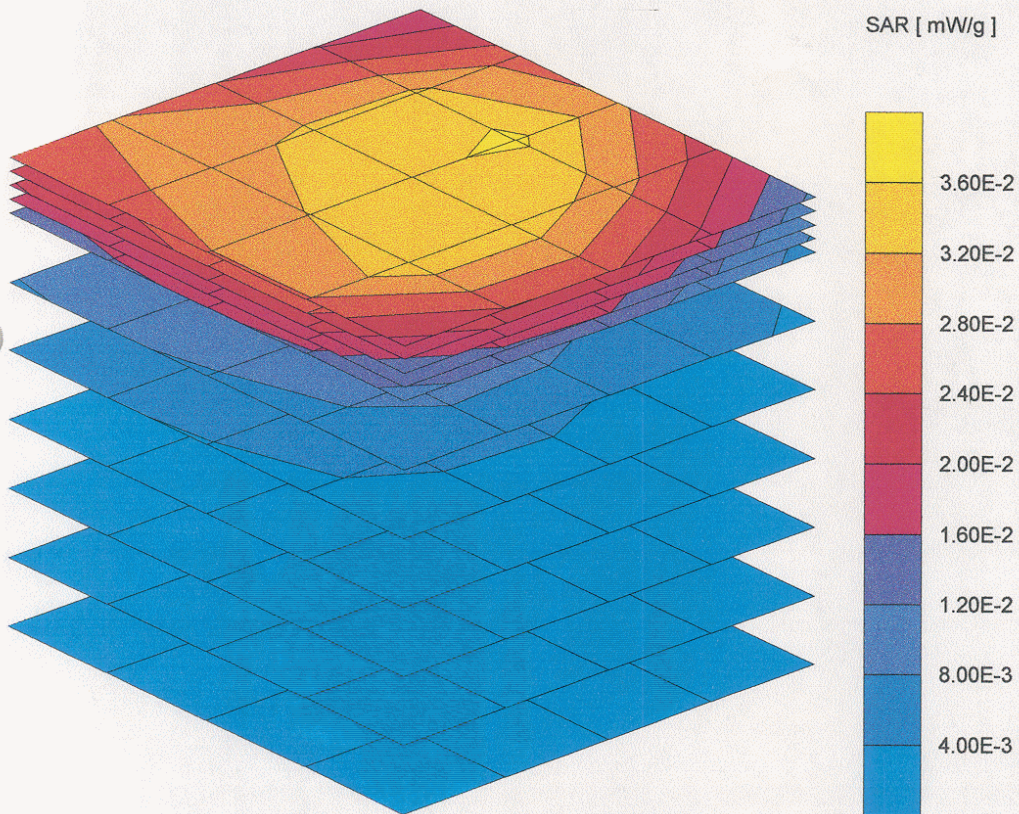

9631 Handset, F=1920.625 MHz, Antenna=0, RightSide, 11/10/98.MEA

$\sigma = 1.77$ [mho/m] $\epsilon_r = 41.2$ $\rho = 1.00$ [g/cm³]

Coarse Grid DX = 15.0 Dy = 15.0 Dz = 0.0 [mm]

SAR [mW/g] Max: 0.02

Max at (91.50, 79.50, 4.00)

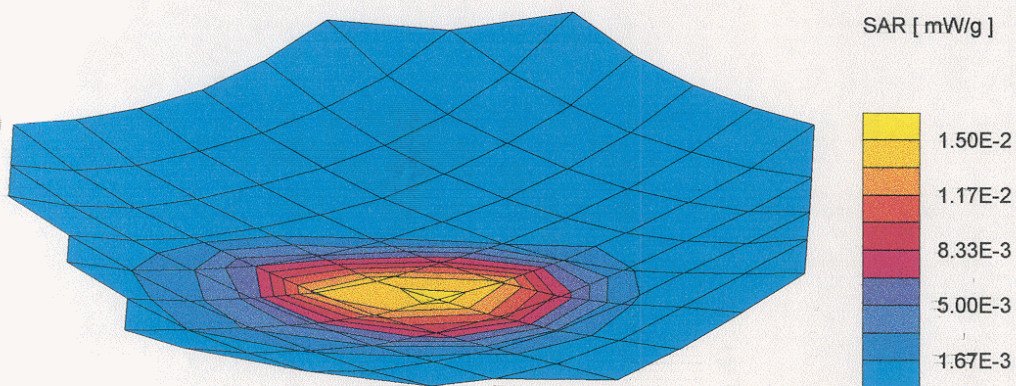

9631 Handset, F=1920.625 MHz, Antenna=0, RightSide, 11/10/98.MEA

$\sigma = 1.77$ [mho/m] $\epsilon_r = 41.2$ $\rho = 1.00$ [g/cm³]

Cube 5x5x7 $D_x = 8.0$ $D_y = 8.0$ $D_z = 5.0$ [mm]

SAR [mW/g] Max: 0.03

SAR (1g): 0.0155 [mW/g] SAR (10g): 0.0087 [mW/g]

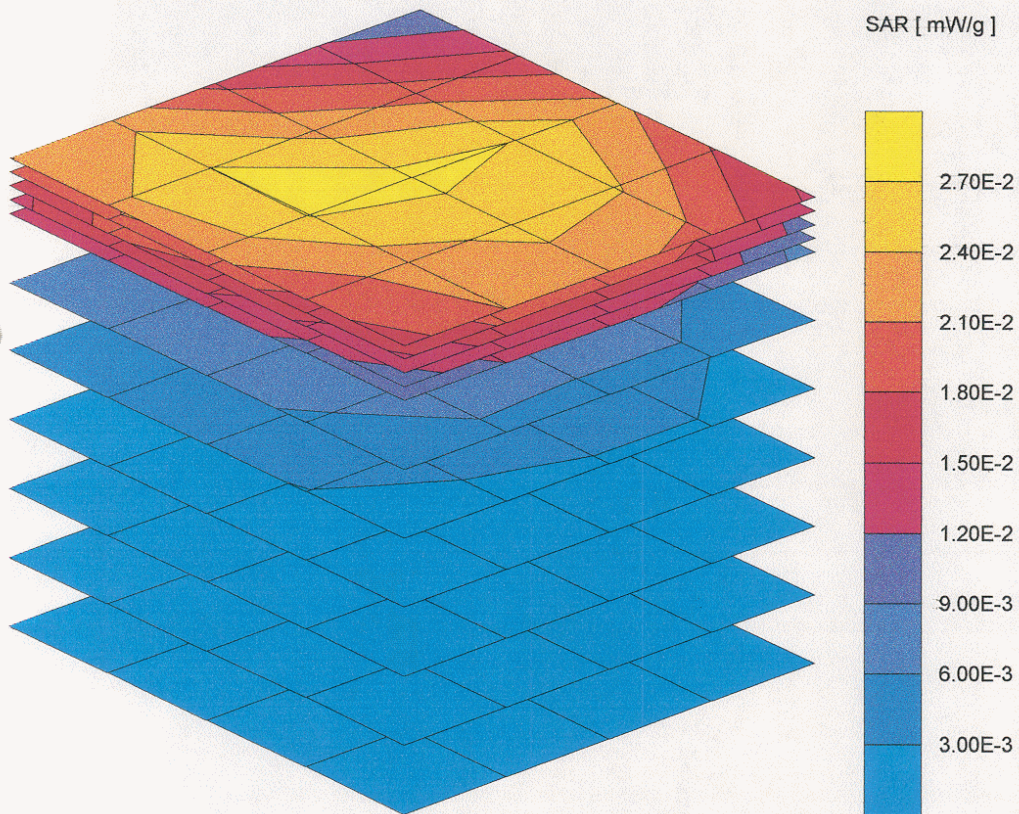

9631 Handset, F=1920.625 MHz, Antenna=1, RightSide, 11/10/98.MEA

$\sigma = 1.77$ [mho/m] $\epsilon_r = 41.2$ $\rho = 1.00$ [g/cm³]

Coarse Grid: Dx = 15.0 Dy = 15.0 Dz = 0.0 [mm]

SAR [mW/g] Max: 0.02

Max at (-90.00, 94.50, 4.00)

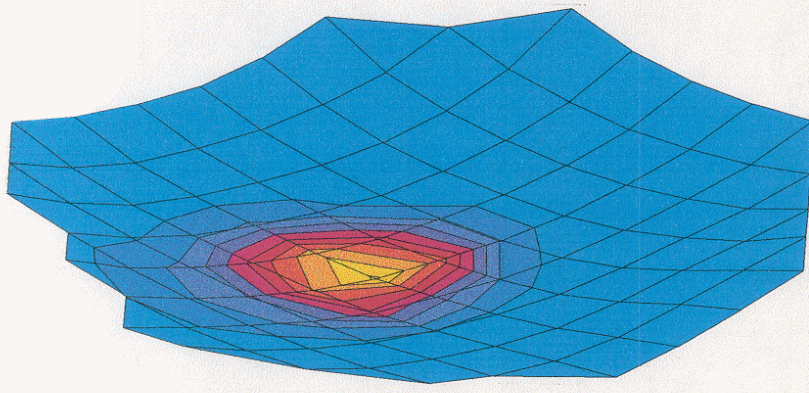

SAR [mW/g]

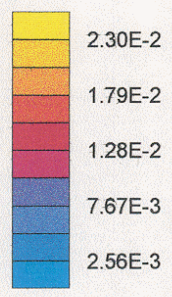

9631 Handset, F=1920.625 MHz, Antenna=1, RightSide, 11/10/98.MEA

$\sigma = 1.77$ [mho/m] $\epsilon_r = 41.2$ $\rho = 1.00$ [g/cm³]

Cube 5x5x7 $Dx = 8.0$ $Dy = 8.0$ $Dz = 5.0$ [mm]

SAR [mW/g] Max: 0.04

SAR (1g): 0.0220 [mW/g] SAR (10g): 0.0120 [mW/g]

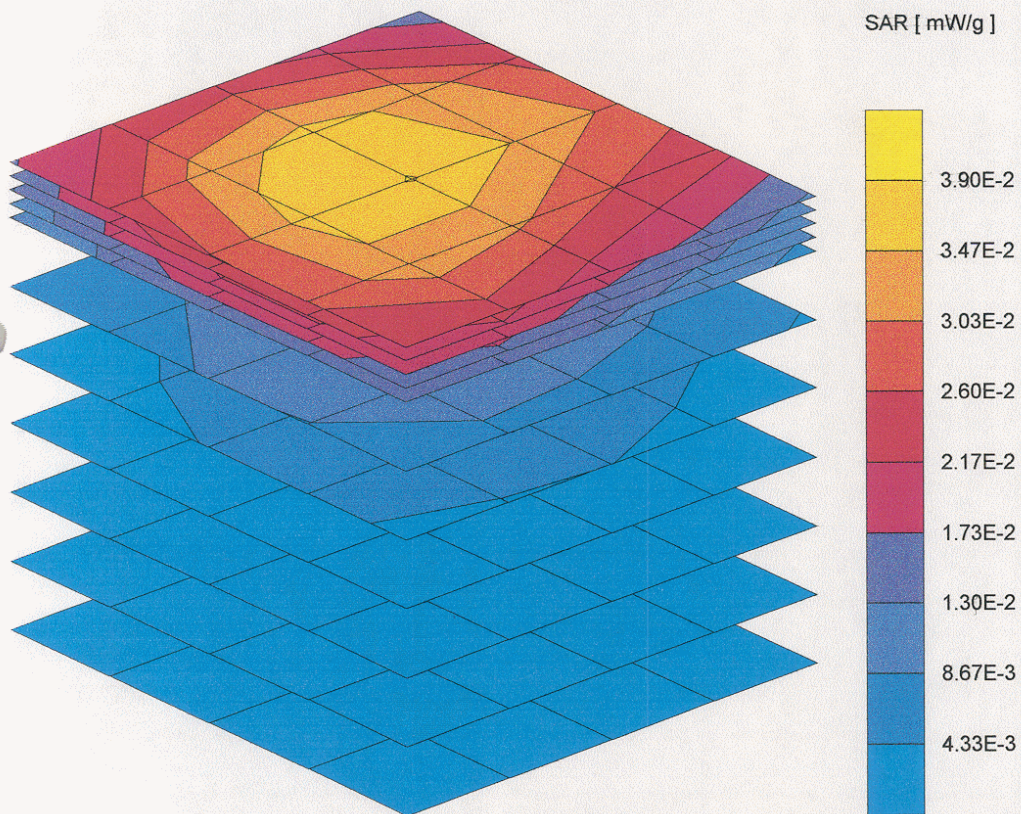

9631 Handset, F=1920.625 MHz, Antenna=0, LeftSide, 11/9/98.MEA

$\sigma = 1.77$ [mho/mm] $\epsilon_r = 41.2$ $\rho = 1.00$ [g/cm³]

Coarse Grid DX = 15.0 DY = 15.0 DZ = 0.0 [mm]

SAR [mW/g] Max: 0.02

Max at (93.00, 109.50, 4.00)

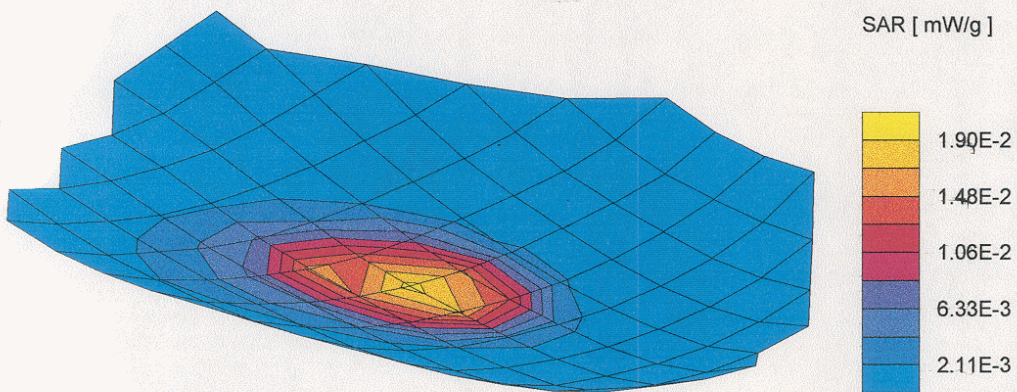

9631 Handset, F=1920.625 MHz, Antenna=0, LeftSide, 11/9/98.MEA

$\sigma = 1.77$ [mho/m] $\epsilon_r = 41.2$ $\rho = 1.00$ [g/cm³]

Cube 5x5x7 Dx = 8.0 Dy = 8.0 Dz = 5.0 [mm]

SAR [mW/g] Max: 0.03

SAR (1g): 0.0189 [mW/g] SAR (10g): 0.0107 [mW/g]

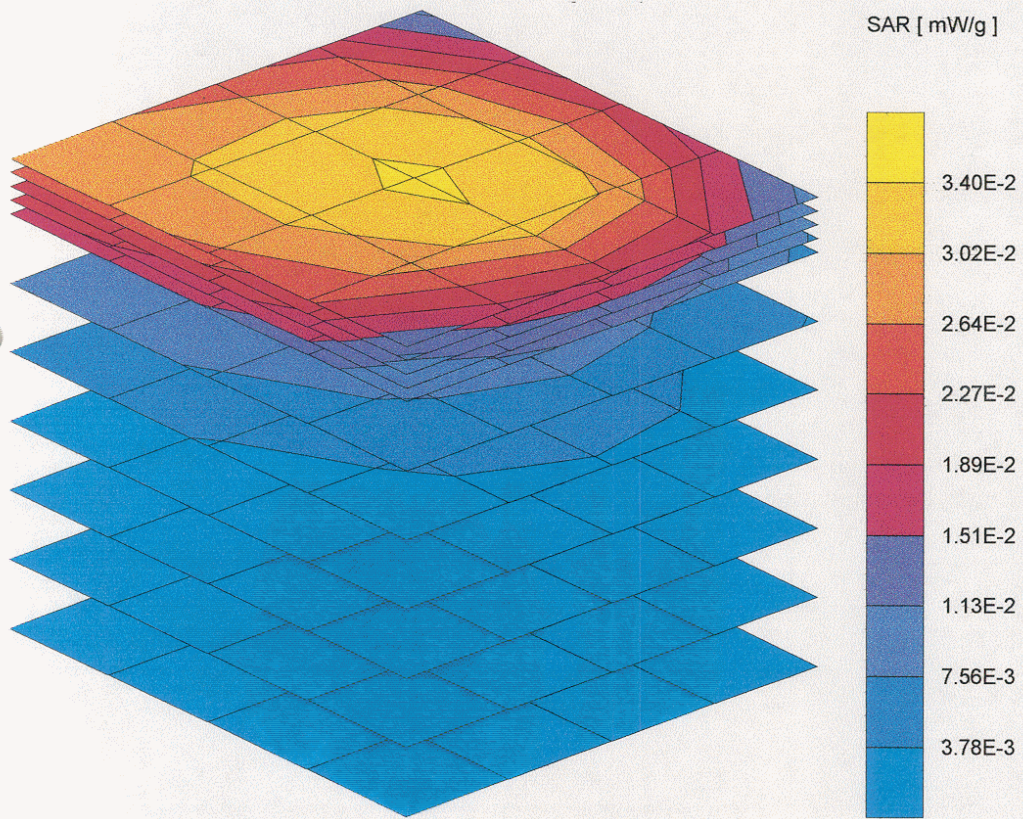

9631 Handset, F=1920.625 MHz, Antenna=1, LeftSide, 11/9/98.MEA

$\sigma = 1.77$ [mho/m] $\epsilon_r = 41.2$ $\rho = 1.06$ [g/cm³]

Coarse Grid $Dx = 15.0$ $Dy = 15.0$ $Dz = 0.0$ [mm]

SAR [mW/g] Max: 0.02

Max at (93.00, 109.50, 4.00)

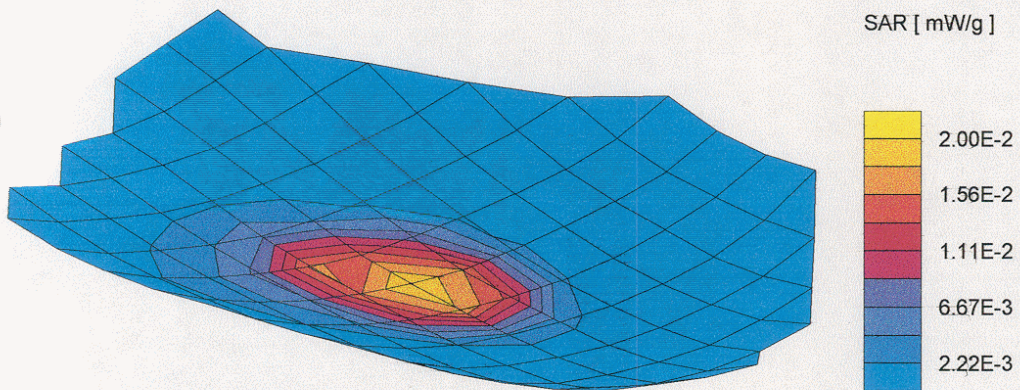

9631 Handset, F=1920.625 MHz, Antenna=1, LeftSide, 11/9/98.MEA

$\sigma = 1.77$ [mho/m] $\epsilon_r = 41.2$ $\rho = 1.00$ [g/cm³]

Cube 5x5x7 Dx = 8.0 Dy = 8.0 Dz = 5.0 [mm]

SAR [mW/g] Max: 0.04

SAR (1g): 0.0194 [mW/g] SAR (10g): 0.0107 [mW/g]

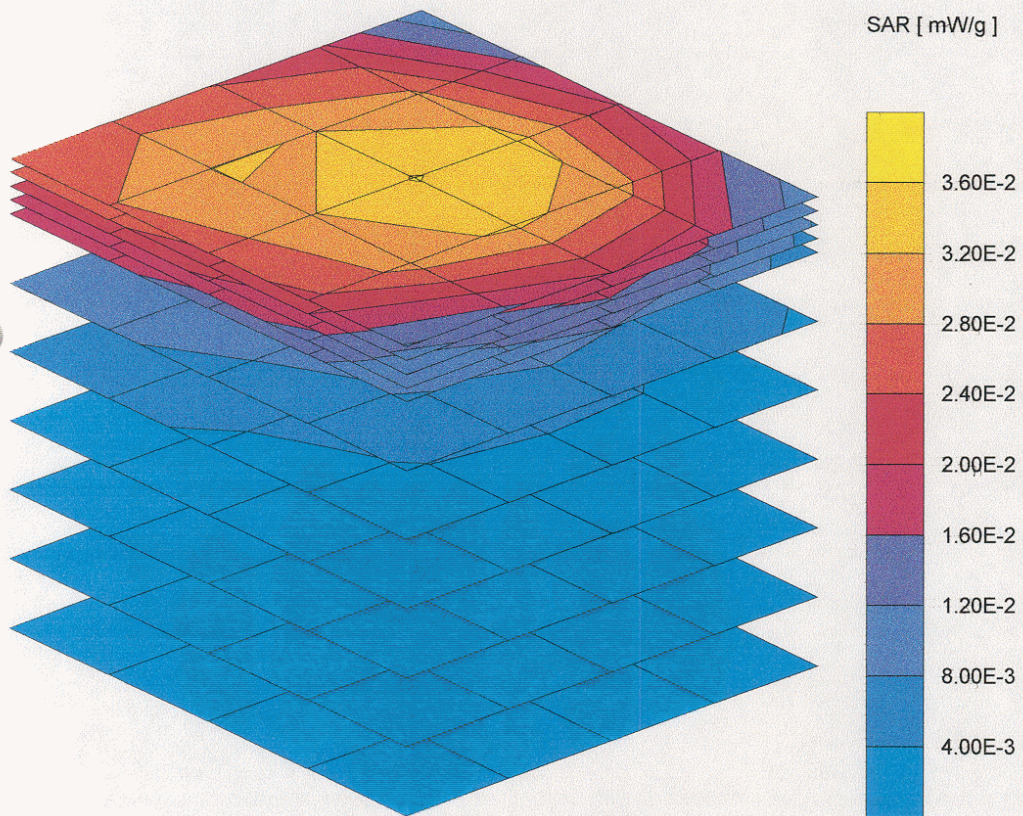

9631 Handset, F=1924.375 MHz, Antenna=1, LeftSide, 11/9/98.MEA

$\sigma = 1.77$ [mho/m] $\epsilon_r = 41.2$ $\rho = 1.00$ [g/cm³]

Coarse Grid $\Delta x = 15.0$ $\Delta y = 15.0$ $\Delta z = 0.0$ [mm]

SAR [mW/g] Max: 0.02

Max at (85.50, 90.00, 4.00)

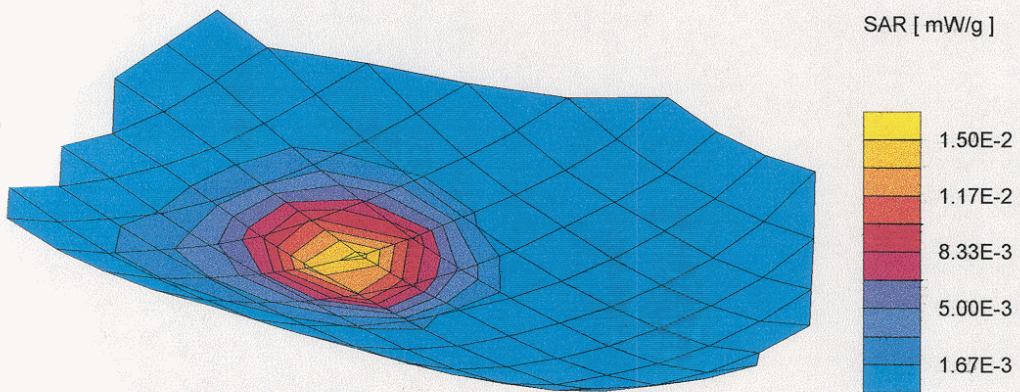

9631 Handset, F=1924.375 MHz, Antenna=1, LeftSide, 11/9/98.MEA

$\sigma = 1.77$ [mhos/m] $\epsilon_r = 41.2$ $\rho = 1.00$ [g/cm³]

Cube 5x5x7 Dx = 8.0 Dy = 8.0 Dz = 5.0 [mm]

SAR [mW/g] Max: 0.02

SAR (1g): 0.0142 [mW/g] SAR (10g): 0.0082 [mW/g]

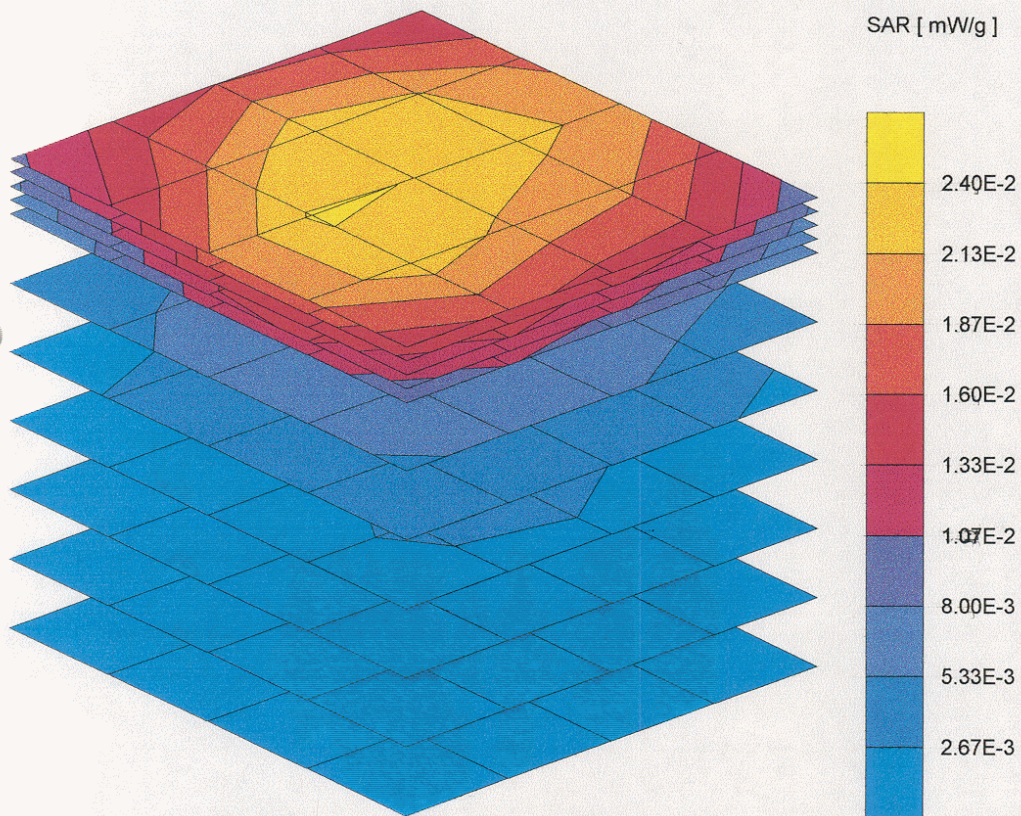

9631 Handset, F=1924.375 MHz, Antenna=0, LeftSide 11/9/98.MEA

$\sigma = 1.77$ [mho/m] $\epsilon_r = 41.2$ $\rho = 1.00$ [g/cm³]

Coarse Grid $\Delta x = 15.0$ $\Delta y = 15.0$ $\Delta z = 0.0$ [mm]

SAR [mW/g] Max: 0.02

Max at (91.50, 108.00, 4.00)

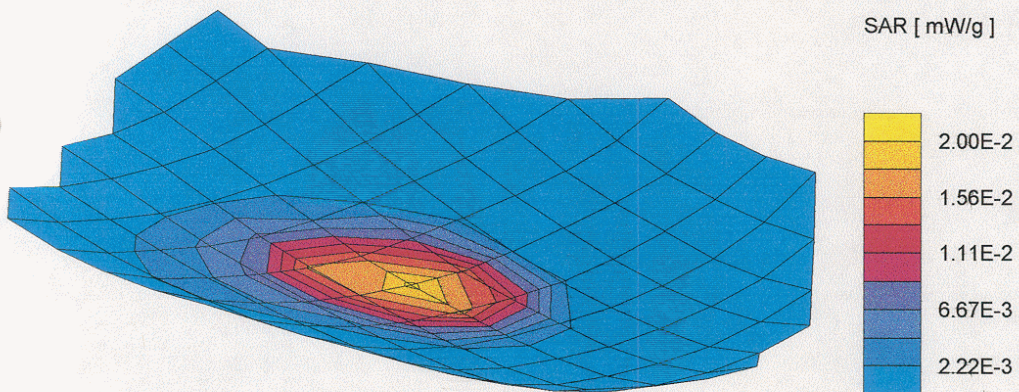

9631 Handset, F=1924.375 MHz, Antenna=0, LeftSide, 11/9/98.MEA

$\sigma = 1.77$ [mho/m] $\epsilon_r = 41.2$ $\rho = 1.00$ [g/cm³]

Cube 5x5x7 Dx = 8.0 Dy = 8.0 Dz = 5.0 [mm]

SAR [mW/g] Max: 0.04

SAR (1g): 0.0195 [mW/g] SAR (10g): 0.0109 [mW/g]

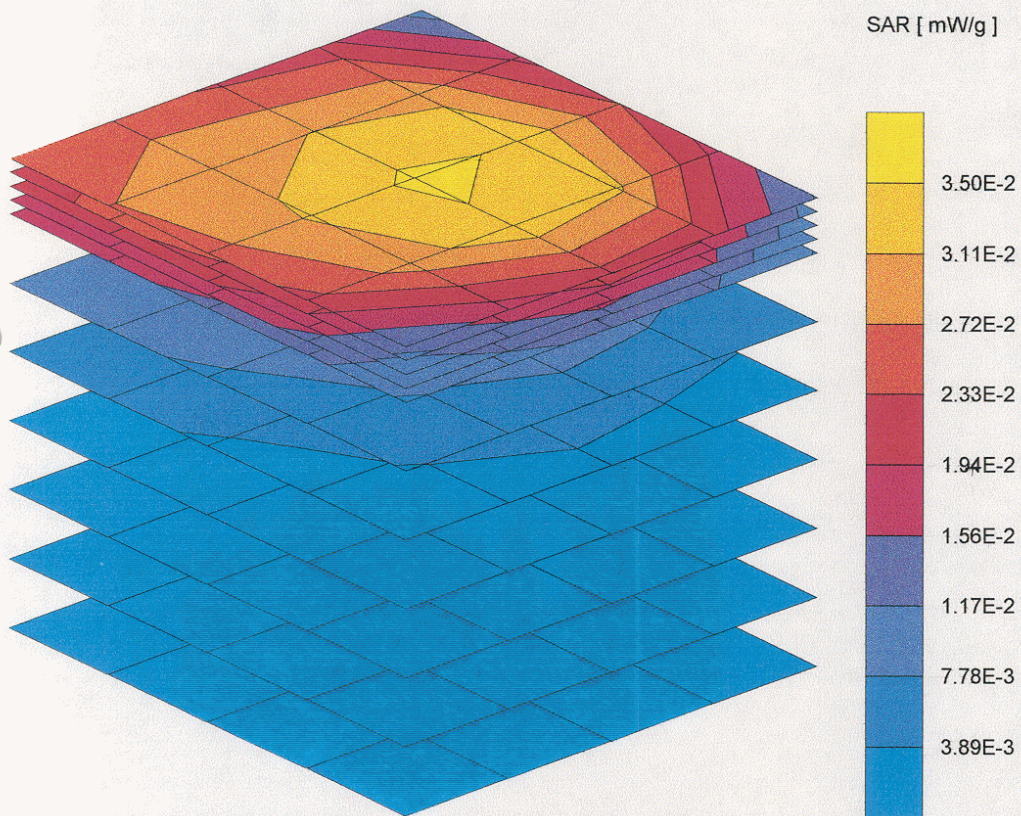

9631 Handset, F=1929.375MHz, Antenna=1, LeftSide, 11/9/98.MEA

$\sigma = 1.77$ [mho/m] $\epsilon_r = 41.2$ $\rho = 1.00$ [g/cm³]

Coarse Grid $Dx = 15.0$ $Dy = 15.0$ $Dz = 0.0$ [mm]

SAR [mW/g] Max: 0.01

Max at (84.00 ,90.00,4.00)

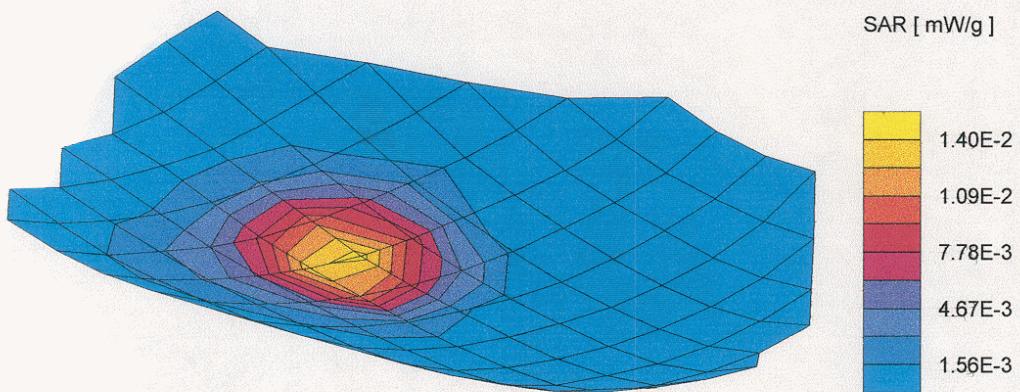

9631 Handset, F=1929.375 MHz, Antenna=1, Left Side 11/9/98.MEA

$\sigma = 1.77$ [mho/m] $\epsilon_r = 41.2$ $\rho = 1.00$ [g/cm³]

Cube 5x5x7 Dx = 8.0 Dy = 8.0 Dz = 5.0 [mm]

SAR [mW/g] Max: 0.02

SAR (1g): 0.0140 [mW/g] SAR (10g): 0.0082 [mW/g]

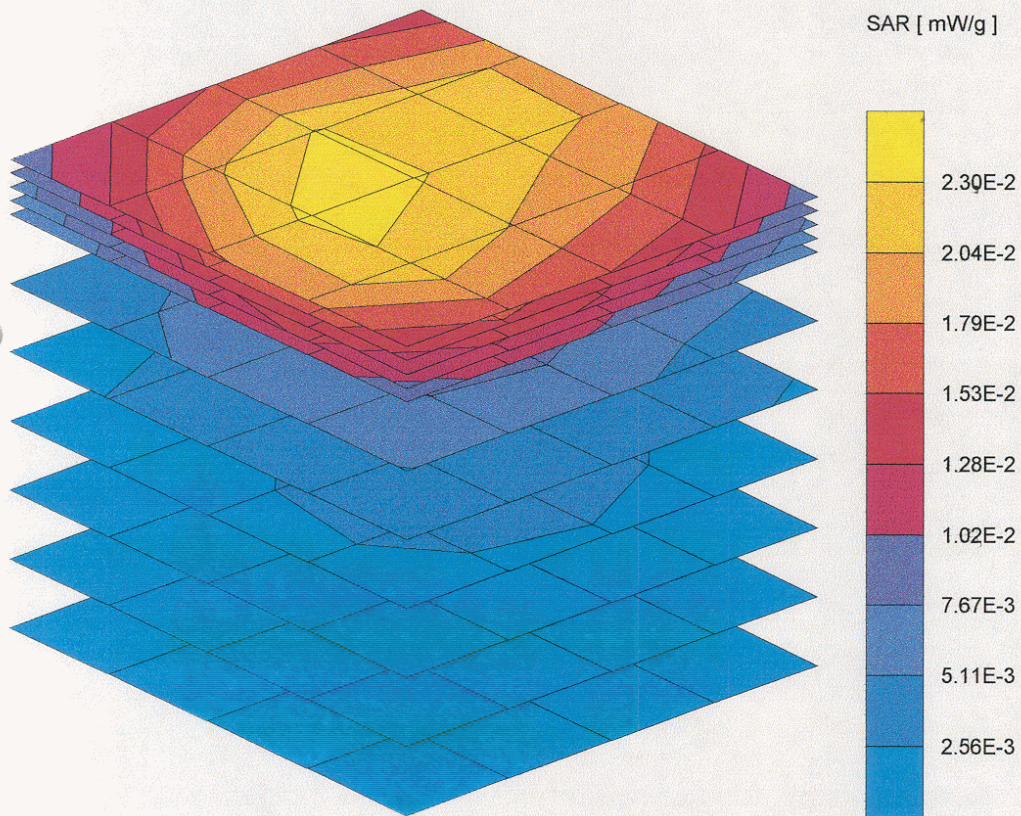

9631 Handset, F=1929.375 MHz, Antenna=0, LeftSide, 11/9/98.MEA

$\sigma = 1.77$ [mho/m] $\epsilon_r = 41.2$ $\rho = 1.00$ [g/cm³]

Coarse Grid Dx = 15.0 Dy = 15.0 Dz = 0.0 [mm]

SAR [mW/g] Max: 0.02

Max at (91.50 ,109.50,4.00)

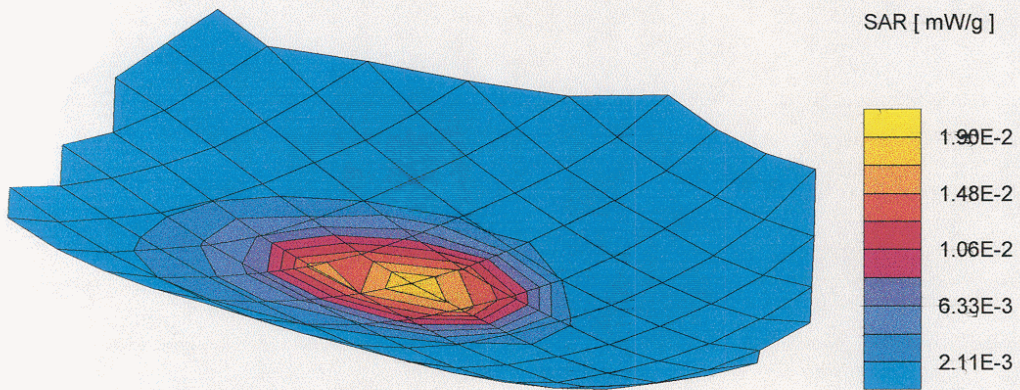

9631 Handset, F=1929.375MHz, Antenna=0, LeftSide, 11/9/98.MEA

$\sigma = 1.77$ [mho/m] $\epsilon_r = 41.2$ $\rho = 1.00$ [g/cm³]

Cube 5x5x7 D_x = 8.0 D_y = 8.0 D_z = 5.0 [mm]

SAR [mW/g] Max: 0.03

SAR (1g): 0.0182 [mW/g] SAR (10g): 0.0103 [mW/g]

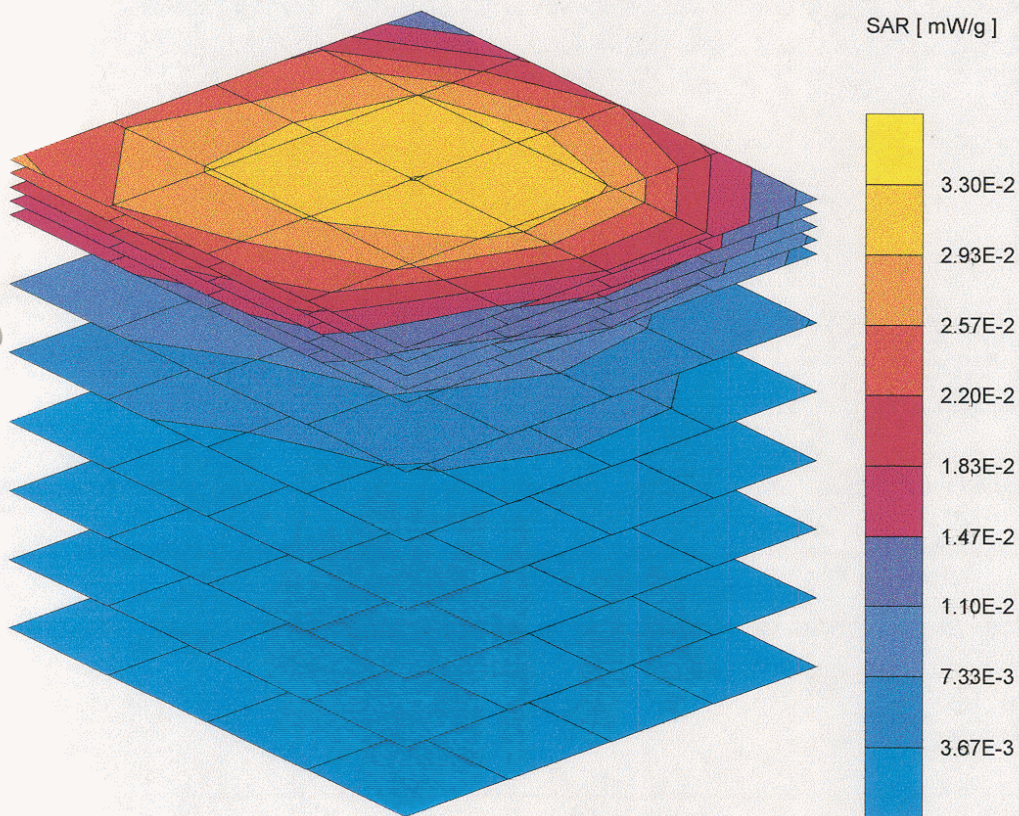

**PHOTOGRAPH(S) (copy) of EUT ARRANGEMENT
DURING SAR TEST**

Front View of Left Side

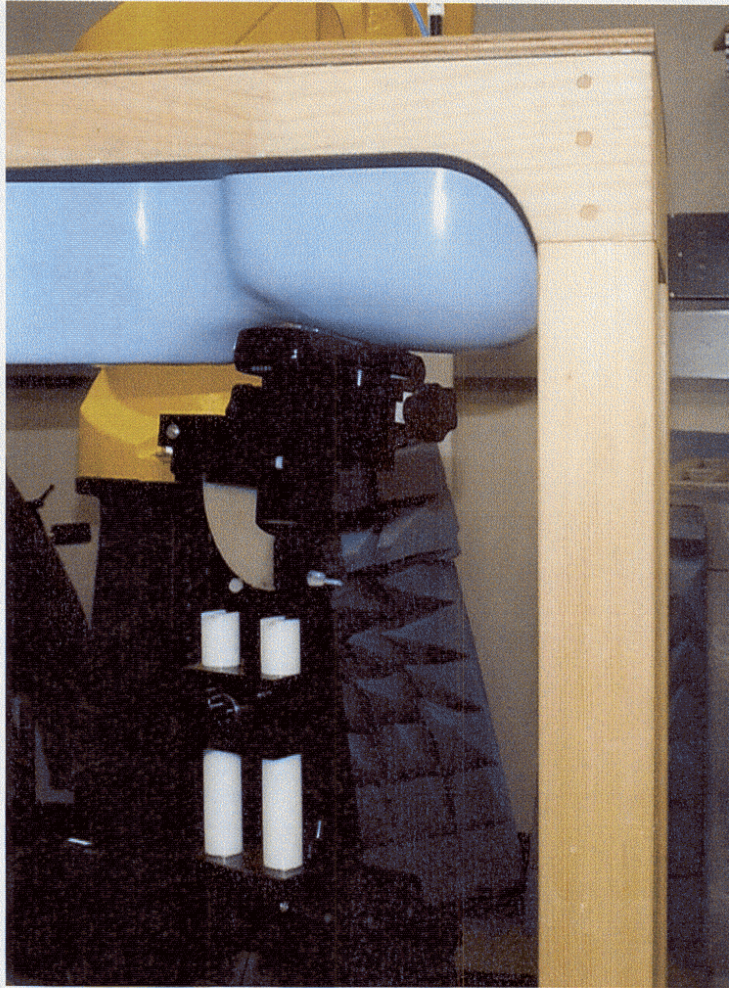

Rear View of Right Side

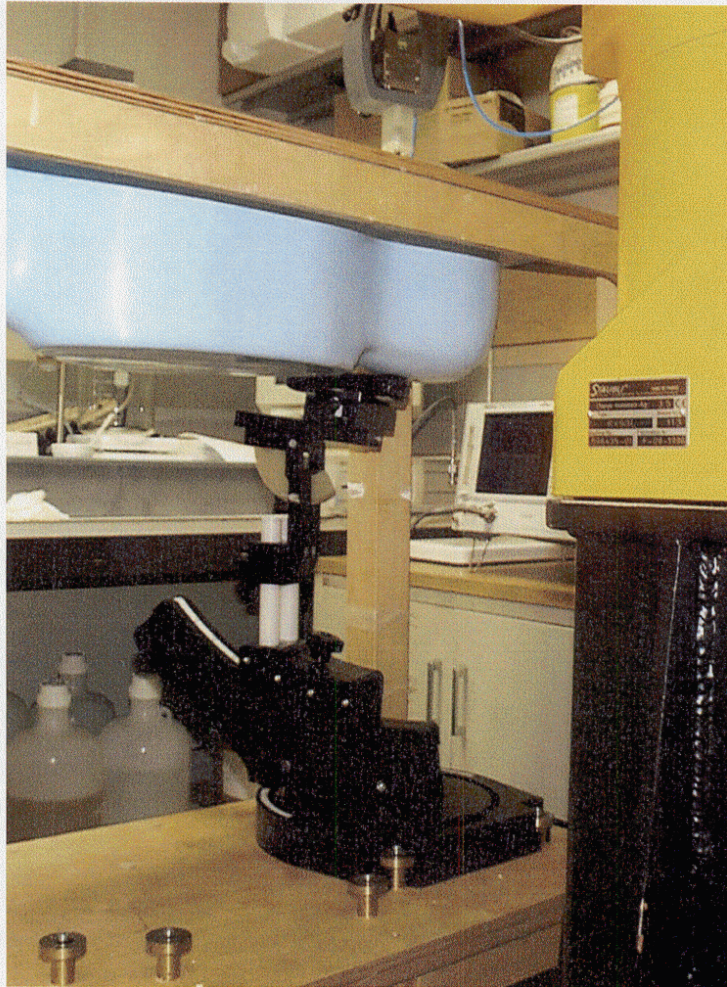

Front View of Left Side

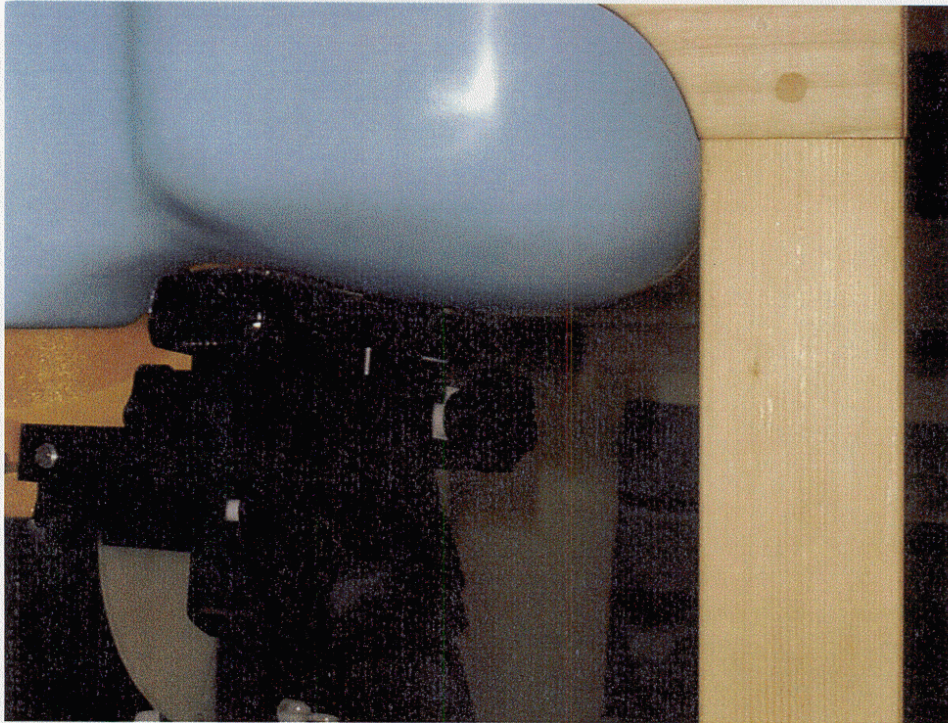

Front View of Right Side

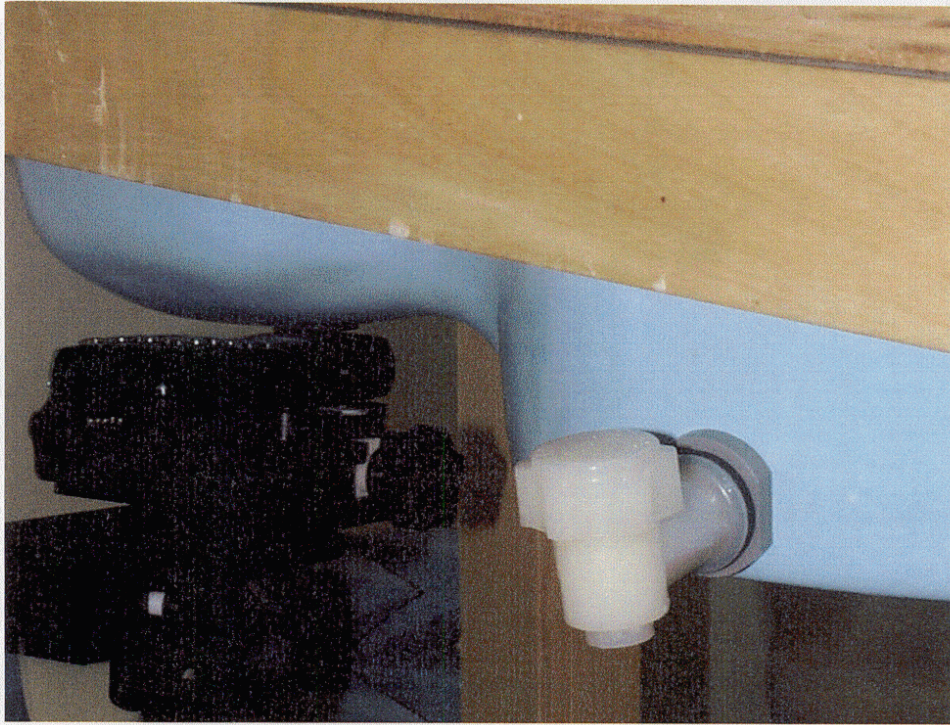

TEST EQUIPMENT CALIBRATION LIST

Manufacturer	Model Number	Serial Number	Description	Last Calibrated dd/mm/yy	Cal Cycle Month
Schmid & Partner Engineering AG	ET3DV4	1123	Probe	20/7/98	12
HP	83623A	3009A00184	Synthesized Sweeper	16/12/97	12
HP	437B	3110A03795	Power Meter	4/8/98	12
HP	8481A	3318A94086	Power Sensor	19/02/98	12
Amplifier Research	25S1G4	21071	RF Power Amplifier	N/A	N/A
Weinchel	46-20-34	BD5843	Attenuator	29/4/98	12
Weinchel	46-10-34	BD 5340	Attenuator	28/4/98	12

Brain Tissue Simulating Liquid Data

RECIPE I

Water	40.1%
Sugar	58.0%
Salt	0.8%
Hydroxyethylcellulosis (HEC)	1.0%
Preservative substance	1.0%

900 MHz: $\epsilon_r = 42.5 \pm 5\%$ and $s = 0.85 \pm 10\%$ mho/m, ConvF = $6.0 \pm 10\%$
450 MHz: $\epsilon_r = 47.2 \pm 5\%$ and $s = 0.45 \pm 10\%$ mho/m, ConvF = $6.7 \pm 10\%$
Simulates tissue according to the data provided by C. Gabriel at 900 MHz

RECIPE III

Water	45.0%
Sugar	53.9%
Hydroxyethylcellulosis (HEC)	1.0%
Preservative substance	1.0%

1800 MHz: $\epsilon_r = 41.0 \pm 5\%$ and $s = 1.65 \pm 10\%$ mho/m, ConvF = $4.8 \pm 10\%$
Simulates tissue according to the data provided by C. Gabriel at 1800 MHz

System Diagram

Test Setup

The diagram below is the test setup for specific absorption rate measurements.

DASY 2 SYSTEM WITH REMOTE CONTROL UNIT

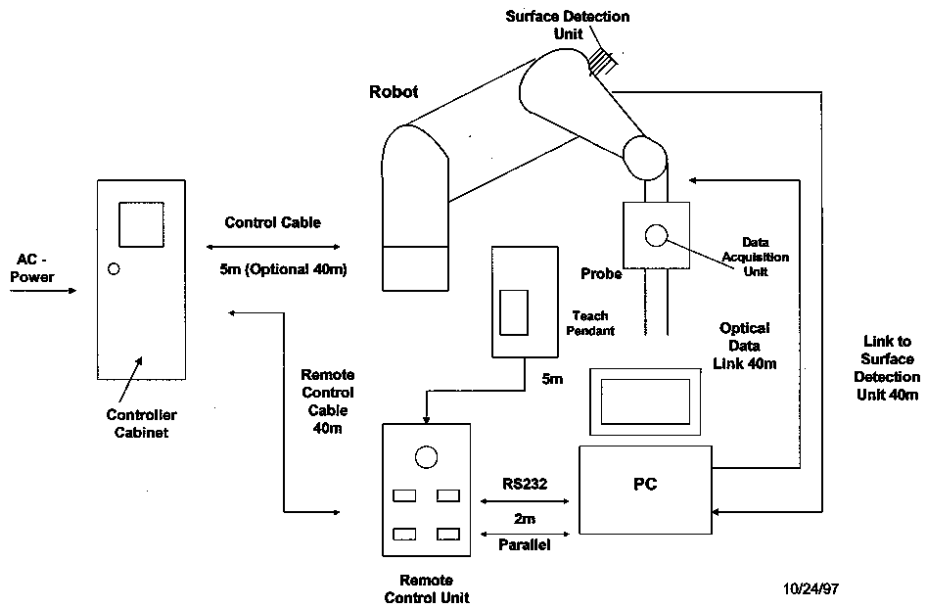

System Uncertainty Data

Uncertainty

Field measurement errors: $\leq \pm 13\%$ (includes isotropy error in tissue-simulation liquid: $\leq +0.2\text{dB}$ for the assessment procedure; frequency response: $\leq +0.1\text{dB}$; linearity: $\leq +0.2\text{dB}$; data acquisition and evaluation error: $\leq \pm 0.05\text{dB}$; probe calibration uncertainty: $\leq \pm 10\%$; ELF and RF disturbance: $\leq +10\text{uW/g}$)

Errors in evaluating spatial peak SAR values: $\leq \pm 7\%$ (includes extrapolation and interpolation errors and positioning errors: $\leq +0.1\text{dB}$ at 900 MHz and $\leq +0.2\text{dB}$ at 1800 MHz when using the surface detection with transparent, homogeneous sugar-water solutions. Whereby the angle between surface and probe ranges from 75 to 105 degrees; integration and maximum search routine: $\leq \pm 0.1\text{dB}$ for the fine cube measurement grid defined in the software (cube size: $32 \times 32 \times 30\text{mm}^3$; number of measurement points: $5 \times 5 \times 7$); inaccuracies in the cube's shape: $\leq \pm 0.2\text{dB}$ for angles between surface and probe ranging from 75 to 105 degrees).

Dosimetric Assessment System Calibration Data



**Schmid & Partner
Engineering AG**

Staffelstrasse 8, 8045 Zürich, Switzerland, Telefon +41 1 280 08 60, Fax +41 1 280 08 64

DASY - DOSIMETRIC ASSESSMENT SYSTEM

CALIBRATION REPORT

DATA ACQUISITION ELECTRONICS

MODEL: DAE2

SERIAL NUMBER: 222

This Data Acquisition Unit was calibrated and tested using a FLUKE 702 Process Calibrator. Calibration and verification were performed at an ambient temperature of 23 ± 5 °C and a relative humidity of < 70%.

Measurements were performed using the standard DASY software for converting binary values, offset compensation and noise filtering. Software settings are indicated in the reports.

Results from this calibration relate only to the unit calibrated.

Calibrated by: M.Bruggmann

Calibration Date: 20.7.1998

DASY Software Version: DASY3 V1.0b

1. DC Voltage Measurement

DA - Converter Values from DAE

High Range: 1LSB = 6.1 μ V, full range = 400 mV
 Low Range: 1LSB = 61nV, full range = 4 mV

Software Set-up: Calibration time: 3 sec Measuring time: 3 sec

Setup	X	Y	Z
High Range	400	400	400
Low Range	4	4	4
Connector Position	0°		

High Range	Input	Reading in μ V	% Error
Channel X + Input	200mV	200101.1	0.05
	20mV	20004.32	0.02
Channel X - Input	20mV	-19985.45	-0.07
	200mV	199699.2	-0.15
Channel Y + Input	20mV	19973.9	-0.13
	20mV	-19952.51	-0.24
Channel Y - Input	20mV	-19952.51	-0.24
	200mV	199926.8	-0.04
Channel Z + Input	20mV	19998.31	-0.01
	20mV	-19983.92	-0.08
Channel Z - Input	20mV	-19983.92	-0.08

Low Range	Input	Reading in μ V	% Error
Channel X + Input	2mV	2001.9	0.10
	0.2mV	200.4	0.20
Channel X - Input	0.2mV	-200.42	0.21
	2mV	2000.55	0.03
Channel Y + Input	0.2mV	200.06	0.03
	0.2mV	-200.43	0.22
Channel Y - Input	0.2mV	-200.43	0.22
	2mV	2002.34	0.12
Channel Z + Input	0.2mV	200.3	0.15
	0.2mV	-200.44	0.22
Channel Z - Input	0.2mV	-200.44	0.22

2. Common mode sensitivity

Software Set-up

Calibration time: 3 sec, Measuring time: 3 sec

High/Low Range

in μV	Common mode Input Voltage	High Range Reading	Low Range Reading
Channel X	200mV	-3.845116	-12.54785
	- 200mV	-0.1900478	3.36185
Channel Y	200mV	-3.178766	-2.986652
	- 200mV	2.703252	1.250767
Channel Z	200mV	-2.356277	-0.5931777
	- 200mV	-1.051177	0.07354297

3. Channel separation

Software Set-up

Calibration time: 3 sec, Measuring time: 3 sec

High Range

in μV	Input Voltage	Channel X	Channel Y	Channel Z
Channel X	200mV	-	2.831002	4.700725
Channel Y	200mV	5.305566	-	5.057163
Channel Z	200mV	3.527318	4.021758	-

4. AD-Converter Values with inputs shorted

in LSB	Low Range	High Range
Channel X	15999.05	16489.69
Channel Y	17024.61	16490.92
Channel Z	15382.57	16472.47

5. Input Offset Measurement

Measured after 15 min warm-up time of the Data Acquisition Electronic.
Every Measurement is preceded by a calibration cycle.

Software set-up:

Calibration time: 3 sec
Measuring time: 3 sec
Number of measurements: 100, Low Range

Input 10M Ω

in μ V	Average	min. Offset	max. Offset	Std. Deviation
Channel X	0.4657	-1.654	1.3245	0.654
Channel Y	0.36571	-0.46744	1.65798	0.5647
Channel Z	-0.003	-0.657	1.654	0.4657

Input shorted

in μ V	Average	min. Offset	max. Offset	Std. Deviation
Channel X	-0.546	-0.645	0.35435	0.56741
Channel Y	-0.3241	-0.68768	1.654	0.654
Channel Z	-0.8973	-0.145	1.543	0.47774

6. Input Offset Current

in fA	Input Offset Current
Channel X	< 100
Channel Y	< 100
Channel Z	< 100

7. Input Resistance

	Calibrating	Measuring
Channel X	199.2 k Ω	20.2M Ω
Channel Y	199.8 k Ω	20.2M Ω
Channel Z	199.8 k Ω	20.2M Ω

8. Low Battery Alarm Voltage

in V	Alarm Level
Supply (+ Vcc)	5.37 V
Supply (- Vcc)	-5.60 V

9. Power Consumption

in mA	Switched off	Stand by	Transmitting
Digital Supply (VCC)	0.012	9.0	12.6
Analog Supply (+ Vcc)	0.00	9.61	9.98
Analog Supply (- Vcc)	0.0005	-9.56	-9.61

10. Functional test

Touch async pulse 1	ok
Touch async pulse 2	na
Touch status bit 1	ok
Touch status bit 2	na
Remote power off	ok
Remote analog Power control	ok

Date: 20.7.98

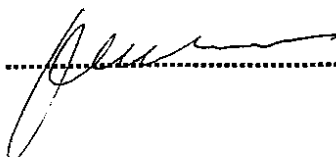
Signature: 

System Validation Data/Dipole Validation Kit

1800 MHz Verification 11/9/98.MEA
 $\sigma = 1.77$ [mho/m] $\epsilon_r = 41.2$ $\rho = 1.00$ [g/cm³]
Coarse Grid Dx = 15.0 Dy = 15.0 Dz = 0.0 [mm]
SAR [mW/g] Max: 35.02
Max at (153.00, 129.00, 4.00)

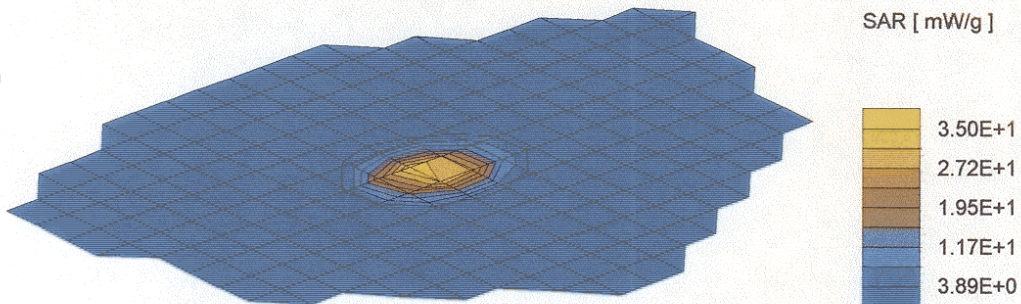

1800 MHz Verification 11/9/98.MEA

$\sigma = 1.77$ [mho/m] $\epsilon_r = 41.2$ $\rho = 1.00$ [g/cm³]

Cube 5x5x7 Dx = 8.0 Dy = 8.0 Dz = 5.0 [mm]

SAR [mW/g] Max: 74.69

SAR (1g): 40.0 [mW/g] SAR (10g): 20.6 [mW/g]

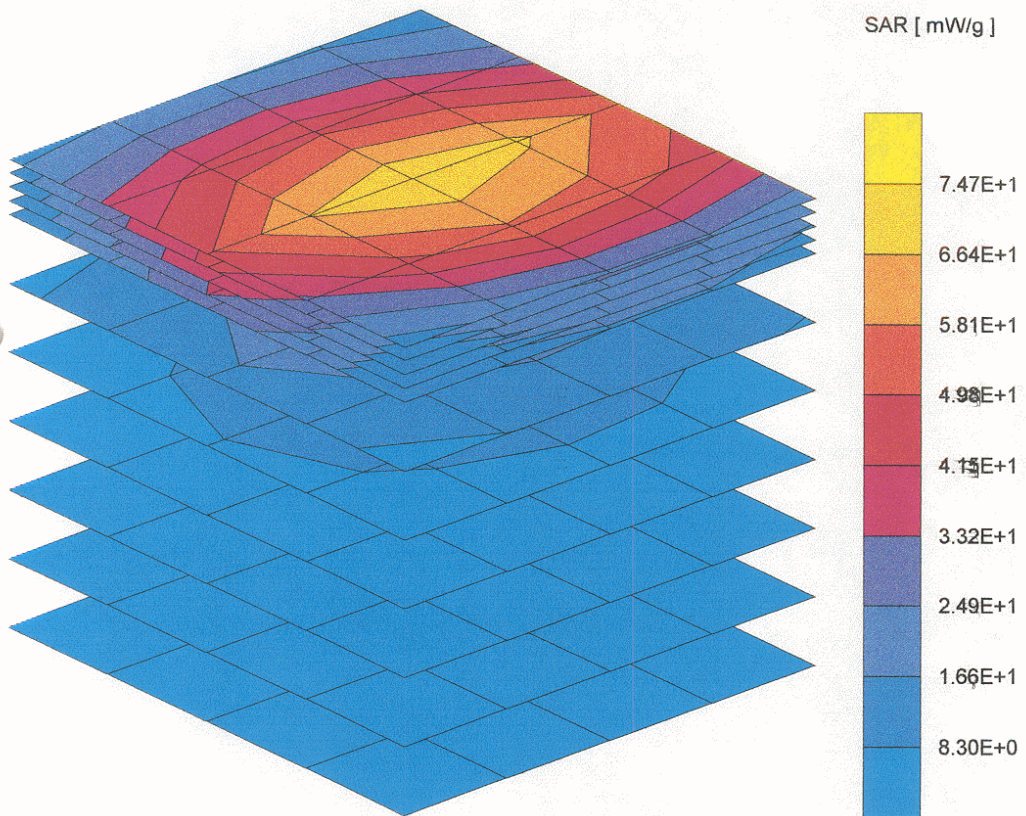

DASY3

Dipole Validation Kit

Type: D1800V2

Serial: 201

Manufactured: June 1996

Calibrated: July 1997

Recalibrated: July 1998

1. Measurement Conditions

The measurements were performed in the flat section of the new generic twin phantom (shell thickness 2mm) filled with brain simulating sugar solution of the following electrical parameters at 1800 MHz:

Relative Dielectricity	40.1	± 5%
Conductivity	1.65 mho/m	± 10%

The DASY3 System (Software version 3.0b) with a dosimetric E-field probe ET3DV4 (SN:1302, conversion factor 4.6) was used for the measurements.

The dipole feedpoint was positioned below the centre marking and oriented parallel to the body axis (the long side of the phantom). The standard measuring distance was 10mm from dipole centre to the solution surface. The included distance holder was used during measurements for accurate distance positioning.

The coarse grid with a grid spacing of 15mm was aligned with the dipole. The 5x5x7 fine cube was chosen for cube integration. Probe isotropy errors were cancelled by measuring the SAR with normal and 90° turned probe orientations and averaging. The dipole input power (forward power) was 250mW ± 3 %. The results are normalised to 1W input power.

2. SAR Measurement

Standard SAR-measurements were performed with the head phantom according to the measurement conditions described in section 1. The results (see figure) have been normalised to a dipole input power of 1W (forward power). The resulting averaged SAR-values are:

averaged over 1 cm ³ (1 g) of tissue:	39.1 mW/g
averaged over 10 cm ³ (10 g) of tissue:	20.0 mW/g

Note: If the liquid parameters for validation are slightly different from the ones used for initial calibration, the SAR-values will be different as well. The estimated sensitivities of SAR-values and penetration depths to the liquid parameters are listed in the DASY Application Note 4: 'SAR Sensitivities'.

Validation Dipole DI800V2 SN:201, d = 10mm

Frequency: 1800 [MHz]; Antenna Input Power: 250 [mW]
Generic Twin Phantom; Flat Section; Grid Spacing: Dx = 20.0, Dy = 20.0, Dz = 10.0
Probe: ET3DV5 - SN1302/DAE3; ConvF(4.60,4.60,4.60); Brain 1800 MHz: $\sigma = 1.65$ [mho/m] $\epsilon_r = 40.1$ $\rho = 1.00$ [g/cm³]
Tubes (2): Peak: 18.6 [mW/g] ± 0.01 dB, SAR (1g): 9.78 [mW/g] ± 0.01 dB, SAR (10g): 5.00 [mW/g] ± 0.01 dB, (Worst-case extrapolation)
Penetration depth: 7.6 (7.3, 8.1) [mm]

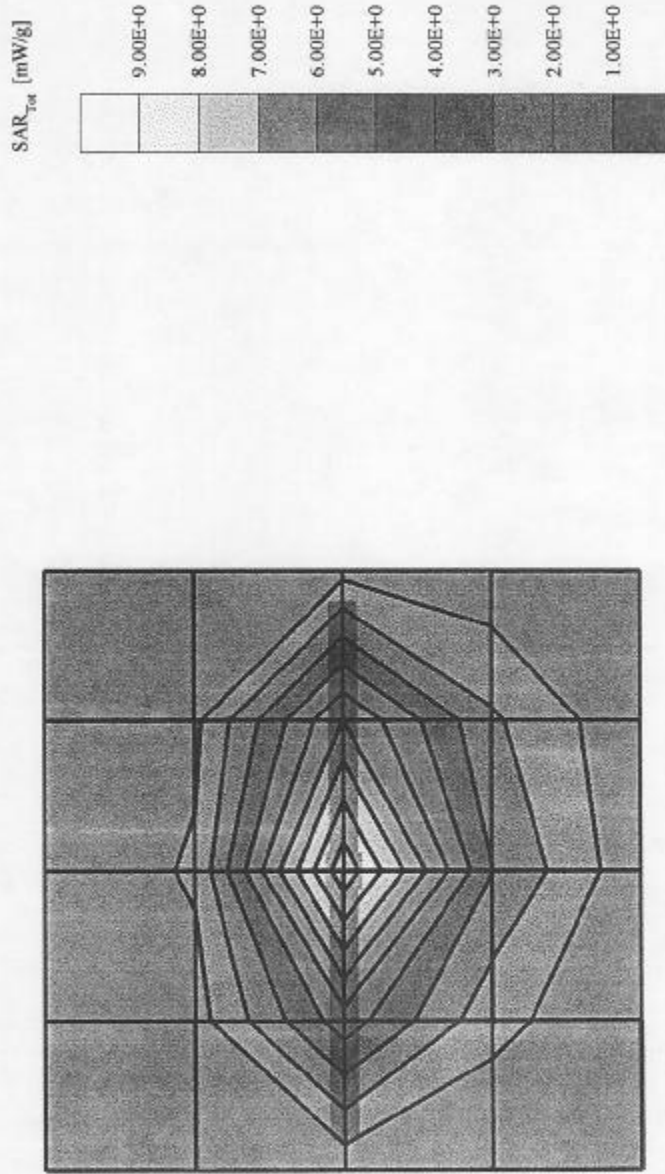

CH1 1→1 1 U FS 1 47.865 Ω 0.5469 Ω 48.354 PH
1 800.000 000 MHZ

Cor
E
Del

PAGE 61 OF 74

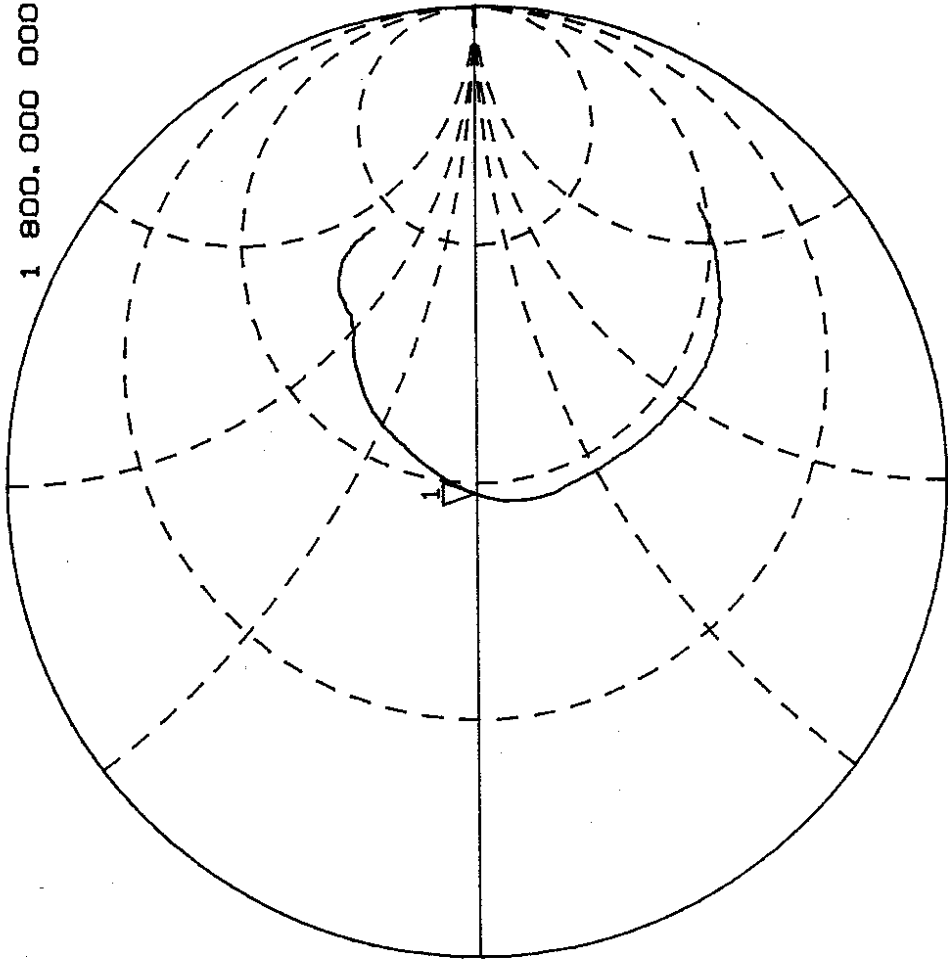

CENTER 1 800.000 000 MHZ SPAN 800.000 000 MHZ

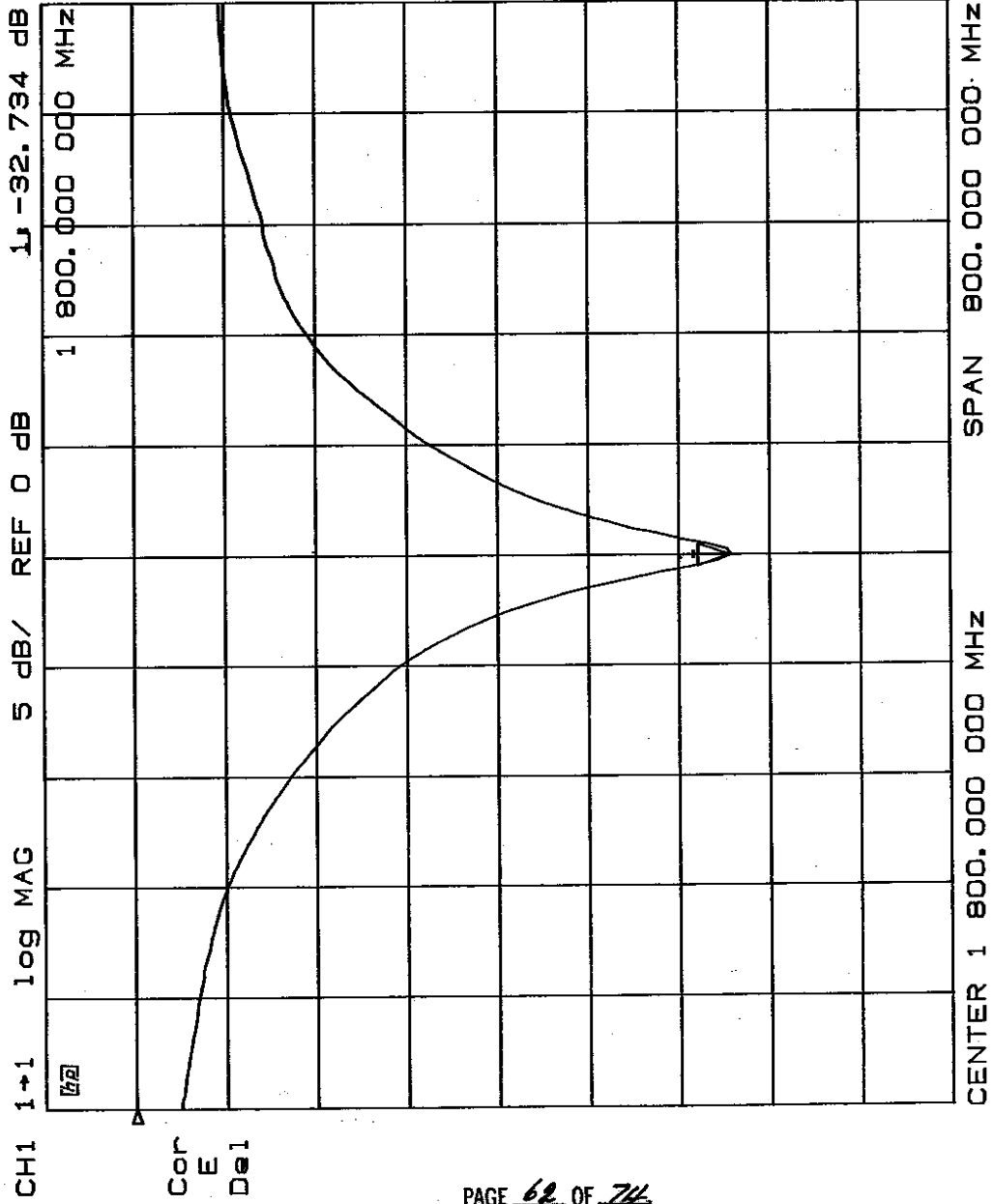

Probe Calibration Data

**Schmid & Partner
Engineering AG**

Staffelstrasse 8, 8045 Zurich, Switzerland, Telefon +41 1 280 08 60, Fax +41 1 280 08 64

Probe ET3DV4

SN:1123

Manufactured:	April 1996
Calibrated:	September 1997
Recalibrated:	July 1998

Calibrated for System DASY2

PAGE 64 OF 74

Introduction

The performance of all probes is measured before delivery. This includes an assessment of the characteristic parameters, receiving patterns as a function of frequency, frequency response and relative accuracy. Furthermore, each probe is tested in use according to a dosimetric assessment protocol. The sensitivity parameters (NormX, NormY, NormZ), the diode compression parameter (DCP) and the conversion factor (ConvF) of the probe and some of the measurement diagrams are given in the following.

The performance of the individual probes varies slightly due to tolerances arising from the manufacturing process. Since the lines are highly resistive (several MOhms), the offset and noise problem is greatly increased if signals in the low μV range are measured. Accurate measurement below $10 \mu\text{W/g}$ are possible if the following precautions are taken. 1) check the current grounding with the multimeter¹, i.e., low noise levels, 2) compensate the current offset¹, 3) use long integration time (approx. 10 seconds), 4) calibrate¹ before each measurement, 5) persons should avoid moving around the lab while measuring.

Since the field distortion caused by the supporting material and the sheath is quite high in the θ direction, the receiving pattern is poor in air. However, the distortion in tissue equivalent material is much less because of its high dielectricity. In addition, the fields induced in the phantoms by dipole structures close to the body are dominantly parallel to the surface. Thus, the error due to non-isotropy is much better than 1 dB for dosimetric assessments.

The probes are calibrated in the TEM cell in 110 although the field distribution in the cell is not very uniform and the frequency response is not very flat. To ensure consistency, a strict protocol is followed. The conversion factor (ConvF) between this calibration and the measurement in the tissue simulation solution is performed by comparison with temperature measurements and computer simulations. This conversion factor is only valid for the specified tissue simulating liquids at the specified frequencies. If measurements have to be performed in solutions with other electrical properties or at other frequencies, the conversion factor has to be assessed by the same procedure.

As the probes have been constructed with printed resistive lines on ceramic substrates (thick film technique), the probe is very delicate with respect to mechanical shocks.

Attention:

Do not drop the probe or let the probe collide with any solid object. Never let the robot move without first activating the emergency stop feature (i.e., without first turning the data acquisition electronics on).

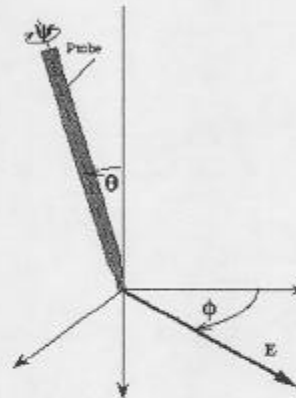

Fig 1: Due to the field distortion caused by the supporting material, the probe has two characteristic directions, referred to as angle ψ and θ .

¹ Feature of the DAS Y2 Software Tool.

ET3DV4 SN:1123

DASY2 - Parameters of Probe: ET3DV4 SN:1123

Sensitivity in Free Space

NormX	1.78	$\mu\text{V}/(\text{V}/\text{m})^2$
NormY	1.81	$\mu\text{V}/(\text{V}/\text{m})^2$
NormZ	1.73	$\mu\text{V}/(\text{V}/\text{m})^2$

Diode Compression

DCP X	41000	μV
DCP Y	41000	μV
DCP Z	41000	μV

Sensitivity in Tissue Simulating Liquid

450 MHz	ConvF X	5.9	extrapolated	$\epsilon_r = 48 \pm 5\%$ $\sigma = 0.50 \pm 10\% \text{ mho/m}$ (brain tissue simulating liquid)
	ConvF Y	5.9	extrapolated	
	ConvF Z	5.9	extrapolated	
900 MHz	ConvF X	5.5	$\pm 10\%$	$\epsilon_r = 41.5 \pm 5\%$ $\sigma = 0.86 \pm 10\% \text{ mho/m}$ (brain tissue simulating liquid)
	ConvF Y	5.5	$\pm 10\%$	
	ConvF Z	5.5	$\pm 10\%$	
1500 MHz	ConvF X	4.9	interpolated	$\epsilon_r = 41 \pm 5\%$ $\sigma = 1.32 \pm 10\% \text{ mho/m}$ (brain tissue simulating liquid)
	ConvF Y	4.9	interpolated	
	ConvF Z	4.9	interpolated	
1800 MHz	ConvF X	4.6	$\pm 10\%$	$\epsilon_r = 40.5 \pm 5\%$ $\sigma = 1.69 \pm 10\% \text{ mho/m}$ (brain tissue simulating liquid)
	ConvF Y	4.6	$\pm 10\%$	
	ConvF Z	4.6	$\pm 10\%$	

Sensor Offset

Probe Tip to Sensor Center	2.7	mm
Surface to Probe Tip	1.3 ± 0.2	mm

Receiving Pattern (ϕ), $\theta = 0^\circ$

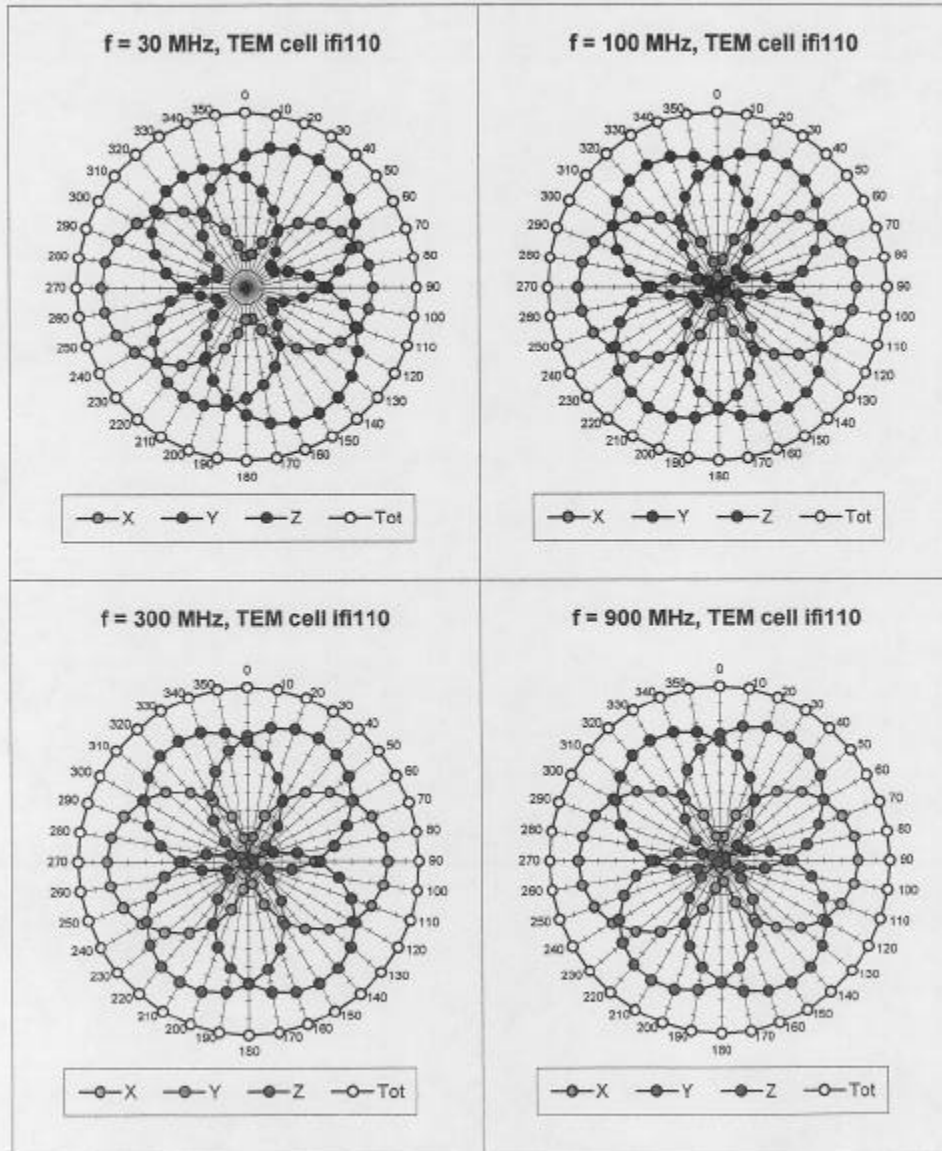

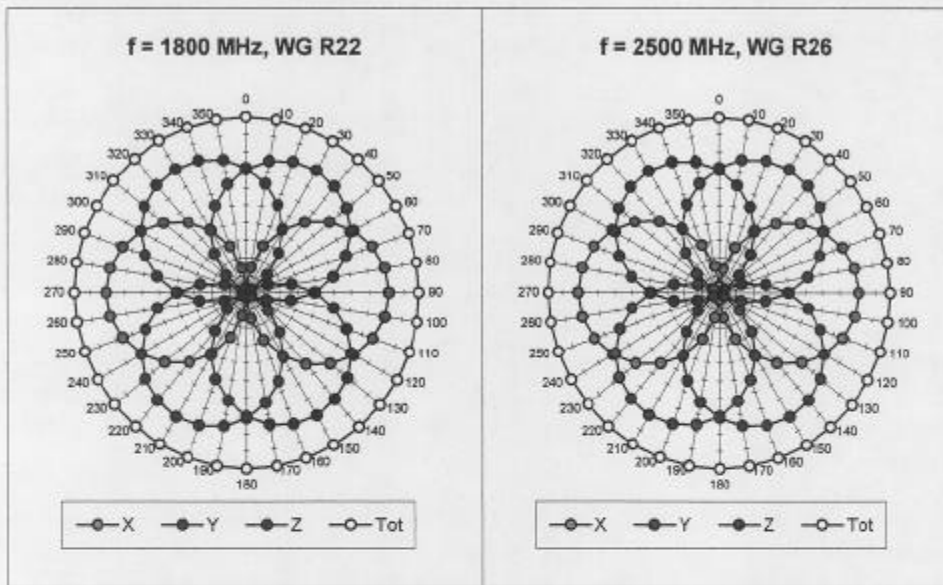

Isotropy Error (ϕ), $\theta = 0^\circ$

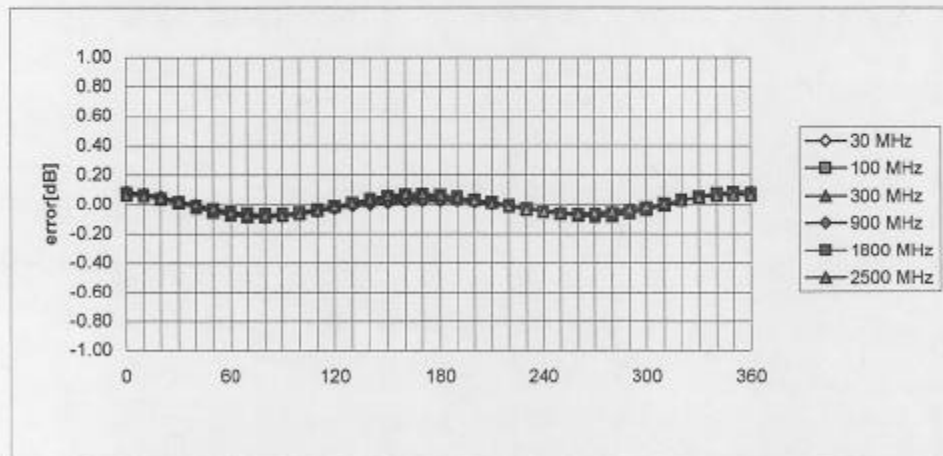

Frequency Response of E-Field

(TEM-Cell:ifi110, Waveguide R22, R26)

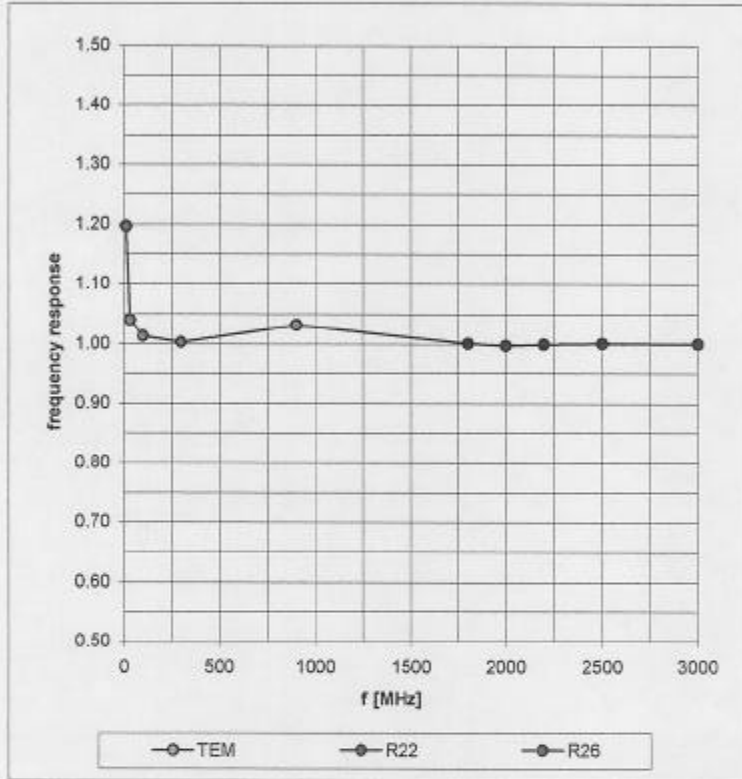

Dynamic Range $f(\text{SAR}_{\text{brain}})$ (TEM-Cell:ifi110)

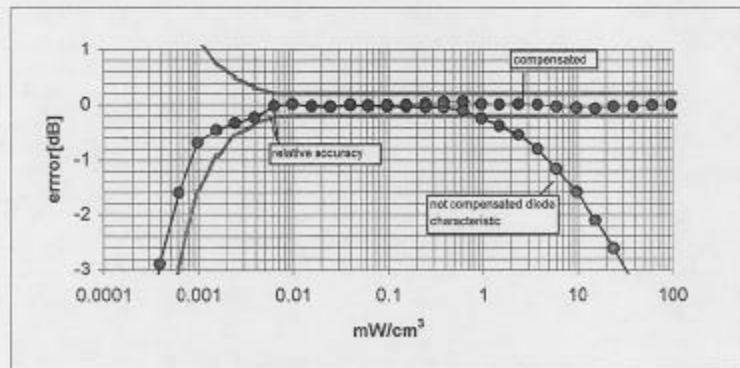
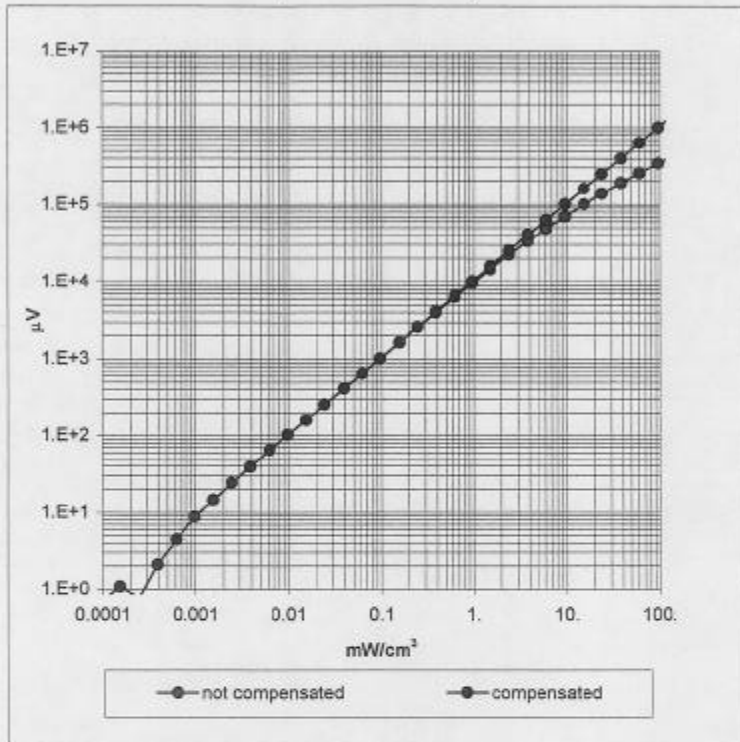

Conversion Factor Assessment

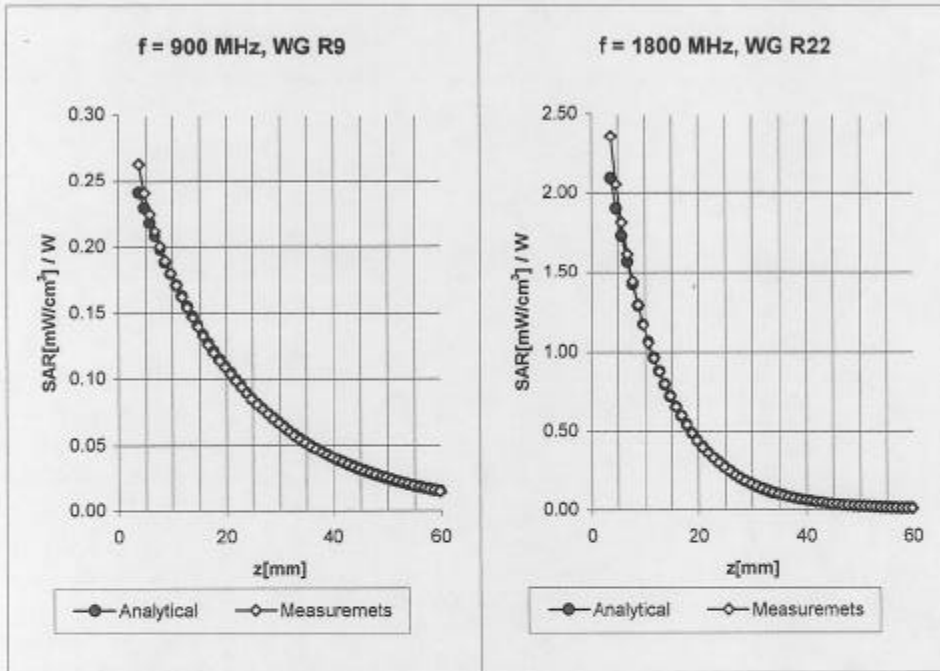

Receiving Pattern (ϕ)

(in brain tissue, z = 5 mm)

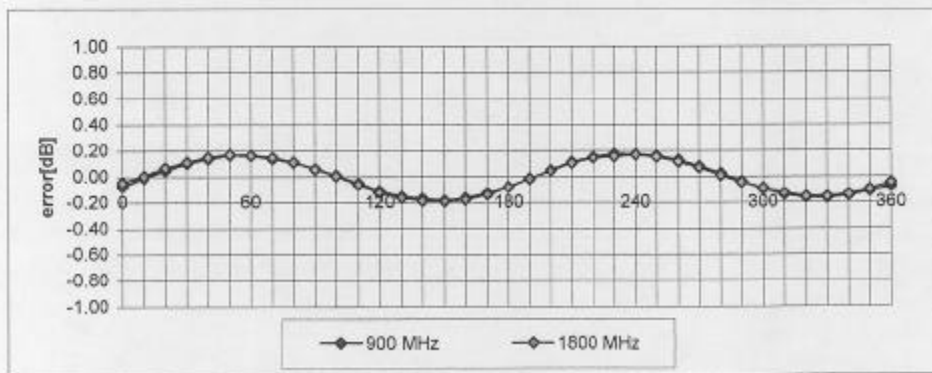



AFFILIATED WITH N.V. KEMA IN THE NETHERLANDS
A MEMBER OF THE EUROPEAN NETWORK FOR QUALITY SYSTEM ASSESSMENT AND CERTIFICATION "IQNET"

CERTIFICATE

Number: 10083.01

The quality system of:

**Lucent Technologies Inc.
Bell Labs Innovations
Global Product Compliance Laboratory
Holmdel, New Jersey 07733-3030**

including its implementation, meets the requirements of the standard:

ISO 9002:1994

Scope:

Electromagnetic Compatibility, Product Safety and Telecommunications Network Interconnect International Conformity Assessment Testing.

Reports that form the basis of this certificate:

10083.01.S001; 100830.01.S002; 10083.01.S003; 10083.01.S004; 10083.01.S005 up to and including 10083.01.S006

This certificate is valid until: January 16, 2001

Renewal date: January 16, 1998

Issued for the first time: February 1, 1995

H. Pierre Salle
President
KEMA-Registered Quality, Inc.

The method of operation for quality system and environmental management system certification is defined in the KRC Regulations for Quality System Certification. Integral publication of this certificate and adjoining reports is allowed.

KEMA-REGISTERED QUALITY, INC.
4379 County Line Road
Chalfont, PA 18914
Phone: (215) 822-4258 Fax: (215) 822-4285

ACCREDITED BY:

The Dutch Council for Accreditation (RvA)
The Registrar Accreditation Board (RAB)



National Institute
of Standards and Technology



National Voluntary
Laboratory Accreditation Program

ISO/IEC GUIDE 25:1990
ISO 9002:1987

Scope of Accreditation



Page: 1 of 2

ELECTROMAGNETIC COMPATIBILITY AND TELECOMMUNICATIONS

NVLAP LAB CODE 100275-0

LUCENT TECHNOLOGIES, GLOBAL PRODUCT COMPLIANCE LAB

101 Crawfords Corner Road, M/S 11C-195

P.O. Box 3030

Holmdel, NJ 07733-3030

Mr. E. Gardner Burkhardt

Phone: 732-332-6001 Fax: 732-332-5999

NVLAP Code Designation / Description

International Special Committee on Radio Interference (CISPR) Methods

12/CIS22 IEC/CISPR 22:1993: Limits and methods of measurement of radio disturbance characteristics of information technology equipment

Federal Communications Commission (FCC) Methods

12/F01 FCC Method - 47 CFR Part 15 - Digital Devices

12/F01a Conducted Emissions, Power Lines, 450 KHz to 30 MHz

12/F01b Radiated Emissions

AUSTEL Technical Standards as determined under the Telecommunications Act of 1991

12/T41 TS-001: Safety Requirements for Customer Equipment

12/T42 TS-002: Analogue Interworking and Non-Interference Requirements for Customer Equipment Connected to the Public Switched Telephone Network

12/T44 TS-004: Voice Frequency Performance Requirements for Customer Equipment

September 30, 1999

Effective through

For the National Institute of Standards and Technology

National Institute
of Standards and Technology



National Voluntary
Laboratory Accreditation Program

ISO/IEC GUIDE 25:1990
ISO 9002:1987

Scope of Accreditation



Page: 2 of 2

**ELECTROMAGNETIC COMPATIBILITY
AND TELECOMMUNICATIONS**

NVLAP LAB CODE 100275-0

LUCENT TECHNOLOGIES, GLOBAL PRODUCT COMPLIANCE LAB

NVLAP Code *Designation / Description*

12/T45 TS-006: General Requirements for Customer Equipment Connected to the
Non-Switched Telephone Network

12/T46 TS-008: Requirements for Authorized Cabling Products

Australian Standards referred to by clauses in AUSTEL Technical Standards

12/T51 AS/NZS 3548: Electromagnetic Interference - Limits and Methods of Measurement of
Information Technology Equipment

September 30, 1999

Effective through

A handwritten signature in black ink, appearing to read 'John T. ...'.

For the National Institute of Standards and Technology

NVLAP-01S (11-95)