

Lucent Technologies
Bell Labs Innovations



TransTalk™ 9000
Digital Wireless System
MDW 9031 Wireless Pocketphone
Installation and Use

503-801-166
Comcode 108170176
Issue 1
November 1997

Copyright ©1997 Lucent Technologies
All Rights Reserved
Printed in U.S.A.

Lucent Technologies 503-801-166
Comcode 108170176
Issue 1
November 1997

Notice

Every effort was made to ensure that the information in this book was complete and accurate at the time of printing. However, information is subject to change. The pictures in this book are for illustrative purposes only; your actual hardware may look slightly different.

Federal Communications Commission (FCC) and Industry Canada (IC) Information

For details, see Appendix B.

Security

Toll fraud, the unauthorized use of your telecommunications system by an unauthorized party (for example, persons other than your company's employees, agents, subcontractors, or persons working on your company's behalf) can result in substantial additional charges for your telecommunications services. You are responsible for the security of your system. There may be a risk of toll fraud associated with your telecommunications system. You are responsible for programming and configuring your equipment to prevent unauthorized use. Your system administrator should read all documents provided with this product to fully understand the features that can introduce the risk of toll fraud and the steps that can be taken to reduce that risk. Lucent Technologies does not warrant that this product is immune from or will prevent unauthorized use of common-carrier telecommunication services or facilities accessed through or connected to it. Lucent Technologies will not be responsible for any charges that result from such unauthorized use.

Trademarks

TransTalk is a trademark of Lucent Technologies and DEFINITY, MERLIN, MERLIN LEGEND, PARTNER, and SYSTIMAX are registered trademarks of Lucent Technologies. Supra is a registered trademark of Plantronics, Inc.

Warranty

Lucent Technologies provides a limited warranty for this product; see Appendix A.

Ordering Information

The order number for this book is 503-801-166. The order number for the *MDW 9031 Wireless Pocketphone Quick Reference* is 503-801-165. To order additional copies of these reference materials, call 1 800 457-1235 or 1 317 361-5353. To order parts and accessories, see "Ordering Replacement & Optional Parts" in Chapter 4.

Customer Support

In the continental U.S., call 1 800 628-2888 if you need assistance when using your wireless phone with a PARTNER, MERLIN, or MERLIN LEGEND system. Consultation charges may apply. For all other systems, follow the procedure you normally use to get support for your communications system.

Outside the continental U.S., contact your Lucent Technologies Representative or local Authorized Dealer.

Contents

1	Introduction	1-1
	About TransTalk™ 9000 Products	1-1
	What Is a Wireless Phone?	1-1
	TransTalk 9000 System	1-1
	About the MDW 9031 Pocketphone	1-3
	Privacy Information	1-3
	Where Can You Use Your Pocketphone?	1-3
	Parts List	1-4
	Additional Parts	1-5
	Spare Battery and Headset	1-6

2	Installing the MDW 9031 Pocketphone	2-1
	Important Safety Instructions	2-1
	Guidelines for Safe and Efficient Operation	2-2
	Exposure to Radio Frequency Energy	2-2
	Cardiac Pacemakers	2-2
	Hearing Aid Compatibility	2-2
	Basic Safety Precautions for Installation and Use	2-3
	Additional Safety Instructions for Installation Personnel	2-4
	AC Outlet Check	2-5
	Installation Overview for Radio Modules and Carriers	2-6
	Radio Module/Switch Wiring	2-6
	Key Components	2-7
	Positioning a Radio Module or Carrier(s)	2-9
	General Positioning Rules	2-9
	Installing a Single Radio Module	2-11
	Single Radio Module Installation Self Test	2-12
	Understanding Carriers	2-13
	Understanding Your Model 117A3 Carrier	2-13
	Setting the 117A3 Carrier Power Level	2-15
	Setting the 117A3 Carrier Control/Expansion DIP Switch	2-16

Understanding Your Model 117A4 Carrier	2-18
Installing a Single Carrier	2-21
Installing a Single Carrier on a Shelf or Desk	2-22
Installing a Single Carrier on a Wall	2-25
Single Carrier Installation Self Test	2-28
Installing Multiple Carriers	2-29
Mounting and Cabling Multiple Carriers	2-29
Multiple Carrier Mounting and Cabling Self Test	2-32
Installing a Single Radio Module in Each Carrier	2-33
Installation Self Test with a Single Radio Module in Each Carrier	2-35
Installing the Remaining Radio Modules	2-37
Installation Self Test for Remaining Radio Modules	2-39
Handset	2-41
Inserting and Removing the Handset's Battery Pack	2-41
Changing the Communications System Setting	2-42
Filling Out the Handset Label	2-43
Battery Charger	2-44
Positioning the Battery Charger	2-44
Installing the Battery Charger	2-44
Inserting a Battery Pack into the Spare Battery Compartment	2-46
Removing a Battery Pack from the Spare Battery Compartment	2-47
Inserting the Handset into the Battery Charger's Handset Cradle	2-48
Removing the Handset from the Handset Cradle	2-48

3	Using the MDW 9031 Pocketphone	3-1
	Important Safety Instructions	3-1
	The Handset	3-1
	Handset Controls	3-2
	Column and Select Buttons	3-3
	Handset Display (with Backlighting)	3-4
	Display Messages	3-5
	Line Status Indicators	3-5
	Range Indicators	3-6
	Low Battery Indicator	3-6
	Volume Control	3-7

Carrying Your Pocketphone	3-7
Antenna	3-8
Changing the Handset Settings	3-8
Changing the Communications System	
Button Mapping Setting	3-8
Enabling or Disabling the Vibrator	3-9
Enabling or Disabling Line Preselection	3-9
Enabling or Disabling Backlighting	3-10
Enabling or Disabling the Alerter	3-11
Test Modes	3-12
Using Local Test Mode	3-12
Using Wireless Test Mode	3-13
"Waking Up" the Phone	3-17
Making a Call	3-17
Answering a Call	3-17
Manually Selecting a Line or Programmed Button	3-18
Preselecting a Line	3-18
Using a Headset	3-19
Using the Headset On/Off Button	3-19
Answering Calls with a Headset	3-19
Placing Calls with a Headset	3-20
The Battery Charger	3-21
Battery Charger Features	3-21
Extending Battery Life	3-23

4	Maintaining the MDW 9031 Pocketphone	4-1
	Important Safety Instructions	4-1
	Removing a Radio Module from the Carrier	4-1
	Swapping Extensions	4-3
	Replacing the Antenna	4-4
	Ordering Replacement & Optional Parts	4-5

5	Troubleshooting	5-1
	Procedures	5-1
	Installation Problems	5-1
	Handset Problems	5-5
	Battery Problems	5-7
	Voice Quality Problems	5-8
	Range Problems	5-11
	Battery Charger Problems	5-14

6	MDW 9031 Pocketphone Compatibility	6-1
	Programming and Call Handling Instructions	6-1
	Programming Features for PARTNER, MERLIN, and MERLIN LEGEND Systems	6-2
	Communications System Compatibility	6-3
	PARTNER Systems	6-3
	Button Mapping for PARTNER Systems	6-3
	Setting the Line-Ringing Options	6-4
	MERLIN Systems	6-5
	Button Mapping for MERLIN Systems except MERLIN 410 and MERLIN 820	6-6
	Button Mapping for MERLIN 410 and MERLIN 820 Systems	6-7
	Setting the Line Ringing Options	6-8
	System 25, System 75, System 85, and DEFINITY Systems	6-9
	Button Mapping for DEFINITY Systems, System 25, System 75, and System 85	6-10
	Setting the Line Ringing Options	6-12

A	Warranty and Repair Information	A-1
	Lucent Technologies Limited Warranty and Limitation of Liability	A-1
	Limitation of Liability	A-2
	Repair Information	A-2
	In-Warranty Repairs	A-2
	Post-Warranty Repairs	A-3

B	Regulatory Information	B-1
	FCC Part 15 Rules	B-1
	IC RSS-210 Compliance	B-1
	Hearing Aid Compatibility	B-1

C	Specifications	C-1
----------	-----------------------	------------

I N	Index	1
------------	--------------	----------

	Battery Charger Wall-Mounting Template	B-1
--	---	------------

Introduction

1

About TransTalk™ 9000 Products

Congratulations on the purchase of your new TransTalk 9000 Digital Wireless System **MDW 9031 Pocketphone**. MDW stands for "Multi-Line Digital Wireless." The MDW 9031 Pocketphone is the latest addition to the TransTalk 9000 family of wireless products, which also includes the MDW 9000 Telephone, the MDW 9010 Telephone and the MDW 9030P Pocketphone. All of these phones are designed to Lucent Technologies' high standards for convenience, reliability, and innovation.

TransTalk 9000 products are designed to work with your communications system (PARTNER®, PARTNER II, PARTNER Plus, PARTNER Advanced Communications System, MERLIN®, MERLIN II, MERLIN Plus, MERLIN LEGEND®, System 25, System 75, System 85, or DEFINITY®) to provide wireless flexibility.

What Is a Wireless Phone?

A wireless phone has no handset cord and no telephone line cord, so it is portable. This portability lets you move around freely, without giving up the features of a wired phone. With a wireless phone, you can make and receive calls even when you are away from your desk, thus remaining accessible and responsive to your customers and coworkers as you move around your work area. Time-sensitive work issues will not need to wait until you are back at your desk, and you can reduce the number of (sometimes costly) phone calls you must return.

TransTalk 9000 System

Your wireless phone's **handset** is linked with your communications system through a matching **radio module**, *not* through the **battery charger** where the handset sits for charging. Each handset can be used only with the radio module packaged with the handset. The handset and the radio module each have the same unique security code and serial number (on the bottom of the radio module and inside the battery compartment of the handset) to identify the matching pair. And there is built-in and secure automatic registration between the handset and radio module, so that your system is ready to use after powering up.

Your TransTalk system may have from 1 to 24 wireless phones. In order to use multiple wireless phones within the same zone (area of coverage), you also need a **carrier** (also known as a backplane). A carrier holds up to six radio modules, and synchronizes radio

signals for proper operation of multiple phones, ensuring consistent voice quality and range. If you have a key system (for example, PARTNER or MERLIN), you can link up to three carriers supporting up to 18 wireless phones in a single zone; if you have a PBX system (for example, DEFINITY), you can link up to four carriers, supporting up to 24 wireless phones in a single zone. Linked carriers are automatically synchronized with each other.

The TransTalk 9000 system enables you to use several different phone and carrier models in the same zone, but there are some compatibility issues to consider. You need to know the following:

- The name of the MDW phone (9000, 9010, 9030P, or 9031), located in the battery compartment of the handset. (For an MDW 9000 phone, you also need to know the Apparatus Code, also located in the battery compartment of the handset.)
- The model number of your carrier, located on the left side of the carrier.

The following illustrations show which phone models and carriers can be used together:

Single Carrier Installation

If you have a **Model 117A1 Carrier...**

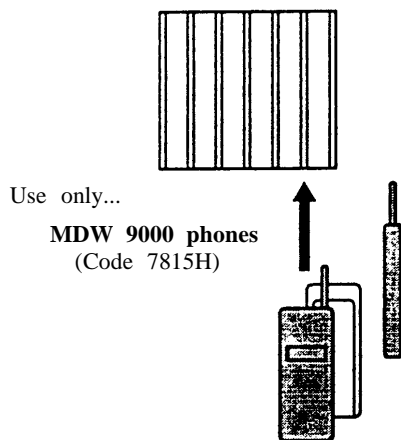

If you have a **Model 117A1A Carrier, Model 117A3 Carrier, or Model 117A4 Carrier...**

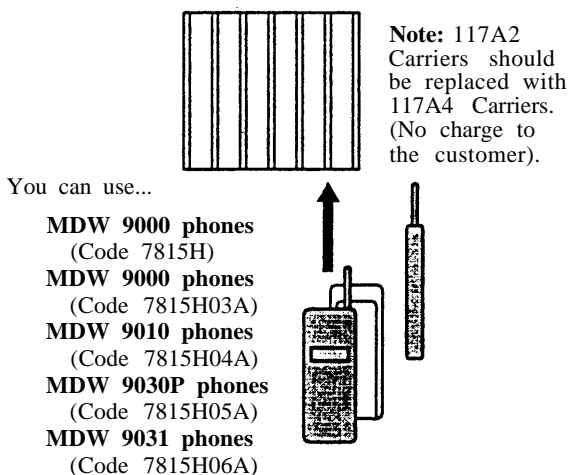

Note: 117A2 Carriers should be replaced with 117A4 Carriers. (No charge to the customer).

Note: You can use Code 7815H phones *together* with other phones *only* in a Model 117A1A, Model 117A3, or Model 117A4 *single* carrier installation.

Multiple (4 Max) Carrier Installation

If you have multiple **Model 117A3** or **Model 117A4 System Expansion Carriers** (or both)...

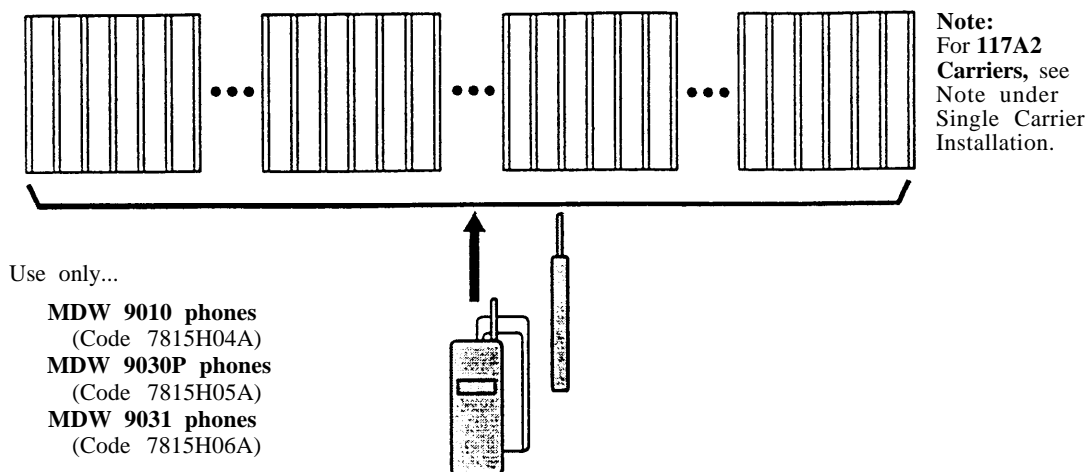

Note:
For **117A2 Carriers**, see Note under Single Carrier Installation.

Note: Multiple carrier installations *must* use MDW 9010 phones, MDW 9030P phones, and/or MDW 9031 phones. MDW 9000 phones cannot be used in multiple carrier installations.

About the MDW 9031 Pocketphone

The MDW 9031 Pocketphone is not only wireless, but it is also lightweight and pocket-sized. A removable carrying clip and a lanyard are provided with the handset. You can use either the clip or the lanyard for hands-free portability. The MDW 9031 also has a headset connector to accommodate an optional headset.

You can be notified of an incoming call by either an alerter (which rings) or a vibrator, or both. There is a five-line, user-activated backlighted display that shows information you would see on a wired system phone's display (with the exception of the time), icons representing various handset functions (such as the alerter and the vibrator), and the status of up to 12 telephone lines. The MDW 9031 provides Redial, Hold, Mute, Transfer, and Conference buttons, and provides the capability to program additional features on unused line buttons.

Privacy Information

The MDW 9031 Pocketphone is designed to protect the privacy and security of your voice conversation. The phone uses continuously changing radio frequencies and digital encoding techniques to make it impossible for eavesdropping to occur through the use of commercially available analog radio scanners.

Where Can You Use Your Pocketphone?

The MDW 9031 Pocketphone can be used in most typical office buildings, in warehouses, malls, and even in outdoor areas such as loading docks. **The location of the radio module greatly affects the performance of the MDW 9031. Read the "Positioning a Radio Module or Carrier(s)" section in Chapter 2 to determine the best place to install the radio module.** Repeat the tests several times with the radio module positioned in a different location each time. To perform the tests, all you need is an electrical outlet for the radio module and a charged battery pack in the handset.

Parts List

Along with this book and the *MDW 9031 Pocketphone Quick Reference*, the box should contain the items shown below. If it does not, call for customer support as described on the inside front cover of this book.

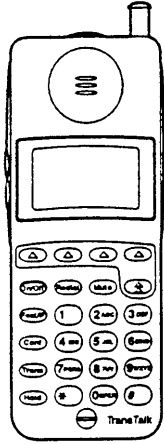

Handset

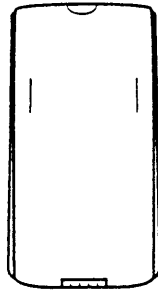

Battery Pack

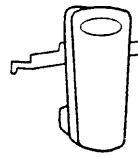

Carrying Clip

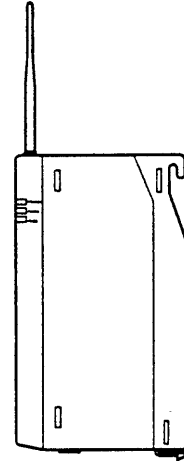

Radio Module

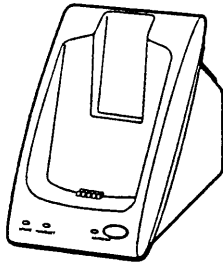

Battery Charger

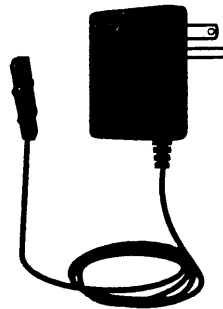

11-foot (3.4 m)
Power Cord/AC Adapter for
Battery Charger

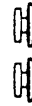

Wall Spacers (2)



Philips Head
Wood Screws (2)

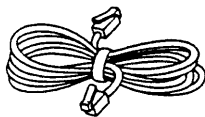

8-foot (2.4 m)
Telephone Line Cord

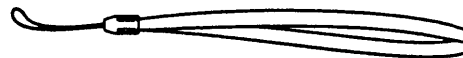

8' (0.5 m) Lanyard

Additional Parts

The following parts *may* be necessary, depending upon your installation.

This Kit of Parts is **required only when a single (stand-alone) MDW 9031 Pocketphone is installed:**

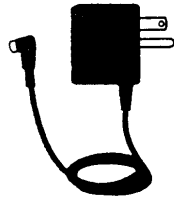

Radio Module 11-foot (3.4 m)
Power Cord/AC Adapter



Rubber Feet (4)



Philips Head
Wood Screws (2)

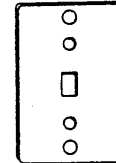

Wall Mounting
Plate

These additional parts are **required when two or more MDW 9031 Pocketphones are installed in the same zone:**

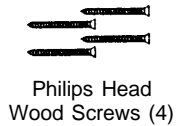

Philips Head
Wood Screws (4)

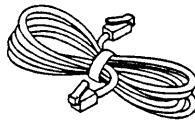

Expansion Cable 6-foot (1.8 m)
for multiple-carrier installation



Carrier Assembly 25-foot (7.6 m)
Power Cord and Standard AC Adapter

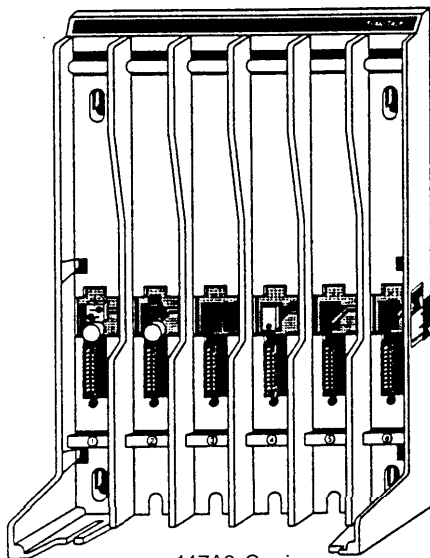

117A3 Carrier

or

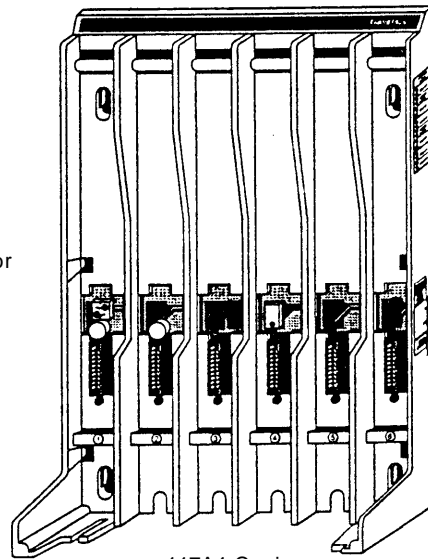

117A4 Carrier

For information about ordering parts, see "Ordering Replacement & Optional Parts" in Chapter 4.

Spare Battery and Headset

One nickel metal hydride battery pack, which provides up to 3 hours of talk time, comes with your MDW 9031 Pocketphone. For extended phone usage, you should purchase an additional battery pack. If you require full business-day use, you can purchase an extended battery pack. Although thicker and heavier than the standard battery pack, the extended battery pack provides 8–9 hours of talk time when fully charged. You can store the extra battery pack in the Spare battery compartment of the battery charger. Then when the battery pack in the handset is low, you can switch battery packs.

To help you answer calls, an optional Supra® 9031 headset or a Radium (over the ear) headset can be attached to a quick-disconnect adapter cord, which you can insert into the connector on the bottom of the handset to allow hands-free conversation. For instructions for connecting the headset, see "Using a Headset" in Chapter 3.

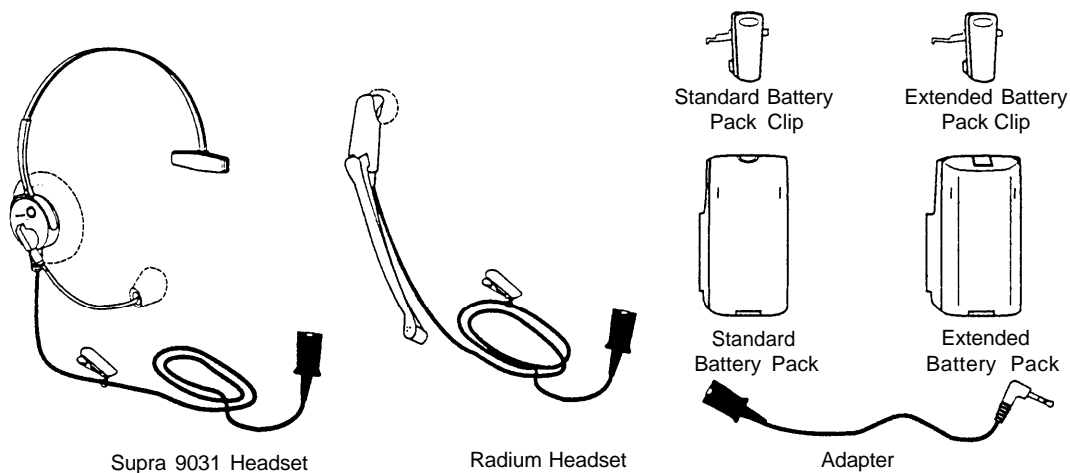

For ordering information, see "Ordering Replacement & Optional Parts" in Chapter 4.

Installing the MDW 9031 Pocketphone

2

Important Safety Instructions

This book contains instructions related to safety labels on the product:

- ▲ **The exclamation point within an equilateral triangle is intended to alert the user to the presence of important operating and maintenance (servicing) instructions in the literature accompanying the product.**
- ▲ **WARNING** indicates the presence of a hazard that can cause severe or fatal personal injury if the hazard is not avoided.
- ▲ **CAUTION** indicates the presence of a hazard that will or can cause minor personal injury or property damage if not avoided.

This phone is designed to provide trouble-free performance without any special maintenance procedures. To reduce the risk of accidental damage:

- Keep the phone in an area free of dust, smoke, and moisture; do not block the air vents by placing objects on top of the radio module.
- Do not place the phone or battery charger near a heating duct, radiator, or other heat source, and do not drop or expose it to excessive shock or vibration.
- Unplug the battery charger, radio module, or carrier if its power cord is damaged, if liquid is spilled into it, or if its housing becomes cracked or otherwise damaged.
- To clean your phone, wipe the outside housing with a soft, dust-free cloth. If absolutely necessary, you may use a cloth *slightly* dampened with a mild soap and water solution. Dry quickly with a soft cloth.

- ▲ **CAUTION:**
Your phone contains sensitive electronic parts. Never submerge it in any kind of liquid, and never use liquid or aerosol cleaners, detergents, alcohols, solvents, abrasive cleaners, or an excessive amount of water when cleaning the housing and faceplate. To do so could result in irreparable damage.

Guidelines for Safe and Efficient Operation

Your wireless telephone is a radio transmitter and receiver. When the phone is turned on, it receives and sends out radio frequency (RF) energy. The phone operates in the frequency range of 902–928 MHz. Your hand-held wireless telephone uses the digital TDD mode. The power is transmitted in bursts at a 200 Hz pulsed repetition rate. The peak envelope transmit power is 325 mW or less.

Exposure to Radio Frequency Energy

The design of your wireless telephone complies with the latest Institute of Electrical and Electronic Engineers (IEEE) and the American National Standards Institute (ANSI) safety levels with respect to human exposure to RF energy. Of course, if you would like to limit RF exposure even further, you may choose to control the duration of your calls.

Cardiac Pacemakers

▲ CAUTION:

The MDW 9031 handset is a radio device and, like all radio devices, should not be placed next to a pacemaker.

Preliminary studies performed at the US Food and Drug Administration (FDA) and elsewhere have shown that when digital cellular telephones are placed very close to implanted cardiac pacemakers, interference with the operation of the implanted pacemaker can occur. These preliminary studies show that interference does not occur when there is a reasonable distance between the telephone and the implanted pacemaker and stops when the phone is turned off or moved so that it is more than 6 inches (15 cm) from the pacemaker. Digital cellular telephones operate at .6 W. TransTalk wireless telephones operate at a lower peak power of 325 mW or less (100 mW, on an average).

Until more is known, the FDA suggests that people with pacemakers may want to take some simple precautions when using or carrying digital wireless telephones to ensure that there is ample distance between the digital wireless telephone and the pacemaker—by not placing the phone next to the pacemaker implant (for example, in a shirt or a coat pocket directly over the pacemaker implant) when the phone is on and ready to receive a call and holding it to the ear opposite the side of the body where the pacemaker is implanted when using the phone. Consult your physician or medical device manufacturer to determine if additional precautions are necessary.

Hearing Aid Compatibility

Most electronic equipment, such as equipment in hospitals is shielded from RF energy. However RF energy from wireless telephones may affect some electronic equipment.

Although the TransTalk wireless telephone is compatible with inductively-coupled hearing aids, you should consult your physician or hearing aid manufacturer to determine if your hearing aid is adequately shielded from external RF energy. The operation of inadequately shielded medical devices may be adversely affected when a portable wireless telephone is operating in close proximity.

Basic Safety Precautions for Installation and Use

Always follow these basic safety precautions when installing or using this product to reduce risk of injury from fire or electric shock.

⚠ WARNING:

Installation of this equipment for In-Range Out of Building (IROB) conditions requires the use of protectors. See the documentation that came with your communications system for more information.

⚠ CAUTION:

This equipment is for installation on Lucent Technologies PARTNER, PARTNER Plus, PARTNER II, PARTNER Advanced Communications System, MERLIN, MERLIN Plus, MERLIN II, MERLIN LEGEND, System 25, System 75, System 85, and DEFINITY communications systems only.

- Read and understand all instructions in this book before using this product.
- Observe all warnings and instructions marked on the product.
- Do not use the product near water or when you are wet. If the product comes in contact with any liquids, unplug the power cord and telephone line cords immediately. Do not plug the product back in until it has dried thoroughly.
- Never push objects of any kind into this product through housing slots, since the objects may touch hazardous voltage points or short out parts that could result in a risk of electric shock. Never spill liquid of any kind on the phone.
- If you suspect a gas leak, report it immediately, but use a phone away from the area in question. The phone's electrical contacts could generate a tiny spark. While unlikely, it is possible that this spark could ignite a heavy concentration of gas. This product is not approved for use in areas labeled by the Occupational Safety and Health Administration (OSHA) as "explosive environments." Only "Explosive Atmosphere Telephones" may be used in such hazardous environments.
- Unplug this product from wall outlets and telephone jacks before cleaning. Clean exposed parts with a soft, damp cloth. Do not use liquid or aerosol cleaners.
- Unplug this product from the wall outlet, remove the telephone line cord from the modular wall jack or communications system switch/control unit, and refer servicing to qualified service personnel under the following conditions:
 - When the power cord or plug is damaged or frayed.
 - If the product does not operate normally by following the operating instructions. Adjust only those controls that are covered by the operating instructions because improper adjustment of other controls may result in damage and will often require extensive work by a qualified technician to restore the product to normal operation.
 - If the product has been dropped and the housing has been damaged.
- This product should be serviced by (or taken to) a qualified service center when service or repair work is required. Do not open the product, there are no user-serviceable components inside.
- Always unplug the power cord/AC adapter for the carrier or carriers from the wall outlet when:
 - Removing a radio module
 - Moving a radio module to a new slot in the carrier

-
- Installing a new radio module
 - Connecting or disconnecting telephone line cords
 - Adding a carrier
 - Use only the type of battery pack shipped with this product or sold as an optional part. (See "Ordering Replacement & Optional Parts" in Chapter 4.)



WARNING:

The rechargeable battery pack may contain elements that are harmful to the environment (for example, nickel). Do not burn or puncture the battery pack. Like other batteries of this type, if it is burned or punctured, it could release toxic material which could cause injury. Do not dispose of it in household garbage. For information about recycling or proper disposal, consult your local solid waste (garbage) collection or disposal organization.

**Additional Safety Instructions
for Installation Personnel**

- Install the product to meet all environmental and electrical requirements listed in Appendix C.
- All wiring that connects to this equipment and becomes part of the building wiring must be a minimum of CLASS 2 or UL (Underwriters Laboratories) Listed Communications cable.
- Do not install telephone wiring during a lightning storm.
- Do not install telephone jacks in a wet location unless the jack is specifically designed for wet locations. Never touch uninsulated telephone wires or terminals unless the telephone line has been disconnected at the network interface.
- Use caution when installing or modifying telephone lines.
- Install this product securely on a stable surface. Damage may result if the product falls.
- Never place this product near or over a radiator or heat register.
- Slots and openings in the housing and the back or bottom are provided for ventilation. To protect the housing from overheating, these openings must not be blocked or covered. Therefore, do not place the product on a bed, sofa, rug, or other similar surface. Also, do not place this product in an enclosed area unless proper ventilation is provided.
- Install this product in a protected location where no one can step on or trip over power cords and telephone line cords. Do not place objects on the cords that may cause damage or abrasion.
- Do not allow anything to rest on the power cord. Do not locate this product where the cord will be abused by persons walking on it. Do not overload wall outlets as this can result in the risk of fire or electric shock. Do not staple or otherwise attach the power cord to building surfaces.
- Use only the power supply (Comcode 847713583) shipped with this product for the battery charger.
- Use only the power supply (Comcode 847523404) shipped with this product for the radio module.

- Use only the power supply (Comcode 847224227) shipped with the carrier.
- Use only the correct power source. If you are not sure of the power supply to your location, consult your local power company.
- This product uses a 3-prong plug. Such plugs are designed for your safety. Do not attempt to defeat this purpose. If your wall outlet will not accept the plug, the outlet should be replaced by an electrician.

⚠ WARNING: Risk of Electric Shock

Failure to properly ground this product will result in a risk of electrical shock, which can cause serious personal injury. This product requires a 3-prong AC outlet for safe operation. You should have your outlet checked by a qualified electrician (see "AC Outlet Check" below) before connecting this equipment.

AC Outlet Check

Have a qualified electrician check all of the outlets into which the MDW 9031 radio modules or carriers as well as the communications system switch/control unit will be plugged. The electrician should check that the hot, neutral, and ground wires are properly connected to the outlet by using a circuit tester.

The outlet can also be tested using a voltmeter by taking the measurements as shown:

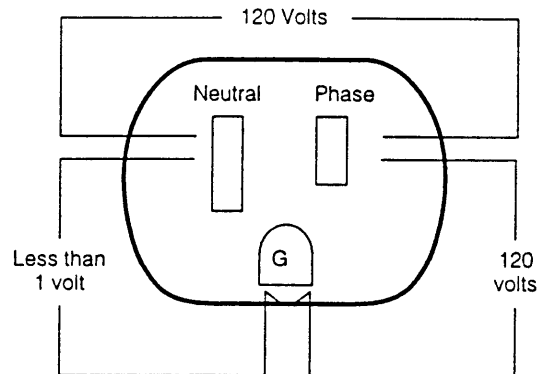

If the outlet does not meet the electrical specifications for grounded outlets, your MDW 9031 Pocketphone may not operate properly.

IMPORTANT:

If there is no current to the outlet or the voltages are not correct, the problem should be corrected by a qualified electrician.

[Go to "Installation Overview for Radio Modules and Carriers."](#)

Installation Overview for Radio Modules and Carriers

This section explains how to install radio modules and carriers. You should proceed through this section in the following order:

1. "Radio Module/Switch Wiring"
2. "Key Components"
3. "Positioning a Single Radio Module or Carrier(s)"
4. "Wireless Test Mode" (in Chapter 3)
5. Choose one of the following paths, depending upon which components you are installing:
 - If you are installing **single radio module**, go to "Installing a Single Radio Module."
 - If you are installing **one or more carriers** (from two to 24 radio modules), go to "Understanding Carriers."

NOTE:

The illustrations in this chapter depict PARTNER system hardware; your hardware may differ from these illustrations.

Radio Module/Switch Wiring

If your installation requires some customized wiring, the technician should match the Pin numbers with the switch interfaces as shown in the following table:

Switch Interface	Pin #
ATL (MERLIN, DEFINITY)	1, 2
ETR (PARTNER)	3, 6
T/R (Tip/Ring)	5, 4

Key Components

Each **radio module** communicates with a corresponding handset. The matching sets are identified by a serial number located on the bottom of the radio module and in the battery compartment of the handset.

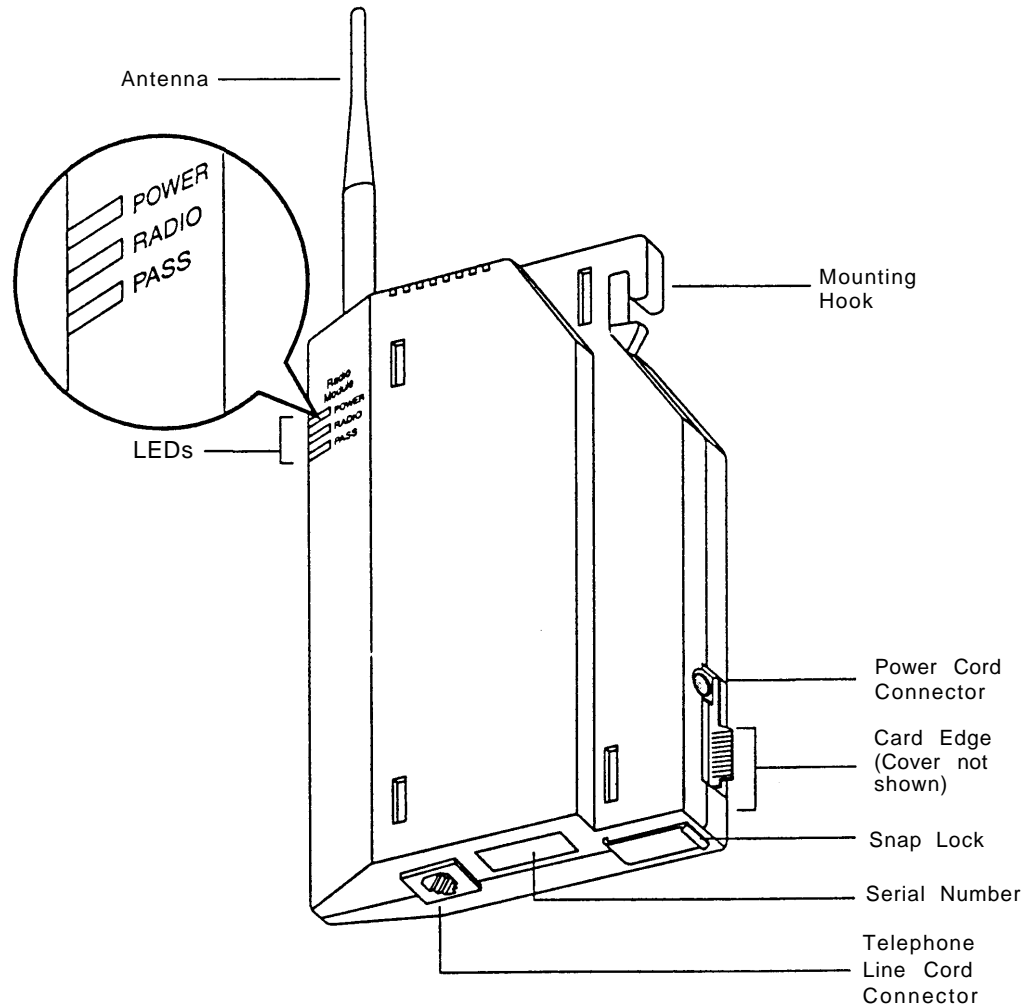

A **carrier** (Model 117A3 or Model 117A4) is required when installing two or more MDW 9031 Pocketphones.

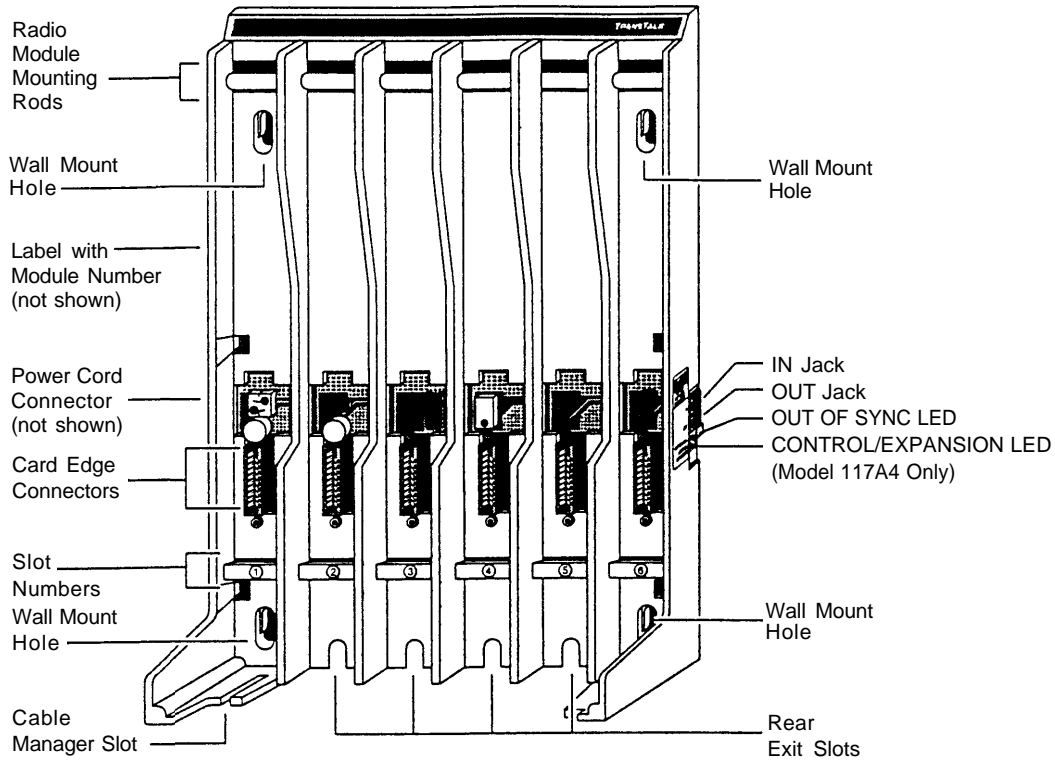

Using the **expansion cable** provided with each carrier, you can link up to four carriers.

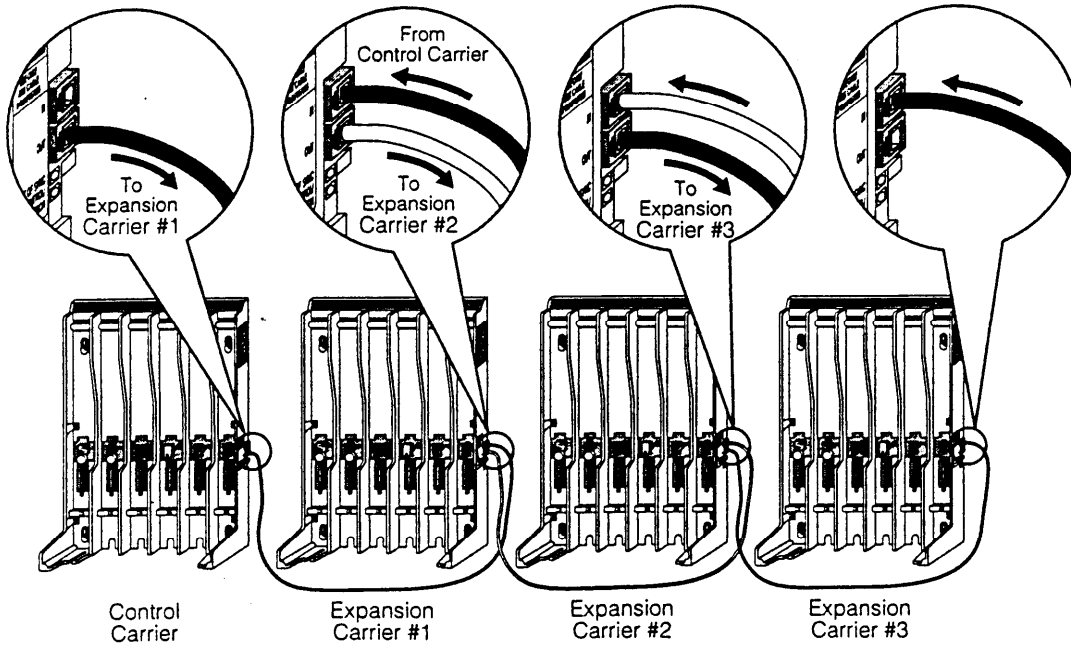

Positioning a Radio Module or Carrier(s)

Each of your handsets and its corresponding radio module operates within a single zone of coverage:

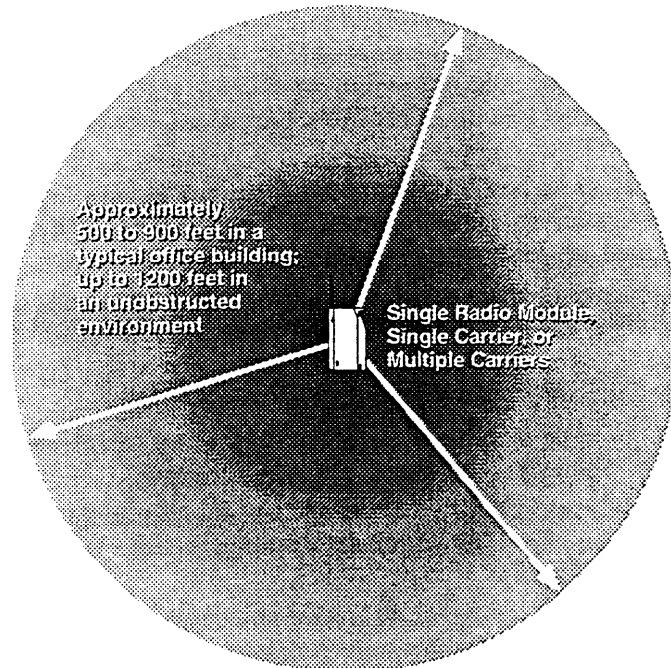

The range depends on your particular operating environment. For indoor use, walls between the handset and the radio module will reduce the phone's range. Avoid concentrations of structural metal, such as steel and aluminum, and reinforced concrete.

IMPORTANT:

The MDW 9031 Pocketphone has a built-in testing feature that you can use before final installation to help determine proper placement of the radio module. To perform the tests, all you need is an electrical outlet for the radio module and a charged battery pack in the handset (you do not need a communications system switch/control unit). The tests are described in "Wireless Test Mode" in Chapter 3.

General Positioning Rules

Failure to observe the following rules regarding location and use will result in poor performance of your MDW 9031 Pocketphone.

- Position the radio module or carrier(s) in a central location, relative to the handset(s) usage area, leaving at least **6 feet (1.8 m)** between the radio module or carrier(s) and the communications system switch/control unit or other wired phones. If your switch/control unit is located in a remote location, you may have to run a telephone line cord from your switch/control unit to the centrally positioned radio module or carrier(s). The line cord maximum length is 1,000 feet (305 m) of 26-gauge cable.
- The radio module or carrier(s) should be placed high on the wall for optimum voice quality and range. Allow 6–12 inches (15.2–30.5 cm) of space between the top of the antenna on the radio modules and the ceiling.
- The radio module or carrier(s) should never be installed above a drop, suspended ceiling.

-
- The radio module or carrier(s) should not be within 3 feet (.9 m) of any large metal object, and should not have metal objects in the line of sight to the operating area of the handset.
 - **The radio module or carrier(s) should not be within 6 feet (1.8 m) of equipment with microprocessors such as answering machines, personal computers, and fax machines; control units, communications system switches, or other phones (especially speakerphones); competing radio devices such as wireless bar-code scanners; electromagnetic equipment such as electric motors; or electrical main power feeds, junction boxes, circuit-breaker panels, fuse boxes, or 220-volt power lines.**
 - The radio module or carrier(s) should *not* share the same power line as equipment with microprocessors such as answering machines, personal computers, and fax machines; or electromagnetic equipment such as electric motors.
 - If your communications system uses an uninterruptible power supply, such as a backup generator, you may want to connect the radio module or carrier(s) to that power supply.

Additional Rules for Installing a Single Radio Module Only

- Installing a single radio module on a shelf or desk is not recommended, because it greatly reduces the range and quality of the transmission.
- Install a single radio module within 3 feet (0.9 m) of either side of, and within 6 to 8 feet (1.8 to 2.4 m) above, a properly grounded 3-prong electrical outlet that is not controlled by an on/off switch.
- You can install a single radio module in a remote location using a telephone line cord to connect the radio module to the communications system switch/control unit. **IROBs must be used for out-of-building installations.**



CAUTION:

A radio module cannot be installed outdoors.

Additional Rules for Installing One or More Carriers

- Install carrier(s) within 15 feet (5 m) of either side of, and within 6 to 8 feet (1.8 to 2.4 m) above, a properly grounded 3-prong electrical outlet that is not controlled by an on/off switch.
- **Choose a location where handset users will not approach the carrier(s) within a radius of 6 feet (1.8 m) for 1 or 2 carriers or 10 feet (3 m) for 3 carriers.**
- When installing multiple carriers:
 - Install multiple carriers 1 foot (0.3 m) optimally to 4 feet (1.2 m) apart.
 - Install multiple carriers on the same horizontal axis (do not install one carrier higher or lower than another).
 - Install the control carrier as the leftmost carrier, using only the expansion cables provided.
 - Slot 6 of an 117A3 control carrier must always contain a radio module to pass the synchronization signal to the next carrier.



CAUTION:

Carrier(s) cannot be installed outdoors.

Go to **"Wireless Test Mode"** in Chapter 3.

Installing a Single Radio Module

- Install high on wall, leaving 6–12 inches (15.2–30.5 cm) between antenna and ceiling
- See "Key Components" earlier in this chapter for additional picture detail

1 Perform the tests described in "Wireless Test Mode" in Chapter 3 to determine the optimal placement of the radio module. To perform the tests, all you need is an electrical outlet for the radio module and a charged battery pack in the handset.

2 Check to make sure the radio module's power cord is unplugged from the wall outlet before continuing.

3 Detach the rubber feet from the shipping card. Apply them to marked areas on the underside of the radio module.

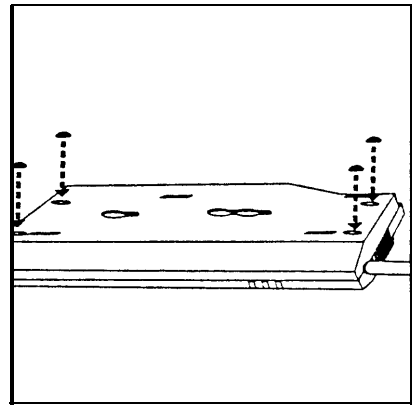

4 Place the wall-mounting plate against the wall. Choose a location backed by a wooden stud (if unavailable, use toggle bolts instead of the supplied wood screws). Lightly tap a nail into the wall to start holes. Then screw the plate flush to the wall. Place the radio module over the plate, then slide it downward to lock it into place. **(Note: Do not remove the plastic cap covering the radio module's card edge.)**

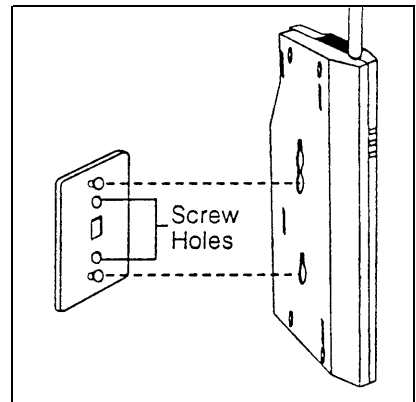

5 Insert one end of the telephone line cord into an extension jack or terminal/station connector on your communications system switch/control unit (refer to your communications system manual for the proper location).

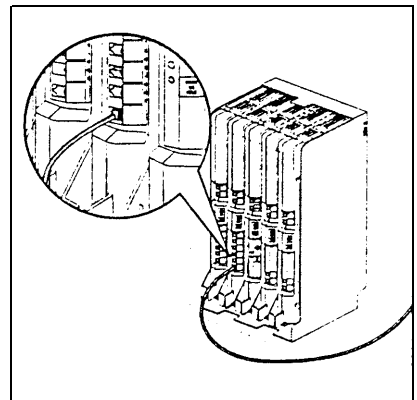

- 6** Insert the radio module's power cord into the side of the radio module. Insert the other end of the telephone line cord into the bottom of the radio module.

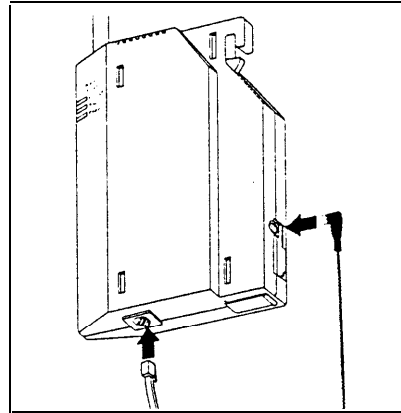

- 7** Plug the power cord/AC adapter into a properly grounded 3-prong wall outlet that is not controlled by an on/off switch.

⚠ CAUTION: *Never connect or disconnect the telephone line cord while the radio module is plugged into the wall outlet.*

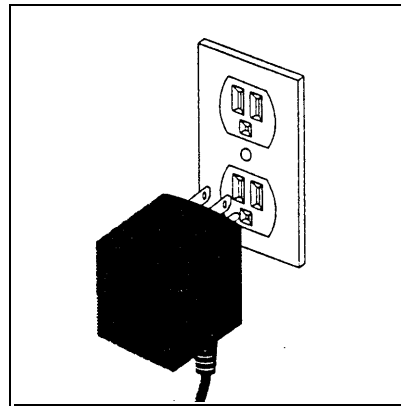

Single Radio Module Installation Self Test

Verify that the **POWER** and **PASS** LEDs on the radio module light. If the radio module's **PASS** LED does not light:

- 1** Unplug the power cord/AC adapter from the wall outlet.
- 2** Wait 15 seconds.
- 3** Plug it in again.

If the radio module's **PASS** LED still does not light, refer to Chapter 5, "Troubleshooting."

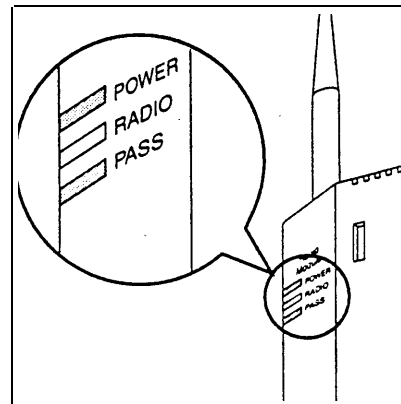

NOTE:

The **RADIO** LED also may light upon installation; however, since the **RADIO** LED has no significance during installation, ignore its operation.

The **RADIO** LED indicates a connection between the handset and the radio module; it lights when the handset is being used as long as the battery pack in the handset is charged.

Understanding Carriers

When you install more than one radio module in a single zone, you must mount the radio modules in a carrier, so that their signals will be synchronized. A carrier can hold up to six radio modules. The MDW 9031 Pocketphone is designed to work with any of three carrier models: Model 117A1A, Model 117A3, and Model 117A4.

NOTE:

If you currently own a Model 117A2 carrier, Lucent Technologies will replace it with a Model 117A4 at no charge.

If you want to install more than six radio modules, you will need more than one carrier. Systems configured as key systems (for example, PARTNER or MERLIN) can accommodate up to 18 radio modules (three carriers); PBX systems can accommodate up to 24 radio modules (four carriers).

In any multiple-carrier installation, the leftmost carrier acts as the *control* carrier, and the remaining carriers act as *expansion* carriers, passing along the synchronization signal from the control carrier. Multiple carrier installations require that you use Model 117A3 or Model 117A4 carriers, or both.

The Model 117A3 and Model 117A4 carriers are similar in general appearance, but the installation procedure for the two models differs somewhat. A label on the left side of the carrier identifies the carrier model number.

If you are installing **one model** of carrier, go to **one** of the following sections:

- If installing a Model 117A3 carrier, go to "**Understanding Your Model 117A3 Carrier.**"
- If installing a Model 117A4 carrier, go to "**Understanding Your Model 117A4 Carrier.**"

If you are installing **both carrier models**, read **both** of these sections.

Understanding Your Model 117A3 Carrier

The installation of a Model 117A3 carrier differs in three ways from the installation of a Model 117A4 carrier:

- You may need to adjust the power DIP switch.
- You *must* set the Control/Expansion DIP switch.
- If you use the 117A3 as the *control* carrier, you *must* have a radio module installed in Slot 6 of that carrier in order to pass the synchronization signal on to the next carrier.

As the following illustration shows, each Model 117A3 carrier has two user-adjustable DIP switches, one in Slot 2 that controls the power levels, and another in Slot 4 that specifies whether this particular carrier is functioning as a control or an expansion carrier.

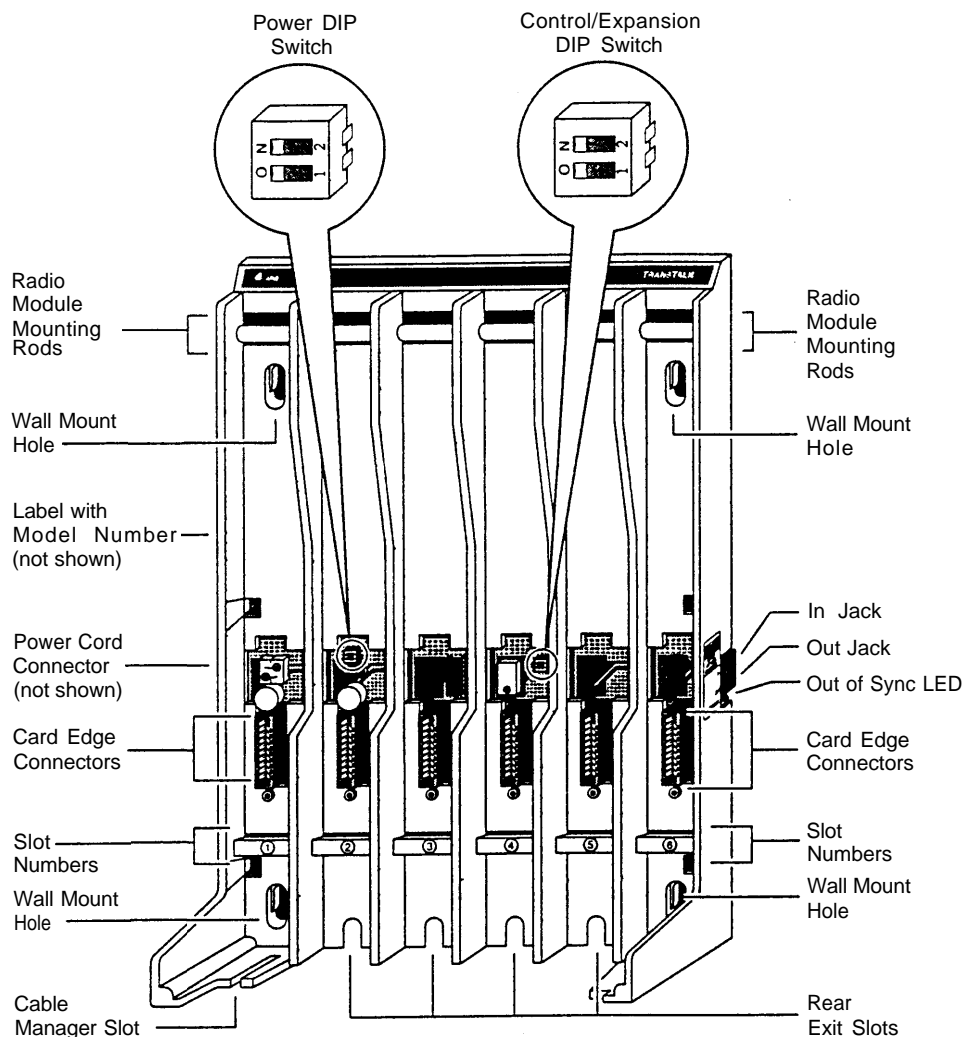

If you are installing one or more 117A3 carriers in a strip mall, high-rise office building, or similar environment, the MDW 9031 Pocketphones may interfere with other wireless products in use. If this is the case, you can adjust the range of the 117A3 carrier(s) to prevent overlapping with the other wireless products.

- Go to **one** of the following sections:
- To adjust the 117A3 carrier's range, go to "**Setting the 117A3 Carrier Power Level.**"
 - To skip that section, go to "**Setting the 117A3 Carrier Control/Expansion DIP switch.**"

Setting the 117A3 Carrier Power Level

If your MDW 9031 Pocketphones are interfering with other wireless products in use, or if you anticipate that they will, you can adjust the carrier's range by setting each 117A3 carrier's power DIP switch, located in Slot 2.

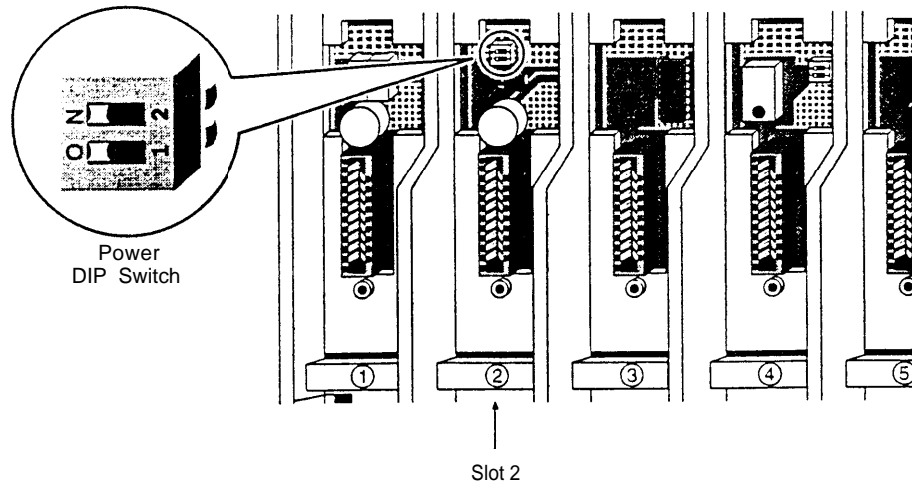

The Power DIP switch must be adjusted while the carrier is without power and while Slot 2 is empty. You can adjust it before mounting the carrier on the wall.

Use a nonmetallic, pointed object to set each carrier's DIP switch according to the following table.

IMPORTANT:

You *must* set the DIP switch for all of the 117A3 carriers to the same setting.

Desired Range (Approximate)	Power DIP Switch Settings
500 to 900 feet (152 to 274 m)	
300 to 500 feet (91 to 152 m)	
150 to 300 feet (46 to 91 m)	
100 to 150 feet (31 to 46 m)	

Go to "Setting the 117A3 Carrier Control/Expansion DIP Switch."

Setting the 117A3 Carrier Control/Expansion DIP Switch

The Model 117A3 carrier can serve as either a control or an expansion carrier. Whether you install one or more 117A3 carriers, you must set the Control/Expansion DIP switch in Slot 4 of each 117A3 carrier to indicate which role that carrier is filling.

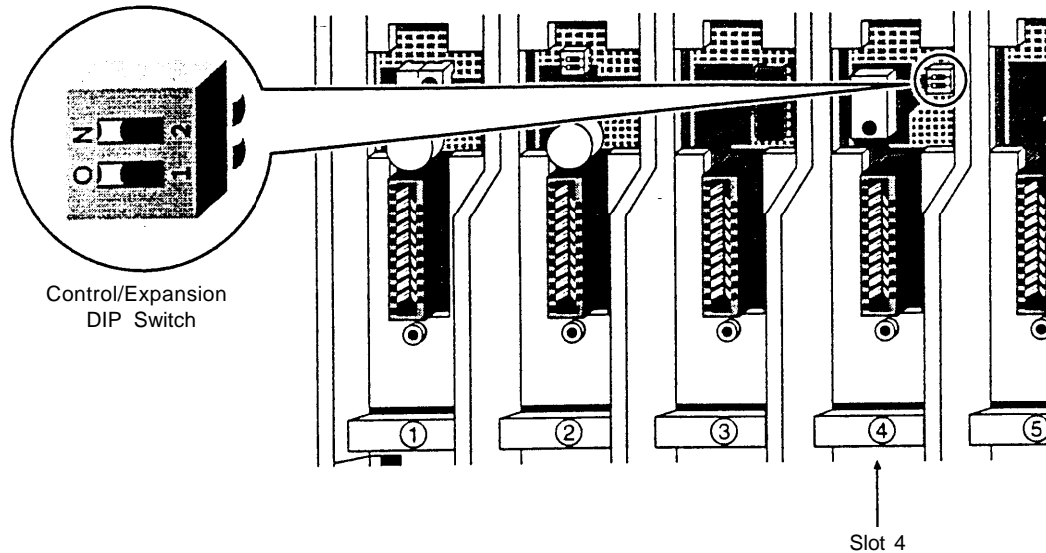

The leftmost carrier, no matter what model number it is, must be the *control* carrier, and the remaining carriers are *expansion* carriers. The control carrier acts as the "lead" carrier—its transmit and receive patterns control the expansion carriers, ensuring that all of the linked carriers function as a single system.

It is recommended that you determine which carrier is to be the control carrier, and which, if any will be expansion carriers, and set the Control/Expansion DIP switch(es) before mounting the carrier(s) on the wall.

Use a nonmetallic, pointed object to set each 117A3 carrier's DIP switch according to the following table.

IMPORTANT:

Only one carrier (the leftmost carrier) can be the control carrier; the other carriers must be expansion carriers.

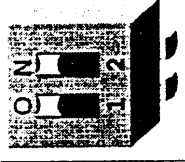
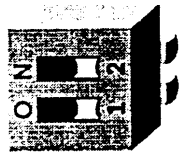
To designate the carrier as a...	Use this setting for the DIP switch...
control carrier (one carrier only)	 A photograph of a carrier's DIP switch panel. The top switch is labeled 'N' on the left and '2' on the right, and is currently in the '2' position. The bottom switch is labeled 'O' on the left and '1' on the right, and is currently in the '1' position.
expansion carrier (one or <u>more</u> additional carriers)	 A photograph of a carrier's DIP switch panel. The top switch is labeled 'N' on the left and '2' on the right, and is currently in the '2' position. The bottom switch is labeled 'O' on the left and '1' on the right, and is currently in the '1' position.

Go to **one** of the following:

- If you are *also* installing **one or more 117A4 carriers**, go to "**Understanding Your Model 117A4 Carrier.**"
- If you are installing a **single 117A3 carrier**, go to "**Installing a Single Carrier.**"
- If you are installing **multiple 117A3 carriers**, go to "**Installing Multiple Carriers.**"

Understanding Your Model 117A4 Carrier

The Model 117A4 carrier differs from the 117A3 in that it does *not* require that Slot 6 contain a radio module in order to pass the signal from the control carrier to the next carrier. It also does not have Power and Control/Expansion DIP switches to set. The 117A4 automatically adjusts its power level and senses whether it is being used as a control or an expansion carrier.

As the following illustration shows, the 117A4 does have an additional LED located on the right side of the carrier, the **CONTROL/EXPANSION LED**, used for determining whether the cabling was installed correctly.

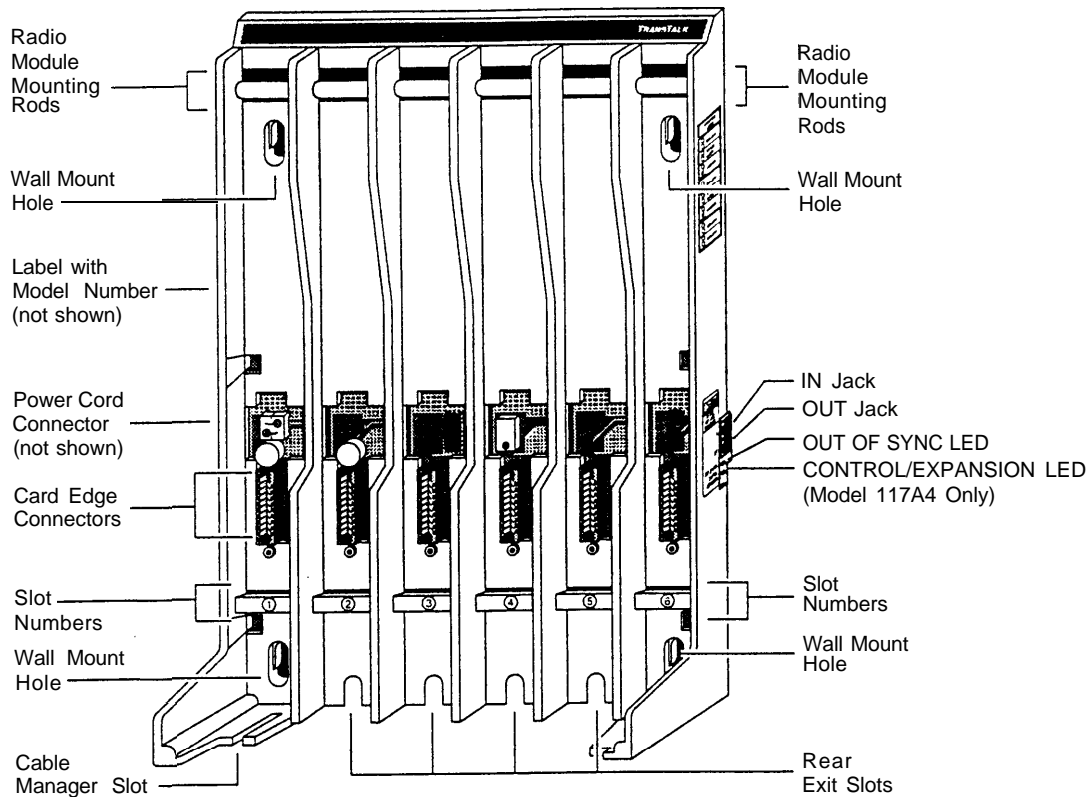

The following chart explains the label that identifies the jacks and LEDs on the 117A4 carrier. (The IN and OUT jacks and the OUT OF SYNC LED also appear on the 117A3 carrier.)

Label	Explanation
IN	Designates the modular jack that accepts the modular plug and cable from the preceding carrier to the left. If the jack is in use, this carrier is an "Expansion" carrier.
OUT	Designates the modular jack that accepts a modular plug and cable to connect this carrier to the next carrier to the right. This carrier can be either a "Control" carrier (if it is the leftmost carrier) or an "Expansion" carrier.
OUT OF SYNC	Designates the upper of two LEDs. If the LED is not lit, there is no problem. If the LED glows red, the carrier is out of synchronization. The problem must be corrected. See Chapter 5, "Troubleshooting. "
CONTROL/ EXPANSION	Designates the lower of two LEDs. The color of the LED indicates the carrier configuration: Control carrier = green LED Expansion carrier = amber LED The light pattern indicates whether the carrier is operational: Glowing steadily = no problem Blinking = no radio modules(s) in the carrier.

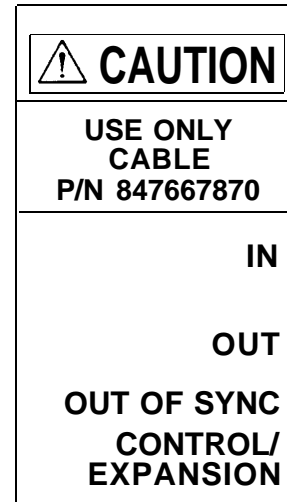

The label at the top of the right side of the carrier is provided to help you interpret the LED lights. The first three lines on this label refer to LEDs on the the control carrier; the next three lines refer to the LEDs on each of the expansion carriers; and the last two lines apply to all carriers.

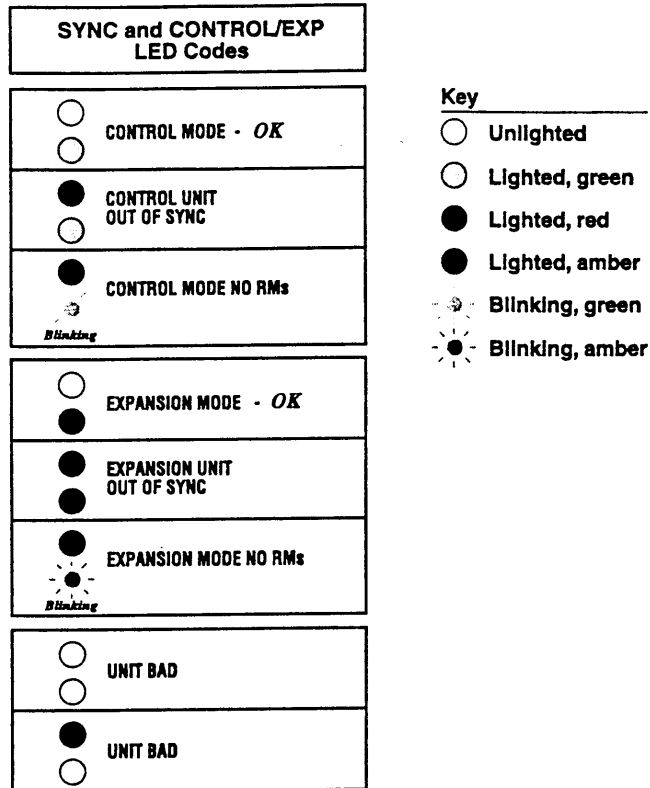

Go to **one** of the following:

- If installing a **single carrier**, go to "Installing a Single Carrier."
- If installing **multiple carriers**, go to "Installing Multiple Carriers."

Installing a Single Carrier

If you are installing a **Model 117A3 carrier**, be sure you have read the following sections and have set the DIP switches:

- "Understanding Your Model 117A3 Carrier"
- "Setting the 117A3 Carrier Power Level"
- "Setting the 117A3 Carrier Control/Expansion DIP Switch"

Then go to **one** of the following:

- "Installing a Single Carrier on a Shelf or Desk" or
- "Installing a Single Carrier on a Wall"

If you are installing a **Model 117A4 carrier**, be sure you have read "Understanding Your Model 117A4 Carrier." Then go to **one** of the following:

- "Installing a Single Carrier on a Shelf or Desk" or
- "Installing a Single Carrier on a Wall"

Installing a Single Carrier on a Shelf or Desk

- You will not receive optimum performance if unit is placed on a desk or low shelf
- Install as high as possible, leaving 6–12 inches (15.2–30.5 cm) between antennas and ceiling if on high shelf
- Never install or remove a radio module from a carrier that is plugged into a wall outlet (hot insertion)
- See "Key Components" earlier in this chapter for additional picture detail

1 Perform the tests described in "Wireless Test Mode" earlier in this chapter to determine the optimal placement of the radio module. To perform the tests, all you need is an electrical outlet for the radio module and a charged battery pack in the handset.

2 Check to make sure the carrier's power cord is unplugged from the wall outlet before continuing.

3 Remove the plastic cap covering each radio module's card edge before installing the radio modules in the carrier.

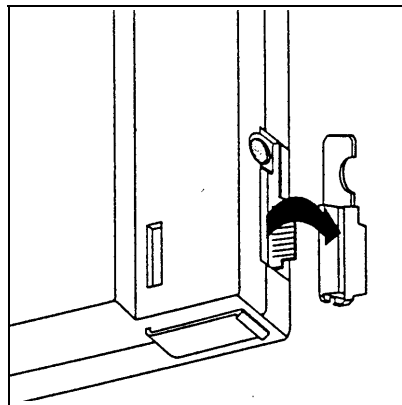

4 Starting from the leftmost slot (#1), insert each radio module into the carrier by hooking it onto the radio module mounting rod. Slowly swing the radio module's card edge into the card edge connector on the back of the carrier.

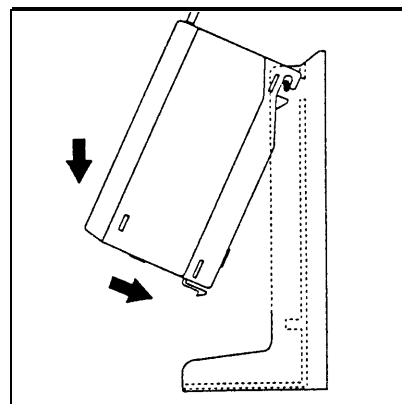

- 5** When the card edge is fully seated, a snap lock on the bottom of the radio module will engage.

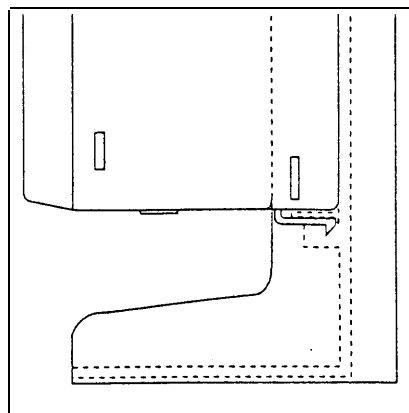

- 6** Insert a telephone line cord into the bottom of each radio module.

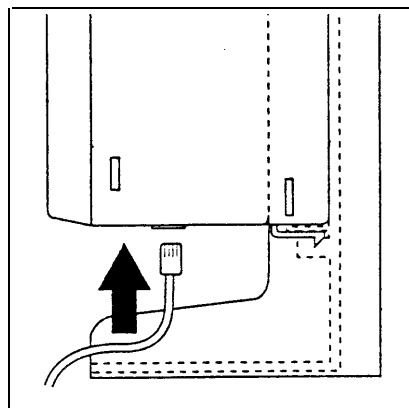

- 7** Slide the telephone line cords through the rear exit slots on the bottom of the carrier. Cords originating from Modules 1 and 6 can share exit slots with cords from Modules 2 and 5 respectively.

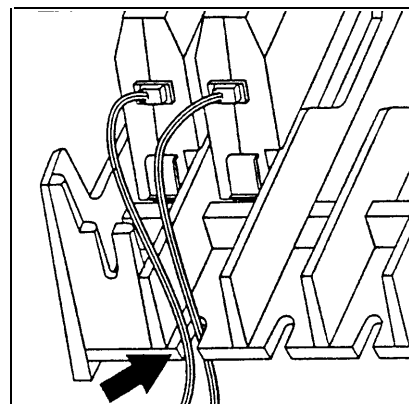

- 8** Insert the free end of the telephone line cord into the appropriate extension jack or terminal/station connector on your communications system switch/control unit (refer to your communications system manual for the proper location).

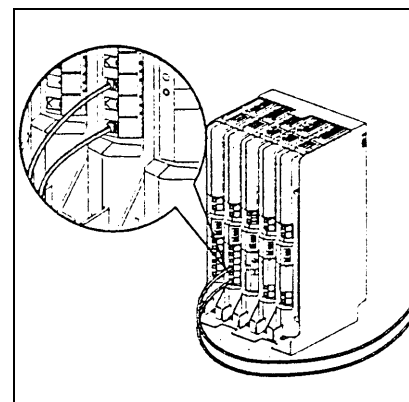

- 9** Insert the carrier's AC adapter cord into the left side of the carrier.

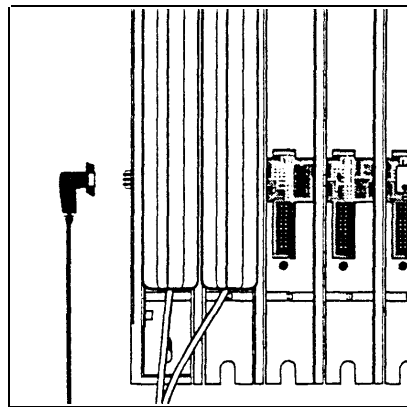

- 10** Place the carrier on its feet towards the back of the shelf or desk, making sure it is in a stable position. Be sure the telephone line cords come out the rear exit slots in the back of the unit. Arrange the power cord and telephone line cords beneath the shelf or desk so no one can step on them or trip over them.

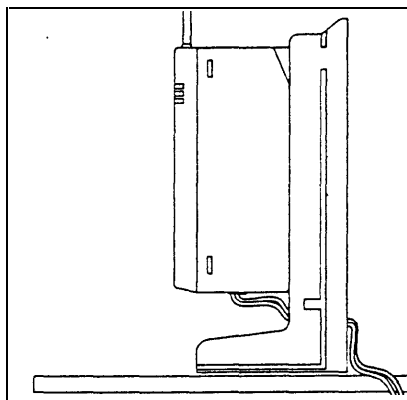

- 11** Insert the carrier's power cord into the AC adapter, then plug the power cord into a properly grounded 3-prong wall outlet that is not controlled by an on/off switch.

If appropriate, you can wall-mount the AC adapter using its attached wall-mounting bracket.

- ⚠ CAUTION:**
Never connect or disconnect telephone line cords, or insert or remove radio modules, while the carrier is plugged into the wall outlet.

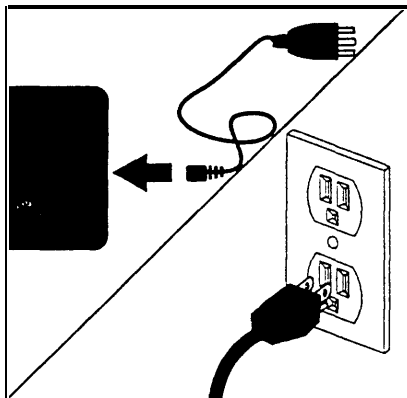

Go to "**Single Carrier Installation Self Test.**"

Installing a Single Carrier on a Wall

- Install high on wall, leaving 6–12 inches (15.2–30.5 cm) between antennas and ceiling
- Never install or remove a radio module from a carrier that is plugged into a wall outlet (hot insertion)
- See "Key Components" earlier in this chapter for additional picture detail

1 Perform the tests described in "Wireless Test Mode" in Chapter 3 to determine the optimal placement of the radio module. To perform the tests, all you need is an electrical outlet for the radio module and a charged battery pack in the handset.

2 Check to make sure the carrier's power cord is unplugged from the wall outlet before continuing.

3 Place the carrier against the wall. Choose a location backed by a wooden stud (if unavailable, use toggle bolts instead of the supplied wood screws). Hold the carrier straight; use a level if needed. Using a nail or pencil, mark screw locations through the four wall-mount holes.

Start the screws, leaving the screw heads protruding approximately $\frac{1}{2}$ " (12 mm) from the wall. Place the carrier assembly over the screws, then slide it downward to lock it into place. Tighten the screws.

4 Remove the plastic cap covering each radio module's card edge before inserting the radio modules into the carrier.

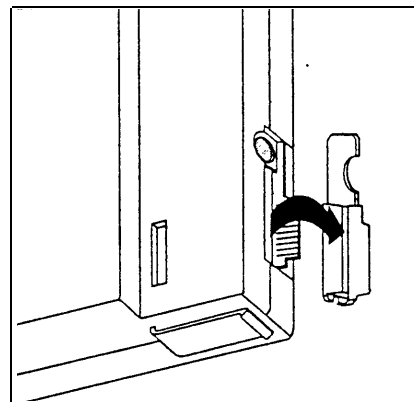
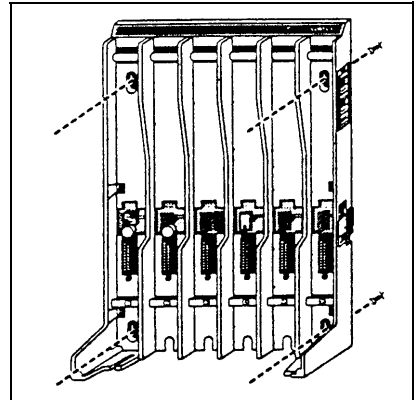

5 Starting from the leftmost slot (#1), insert each radio module into the carrier by hooking it onto the radio module mounting rod. Slowly swing the radio module's card edge into the card edge connector on the back of the carrier.

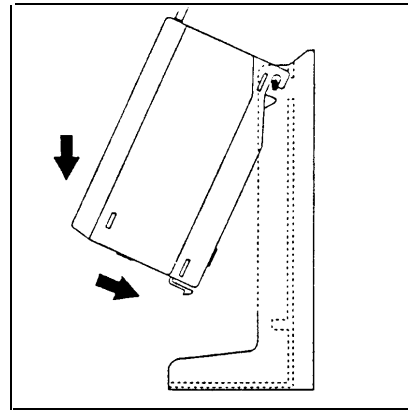

6 When the card edge is fully seated, a snap lock on the bottom of the radio module will engage.

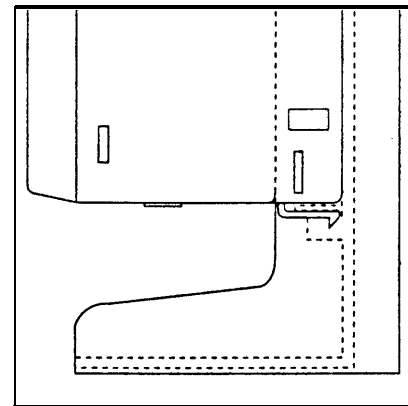

7 Insert a telephone line cord into the bottom of each radio module.

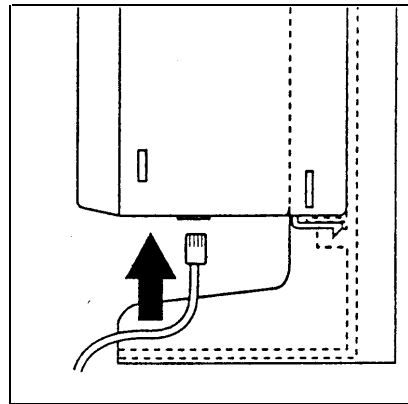

8 Slide the telephone line cords through the cable manager slot on the left front of the carrier.

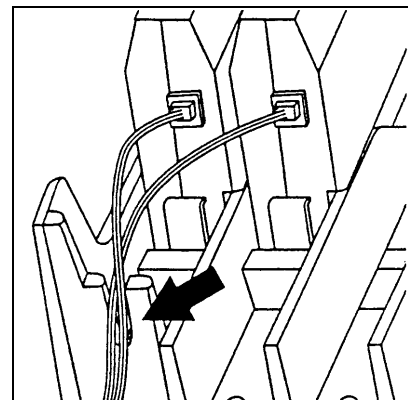

- 9** Insert the free end of each telephone line cord into the appropriate extension jack or terminal/station connector on your communications system switch/control unit (refer to your communications system manual for the proper location).

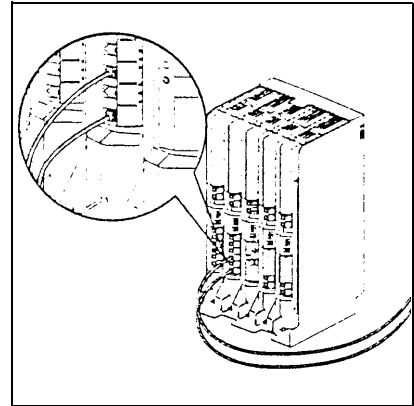

- 10** Plug the carrier's AC adapter cord into the left side of the carrier.

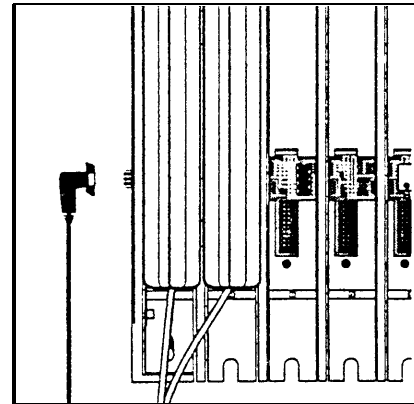

- 11** Insert the carrier's power cord into the AC adapter, then plug the power cord into a properly grounded 3-prong wall outlet that is not controlled by an on/off switch.

If appropriate, you can wall-mount the AC adapter using its attached wall-mounting bracket.

- ⚠ CAUTION:**
Never connect or disconnect telephone line cords, or insert or remove radio modules, while the carrier is plugged into the wall outlet.

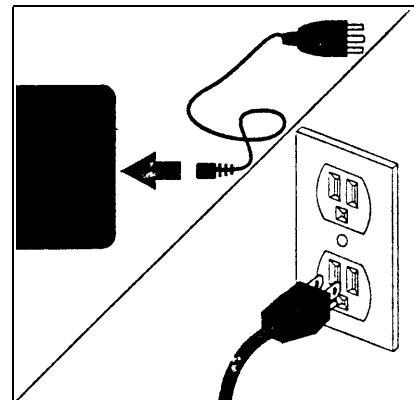

Go to "**Single Carrier Installation Self Test.**"

Single Carrier Installation Self Test

1 A single carrier must always function as a control carrier. Wait a few seconds, then compare the **OUT OF SYNC** and **CONTROL/EXPANSION** LEDs against the top three lines on the "SYNC and CONTROL/EXP LED Codes" label.

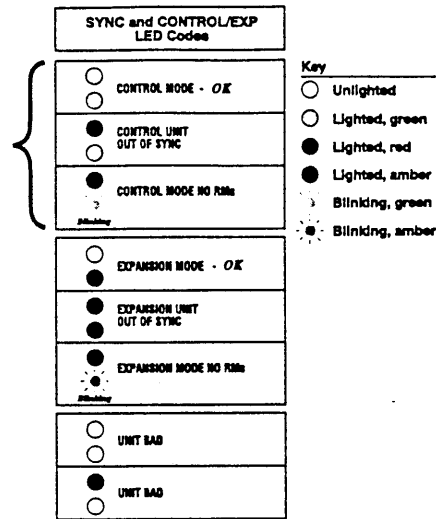

2 If the **OUT OF SYNC** LED is lit, power down, wait at least 15 seconds, and then repower the carrier. If the LED is still lit, follow the suggestions in the "Installation Problems" section of Chapter 5, "Troubleshooting." If the LED is still lit, call for help as described on the inside cover of this book.

3 If you are using a Model 117A4 carrier, verify that the carrier's **CONTROL/EXPANSION** LED is lit and that its color is green. This is correct for a single-carrier installation.

4 Verify the **POWER** and **PASS** LEDs on each radio module are lit. If a radio module's **PASS** LED does not light, power down the carrier and the module, wait 15 seconds, and repower the module and then the carrier. If the **PASS** LED still does not light, refer to Chapter 5, "Troubleshooting."

NOTE:

The **RADIO** LED also may light upon installation; however, since the **RADIO** LED has no significance during installation, ignore its operation.

The **RADIO** LED indicates a connection between the handset and the radio module; it lights when the handset is being used as long as the battery pack in the handset is charged.

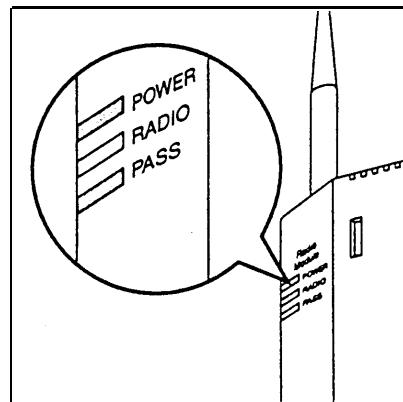
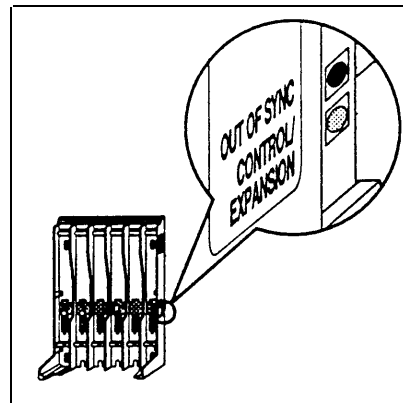

Go to "Handset."

Installing Multiple Carriers

- Install each carrier high on wall, leaving 6–12 inches (15.2–30.5 cm) between antennas and ceiling
- Install each carrier 1 foot (0.3 m) optimal to 4 feet (1.2 m) from its neighboring carrier
- Never install or remove a radio module from a carrier that is plugged into a wall outlet (hot insertion)
- See "Key Components" earlier in this chapter for additional picture detail

Multiple-carrier installation involves several stages:

- Mounting the carriers on the wall and cabling them
- Installing a single radio module in each carrier
- Installing the remaining radio modules

The most efficient method for installing carriers and their radio modules is to perform self tests after each stage of the installation. This enables you to spot any problems at an early stage, and avoid the necessity for reinstalling the components in order to solve problems.

Mounting and Cabling Multiple Carriers

Perform the tests described in "Wireless Test Mode" in Chapter 3 to determine the optimal placement of the radio module. To perform the tests, all you need is an electrical outlet for the radio module and a charged battery pack in the handset.

If you are installing any 117A3 carriers and need to adjust the power setting to avoid interference from other wireless products, see "Setting the 117A3 Carrier Power Level." Also make sure you have set the Control/Expansion DIP switch correctly (see "Setting the 117A3 Carrier Control/Expansion DIP Switch").

- 1** Check to make sure the carrier's power cord is unplugged from the wall outlet before continuing.
- 2** Choose a location backed by a wooden stud for the carrier (if unavailable, use toggle bolts instead of the supplied wood screws).

IMPORTANT:

The leftmost carrier must be the control carrier; all of the others are expansion carriers.

Place the carrier against the wall, leaving enough room to the right for additional carrier(s) if applicable. Hold the carrier straight; use a level if needed. Using a nail or pencil, mark screw locations through the four wall-mount holes. Start the screws, leaving the screw heads protruding approximately ½" (12 mm) from the wall.

- 3** Repeat Steps 1 through 3 for each carrier, leaving 1 foot (0.3 m) optimally to 4 feet (1.2 m) between carriers.
- 4** Place the carrier over the screws, then slide it downward to lock it into place. Be sure that the leftmost carrier is the control carrier. Tighten the screws. Repeat for each carrier.

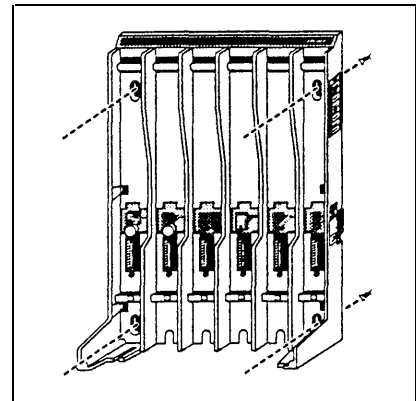

- 5** Connect an expansion cable to the OUT jack of the control carrier.

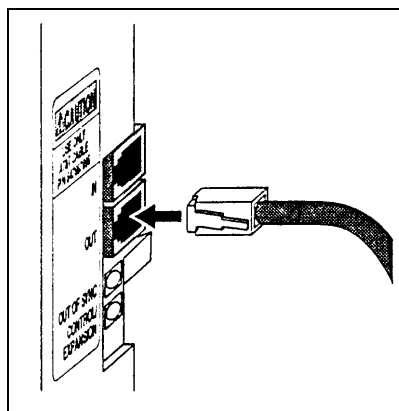

- 6** Insert the free end of the expansion cable into the IN jack of the expansion carrier immediately to the right of the control carrier.

NOTE:

Although installing an expansion cable into the wrong IN or OUT jack will not harm either carrier, doing so causes all handsets to work improperly and the **OUT OF SYNC** LED to light.

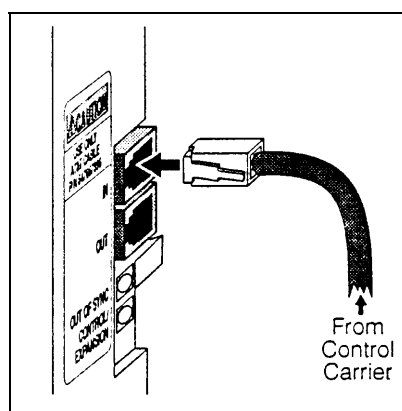

- 7** If you have a second expansion carrier:

- a. Connect an expansion cable to the OUT jack of expansion carrier #1.
- b. Insert the free end of the expansion cable into the IN jack of expansion carrier #2.

See "Key Components" earlier in this chapter for an illustration of a four-carrier setup.

- 8** Plug an AC adapter cord into the left side of each carrier.

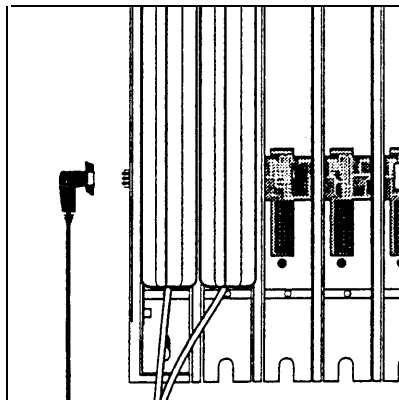

9 Insert each carrier's power cord into its AC adapter.

If appropriate, you can wall-mount each AC adapter using its attached wall-mounting bracket.

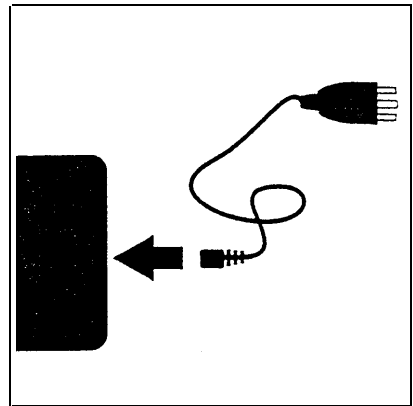

10 Plug each carrier's power cord into one of the following power sources that is not controlled by an on/off switch.

- Surge-suppressor strip.
- Properly grounded 3-prong wall outlets. (See "Wall outlets" in the following chart for the order in which to power up the carriers.)

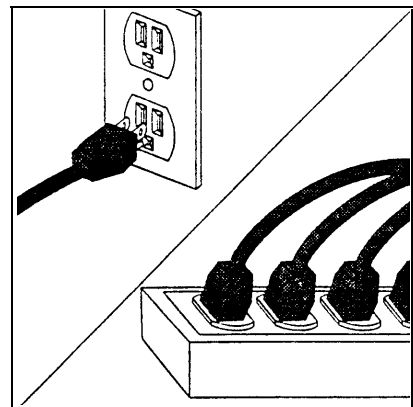

Power the carriers as follows:

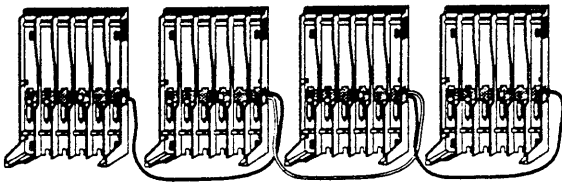
If the carriers are plugged into...	Then...
One surge suppressor strip	Power the strip. <i>Result:</i> All carriers will turn on simultaneously.
Wall outlets	Plug in the power for the Carriers in this order: <div style="text-align: center; margin-top: 10px;">  </div>

⚠ CAUTION:
Never connect or disconnect expansion cables or telephone line cords, or insert or remove radio modules, while the carrier is plugged into the wall outlet.

Multiple Carrier Mounting and Cabling Self Test

1 Wait a few seconds after powering up the carriers, then verify that the red **OUT OF SYNC** LEDs on all carriers are lit. This is normal when no radio modules have yet been installed. The **CONTROL/EXPANSION** LEDs should also be lit and blinking:

- Model 117A4 control carrier = Green blinking
- Model 117A4 expansion carrier(s) = Green blinking

A Model 117A3 carrier has no **CONTROL/EXPANSION** LED, but the DIP switch in Slot 4 of the carrier must be set correctly to either Control or Expansion.

2 The following illustration shows the correct LED lights for a four-carrier installation with no radio modules installed yet. This example installation has three 117A4 carriers—one acting as the control carrier and the other two acting as expansion carriers—and one 117A3 carrier acting as an expansion carrier.

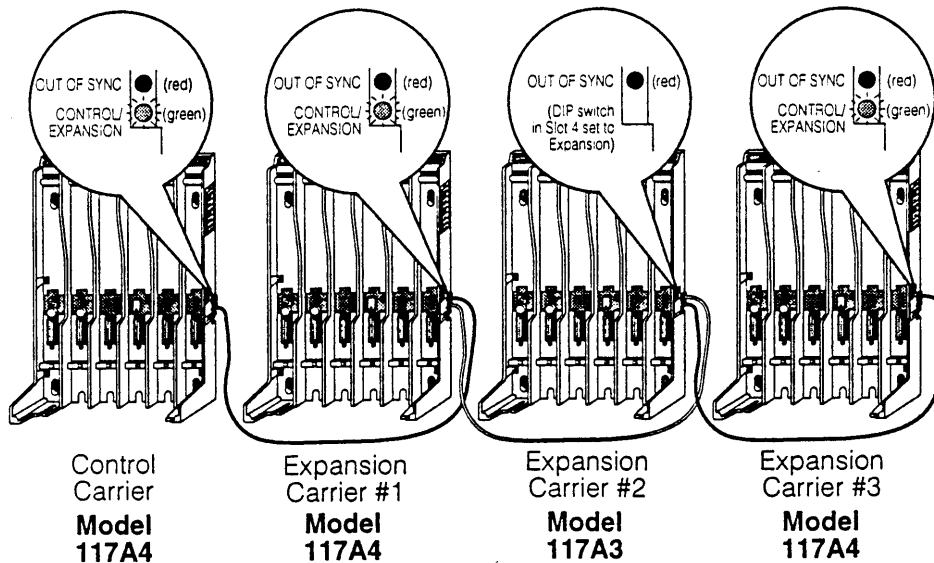

3 At this stage of your installation, the LEDs displayed should match the third or sixth lines of the SYNC and CONTROL/EXP LED Codes label, depending on whether the carrier is the control or an expansion carrier.

4 If the LEDs on your installation do not reflect this pattern, there is probably a mistake in the cabling. Power down the carriers and check that you have followed Steps 6 through 8 in "Mounting and Cabling Multiple Carriers" correctly. If you are still having problems, see Chapter 5, "Troubleshooting."

5 If your LEDs match the pattern in the illustration, you can feel confident that your carriers are cabled correctly. **Power down the carriers** and go on to "Installing a Single Radio Module in Each Carrier."

SYNC and CONTROL/EXP LED Codes		Key
○	CONTROL MODE - OK	○ Unlighted
○	CONTROL UNIT OUT OF SYNC	○ Lighted, green
●	CONTROL MODE NO RMs	● Lighted, red
●	CONTROL MODE NO RMs	● Lighted, amber
⦿	CONTROL MODE NO RMs	⦿ Blinking, green
⦿	CONTROL MODE NO RMs	⦿ Blinking, amber
○	EXPANSION MODE - OK	
○	EXPANSION UNIT OUT OF SYNC	
●	EXPANSION MODE NO RMs	
●	EXPANSION MODE NO RMs	
⦿	EXPANSION MODE NO RMs	
⦿	EXPANSION MODE NO RMs	
○	UNIT BAD	
○	UNIT BAD	

Installing a Single Radio Module in Each Carrier

- 1** Remove the plastic cap covering each radio module's card edge before inserting the radio modules into the carriers.

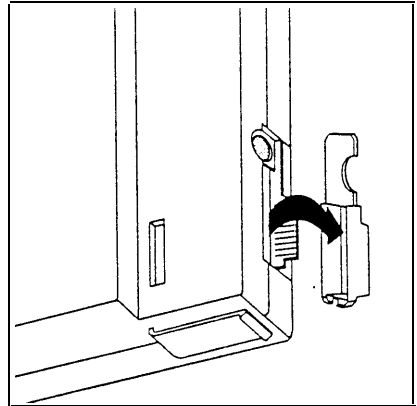

- 2** Working from left to right, insert a radio module into the first slot (Slot 1) of each carrier; hook each radio module onto the mounting rod. Slowly swing the radio module's card edge into the card edge connector on the back of the carrier. (Exception: use Slot 6 instead of Slot 1 for a Model 117A3 control carrier.)

IMPORTANT:

Slot 6 of a Model 117A3 control carrier must always contain a radio module to pass the synchronization signal to the next carrier.

A Model 117A4 carrier does not require Slot 6 to be filled.

- 3** When the card edge is fully seated, a snap lock on the bottom of the radio module will engage.

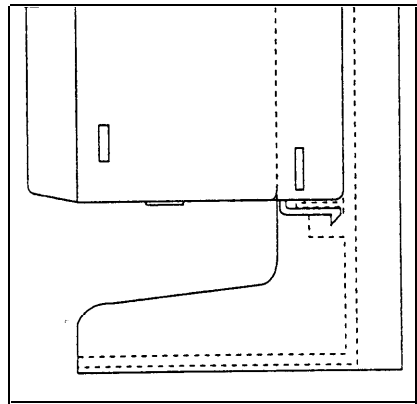
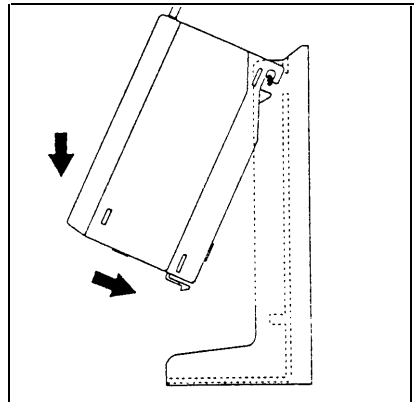

- 4** Insert a telephone line cord into the bottom of each radio module.

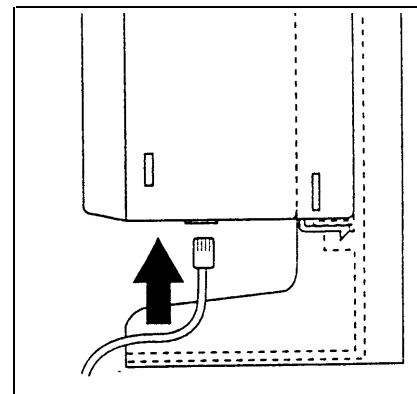

5 Slide the telephone line cords through the cable manager slot on the left front of each carrier.

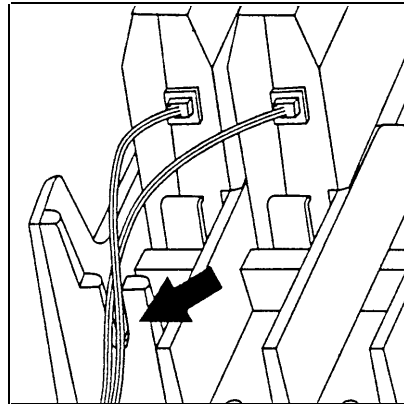

6 Insert the free end of the telephone line cord into the appropriate extension jack or terminal/station connector on your communications system switch/control unit (refer to your communications system manual for the proper location).

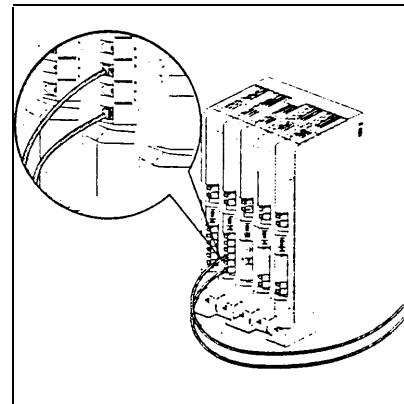

7 Power the carriers as follows:

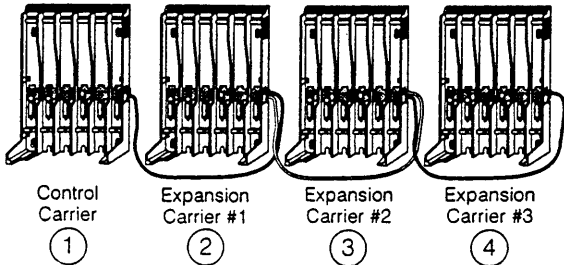
If the carriers are plugged into...	Then...
One surge suppressor strip	Power the strip. <i>Result:</i> All carriers will turn on simultaneously.
Wall outlets	Plug in the power for the Carriers in this order: 

⚠ CAUTION:
 Never connect or disconnect expansion cables or telephone line cords, or insert or remove radio modules, while the carrier is plugged into the wall outlet.

Keep in mind that a Model 117A3 control carrier must have a module in Slot 6 in order to synchronize correctly with the remaining carrier(s).

Installation Self Test with a Single Radio Module in Each Carrier

1 Wait a few seconds after powering the carriers, then verify that the carriers' **OUT OF SYNC** LEDs are not lit.

2 The following illustration shows the correct LED lights for a four-carrier installation with one radio module installed in each carrier. This example installation has three 117A4 carriers—one acting as the control carrier and the other two acting as expansion carriers—and one 117A3 carrier acting as an expansion carrier.

When one radio module is present in each carrier, the red **OUT OF SYNC** LEDs will not be lighted on any carrier, no matter which model. The other LEDs will be lighted as follows:

- Model 117A4 control carrier **CONTROL/EXPANSION** LED = Green
- Two Model 117A4 expansion carriers **CONTROL/EXPANSION** LED = Amber
- The radio modules' **PASS** and **POWER** LEDs = Green

The Model 117A3 expansion carrier has no **CONTROL/EXPANSION** LED, but the DIP switch in Slot 4 of the carrier is set to Expansion.

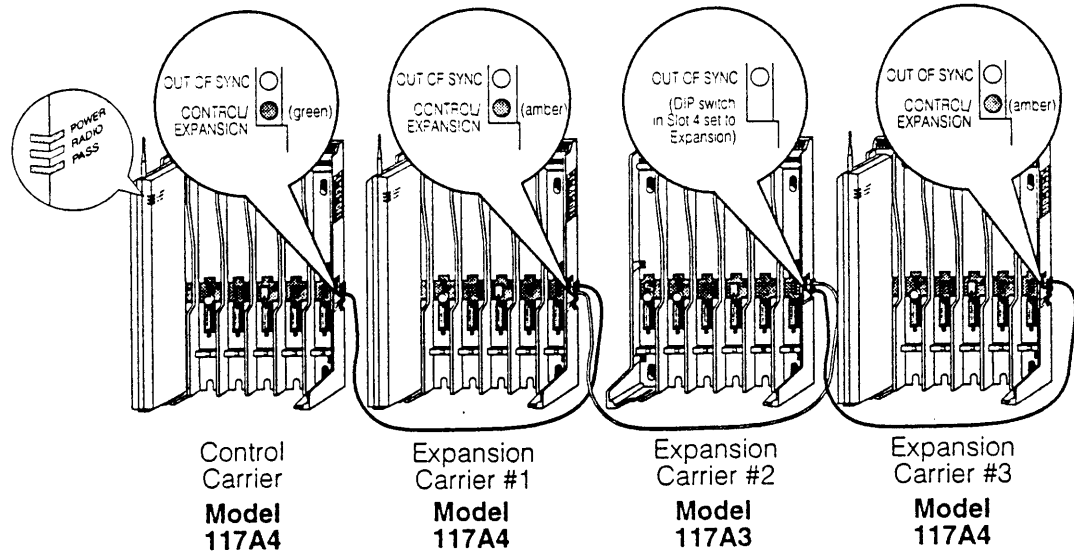

3 At this stage of your installation, the LEDs displayed should match the first or fourth lines of the SYNC and CONTROL/EXP LED Codes label, depending on whether the carrier is the control or an expansion carrier. (Keep in mind that a Model 117A3 carrier does not have a **CONTROL/EXPANSION** LED.)

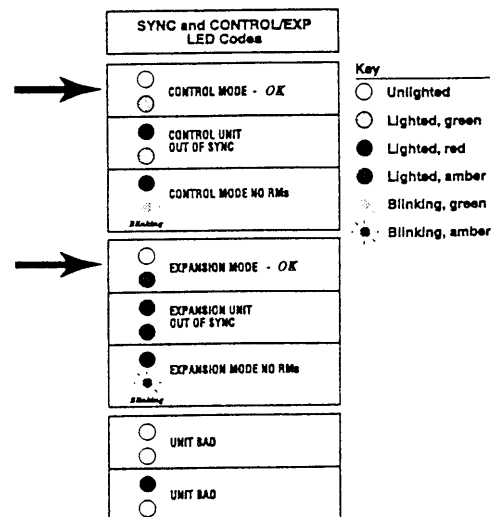

4 If an **OUT OF SYNC** LED is lit, power down, wait at least 15 seconds, and then repower the carriers in order from left to right, as described in Step 7. If the LED is still lit, follow the suggestions in the "Installation Problems" section of Chapter 5, "Troubleshooting." If the LED is still lit, call for help as described on the inside front cover of this book.

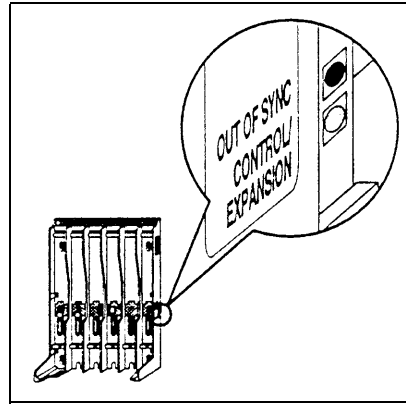

5 The **PASS** and **POWER** LEDs on all radio modules should be lighted and green. If a radio module's **PASS** LED is not lighted:

- a. Power down the carriers.
- b. Unplug from the wall outlet the power cord/AC adapter of the radio module that did not light.
- c. Wait 15 seconds.
- d. Plug in the radio module's power cord again.
- e. Repower the carriers again, following the proper left-to-right order.

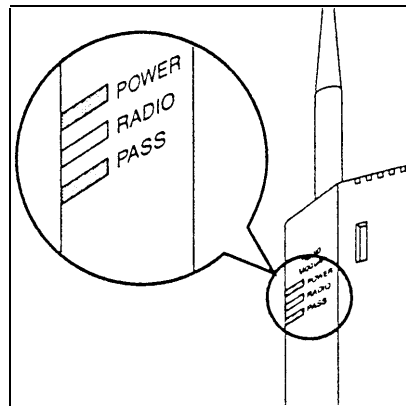

6 If your LEDs match the pattern in the illustration in Step 2, you can feel confident that the carriers are cabled correctly and that the installed radio modules are all functional. **Power down the carriers** and go on to "Installing the Remaining Radio Modules."

Installing the Remaining Radio Modules

- 1** Remove the plastic cap covering each radio module's card edge before inserting the radio modules into the carriers.

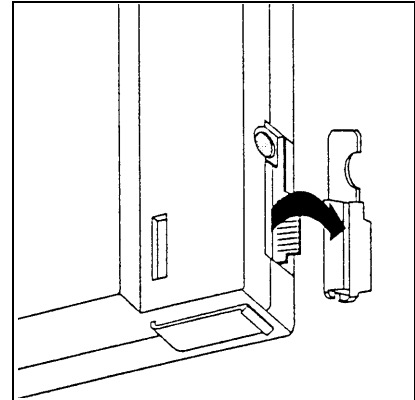

- 2** Beginning with the first empty slot and working from left to right, insert a radio module into each slot of the control carrier. Hook each radio module onto a mounting rod. Slowly swing the radio module's card edge into the card edge connector on the back of the carrier.

IMPORTANT:

Slot 6 of a Model 117A3 control carrier must always contain a radio module to pass the synchronization signal to the next carrier.

A Model 117A4 carrier does not require Slot 6 to be filled.

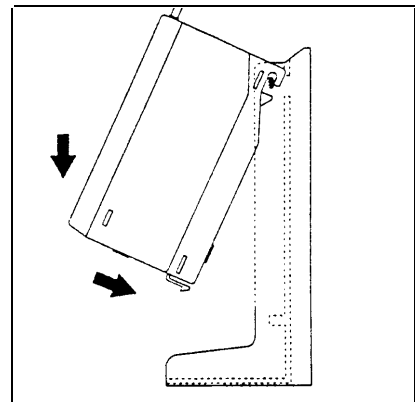

- 3** When the card edge is fully seated, a snap lock on the bottom of the radio module will engage.

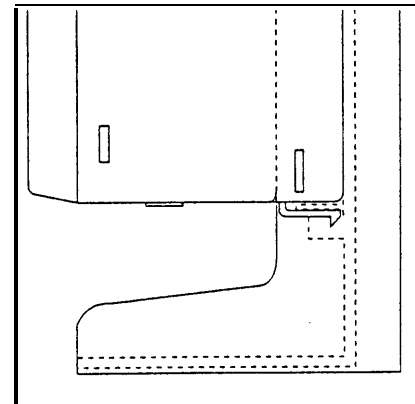

- 4** Repeat Steps 2 and 3 for each expansion carrier, until each radio module is inserted into a carrier.

NOTE:

Fill all six slots of the current carrier before inserting radio modules into the next carrier.

- 5** Insert a telephone line cord into the bottom of each radio module.

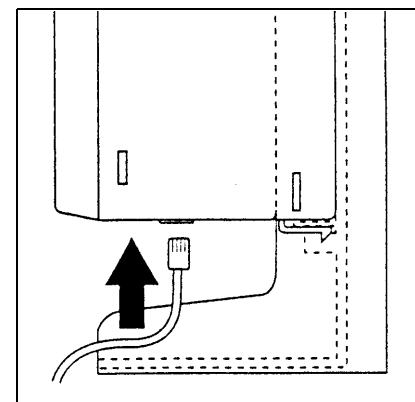

6 Slide the telephone line cords through the cable manager slot on the left front of the carrier.

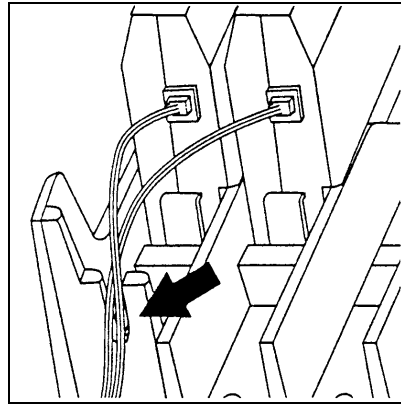

7 Insert the free end of each telephone line cord into the appropriate extension jack or terminal/station connector on your communications system switch/control unit (refer to your communications system manual for the proper location).

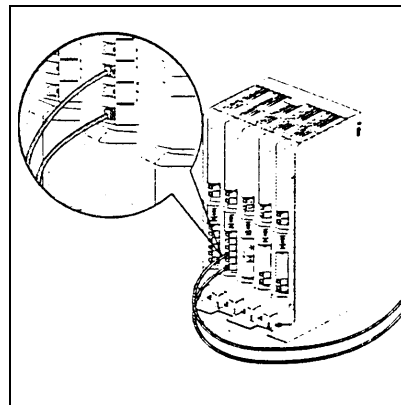

8 Power the carriers as follows:

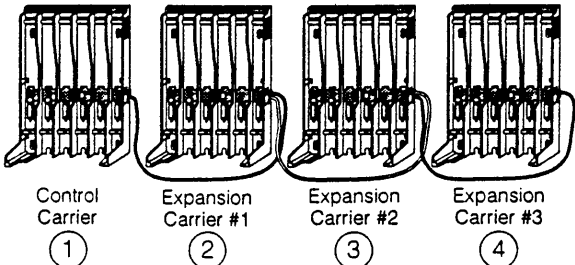
If the carriers are plugged into...	Then...
One surge suppressor strip	Power the strip. <i>Result:</i> All carriers will turn on simultaneously.
Wall outlets	Plug in the power for the Carriers in this order: 

⚠ CAUTION:
Never connect or disconnect expansion cables or telephone line cords, or insert or remove radio modules, while the carrier is plugged into the wall outlet.

Installation Self Test for Remaining Radio Modules

1 Wait a few seconds after powering the carriers, then verify that the carriers' **OUT OF SYNC** LEDs are not lit.

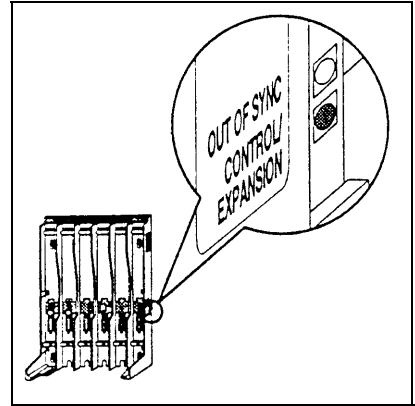

2 At this stage of your installation, the LEDs displayed should again match the first or fourth lines of the SYNC and CONTROL/EXP LED Codes label, depending on whether the carrier is the control or an expansion carrier. (Keep in mind that a Model 117A3 carrier does not have a **CONTROL/EXPANSION** LED.)

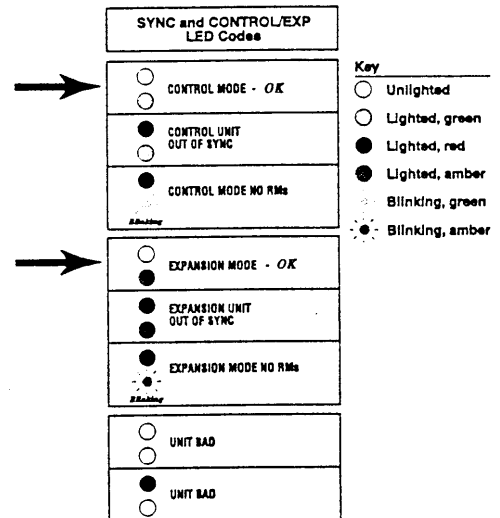

3 If an **OUT OF SYNC** LED is lit, power down, wait at least 15 seconds, and then repower the carriers in order from left to right, as described in Step 8 in "Installing the Remaining Radio Modules." If the LED is still lit, follow the suggestions in the "Installation Problems" section of Chapter 5, "Troubleshooting." If the LED is still lit, call for help as described on the inside front cover of this book.

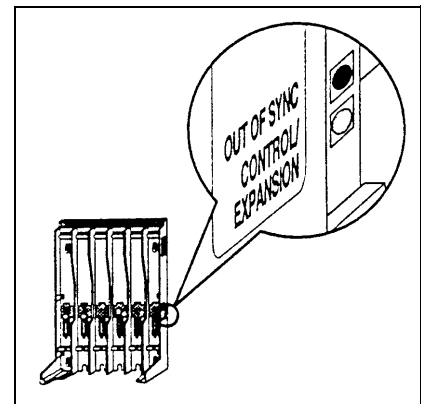

4 The **PASS** and **POWER** LEDs on all radio modules should be lighted and green, indicating that all of the radio modules are functional. If a radio module's **PASS** LED is not lighted:

- a Power down the carriers.
- b Unplug from the wall outlet the power cord/AC adapter of the radio module that did not light.
- c Wait 15 seconds.
- d Plug in the radio module's power cord again.
- e Repower the carriers again, following the proper left-to-right order.

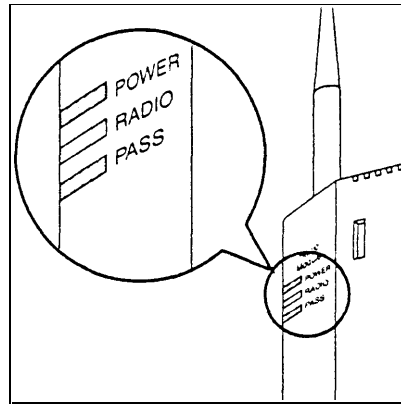

Go to "**Handset.**"

Handset

This section explains how to install the handset battery pack, change the communications system setting, and fill out the handset label.

Inserting and Removing the Handset's Battery Pack

1 To insert the battery pack into the handset, insert the two small rectangular tabs located along the bottom back edge of the handset into the two rectangular holes along the bottom front edge of the battery pack.

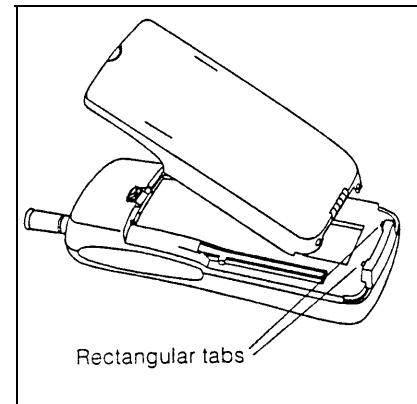

2 Press the battery pack downward until it clicks into place.

The battery pack must be charged prior to using the handset. See "Battery Charger" later in this chapter for instructions.

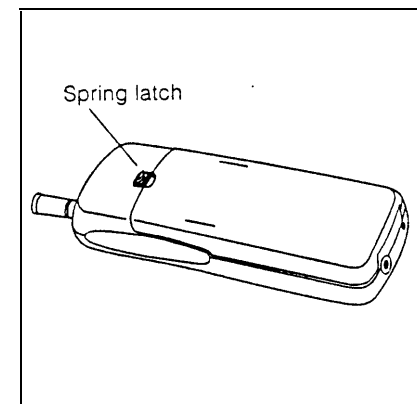

3 To remove the battery pack, slide the spring latch upward (away from the battery pack). While holding the latch up, grasp both sides of the battery pack, then gently pull the battery pack upward and out.

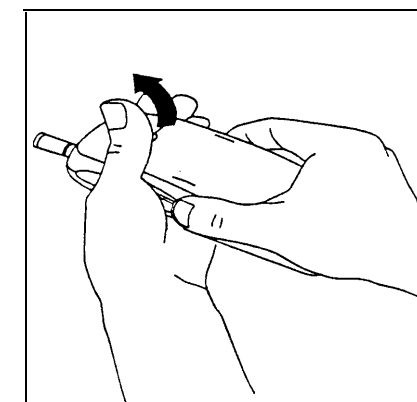



Changing the Communications System Setting

The communications system you use determines what information the MDW 9031 Pocketphone can display and how the phone lines and programmable/intercom/drop buttons are identified (see "Button Mapping" in Chapter 6, "MDW 9031 Pocketphone Compatibility").

The MDW 9031 is factory-set to work with the PARTNER communications system. **If you are using PARTNER as your communications system, skip this section; if you are using a different communications system, you will need to change the setting.**

To change the communications system setting, use the following procedure to enter Local Mode and then Button Mapping Mode:

1. Make sure the handset is turned off.
2. Press and hold the Select button () for three seconds.
3. While still holding , press [*On/Off*].

The handset beeps twice, and the top line of the display shows **LCL:P** (unless you have already changed it from the default setting).

4. Press and hold "M" () for three seconds to enter Button Mapping Mode.

The handset display shows one of the following:

MAP:P	PARTNER systems
MAP:D	DEFINITY systems, System 25, System 75, and System 85
MAP:M1	All MERLIN systems (except MERLIN 410 and MERLIN 820), including MERLIN LEGEND
MAP:M2	MERLIN 410 and MERLIN 820

5. Press  repeatedly to cycle through the settings until the display appropriate for your communications system is shown.
6. Press [*On/Off*] when the correct setting is displayed.

The top line of the display shows information appropriate to the communications system you are using.

7. To verify your setting, repeat Steps 1–3. The top line of the display should appear as follows, depending upon your communications system:

PARTNER systems:	LCL:P
DEFINITY systems, System 25, System 75, and System 85	LCL:D
All MERLIN systems (except MERLIN 410 and MERLIN 820)	LCL:M1
MERLIN 410 and MERLIN 820	LCL:M2

For a description of the button mapping between the MDW 9031 Pocketphone and the wired telephones for your communications system, or to program features on buttons, see "Button Mapping" in Chapter 6.

Filling Out the Handset Label

The MDW 9031 Pocketphone display shows the status of up to 12 lines or programmable/intercom/drop buttons. Since the MDW 9031 is compatible with several different communications systems, diagrams of the button mapping for these systems are provided in Chapter 6.

The MDW 9031 has a label on the back of the handset near the top where you can record:

- Your extension number
- The mapping of your MDW 9031 line buttons to those on a wired phone for your communications system

NOTE:

Use a pencil or *ballpoint* pen on the label, in case you want to erase the information later. Do *not* use felt-tip or other types of non-erasable markers. Also, do not remove the label.

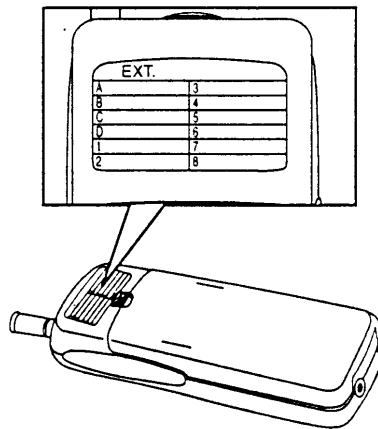

- 1** Write your extension number on the label.
- 2** Locate the section in Chapter 6 that describes the button mapping for your communications system; then copy the mapping to the label for ease of reference.

Go to "Battery Charger."

Battery Charger

This section explains how to choose a location for the battery charger and install it. It also explains how to insert and remove a battery pack.

Positioning the Battery Charger

The battery charger can be placed on a desk, or it can be mounted on a wall. Before you install the battery charger, note the following considerations:

- Locate the battery charger within 5 feet (1.6 m) of a properly grounded 3-prong electrical outlet that is not controlled by an on/off switch.
- If your communications system uses an uninterruptable power supply, such as a backup generator, you may want to connect the battery charger to that power supply.
- Do not locate the battery charger where it will be exposed to direct sunlight or water.

⚠ WARNING:

The rechargeable battery pack may contain elements that are harmful to the environment (for example, nickel). Do not burn or puncture the battery. Like other batteries of this type, if it is burned or punctured, it could release toxic material that could cause injury. Do not dispose of it in household garbage. For information about recycling or proper disposal, consult your local solid waste (garbage) collection or disposal organization.

Installing the Battery Charger

- **If you are wall-mounting the battery charger, follow Steps 1 through 7**
- **If you are desk-mounting the battery charger, follow only Steps 1, 5, and 7**

1 Check to make sure the battery charger's power cord is unplugged from the wall outlet before continuing. If you are desk-mounting, skip to Step 5.

2 To wall-mount, place the battery charger's wall-mounting template (located on the last page of this book) against the wall. Choose a location backed by a wooden stud (if unavailable, use toggle bolts instead of the supplied wood screws). Hold the template straight; use a level if needed.

3 Mark the locations for the two wall-mounting screws, and then remove the template from the wall. Lightly tap a nail into the wall to start the holes.

4 Place the screw through the wall spacers so that the screw head nests in the indentation on the spacer. Start the screws, and screw them in until the wall spacers rest against the wall.

5 Insert the battery charger's power cord/AC adapter into the battery charger. If you are desk-mounting the battery charger, skip to Step 7.

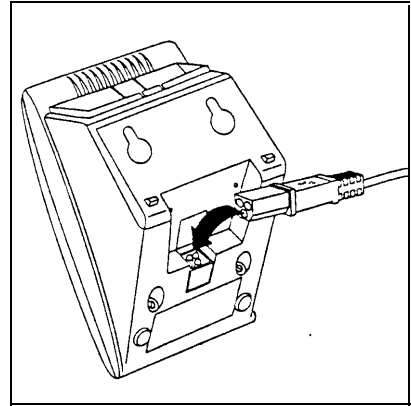

6 Place the keyhole-shaped openings in the back of the battery charger over the screw heads and wall spacers, then slide the battery charger downward into the groove in the wall spacers to lock it into place.

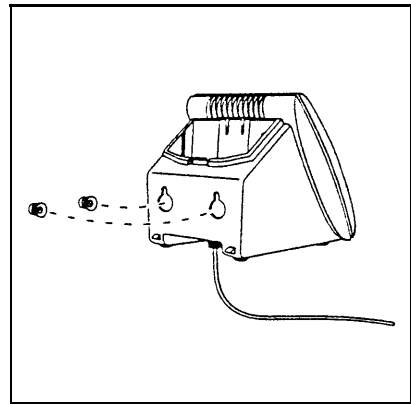

7 Plug the battery charger's power cord/AC adapter into a properly grounded 3-prong wall outlet that is not controlled by an on/off switch.

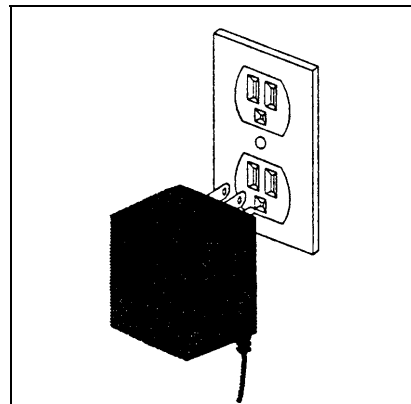

Inserting a Battery Pack into the Spare Battery Compartment

Slide the battery pack (or an optional extended battery pack) into the Spare battery compartment until it is firmly seated with the back of the battery pack against the back of the Spare battery compartment. **Do not force the battery pack down.** The battery pack should slide easily into the slot.

Correct positioning of the battery pack in the charger is important to ensure proper charging. The bottom end of either battery pack also has two small round holes that must align with two guide pins on the bottom of the Spare battery compartment. When a battery pack is positioned correctly in the Spare battery compartment, the **SPARE LED** on the front of the battery charger lights.

The Spare battery compartment has a vertical ridge on each side that serves as a "guide rail" for positioning the standard battery pack.

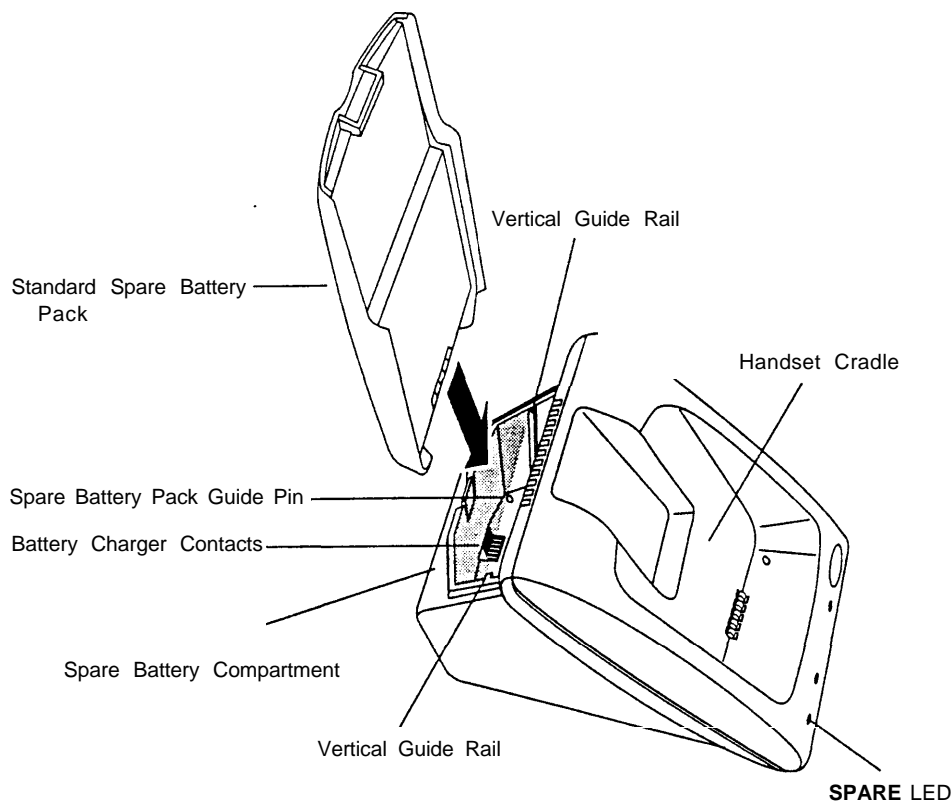

The extended battery pack simply slides down into the Spare battery compartment.

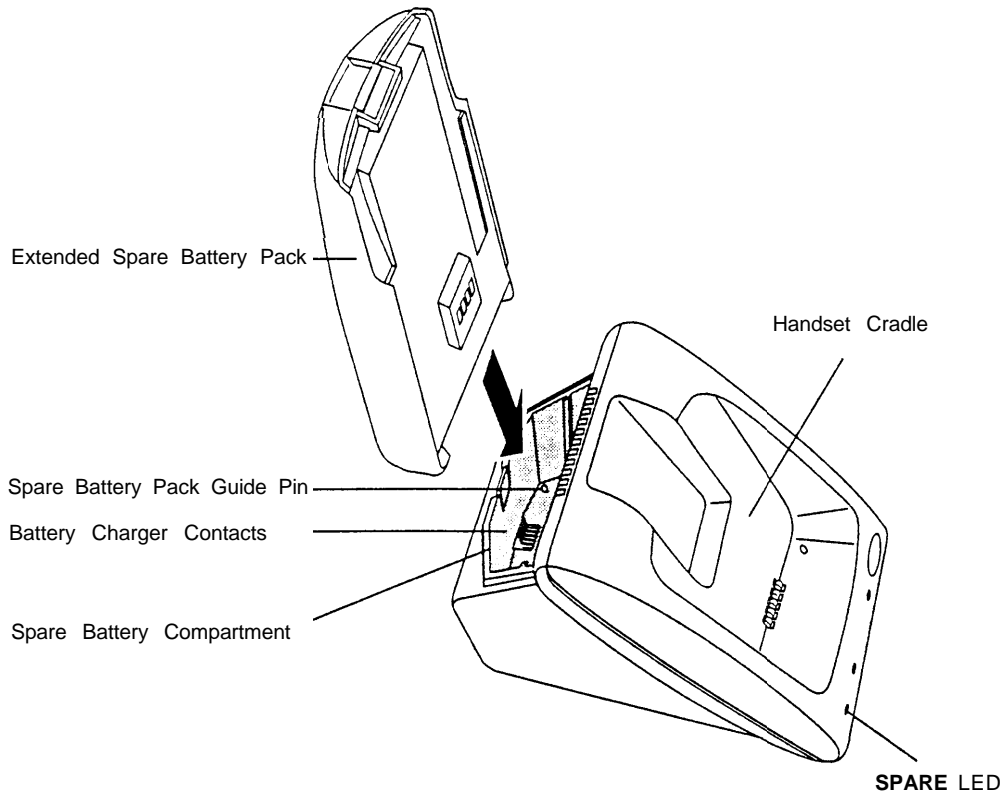

Removing a Battery Pack from the Spare Battery Compartment

To remove a battery pack from the Spare battery compartment of the charger, simply lift the battery pack up and out.

Inserting the Handset into the Battery Charger's Handset Cradle

Correct positioning of the handset in the charger is important to ensure proper charging.

1 Position the handset (with either battery pack attached) so that the two small round holes in the bottom of the handset fit over the two guide pins on the bottom of the handset cradle.

2 Rock the handset back into the cradle until it is firmly seated with the back of the handset battery pack against the back of the handset cradle.

When the handset has been inserted correctly, the following occur:

- The **HANDSET** LED lights.
- If the handset was turned on, the **ON** icon in the display is no longer visible.
- Any call that was in progress is terminated.
- After 15 seconds, the handset enters the energy-saving "sleep" mode.

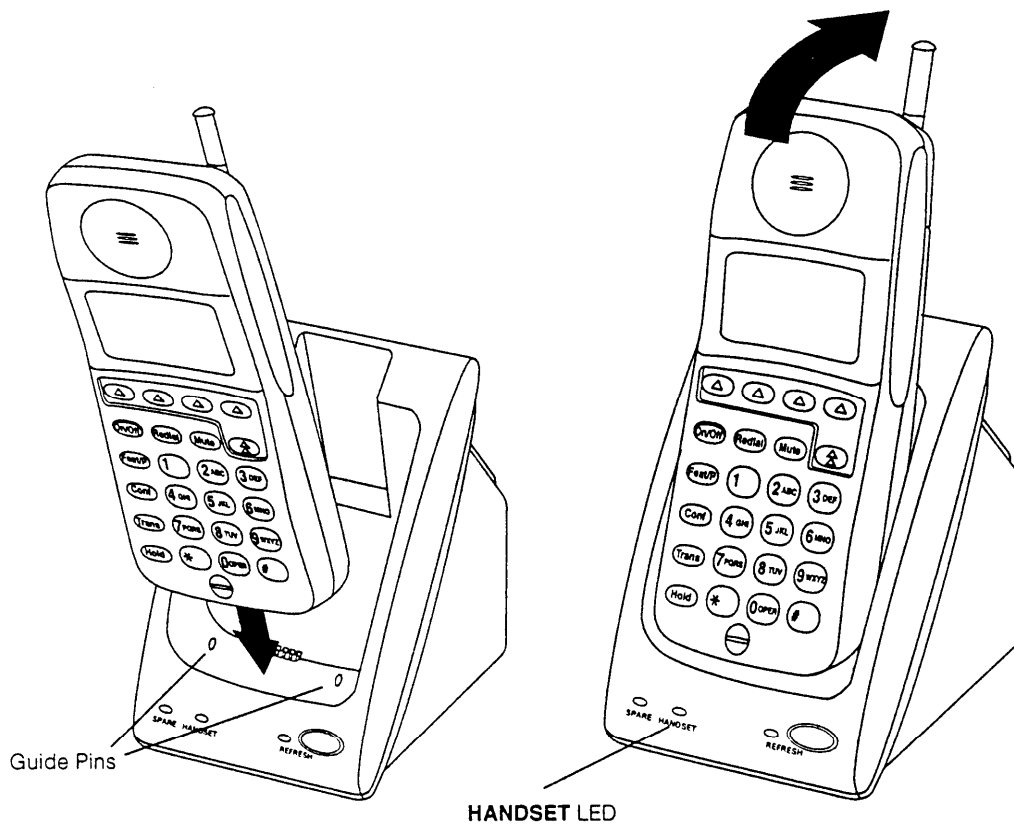

Removing the Handset from the Handset Cradle

To remove the handset from the handset cradle, simply lift it out.

Using the MDW 9031 Pocketphone

3

Important Safety Instructions

Please see "Important Safety Instructions" at the beginning of Chapter 2.

The Handset



The MDW 9031 Pocketphone supports normal operation of all of the features of the switch as far as is practical within the limitations of its reduced size and power and the nature of wireless operation. There are very few differences in operation between the wireless MDW 9031 Pocketphone and a wired deskset.

This chapter describes the handset and how to use it. It also explains how to use a headset.

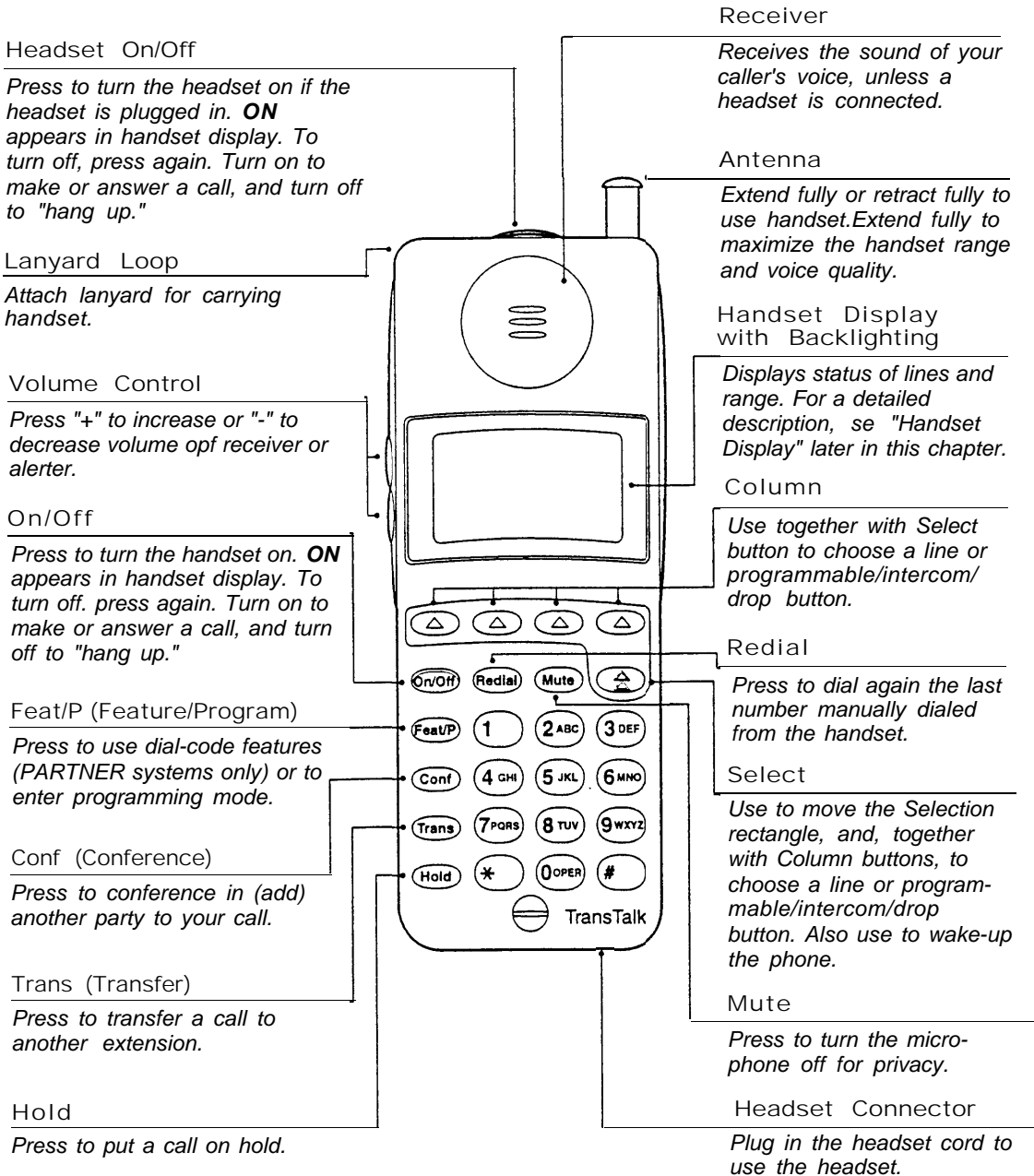

Handset Controls

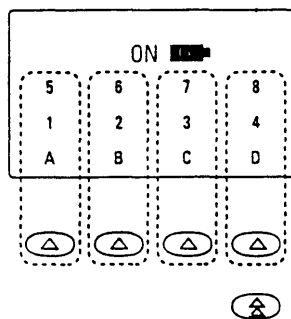

Column and Select Buttons

The MDW 9031 pocketphone can display the status of up to 12 lines or programmable/intercom/drop buttons; however, it has only 4 selection buttons (the Column buttons). The Select button () is used in conjunction with the Column buttons () to increase the available selections to 12. Each Column button () affects one of the three lines or programmable/intercom/drop buttons directly above it, as shown in the illustration below.



Each time you press the Select button () the Selection rectangle moves to another row (cycling through the three rows in turn). The Column buttons () each represent one of the four lines or programmable/intercom/drop buttons *in the row enclosed by the Selection rectangle*.

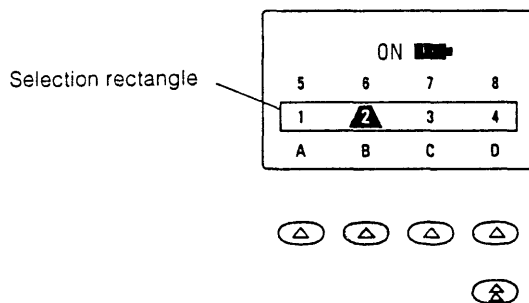

For example, suppose your handset shows the Selection rectangle around the middle row of lines. If you press the second Column button from the left (shaded in the illustration above), you select Line 2, as indicated by the truncated triangle in the illustration.

NOTE:

If you have a communications system other than PARTNER, the line you select is indicated by a small rectangle instead of the triangle, as shown below:

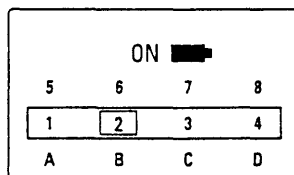

See "Manually Selecting a Line or Programmed Button" and "Preselecting a Line" later in this chapter for more information about the Column and Select buttons.

Handset Display (with Backlighting)

The MDW 9031 Pocketphone display has one 16-alphanumeric-character line, and four lines of icons to provide you with status information. The display provides Backlighting (a programmable option) either when the handset is turned on or when the  button is pressed. See "Changing the Handset Settings." The Backlighting lasts for 10 seconds if no other button is pressed when the handset is turned on.

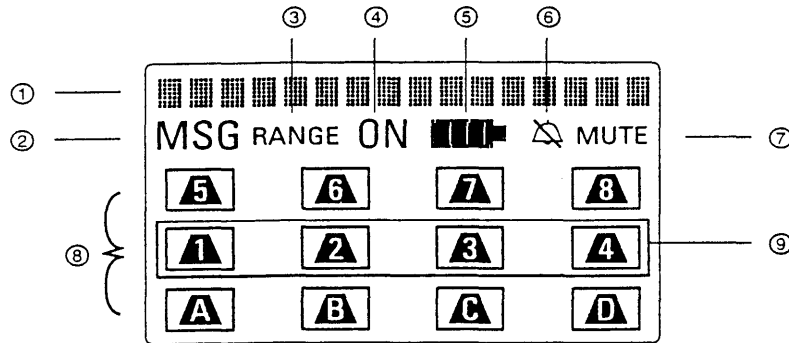

NOTE:

This illustration is intended to show you what all of the indicators look like, but you will never see all of the line status indicators illuminated at once.

- ① This line of the display gives you the information you would see on a wired system phone's display, except that the time is not provided. The information varies according to which communications system you are using. For example, the display may show the current date, the number you are calling, or caller ID information (if the system supports this feature). This display line is also used for feedback when testing and programming the handset. See "Display Messages" later in this chapter for more information about messages.
- ② **MSG** icon indicates that you have a message.
- ③ **RANGE** icon indicates that the handset is out of range or almost out of range. The handset also beeps. For more information, see "Range Indicators" later in this chapter.
- ④ **ON** icon indicates that the handset has been turned on by pressing [*On/Off*].
- ⑤ **Battery** icon flashes to indicate a low battery condition. The handset also emits 2 beeps. For more information, see "Low Battery Indicator" later in this chapter.
- ⑥ **No Ring** icon indicates that the alerter is disabled. If the alerter is enabled, no icon is displayed.
- ⑦ **MUTE** icon indicates that the handset microphone was turned off by pressing [*Mute*].
- ⑧ **Line Status Indicators** show the status of line or programmable/intercom/drop buttons. See Chapter 6 for button-mapping information. Also see "Line Status Indicators" later in this chapter.
- ⑨ **Selection rectangle** indicates the active row for line or programmable/intercom/drop button selection. See "Column and Select Buttons" earlier in this chapter.

When the display is blank, the handset is either turned off or in the power-saving "sleep" mode. You can activate the display and Backlighting (if programmed) by pressing [*On/Off*] to turn the handset on or by pressing  to "wake it up."

Display Messages

The top line of the handset display uses up to 16 alphanumeric characters to provide messages such as the following:

- **LCL:P** (or **LCL:D**, **LCL:M1**, or **LCL:M2**) indicates that the handset is in Local Mode, and tells which communications system the button mapping is set to emulate:

LCL:P	PARTNER systems
LCL:D	DEFINITY systems, System 25, System 75, and System 85
LCL:M1	All MERLIN systems (except MERLIN 410 and MERLIN 820), including MERLIN LEGEND
LCL:M2	MERLIN 410 and MERLIN 820

- **WIRELESS TEST** indicates that the handset is in Wireless Test Mode; **1** through **10** are used to measure signal strength and voice quality in Wireless Test Mode.
- **VIBR** indicates that the vibrator is enabled to notify you of incoming calls.
- **PSEL** indicates that Line Preselection is enabled.
- **PRESELECTION:ON** or **PRESELECTION:OFF** is displayed when you enter Preselection Mode, and indicates the status of the Line Preselection option.
- **CHANGE BUTTN MAP** is an error message indicating that the handset is set for the wrong communications system. See "Changing the Communications System Setting" in Chapter 2 for instructions for changing the setting.
- **MAP:P** (or **MAP:D**, **MAP:M1**, or **MAP:M2**) is displayed when you enter Button Mapping Mode, and indicates the communications system to which the MDW 9031 buttons are currently mapped:

MAP:P	PARTNER systems
MAP:D	DEFINITY systems, System 25, System 75, and System 85
MAP:M1	All MERLIN systems (except MERLIN 410 and MERLIN 820), including MERLIN LEGEND
MAP:M2	MERLIN 410 and MERLIN 820

- **RANGE** is an error message indicating that the handset is not communicating with its radio module. See Chapter 5, "Troubleshooting," for help in resolving this problem.

Line Status Indicators

There are 12 status indicators; each one corresponds to a specific outside line or programmable/intercom/drop button. (The function of these status indicators varies, depending on the communications system you are using—see button mapping for the appropriate communications system switch in Chapter 6, "MDW 9031 Pocketphone Compatibility.") The status indicators show either a truncated triangle or a rectangle, signifying activity as follows:

PARTNER Systems:

A **rectangle** () is the equivalent of a red LED on a wired system phone.

A truncated **triangle** () is the equivalent of a green LED on a wired system phone.

All Other Systems:

A **rectangle** () is the equivalent of a green LED on a wired system phone.

A truncated **triangle** () is the equivalent of a red LED on a wired system phone.

Range Indicators

For maximum range and voice quality, always fully extend the antenna before placing or answering a call. **The antenna must be either fully retracted (for short range) or fully extended (for maximum range) to use the Pocketphone.**

The handset provides an audible and a visual signal to alert you when the handset is near the end of the range of the radio module. Depending on how far away the handset is from the radio module, the signals function as follows:

- The handset emits two beeps and flashes the **RANGE** indicator continuously.
Out of optimal range. You have walked into an area that is near the end of the operating range of the radio module. You can continue your conversation or initiate a call, but you are likely to experience a degradation in voice quality.
- The handset emits five sets of beeps and displays the **RANGE** indicator.
Loss of communication link. You have walked into an area that is out of the operating range of the radio module. You must bring the handset within range of the radio module within several seconds or the handset will turn off. If the handset turns off, it appears that your call was disconnected; however it was only placed on Hold. To talk with your party, move back towards the radio module, press [*On/Off*], then proceed as you would for any call placed on Hold.
- When you try to make a call, the handset emits two beeps and flashes the **RANGE** indicator twice; then the handset automatically turns off.
Cannot establish communication link. You are completely out of range of the radio module. To make the call, move back towards the radio module and try again.

Refer to Chapter 5, "Troubleshooting," for additional information about out-of-range conditions.

Low Battery Indicator

The standard battery pack has approximately three hours of continuous talk time after being fully charged. The optional extended battery pack has approximately eight hours of continuous talk time after being fully charged.

When the handset is On and the battery power is low, the handset will emit two beeps and the **Battery** icon in the handset display will flash. When this occurs, you have 5 minutes or less of talk time left. At this point, you can either:

- Complete your call, turn the handset off, and recharge the battery pack, or
- If you have a charged spare battery pack, place your call on Hold and replace the handset battery pack with the spare battery pack. Wait 6 to 10 seconds, then turn the handset on and proceed as you would for any call placed on Hold.

NOTE:

When the battery power is low, the two beeps will sound each time either [*On/Off*] button is pressed until either the battery is drained or you replace the battery. If you continue talking, the handset will turn off when the battery pack is drained. Your call will be placed on Hold automatically so that you can swap battery packs or pick up the call on another telephone.

Volume Control

To increase or decrease the volume of the handset alerter or the receiver (earpiece):

- **Alerter:** Press the "+" or the "-" button while the MDW 9031 is awake but turned *off*. If the display is dark (the phone is in "sleep" mode), press  to wake it up, then press the "+" or the "-" button.
- **Receiver:** Press the "+" or the "-" button while the MDW 9031 is turned *on*.

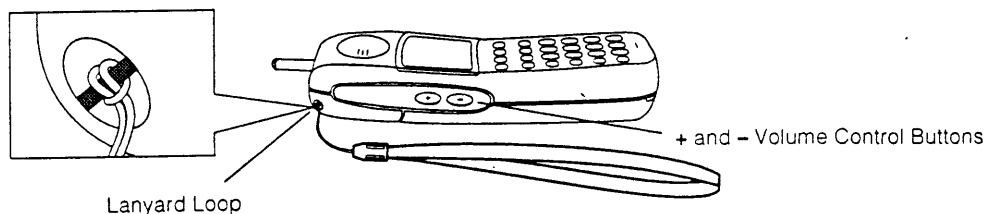

Carrying Your Pocketphone

The MDW 9031 Pocketphone has a loop in the upper corner to accommodate the included lanyard. You can attach the lanyard, as illustrated above, and slip the lanyard over your wrist to guard against dropping the phone. A leather carrying case is also available separately (see "Ordering Replacement & Optional Parts" in Chapter 4).

Each battery pack (standard or extended) also comes with its own detachable clip that you can attach to the back of the battery pack, enabling you to attach the phone to your belt or purse strap. Be sure to use the clip that matches the battery pack; they are not interchangeable. To attach the clip to the battery pack, do the following:

- 1** Remove the battery pack from the handset, as described in "Inserting and Removing the Handset's Battery Pack" in Chapter 2.
- 2** Place the two metal tabs on the clip into the slots on the battery pack, with the "hooks" toward the bottom of the battery pack.
- 3** Slide the clip toward the bottom of the battery pack to engage the hooks.
- 4** Reinsert the battery pack in the handset, as described in "Inserting and Removing the Handset's Battery Pack" in Chapter 2.

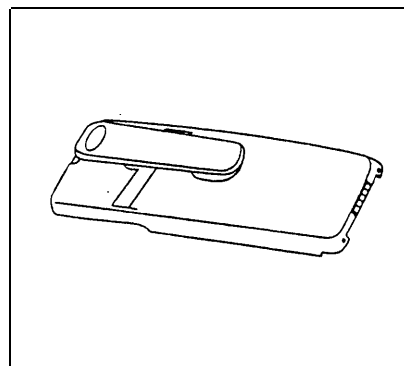
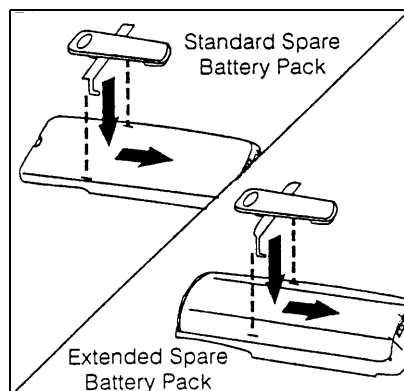

Antenna

The MDW 9031 Pocketphone comes with a user-replaceable, flexible, retractable antenna. For maximum range and voice quality, always fully extend the antenna before placing or answering a call. You can receive a call (if you are within range of the radio module) without extending the antenna, but you may get a **RANGE** indication. The antenna must be fully extended for optimal performance.



Changing the Handset Settings

You can use Local Mode to change the handset settings for these functions:

- Communications system button mapping
- Vibrator
- Line Preselection
- Backlighting
- Alerter



Local Mode also gives you access to Local Test Mode (which enables you to test the alerter, vibrator, and display) and Wireless Test Mode (which enables you to test sound clarity, signal strength, and voice quality). While in Local Mode, the MDW 9031 can still receive notification of incoming calls.

To access Local Mode, use the following procedure:

1. Make sure the handset is turned off.
2. Press and hold the Select button () for three seconds.
3. While still holding , press [On/Off].

The handset beeps twice, and the display shows the handset settings. For example, the following display indicates that the handset:

- Is using button mapping for a PARTNER switch
- Has the vibrator and Line Preselection enabled
- Has the alerter disabled

LCL: P	VIBR	PSEL	
			
5	6	7	8
1	2	3	4
A	B	C	D



To exit Local Mode, press [On/Off] .

Changing the Communications System Button Mapping Setting

If the MDW 9031 Pocketphone is set to use the wrong communications system, an error message saying **CHANGE BUTTN MAP** shows on the top line of the handset display each time the [On/Off] button is pressed. If you see this message, use the procedure described in "Changing the Communications System Setting" in Chapter 2 to specify the correct communications system setting.

Enabling or Disabling the Vibrator

The vibrator vibrates to alert you to an incoming call in situations where you do not want to disturb others with an audible ring. You can enable or disable the vibrator using the following procedure:

1. Make sure the handset is turned off.
2. Press and hold the Select button () for three seconds.
3. While still holding , press [*On/Off*].

The handset beeps twice, and the display shows the handset settings, indicating that you are now in Local Mode. (While in Local Mode, the MDW 9031 can still receive notification of incoming calls.)

If the vibrator is enabled, the **VIBR** icon appears in the display. For example:

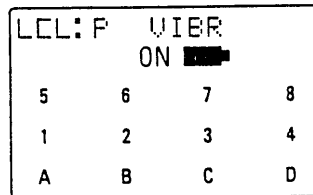

If the vibrator is disabled, no icon appears.

4. Press "V" ([*g*]) on the dialpad to enable or disable the vibrator.
5. Press [*On/Off*] to exit Local Mode.

NOTE:

Both the alerter and the vibrator can be disabled at the same time. In this case the only notification you have of an incoming call is that a line status indicator (a truncated triangle or a rectangle, depending on your communications system) flashes in the display.

Enabling or Disabling Line Preselection

Line Preselection lets you choose the line or button you want to use before turning the handset on. For example, suppose your phone is ringing but you want to pick up a call that is holding on another line instead of the ringing call. In normal operation, the communications system automatically connects you to the ringing line as soon as you turn on the handset. With Line Preselection enabled, you can select the line you want to connect to *before* turning on the handset.



NOTE:

Under certain conditions, the communications system tries to turn on a speaker; for example, if you use Line Preselection to select a button programmed for speed-dialing. Since the MDW 9031 Pocketphone has no speaker, the system causes the **ON** icon in the handset display to flutter, and the handset emits a continuous double beep. You must press [*On/Off*] to complete the connection.

NOTE:



When Line Preselection is enabled, you do not have to use it; however you cannot use it unless it is enabled.

To enable Line Preselection, use the following procedure:

1. Make sure the handset is turned off.
2. Press and hold the Select button () for three seconds.
3. While still holding , press [On/Off].

The handset beeps twice, and the display shows the handset settings, indicating you are in Local Mode. (While in Local Mode, the MDW 9031 can still receive notification of incoming calls.)



If Line Preselection is enabled, **PSEL** shows on the top line of the display. For example:

LCL: P	VIBR	PSEL	
			
5	6	7	8
1	2	3	4
A	B	C	D

If Line Preselection is disabled, no icon appears.

4. Press and hold "P" ([Z]) for three seconds.



The handset display shows **PRESELECTION:ON** if Line Preselection is enabled or **PRESELECTION:OFF** if Line Preselection is disabled. For example:

PRESELECTION: ON			
			
5	6	7	8
1	2	3	4
A	B	C	D

5. Press  to toggle between ON and OFF to enable or disable Line Preselection.
6. Press [On/Off] to exit Local Mode.

Enabling or Disabling Backlighting

Backlighting for the display is factory set to ON for the MDW 9031 Pocketphone. To toggle the Backlighting features OFF (and ON), use the following procedure:

1. Make sure the handset is turned off.
2. Press and hold the Select button() for three seconds.
3. While still holding ,press [On/Off].

The handset beeps twice, and the display shows the handset settings, indicating you are in Local Mode. (While in Local Mode, the MDW 9031 can still receive notification of incoming calls.)

- Press "L" ([5]) for "Lighting." The Backlighting toggles ON or OFF each time you press the [5].
- After setting the correct Backlighting state, press [On/Off] for normal Pocketphone use.

Enabling or Disabling the Alerter

The alerter is an audible signal to notify you of an incoming call. If a call comes in while the phone is idle, the handset rings. If you are already on a call, the handset chirps softly. You can adjust the volume of the alerter by pressing the "+" button or the "-" button on the side of the handset *when the phone is turned off*. You can enable or disable the alerter using the following procedure:

1. Make sure the handset is turned off.
2. Press and hold the Select button (ⓧ) for three seconds.
3. While still holding ⓧ, press [On/Off].

The handset beeps twice, and the display shows the handset settings, indicating you are in Local Mode. (While in Local Mode, the MDW 9031 can still receive notification of incoming calls.)

If the alerter is disabled, the **No Ring** icon (a bell with a line through it) appears in the second line of the display. For example:

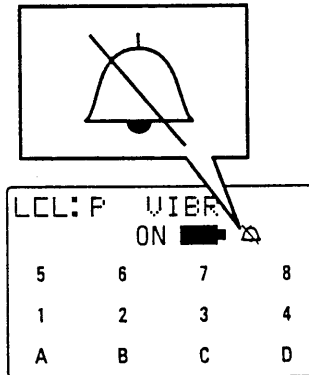

If the alerter is enabled, the icon is not displayed. For example:

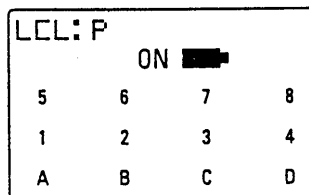

4. Press "A" ([2]) on the dialpad to enable or disable the alerter.
5. Press [On/Off] to exit Local Mode.

NOTE:

Both the alerter and the vibrator can be disabled at the same time. In this case the only notification you have of an incoming call is that a line status indicator (a truncated triangle or a rectangle, depending on your communications system) flashes in the display.

Test Modes

You can use Local Test Mode and Wireless Test Mode to verify that your handset is working properly and that the MDW 9031 system is performing optimally.

Using Local Test Mode

You can use Local Test Mode to activate the audio warning signal, the vibrator, and all visual indicators on the handset display, enabling you to test the following:

- Does the audio warning signal work?
- Does the vibrator vibrate?
- Is the display operational?
- Are the visuals bright and clear?

NOTE:

While in Local Test Mode, the MDW 9031 *cannot* make or receive calls.

1. Make sure the handset is turned off.
2. Press and hold the Select button (Ⓢ) for three seconds.
3. While still holding Ⓢ, press [On/Off].

The handset beeps twice, and the display shows the handset settings, indicating you are in Local Mode. (While in Local Mode, the MDW 9031 can still receive notification of incoming calls.)

4. Press [#] to enter Local Test Mode.

The handset emits two beeps, the vibrator vibrates, and *all* indicators on the display appear (including the rectangles and truncated triangles), as shown below.

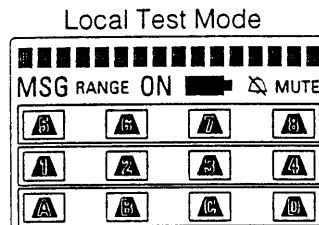

If the beeps do not sound, the vibrator does not vibrate, or the indicators do not appear, repeat Steps 1–4. If you still have problems, call for customer support as described on the inside front cover of this book.

3. Press [On/Off] once to exit both Local Test Mode and Local Mode.

You must exit Local Test Mode to reinstate proper call handling.

Using Wireless Test Mode



You can determine sound clarity, signal strength, and voice quality using Wireless Test Mode.

You should use Wireless Test Mode to help you locate the best place to install the radio module(s) to optimize the performance of your MDW 9031 Pocketphone. Repeat the tests several times, with the radio module positioned in a different location each time.

By performing the tests as you walk around the area in which the handset will be used, you can determine the handset's range and the voice quality throughout the area of coverage. To perform the tests, all you need is an electrical outlet for the radio module and a charged battery pack in the handset. You can perform the tests multiple times and in any order; and you can exit at any time by pressing [On/Off].

NOTE:

Ignore anything that displays if you press [4] while in Wireless Test Mode. These displays are for Lucent Technologies technicians' use only.

1. Make sure the handset is turned off.
2. Press and hold the Select button () for three seconds.
3. While still holding , press [On/Off].

The handset beeps twice, and the display shows the handset settings, indicating you are in Local Mode. (While in Local Mode, the MDW 9031 can still receive notification of incoming calls.)

4. Press "W" ([9]) to enter Wireless Test Mode.

WIRELESS TEST appears on the top line of the handset display.

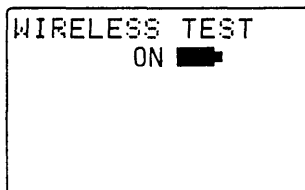

The handset beeps twice and, if the vibrator is enabled, it vibrates; then you hear a simulated dial tone. This dial tone continues until you exit Wireless Test Mode. While in this mode, the MDW 9031 *cannot* make or receive calls.

5. To identify the matching radio module for this handset, press [3].

The display indicates in which slot in the individual carrier (**SLOT:n**) the matching radio module is located, using a number (*n*) from 1 to 6. A stand-alone radio module is shown as **0**. For example:

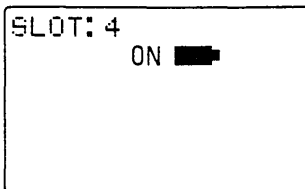

-
6. To determine **sound clarity**, listen to the simulated dial tone as you walk around.

A clear, steady tone indicates good sound clarity.

7. To determine **signal strength**, press [1].

The display shows the signal strength (**SIG**) for both the handset (**HS**) and the base (**B**) (the radio module) at the moment that [1] was pressed, using a number from 1 to 10, as shown in the following display.

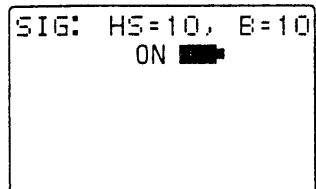

SIG: HS=10, B=10
ON []

The higher the number, the stronger the signal, as shown in the following table. You can press [1] again to show a subsequent signal-strength reading. Each time you press [1], you get a new reading.

Display Number	Signal Strength Is
10	Strong
9	Strong
8	Strong
7	Very good
6	Very good
5	Good
4	Good to Fair
3	Fair
2	Near end of range
1	Near end of range/loss of link

8. To determine **voice quality**, press [2].

The display shows the voice quality (**QUAL**) for both the handset (**HS**) and the base (**B**) (the radio module) using a number from 1 to 10, as shown in the following display.

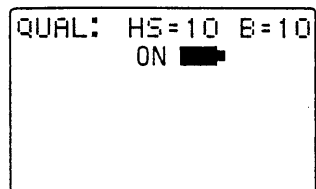

QUAL: HS=10 B=10
ON []

The higher the number, the better the voice quality, as shown in the table below. A low number may indicate potential interfering devices (such as another radio transmitter) in the area. You can press [2] again to show a subsequent voice-quality reading. Each time you press [2], you get a new reading.

Display Number	Voice Quality Is
10	Very good
9	Very good/almost error free
8	Errors, but not noticeable in normal speech
7	Errors, but not noticeable in normal speech
6	Noticeable noise
5	Noticeable noise
4	Noisy but intelligible speech
3	Noisy but intelligible speech
2	Garbled speech
1	Unintelligible speech

9. To determine **power level**, press [5].

The display shows the power level to which the handset (**HS**) and the base (**B**) (the radio module) have adjusted. The power level adjusts from low power (1) to high power (8) as the pocketphone is moved farther from its base. The following display shows the pocketphone at its highest setting.

```

CUR: FW: HS=8 B=8
      ON █████
  
```

10. To exit Wireless Test Mode and Local Mode, press [On/Off].



Go to **one** of the following sections:

- If installing **one MDW 9031 Pocketphone**, go to "Installing a Single Radio Module" in Chapter 2.
- If installing **one or more carriers**, go to "Understanding Carriers" in Chapter 2.

Performance/Range Test in Wireless Test Mode

Using the signal-strength test and the voice-quality test together, you can determine the range in which your MDW 9031 Pocketphone performs best at your site:

At 10–15 feet (3.1–4.6 m) from its radio module, use the following procedure:

1. Make sure the handset is turned off.
2. Press and hold the Select button () for three seconds.
3. While still holding , press [*On/Off*].

The handset beeps twice, and the display shows the handset settings, indicating you are in Local Mode. (While in Local Mode, the MDW 9031 can still receive notification of incoming calls.)

4. Press "W" () to enter Wireless Test Mode.

WIRELESS TEST appears on the top line of the handset display. The handset beeps twice and vibrates, then you hear a simulated dial tone. This dial tone continues until you exit Wireless Test Mode. While in this mode, the MDW 9031 *cannot* make or receive calls. For more information, see "Wireless Test Mode" in Chapter 3.

5. Press [*1*].

The display should show a **9** or **10** for signal strength. If it does not, see Chapter 5, "Troubleshooting," for help with range problems.

6. Press [*2*].

The display should show a **9** or **10** for voice quality. If it does not, see Chapter 5, "Troubleshooting," for help with range problems and/or voice quality problems.

7. Periodically check the signal strength and voice quality as you walk away from the radio module. Each time you press [*1*] or [*2*], you get a new reading.

When you see a signal strength of **3**, you are at the "edge of range" for the MDW 9030P Pocketphone. The distance will vary depending on the environment, building structure, and other factors. The range in an average office building is 500–700 feet (152.5–213.5 m). If, however, dense walls intervene, the distance could be less.

8. With a signal strength of **3**, press [*2*] to check the voice quality. When the voice quality is **7** or **8**, the voice connection should be satisfactory. This is the edge of your usable range.

The following diagram illustrates this Performance/Range test.

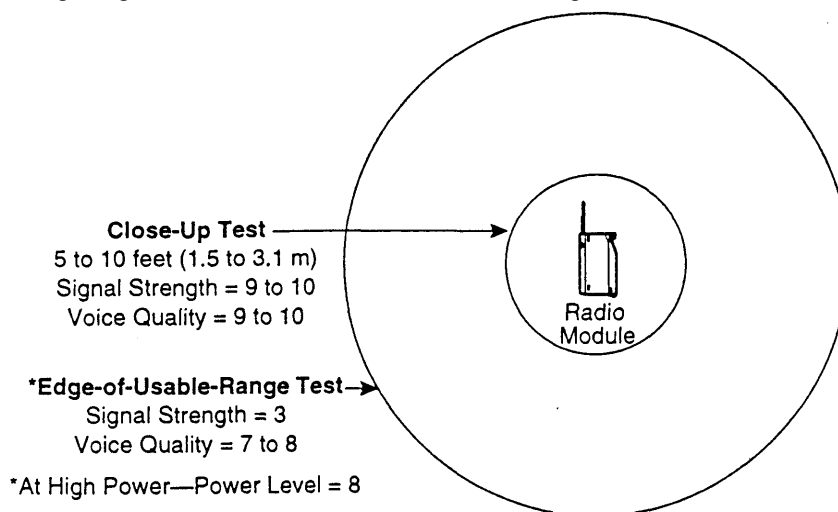

"Waking Up" the Phone

In addition to "On" and "Off," the MDW 9031 has an energy-saving "sleep" or "standby" mode. The MDW 9031 "goes to sleep" 15 seconds after activity ceases (that is, after an alert stops ringing or after you hang up).

The [*On/Off*] and (ⓧ) buttons "wake up" the phone. The headset and handset [*On/Off*] buttons turn the phone on, and the Select button ((ⓧ)) signals the phone that activity is occurring. You can activate the display to see whether you have a message or to check whether your alerter is enabled without actually turning the phone on (if the communications system is very busy, for instance) by pressing (ⓧ).

Making a Call

To make a call using your MDW 9031, use the following procedure:

1. Press the handset [*On/Off*] button (or the headset [*On/Off*] button if you have the headset attached) to turn the phone on.
 - The MDW 9031 seizes an available line and a truncated triangle or a small rectangle (depending on your communications system) appears around that line in the handset display.
 - You hear a dial tone.
2. Dial the call as you would on a wired system phone.
3. To end the call, press the [*On/Off*] button.

After 15 seconds, unless there is other activity on the phone, the handset goes into the energy-saving "sleep" mode.

Answering a Call

When you receive a call on your MDW 9031 Pocketphone, you hear a ringing tone if your alerter is enabled, or you feel a vibration in the handset if the vibrator is enabled, or both. To answer the call, use the following procedure:

1. Press the handset [*On/Off*] button (or the headset [*On/Off*] button if you have the headset attached) to turn the phone on.

You are automatically connected to the ringing line.
4. Speak into the handset to converse with your caller.
5. To end the call, press the [*On/Off*] button.



After 15 seconds, unless there is other activity on the phone, the handset goes into the energy-saving "sleep" mode.

Manually Selecting a Line or Programmed Button

When you are making or answering a call, the MDW 9031 automatically selects the line for you. In some situations, however, you may want to select a particular line (for example, to use an "800" line). To select a particular line or programmable/intercom/drop button, use the following procedure:

1. Press [*On/Off*].

The **ON** icon displays steadily, and you are connected to an available line.

2. If the Selection rectangle in the handset display is not surrounding the row that includes the line or button you want to use, press  one or more times until the rectangle encloses that row. (See "Column and Select Buttons" earlier in this chapter for more information.)
3. Press the  button that corresponds to the line or button within the Selection rectangle that you want to select.

You are connected to the line or you have access to the button you chose.



To deselect the line or button, press [*On/Off*].

For information about assigning features to buttons, see "Programming Features for PARTNER, MERLIN, and MERLIN LEGEND Systems" in Chapter 6.

Preselecting a Line

You may sometimes want to select a line other than the line to which the communications system automatically connects you. To preselect a line, you must first enable Line Preselection. See "Enabling or Disabling Line Preselection" earlier in this chapter.

Once Line Preselection is enabled, use the following procedure:

1. If the handset is "asleep," press  to wake it up and activate the display.
2. If the Selection rectangle in the handset display is not surrounding the row that includes the line you want to use, press  repeatedly until the rectangle encloses that row. (See "Column and Select Buttons" earlier in this chapter for more information.)
3. Press the  button that corresponds to the line within the Selection rectangle that you want to select.

The **ON** icon flashes in the display and the handset emits double beeps.

4. Press [*On/Off*].

The **ON** icon displays steadily, and you are connected to the line you chose.

Using a Headset

Lucent Technologies offers the Supra 9031 headset, which is specifically designed for use with your MDW 9031 wireless phone, or the Radium (over the ear) headset. A headset assists in call answering, and provides hands-free operation.

For ordering information, see "Ordering Replacement & Optional Parts" in Chapter 4.

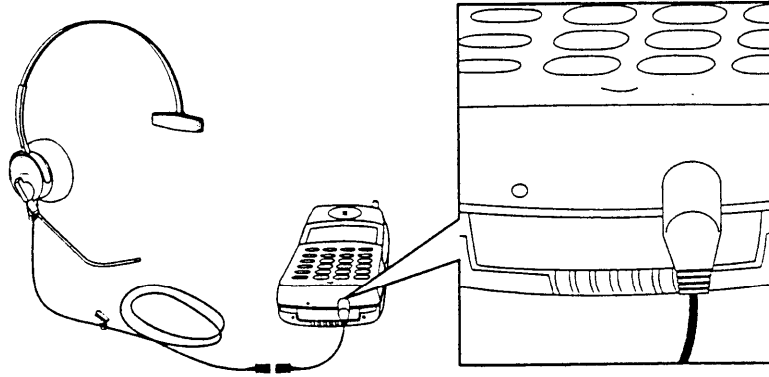

▲ CAUTION:
Plug ONLY the Supra 9031 headset cord or the Radium headset cord into the headset adapter.

NOTE:
Calls cannot be heard on the handset receiver when the headset is plugged in to the headset adapter. The handset microphone is also deactivated. The range of the handset is slightly diminished when you are using a headset. You may need to move closer to the radio module, or move the radio module closer to you.

If desired, you can disconnect the headset from the handset without dropping the call, either by unplugging the headset adapter from the handset, or by releasing the Quick Disconnect plug from the headset adapter cord. You can then use the handset as you normally would.

Using the Headset On/Off Button

The headset On/Off button near the antenna becomes active **only** when the headset is plugged into the headset connector. The headset On/Off button is identical in function to the [On/Off] button near the dialpad.

Answering Calls with a Headset

When you receive a call, you will hear a ringing tone or feel a vibration coming from the handset (you will not hear a tone from the headset itself). To answer the call, press either the headset On/Off button near the antenna or the [On/Off] button near the dialpad.

Placing Calls with a Headset

To place a call with a headset:

1. Press the On/Off button near the antenna or the [On/Off] near the dialpad to access an available line.

The microphone and earpiece in the handset are disabled.

2. Dial the call as you would on a wired system phone.
3. Press either the On/Off button near the antenna or the [On/Off] near the dialpad to end the call.

The Battery Charger

The battery charger charges battery packs in the Spare battery compartment and in the handset. If both are present at the same time, charging in the Spare battery compartment is suspended until the battery pack in the handset is fully charged. To enable extended phone usage, you should purchase an extra battery pack and store it in the charger, so that you always have a charged battery pack to switch to, if necessary. This section describes the battery charger and explains how to use battery packs properly.

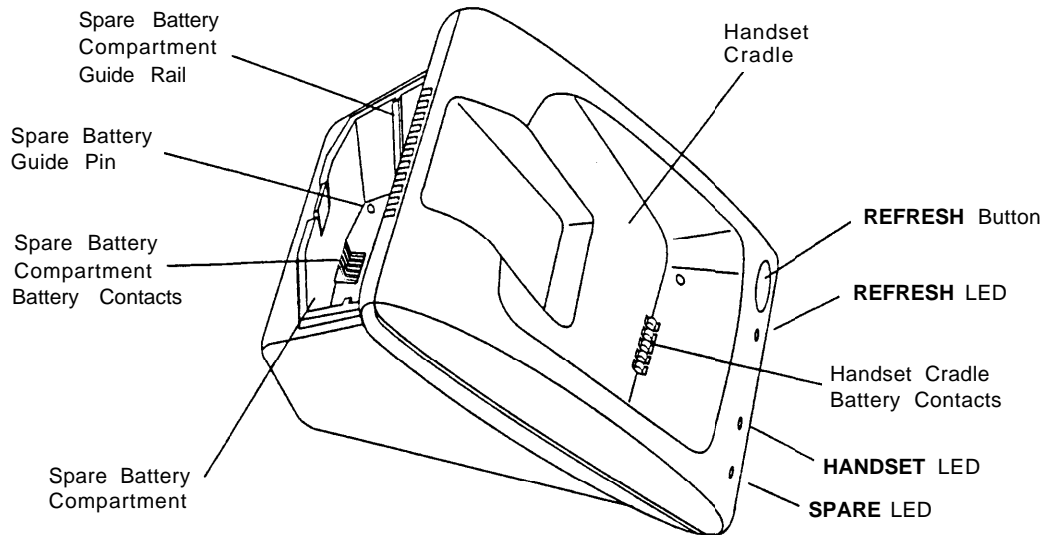

NOTE:

Do not touch, push, or pull any exposed battery contacts.

Battery Charger Features

The battery charger offers these features:

- The **Spare battery compartment** refreshes the battery pack automatically by fully *discharging* it before *recharging* it. This process reduces or eliminates the potential "memory" effect. Memory effect, which reduces a battery's capacity, occurs over time when you repeatedly recharge a battery before it is fully discharged.
- The **handset cradle** charges a battery pack in the handset.
- The **REFRESH button**, when pressed, refreshes the handset battery pack in the handset cradle by fully *discharging* the battery pack before *recharging* it.
- The **REFRESH LED** and the **HANDSET LED** light when the **REFRESH** button is pressed and stay lit until the battery pack finishes *discharging*.
- The **HANDSET LED**, when lit, indicates that the handset battery pack is installed in the handset, and the handset is in the handset cradle.
- The **SPARE LED**, when lit, indicates that a battery pack is in the Spare battery compartment.

The color of the battery charger's LEDs indicates the state of the corresponding battery pack, as shown in the following table:

Battery charger LED shows...	If it is the SPARE LED, the battery pack in the Spare battery compartment...	If it is the HANDSET LED, the battery pack in the Handset...	If it is the REFRESH LED, the Refresh button was pressed, and the Handset battery pack...
Steady orange	Is charging	Is charging	N/A
Steady green	Is fully charged	Is fully charged	N/A
Flashing red * See note	Has one of the following problems: <ul style="list-style-type: none"> • Is not seated properly in the charger • Has dirty contacts • Is defective 	Has one of the following problems: <ul style="list-style-type: none"> • Is not seated properly in the charger • Has dirty contacts • Is defective 	N/A
Steady red	Is in the Discharge portion of the Refresh cycle.	Is in the Discharge portion of the Refresh cycle.	Is in the Discharge portion of the Refresh cycle.

* **Note:** If *either* the **SPARE LED** or the **HANDSET LED** is flashing red, *both* battery packs must be removed from the charger to clear the flashing-red condition. Address the possible problems for one battery pack at a time to determine whether one is bad.

NOTE:

Before you use the MDW 9031 Pocketphone handset for the first time, the battery pack must be charged.

Extending Battery Life

The battery charger will charge a battery pack in the handset if you simply insert the handset in the battery charger's handset cradle; however, the Refresh process fully discharges the battery pack before recharging it, thereby ensuring the best possible charge and the longest talk time.

"Memory effect" reduces a battery's capacity, and can occur when you repeatedly recharge a battery pack before it is fully discharged. The nickel metal hydride battery pack shipped with your MDW 9031 is resistant to the memory effect. Even so, it is recommended that you refresh your battery pack at least once a week.

The following table shows how long refreshing takes, depending on how much charge is left in the battery pack when you insert it into the charger and press the **REFRESH** button

Battery-Pack	Battery-Pack Charge State	Discharge Time	Recharge Time	Total Time
Standard Battery Pack	Low charge (Battery icon is lit)	0.5 hours	1 hour	1.5 hours
	Full charge	3 hours	1 hour	4 hours
Extended Battery Pack	Low charge (Battery icon is lit)	0.5 hours	1.5 hours	2 hours
	Full charge	8 hours	1.5 hours	9.5 hours

Note that your handset will consume power both during talk time (when the handset is turned on) and during standby time (when the handset is turned off, but out of the battery charger). The following chart illustrates typical power usage.

Battery Use at Full Charge		
Type	Approximate Talk Time	Approximate Standby Time
Standard Battery Pack	3 hours	22 hours
Extended Battery Pack	8 hours	72 hours

As a guideline, you can expect a 1-hour reduction in talk time for every 7 hours of standby time. Similarly, you can expect a 7-hour reduction in standby time for every hour of talk time.

It is highly recommended that you purchase a second battery pack to use as a spare. With the spare battery pack in the Spare battery compartment of the battery charger, you are assured of always having a fresh, usable battery pack.

Follow these steps to ensure an uninterrupted supply of power to your MDW 9031 Pocketphone:

- If you have only one battery pack, be sure to refresh it at least once a week. You can refresh it by:
 - Placing it in the Spare battery compartment of the battery charger.
 - Leaving it in the handset, placing the handset in the handset cradle of the battery charger, and pressing the **REFRESH** button.
- If you have two battery packs, exchange the packs between the handset and the Spare battery compartment at least once a week, so that each battery pack is automatically refreshed. (Alternate the battery packs even if the handset battery never flashes the **Battery** icon in the handset display to indicate a low battery condition.)
- The average battery life for both the standard and the extended battery packs is approximately one year, assuming that the battery is discharged and charged once a day. If the battery packs are discharged and charged twice a day, the life expectancy is approximately six months.

IMPORTANT:

Depending on the level of memory effect that the battery pack has, it is sometimes necessary to refresh the battery pack twice:

Insert the battery pack in the Spare battery compartment of the battery charger and leave it there until the SPARE LED is steady green. Remove the battery pack from the charger, then reinsert it, and leave it until the SPARE LED is steady green a second time.

Or, with the battery pack in the handset, insert the handset in the handset cradle, press REFRESH, and leave it there until the HANDSET LED is steady green. Remove the handset from the handset cradle, then reinsert it, press REFRESH again, and leave it until the HANDSET LED is steady green a second time.

Maintaining the MDW 9031 Pocketphone

4

Important Safety Instructions

Please see "Important Safety Instructions" at the beginning of Chapter 2.

Removing a Radio Module from the Carrier

- See "Key Components" in Chapter 2 for additional picture detail.
- Slot 6 of an 117A3 control carrier must always contain a radio module to pass the synchronization signal to the next carrier.

- 1** Unplug the carrier(s) power cord/AC adapter from the wall outlet.

IMPORTANT:

When power is disconnected from the radio module or carrier, the receiver and alerter volumes are reset to the factory default settings.

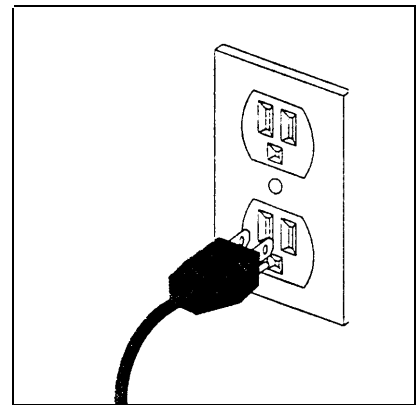

- 2** Unplug the telephone line cord from the bottom of the radio module.

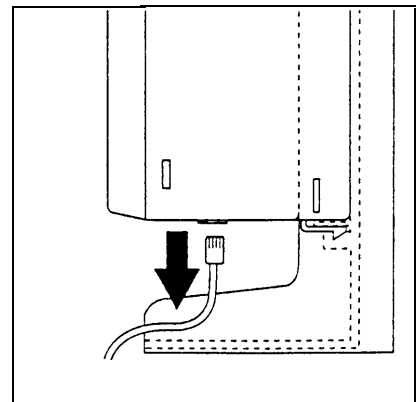

- 3** Press up and hold the snap lock on the bottom rear of the radio module.

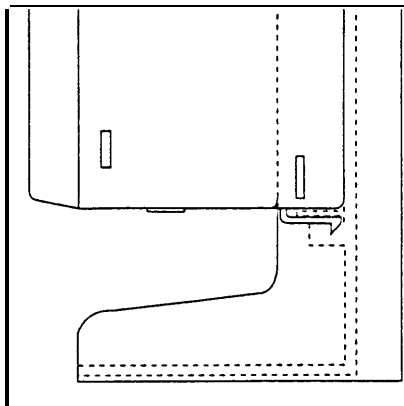

- 4** Slowly swing the radio module's card edge out of the card edge connector on the back of the carrier, releasing the snap lock when clear. Unhook the radio module from the radio module mounting rod by gently lifting upward.

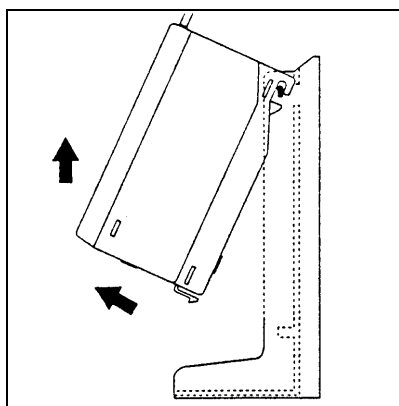

- 5** If you removed a radio module from Slot 6 of an 117A3 control carrier, you must insert another radio module into this slot. Failure to do so will cause the carriers to be unsynchronized.

- 6** Repower the carrier. If you have multiple carriers, repower them in order from left to right, as shown below:

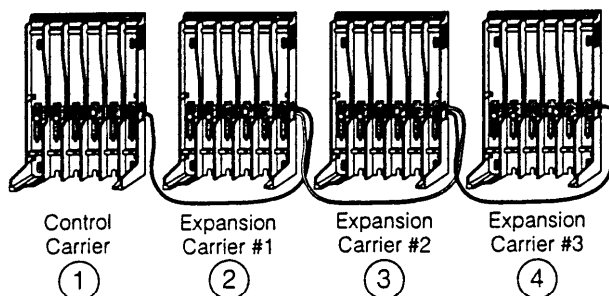

7 Wait a few seconds, then verify that the carrier's **OUT OF SYNC** LED is not lit. If the LED is lit, power down, wait at least 15 seconds, and then repower the carrier. If the LED is still lit, follow the suggestions in the "Installation Problems" section of Chapter 5, "Troubleshooting." If the LED is still lit, call for help as described on the inside front cover of this book.

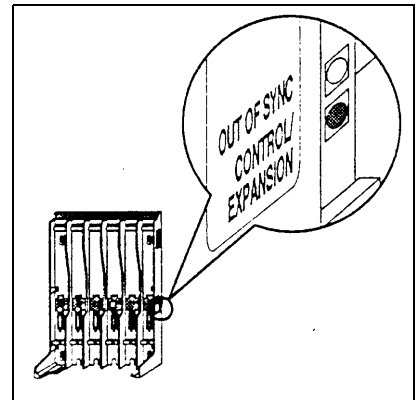

8 For any Model 117A4 carriers, verify that the **CONTROL/EXPANSION** LED is lit. For the control carrier, this LED is green. For an expansion carrier, this LED is amber.

9 Reset the receiver and alerter volumes that reverted to the default settings when the system was powered down (see "Changing the Handset Settings" in Chapter 3).

Swapping Extensions

If you want to change your phone's extension number assignment, make sure the radio module or carrier(s) is unplugged before you unplug the telephone line cord from the communications system switch/control unit. **Power down and then repower the carrier(s) after all extension changes are made.**

1 Unplug the carrier(s) power cord/AC adapter from the wall outlet.

IMPORTANT:

When power is disconnected from the radio module or carrier, the receiver and alerter volumes are reset to the factory default settings.

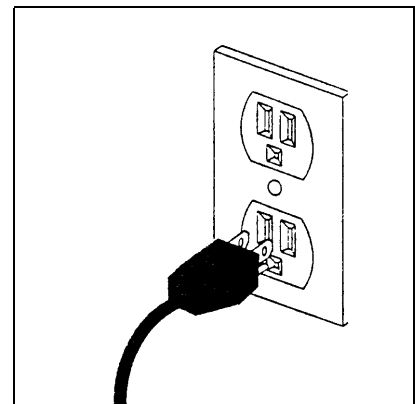

2 Unplug the telephone line cords from the communications system switch/control unit for the extensions that you want to change.

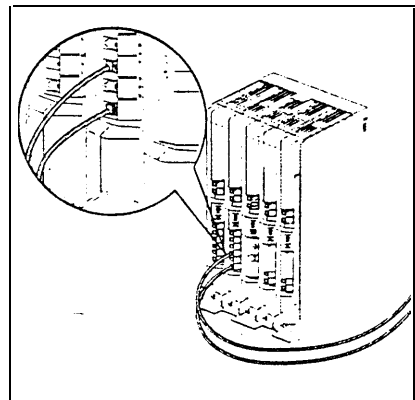

3 Insert the telephone line cords for the extensions that you want to change into the desired extension jack or terminal/station connector on your communications system switch/control unit.

- 4** Repower the carrier. If you have multiple carriers, repower them in order from left to right, as shown below:

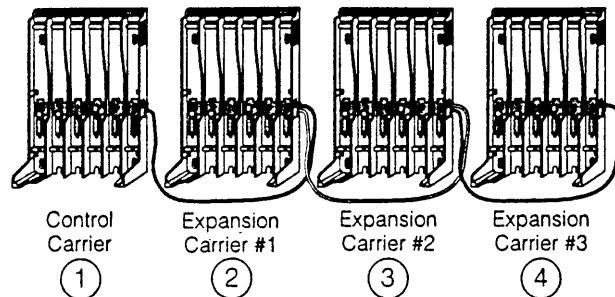

- 5** Wait a few seconds, then verify that the carrier's **OUT OF SYNC** LED is not lit. If the LED is lit, power down, wait at least 15 seconds, and then repower the carrier. If the LED is still lit, follow the suggestions in the "Installation Problems" section of Chapter 5, "Troubleshooting." If the LED is still lit, call for help as described on the inside front cover of this book.

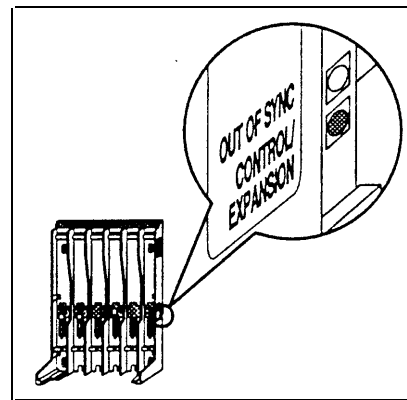

- 6** For any Model 117A4 carriers, verify that the **CONTROL/EXPANSION** LED is lit. For the control carrier, this LED is green. For an expansion carrier, this LED is amber.

- 7** Reset the receiver and alerter volumes that reverted to the default settings when the system was powered down (see "Changing the Handset Settings" in Chapter 3).

Replacing the Antenna

If the antenna on your MDW 9031 Pocketphone handset becomes damaged, you can order a replacement antenna (see "Ordering Replacement & Optional Parts" later in this chapter), and replace it yourself.

To replace the antenna, use the following procedure:

1. Fully retract the antenna.
2. Grasping the base of the antenna, unscrew it by turning it counterclockwise.
3. Grasping the base of the new antenna, screw it into the handset in a clockwise direction.

Ordering Replacement & Optional Parts

To order replacement parts or optional equipment in the continental U.S., call the Sourcebook Sales, Catalog Sales, or National Parts Sales Center toll free. When ordering, please use the part numbers shown in the table below:

Item	Sourcebook Sales 1 800 451-2100	Catalog Sales 1 800 635-8866	National Parts Sales Center 1 800 222-PART
MDW 9031 Pocketphone (Stand-Alone). Includes Radio Module and Kit of Parts	3204-05B	3204-05B	10804652 (for Pocketphone) 107586828 (for Kit of Parts)
MDW 9031 Pocketphone System (requires Carrier). Includes Radio Module, but not Kit of Parts	3204-W5B	3204-W5B	107733081
Retractable Flex Antenna for MDW 9031 Pocketphone Handset	NA	NA	847713450
Standard Battery Pack. Includes Carrying Clip	32045A	32045A	107733107
Carrying Clip (for Standard Battery Pack)	NA	NA	847773140
Extended Battery Pack. Includes Carrying Clip	320490	320490	107733115
Carrying Clip (for Extended Battery Pack)	NA	NA	847773157
Lanyard	NA	NA	407183417
MDW 9031 Pocketphone Leather Carrying Case	32043A	32043A	847877487
Headset Leather Carrying Case	32090A	32090A	
Power Cord/AC Adapter for Radio Module (11 foot (3.4m))	NA	NA	847523404
Battery Charger. Includes Power Cord/AC Adapter	32047A	32047A	107733099
Power Cord/AC Adapter for Battery Charger (11 foot (3.4m))	NA	NA	847713583
Carrier—Includes: ■ Power Cord and AC Adapter for Carrier (25 foot (7.6m)) ■ Expansion Cable for Multiple- Carrier Installation (6 foot (1.8m))	3204-CR2A	3204-CR2A	107907289 (for 117A3) 107955122 (for 117A4)
Power Cord and AC Adapter for Carrier (25 foot (7.6m))	NA	NA	847224227
Expansion Cable for Multiple- Carrier Installation (6 foot (1.8m))	32035A	32035A	847667870
Telephone Line Cord (8 foot (2.4m))	NA	NA	103786794
Supra 9031 Headset with Adapter	3122-042A	3122-042A	407654490
9031 Quick Disconnect Adapter for Supra 9031 or Radium Headset	3124-TLK	3124-TLK	848047965
Radium (Over the Ear) Headset with Adapter	3122-043A	3122-043A	407720739
Kit of Parts (for Stand-Alone MDW 9031 Installation)	D-182866	D-182866	107586828

Outside the continental U.S., contact your Lucent Technologies Representative or local Authorized Dealer.

Troubleshooting

5

Procedures

If you have a problem with your MDW 9031 Pocketphone, you may be able to solve it by following the procedures included in this chapter. If you cannot resolve the problem, call for customer support as described on the inside front cover of this book.

The problems in this chapter are organized as follows:

- Installation
- Handset
- Battery
- Voice Quality
- Range
- Battery Charger

Installation Problems

Symptom	Possible Causes	Possible Solutions
One or more OUT OF SYNC LEDs are lit, radio module PASS LEDs are not lit, or both.	Expansion cable is installed in the wrong IN or OUT jack, or is not fully inserted into the correct jack.	1. Verify that all expansion cables are fully inserted in the correct IN and OUT jacks. 2. Check CONTROL/EXPANSION LEDs for correct color (see "Understanding the Model 117A4 Carrier" in Chapter 2). 3. Ensure that each carrier has at least one Radio Module installed. If the control carrier is a Model 117A3, ensure that there is a Radio Module in that carrier's Slot 6. 4. Power down all carriers, wait 15 seconds, repower the control carrier, then repower the expansion carriers in order, from left to right.
	Carriers were not powered in the correct order.	
	A telephone line cord was disconnected and reconnected without powering down, waiting 15 seconds, and repowering the carrier(s).	

Installation Problems (continued)

Symptom	Possible Causes	Possible Solutions
After <u>you plug</u> the radio module or carrier into an electrical outlet, one or more radio module POWER and PASS LEDs do not light.	Radio module or carrier(s) is plugged into an electrical outlet controlled by a switch.	Plug the radio module or carrier(s) into an outlet not controlled by a switch.
	Power cord of radio module is not inserted properly.	Unplug the radio module's power cord/AC adapter from the electrical outlet and from the radio module. <u>Wait 15 seconds</u> . Carefully reinsert the power cord/AC adapter into the radio module and into the electrical outlet. Repeat for each radio module.
	Power cord of carrier(s) is not inserted properly.	Unplug the carrier's power cord from the electrical outlet. Unplug the AC adapter from the carrier and from the power cord. Carefully reinsert the AC adapter into the carrier and into the power cord. Repeat for each carrier. After waiting 15 seconds, plug the power cord back into the electrical outlet. (If you have multiple carriers, repower the control carrier first, and then power the expansion carriers in order from left to right; or use a surge-protector strip to repower all the carriers at one time.)
	Power cord of radio module or carrier(s) is defective.	Call for help.*
After <u>you plug</u> the radio module into an electrical outlet, the radio module's POWER LED lights, but the PASS LED does not light.	The radio module is malfunctioning.	Replace the radio module.

* See "Customer Support" on the inside front cover of this book.

Installation Problems (continued)

Symptom	Possible Causes	Possible Solutions
After <u>you plug</u> the carrier into an electrical outlet, the PASS LED of one or more radio modules does not light.	Radio modules are out of synchronization.	Power down the carrier, wait 15 seconds, and repower it. If you have multiple carriers, repower the control carrier first, and then power the expansion carriers in order from left to right; or use a surge-protector strip to repower all of the carriers at one time.) If the problem persists, call for help.*
	A radio module is malfunctioning.	<ol style="list-style-type: none"> 1. Remove all but one radio module from the carrier. (See "Removing a Radio Module from the Carrier" in Chapter 4.) 2. Test each radio module individually, verifying that the POWER and PASS LEDs on each radio module light when the carrier is powered. 3. If the PASS LED does not light, the radio module is malfunctioning. Replace the radio module and handset.
A defective radio module was replaced, and now all the handsets have less range than before, and the voice quality has deteriorated.	The radio module was inserted without first powering down the carrier. The carrier is out of synchronization.	Power down the carrier, wait 15 seconds, and repower it. If you have multiple carriers, repower the control carrier first, and then power the expansion carriers in order from left to right; or use a surge-protector strip to repower all of the carriers at one time.) If the problem persists, call for help.*
When turned on, the handset display shows lines going on hold and line selections changing without any buttons being pressed.	Electrical outlets may not be up to specifications. Electrical problems, such as no ground or floating ground, can cause the switch to send or receive spurious current, causing problems in switch protocol.	Verify that the outlets for the communications system switch and for the carrier(s) meet electrical requirements. (See "AC Outlet Check" in Chapter 2.)

* See "Customer Support" on the inside front cover of this book.



Installation Problems (continued)

Symptom	Possible Causes	Possible Solutions
<p>The LEDs on the carriers were displaying correctly according to the three self tests in "Installing Multiple Carriers" when you installed the carriers and radio modules, but now the LED conditions have changed.</p>	<p>A radio module is malfunctioning.</p>	<p>Locate the malfunctioning radio module by using the following procedure:</p> <ol style="list-style-type: none"> 1. Power down all carriers. 2. Remove the rightmost radio module. 3. Wait 15 seconds. 4. Repower the carriers in order from left to right. 5. Repeat the above steps as often as necessary, removing the modules one by one, working from right to left, until the LED conditions revert back to one of the following: <ul style="list-style-type: none"> ■ With no radio modules in the carriers: <ul style="list-style-type: none"> — OUT OF SYNC = all lighted — CONTROL/EXPANSION = all lighted (green), <p style="text-align: center;">or</p> <ul style="list-style-type: none"> ■ With one or more radio modules in each carrier: <ul style="list-style-type: none"> — OUT OF SYNC = not lighted — CONTROL/EXPANSION = all lighted <ul style="list-style-type: none"> ■ Control carrier = green ■ Expansion carrier(s) = amber <p>The last radio module that you removed before the lights reverted to the proper display is the malfunctioning one.</p> 6. Power down the carriers again. 7. Replace the malfunctioning radio module with a good one. 8. Repower the carriers again, in order from left to right, to verify that the replacement module functions properly. If the LEDs match one of the displays described in Step 5, the radio module is functioning as it should. 9. Power down the carriers again. 10. Reinsert the remaining radio modules into their slots. 11. Repower the carriers again, in order from left to right.

Handset Problems

Symptom	Possible Causes	Possible Solutions
After you press [<i>On/Off</i>], display does not show anything.	There is no battery pack in the handset.	Insert a battery pack in the handset.
	Battery pack is not inserted properly in the handset.	Reinsert the battery pack in the handset.
	Battery pack is not charged.	Place the handset with its battery into the handset cradle until fully charged, or remove the handset battery pack, and place it in the battery charger's Spare battery compartment until fully charged. If you have a charged battery pack, use it while the other battery pack recharges.
After you press [<i>On/Off</i>], the handset double beeps, RANGE flashes in the display, and then the display goes blink.	Handset is out of range of its matching radio module.	<ul style="list-style-type: none"> ■ Fully extend the handset antenna. ■ Move the handset closer to the radio module.
	Serial numbers for the handset and the radio module do not match.	The handset and radio module must be a matched pair.
	Another electrical device or metal walls are causing interference.	Remove the electrical device that is causing interference, or move the handset or the radio module to another location.
	Radio module is not powered.	Power the radio module.
After you press [<i>On/Off</i>], dial tone is not heard.	Telephone line cord is not plugged into the radio module.	Power down the radio module or carrier(s). Wait 15 seconds. Plug the telephone line cord into the radio module, then repower the radio module or carrier(s).
	The communications system switch is not operating properly.	Check the wiring for the switch, and verify that the switch has power.
	Station wiring is incorrect.	Check the switch manual's station port wiring configuration.

Handset Problems (continued)

Symptom	Possible Causes	Possible Solutions
You can hear the party on the other end, but they cannot hear you, MUTE appears in the handset display.	The [<i>Mute</i>] button was pressed inadvertently.	Press [<i>Mute</i>] again to turn off the mute feature.
When placed in the battery charger's handset cradle, the handset does not turn off.	Battery charger is plugged into an electrical outlet controlled by a switch, and the switch is turned off.	Plug the battery charger into an outlet not controlled by a switch.
	Battery charger's power cord is not inserted or is not inserted properly.	<ol style="list-style-type: none"> 1. Unplug the power cord/AC adapter from the electrical outlet. 2. Disconnect the power cord/AC adapter from the battery charger. 3. Carefully reconnect the power cord/AC adapter to the battery charger. 4. Plug the power cord/AC adapter back into the electrical outlet.
Handset does not ring or vibrate.	Alerter is disabled and vibrator is disabled.	Enable the alerter and/or the vibrator.
After you press [<i>On/Off</i>] or  , display does not light.	Handset must be programmed for backlighting.	Enable the backlighting (see "Enabling or Disabling Backlighting" in Chapter 3).
After you press [<i>On/Off</i>] or  , the handset does not wake up or turn on.	<ul style="list-style-type: none"> ■ Battery pack may not be charged. ■ Battery pack may have malfunctioned. 	<p>If you have one, try a different battery pack.</p> <p>Call for help.*</p>
Your handset shows CHANGE BUTTN MAP in the display when you try to use it.	Your handset is not mapped to the correct switch.	Change the handset button mapping. See "Changing the Communications System Setting" in Chapter 2.
	If your handset is mapped to the correct switch, but you are still getting the message, your station wiring is incorrect.	Check your station wiring, referring to the table in "Radio Module/Switch Wiring" in Chapter 2.

* See "Customer Support" on the inside front cover of this book.

Battery Problems

Symptom	Possible Causes	Possible Solutions
The Battery icon appears in the handset display.	This is normal operation for the MDW 9031 Pocketphone.	No action is required.
The Battery icon flashes in the handset display and the handset beeps twice.	Battery power is low.	You have 5 minutes or less of talk time left. Either: <ul style="list-style-type: none"> ■ Complete your call, turn the handset off, and recharge the battery pack. ■ If you have a fully charged spare battery pack, place your call on Hold. Swap the battery packs. Wait 6 to 10 seconds, then turn the handset on and proceed as you would for any call placed on Hold.
The handset battery pack does not last as long as it used to under similar conditions.	The battery pack needs to be refreshed.	When the Battery icon flashes, insert the handset with its battery into the handset cradle and press the REFRESH button, or insert the handset battery pack into the Spare battery compartment until the SPARE LED is steady green (1.5 hours).
You get less than 3 hours of talk time when you use a <u>standard</u> battery pack that was refreshed.	The battery pack needs to be refreshed a second time.	Refresh the battery pack.
You get less than 8 hours of talk time when you use an extended battery pack that was refreshed.	The battery pack needs to be refreshed a second time.	Refresh the battery pack.
When a battery pack or the handset with battery pack is placed in the charger, the appropriate LED (SPARE or HAND-SET) does not light.	The battery pack may have malfunctioned.	If you have one, try a different battery pack. Call for help.*

* See "Customer Support" on the inside front cover of this book.

Voice Quality Problems

Symptom	Possible Causes	Possible Solutions
Handset voice quality and range are not as good as they were before.	A competing radio device (for example, a wireless bar-code scanner) has been installed in the area. Both products are competing for the same air space and will conflict when both are being used.	Place the handset in Wireless Test Mode as described in Chapter 3. If the signal strength and voice quality readings are low, look for a newly installed radio device nearby. Remove it or move your handset's matching radio module at least 6 feet (1.8 m) away from the potential interference.
	<u>Carrier(s) are out of synchronization (the OUT OF SYNC LED is lit).</u>	<p>For a single-carrier installation, power down, wait 15 seconds, then repower the carrier.</p> <p>For a multiple-carrier installation:</p> <ol style="list-style-type: none"> 1. Verify that all expansion cables are fully inserted in the correct IN and OUT jacks. 2. Check CONTROL/EXPANSION LEDs for correct color (see "Understanding the Model 117A4 Carrier" in Chapter 2). 3. Ensure that each carrier has at least one Radio Module installed. If the control carrier is a Model 117A3, ensure that there is a Radio Module in that carrier's Slot 6. 4. Power down all carriers, wait 15 seconds, repower the control carrier, then repower the expansion carriers in order, from left to right.
	Antenna of the radio module is too close to the ceiling.	Reinstall the radio module or carrier(s) so that the radio module antenna is 6–12 inches (15.2–30.5 cm) from the ceiling.
	You have a malfunctioning radio module.	<ol style="list-style-type: none"> 1. Remove all but one radio module from the carrier. (See "Removing a Radio Module from the Carrier" in Chapter 4.) 2. Test each radio module individually, verifying that the POWER and PASS LEDs on each radio module lights when the carrier is powered, <u>and that the OUT OF SYNC LED is not lit.</u> 3. If the PASS LED does not light, the radio module is malfunctioning. Replace the radio module and handset.

Voice Quality Problems (continued)

Symptom	Possible Causes	Possible Solutions
Voice quality in a specific location is poor and noisy.	Handset is too close to the carrier(s).	Move the handset at least 6 feet (1.8 m) away for a one- or two-carrier setup, or 10 feet (3.1 m) away for a three-carrier setup.
Voice quality for calls is lower than expected.	The handset antenna is only partially extended.	Fully extend the handset antenna.
	There are environmental limitations.	Reinstall the radio module or carrier away from electrical equipment and as high as possible on the wall (but with radio module antennas 6–12 inches (15.2–30.5 cm) from the ceiling). See "General Positioning Rules" in Chapter 2 for more information.
	You are using different models of handsets and the mix is incompatible with the carrier.	See "TransTalk 9000 System" in Chapter 1.
Volume is too low at any setting and there is noise on the line.	Handset or radio module is not working properly.	Place the handset in Wireless Test Mode and determine signal strength and voice quality as described in Chapter 3. Use the Close-Up Test described in "Performance/Range Test in Wireless Test Mode" in Chapter 3.
	The connection between the radio module and the communications system switch/control unit is incorrect.	Check the connection between the radio module and the communications system switch/control unit, as described in Chapter 2.
	Telephone line may be producing noise.	Report line trouble to your local phone company.
Your business has two or more wireless phones installed and all handsets seem to have developed interference problems at the same time.	There was a recent occurrence of lightning, or a power failure.	<ol style="list-style-type: none"> 1. Unplug the carrier(s) power cord(s) from the electrical outlet. 2. Wait <u>15</u> seconds, then repower the carrier(s) in order, from left to right.

Voice Quality Problems (continued)

Symptom	Possible Causes	Possible Solutions
You are on a call and you hear radio interference when another call rings.	Communications system in key mode has all lines set to ring. An incoming call "wakes up" all of the other radio modules at the same time to ring the other phones.	Refer to Chapter 6, "MDW 9031 Pocketphone Compatibility," to reset line ringing options.
Voice quality for a call in progress degrades for more than 6 seconds (PARTNER, PARTNER Plus, PARTNER II in key mode, MERLIN, MERLIN Plus, and MERLIN II phone systems only).	Line ringing options are incorrectly set for extensions with radio modules in the first expansion carrier.	Refer to Chapter 6, "MDW 9031 Pocketphone Compatibility," to reset line ringing options.

Range Problems

Symptom	Possible Causes	Possible Solutions
Handset voice quality and range are not as good as they were before.	A competing radio device (for example, a wireless bar-code scanner) has been installed in the area. Both products are competing for the same air space and will conflict when both are being used.	Place the handset in Wireless Test Mode as described in Chapter 3. If the signal strength and voice quality readings are low, look for a newly installed radio device nearby. Remove it or move your handset's matching radio module at least 6 feet (1.8 m) away from the potential interference.
	Carrier(s) are out of synchronization (the OUT OF SYNC) LED is lit).	<p>For a single-carrier installation, power down, wait 15 seconds, then repower the carrier.</p> <p>For a multiple-carrier installation:</p> <ol style="list-style-type: none"> 1. Verify that all expansion cables are fully inserted in the correct IN and OUT jacks. 2. Check CONTROL/EXPANSION LEDs for correct color (see "Understanding the Model 117A4 Carrier" in Chapter 2). 3. Ensure that each carrier has at least one Radio Module installed. If the control carrier is a Model 117A3, ensure that there is a Radio Module in that carrier's Slot 6. 4. Power down all carriers, wait 15 seconds, repower the control carrier, then repower the expansion carriers in order, from left to right.
	Antenna of the radio module is too close to the ceiling.	Reinstall the radio module or carrier(s) so that the radio module antenna is 6–12 inches (15.2–30.5 cm) from the ceiling.

(Continued on next page)

Range Problems (continued)

Symptom	Possible Causes	Possible Solutions
(Continued)	You have a malfunctioning radio module.	<ol style="list-style-type: none"> 1. Remove all but one radio module from the carrier. (See "Removing a Radio Module from the Carrier" in Chapter 4.) 2. Test each radio module individually, verifying that the POWER and PASS LEDs on each radio module light when the carrier is powered, <u>and that the OUT OF SYNC LED is not lit.</u> 3. If the PASS LED does not light, the radio module is malfunctioning. Replace the radio module and handset.
Handset voice quality and range are not as good as they were before.	Electromagnetic fields are interfering.	Look for 110/Volt lines, fuse boxes, circuit breakers, electrical junction boxes, or similar items. Move the carrier or radio module at least 6 feet (1.8 m) away from the potential interference.
	There is a large metal object within 3 feet (1.2 m) of the radio module.	Move the carrier or radio module at least 3 feet (1.2 m) away from the potential interference.
	There is a large metal object in the "line of sight" to the radio module.	Move the metal object, or move the carrier or radio module.
Range for calls is lower than expected	The handset antenna is only partially extended.	Fully extend the handset antenna.
	There are environmental limitations.	Reinstall the radio module or carrier away from electrical equipment and as high as possible on the wall (but with radio module antennas 6-12 inches (15.2–30.5 cm) from the ceiling). See "General Positioning Rules" in Chapter 2 for more information.
	You are using different models of handsets and the mix is incompatible with the carrier.	See "TransTalk 9000 System" in Chapter 1.

Range Problems (continued)

Symptom	Possible Causes	Possible Solutions
No ring on an incoming call.	Handset is out of range of its matching radio module.	Move the handset closer to the radio module.
	<ul style="list-style-type: none"> ■ Station wiring is incorrect. ■ Radio module station wiring is not connected to the switch. 	Check your switch manual for switch settings and station wiring diagrams.
	Station port is set to NO RING.	Check your switch manual for the correct settings.
While you are talking and walking, the handset beeps and RANGE flashes in the handset display.	Handset antenna is not fully extended.	Fully extend the handset antenna.
	You are approaching an out-of-range condition.	Move back towards the handset's matching radio module until the display stops showing RANGE .
While <u>you are</u> talking and walking, the handset beeps and RANGE flashes in the handset display. You keep walking away from the handset's matching radio module, <u>the handset double beeps five times</u> , the display goes blank, and your call appears to be disconnected.	You are out of range of the radio module. YOUR CALL HAS NOT BEEN DISCONNECTED. IT HAS BEEN PLACED ON HOLD.	Move back towards the radio module. Press [<i>On/Off</i>], then proceed as you would for any call placed on Hold.
After placing a call on Hold, you walk away from the handset's matching radio module. Your handset beeps, the handset display flashes RANGE , and your call appears to be disconnected.	You are out of range of the radio module. YOUR CALL HAS NOT BEEN DISCONNECTED. IT IS STILL ON HOLD.	Move back towards the radio module. Press [<i>On/Off</i>], then proceed as you would for any call placed on Hold.

Battery Charger Problems

Symptom	Possible Causes	Possible Solutions
No LEDs on battery charger light.	Battery charger is plugged into an electrical outlet controlled by a switch and the switch is turned off.	Plug the battery charger into an outlet not controlled by a switch.
HANDSET LED on battery charger does not light when handset is placed in battery charger.	Handset is not seated properly in battery charger's handset cradle.	Reseat the handset in the battery charger's handset cradle, as described in Chapter 3.
	The contacts in the handset cradle or on the battery pack are dirty.	<ol style="list-style-type: none"> 1. Verify that there are no obstructions on the handset or battery charger contacts. 2. Unplug the charger and clean the contacts with a soft eraser. 3. Clean the handset contacts with a soft eraser.
	The battery pack is defective.	<p>If you have a fully charged spare battery pack, use it to replace the battery pack in the handset.</p> <ol style="list-style-type: none"> 1. Place the questionable battery pack in the battery charger's Spare battery compartment. 2. Wait one minute. If the SPARE LED flashes red, order a new battery pack.

Battery Charger Problems (continued)

Symptom	Possible Causes	Possible Solutions
HANDSET LED flashes red.	Battery pack is defective.	If you have a battery pack in the handset and one in the Spare battery compartment, remove <i>both</i> battery packs from the charger to clear the red flashing LED. Then test each battery pack separately as follows: <ol style="list-style-type: none"> Place the battery pack in the battery charger's Spare battery compartment. Wait one minute. If the SPARE LED flashes red, order a new battery pack.
	The contacts in the handset cradle or on the battery pack are dirty.	<ol style="list-style-type: none"> Verify that there are no obstructions on the handset or battery charger contacts. Unplug the charger and clean the contacts with a soft eraser. Clean the handset contacts with a soft eraser.
	Handset is not seated properly in battery charger's handset cradle	Reseat the handset in the battery charger's handset cradle, as described in Chapter 3.

Battery Charger Problems (continued)

Symptom	Possible Causes	Possible Solutions
SPARE LED on battery charger does not light when the battery pack is placed in Spare battery compartment.	The battery pack is not seated properly in Spare battery compartment.	Reseat the battery pack in the battery charger's Spare battery compartment.
	The contacts on the battery pack or in the Spare battery compartment are dirty.	<ol style="list-style-type: none"> 1. Verify that there are no obstructions on the battery pack or battery charger contacts. 2. Unplug the charger and clean the contacts with a soft eraser. 3. Clean the battery pack contacts with a soft eraser.
	The battery pack is defective.	<ol style="list-style-type: none"> 1. Insert the questionable battery pack in the handset and place the handset in the handset cradle. 2. Wait one minute. If the HANDSET LED flashes red, order a new battery pack.

Battery Charger Problems (continued)

Symptom	Possible Causes	Possible Solutions
SPARE LED flashes red.	Battery pack is defective.	<p>If you have a battery pack in the handset and one in the Spare battery compartment, remove <i>both</i> battery packs from the charger to clear the red flashing LED. Then test each battery pack separately as follows:</p> <ol style="list-style-type: none"> 1. Insert the battery pack in handset and place the handset in the battery charger's handset cradle. 2. Wait one minute. If the HANDSET LED flashes red, order a new battery pack.
	The contacts on the battery pack or in the battery charger's Spare battery compartment are dirty.	<ol style="list-style-type: none"> 1. Verify that there are no obstructions on the battery pack or battery charger contacts. 2. Unplug the charger and clean the contacts with a soft eraser. 3. Clean the battery pack contacts with a soft eraser.
	The battery pack is not seated properly in Spare battery compartment.	Reseat the battery pack in the battery charger's Spare battery compartment, as described in Chapter 3.
Handset is in the battery charger cradle and the HANDSET LED does not light.	Handset is not seated properly in the battery charger cradle.	Reseat the handset in the battery charger cradle.
	Battery power supply is not plugged in.	Check that the charger power cord is plugged into the charger and into an electrical outlet that is not controlled by a wall switch.

MDW 9031 Pocketphone Compatibility

6

Programming and Call Handling Instructions

The MDW 9031 Pocketphone can display the status of up to 12 telephone lines, but the number of lines supported by compatible communications system switches varies. After you have installed your MDW 9031 and understand the controls and displays, use the programming and call handling instructions that come with your communications system; follow the user instructions for the phone type identified below:

For this release	Of this communications system...	Use the instructions for a...
R1, R2, R3, R4	PARTNER®	MLS-12D phone* (Apparatus code 7311H)
R1, R3, R4, R4.1	PARTNER® II	
R1, R2, R3, R4, R4.1	PARTNER® Plus	
R1, R2,	PARTNER® Advanced Communications System	
FP 1&2	MERLIN® (206, 410)	BIS-22D phone (Apparatus code 7315H) NOTE: The MDW 9031 display and mail capabilities will function fully only if your system supports: 1) Analog/Hybrid display sets 2) Analog ports to AUDIX, VOICE MAIL. Consult your System Administration manuals for this compatibility. If your system does not support the items above, consult the System Administration manual for the BIS-10 phone (Apparatus Code 7303S).
FP 2	MERLIN® (820)	
FM 1, 2, 3, 4, & 5	MERLIN® (1030, 3070)	
FM 1, 2, R3	MERLIN® II	
R1, R2	MERLIN® Plus	
R1, R1.1, R2, R2.1, R3	MERLIN LEGEND®	
R1V1, R1V2, R2, R3V1, R3V2, R3V3	System 25	
R1V1, R1V2, R1V3	System 75	
R2V1, R2V2, R2V3, R2V4	System 85	
G1, G2, G3	DEFINITY®	

Legend: R=Release, V=Version, FP=Feature Package, FM=Feature Module, G=Generic

* PARTNER Plus or PARTNER II Release 4.1 communications system users can order documentation for MLS telephones by calling 1 800 457-1235 or 1 317 361-5353 and asking for Order Number 107794331.

NOTE:

The MDW 9031 Pocketphone is fully compatible with the PARTNER family of communication systems. For the remaining communications systems, however, you must carefully note the functional differences between your wireless phone and the phone type identified in the table on the previous page. Differences are summarized on the following pages.

Some systems do not support display features. In these cases, the display is not available; the MDW 9031 works as a nondisplay set.

Programming Features for PARTNER, MERLIN, and MERLIN LEGEND Systems

On all PARTNER, MERLIN, and MERLIN LEGEND systems, you can assign a feature to an available button (a button that does not have a line or another feature assigned to it):

1. To enter programming mode, turn on the handset, press [*Intercom*], then press [*Feat/P*] followed by [*Q*] [*Q*].
2. Press the Select button (Ⓢ) to move the Selection rectangle to the row of line indicators containing the available button.
3. Press the Column button (ⓐ) under the button that you want.
4. Program the feature (using the procedure described in the manual for your PARTNER, MERLIN, or MERLIN LEGEND communications systems).

NOTE:

Some features provide a visual indication in the handset display that the feature is turned on. Be aware that if you turn off the handset while using one of these features, you may forget that the feature is on. To verify the status of a such a feature, you can simply press the (Ⓢ) button to "wake up" the phone and activate the display.

5. To exit programming mode, press [*Feat/P*] followed by [*Q*] [*Q*] or turn off the handset.

NOTE:

The above instructions do not apply to System 25, System 75, System 85, and DEFINITY systems, because in those systems, features are assigned by the System Administrator.

Communications System Compatibility

This section describes some communications-system-dependent programming to help you optimize the performance of your MDW 9031 Pocketphone. It also describes how the buttons on a wired phone for your communications system map to the buttons on your MDW 9031. Turn to the information appropriate to your communications system:

- PARTNER
- MERLIN
- System 25, System 75, System 85, and DEFINITY

NOTE:

For all systems configured as key systems (for example, PARTNER or MERLIN), only three carriers are allowed. For all systems configured as PBX systems (for example, DEFINITY), you can use up to four carriers.

PARTNER Systems

Button Mapping for PARTNER Systems

On PARTNER systems, the MDW 9031 emulates an MLS-12D telephone. Following is a diagram of the button assignments on an MLS-12D phone and the corresponding assignments on the MDW 9031 Pocketphone.

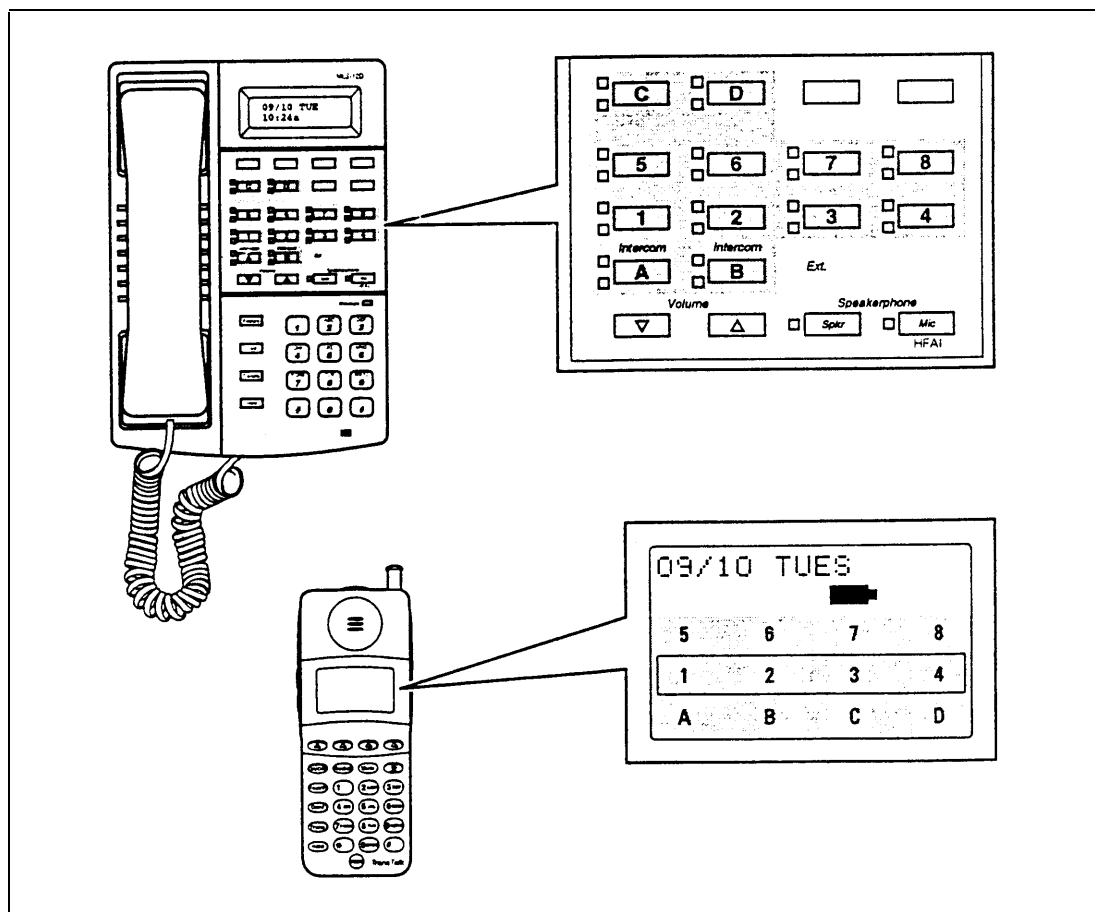

Setting the Line-Ringing Options

Use the following guidelines to ensure optimal voice quality when using MDW 9031 Pocketphones with a PARTNER, PARTNER Plus, PARTNER II, or PARTNER Advanced Communications System in key mode:

Telephone Communications System	TransTalk 9000 System with Two Carriers (one control and one expansion carrier)	TransTalk 9000 System with Three Carriers (one control and two expansion carriers)
PARTNER	<ol style="list-style-type: none"> 1. Set Line Ringing for each extension that has a radio module in the control carrier to Ring. 2. Set Line Ringing for each extension that has a radio module in the expansion carrier to No Ring. (Install an external audible alert for these extensions.) 	Not applicable: PARTNER supports up to 12 phones.
PARTNER Plus, PARTNER II, PARTNER Advanced Communications System	<ol style="list-style-type: none"> 1. Set Line Ringing for each extension that has a radio module in the control carrier to Ring. 2. Set Line Ringing for each extension that has a radio module in the expansion carrier to Delayed Ring. 	<ol style="list-style-type: none"> 1. Set Line Ringing for each extension that has a radio module in the control carrier to Ring. 2. Set Line Ringing for each extension that has a radio module in expansion carrier #1 to Delayed Ring. 3. Set Line Ringing for each extension that has a radio module in expansion carrier #2 to No Ring. (Install an external audible alert for these extensions.)

NOTE:

For PARTNER II hybrid systems that use pooled lines, set the Line Ringing options as described in the above table if more than six MDW 9031 Pocketphone handsets have the same pooled line appearance.

MERLIN Systems

- On MERLIN II and MERLIN LEGEND systems, you must connect your wireless phone to an available jack on either a 408 outside line/analog telephone module or a 008 analog telephone module.
- Since the MDW 9031 does not have a speaker function, the Voice Announce feature must be disabled. It is recommended that you use MERLIN 206/410/820 systems installed with Feature Package 2 with your wireless phone, so that you can disable that feature.
- Since the MDW 9031 has no speaker function, it should not be assigned to a paging group.
- To program the Ringing Option feature, use the "triangle" and "rectangle" indicators in the display as the equivalent of red and green LEDs, respectively.
- For MERLIN II system users, if you program an Auto Intercom button, idle line preference must be set to intercom.
- If any of your incoming lines has the call waiting feature, use the Recall feature (letter "C" in the display) and press it before you pick up a waiting call. You can dial [#] [5] [0] before you pick up a waiting call on the following: MERLIN 206/410/820 systems only with Feature Package 2, and all MERLIN Plus, MERLIN II, and MERLIN 1030/3070 systems. Pressing the [*On/Off*] button disconnects the call.
- The [*Feat/P*] button on the MDW 9031 allows you only to enter programming mode. It does not work when using MERLIN LEGEND system features. To use MERLIN LEGEND system feature codes with this phone, program any available button as a System Feature button. This enables you to use the wide array of MERLIN LEGEND system features by turning the set on, pressing the System Feature button, and dialing the appropriate " * " code number.

Note: MERLIN LEGEND does not support Caller ID and some other Display features to Analog/Hybrid terminals, such as the MDW 9031.

Button Mapping for MERLIN Systems except MERLIN 410 and MERLIN 820

On all MERLIN systems, the MDW 9031 emulates a Model BIS-22D phone (Apparatus Code 7315H). However, the BIS-22D button assignments differ depending on the MERLIN system used. Following is a diagram of the BIS-22D button assignments and the corresponding assignments on the MDW 9031 for all MERLIN systems *except MERLIN 410 and MERLIN 820*. (See the next section for button mapping for MERLIN 410 and MERLIN 820 systems).

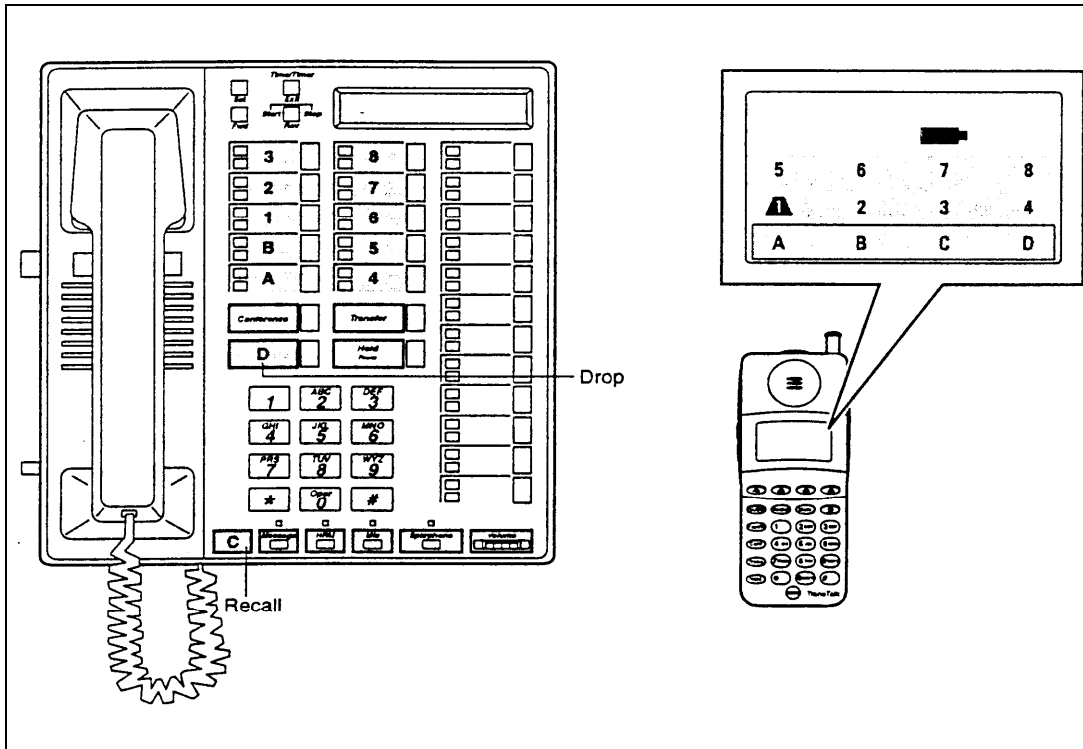

The button labeled C and the button labeled D on the MDW 9031 Pocketphone display automatically default to the buttons labeled C (Recall) and D (Drop), respectively, on the 7315H phones.

Button Mapping for MERLIN 410 and MERLIN 820 Systems

Following is a diagram of the button assignments on a BIS-22D phone used for *MERLIN 410 and 820 systems*, and the corresponding assignments on the MDW 9031 Pocketphone. (See the previous section for button mapping for all other MERLIN systems, including MERLIN LEGEND systems).

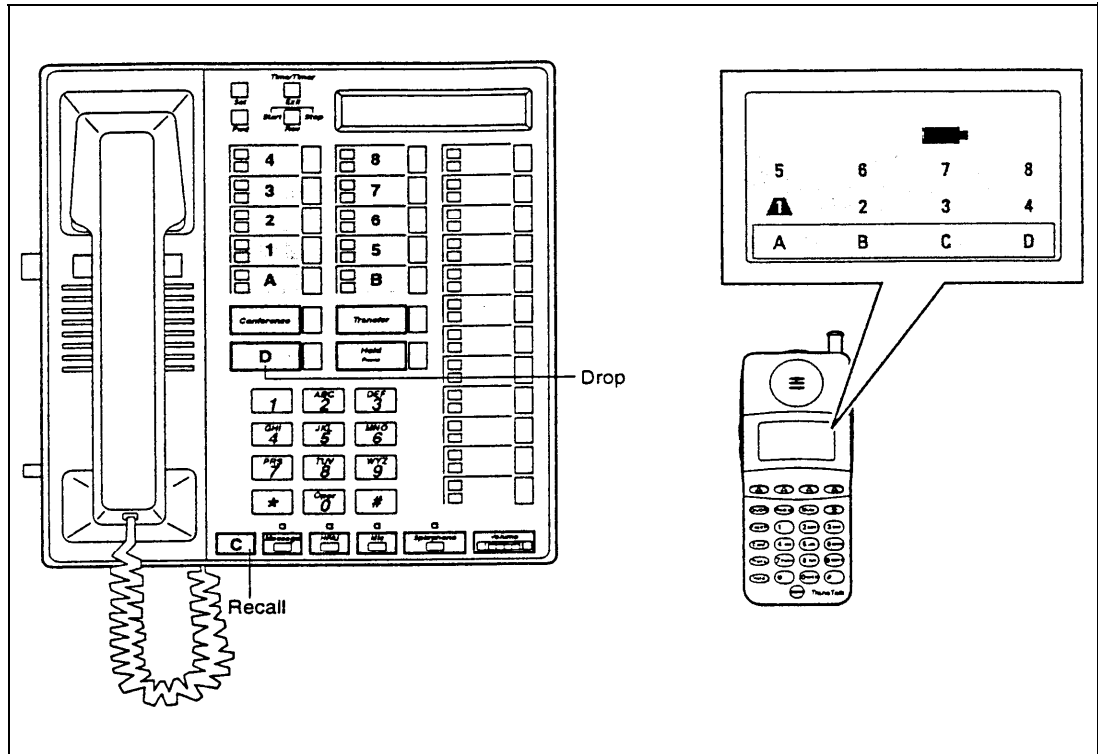

The button labeled C and the button labeled D on the MDW 9031 Pocketphone display automatically default to the buttons labeled C (Recall) and D (Drop), respectively, on the 7315H phones.

Setting the Line Ringing Options

Use the following guidelines to ensure optimal voice quality when using MDW 9031 Pocketphones with MERLIN, MERLIN Plus, and MERLIN II:

Telephone Communications System	TransTalk 9000 System with Two Carriers (one control and one expansion carrier)	TransTalk 9000 System with Three Carriers (one control and two expansion carriers)
MERLIN, MERLIN II, MERLIN Plus	<ol style="list-style-type: none"> 1. Set Line Ringing for each extension that has a radio module in the control carrier to Ring. 2. Set Line Ringing for each extension that has a radio module in the expansion carrier to Delayed Ring. 	<ol style="list-style-type: none"> 1. Set Line Ringing for each extension that has a radio module in the control carrier to Ring. 2. Set Line Ringing for each extension that has a radio module in expansion carrier #1 to Delayed Ring. 3. Set Line Ringing for each extension that has a radio module in expansion carrier #2 to No Ring. (Install an external audible alert for these extensions.)

NOTE:

For MERLIN LEGEND systems that use pooled lines, set the Line Ringing options as described in the above table if more than six MDW 9031 Pocketphone handsets have the same pooled line appearance. For MERLIN LEGEND systems that use the TransTalk MDW 9031 Pocketphones as PBX extensions, the above Line Ringing options are not necessary.

System 25, System 75, System 85, and DEFINITY Systems

- This phone must be administered as a BIS-22D MERLIN set (Apparatus Code 7315H) for the following systems:
 - System 25
 - System 75—R1V1, R1V2, and R1V3
 - System 85—R2V1, R2V2, R2V3, and R2V4
 - DEFINITY G1 (R1V4)
 - DEFINITY G2—G2.1 and G2.2—(R2V5, R2V6)
 - DEFINITY G3 Version 1 (R1V5)
 - DEFINITY G3 Version 1.1 and Version 2

Native terminal administration is provided in DEFINITY G3 Version 3.

NOTE:

The MDW 9031 display and mail capabilities will function fully only if your system supports:

- 1) Analog/Hybrid display sets
- 2) Analog ports to AUDIX, Voice Mail.

Consult your System Administration manuals for this compatibility.

If your system does not support the items above, consult the System Administration manual for the BIS-10 phone (Apparatus Code 7303S).

- To connect the communications system switch and the MDW 9031 Pocketphone, use the following:
 - An ANN17B Hybrid pack in conjunction with a DS-1 carrier for older communications system switches that do not accommodate Universal modules (System 85 –R2V1, R2V2, R2V3, and R2V4)
 - Either a TN762B Hybrid pack or a ZTN79 ATL pack for System 25
 - A TN762B Hybrid pack for newer communications system switches that accommodate Universal modules:
 - System 75 – R1V1, R1V2, and R1V3
 - DEFINITY G1 (R1V4)
 - DEFINITY G3 Version 1 (R1V5)
 - DEFINITY G3 Version 1.1 and Version 2
 - DEFINITY G3 Version 3
 - Either a TN762B (in a universal mod carrier) or an ANN17B (in a traditional mod carrier) Hybrid pack for DEFINITY G2 (G2.1 and G2.2), depending upon the actual hardware configuration.

NOTE:

For DEFINITY G2.1 and G2.2, General Terminal Administration (GTA) can be used to set up "custom" set types so that administration can be done using that custom set type.

- System 25 users cannot program Recall for use with systems such as Centrex.
- Only the System Administrator can assign features. Use the following guidelines:
 - Do not assign the following features: Auto Answer, Inspect, Directory, Next, Local, Call, and Manual Callback Queuing.
 - If programming the Flex DSS or Repertory Dial feature, dial the number to be recorded and push the button you are assigning to the feature. You will hear 3 short beeps and a dial tone to confirm programming.
 - If you are programming numbers for the Station Speed Dial feature, dial the numbers to be stored then dial the Personal Speed Dialing code ([#] [2] [0] through [#] [3] [9]), including the [#]. Listen for a confirmation tone followed by a dial tone.
 - It is recommended that you do not use features that require visuals to be updated while the set is turned off.

Button Mapping for DEFINITY Systems, System 25, System 75, and System 85

On DEFINITY systems, System 25, System 75, and System 85, the MDW 9031 emulates a BIS-22D phone (Apparatus Code 7315H). Following is a diagram of the BIS-22D button assignment, and the corresponding assignments on the MDW 9031 for DEFINITY systems, System 25, System 75, and System 85.

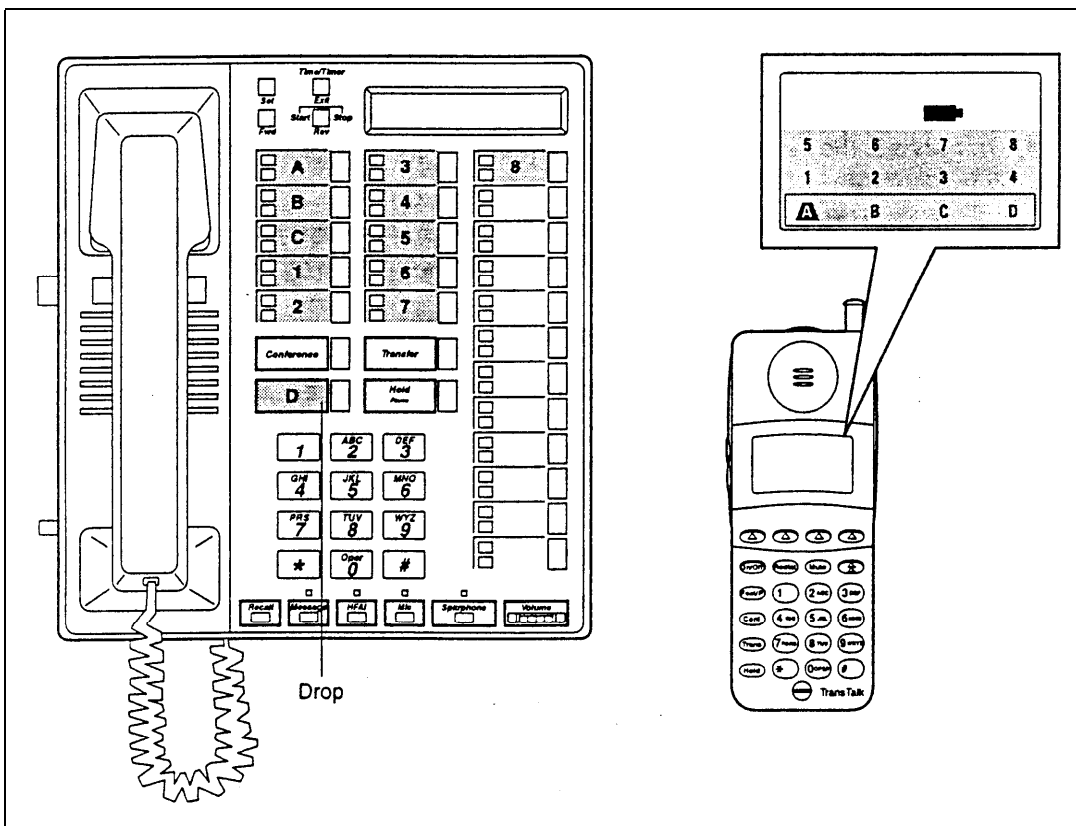

The 7315H phones are programmed for DEFINITY systems using three STATION Administration screens. Enter 7315H in the Type field on the first screen to bring up the next two screens.

```

Page 1 of 3
STATION
Extension: _____ BCC: 0 COR: 1
Type: 7315H Lock Messages: n COS: 1
Name: _____ Coverage Path: ____

FEATURE OPTIONS
LWC Reception? msa-spe Coverage Msg Retrieval? y
LWC Activation? Y Auto Answer: none
CDR Privacy? n Data Restriction? n
Redirect Notification? Y Idle Appearance Pattern: n
Bridged Call Alerting? n Personalized Ringing Pattern: 1
Active Station Ringing: single Restrict Last Appearance? Y
Display Module? y
AUDIX Name: _____
Messaging Server Name: _____ Audible Message Waiting? n

```

The following illustrations show in parentheses the MDW 9031 Pocketphone button assignments on Pages 2 and 3 of the STATION Administration screens. The button labeled D on the MDW 9031 Pocketphone display automatically defaults to the button labeled D (Drop) on the 7315H phones.

```

Page 2 of 3
STATION
SITE DATA
Room: _____ Headset? n:
Jack: _____ Speaker? n:
Cable: _____ Mounting? d:
Floor: _____ Cord Length: 0__
Building: _____ Set Color: _____

ABBREVIATED DIALING
List1: _____ List2: _____ List3: _____

BUTTON ASSIGNMENTS
1: (A) _____ 6: (3) _____
2: (B) _____ 7: (4) _____
3: (C) _____ 8: (5) _____
4: (1) _____ 9: (6) _____
5: (2) _____ 10: (7) _____

```

```

Page 3 of 3
STATION
FEATURE BUTTON ASSIGNMENTS
1: (8) _____ 13: _____
2: _____ 14: _____
3: _____ 15: _____
4: _____ 16: _____
5: _____ 17: _____
6: _____ 18: _____
7: _____ 19: _____
8: _____ 20: _____
9: _____ 21: _____
10: _____ 22: _____
11: (Scroll) _____ 23: _____
12: (Display) _____ 24: _____

```

For DEFINITY systems, you must assign the Scroll and Display features to buttons. If your users do not need these features, assign them to "nonappearing" MDW 9031 Pocketphone buttons; the buttons represented by the numbers 1 through 8 on the Pocketphone display can then be used for features the users want. The Scroll and Display features shown on Page 3 of the STATION Administration screens are assigned to buttons 11 and 12 (which cannot be accessed from MDW 9031 Pocketphones).

Setting the Line Ringing Options

Use the following guidelines to ensure optimal voice quality when using MDW 9031 Pocketphones with System 25, System 75, System 85, and DEFINITY systems:

Telephone Communications System	TransTalk 9000 System with Two Carriers (one control and one expansion carrier)	TransTalk 9000 System with Three or Four Carriers (one control and two or three expansion carriers)
System 25, System 75, System 85, DEFINITY Systems	<ol style="list-style-type: none"> 1. When TransTalk handsets are configured as individual PBX extensions, no Line Ringing options are necessary. 2. When TransTalk handsets are configured in pooled PBX or group PBX extensions (for example, Splits or Skills), where all incoming calls ring all handsets at the same time, refer to "Setting the Line Ringing Options" for PARTNER systems on page 6-4. 	<ol style="list-style-type: none"> 1. Set Line Ringing for each extension that has a radio module in the control carrier to Ring. 2. Set Line Ringing for each extension that has a radio module in expansion carrier #1 to Delayed Ring. 3. Set Line Ringing for each extension that has a radio module in expansion carrier #2 to No Ring. (Install an external audible alert for these extensions.)

NOTE:

For System 25, System 75, System 85, and DEFINITY systems that use pooled lines, set the Line Ringing options as described in the above table if more than six MDW 9031 Pocketphone handsets have the same pooled line appearance.

Warranty and Repair Information

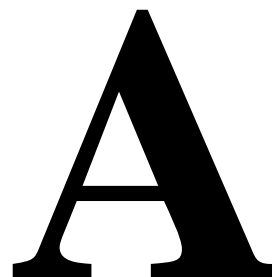

Lucent Technologies Limited Warranty and Limitation of Liability

Lucent Technologies warrants to you, the customer, that your wireless telephone system will be in good working order on the date Lucent Technologies or its Authorized Dealer delivers or installs the system, whichever is later ("Warranty Date"). If you notify Lucent Technologies or its Authorized Dealer within one year of the Warranty Date that your system is not in good working order, Lucent Technologies will without charge to you repair or replace, at its option, the system components that are not in good working order. Repair or replacement parts may be new or refurbished and will be provided on an exchange basis. If Lucent Technologies determines that your system cannot be repaired or replaced, Lucent Technologies will remove the system and, at your option, refund the purchase price of your system or apply the purchase price towards the purchase of another Lucent Technologies system.

If you purchased your system directly from Lucent Technologies, Lucent Technologies will perform warranty repair in accordance with the terms and conditions of the specific type of Lucent Technologies maintenance coverage you selected. A written explanation of Lucent Technologies's types of maintenance coverage may be obtained from Lucent Technologies by calling 1 800 247-7000 (in the continental U.S. only). If you purchased your system from an Lucent Technologies Authorized Dealer, contact your dealer for the details of the maintenance plan applicable to your system.

This Lucent Technologies limited warranty covers damage to the system caused by power surges. Unless otherwise expressly agreed to in a written agreement signed by Lucent Technologies, Lucent Technologies will not be responsible under this limited warranty for damages resulting from:

- Failure to follow Lucent Technologies's installation, operation, or maintenance instructions;
- Unauthorized system modification, movement, or alteration;
- Unauthorized use of common carrier communication services accessed through the system;

-
- Abuse, misuse, or negligent acts or omissions of the customer and persons under the customer's control; or
 - Acts of third parties and acts of God. LUCENT TECHNOLOGIES'S OBLIGATION TO REPAIR, REPLACE, OR REFUND, AS SET FORTH ABOVE, IS YOUR EXCLUSIVE REMEDY.

EXCEPT AS SPECIFICALLY SET FORTH ABOVE, Lucent Technologies, ITS AFFILIATES, SUPPLIERS, AND DEALERS MAKE NO WARRANTIES, EXPRESS OR IMPLIED, AND SPECIFICALLY DISCLAIM ANY WARRANTIES OF MERCHANTABILITY OR FITNESS FOR A PARTICULAR PURPOSE.

Limitation of Liability

Except as provided below, the liability of Lucent Technologies and its affiliates and suppliers for any claims, losses, damages, or expenses from any cause whatsoever (including acts or omissions of third parties), regardless of the form of action, whether in contract, tort, or otherwise, shall not exceed the lesser of: (1) the direct damages proven; or (2) the repair cost, replacement cost, license fee, annual rental charge, or purchase price, as the case may be, of the equipment that directly gives rise to the claim. Except as provided below, Lucent Technologies and its affiliates and suppliers shall not be liable for any incidental, special, reliance, consequential, or indirect loss or damage incurred in connection with the equipment. As used in this paragraph, consequential damages include, but are not limited to, the following: lost profits, lost revenues, and losses arising out of unauthorized use (or charges for such use) of common carrier telecommunications services or facilities accessed through or connected to the equipment. For personal injury caused by Lucent Technologies's negligence, Lucent Technologies's liability shall be limited to proven damages to person. No action or proceeding against Lucent Technologies or its affiliates or suppliers may be commenced more than twenty-four (24) months after the cause of action accrues. THIS PARAGRAPH SHALL SURVIVE FAILURE OF AN EXCLUSIVE REMEDY.

Repair Information

Outside the continental U.S., contact your Lucent Technologies Representative or local Authorized Dealer for warranty and repair information applicable to your system.

In-Warranty Repairs

If you purchased or leased your system directly from Lucent Technologies, Lucent Technologies will repair it free of charge during the one-year warranty period. Simply call for customer support as instructed on the inside front cover of this book.

Business-Day service is standard during the warranty period. Business-Day service is performed during normal business hours. (Around-the-Clock service is not available for phones.)

If you purchased or leased your system through a Lucent Technologies Authorized Dealer, contact your dealer for repairs.

Post-Warranty Repairs

If you purchased the system from Lucent Technologies and you have a post-warranty service contract, Lucent Technologies service is provided under the terms of that contract.

To significantly reduce unexpected repair costs after the warranty period, you can purchase a post-warranty service contract from Lucent Technologies. If you do not have a contract, Lucent Technologies service is provided on a time-and-materials basis by calling for customer support as instructed on the inside front cover of this book. A contract provides to you, within the applicable coverage period and response times, service calls with no charge for parts and labor on covered repairs. To order a post-warranty service contract, call 1 800 247-7000 (in the continental U.S. only).

If you leased your system from Lucent Technologies, Business-Day service is included in your lease.

If you purchased or leased your system through a Lucent Technologies Authorized Dealer, contact your dealer for repairs.

Regulatory Information

B

This appendix contains information about the Federal Communications Commission and Industry Canada.

FCC Part 15 Rules

The Lucent Technologies MDW 9031 Wireless Pocketphone has been tested and has been found to comply with *FCC Part 15 Rules*. These specifications are designed to provide reasonable protection against harmful interference in a commercial or residential installation. This wireless telephone generates, uses, and can radiate radio frequency energy and, if not installed and used in accordance with the instructions, may cause harmful interference to radio communications. However, there is no guarantee that interference will not occur in a particular installation. If the telephone does cause harmful interference to radio or television reception, which can be determined by turning the telephone off and on, the user is encouraged to try to correct the interference by one or more of the following measures:

- Where it can be done safely, reorient the receiving television or radio antenna.
- To the extent possible, relocate the television, radio, or other receiver with respect to the telephone.
- Plug the telephone into an electrical outlet that is not on the same circuit as one used by the radio or television.

IC RSS-210 Compliance

This device complies with RSS-210 of Industry Canada. Operation is subject to the following two conditions:

1. This device may not cause interference.
2. This device must accept any interference including interference that may cause undesirable operation of the device.

The user is cautioned that modifications to this telephone, not expressly approved by Lucent Technologies, could void the user's authority to operate the equipment.
--

Hearing Aid Compatibility

This wireless telephone is compatible with inductively-coupled hearing aids.

Specifications

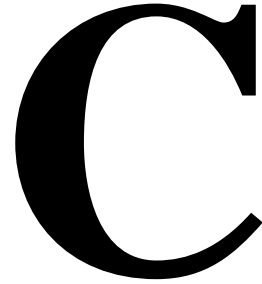

GENERAL			
Model:	MDW 9031 Wireless Pocketphone		
Dimensions and Weights:	Handset	6.0"(L) x 1.0"(D) x 2.25"(W) 15.24 x 2.54 x 5.71 cm	0.33 lbs 0.15 kgs
	Handset w/Battery Pack	6.0"(L) x 1.0"(D) x 2.25"(W) 15.24 x 2.54 x 5.71 cm	0.55 lbs 0.25 kgs
	Battery Charger (BC)	9.75"(L) x 5.13"(H) x 3.94"(W) 24.77 x 13.03 x 10.01 cm	1.00 lbs 0.45 kgs
	Battery Charger w/ Battery Pack	9.75"(L) x 5.13"(H) x 3.94"(W) 24.77 x 13.03 x 10.01 cm	1.22 lbs 0.55 kgs
	<u>Standard</u> Battery Pack	3.0"(L) x .75"(H) x 2.5"(W) 7.6 x 1.9 x 6.35 cm	0.22 lbs 0.10 kgs
	Extended Battery Pack	<u>3.0"(L) x .95"(H) x 2.5"(W)</u> 7.6 x 2.4 x 6.35 cm	<u>0.35 lbs</u> 0.16 kgs
	Headset w/Cord (approx.)	10.5"(L) x 1.2"(H) x 5.6"(W) 26.67 x 3.05 x 14.22 cm	0.17 lbs 0.08 kgs
	Radio Module (RM)	12.1"(L) x 1.5"(H) x 5.5"(W) 30.73 x 3.81 x 13.97 cm	1.50 lbs 0.68 kgs
	Carrier (CA)	14.0"(L) x 2.5"(H) x 9.0"(W) 35.56 x 6.35 x 22.86 cm	3.00 lbs 1.36 kgs
	Carrier w/6 RMs	14.0"(L) x 2.5"(H) x 9.0"(W) 35.56 x 6.35 x 22.86 cm	12.00 lbs 5.44 kgs
	Power Supply (BC)	3.35"(L) x 2.70"(H) x 2.19"(W) 8.50 x 6.85 x 5.55 cm	1.75 lbs 0.80 kgs
	Power Supply (RM)	3.19"(L) x 1.94"(H) x 2.17"(W) 8.09 x 4.92 x 5.50 cm	1.10 lbs 0.50 kgs
	Power Supply (CA)	5.13"(L) x 1.6"(H) x 1.6"(W) 13.03 x 4.06 x 4.06 cm	1.70 lbs 0.77 kgs
	Operating Temperature:	Temperature range: Relative humidity:	4.4° C (40° F) to 40° C (104° F) 15% to 95%

GENERAL (continued)		
Electrical	Handset	1.0 watt
Specifications: (Power)	Battery Charger (BC)	15 watts
	Radio Module (RM)	4.0 watts
	Carrier (CA) w/6 RMs	24.0 watts
	Power Supply (BC)	15 watts (10V 1.5 A)
	Power Supply (RM)	6.0 watts (10V 600mA)
	Power Supply (CA)	30.0 watts (9V)
Battery Pack Life:	Standard Nickel Metal Hydride	3 hours talk time/22 hours standby time
	Extended Nickel Metal Hydride	8 hours talk time/72 hours standby time
RF SYSTEM PARAMETERS		
Frequency Band:	902 – 928 MHz	
Channel Spacing:	150 KHz	
Total Channel Capability:	50 (Channels Dynamically allocated out of 173)	
Duplex Method:	Time Division Duplex (TDD) (Transmit and Receive on same frequency)	
Transmitter Output Power:	Dynamic Power Adjustment: 1mW ERP Minimum to 160mW ERP Maximum	
Receiver Sensitivity:	-103 dBm at Antenna Port	
OTHER		
Electrical Requirements:	<ul style="list-style-type: none"> ■ 105 – 130VAC, 50 –60 Hz, 3-prong outlet separate ground, separately fused at 15 amps. ■ Outlet must not be controlled by an on/off switch ■ Grounding to comply with Underwriters Laboratories (UL) 1459 	
Requirements For Out-Of-Building Extensions:	<p>Installation of a telephone or other standard (tip/ring) device in another building requires the following In-Range Out-of-Building (IROB) protectors to protect the switch/control unit and telephone device from electrical surges:</p> <ul style="list-style-type: none"> ■ MDW 9031 Pocketphone: two Lucent Technologies <u>146D</u> protectors (ETR); two Lucent Technologies <u>146E</u> protectors (ATL) 	
Wiring:	<ul style="list-style-type: none"> ■ MDW 9031 Pocketphone: Lucent Technologies SYSTIMAX® or at least 2-pair (4-wire) star ("home run" not "loop") ETR ■ Lucent Technologies SYSTIMAX or at least 4-pair (8-wire) star ("home run" not "loop") ATL ■ Bridging Adapter: Lucent Technologies 267F2 (ETR) ■ Bridging Adapter: Lucent Technologies 267C (ATL) ■ Range: 1,000 feet (305 meters) for the Radio Module (26 AWG) 	

Index

A

Alerter 3-4, 3-7, 3-11
Alerter icon 3-4
Answering a call 3-15, 3-17
Antenna 3-2, 3-6, 3-8
 replacement 4-4, 4-5

B

Backlighting 3-10
Battery charger
 about 1-1, 3-19
 illustration 1-4, 2-34, 3-19
 inserting the spare battery pack 2-34
 installation 2-32
 positioning 2-32
 power supply 2-3, 4-5
 problems 5-13
 refreshing battery pack 3-21
 removing the spare battery 2-34
 replacement 4-5
Battery icon 3-4, 3-6, 3-21, 5-6
Battery pack
 charging in battery charger 2-34
 disposal warning 2-3, 2-32
 extending life of 3-21
 inserting/removing from battery
 charger 2-34
 inserting/removing from handset 2-29
 low power indicator 3-4, 3-6, 3-21
 problems 5-6
 refreshing 3-19, 3-20, 3-21, 3-22
 replacement 4-5
 spare 1-6, 3-6, 3-21
 warning 2-3, 2-32
Beeps 3-4, 3-6, 3-12
Button mapping 2-30, 3-5, 3-8
 DEFINITY systems 6-10
 MERLIN systems 6-6, 6-7
 PARTNER systems 6-3
 System 25 6-10
 System 75 6-10
 System 85 6-10
Buttons 3-2, 3-3, 3-4, 3-5, 6-2

C

Call handling 6-1
Carrier
 compatibility 1-2
 control 2-16, 2-23
 expansion 2-16, 2-23, 2-24
 illustration 1-5, 2-7
 installation
 multiple carriers 2-7, 2-16, 2-23
 single carrier on shelf or desk 2-17
 single carrier on wall 2-20
 positioning 2-8
 power supply 2-4, 4-5
 powering multiple 2-27
 powering single 2-19, 2-22
 removing a radio module from 4-1
 replacement 4-5
Carrying case 3-7, 4-5
Carrying clip 1-4, 3-7, 4-5
CHANGE BUTTN MAP 3-5, 3-8
Cleaning 2-1
Column buttons 3-2, 3-3, 3-16
Communications system setting 2-30,
 3-5, 3-8
Compatibility
 communications systems 6-1
 equipment 1-1
Conference button 3-2
Control carrier 2-16, 2-23
Control/expansion DIP switch 2-7, 2-16
Coverage zone 1-1, 2-8, 2-10
Cradle 2-35, 3-19
Customer support Inside front cover

D

DEFINITY systems 1-1, 2-30, 3-5, 6-1,
 6-9, 6-12
DIP switch, carrier
 control/expansion 2-7, 2-16
 power 2-7, 2-14
Display 3-2, 3-4, 3-5
 activate 3-15
 test 3-12

E

Electrical requirements 2-4, C-2
Environmental
 requirements 2-2, C-1
Expansion cable 2-7, 2-24
Expansion carrier 2-16, 2-23, 2-24
Extended battery pack
 about 1-6, 3-6, 3-21
 inserting/removing from the
 battery charger 2-34
Extension labels 2-31
Extensions, changing 4-3

F

Feat/P button 3-2, 6-2

H

Handset
 about 1-1
 alerter 3-4, 3-7, 3-11
 backlighting 3-10
 buttons 3-2, 3-3
 controls 3-2
 cradle 2-35, 3-19
 display 3-2, 3-4, 3-5, 3-12,
 3-15
 HANDSET LED 2-35, 3-19,
 3-20, 5-13, 5-14
 illustration 1-4, 3-2
 inserting/removing battery
 pack 2-29
 inserting/removing from
 cradle 2-35
 label 2-31
 Local Test Mode 2-30, 3-12
 problems 5-4
 range indicators 3-6
HANDSET LED 2-35, 3-19,
3-20, 5-13, 5-14
Headset
 illustration 1-6
 replacement 4-5
 using 3-17
Headset adapter 3-17

Headset connector 3-2, 3-17
Hearing aid compatibility B-1
Helpline Inside front cover
Hold button 3-2

I

Icons 3-4
Illustrations
 battery charger 1-4, 2-34, 3-19
 carrier 1-5, 2-7
 handset 1-4, 3-2
 headset 1-6
 radio module 1-4, 2-6
Installation
 battery charger 2-32
 multiple carriers 2-7, 2-16, 2-23
 problems 5-1
 remote location 2-9
 requirements 2-8, C-1
 rules 2-8
 self-test 2-28
 single carrier on shelf or desk 2-17
 single carrier on wall 2-20
 single radio module 2-12
 warning 2-2, 2-3
Interference
 radio 5-8, 5-9
 with wireless products 2-14

L

Label 2-31
Lanyard 1-4, 3-7, 4-5
Lanyard loop 3-2, 3-7
LCL 3-5
LED
 HANDSET 2-35, 3-19, 3-20, 5-13,
 5-14
 Out of Sync 2-7, 2-19, 2-22, 2-27,
 4-3, 4-4, 5-1
 PASS 2-6, 2-28, 5-2, 5-3
 POWER 2-6, 2-28, 5-2
 RADIO 2-6, 2-28, 5-4
 REFRESH 3-19, 3-20
 SPARE 2-34, 3-19, 3-20, 5-15, 5-16
Line Preselection 3-5, 3-9, 3-16

Line Ringing options
DEFINITY systems 6-12
MERLIN systems 6-8
PARTNER systems 6-4
System 25 6-12
System 75 6-12
System 85 6-12
Line selection 3-2, 3-3, 3-5, 3-16
Line status 3-4, 3-5
Local Mode 3-5, 3-8
Local Test Mode 3-12

M

Making a call 3-15, 3-18
MAP 3-5
MDW 9000 1-1
MDW 9010 1-1
MDW 9030P 1-1
Memory effect 3-19, 3-21
MERLIN systems 1-1, 2-30 3-5, 6-1,
6-2, 6-5
Message icon 3-4
Microphone 3-2, 3-4, 3-17
Mode
Button Mapping 2-30, 3-5
Local 3-5, 3-8
Preselection 3-5, 3-9
Wireless Test 3-5, 3-13
MSG icon 3-4
Mute
button 3-2
icon 3-4, 5-5

N

NO LINK 3-5
No Ring icon 3-4, 3-11

O

ON icon 3-4, 3-16
On/Off buttons 3-2, 3-15, 3-17, 3-18
Ordering parts 4-5
Out of Sync LED 2-7, 2-19, 2-22,
2-27, 4-3, 4-4, 5-1

P

PARTNER systems 1-1, 2-30, 3-5, 6-1,
6-2, 6-3
Parts
additional 1-5
illustrations 1-4, 1-5, 2-6, 2-7,
2-34, 3-2, 3-19
ordering 4-5
replacement/optional 4-5
PASS LED 2-6, 2-28, 5-2, 5-3
Positioning
battery charger 2-32
radio module or carrier(s) 1-3, 2-8
Power DIP switch 2-7, 2-14
POWER LED 2-6, 2-28, 5-2
Power level
carrier 2-14
handset 3-13
Power supply 2-3, 2-4, 4-5
PRESELECTION 3-5, 3-10
Privacy 1-3
Programmable buttons 3-3, 3-4, 3-5, 6-2
Programming features
DEFINITY systems 6-9
MERLIN systems 6-2, 6-5
PARTNER systems 6-2, 6-3
System 25 6-9
System 75 6-9
System 85 6-9
Programming instructions 6-1, 6-2
Programming mode 6-2
PSEL 3-5, 3-10

R

RADIO LED 2-6, 2-28, 5-4
Radio module
identification 3-13
illustration 1-4, 2-6
installation in carrier 2-17, 2-20, 2-23
installation of a single module 2-12
positioning 1-3, 2-8
power supply 2-3, 2-4, 4-5
removing from carrier 4-1

Range 2-8, 2-10, 3-4, 3-6, 5-10
adjusting 2-14
maximum 3-6, 3-8
problems 5-10, 5-11, 5-12
test 3-14
RANGE indicator 3-6, 5-11, 5-12
Rectangle
selection 3-2, 3-3, 3-4, 3-16
status 3-5, 3-12, 3-15
Redial button 3-2
REFRESH button 3-19, 3-21, 3-22
REFRESH LED 3-19, 3-20
Refresh process 3-19, 3-21
Regulatory information B-1
Repair information A-2
Replacement parts 4-5
Rules for installation 2-8

S

Safety precautions 2-1
Security 1-3
Select button 3-2, 3-3, 3-15, 3-16
Selection rectangle 3-2, 3-3, 3-4, 3-16
Self-test, installation 2-28
Serial number 1-1, 2-6
Signal strength 2-10, 3-14
Sleep mode 2-35, 3-4, 3-15, 3-16
Sound clarity 2-10
Spare battery compartment 2-34, 3-19,
3-21, 5-13
Spare battery pack
about 1-6, 3-6, 3-21
inserting/removing from the battery
charger 2-34
SPARE LED 2-34, 3-19, 3-20, 5-15, 5-16
Specifications C-1
Standby time 3-21, C-2
System 25 1-1, 2-30, 3-5, 6-1, 6-9, 6-12
System 75 1-1, 2-30, 3-5, 6-1, 6-9, 6-12
System 85 1-1, 2-30, 3-5, 6-1, 6-9, 6-12

T

Talk time 3-6, 3-21, C-2
Testing
beeps 3-12
display 3-12
Local Test Mode 3-12
range 3-14
signal strength 2-10, 3-14
sound clarity 2-10
vibrator 3-12
voice quality 2-11, 3-14
Wireless Test Mode 2-10, 3-5, 3-13
Transfer button 3-2
Triangle 3-4, 3-5, 3-12, 3-15
Troubleshooting
battery charger problems 5-13
battery problems 5-6
handset problems 5-4
installation problems 5-1
overview 5-1
range problems 5-10
voice quality problems 5-7

V

VIBR 3-5
Vibrator
enable/disable 3-9
icon 3-5, 3-9
test 3-12
Voice quality 3-14
maximum 3-6, 3-8
problems 5-7
testing 2-11, 3-14
Volume
control 3-2, 3-7
problems 5-8

W

Wake up 3-15
Warranty information A-1
Wireless Test Mode 3-5, 3-13

Battery Charger Wall-Mounting Template

Use the template below to position the screws for mounting your MDW 9031 Pocketphone battery charger:

1. Cut out the template along the dotted line.
2. Lightly affix the template to the wall with tape where you want to attach the battery charger. If possible, choose a location that will position at least one of the screw holes over a wall stud.
3. Mark the wall.
4. Position a wall spacer on each of the two wood screws provided, and insert the screws in the wall as far as they will go at the places you marked.

Note:

If you cannot locate a wall stud for one of the screws, use molly bolts or another type of hollow-wall fastener. Be sure to place the wall spacers on the screws before inserting them permanently.

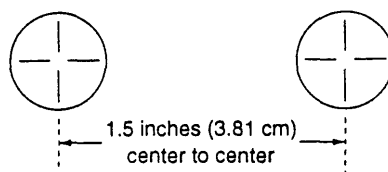

MDW 9031 Wireless Pocketphone Quick Reference

Handset Controls

Headset On/Off

Press to turn the headset on if the headset is plugged in. **ON** appears in the handset display. To turn off, press again. Turn on to make or answer a call, and turn off to "hang up."

Lanyard Loop

Attach lanyard for carrying handset.

Volume Control

Press "+" to increase or "-" to decrease volume of receiver or alerter.

On/Off

Press to turn the handset on. **ON** appears in handset display. To turn off, press again. Turn on to make or answer a call, and turn off to "hang up."

Feat/P (Feature/Program)

Press to use dial-code features (PARTNER® systems only) or to enter programming mode.

Conf (Conference)

Press to conference in (add) another party to your call.

Trans (Transfer)

Press to transfer a call to another extension.

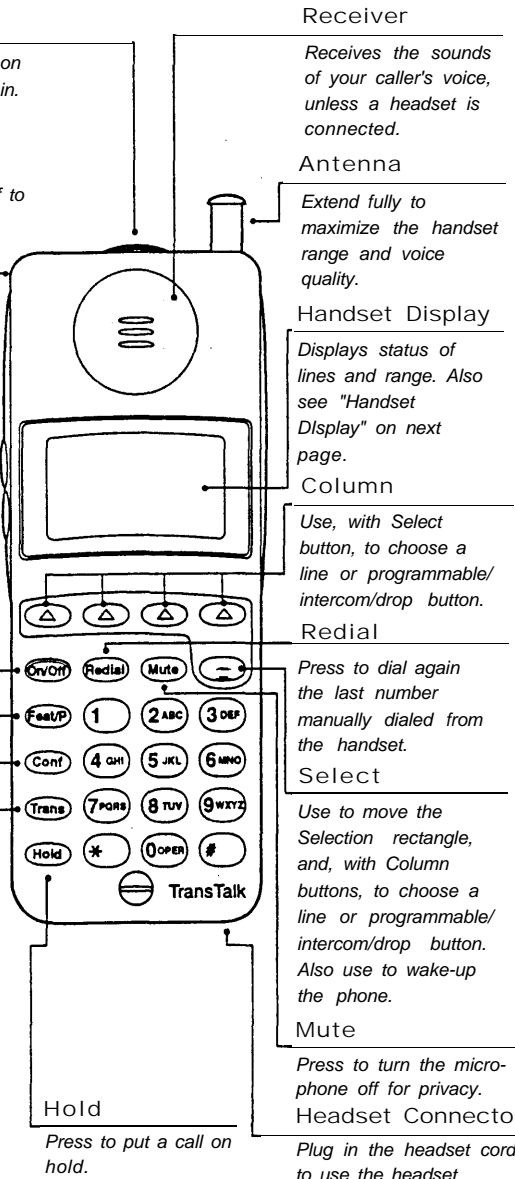

Receiver

Receives the sounds of your caller's voice, unless a headset is connected.

Antenna

Extend fully to maximize the handset range and voice quality.

Handset Display

Displays status of lines and range. Also see "Handset Display" on next page.

Column

Use, with Select button, to choose a line or programmable/intercom/drop button.

Redial

Press to dial again the last number manually dialed from the handset.

Select

Use to move the Selection rectangle, and, with Column buttons, to choose a line or programmable/intercom/drop button. Also use to wake-up the phone.

Mute

Press to turn the microphone off for privacy.
Headset Connector
Plug in the headset cord to use the headset.

Hold

Press to put a call on hold.

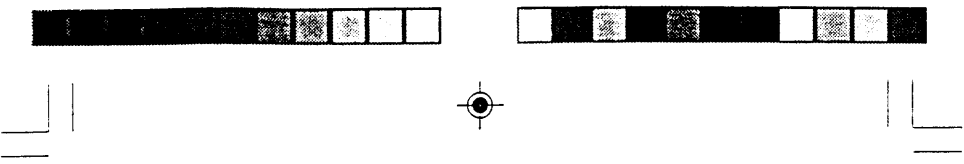

Handset Display

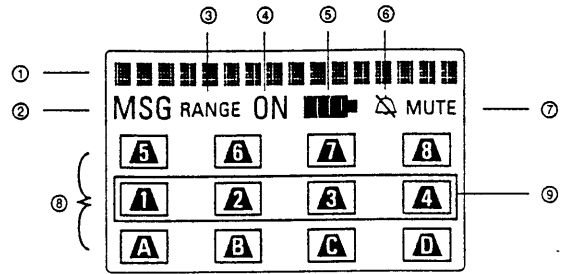

- ① Information you would see on a wired system phone's display, (except time), based on your communications system:
LCL:P, D, M1, or M2 = Local Mode:communications system
WIRELESS TEST = Handset in Wireless Test Mode
VIBR = Vibrator enabled
PSEL = Line Preselection enabled
PRESELECTION:ON/OFF = Line Preselection Mode:status
CHANGE BUTTN MAP = Communications system setting is wrong
MAP:P, D, M1, M2 = Button Mapping Mode: setting
NO LINK = Handset is not communicating with radio module
- ② **MSG** indicates that you have a message.
- ③ **RANGE** indicates that the handset is out of range or almost out of range. Handset also beeps.
- ④ **ON** indicates that handset was turned on by pressing [*On/Off*].
- ⑤ **Battery** icon flashes to indicate a low battery condition. Handset also emits 2 beeps.
- ⑥ **No Ring** icon indicates that the alerter is disabled.
- ⑦ **MUTE** indicates that handset microphone was turned off by pressing [*Mute*].
- ⑧ **Line Status Indicators** show the status of line or programmable/intercom/drop buttons. See "Line Status Indicators" below.
- ⑨ **Selection rectangle** indicates the active row for line or programmable/intercom/drop button selection.

When the display is blank, the handset is either turned off or in "sleep" mode. Activate the display by pressing [*On/Off*] or **3**.

Line Status Indicators

Each line status indicator corresponds to a specific outside line or programmable/intercom/drop button:

PARTNER Systems

A **triangle** (▲) is the equivalent of a green LED on a wired phone.

A **rectangle** (□) is the equivalent of a red LED on a wired phone.

All Other Systems

A **triangle** (▲) is the equivalent of a red LED on a wired phone.

A **rectangle** (□) is the equivalent of a green LED on a wired phone.



Volume Adjustment

To increase or decrease the volume of the handset alerter or the receiver (earpiece):

- **Alerter:** Press the "+" or the "-" button while the MDW 9031 is awake but turned *off*. If the display is dark (the phone is in "sleep" mode), press **(3)** to wake it up, then press the "+" or the "-" button.
- **Receiver:** press the "+" or the "-" button while the MDW 9030P is turned *on*.

Battery Charger LEDs

The color of the battery charger's LEDs indicates the state of the corresponding battery pack, as shown in the following table:

Battery charger LED shows...	If it is the SPARE LED, the battery pack in the Spare battery compartment...	If it is the HANDSET LED, the battery pack in the Handset...	If it is the REFRESH LED, the Refresh button was pressed, and the Handset battery pack...
Steady orange	Is charging	Is charging	N/A
Steady green	Is fully charged	Is fully charged	N/A
Flashing red * See note.	Has one of the following problems: <ul style="list-style-type: none"> • Is not seated properly in the charger • Has dirty contacts • Is defective 	Has one of the following problems: <ul style="list-style-type: none"> • Is not seated properly in the charger • Has dirty contacts • Is defective 	N/A
Steady red	Is in the Discharge portion of the Refresh cycle.	Is in the Discharge portion of the Refresh cycle.	Is in the Discharge portion of the Refresh cycle.

***Note:** If *either* the SPARE LED or the HANDSET LED is flashing red, **both** battery packs must be removed from the charger to clear the flashing-red condition. Address the possible problems for one battery pack at a time to determine whether one is bad.

Help!

If you need help when using your MDW 9031 with a PARTNER, MERLIN®, or MERLIN LEGEND® system in the continental U.S., call 1 800 628-2888. For all other systems, follow the procedure you normally use to get support for your communications system. Outside the continental U.S., contact your Lucent Technologies Representative or local Authorized Dealer.

Making a Call

1. Press [On/Off].
2. If desired, press (3) to move the Selection rectangle; then press (2) corresponding to the line you want.
3. Dial the call.
4. To end the call, press [On/Off].

Answering a Call

1. Press [On/Off].
2. Speak into the handset.
3. To end the call, press [On/Off].

Preselecting a Line or Button

Once Line Preselection is enabled, proceed as follows:

1. If the display is blank, press (3).
2. If necessary, press (2) to move the Selection rectangle.
3. Press (2) corresponding to the line or button you want.
4. Press [On/Off] to access the line or button.

Changing Settings or Performing Tests in Local Mode

1. Make sure the handset is turned off.
2. Press and hold (3) for 3 seconds.
3. While still holding (3), press [On/Off].
4. Press one of the following:
 - A** ([2]) to enable or disable the alerter.
 - L** ([5]) to enable or disable backlighting.
 - P** ([2]) for 3 seconds, then (3) to enable or disable Line Preselection.
 - V** ([8]) to enable or disable the vibrator.
 - W** ([9]) to enter Wireless Test Mode, then
 - [1] for signal strength
 - [2] for voice quality
 - [3] for matching radio module and slot number
 - [5] for handset power settings
 - [#] to enter Local Test Mode.
5. Press [On/Off] to exit.



CAUTION:

The MDW 9031 handset is a radio device and, like all radio devices, should not be placed next to a pacemaker. See "Guidelines for Safe and Efficient Operation" in MDW 9031 Wireless Pocketphone Installation and Use for more information.

PARTNER, MERLIN, and MERLIN LEGEND are registered trademarks of Lucent Technologies.

Lucent Technologies 503-801-165

Comcode 108170184

Issue 1 November 1997

Copyright © 1997 Lucent Technologies



TransTalk™ 9000 Digital Wireless System MDW 9031 Wireless Telephone

Kit of Parts (Order Number D-182866)

This kit contains parts that you must use to install the radio module for a single MDW 9031 Wireless Telephone. You use similar parts that are packaged with the telephone to install the battery charger. Refer to the installation guide packaged with the telephone for additional information.

Parts List

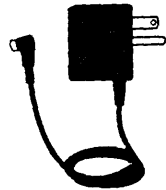

Radio Module 11-foot (3.4 m)
Power Cord and
Standard AC Adapter



Rubber Feet (4)



Philips Head
Wood Screws (2)

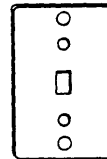

Wall Mounting
Plate

Installing a Single Radio Module

Install high on wall, leaving at least 6–12 inches (15.2–30.5 cm) between antenna and ceiling

1 Check to make sure the radio module's power cord is unplugged from the wall outlet before continuing.

2 Detach the four rubber feet. Apply them to marked areas on the underside of the radio module.

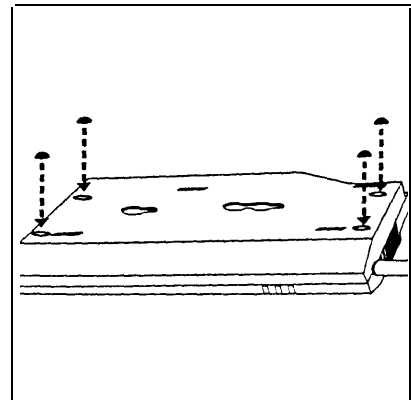

3 Place the wall mounting plate against the wall. Choose a location backed by a wooden stud (if unavailable, use toggle bolts instead of the supplied wood screws). Lightly tap a nail into the wall to start holes. Then screw the plate flush to the wall. Place the radio module over the plate, then slide it downward to lock it into place. (**Note:** do not remove the plastic cap covering the radio module's card edge.)

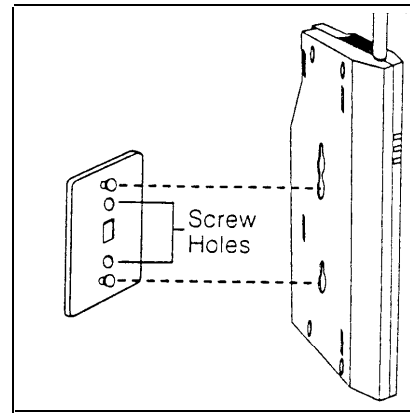

4 Insert the radio module's power cord into the side of the radio module. Insert the telephone line cord into the bottom of the radio module.

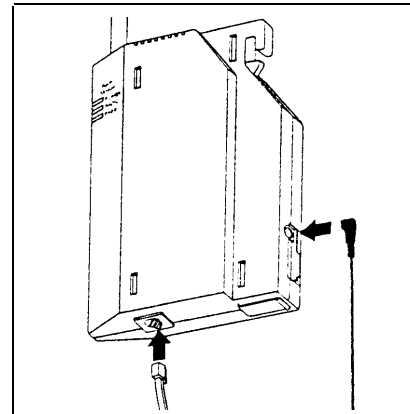

5 Insert the other end of the telephone line cord into an existing wall jack or terminal/station connector on your communications system switch/control unit (refer to your communications system manual for the proper port location).

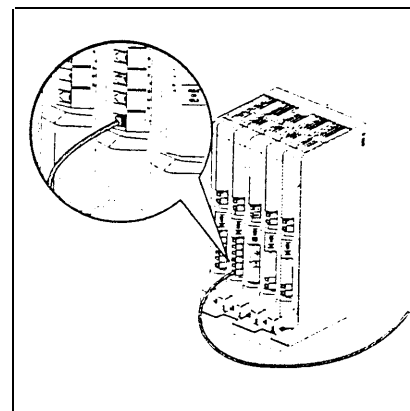

6 Plug the power cord/AC adapter into a properly grounded 3-prong wall outlet.

⚠ CAUTION: *Never connect or disconnect line cords while the radio module is plugged into the wall outlet.*

