

MEASUREMENT OF OCCUPIED BANDWIDTH

SECTION 2.1049

Section 22.901 (d) (2)

SECTION 2.1049

MEASUREMENT OF OCCUPIED BANDWIDTH

The occupied bandwidth of the FCC ID: **AS5CMP-44** ICLA was measured using a Rohde & Schwarz FSEK Spectrum Analyzer and a HP Model 520 DeskJet Printer. The RF power level was measured using RF power meter as shown in the test setup in Figure 3A. The RF output from the transmitter to spectrum analyzer was reduced (to an amplitude usable by the spectrum analyzer) by using a calibrated attenuator. This attenuation was offset on the display and the signal adjusted to the -16.1 dBc level corresponding to the corrected RF power level for a 30 kHz resolution bandwidth. The reference-line on the spectrum analyzer display corresponds to level measured by the RF power meter.

Occupied Bandwidth plots show measurements made at J4 connector antenna terminals for an output of 24 watts and at the terminals of ICLA input. The PCBR (FCC ID: AS5CMP-43) output level of 8.4 dBm approximately was required at the input terminals of ICLA to generate 24 watts power.

Table 3.1. IS 97 channel allocation consists of following channel Blocks:

Block	FCC Cellular Frequency Bands Per FCC 22.905 MHz	Valid CDMA Channels & Frequency Range	
		Channel No.	MHz
A'' (1 MHz)	869.000 - 870.000	1013 -1023	869.700 – 870.000
A (10 MHz)	870.000 - 880.000	0001- 0311	870.030 – 879.330
B (10 MHz)	880.000 - 890.000	0356 - 0644	880.680 – 889.320
A' (1.5 MHz)	890.000 - 891.500	0689 - 0694	890.670 – 890.820
B' (2.5 MHz)	891.500 - 894.000	0739 - 0777	892.170 – 893.310

The edge channels are 1013 and 0777.

Table 3.2. The frequency range used by ICLA and for FCC filing.

Block	Valid CDMA Channels	Frequency Range
A	016-283	870.48 – 878.49 MHz
B	384-617	881.52 – 888.51 MHz

The frequencies and channels used for measurements are tabulated on the bottom of each plot. The ICLA Input and output signals are plotted at each frequency blocks/bands. The input signal plots are shown as Measurement – 3A and output signal as Measurement – 3B. Plots are provided for Left Edge, center and Right Edge of cellular bands A, and B for the channels covered in the frequency ranges used by ICLA as indicated in Table 3.2. These frequencies were chosen to show the occupied bandwidth in the channels in each of the Cellular bands in

which this ICLA can be operated, in compliance with Section 22.905 of the Commission code. There is no SAT or wide band data signals associated with CDMA. The signal used to show the occupied bandwidth is defined in Table 3.3. This is the signal recommended in IS-97. The power output level was adjusted to provide the documented power levels at the bottom of each chart.

Type	Number of Channels	Fraction of Power (Linear)	Fraction of Power (dB)	Comments
Pilot	1	0.2000	-7.0	Walsh 0
Sync	1	0.0471	-13.3	Walsh 32, always 1/8 rate
Paging	1	0.1882	-7.3	Walsh 1, full rate only
Traffic	6	0.09412 each	-10.3 each	Variable Walsh Assignments, full rate only

TABLE 3.3 Base Station Test Model, Nominal

The minimum standard presented in PN-3383 and IS-97.

“Suppression inside the Licensee’s Frequency Block(s)”

For all frequencies within the base station transmit band of 869 to 894 MHz that are within the specific block(s) allocated to the operator’s system. The total conducted spurious emissions in any 30 kHz band greater than 750 kHz for the CDMA channel center frequency shall not exceed a level of -45 dBc....

The spectrum analyzer output plots show the CDMA channel signal is 16.1 dB below the reference line of the spectrum analyzer for the following reason: For the CDMA system there is no carrier without modulation. The CDMA transmit bandwidth is 1.23 MHz. Since spectrum analyzer does not have Resolution Bandwidth setting for 1.23 MHz. This relationship was used to provide the correct level for an unmodulated carrier vs. modulated signal.

$$10 \cdot \log (\text{Resolution Bandwidth} / \text{Transmit Bandwidth}) = \text{Signal Offset}$$

For the peak of the CDMA signal measured with a resolution bandwidth of 30 kHz the signal offset is:

$$\text{Signal Offset} = 10 \cdot \log (30 \text{ kHz} / 1.23 \text{ MHz}) = -16.1 \text{ dB}$$

Figure 3A. TEST CONFIGURATION FOR MEASUREMENT OF OCCUPIED BANDWIDTH

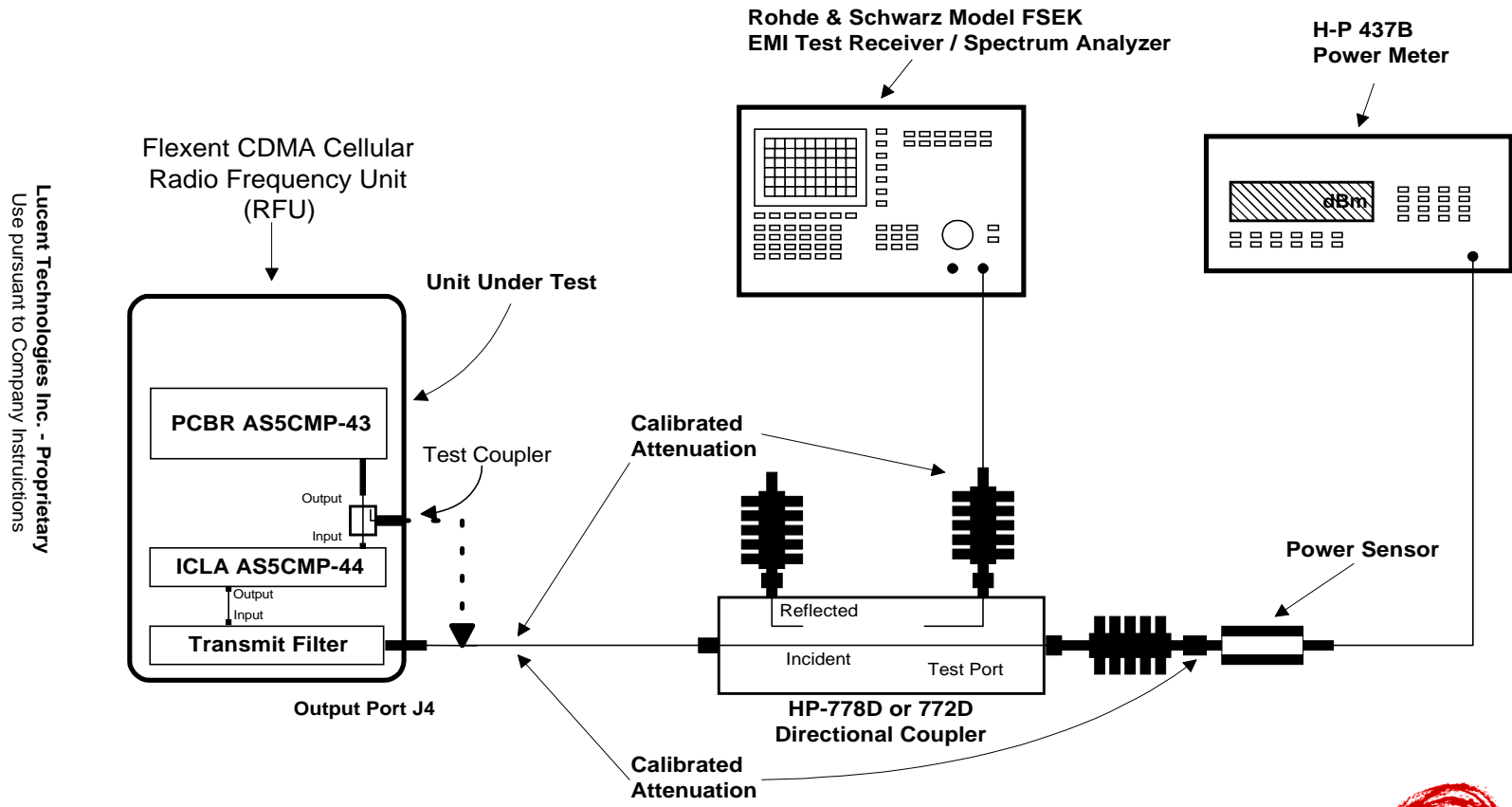

Lucent Technologies Inc. - Proprietary
Use pursuant to Company Instructions

APPLICANT: Lucent Technologies

FCC ID: AS5CMP - 44

All components are calibrated over the frequency range of interest



MEASUREMENT: 3A

ICLA INPUT

MEASUREMENT

OF

OCCUPIED BANDWIDTH

BLOCK A

(870-880 MHz)

Left Edge:	870.48 MHz (Channel 016)
Center:	873.99 MHz (Channel 133)
Right Edge:	878.49 MHz (Channel 283)



Ref Lvl
8.4 dBm

RBW 30 kHz RF Att 30 dB
VBW 300 kHz
SWT 500 ms Unit dBm

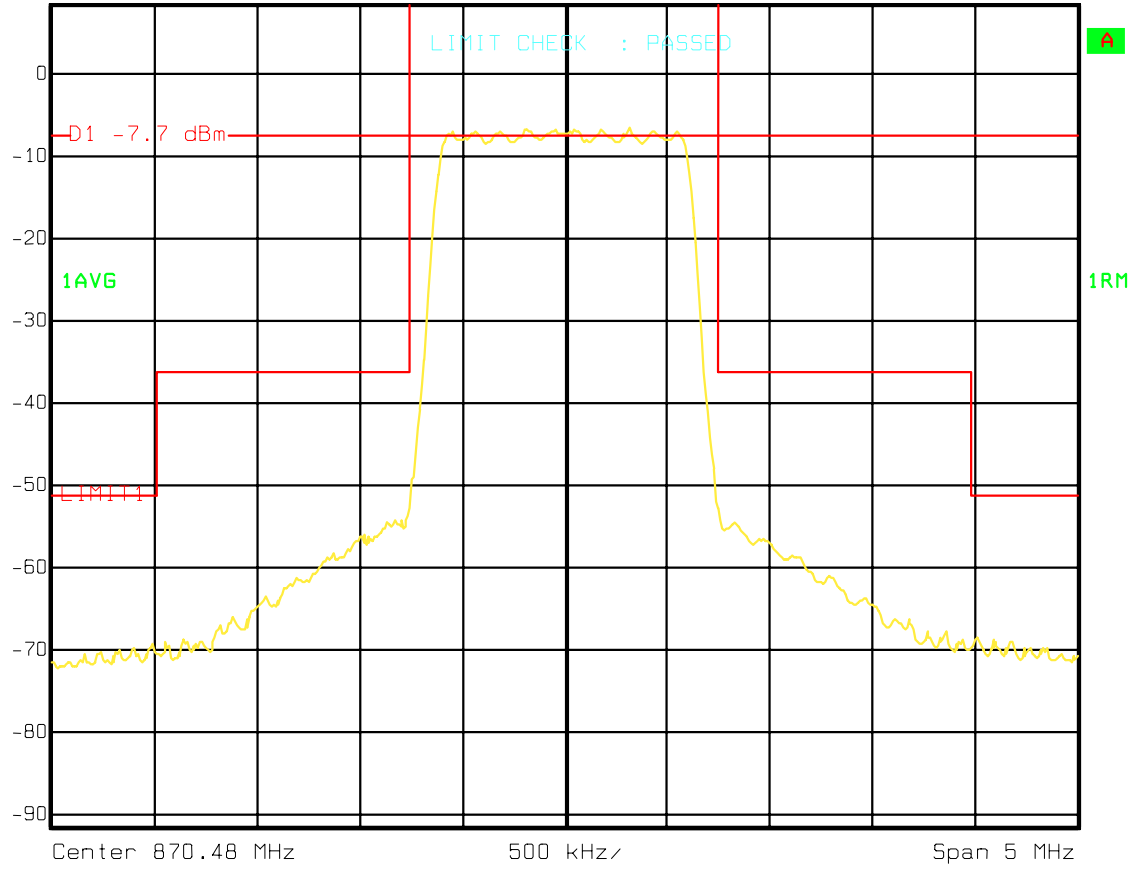

Title: OCCUPIED BANDWIDTH
Comment A: FCC ID: AS5CMP-44. Flexant CDMA MicroMini Cell Channel 16.PC
BR OUTPUT Power=8.4 dBm.
Date: 13.NOV.2000 12:46:36

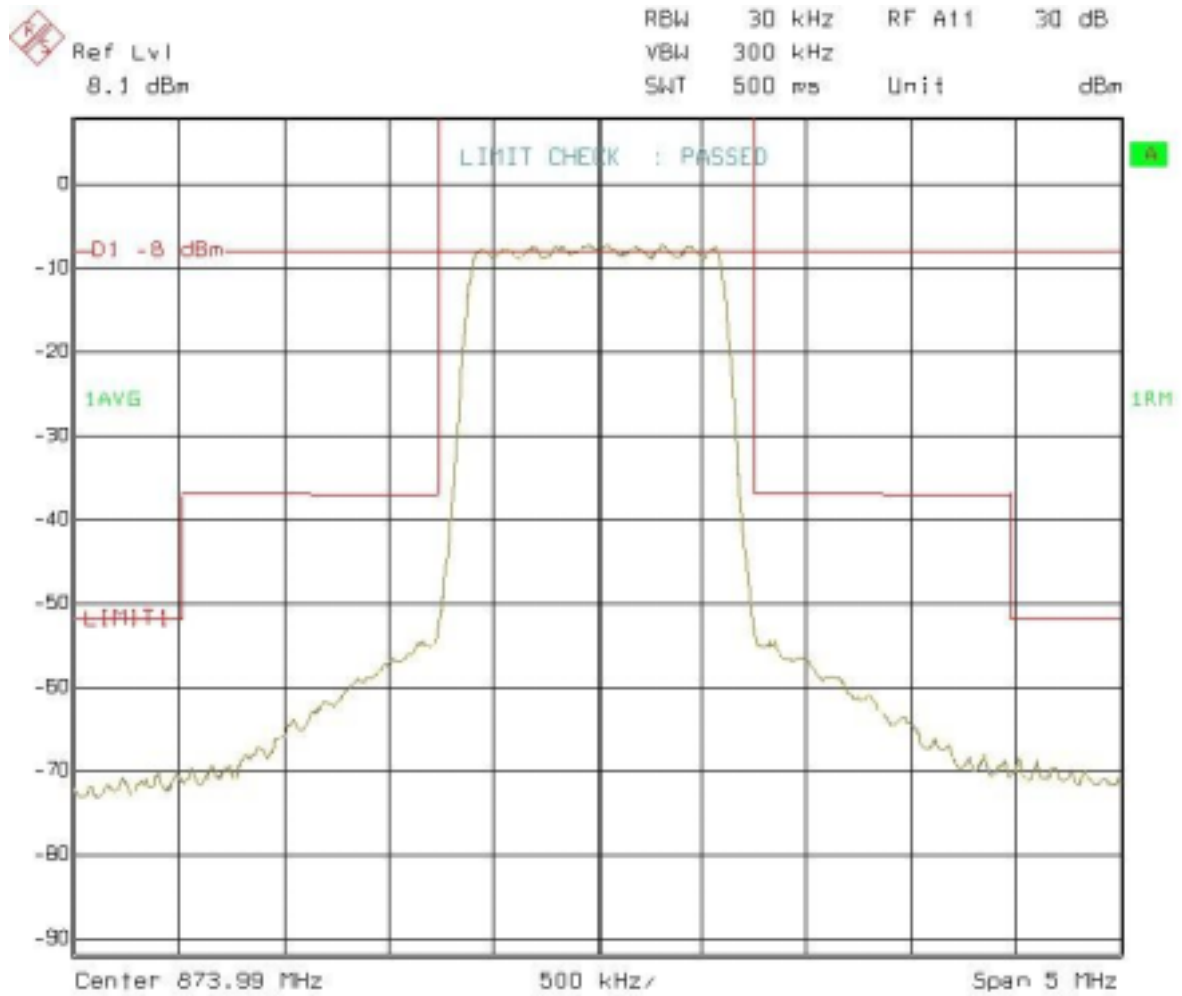

Title: OCCUPIED BANDWIDTH
Comment A: FCC ID: AS5CMP-44. Flexant CDMA MicroMini Cell Channel 133.
PCBR OUTPUT Power = 8.1 dBm.
Date: 13.NOV.2000 12:32:25



Ref Lvl
8.3 dBm

RBW 30 kHz RF Att 30 dB
VBW 300 kHz
SWT 500 ms Unit dBm

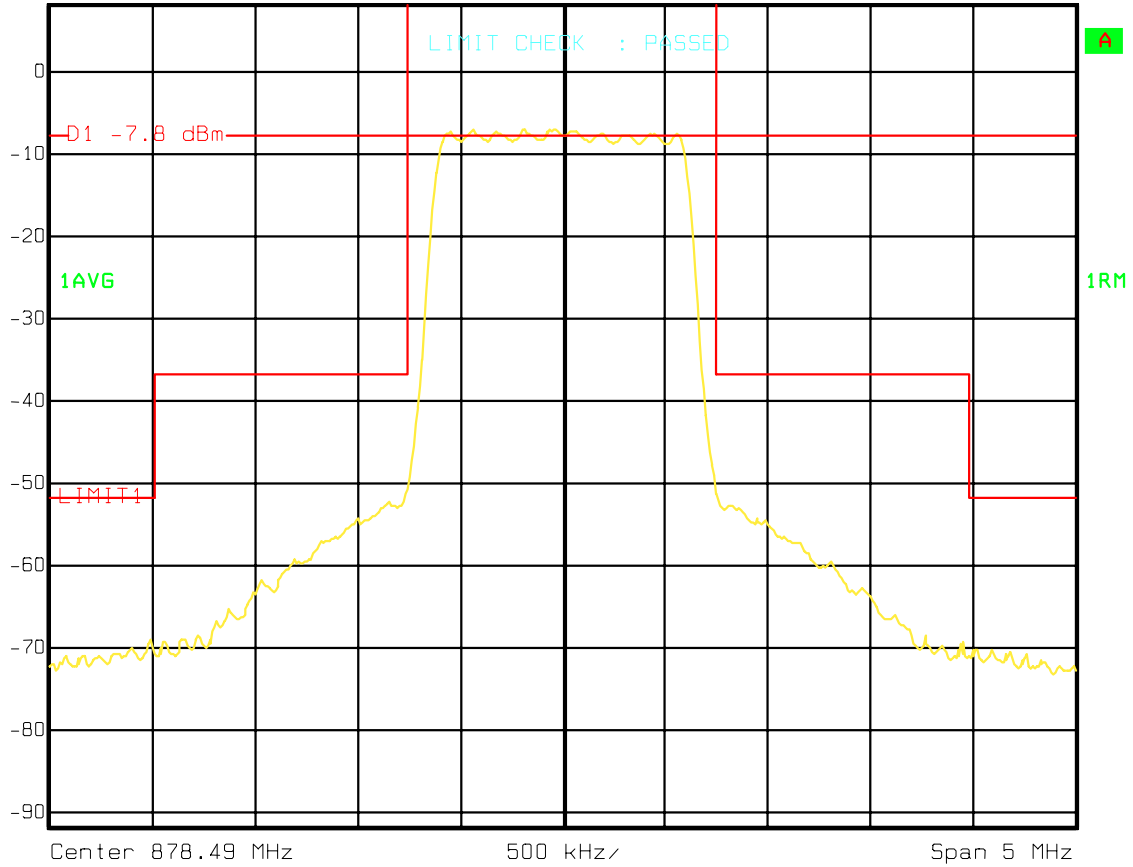

Title: Occupied Bandwidth
Comment A: FCC ID: AS5CMP-44. Flexant CDMA MicroMini Cell Channel 283.P
CBR OUTPUT Power= 8.3 dBm.
Date: 10.NOV.2000 18:23:11

MEASUREMENT: 3A

ICLA INPUT

MEASUREMENT

OF

OCCUPIED BANDWIDTH

BLOCK B

(880-890 MHz)

Left Edge:	881.52 MHz (Channel 384)
Center:	885.00 MHz (Channel 500)
Right Edge:	888.51 MHz (Channel 617)



Ref Lvl
8.5 dBm

RBW 30 kHz RF Att 30 dB
VBW 300 kHz
SWT 500 ms Unit dBm

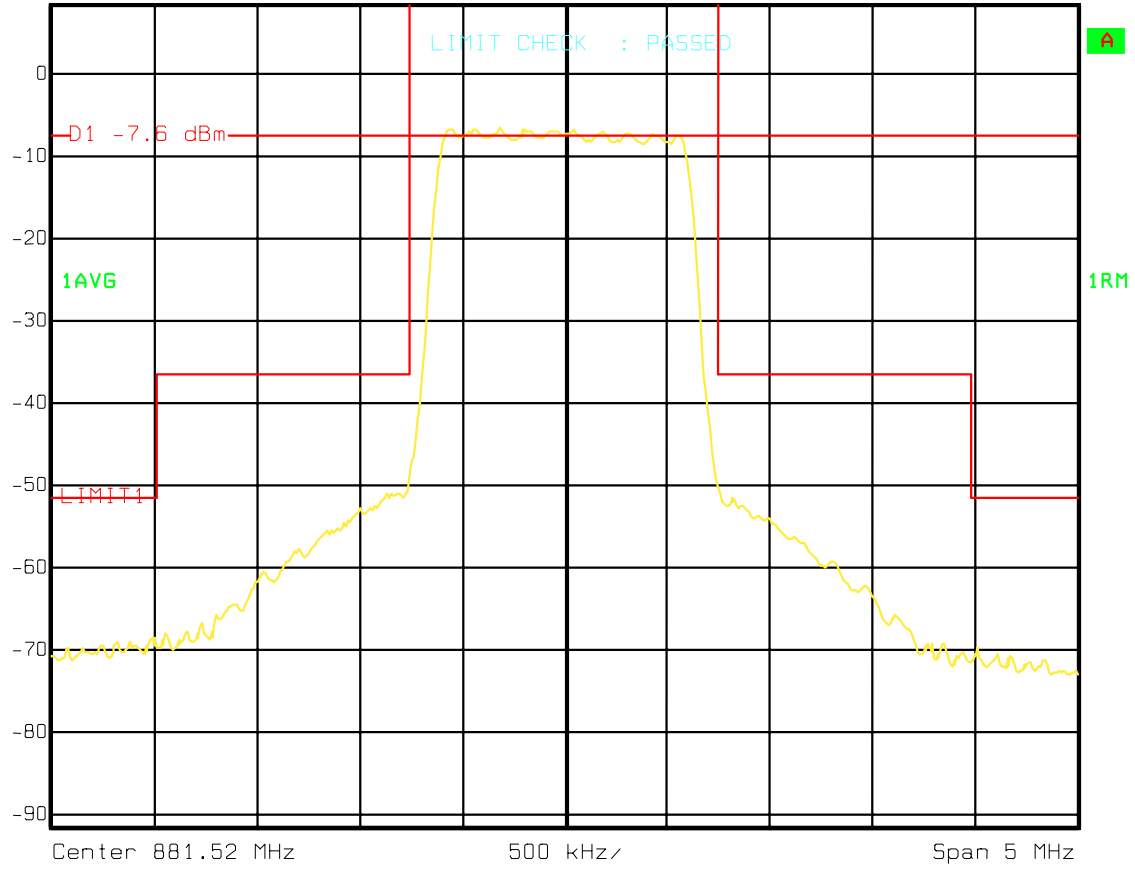

Title: Occupied Bandwidth
Comment A: FCC ID: AS5CMP-44. Flexant CDMA MicroMini Cell Channel 384.P
CBR Output Power=8.5 dBm.
Date: 13.NOV.2000 17:11:34



Ref Lvl
8.8 dBm

RBW 30 kHz RF Att 30 dB
VBW 300 kHz
SWT 500 ms Unit dBm

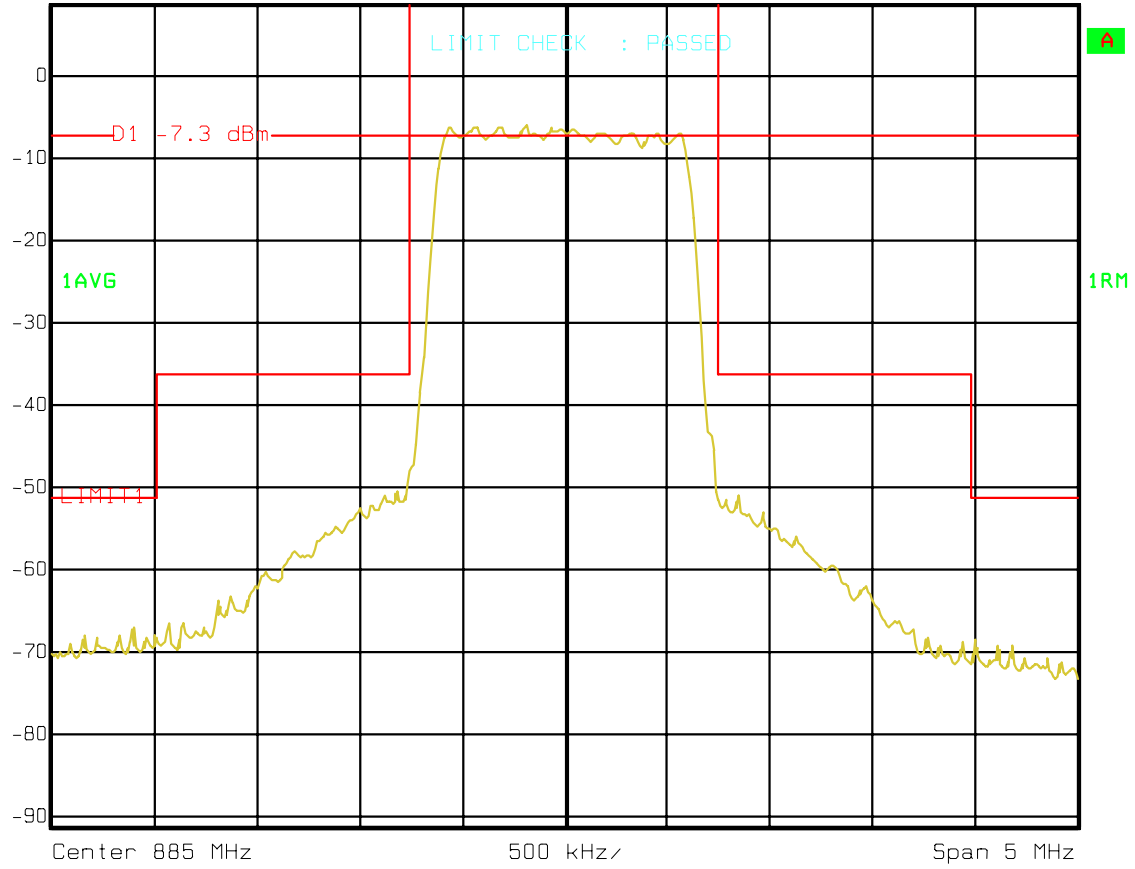

Title: Occupied Bandwidth
Comment A: FCC ID: AS5CMP-44.FLEXENT CDMA MICRO-MINI CELL (DUPLEX)
CHANNEL 500. PCBR OUTPUT POWER 8.8dBm.
Date: 24.OCT.2000 11:53:25



Ref Lvl
8.2 dBm

RBW 30 kHz RF Att 30 dB
VBW 300 kHz
SWT 500 ms Unit dBm

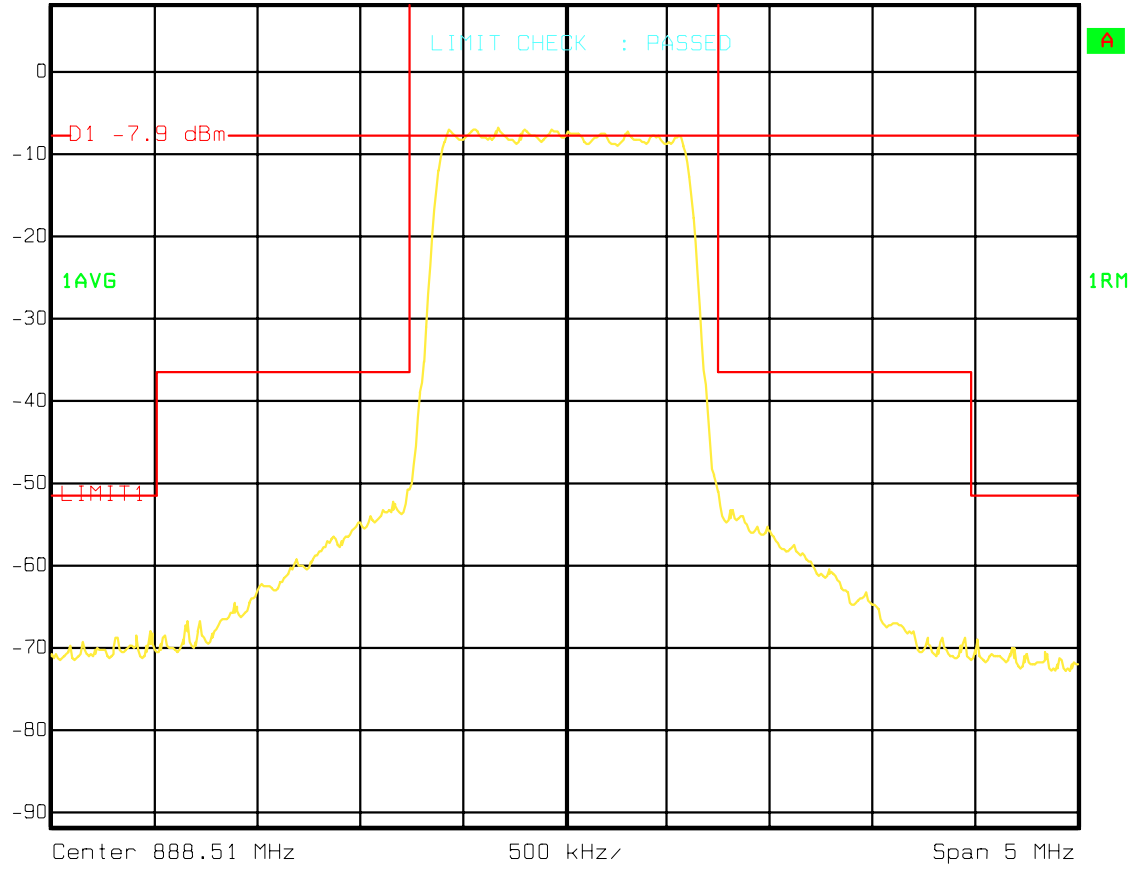

Title: Occupied Bandwidth
Comment A: FCC ID: AS5CMP-44. Flexant CDMA MicroMini Cell Channel 617.
PCBR Output Power= 8.2 dBm.
Date: 13.NOV.2000 17:23:03

MEASUREMENT: 3B

ICLA OUTPUT

MEASUREMENT

OF

OCCUPIED BANDWIDTH

BLOCK A

(870-880 MHz)

Left Edge:	870.48 MHz (Channel 016)
Center:	873.99 MHz (Channel 133)
Right Edge:	878.49 MHz (Channel 283)



Ref Lvl 43.8 dBm
RBW 30 kHz RF Att 30 dB
VBW 300 kHz
SWT 500 ms Unit dBm

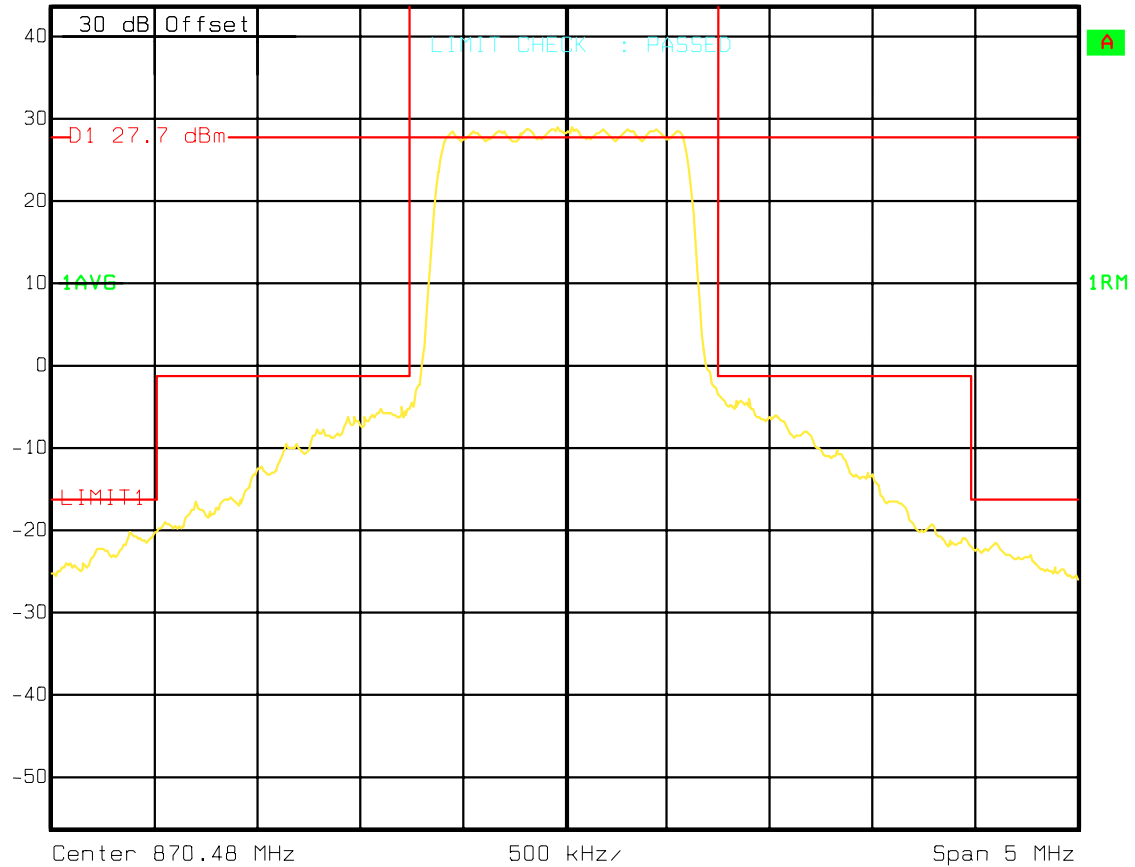

Title: OCCUPIED BANDWIDTH
Comment A: FCC ID: AS5CMP-44. Flexant CDMA MicroMini Cell Channel 16.
OUTPUT Power= 24 watts.
Date: 13.NOV.2000 12:41:30



Ref Lvl
43.8 dBm

RBW 30 kHz RF Att 30 dB
VBW 300 kHz
SWT 500 ms Unit dBm

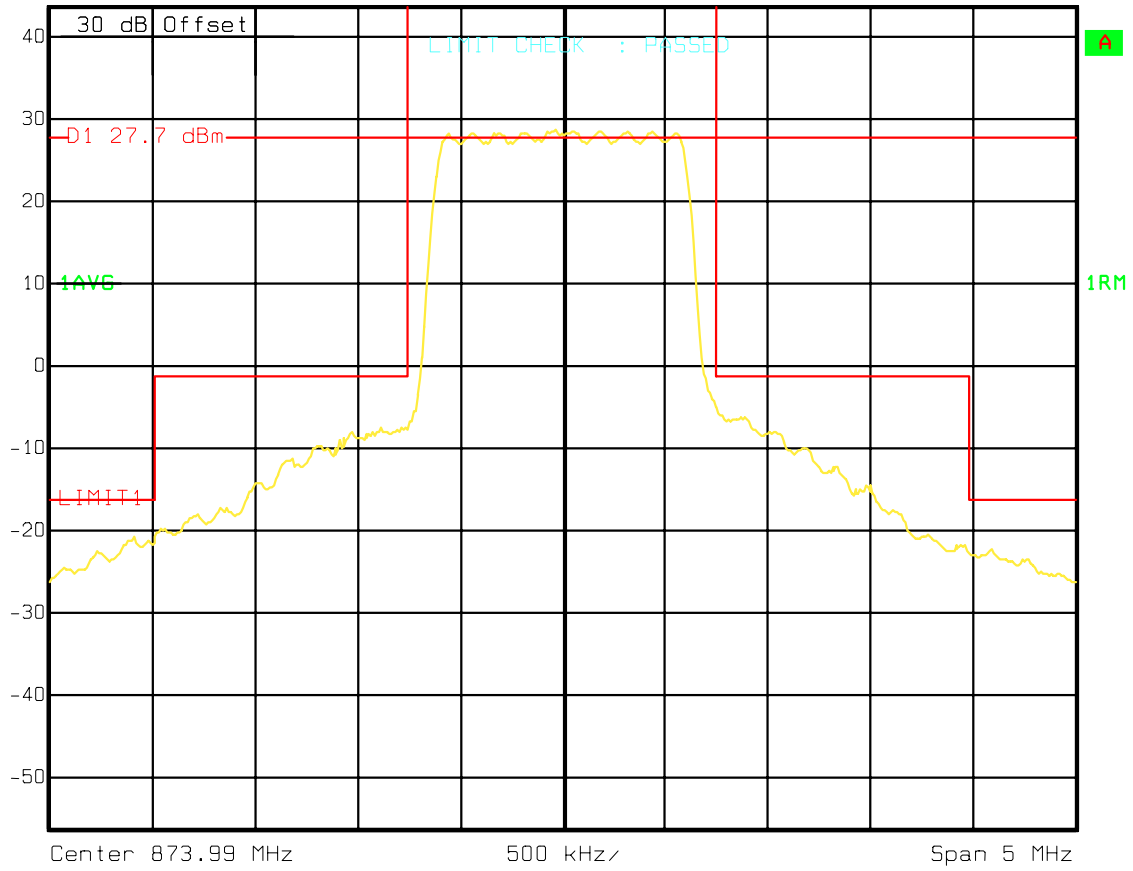

Title: OCCUPIED BANDWIDTH
Comment A: FCC ID: AS5CMP-44. Flexant CDMA MicroMini Cell Channel 133.
OUTPUT Power= 24 Watts.
Date: 13.NOV.2000 12:24:18



Ref Lvl
43.8 dBm

RBW 30 kHz RF Att 30 dB
VBW 300 kHz
SWT 500 ms Unit dBm

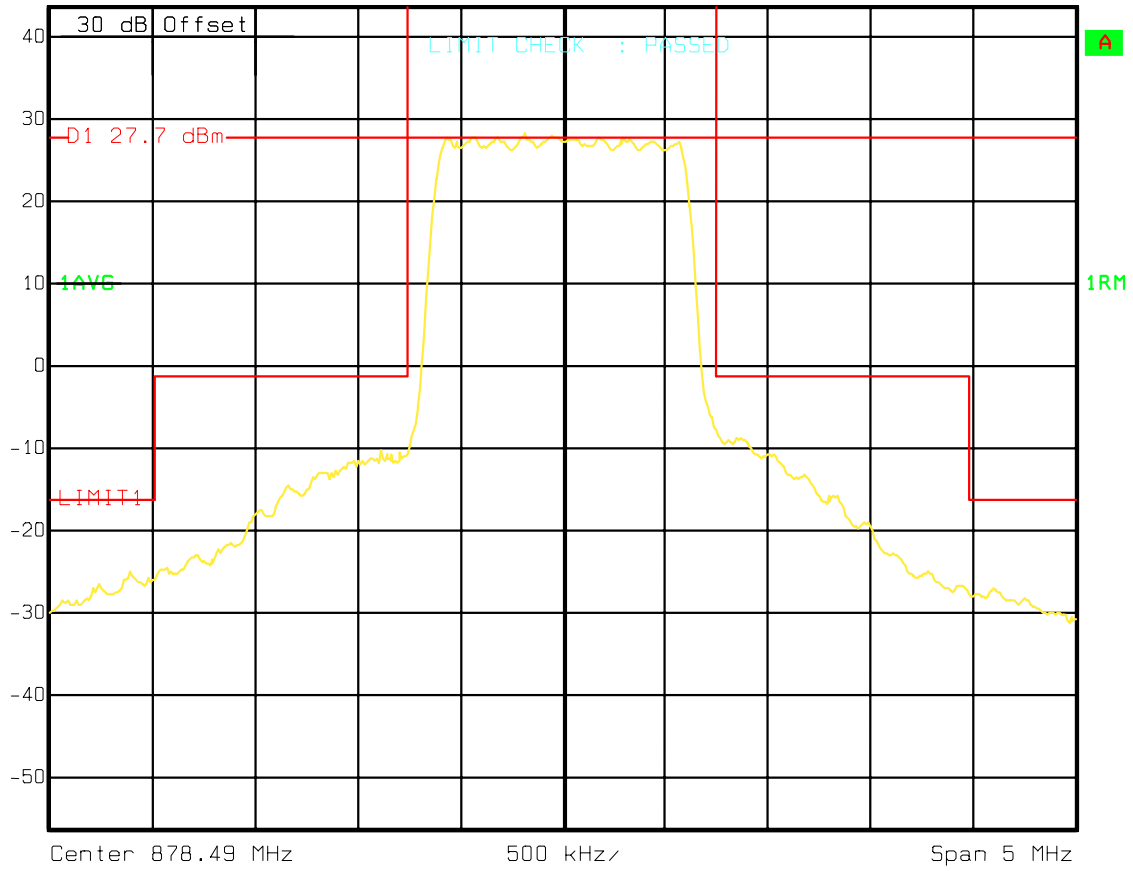

Title: OCCUPIED BANDWIDTH
Comment A: FCC ID: AS5CMP-44. Flexant CDMA MicroMini Cell Channel 283.
OUTPUT Power= 24 Watts.
Date: 13.NOV.2000 12:18:07

MEASUREMENT: 3B

ICLA OUTPUT

MEASUREMENT

OF

OCCUPIED BANDWIDTH

BLOCK B

(880-890 MHz)

Left Edge:	881.52 MHz (Channel 384)
Center:	885.00 MHz (Channel 500)
Right Edge:	888.51 MHz (Channel 617)



Ref Lvl
43.8 dBm

RBW 30 kHz RF Att 30 dB
VBW 300 kHz
SWT 500 ms Unit dBm

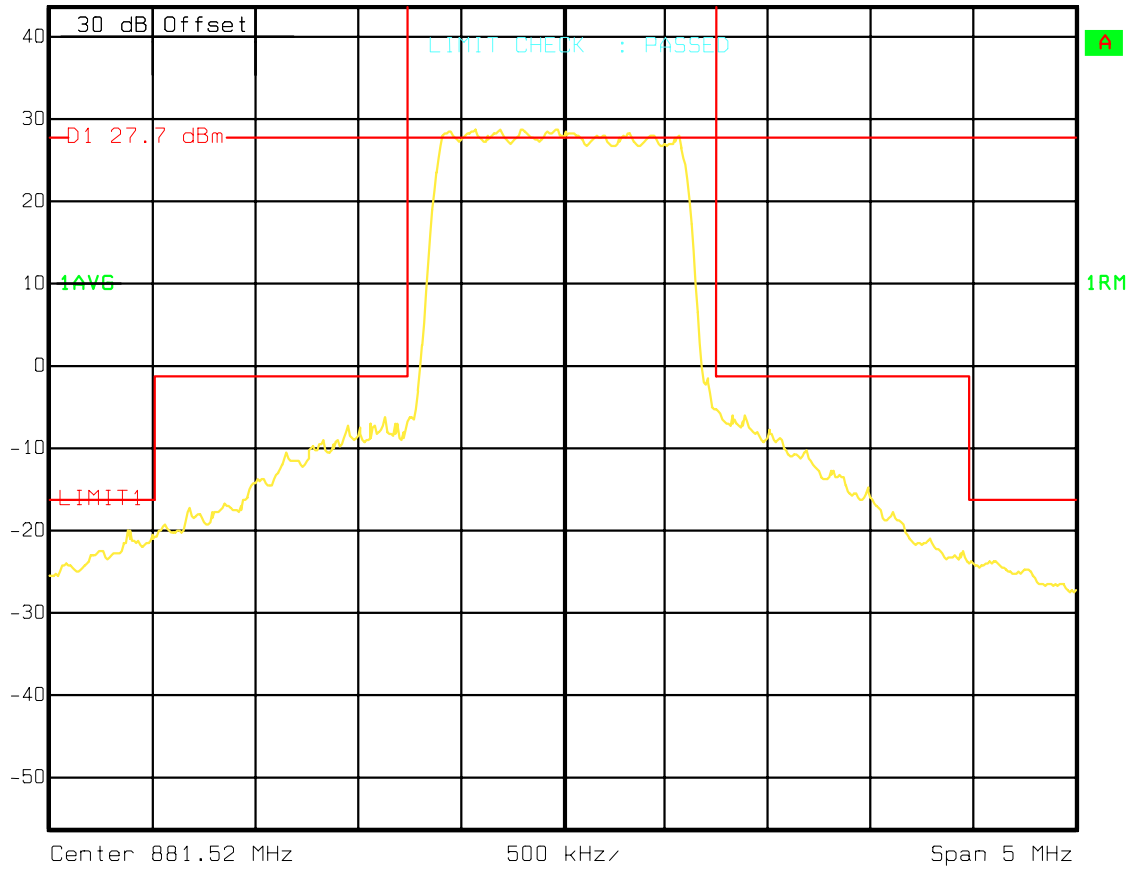

Title: Occupied Bandwidth
Comment A: FCC ID: AS5CMP-44. Flexant CDMA MicroMini Cell Channel 384.
Output Power= 24watts.
Date: 13.NOV.2000 17:15:19



Ref Lvl
43.8 dBm

RBW 30 kHz RF Att 30 dB
VBW 300 kHz
SWT 500 ms Unit dBm

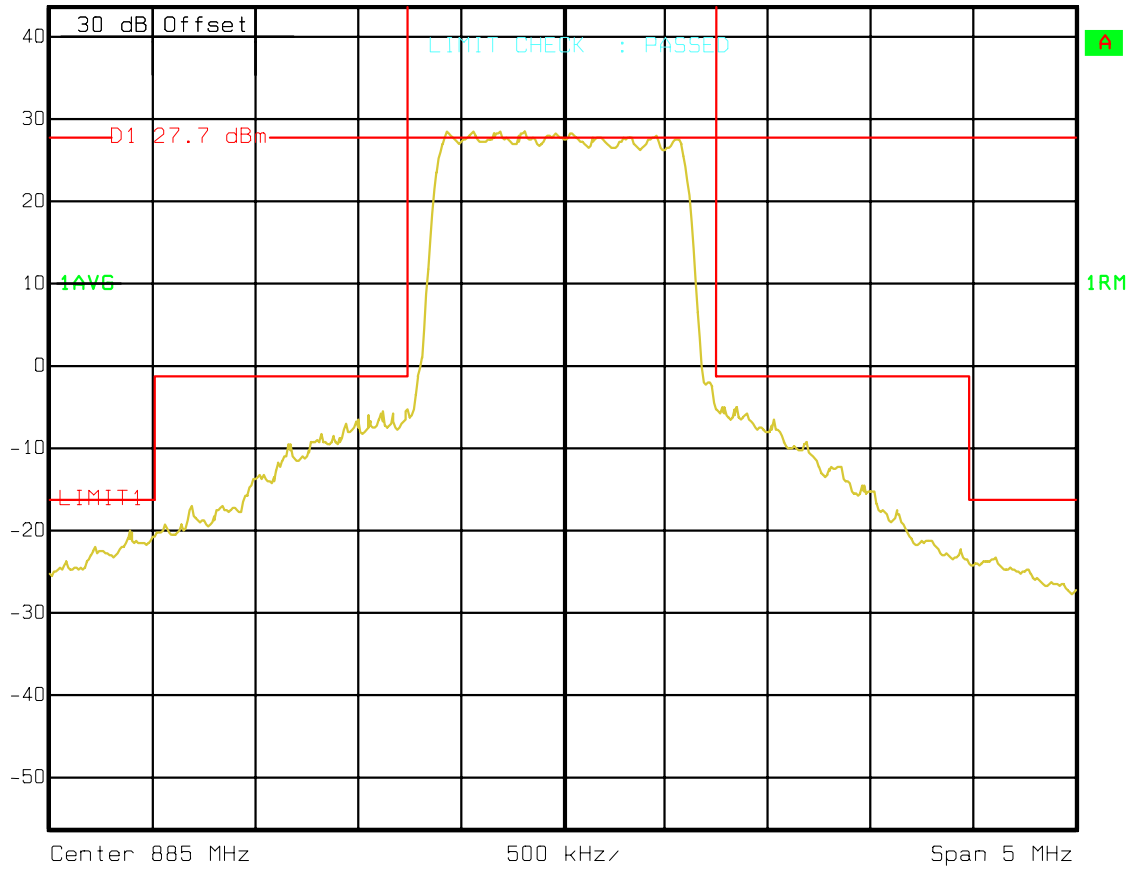

Title: Occupied Bandwidth
Comment A: FCC ID: AS5CMP-44 FLEXENT CDMA MICRO-MINI CELL (DUPLEX)
CHANNEL 500. POWER 24 WATTS
Date: 23.OCT.2000 16:09:55



Ref Lvl
43.8 dBm

RBW 30 kHz RF Att 30 dB
VBW 300 kHz
SWT 500 ms Unit dBm

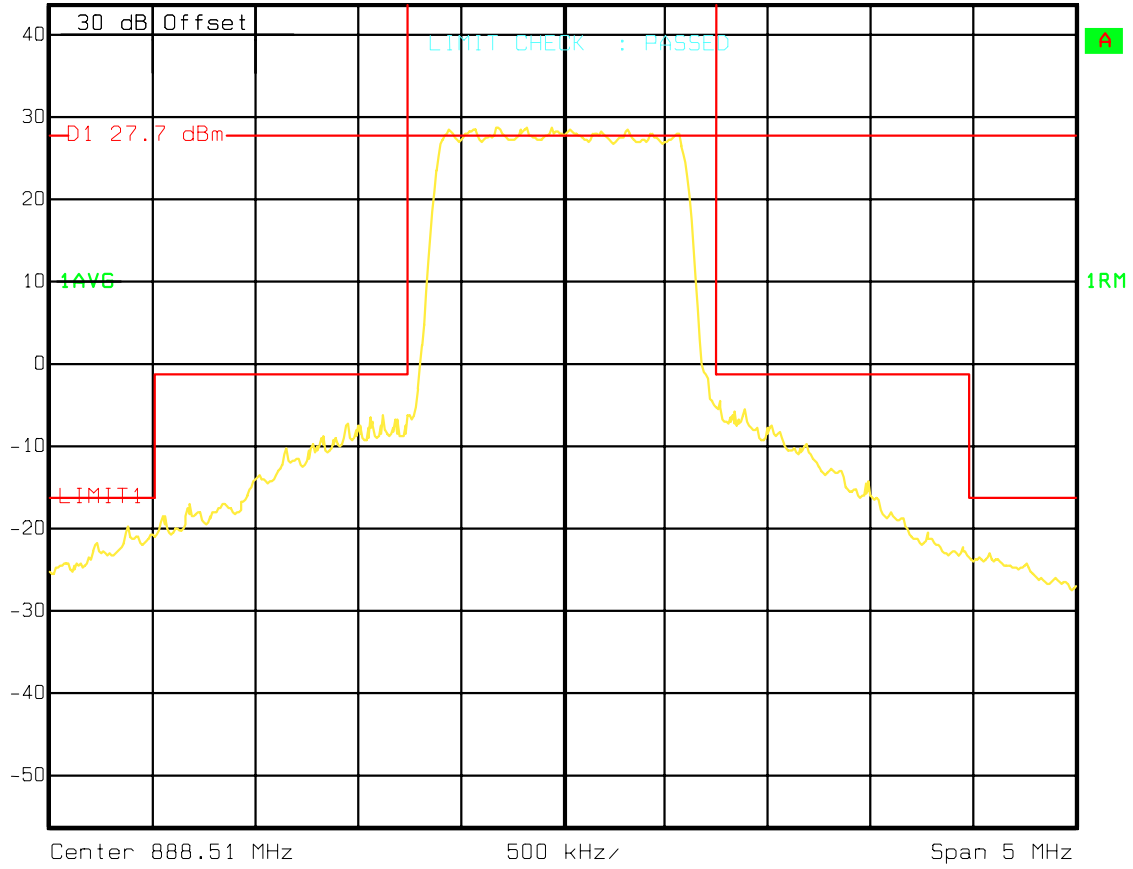

Title: Occupied Bandwidth
Comment A: FCC ID: AS5CMP-44. Flexant CDMA MicroMini Cell Channel 617.
Output Power= 24watts.
Date: 13.NOV.2000 17:18:27

