

NOKIA

Bell Labs



NVLAP LAB CODE: 100275-0

FCC Certification Test Report

Class II Permissive Change

Product Evaluated

B25 RRH 4X30
(FCC ID: AS5BBTRX-22)

Customer

Alcatel-Lucent USA, Inc.
600-700 Mountain Avenue
Murray Hill, New Jersey 07974-0636 USA

Test Laboratory

Global Product Compliance Laboratory

Alcatel-Lucent USA, Inc.
600-700 Mountain Avenue, Rm 5B-108
Murray Hill, New Jersey 07974-0636 USA

Date: January 11, 2017

Revisions

Date	Revision	Section	Change
1/10/2017	0		Initial Release
1/10/2017	1		TCB requested Changes. Revision 1

Nokia Global Product Compliance Laboratory represents to the client that testing was done in accordance with standard procedures as applicable, and that reported test results are accurate within generally accepted commercial ranges of accuracy in accordance with the scope of our NVLAP Accreditation. Nokia Global Product Compliance reports only apply to the specific samples tested. This report is the property of the client. This report shall not be reproduced except in full without the written approval of the Nokia Global Product Compliance Laboratory.

Nokia Global Product Compliance Laboratory is accredited with the US Department of Commerce National Institute of Standards and Technology's National Voluntary Laboratory Accreditation Program (NVLAP) for satisfactory compliance with criteria established in Title 15, Part 7 Code of Federal Regulations for offering test services for selected test methods in Electromagnetic Compatibility; Voluntary Control Council for Interference (VCCI), Japan; Australian Communications and Media Authority (ACMA). The laboratory is ISO 9001:2008 Certified.

Nokia Global Product Compliance Laboratory represents to the client that the laboratory's accreditation or any of its calibration or test reports in no way constitutes or implies product certification, approval, or endorsement by NVLAP, NIST, or any agency of the federal government.

Prepared By: W. Steve Majkowski NCE

Approved By: Ray Johnson

Signed:  1/11/2017
Compliance Engineer

Signed:  1/11/2017
Technical Manager

Table of Contents

1. ATTESTATION OF TEST RESULTS	4
2. SUMMARY OF THE TEST RESULTS.....	5
2.1 MEASUREMENT UNCERTAINTY.....	5
2.2 MEASUREMENT UNCERTAINTY FOR ANTENNA PORT TESTING:.....	5
3. GENERAL INFORMATION	6
3.1 PRODUCT DESCRIPTIONS.....	6
3.2 ANTENNA INFORMATION	7
4. REQUIRED MEASUREMENTS AND RESULTS.....	8
4.1 SECTION 2.1046 MEASUREMENT REQUIRED: RF POWER OUTPUT	9
4.1.1 <i>RF Power Output Measurement</i>	9
4.1.1.1 RF Power Output Results.....	9
4.1.2 <i>Peak-to-Average Power Ratio Measurement</i>	11
4.1.2.1 Peak-to-Average Power Ratio Results:.....	11
4.2 SECTION 2.1047 MEASUREMENT REQUIRED: MODULATION CHARACTERISTICS	13
4.2.1 <i>Modulation Characteristics Measurement</i>	13
4.2.1.1 Modulation Measurements Results:	13
4.3 SECTION 2.1049 MEASUREMENT REQUIRED: OCCUPIED BANDWIDTH AND EDGE OF BLOCK EMISSIONS..	15
4.3.1 <i>Results Occupied Bandwidth (Signal Bandwidth)</i>	15
4.3.2 <i>Occupied Bandwidth-Edge of Block Emissions</i>	17
4.3.2.1 Requirements	18
4.3.2.2 Measurement Offset and MIMO	18
4.3.2.3 Mask Parameters	18
4.3.2.4 Occupied Bandwidth-Edge of Block Emissions Measurements	20
4.3.2.5 Results Occupied Bandwidth-Edge of Block Emissions.....	20
4.4 SECTION 2.1051 MEASUREMENT REQUIRED: SPURIOUS EMISSIONS AT THE ANTENNA TERMINALS	56
4.4.1 <i>Section 2.1051 Spurious Emissions at Antenna Terminals</i>	56
4.4.2 <i>Required Limit</i>	56
4.4.3 <i>Operational Configuration</i>	57
4.4.4 <i>Results</i> :.....	57
4.5 SECTION 2.1055 MEASUREMENT REQUIRED: FREQUENCY STABILITY.....	62
4.5.1 <i>Frequency Stability Results</i> :.....	62
4.6 SECTION 2.1053 MEASUREMENT REQUIRED: FIELD STRENGTH OF SPURIOUS RADIATION	63
4.6.1 <i>Field Strength of Radiated Emissions Results</i> :.....	63
4.7 LIST OF TEST EQUIPMENT	70
4.7.1 <i>List of Radiated Emissions Test Equipment</i>	70
4.7.2 <i>List of Antenna Port Test Equipment</i>	71
4.8 PHOTOGRAPHS OF THE TEST SETUPS	72
4.8.1 <i>Transmitter Antenna Port Measurements</i>	72
4.8.2 <i>Radiated Test Setup</i>	73
4.9 FACILITIES AND ACCREDITATION.....	75

1. ATTESTATION OF TEST RESULTS

Company Name	Alcatel-Lucent USA, Inc.
FCC ID	AS5BBTRX-22
Product Name	B25 RRH 4X30
Model Name	B25 RRH 4X30
Part No	3JR53349ABAA-01M
Serial Number(s)	# LBALLU-YD160603Q6H
Test Standard(s)	47 CFR FCC Part 24
Reference(s)	<ul style="list-style-type: none"> • 47 CFR FCC Part 2 and Part 24 • FCC KDB 971168 D01 • ANSI C63.26 (2015)
Operating Frequency Band	PCS (Tx: 1930-1995 MHz and Rx: 1850-1910MHz), E-UTRAN Band 25
Technology	LTE
Test Frequency Range	10MHz – 20GHz
Operation Mode(s)	2x60W MIMO and 4x30W MIMO
Submission Type	Class II Permissive Change
FCC Part 15 Subpart B Compliance	Compliance with Class B
Test Date	December 6, 2016 – January 10, 2017
Test Laboratory	Global Product Compliance Laboratory 600-700 Mountain Avenue, Rm 5B-108 Murray Hill, New Jersey 07974-0636 USA

This is to certify that the above product has been evaluated and found to be in compliance with the Rules and Regulations set forth in the above standard(s). The data and the descriptions about the test setup, procedures and configuration presented in this report are accurate. The results of testing in this report apply only to the product/system which was tested. Other similar equipment will not necessarily produce the same results due to production tolerance and measurement uncertainties.

Per the requirement of Section 2.911(d) Certification of Technical Test Data, I hereby certify that the technical test data are the results of tests either performed or supervised by me.

W. Steve Majkowski NCE
 Member of Technical Staff
 Global Product Compliance Laboratory
 Alcatel-Lucent USA, Inc.

2. SUMMARY OF THE TEST RESULTS

47 CFR FCC Sections	Description of Tests	Compliance Results	Notes
2.1046	RF Power Output	Yes	
2.1047	Modulation Characteristics	YES	
2.1049, 24.238	(a) Occupied Bandwidth (b) Out-of-Band Emissions	Yes	
2.1051, 24.238	Spurious Emissions at Antenna Terminals	Yes	
2.1053, 24.238	Field Strength of Spurious Radiation	Yes	
2.1055, 24.235	Measurement of Frequency Stability	NR	

NR: Not Required
 NA: Not Applicable

2.1 Measurement Uncertainty

The results of the calculations to estimate uncertainties for the several test methods and standards are shown in the Table below. These are the worst-case values.

Worst-Case Estimated Measurement Uncertainties

Standard, Method or Procedure	Condition	Frequency MHz	Expanded Uncertainty (k=2)
a. Classical Emissions, (e.g., ANSI C63.4, CISPR 11, 14, 22, etc., using ESHS 30,	Conducted Emissions	0.009 - 30	±3.5 dB
	Radiated Emissions (AR-6 Semi-Anechoic Chamber)	30 MHz – 200MHz H	±5.1 dB
		30 MHz – 200 MHz V	±5.1 dB
		200 MHz – 1000 MHz H	±4.7 dB
		200 MHz – 1000 MHz V	±4.7 dB
	1 GHz- 18 GHz	±3.3 dB	

2.2 Measurement uncertainty for Antenna Port Testing:

- 9 kHz to 20 MHz: Frequency = 10 Hz, Amplitude = 0.5 dB
- 20 MHz to 1 GHz: Frequency = 100Hz, Amplitude = 0.5 dB
- 1 GHz to 10 GHz: Frequency = 10 kHz, Amplitude = 0.5 dB

3. GENERAL INFORMATION

3.1 Product Descriptions

The equipment under test (EUT) has the following specifications.

Table 3.1.1 Product Specifications

Specification Items	Description
Product Type	Compact Base Station (4Tx, 4Rx), 4x4 MIMO
Radio Type	Intentional Transceiver
Power Type	-48VDC
Modulation	QPSK, 16QAM, 64QAM
Operating Frequency Range	Tx 1930-1995 MHz/Rx 1850-1910 MHz
Channel Bandwidth	5, 10, 15, 20 MHz, 5+5 MHz and 10+15 MHz
Max Conducted Power (Rated)	47.8 dBm per port for 2xMIMO , 44.8 dBm per port for 4xMIMO
Software Version	NEM LR16.2_D1.12
Hardware Version	RRH 4x30 MIMO
Antenna(s)	Refer to Section 3.2

The EUT supports the following carrier configurations:

Table 3.1.2 EUT Supported Configurations

Carrier Bandwidth (MHz)	Max # of Carriers per Path	MIMO Modes	Signal Tech	Supported?	FCC Authorization
5	1	2x & 4x	LTE	✓	Previously
10	1	2x & 4x	LTE	✓	Previously
15	1	2x & 4x	LTE	✓	Previously
20	1	2x & 4x	LTE	✓	Previously
5+5	2	2x & 4x	LTE	✓	Previously
10+15	2	2x & 4x	LTE	✓	Previously
5+10	2	2x & 4x	LTE	✓	This application
10+10	2	2x & 4x	LTE	✓	This application
10+15	2	2x & 4x	LTE	✓	This application
5+5+5	3	2x & 4x	LTE	✓	This application
10+5+5	3	2x & 4x	LTE	✓	This application
10+10+5	3	2x & 4x	LTE	✓	This application
10+10+10	3	2x & 4x	LTE	✓	This application
5+5+15	3	2x & 4x	LTE	✓	This application
5+10+15	3	2x & 4x	LTE	✓	This application

The operating band consists of the following blocks and spectrum:

Table 3.1.3 EUTRAN 25, PCS Band

PCS Blocks	Tx Downlink Frequency Range (MHz)	Rx Uplink Frequency Range (MHz)	Width of Block (MHz)
A	1930 - 1945	1850 - 1865	15
D	1945 - 1950	1865 - 1870	5
B	1950 - 1965	1870 - 1885	15
E	1965 - 1970	1885 - 1890	5
F	1970 - 1975	1890 - 1895	5
C	1975 - 1990	1895 - 1910	15
G	1990 - 1995	1910 - 1915	5

3.2 Antenna Information

The product does not incorporate integrated antennas.

4. REQUIRED MEASUREMENTS AND RESULTS

The EUT is a Class II Permissive Change. Per 47CFR FCC Section 2.1033(c)(14), the following certification tests are required by Section 2.1046 through Section 2.1057. The measurement was conducted in accordance with the procedures set out in Section 2.1041.

47 CFR FCC Sections	Description of Tests	Required	Notes
2.1046	RF Power Output	Yes	
2.1047	Modulation Characteristics	Yes	
2.1049, 24.238	(a) Occupied Bandwidth (b) Out-of-Band Emissions	Yes	
2.1051, 24.238	Spurious Emissions at Antenna Terminals	Yes	
2.1053, 24.238	Field Strength of Spurious Radiation	Yes	
2.1055, 24.235	Measurement of Frequency Stability	NR	

4.1 Section 2.1046 MEASUREMENT REQUIRED: RF POWER OUTPUT

This test is a measurement of the total RF power level transmitted at the antenna-transmitting terminal. The product was configured for test as shown in Figure 4.1.1 below and allowed to warm up and stabilize per KDB 971168 D01 and ANSI C63.26.

For LTE transmit carrier operation, the **PCS LTE RRH 4x30 Band 25 Outdoor Transceiver System** is specified to provide a continuous maximum power output of 120 Watts as the sum total of RF output power of its Transmit antenna terminals. It does this by either providing 60W (47.78 dBm +/- 1 dB) for all of the carriers at either its Tx1 / Tx2 transmit antenna terminals or by providing 30W (44.77 dBm +/- 1 dB) for all of the carriers at the Tx1, Tx2, Tx3 & Tx4 transmit antenna terminals.

For this Class II Change, the operation of the 2x60W and 4x30W MIMO modes were evaluated with two and three carrier combinations. For demonstration of worst case operation, multiple combinations of 5, 10 or 15 MHz carriers were spread across the entire PCS band.

4.1.1 RF Power Output Measurement

Power measurements were conducted with a broadband Power Meter in the average mode per KDB 971168 D01. The applied signal from an **PCS LTE RRH 4x30 Band 25 Outdoor Transceiver System / AS5BBTRX-22**, met the recommended characteristics as defined in **3GPP TS 36.211 V9.1.0 (2010-03) titled: 3rd Generation Partnership Project; Technical Specification Group Radio Access Network; Evolved Universal Terrestrial Radio Access (E-UTRA); Physical Channels and Modulation (Release 9)**.

The maximum rated mean power at the antenna transmitting terminal was measured with combined QPSK +/- 16QAM and with 64QAM modulation respectively. This power level is documented on each data sheet for Occupied bandwidth and Conducted spurious emissions.

RF Power Output Results

The measured RF power outputs of the EUT are given in Table 4.1.1.1 The RF power output was measured for the 2x60W and 4x30W MIMO configurations as addressed by this Class II Change. The measured performance was in full compliance with the Rules of the Commission This detailed on each of the plots comments in Sections 4.3 and 4.4.

Figure 4.1.1 Test Set-Up for Measurement of Radio Frequency Power Output

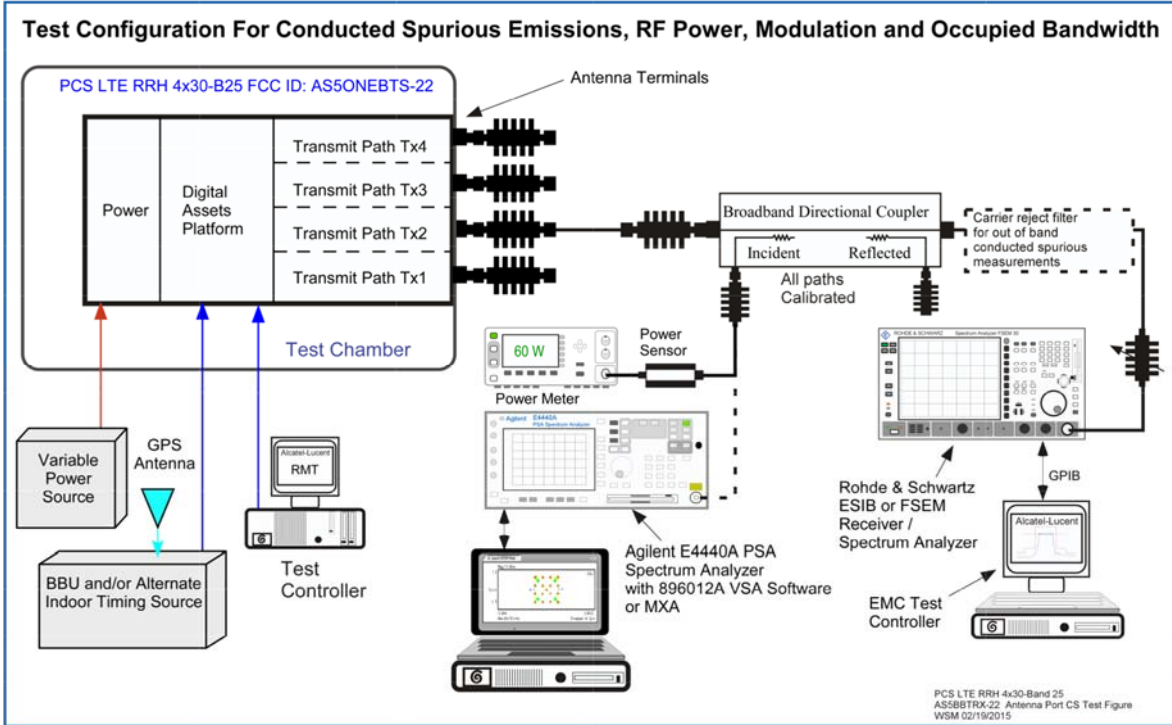

Table 4.1.1.1 Measured Maximum Average RF Output Power of the EUT

Test #	PCS Blocks	Port	MIMO Mode	Signal Bandwidth, MHz	Modulation Q16=qpsk+16qam 64=64QAM	Total Transmit Power, Watts	Total Transmit Power, dBm
1	A+CG	Tx1	4x30W	5+10	QPSK+16QAM	30	44.77
2	A+CG	Tx1	4x30W	5+10	64QAM	30	44.77
3	A+CG	Tx3	4x30W	10+10	Q16, 64QAM	30	44.77
4	A+B	Tx3	4x30W	10+10	64QAM, Q16	30	44.77
5	A+CG	Tx3	4x30W	15+10	64QAM	30	44.77
6	A+CG	Tx3	4x30W	10+15	64QAM	30	44.77
7	A+E+G	Tx3	4x30W	10+5+5	64QAM	30	44.77
8	A+E+G	Tx3	4x30W	5+5+5	QPSK+16QAM	30	44.77
9	A+E+G	Tx3	4x30W	5+5+5	64QAM	30	44.77
10	A+D+CG	Tx4	4x30W	5+5+15	Q16, Q16, 64QAM	30	44.77
11	A+B+CG	Tx4	4x30W	5+10+15	64QAM	30	44.77
12	A+B+CG	Tx4	4x30W	10+10+10	64QAM	30	44.77
13	A+B+G	Tx4	4x30W	10+10+5	64, 64, Q16	30	44.77
14	A+B+CG	Tx1	2x60W	5+5+15	Q16, Q16, 64QAM	60	47.8
15	A+B+CG	Tx1	2x60W	5+10+15	64QAM	60	47.8
16	A+B+CG	Tx2	2x60W	10+10+10	64QAM	60	47.8
17	A+B+G	Tx2	2x60W	10+10+5	QPSK+16QAM	60	47.8
18	A+B+G	Tx2	2x60W	10+10+5	Q16, & 64QAM	60	47.8

4.1.2 Peak-to-Average Power Ratio Measurement

The Peak-to-Average Power Ratio (PAPR) of the EUT has also been measured per KDB 971168 D01 using the setup in Figure 4.1.1 above. These measurements were made for every carrier in the test table for both 2x60W and 4x30W carriers as tabulated in Table 4.1.2.

For either the combined QPSK+16QAM modulation or for the 64QAM the PAPR values (0.1% probability) of the EUT were measured to be below the 13dB requirement. The maximum PAPR value for each measured configuration is given in Table 4.1.2. Sample measurements are shown in the plots in Figure 4.1.2 below.

Table 4.1.2 The Maximum PAPR Value at 0.1% probability of the EUT

Test #	PCS Blocks	Port	Signal Bandwidth, MHz	Modulation Q16=qpsk+16qam 64=64QAM	Total per Port Power, Watts	Maximum Peak Average Power Ratio Value at 0.1% Probability (dB)		
						Left Carrier	Right Carrier	Middle Carrier
1	A+CG	Tx1	5+10	QPSK+16QAM	30	10.5	10.1	-
2	A+CG	Tx1	5+10	64QAM	30	9.5	10.2	-
3	A+CG	Tx3	10+10	Q16, 64QAM	30	10.0	10.2	-
4	A+B	Tx3	10+10	64QAM, Q16	30	10.2	10.1	-
5	A+CG	Tx3	15+10	64QAM	30	10.8	10.6	-
6	A+CG	Tx3	10+15	64QAM	30	10.2	11.8	-
7	A+E+G	Tx3	10+5+5	64QAM	30	10	9.9	10.0
8	A+E+G	Tx3	5+5+5	QPSK+16QAM	30	10.1	10.0	10.0
9	A+E+G	Tx3	5+5+5	64QAM	30	10.1	10.0	10.0
10	A+D+CG	Tx4	5+5+15	Q16, Q16, 64QAM	30	10.0	10.5	10.0
11	A+B+CG	Tx4	5+10+15	64QAM	30	10.0	10.5	10.5
12	A+B+CG	Tx4	10+10+10	64QAM	30	10.1	10.0	10.6
13	A+B+G	Tx4	10+10+5	64, 64, Q16	30	10.1	10.2	10.2
14	A+B+CG	Tx1	5+5+15	Q16, Q16, 64QAM	60	9.5	9.8	10.0
15	A+B+CG	Tx1	5+10+15	64QAM	60	9.5	9.8	10.0
16	A+B+CG	Tx2	10+10+10	64QAM	60	9.5	9.5	9.8
17	A+B+G	Tx2	10+10+5	QPSK+16QAM	60	9.9	9.5	10.0
18	A+B+G	Tx2	10+10+5	64QAM	60	10.1	9.6	10.0

Peak-to-Average Power Ratio Results:

The maximum Peak-to-Average Power Ratio (PAPR) of the EUT measured at its antenna transmitting terminals were measured to be in full compliance with the ≤ 13 dB Rules of the Commission and are listed above.

Figure 4.1.2 Sample Peak to Average Power Ratio Measurements Plots

Configuration 18-3

10 MHz

B Block QPSK+16QAM

2x MIMO

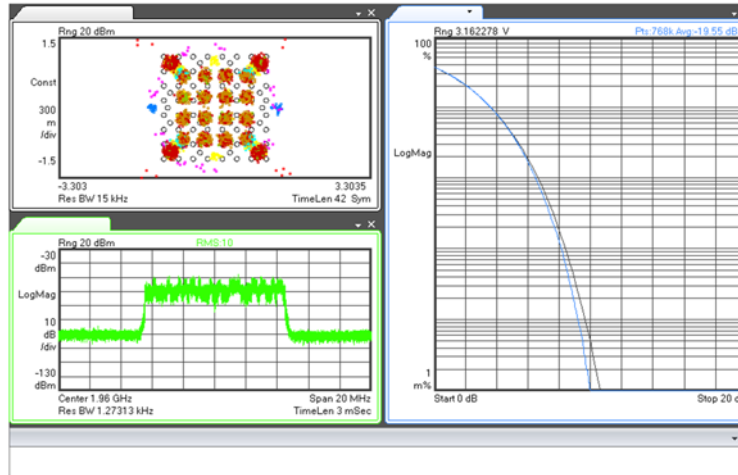

Configuration 9-1

5 MHz

A Block 64QAM

4x MIMO

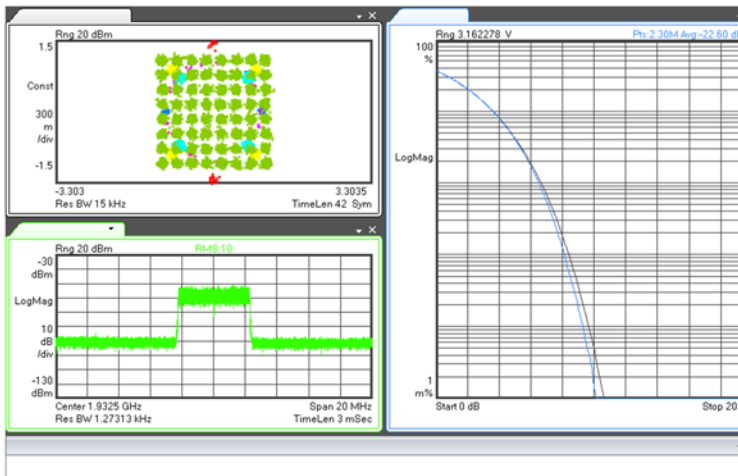

Configuration 11-2

15 MHz

CG Block 64QAM

4x MIMO

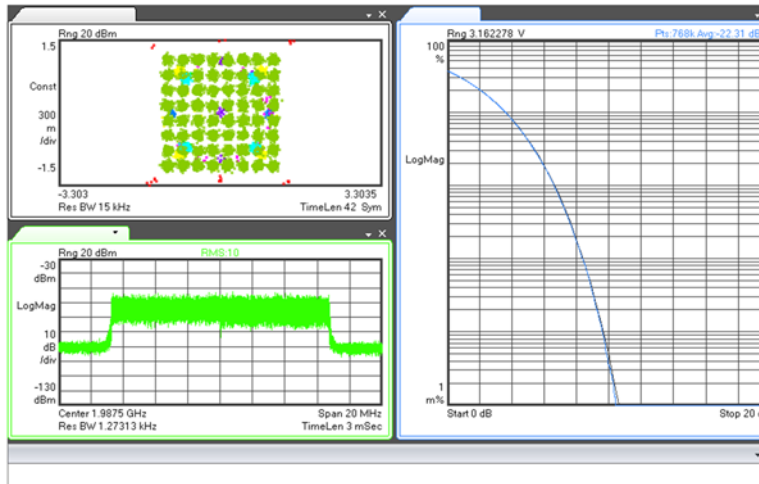

4.2 Section 2.1047 MEASUREMENT REQUIRED: MODULATION CHARACTERISTICS

The B25 RRH 4X30 supports LTE technologies. LTE utilizes Orthogonal Frequency Division Multiplexing (OFDM) which splits the carrier frequency bandwidth into many small subcarriers. Each individual subcarrier was modulated with a combined QPSK + 16QAM or with a 64QAM digital modulation formats.

In QPSK, there are 4 possible symbol states and each symbol carries 2 bits of information. In 16QAM, there are 16 possible symbol states and each 16-QAM symbol carries 4 bits of information. While in 64QAM, there are 64 possible symbol states and each 64-QAM symbol carries 6 bits of information. Higher-order modulation, where the constellations become more dense, is more sensitive to poor channel conditions than the lower-order modulation.

The modulation characteristics measurement of LTE carriers measures the difference between the ideal symbols and the measured symbols after the equalization. The measurement was performed for the combined QPSK + 16QAM and for the 64QAM at all of the channels as documented in table 4.2 below.

4.2.1 Modulation Characteristics Measurement

The measurements were performed at the antenna transmitting terminal of the base station system with a signal analyzer which was calibrated in accordance with ISO 9001 process.

The test set-up diagram is given in the Figure 4.2.1, where the signal analyzer used the external signals from the base station as its trigger source and time reference. Figure 4.1.2 above shows representative screen plots of the modulation measurement for an LTE carrier in QPSK +16QAM and 64QAM modulations.

Modulation Measurements Results:

The measured modulation characteristics of the EUT are tabulated in Table 4.2 and are in full compliance with the Rules of the Commission.

Table 4.2 Modulation Results

Test #	PCS Blocks	Port	Signal Bandwidth, MHz	Modulation Q16=qpsk+16qam 64=64QAM	Total per Port Power, Watts	Modulation Results Pass / Fail		
						Left Carrier	Right Carrier	Middle Carrier
1	A+CG	Tx1	5+10	QPSK+16QAM	30	Pass	Pass	-
2	A+CG	Tx1	5+10	64QAM	30	Pass	Pass	-
3	A+CG	Tx3	10+10	Q16, 64QAM	30	Pass	Pass	-
4	A+B	Tx3	10+10	64QAM, Q16	30	Pass	Pass	-
5	A+CG	Tx3	15+10	64QAM	30	Pass	Pass	-
6	A+CG	Tx3	10+15	64QAM	30	Pass	Pass	-
7	A+E+G	Tx3	10+5+5	64QAM	30	Pass	Pass	Pass
8	A+E+G	Tx3	5+5+5	QPSK+16QAM	30	Pass	Pass	Pass
9	A+E+G	Tx3	5+5+5	64QAM	30	Pass	Pass	Pass
10	A+D+CG	Tx4	5+5+15	Q16, Q16, 64QAM	30	Pass	Pass	Pass
11	A+B+CG	Tx4	5+10+15	64QAM	30	Pass	Pass	Pass
12	A+B+CG	Tx4	10+10+10	64QAM	30	Pass	Pass	Pass
13	A+B+G	Tx4	10+10+5	64, 64, Q16	30	Pass	Pass	Pass
14	A+B+CG	Tx1	5+5+15	Q16, Q16, 64QAM	60	Pass	Pass	Pass
15	A+B+CG	Tx1	5+10+15	64QAM	60	Pass	Pass	Pass
16	A+B+CG	Tx2	10+10+10	64QAM	60	Pass	Pass	Pass
17	A+B+G	Tx2	10+10+5	QPSK+16QAM	60	Pass	Pass	Pass
18	A+B+G	Tx2	10+10+5	Q16 & 64QAM	60	Pass	Pass	Pass

Figure 4.2.1 Test Set-Up for Measurement of Modulation, Occupied Bandwidth and Out-of-Band Emissions

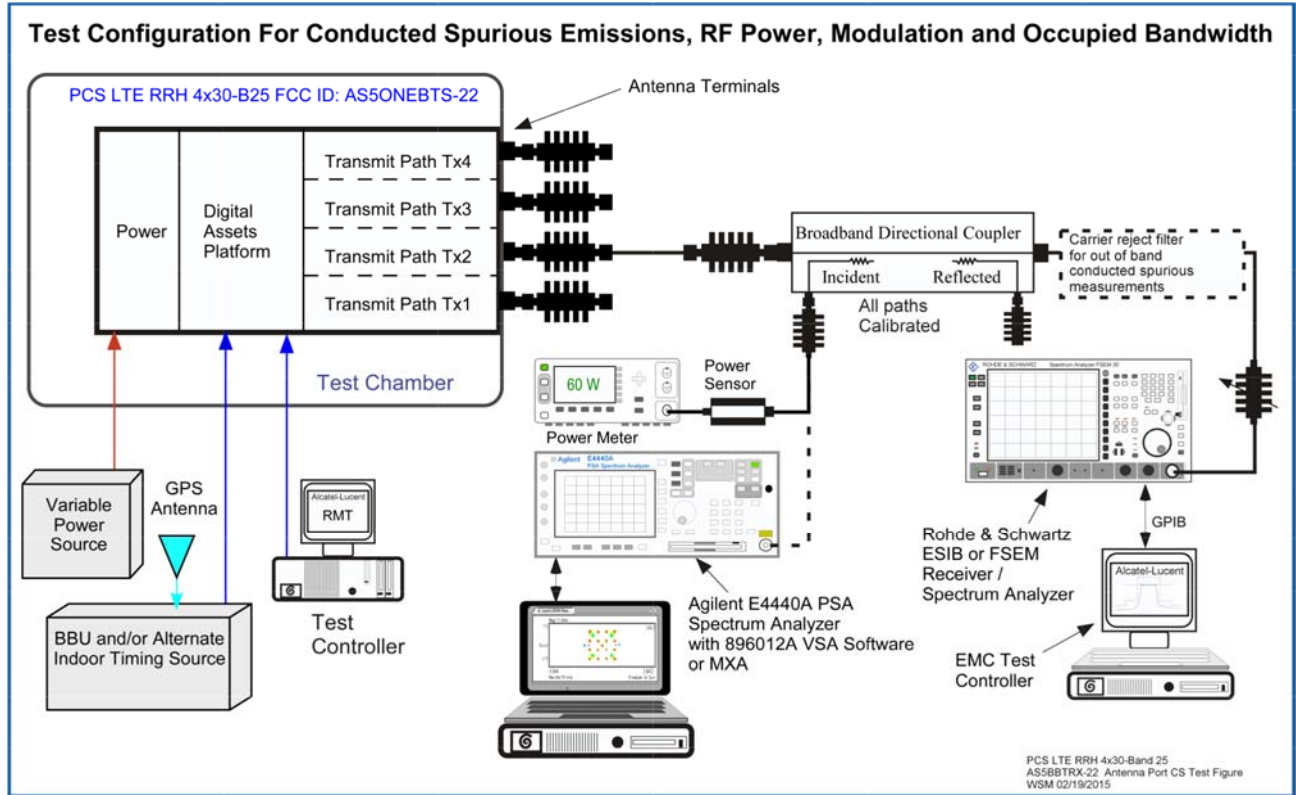

4.3 Section 2.1049 MEASUREMENT REQUIRED: OCCUPIED BANDWIDTH AND EDGE of BLOCK EMISSIONS

This test measures the Occupied Bandwidth of the transmitting carrier and the Edge of-Block Emissions in the frequency spectrum immediately outside and adjacent to the transmitting carrier(s).

The occupied bandwidth (OBW) is usually defined either as the 99% power OBW or a relative OBW. The 99% OBW is the signal bandwidth such that, below its lower and above its upper frequency limits, the mean power radiated or conducted are each equal to 0.5 percent of the total mean power radiated or conducted by a given emission. The relative OBW is defined as the width of the signal between two points, one below the carrier center frequency and one above the carrier center frequency, outside of which all emissions are attenuated by at least X dB below the transmitter power, where the value of X is typically specified as 26.

Per KDB 971168 D01 v02r02, the relative OBW must be measured and reported when it is specified in the applicable rule part; otherwise, the 99% OBW shall be measured and reported. The OBW shall be measured when modulated by an input signal such that its amplitude and symbol rate represent the maximum rated conditions under which the equipment is operated.

4.3.1 Results Occupied Bandwidth (Signal Bandwidth)

The measured 99% occupied bandwidth and -26 dB relative bandwidth was measured with a Keysite MXA signal analyzer for the 5M00F9W, 10M0F9W and 15M0F9W emission designators. The results are in Figure 4.3 .1 below and shows that the measured signals are within the parameters of the emissions designator. .

FIGURE 4.3.1- Occupied Bandwidth - Typical Signal Bandwidth

5M00F9W

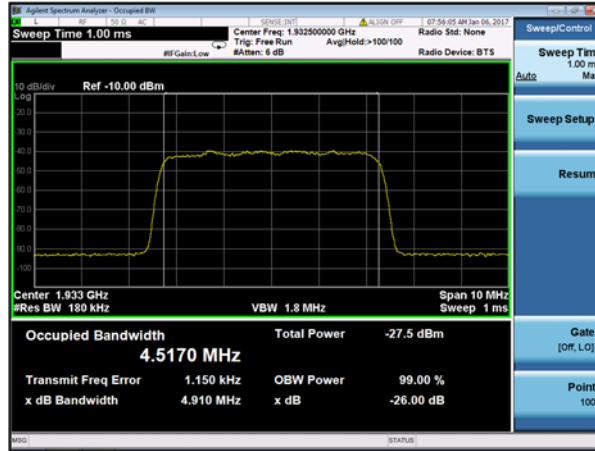

10M0F9W

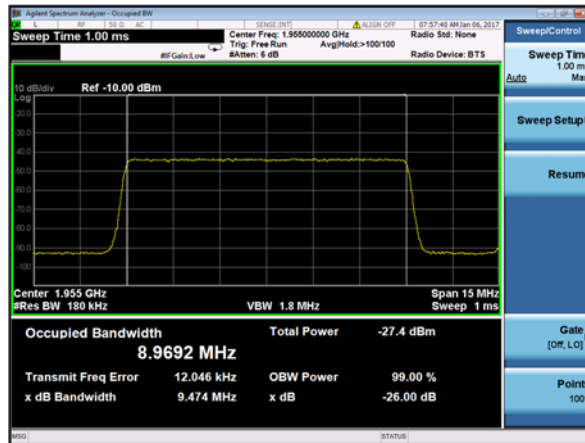

15M0F9W

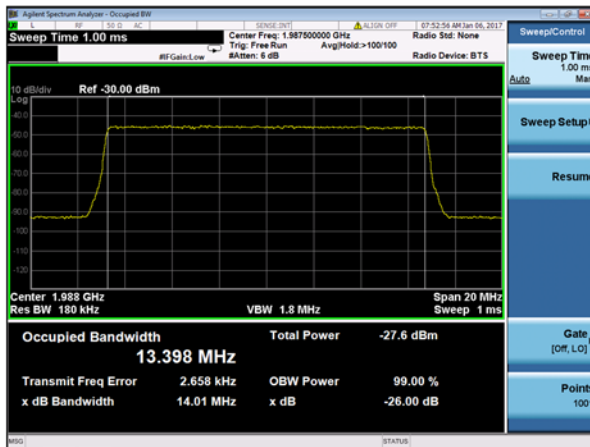

4.3.2 Occupied Bandwidth-Edge of Block Emissions

Classical Occupied Bandwidth – Edge of Block Emissions is an evaluation of the transmit carrier compliance with edge of block/edge of band requirements. This measurement documents the product's ability to maintain compliance with FCC Parts 2 and 24 limitations on emissions outside the block of operation.

The **B25 RRH 4X30** Distributed Base station system supports single-carrier and multiple-carrier configurations with CDMA and LTE technologies. This evaluation addresses multicarrier operation with 5, 10 or 15 MHz carriers in 2x60W and 4x30W MIMO operation. In each test configuration two or three carriers were configured in multiple PCS Blocks and spread across the band. All power adjustments were performed prior to other measurements. Power was set to the total per port maximum for the specific configuration with equal levels of power per carrier. The measurements are described below.

The occupied bandwidth of each of the signals identified in Table 4.3.2 was measured using a Rohde & Schwarz ESIB-40 EMI Receiver/ Spectrum Analyzer, a PC based instrumentation controller using TILE™ software and calibrated RF attenuation and coupled signal path. The measurement process meets the requirements of ANSI C63.26 and ISO17025. The RF power level was measured and adjusted via the test setup in Figure 4.3. The set RF output from the transmitter was reduced by calibrated broadband attenuators to amplitudes usable by the spectrum analyzer and power meter. The attenuation factors are reflected in the displayed values of the charts. The typical occupied bandwidth measurement displays the signal adjusted to the reference level corresponding to the corrected RF power level for the signal bandwidth and given resolution bandwidth (RBW). This set-point was performed as follows:

For each test the power calibration was individually verified at the transmitter antenna connection (J4) with a power meter by using the test setup depicted in Figure 4.3. The power calibration was performed to calibrate the spectrum analyzers power measurement against the more accurate power meter measurement. This provides a specific reference for both the measured 30 and/or 100 kHz RBW Occupied Bandwidth signal at the signal reference line and the 3 MHz RBW measurement against the power calibration line which is the below the "Top of Mask" limit. The "Top of Mask" limit corresponds to a single carrier signal at the specified power level of the carrier if measured with an RBW greater than the emissions bandwidth. Since the power calibration measurements was performed with a 3 MHz RBW a power calibration line equal to $10 \log(3\text{MHz}/\text{Emissions Bandwidth})$ is placed below the top of mask. The specific levels are specified in Table 4.3.2.3 which details the limits for all of the measurements.

In each occupied bandwidth measurement there are two traces which track each other a given distance apart in amplitude. The top trace is the power calibration trace and this carrier is set to the power calibration line. The second trace is the occupied bandwidth measurement. The power calibration measurements is performed along with each Occupied Bandwidth measurement. The signals measured at RBW's of 3 MHz and 30/100 kHz were corrected for path loss and were plotted against the mask limit. As part of the calibration between the power meter measurement and the test analyzer, software was used to place the 3 MHz RBW signal at the carrier power calibration line for the specific carriers signal. The carrier as measured with 3 MHz and 30/100 kHz RBW were corrected with the same attenuation factors. The two measurements are co-plotted on the same graph. A typical single carrier example is shown in Figure 4.3.2.3 which depicts a single 5 MHz carrier inside the D Block mask.

The test procedure above, calibrates the carrier power against the Mask and accurately places the measured occupied bandwidth carrier at the -22.2 dBm reference line. All of the plots are presented with a sufficiently wide frequency span for the specific signals or Block of interest. This allows for ease of comparison of the multi-carrier performance. This data was electronically recorded using the TILE™ software and electronically placed in the Occupied Bandwidth Data Sheets. These sheets contain data for multiple mixed carrier configurations for "Left Edge of Block", and "Right Edge of Block" across the PCS Band.

Requirements

The Limit in 47 CFR 24.238(a)(b) for emissions in the 1 MHz band immediately outside and adjacent to a licensee's frequency block is:

Emissions <1 MHz outside the Block *when measured with a RBW of 1%* of the emissions Bandwidth shall be attenuated by :

$$-\{43+10\log(\text{mean power output in watts})\} = -13 \text{ dBm}$$

The Limit in 47 CFR 24.238(a) for emissions outside a licensee's frequency block is:

Emissions >1 MHz outside the Block, *when measured with a RBW of 1 MHz*, shall be attenuated by :

$$-\{43+10\log(\text{mean power output in watts})\} = -13 \text{ dBm.}$$

The requirement of FCC Part 24.238 was used as the required emission limit mask in the LTE measurement. The sampling average was used in all measurement.

Measurement Offset and MIMO

The spectrum analysis output plots shows the peak of the LTE channel signal at the reference line that is 22.22 dB below the top of Mask reference of the spectrum analyzer. For the LTE system there is no carrier without modulation. Since the LTE signal is broadband and is 5, 10 or 15 MHz wide, all measurements performed at narrower resolution bandwidths needs to be evaluated with limits adjusted for the reduction in signal energy. The following relationship was used to provide the correct level for an unmodulated carrier vs. the modulated signal.

$$10^* \log(\text{Resolution Bandwidth} / \text{Transmit Bandwidth}) = \text{Signal Offset (1)}$$

For the peak of the 5, 10 or 15 MHz LTE signal measured with a RBW of 30/100/100 kHz the signal offset is:

$$\text{Signal Offset} = 10^* \log(30 \text{ kHz} / 5 \text{ MHz}) = -22.22 \text{ dB}$$

$$\text{Signal Offset} = 10^* \log(100 \text{ kHz} / 10 \text{ MHz}) = -20.00 \text{ dB}$$

$$\text{Signal Offset} = 10^* \log(100 \text{ kHz} / 15 \text{ MHz}) = -21.76 \text{ dB}$$

Since the 5 to 15 MHz LTE signal is wider than the 3 MHz spectrum analyzer setting used for power calibration a power calibration line must be placed below the top of mask. The offset for the power calibration line is:

$$\text{Power Calibration Offset} = 10^* \log(3 \text{ MHz} / 5 \text{ MHz}) = -2.22 \text{ dB}$$

$$\text{Power Calibration Offset} = 10^* \log(3 \text{ MHz} / 10 \text{ MHz}) = -5.23 \text{ dB}$$

$$\text{Power Calibration Offset} = 10^* \log(3 \text{ MHz} / 15 \text{ MHz}) = -6.99 \text{ dB}$$

For MIMO operation the limits must be adjusted per the equation:

$$\text{MIMO Offset} = 10\text{LOG}(n) \text{ where } n = \text{MIMO Value}$$

$$\text{For 2x MIMO} = 10\text{LOG}(n) = 3.01 \text{ dB}$$

$$\text{For 4x MIMO} = 10\text{LOG}(n) = 6.02 \text{ dB}$$

Mask Parameters

The parameters for all of the limits used for these tests are detailed in Table 4.3.2.3, below.

Per Part 24 limits which are specified as appropriate at a given RBW can be measured and evaluated at other RBW's if the limit is adjusted per equation (1). Table 4.3.2.3, below, identifies all of the limits and calibrations line levels used on the Occupied Bandwidth Masks to evaluate Out of Band Emissions. The line designations are as identified on the sample OBW chart Figure 4.3.2.3

Table 4.3.2.3 Mask Parameters

Carrier Power line a-aa		Signal BW	Measurement RBW		Power Calibration Line g-gg		Signal Offset Reference level Line t-tt		"n" x MIMO	MIMO Factor	Limit for 1st MHz Outside the Block Lines c-b & bb-cc		Limit for Beyond the 1st MHz Outside the Block Lines e-d & dd-ee	
W	dBm		MHz	MHz	RF Power	Offset	Level	dBc			dBm	n	dB	dBm
10	40.00	5	0.03	3	-2.22	37.78	-22.22	17.78	4	6.02	-21.24	-61.24	-34.25	-74.25
10	40.00	10	0.1	3	-5.23	34.77	-20.00	20.00	4	6.02	-19.02	-59.02	-29.02	-69.02
10	40.00	15	0.1	3	-6.99	33.01	-21.76	18.24	4	6.02	-20.78	-60.78	-29.02	-69.02
15	41.76	5	0.03	3	-2.22	39.54	-22.22	19.54	4	6.02	-21.24	-63.00	-34.25	-76.01
15	41.76	10	0.1	3	-5.23	36.53	-20.00	21.76	4	6.02	-19.02	-60.78	-29.02	-70.78
15	41.76	15	0.1	3	-6.99	34.77	-21.76	20.00	4	6.02	-20.78	-62.54	-29.02	-70.78
20	43.01	5	0.03	3	-2.22	40.79	-22.22	20.79	2	3.01	-18.23	-61.24	-31.24	-74.25
20	43.01	10	0.1	3	-5.23	37.78	-20.00	23.01	2	3.01	-16.01	-59.02	-26.01	-69.02
20	43.01	15	0.1	3	-6.99	36.02	-21.76	21.25	2	3.01	-17.77	-60.78	-26.01	-69.02

Figure 4.3.2.3 Mask Parameters

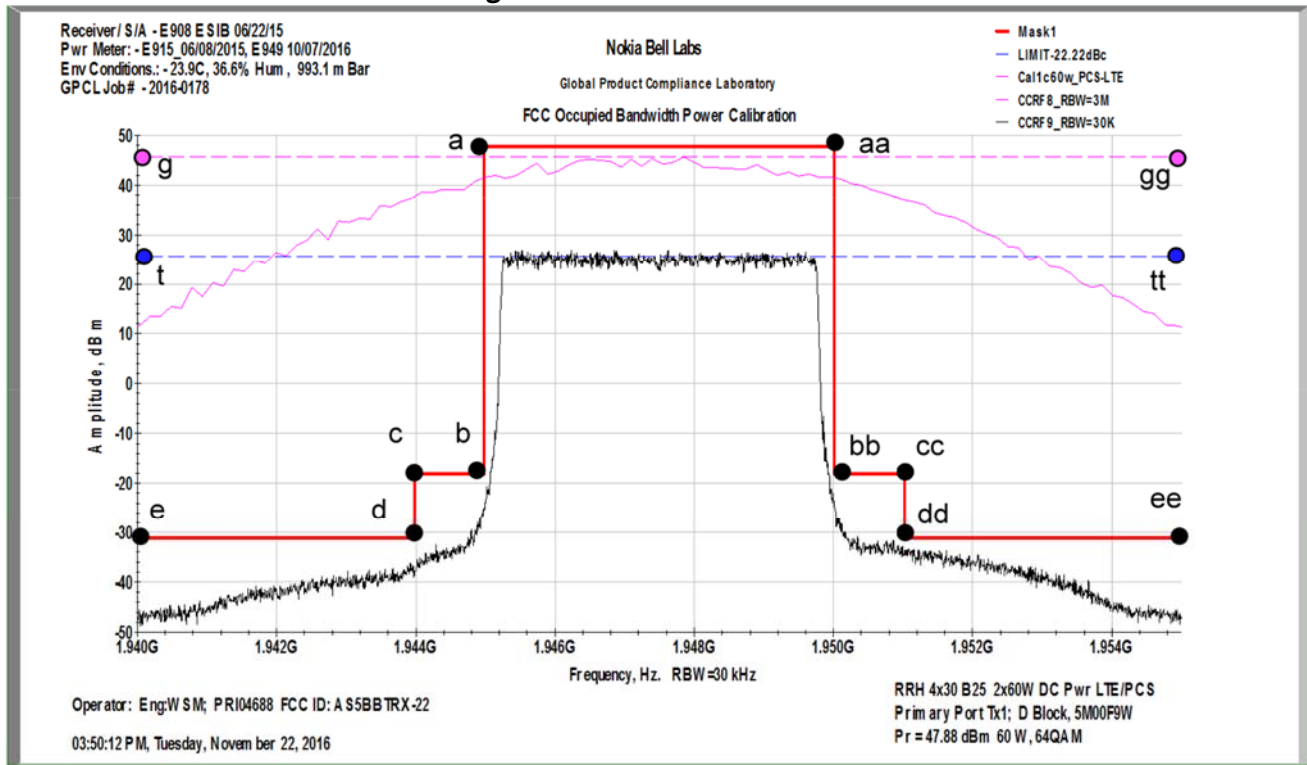

Occupied Bandwidth-Edge of Block Emissions Measurements

The occupied bandwidth and out-of-band emissions measurements were made at the antenna transmitting terminal for QPSK, 16QAM and 64QAM modulations, respectively. The appropriate E-UTRA test model specified in 3GPP TS 36.141 was used for LTE carriers.

The measurements were performed with a spectrum analyzer and in compliance with the procedure and requirements of ANSI C63.26. The test set-up diagram is same as the one shown in the Figure 4.3.1.

Testing was performed for the combined QPSK+16QAM and for the 64QAM modulations, respectively. The total carrier power level at the antenna terminal was adjusted to the maximum rated mean power 47.8 dBm (60W) for 2xMIMO configurations.

Results Occupied Bandwidth-Edge of Block Emissions

The occupied bandwidth plots for operation in all PCS Block are below. The mask accurately depicts the limits for the specific blocks to determine compliance with FCC Part 24.238. The mask limits include the appropriate considerations for 4x30W or 2x60W MIMO operation. Where individual Block plots display two traces, then one trace is for the QPSK+16QAM and the second trace is for the 64QAM modulation respectively.

From the out-of-band emissions plots attached below, it can be seen that all the emissions are under the required FCC emission masks for MIMO operation.

The measurement results of the occupied bandwidth and the out-of-band emissions as documented in the plots and Table 4.3.2.4 demonstrate the full compliance with the Rules of the Commission for the operating band.

Table 4.3.2.4 Compliance Tabulation of Occupied Bandwidth-Edge of Block Measurements

Test #	PCS Blocks	Port	Signal Bandwidth, MHz	Modulation Q16=qpsk+16qam 64=64QAM	Total per Port Power, Watts	Occupied Bandwidth / Edge of Block Results Pass / Fail		
						Left Carrier	Right Carrier	Middle Carrier
1	A+CG	Tx1	5+10	QPSK+16QAM	30	Pass	Pass	-
2	A+CG	Tx1	5+10	64QAM	30	Pass	Pass	-
3	A+CG	Tx3	10+10	Q16, 64QAM	30	Pass	Pass	-
4	A+B	Tx3	10+10	64QAM, Q16	30	Pass	Pass	-
5	A+CG	Tx3	15+10	64QAM	30	Pass	Pass	-
6	A+CG	Tx3	10+15	64QAM	30	Pass	Pass	-
7	A+E+G	Tx3	10+5+5	64QAM	30	Pass	Pass	Pass
8	A+E+G	Tx3	5+5+5	QPSK+16QAM	30	Pass	Pass	Pass
9	A+E+G	Tx3	5+5+5	64QAM	30	Pass	Pass	Pass
10	A+D+CG	Tx4	5+5+15	Q16, Q16, 64QAM	30	Pass	Pass	Pass
11	A+B+CG	Tx4	5+10+15	64QAM	30	Pass	Pass	Pass
12	A+B+CG	Tx4	10+10+10	64QAM	30	Pass	Pass	Pass
13	A+B+G	Tx4	10+10+5	64, 64, Q16	30	Pass	Pass	Pass
14	A+B+CG	Tx1	5+5+15	Q16, Q16, 64QAM	60	Pass	Pass	Pass
15	A+B+CG	Tx1	5+10+15	64QAM	60	Pass	Pass	Pass
16	A+B+CG	Tx2	10+10+10	64QAM	60	Pass	Pass	Pass
17	A+B+G	Tx2	10+10+5	QPSK+16QAM	60	Pass	Pass	Pass
18	A+B+G	Tx2	10+10+5	64QAM	60	Pass	Pass	Pass

Figure 4.3.2 Test Set-Up for Measurement of Occupied Bandwidth and Out-of-Band Emissions

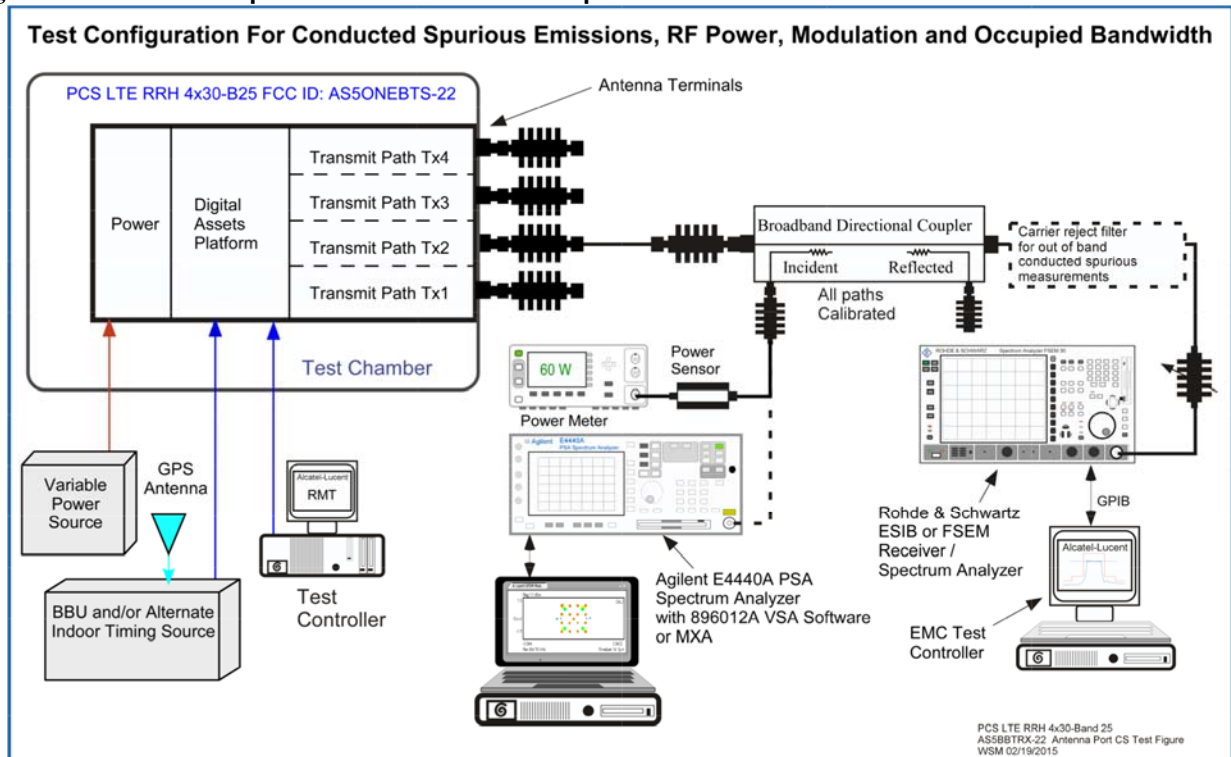

**Transmitter Measurements
of
Occupied Bandwidth
and
Edge of Band Emissions
for
Alcatel-Lucent USA Inc.**

**PCS LTE RRH 4x30 Band 25
Outdoor Transceiver System
FCC ID: AS5BBTRX-22**

Test Configuration 1

FCC Occupied Bandwidth Whole Band View Test Configuration 1

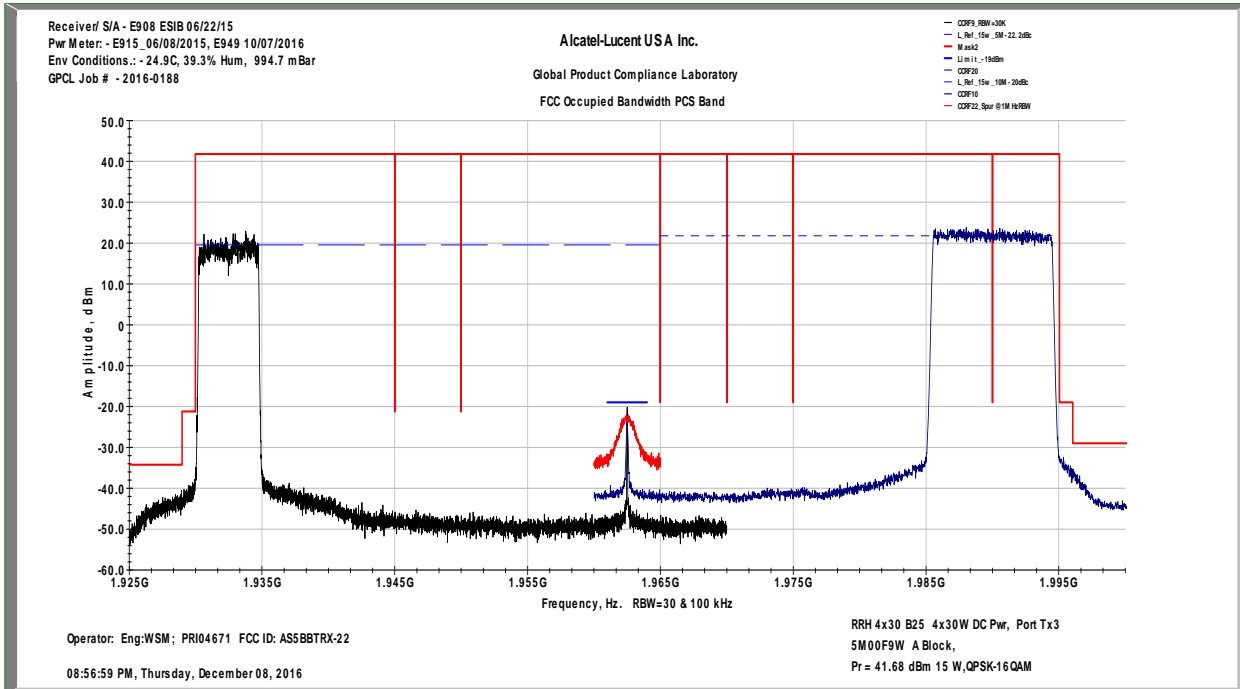

FCC Occupied Bandwidth / Power Calibration Test Configuration 1 Carrier Left

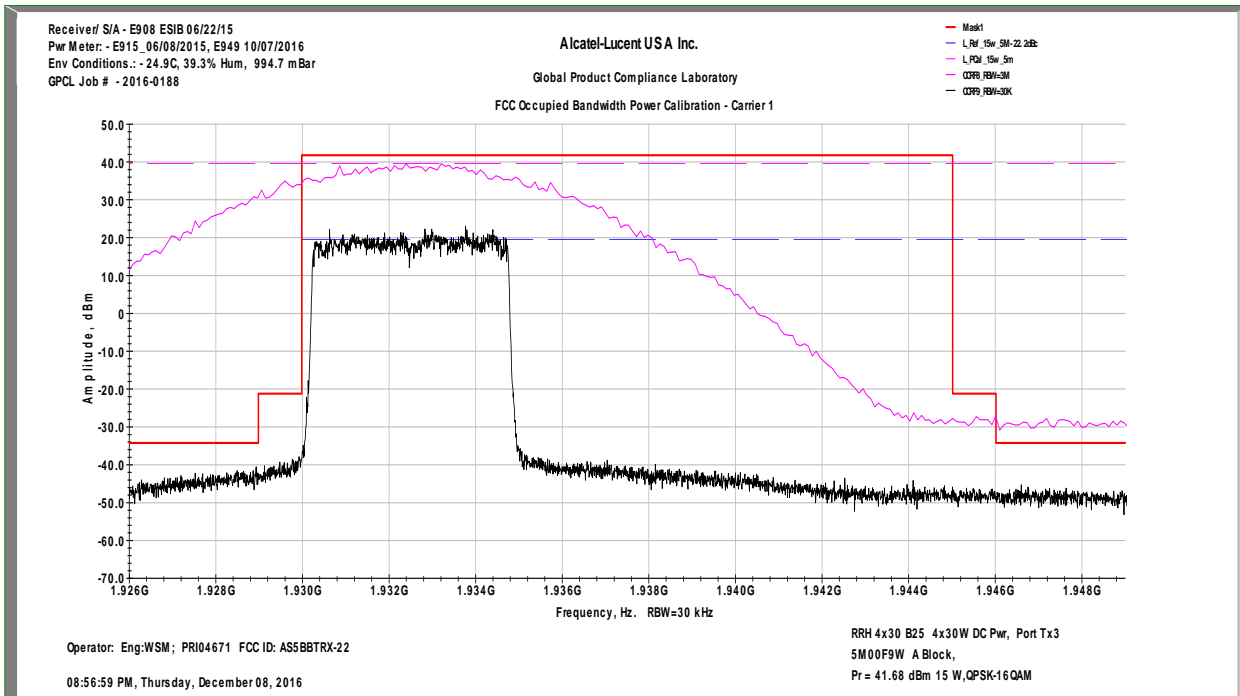

FCC Occupied Bandwidth / Power Calibration

Test Configuration 1 Carrier Right

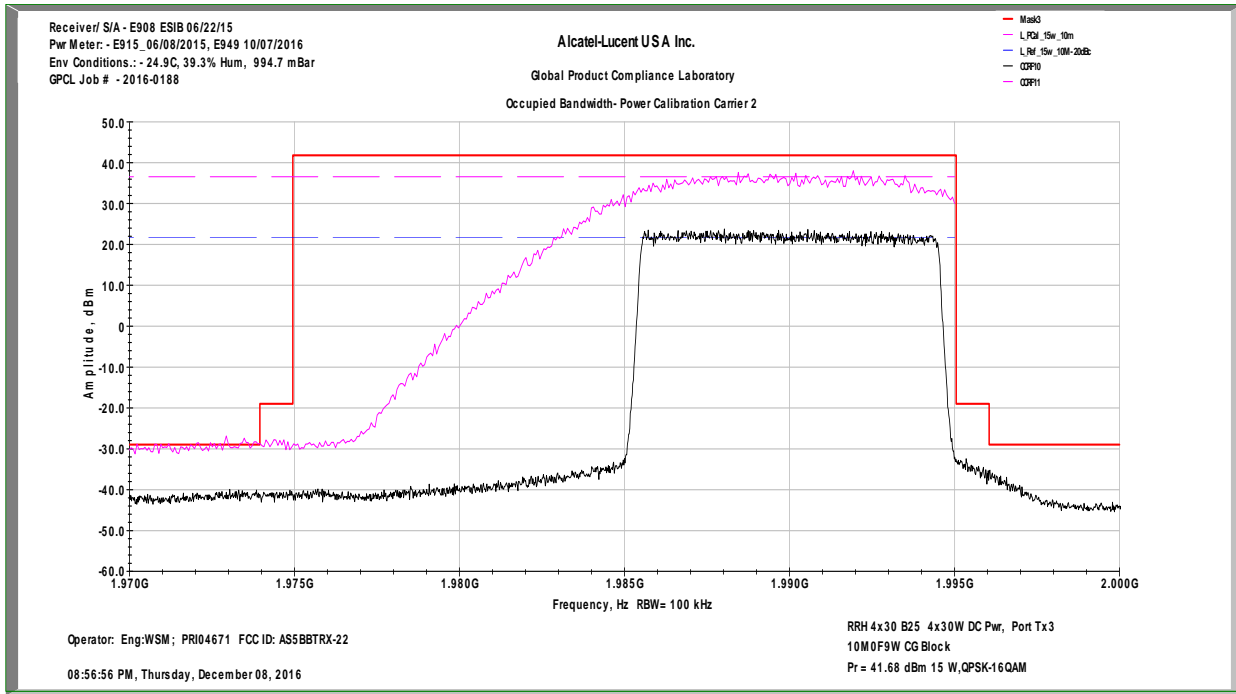

Test Configuration 2

FCC Occupied Bandwidth

Whole Band View

Test Configuration 2

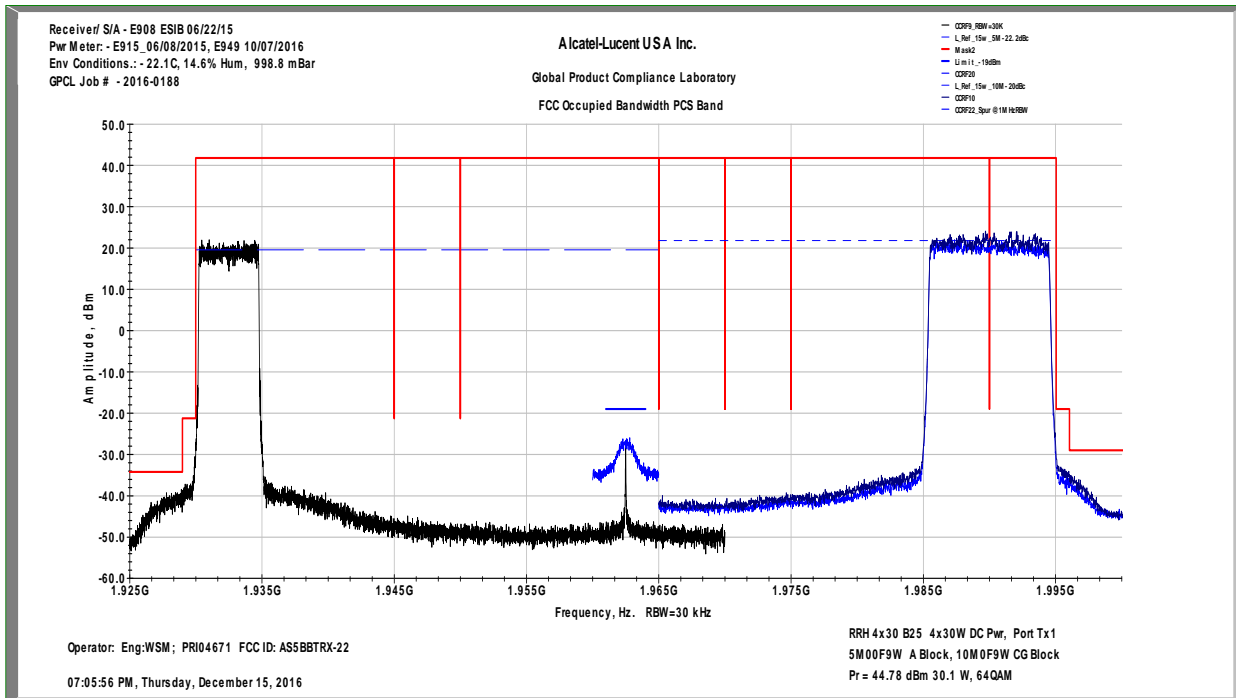

FCC Occupied Bandwidth / Power Calibration

Test Configuration 2 Carrier Left

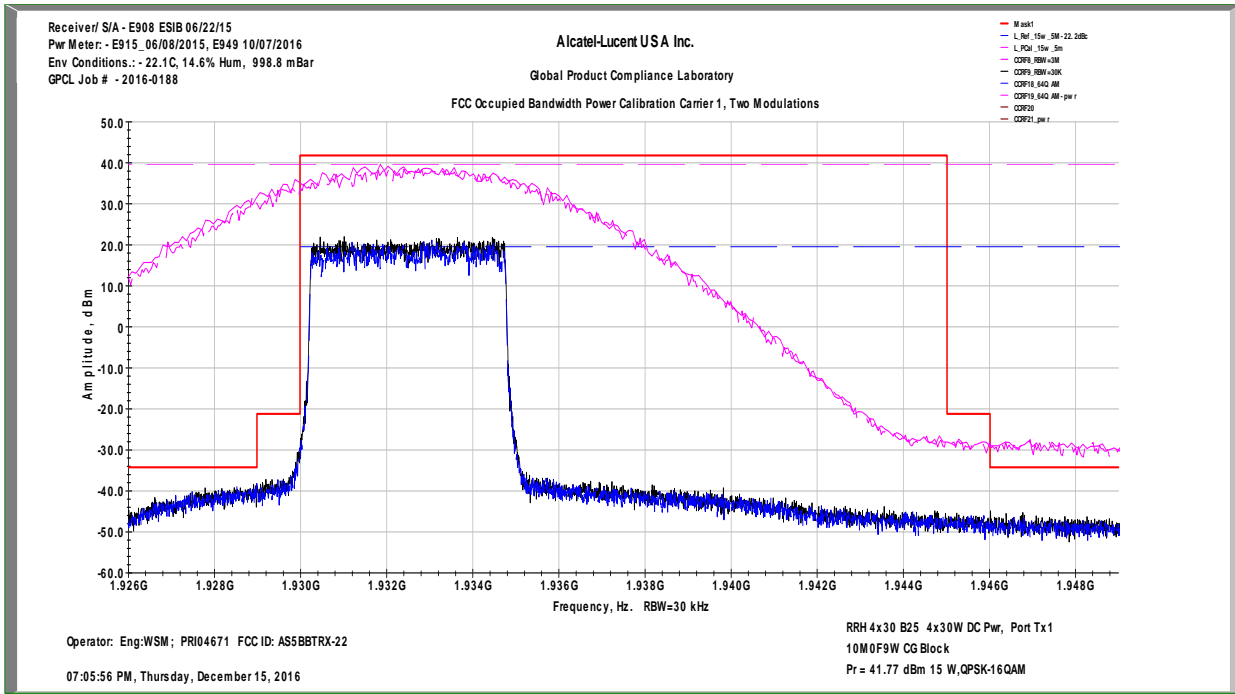

FCC Occupied Bandwidth / Power Calibration

Test Configuration 2 Carrier Right

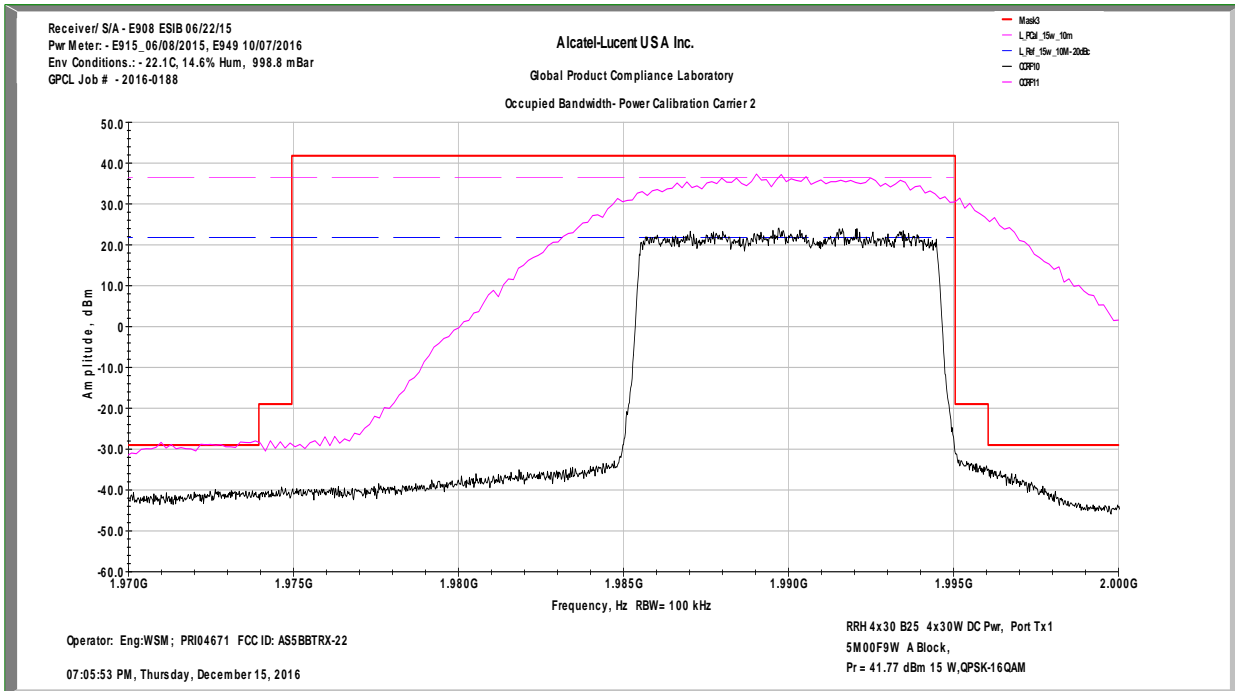

Test Configuration 3

FCC Occupied Bandwidth Whole Band View Test Configuration 3

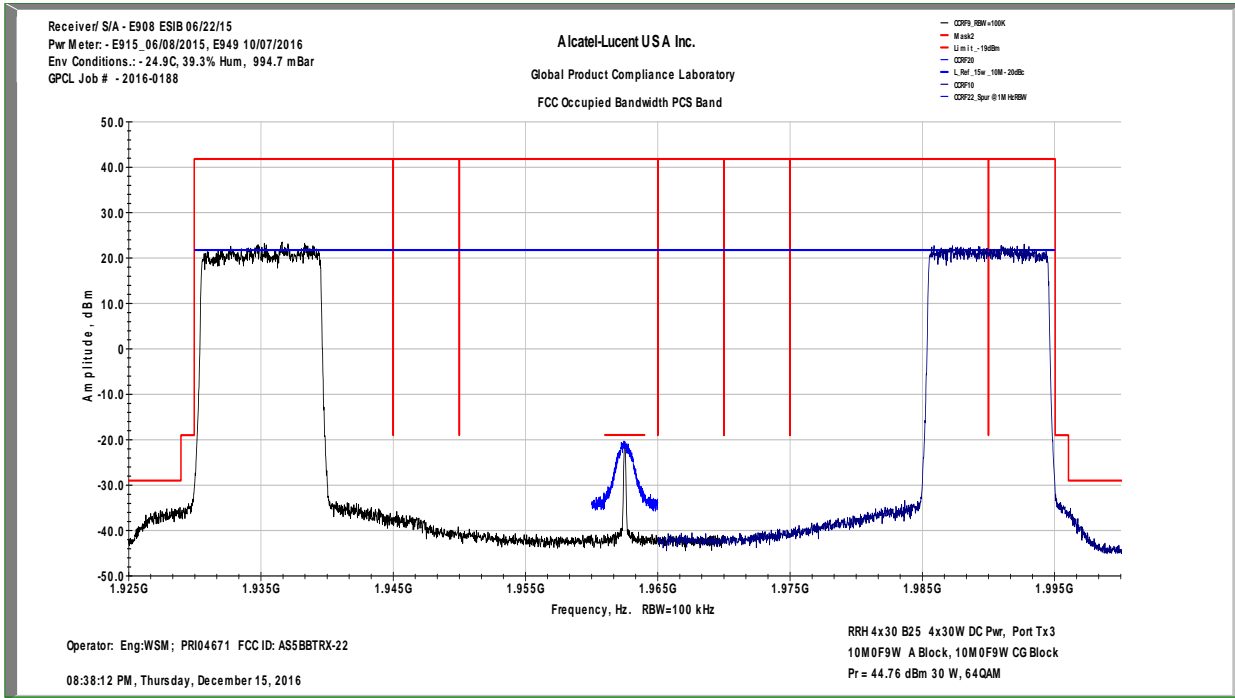

FCC Occupied Bandwidth / Power Calibration Test Configuration 3 Carrier Left

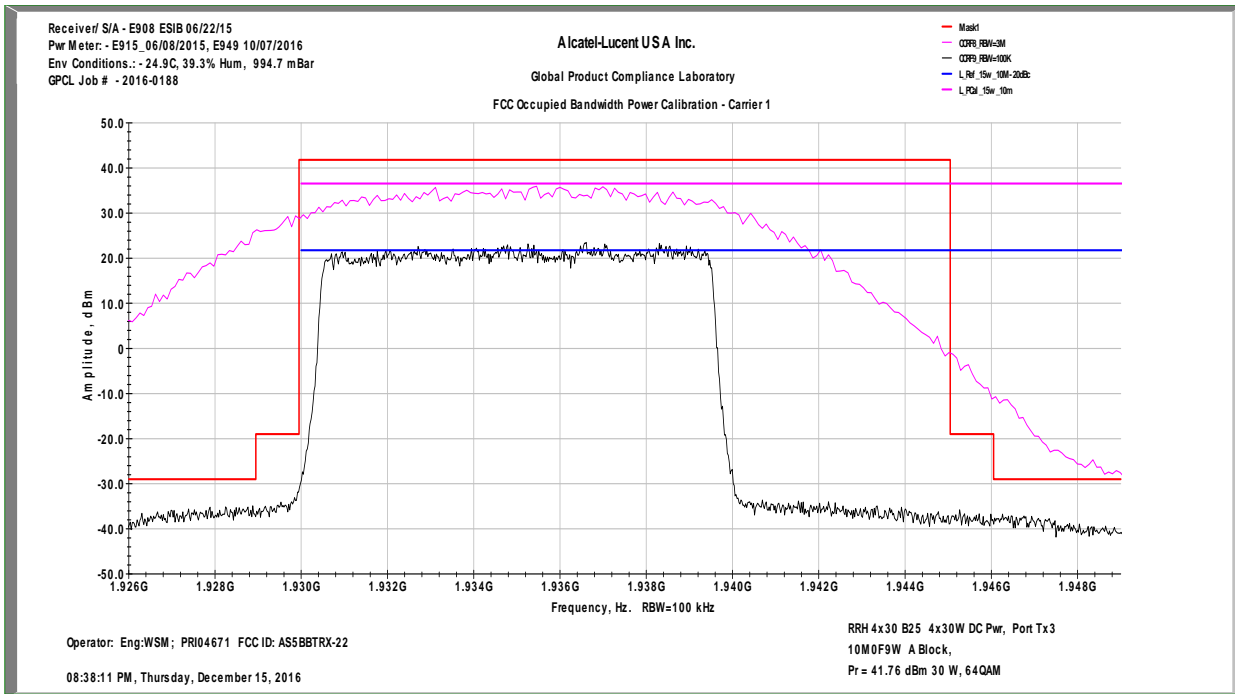

FCC Occupied Bandwidth / Power Calibration

Test Configuration 3 Carrier Right

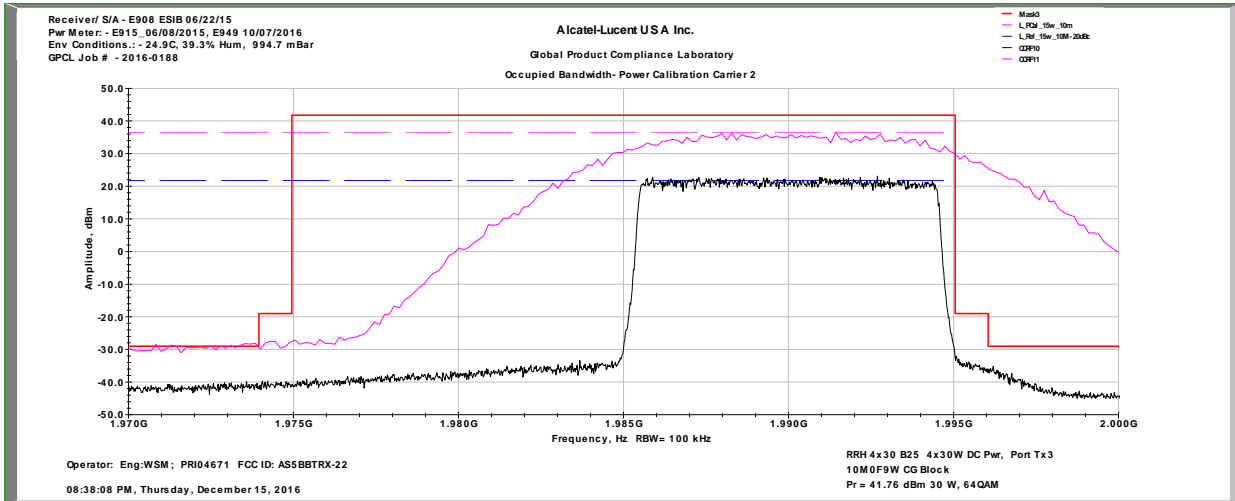

Test Configuration 4

FCC Occupied Bandwidth

Whole Band View

Test Configuration 4

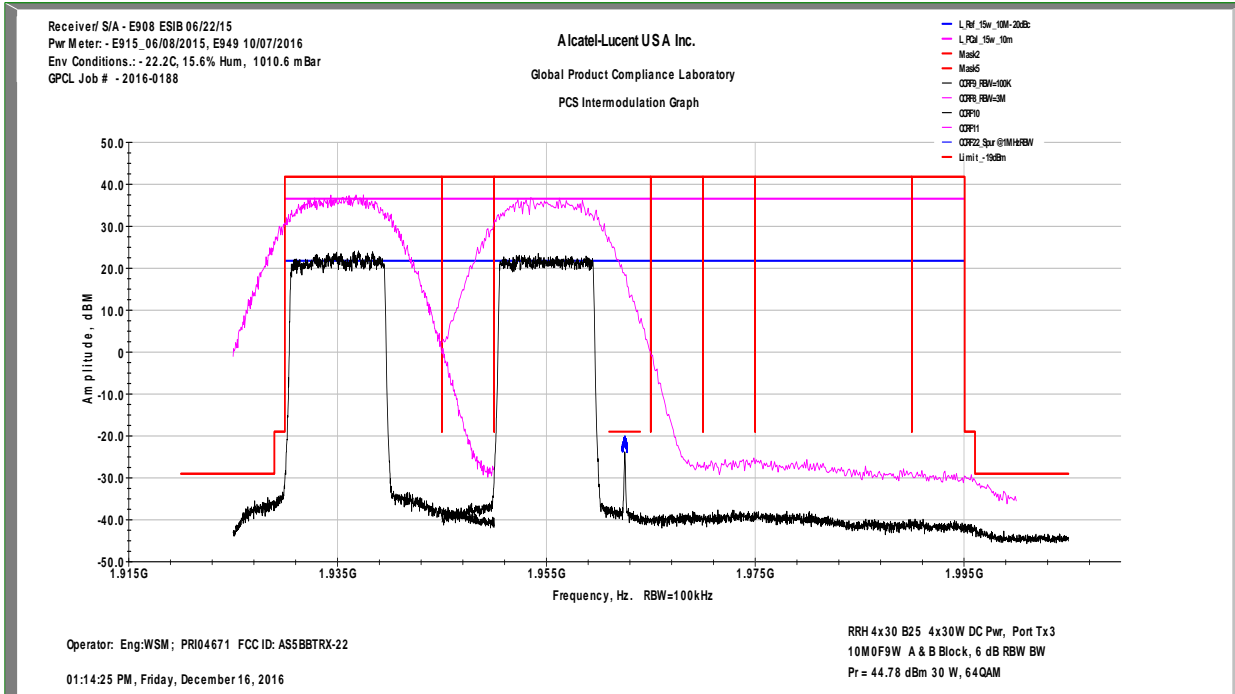

FCC Occupied Bandwidth / Power Calibration

Test Configuration 4 Carrier Left

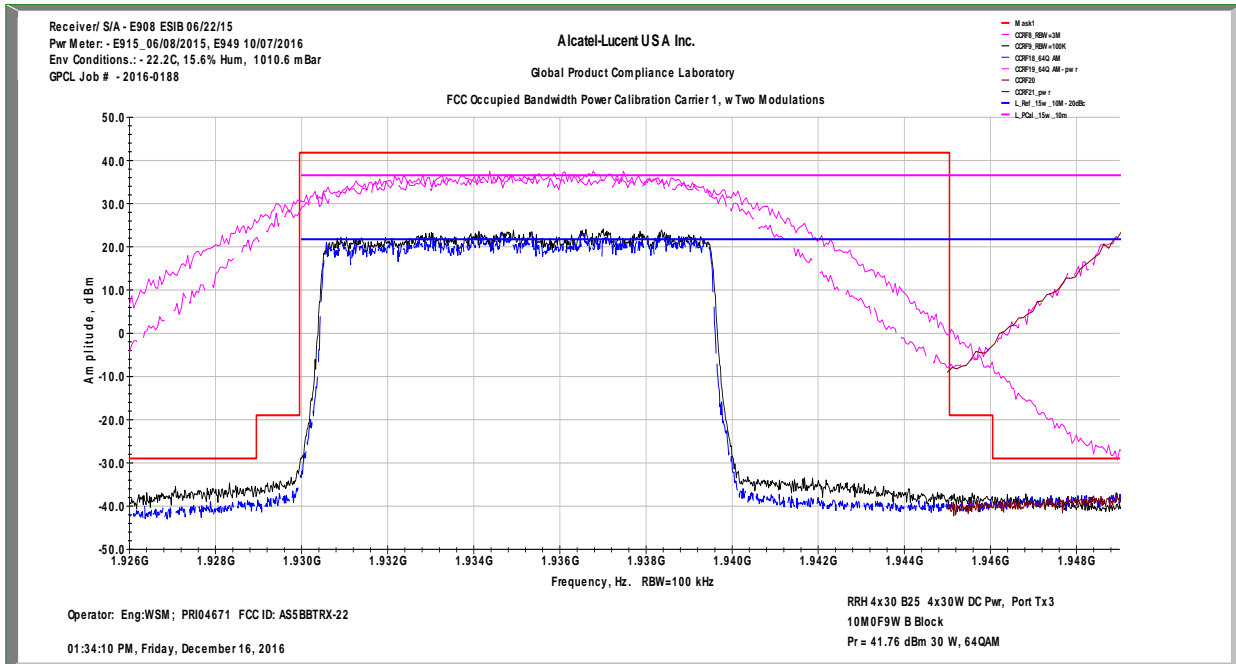

FCC Occupied Bandwidth / Power Calibration

Test Configuration 4 Carrier Right

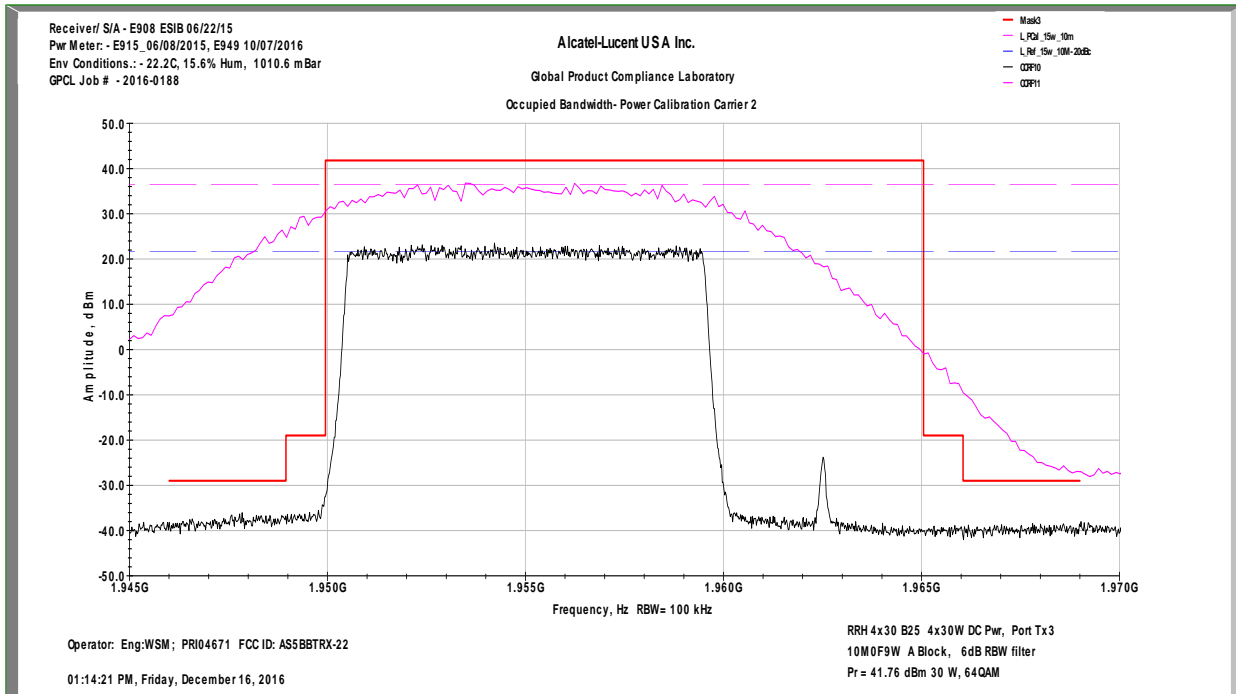

FCC Occupied Bandwidth / Power Calibration

Test Configuration 4 Carrier Middle

Test Configuration 5

FCC Occupied Bandwidth Whole Band View Test Configuration 5

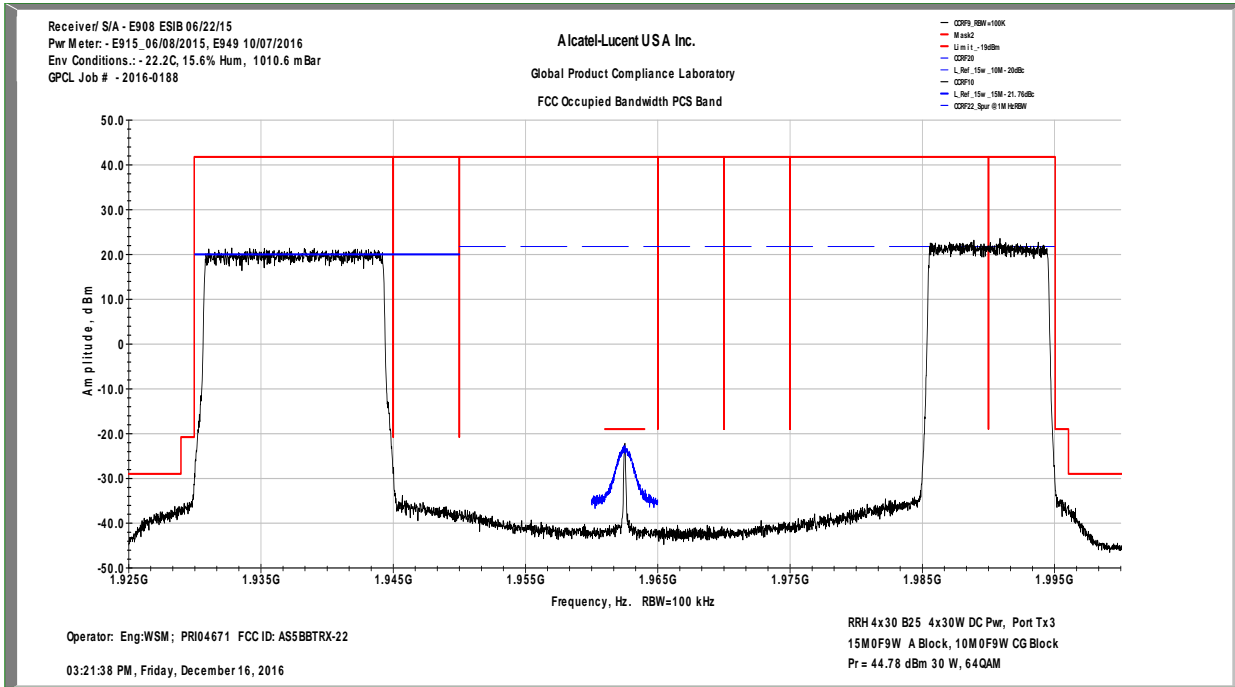

FCC Occupied Bandwidth / Power Calibration Test Configuration 5 Carrier Left

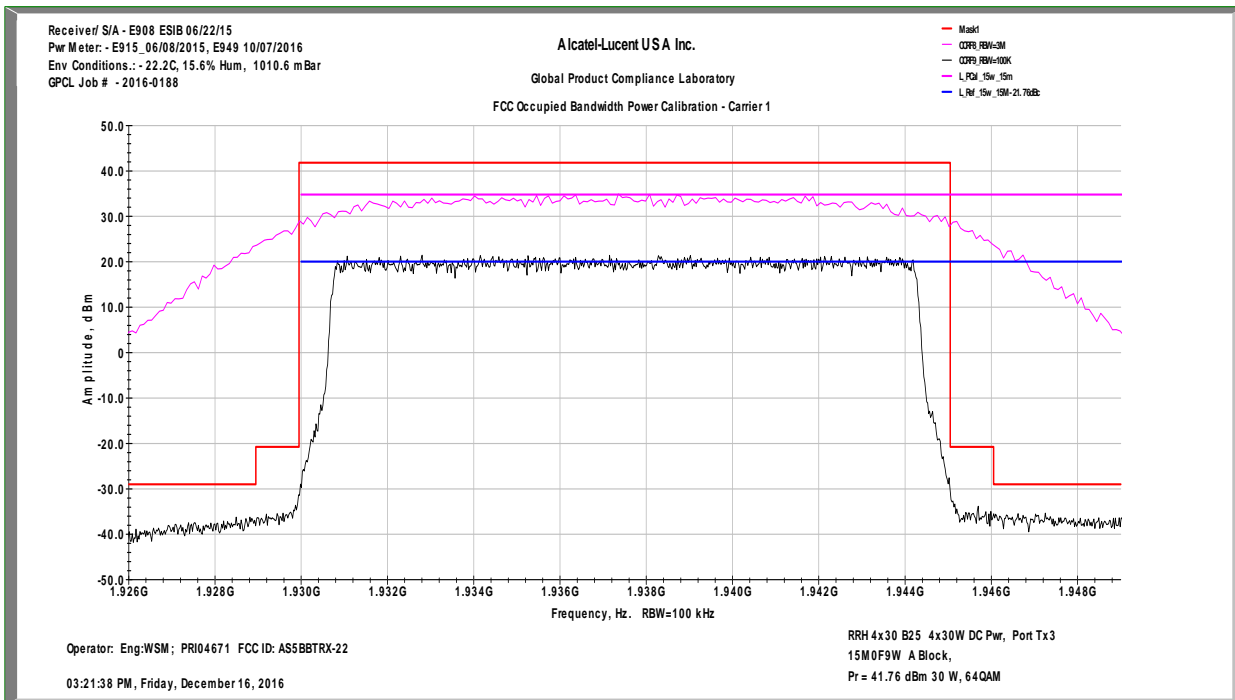

FCC Occupied Bandwidth / Power Calibration

Test Configuration 5 Carrier Right

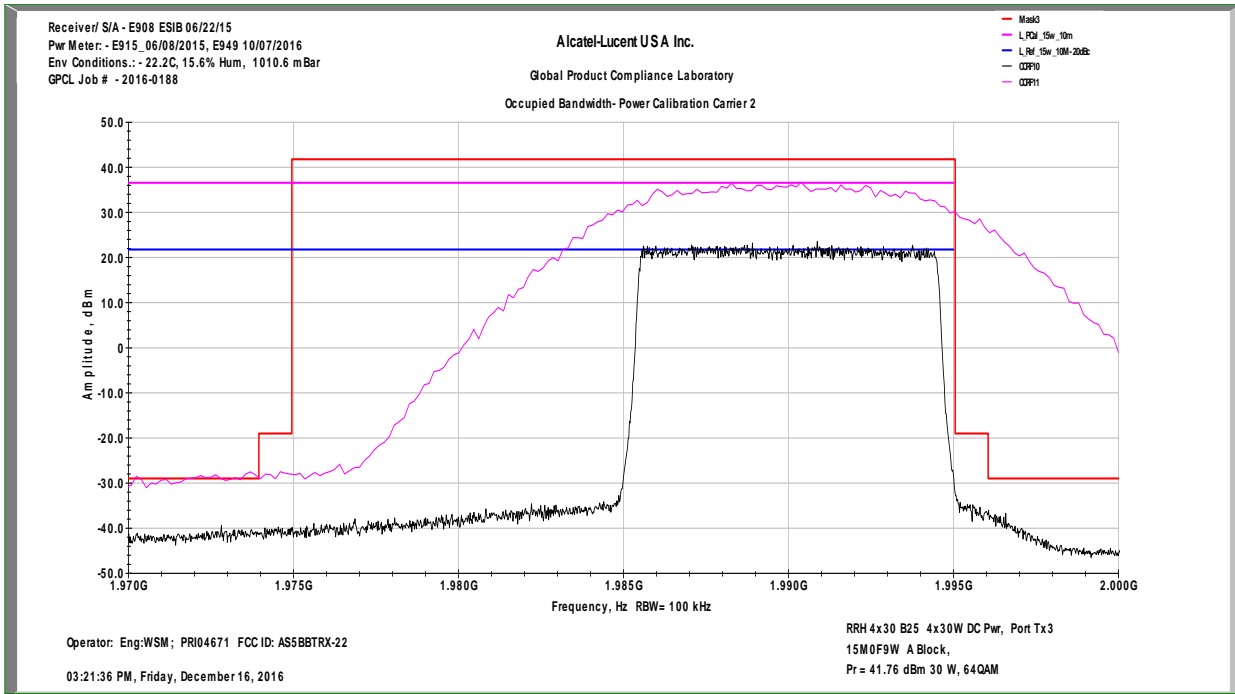

Test Configuration 6

FCC Occupied Bandwidth

Whole Band View

Test Configuration 6

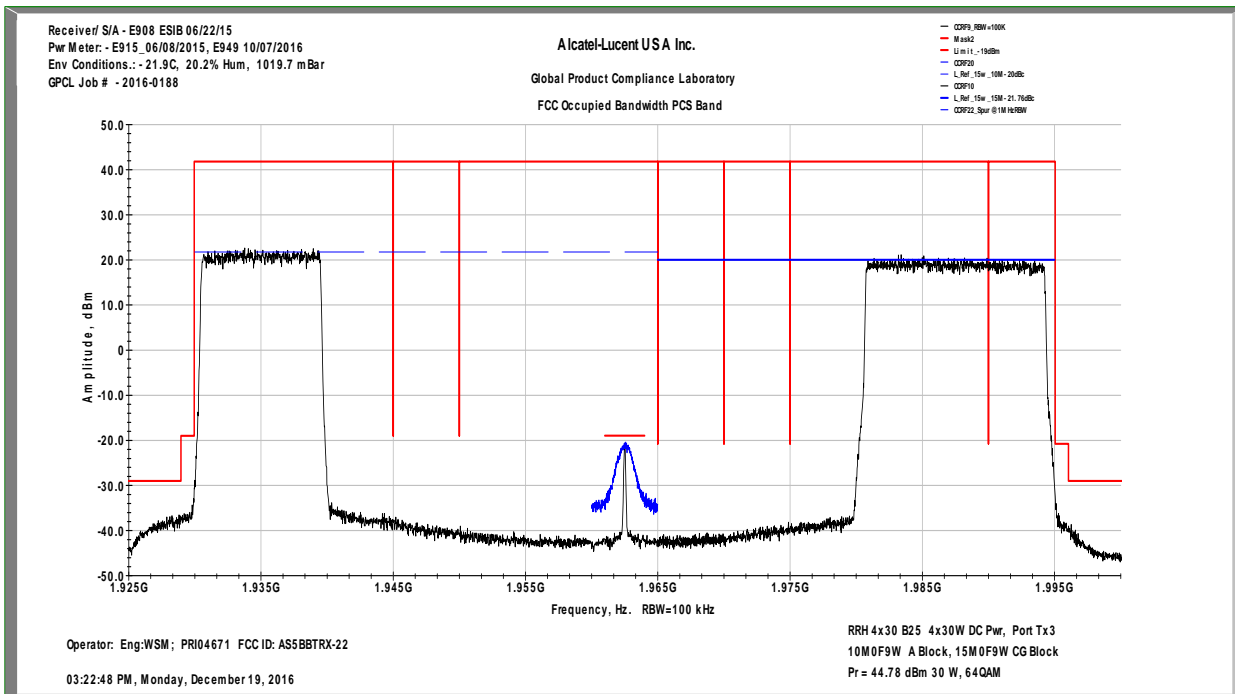

FCC Occupied Bandwidth / Power Calibration

Test Configuration 6 Carrier Left

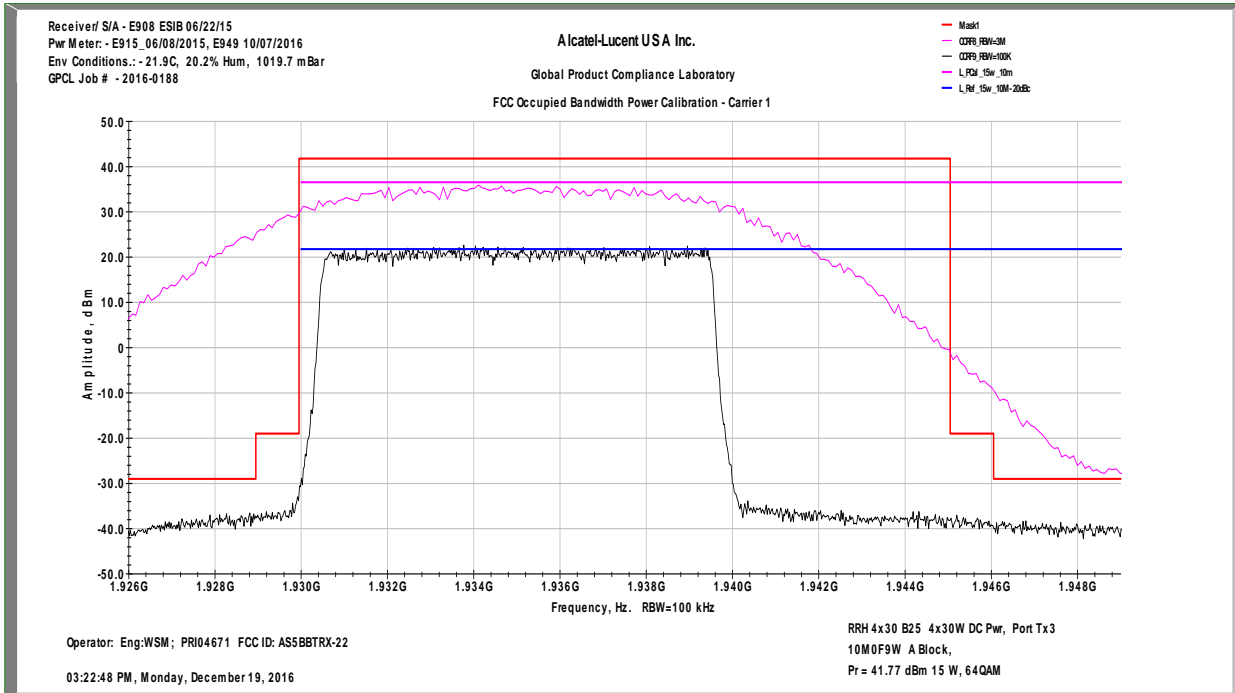

FCC Occupied Bandwidth / Power Calibration

Test Configuration 6 Carrier Right

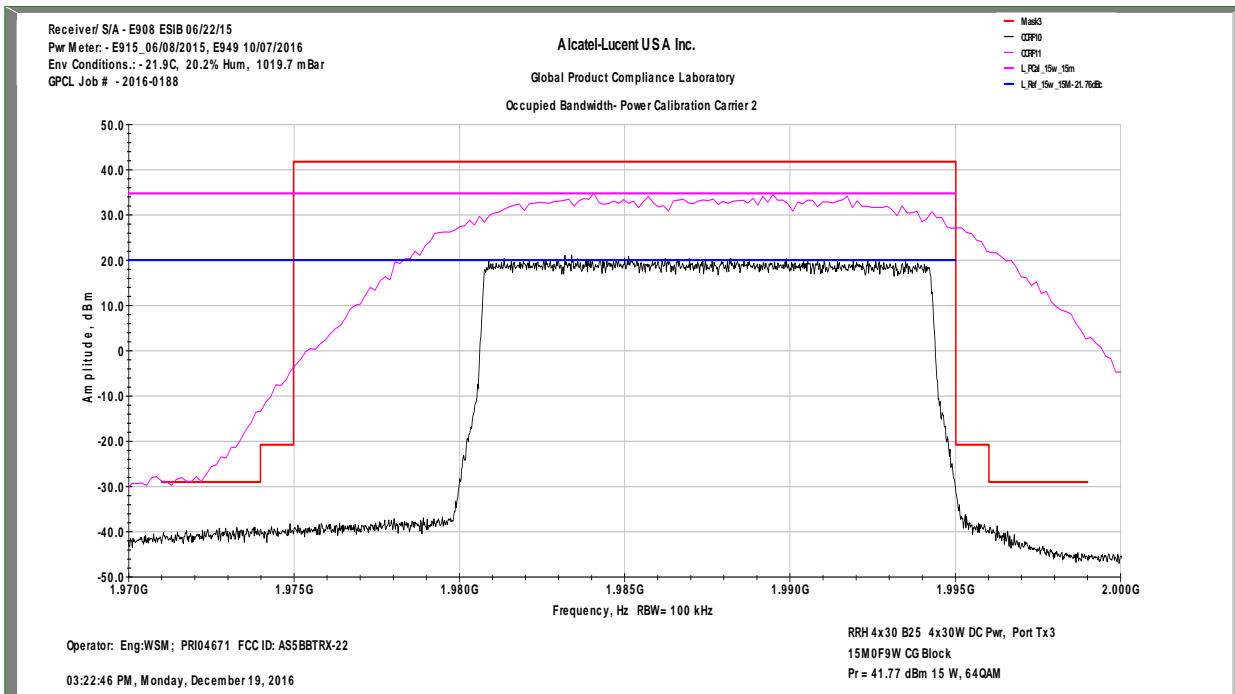

Test Configuration 7

FCC Occupied Bandwidth Whole Band View Test Configuration 7

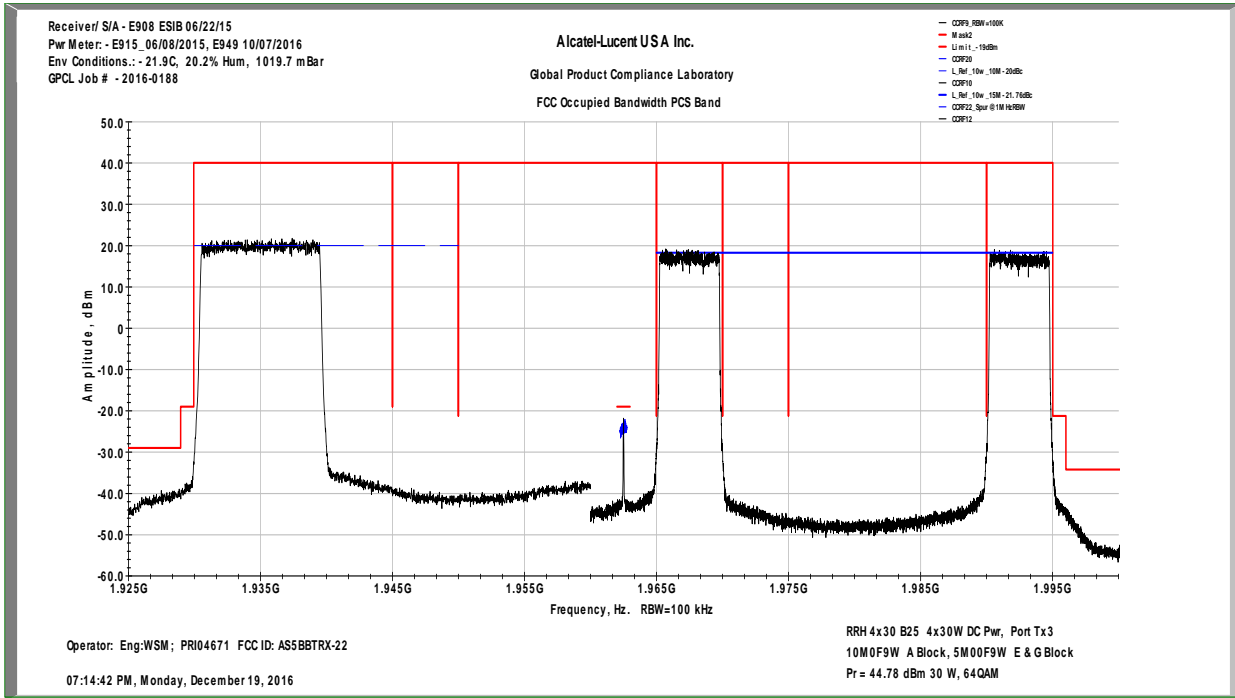

FCC Occupied Bandwidth / Power Calibration Test Configuration 7 Carrier Left

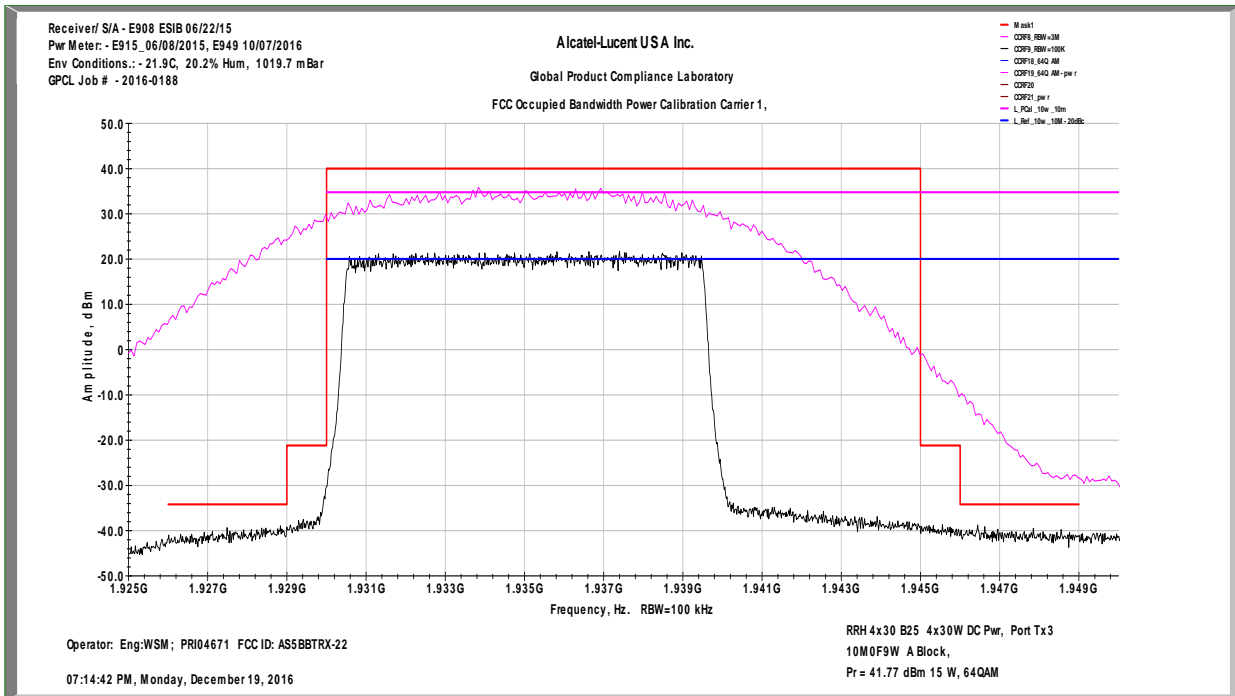

FCC Occupied Bandwidth / Power Calibration

Test Configuration 7 Carrier Right

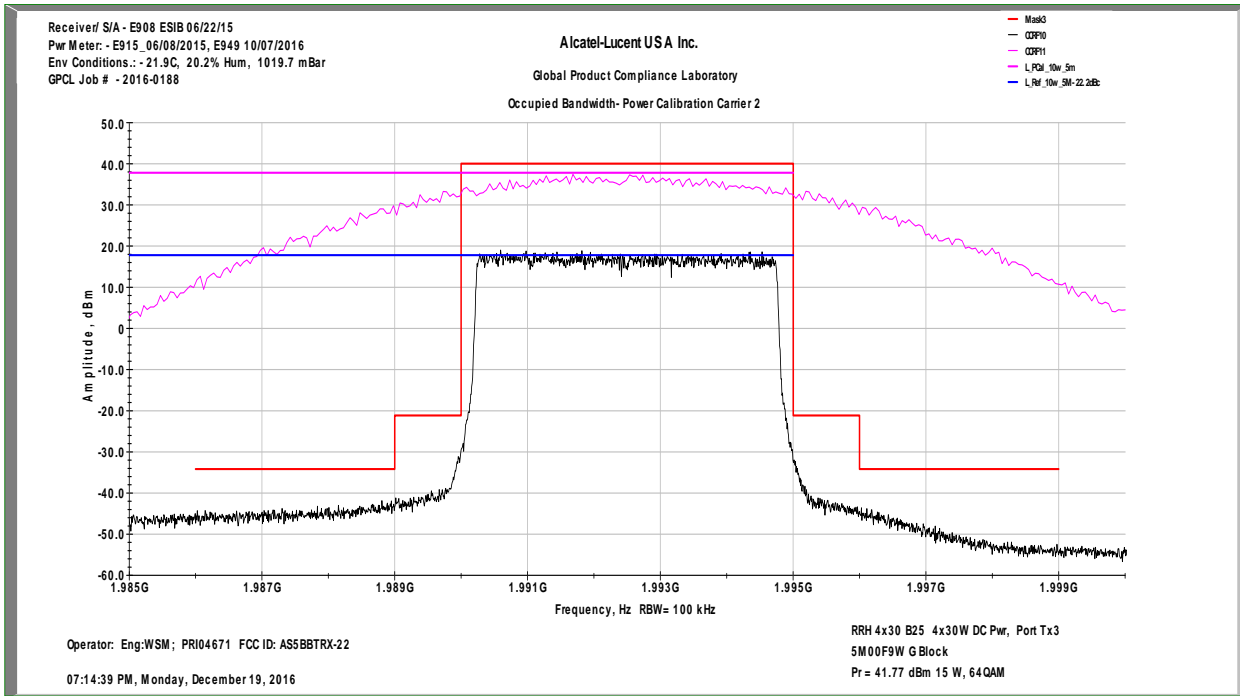

FCC Occupied Bandwidth / Power Calibration

Test Configuration 7 Carrier Middle

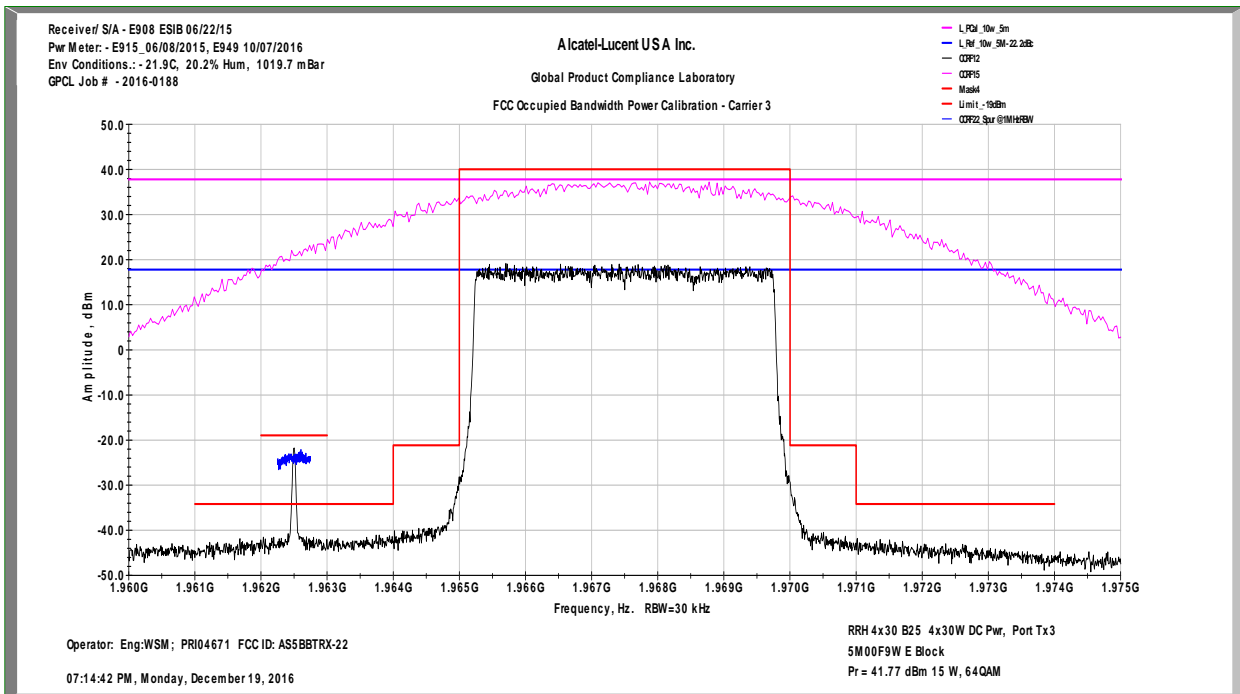

Test Configuration 8

FCC Occupied Bandwidth Whole Band View Test Configuration 8

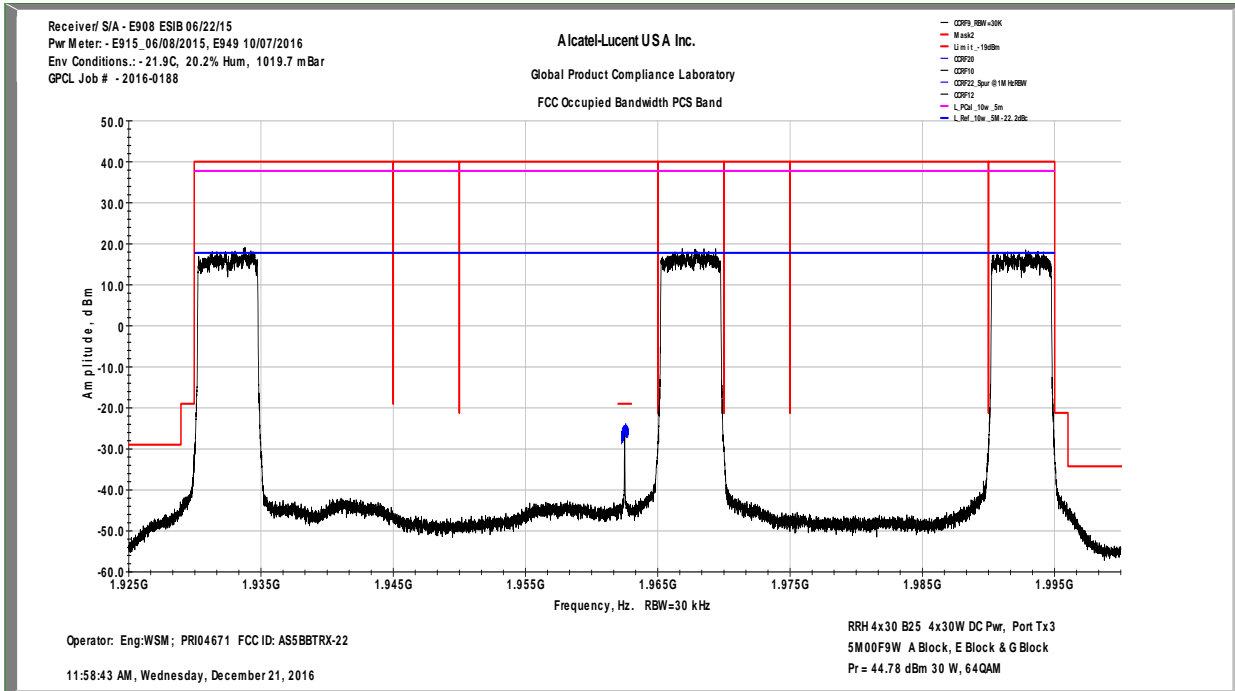

FCC Occupied Bandwidth / Power Calibration Test Configuration 8 Carrier Left

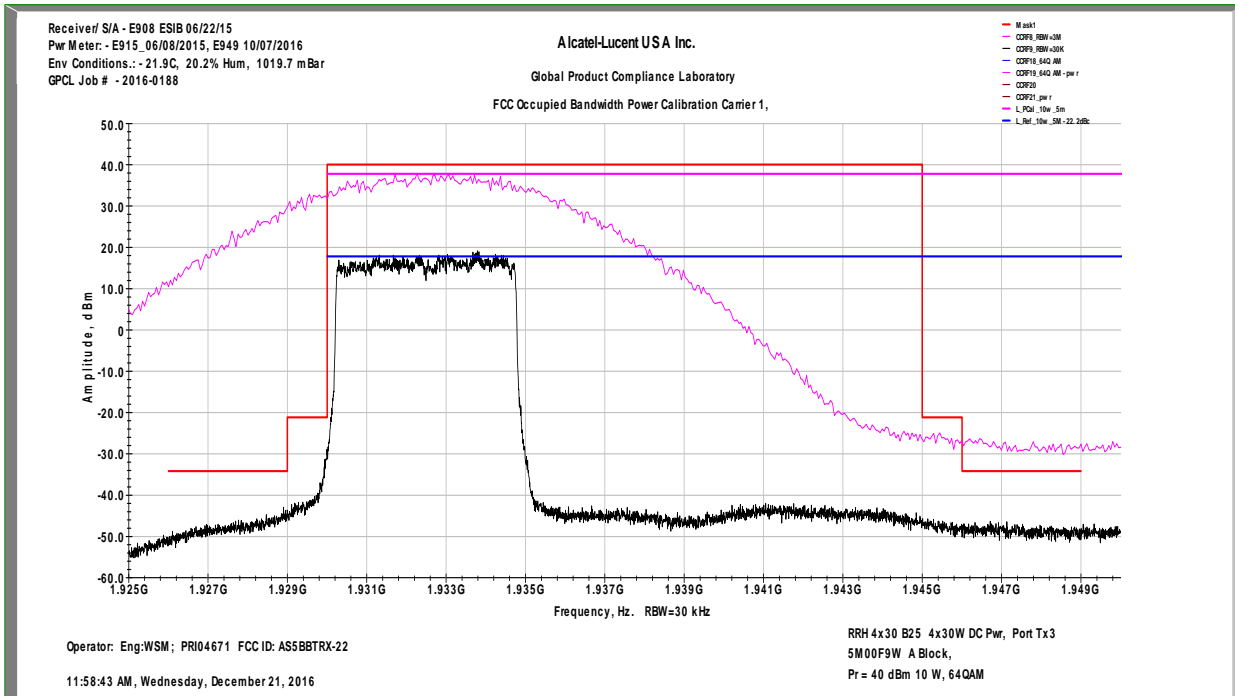

FCC Occupied Bandwidth / Power Calibration

Test Configuration 8 Carrier Right

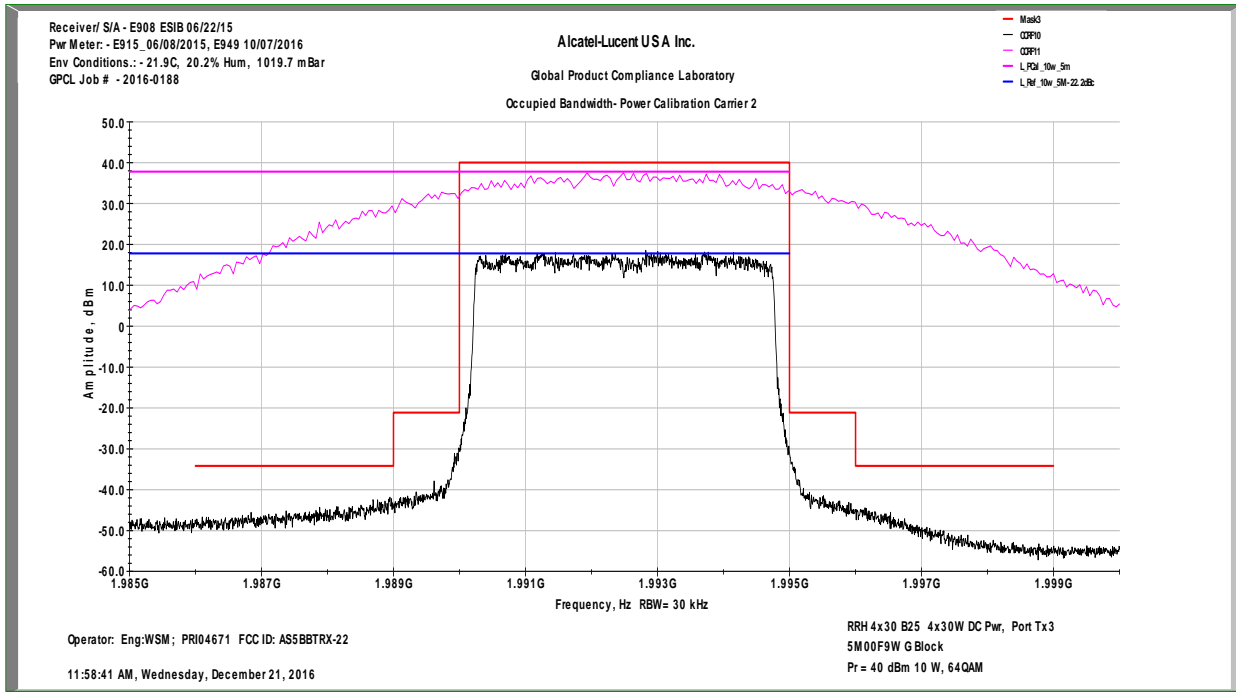

FCC Occupied Bandwidth / Power Calibration

Test Configuration 8 Carrier Middle

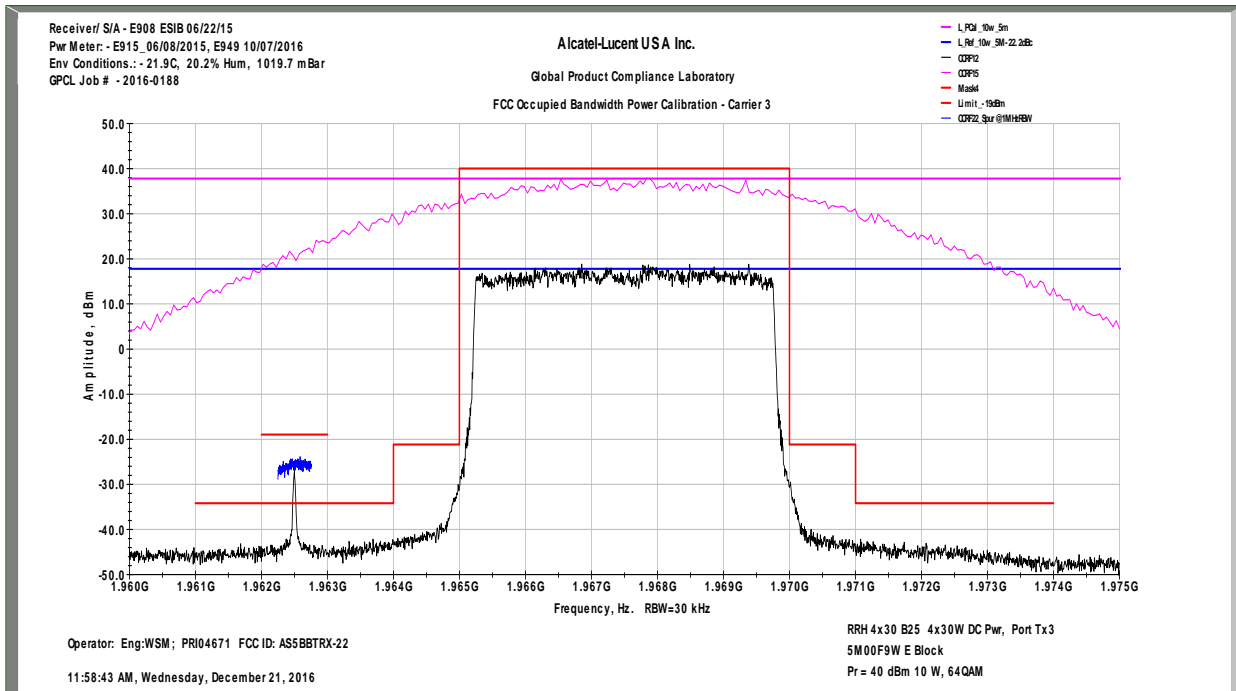

Test Configuration 9

FCC Occupied Bandwidth Whole Band View Test Configuration 9

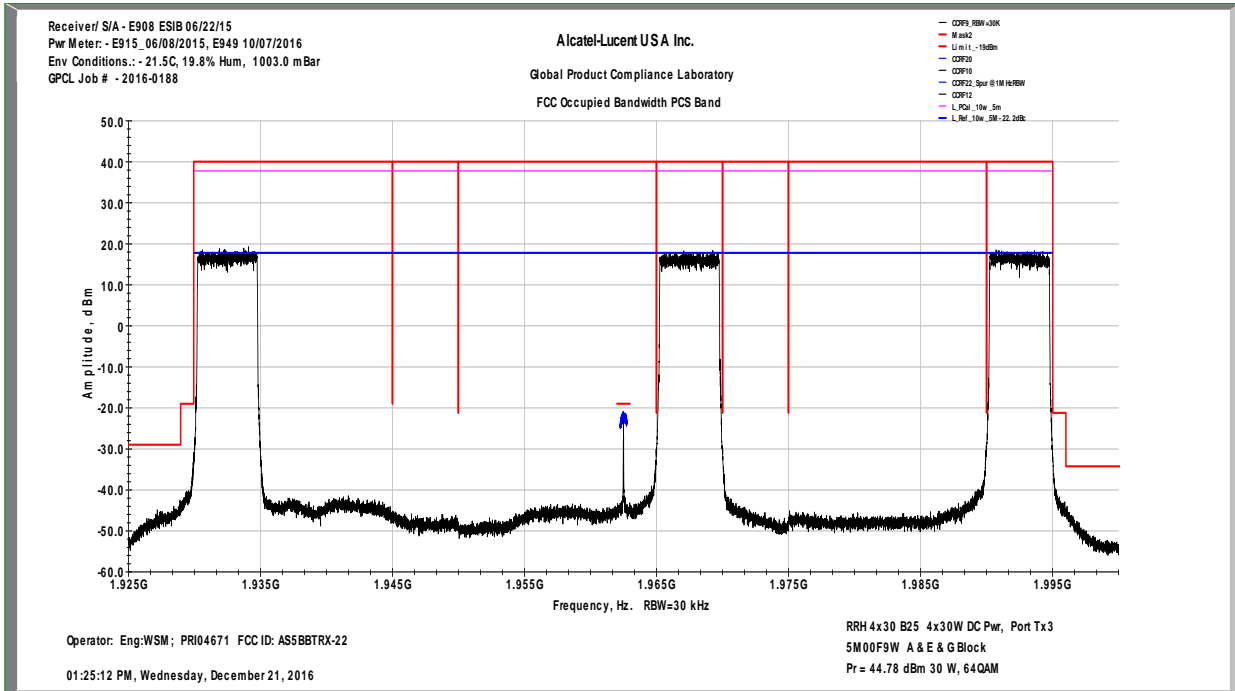

FCC Occupied Bandwidth / Power Calibration Test Configuration 9 Carrier Left

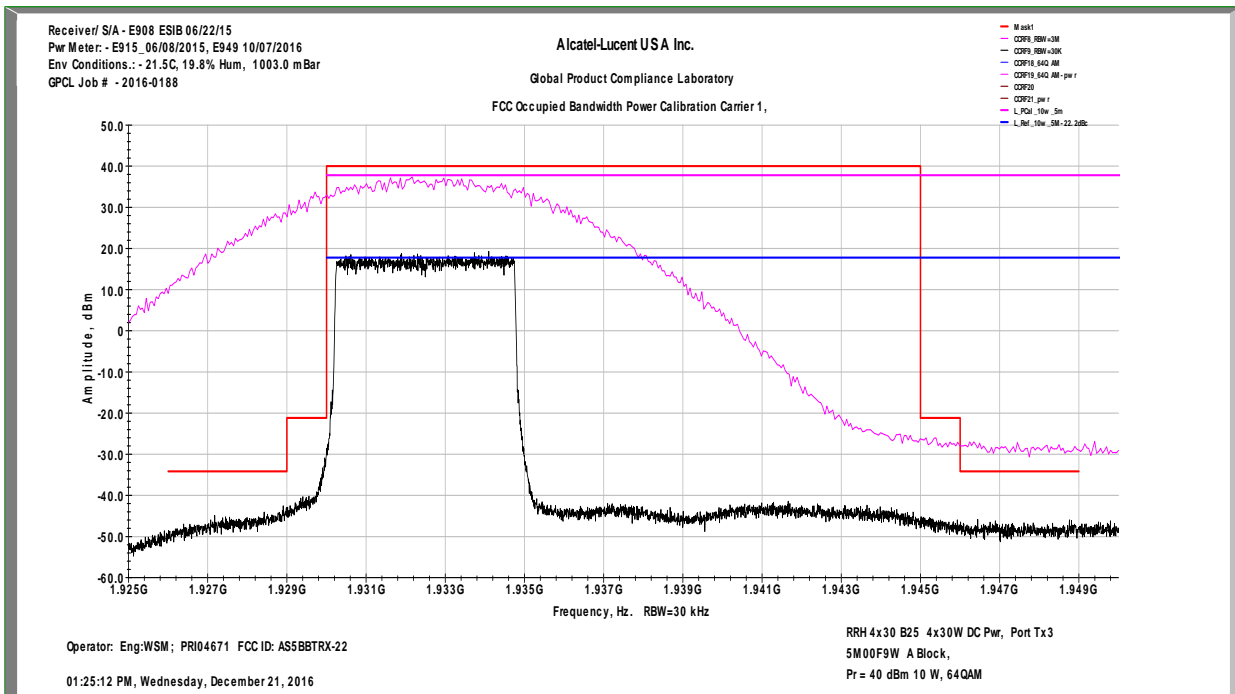

FCC Occupied Bandwidth / Power Calibration

Test Configuration 9 Carrier Right

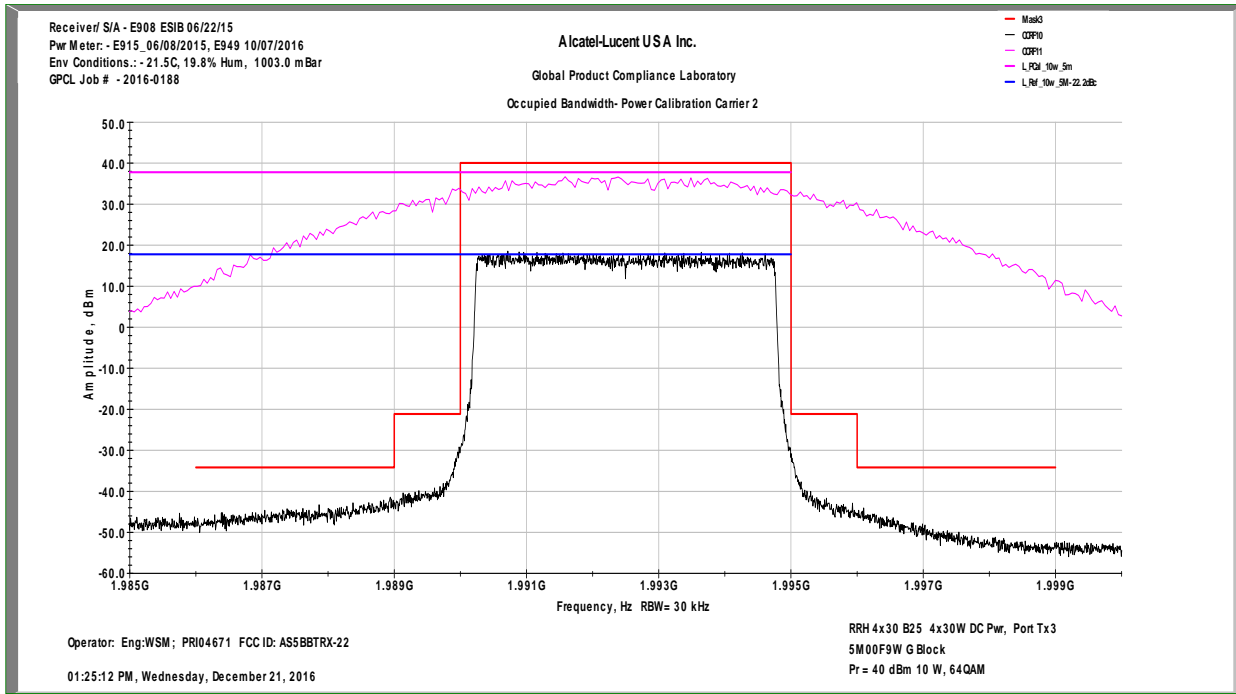

FCC Occupied Bandwidth / Power Calibration

Test Configuration 9 Carrier Middle

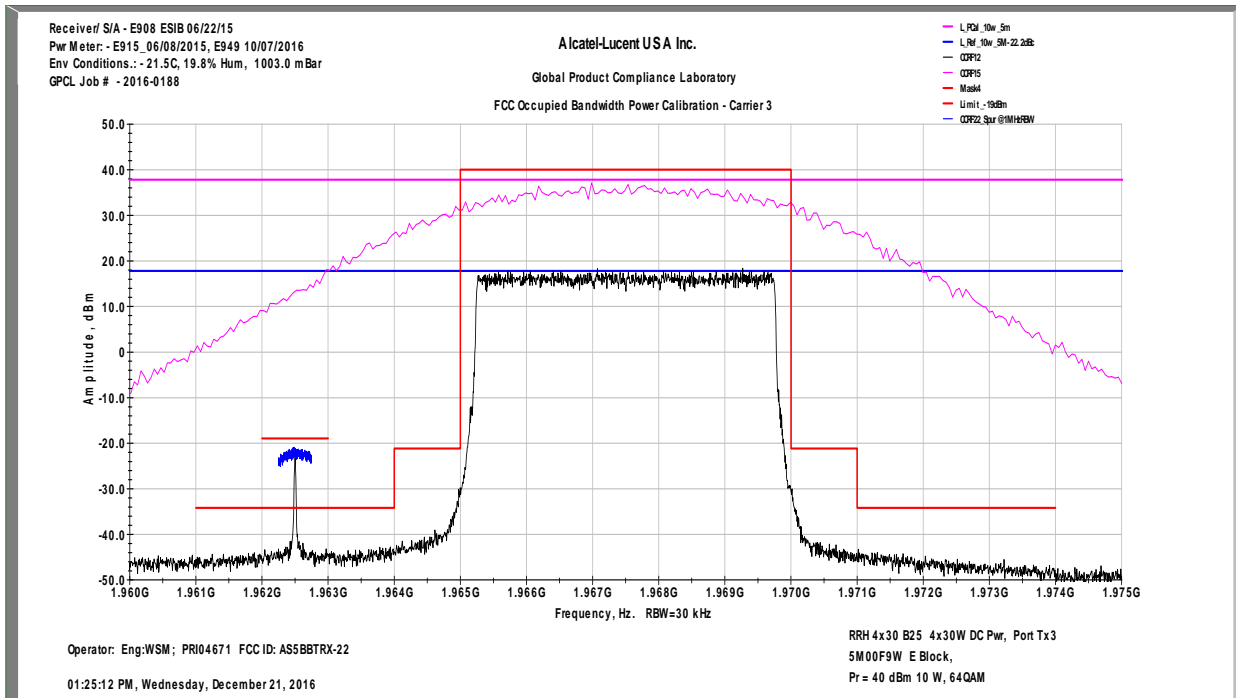

Test Configuration 10

FCC Occupied Bandwidth Whole Band View Test Configuration 10

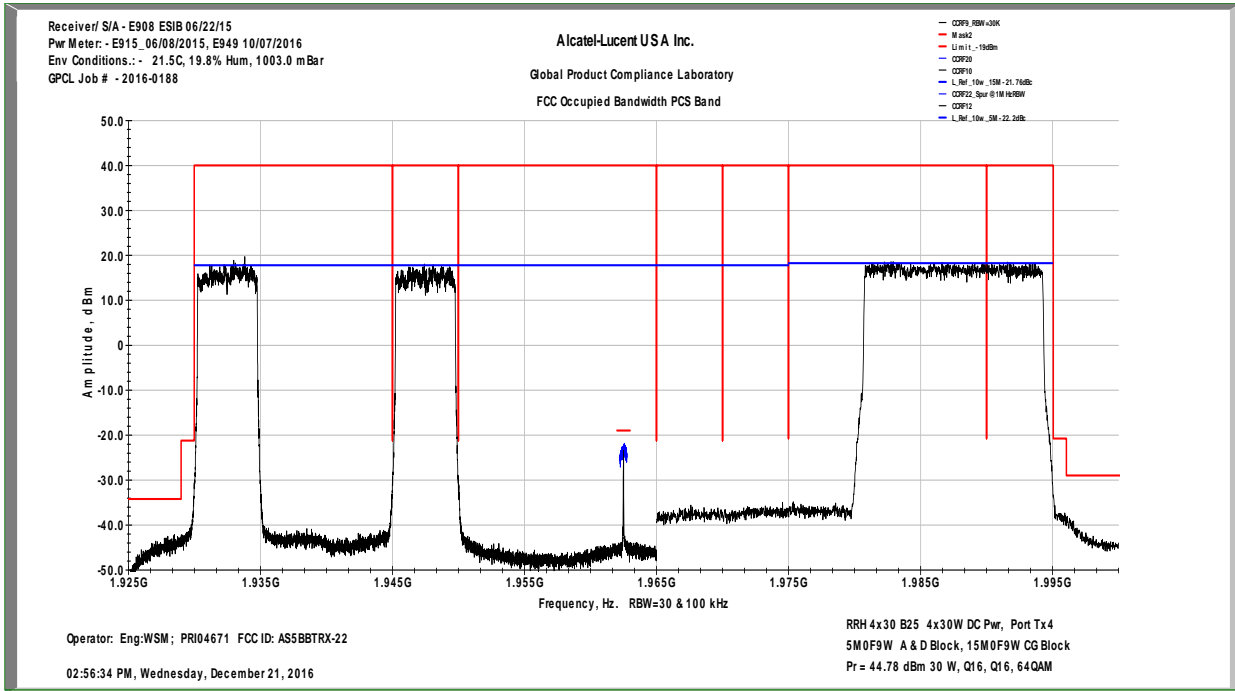

FCC Occupied Bandwidth / Power Calibration Test Configuration 10 Carrier Left

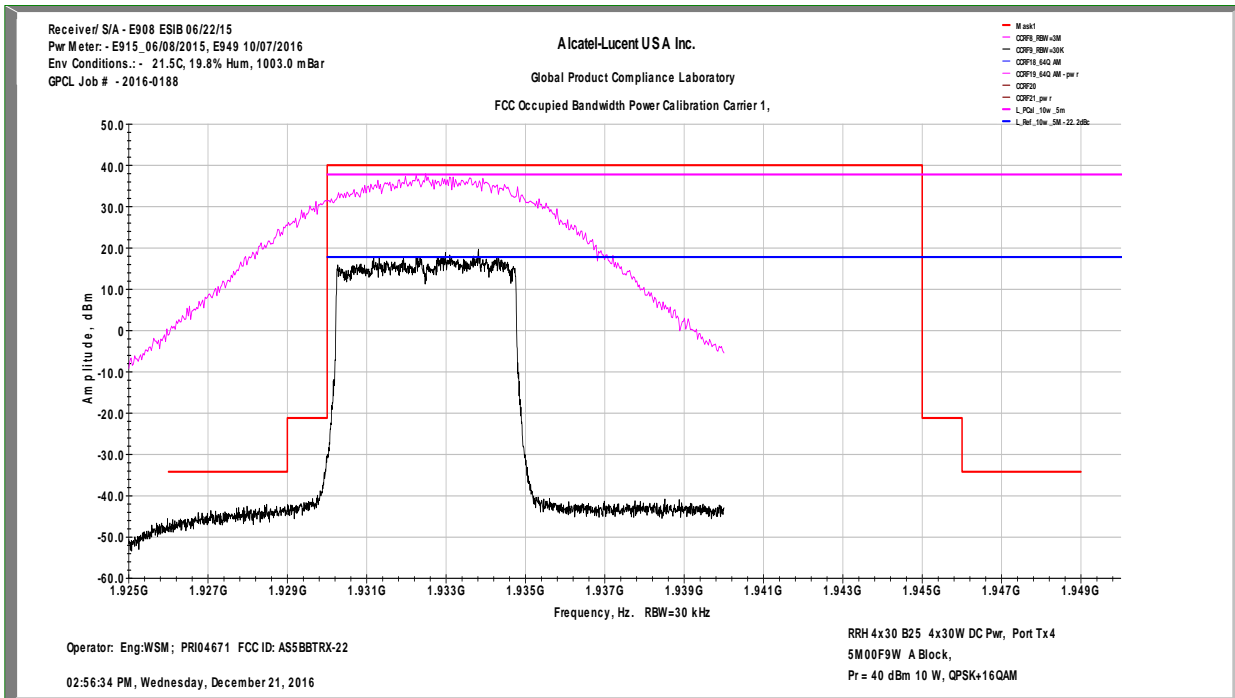

FCC Occupied Bandwidth / Power Calibration

Test Configuration 10 Carrier Right

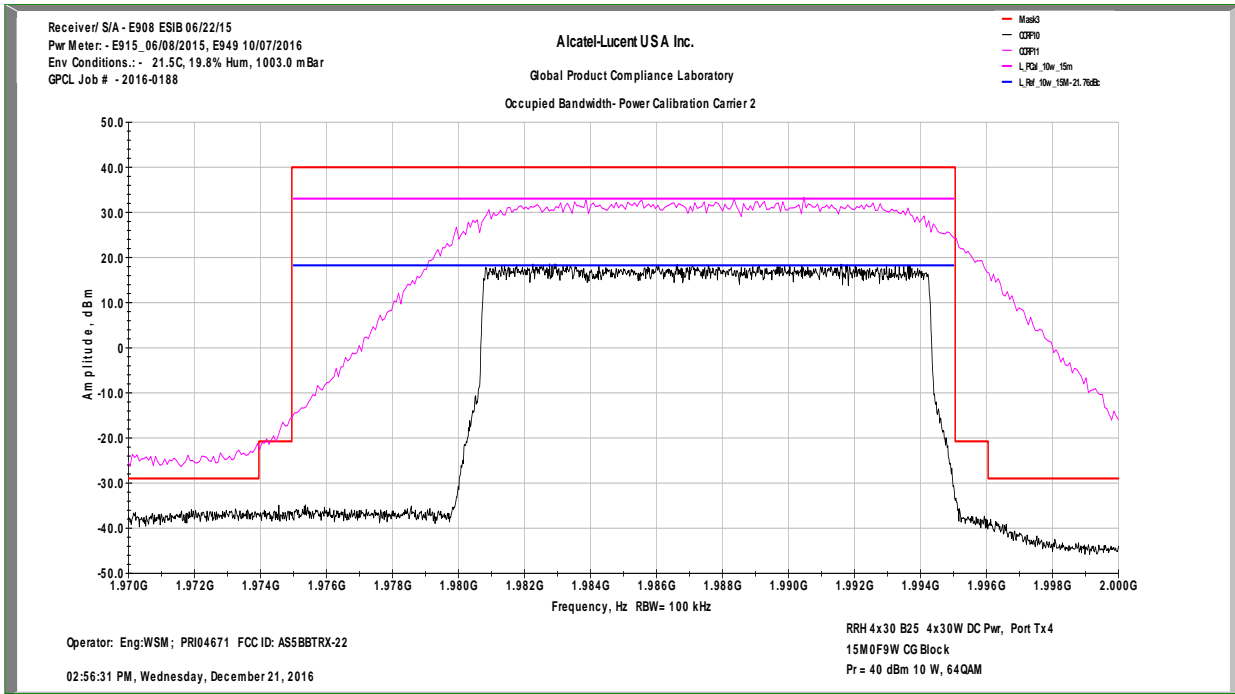

FCC Occupied Bandwidth / Power Calibration

Test Configuration 10 Carrier Middle

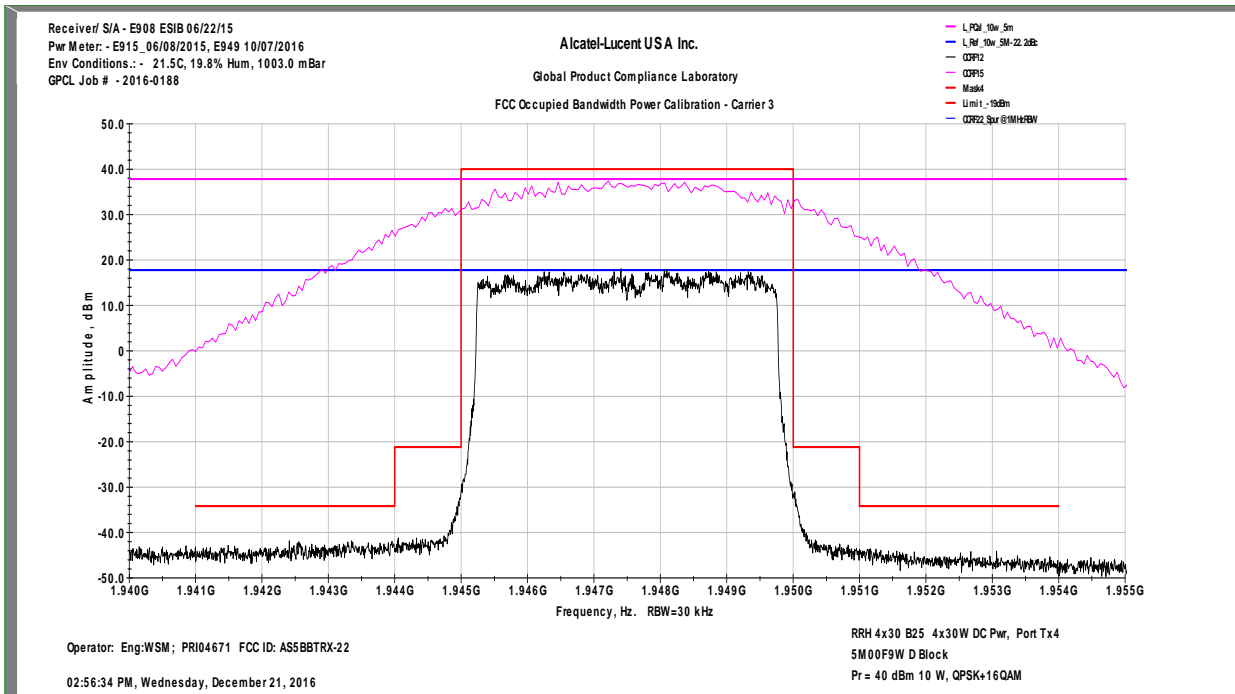

Test Configuration 11

FCC Occupied Bandwidth Whole Band View Test Configuration 11

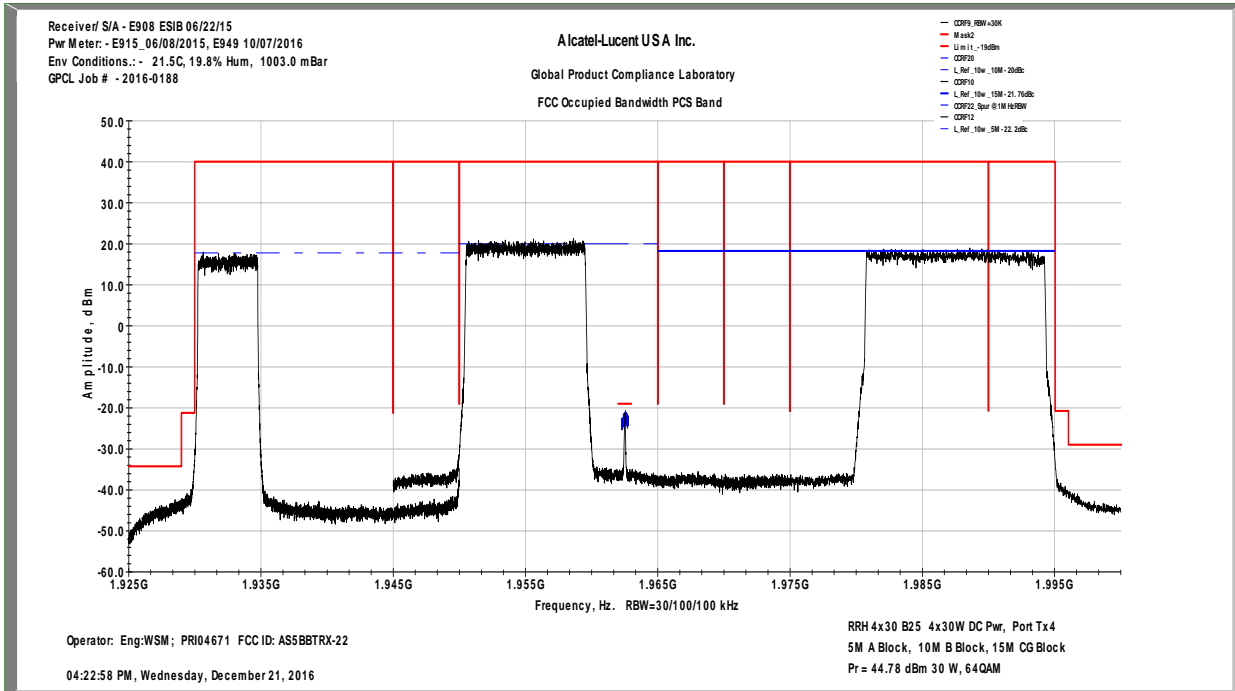

FCC Occupied Bandwidth / Power Calibration Test Configuration 11 Carrier Left

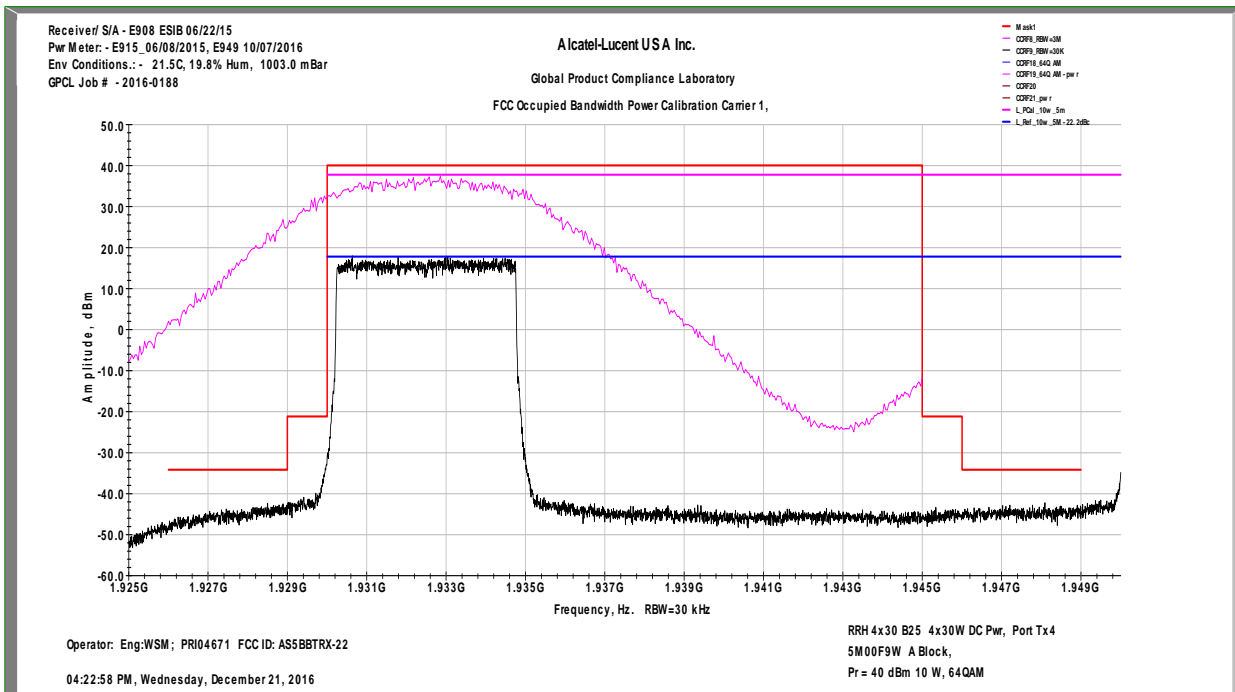

FCC Occupied Bandwidth / Power Calibration

Test Configuration 11 Carrier Right

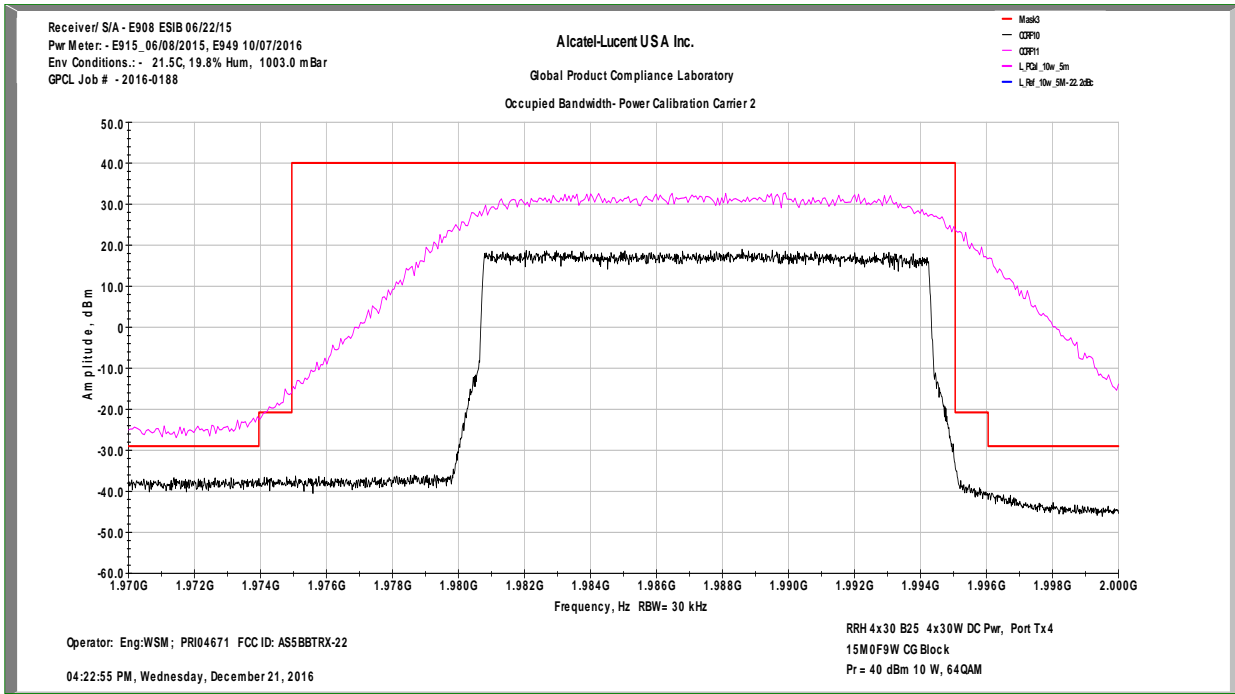

FCC Occupied Bandwidth / Power Calibration

Test Configuration 11 Carrier Middle

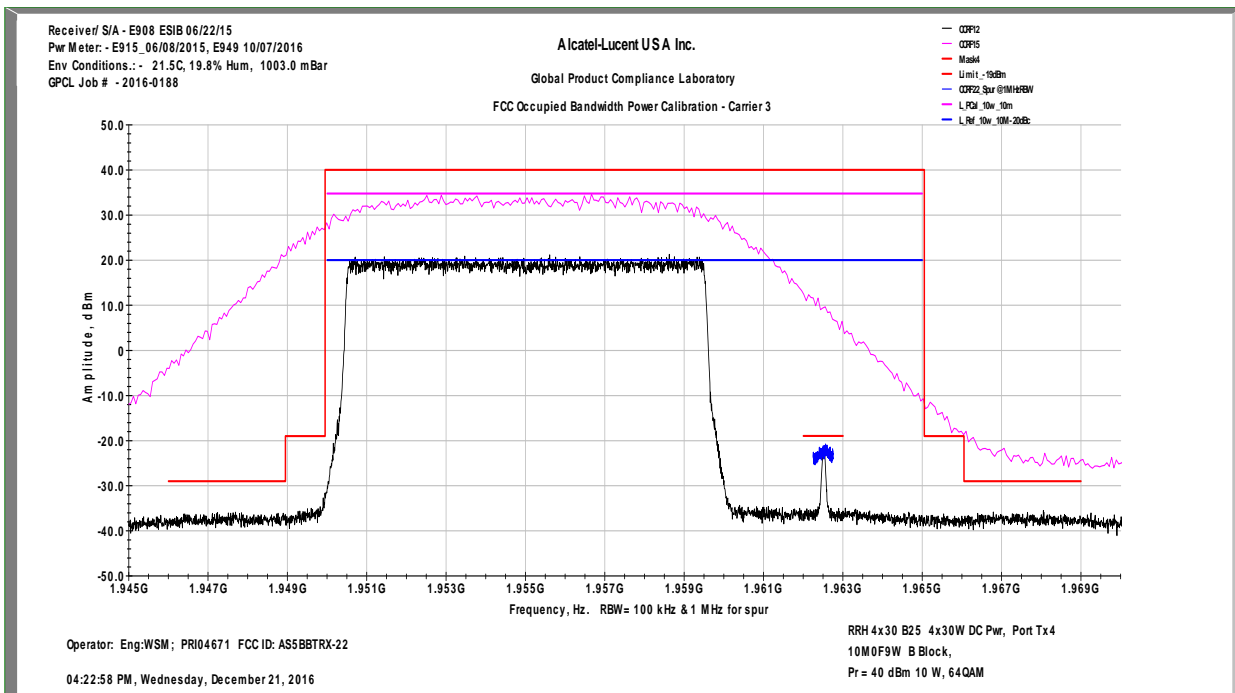

Test Configuration 12

FCC Occupied Bandwidth Whole Band View Test Configuration 12

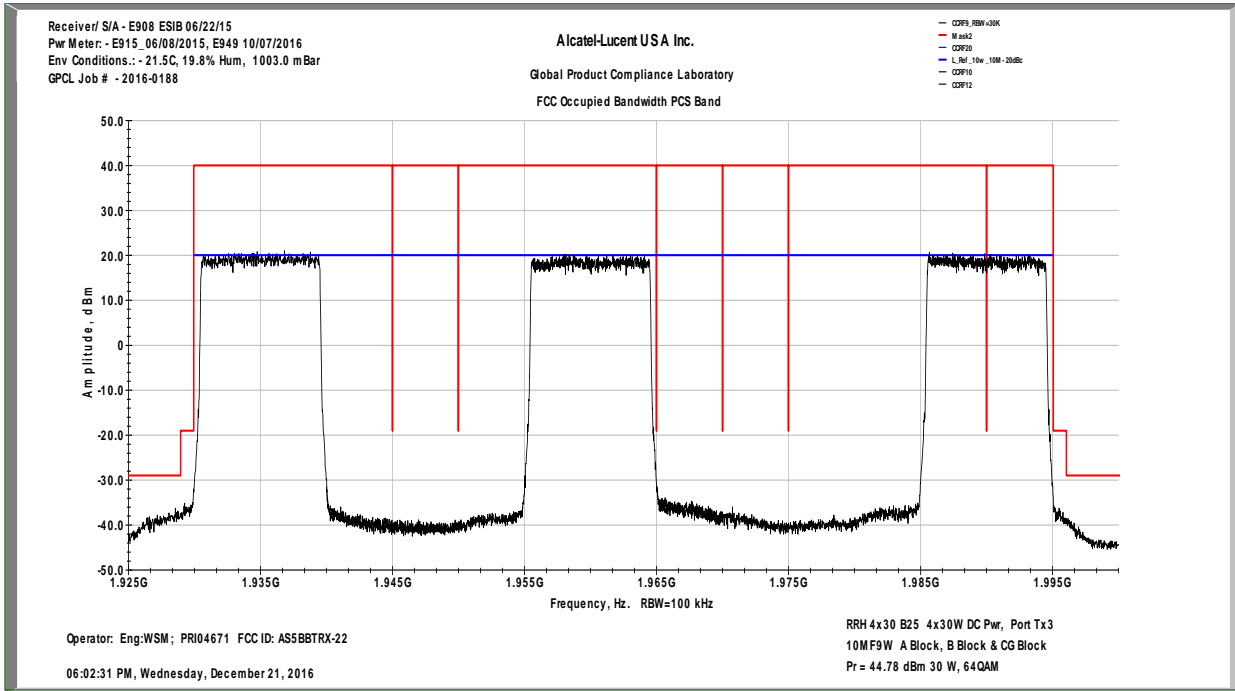

FCC Occupied Bandwidth / Power Calibration Test Configuration 12 Carrier Left

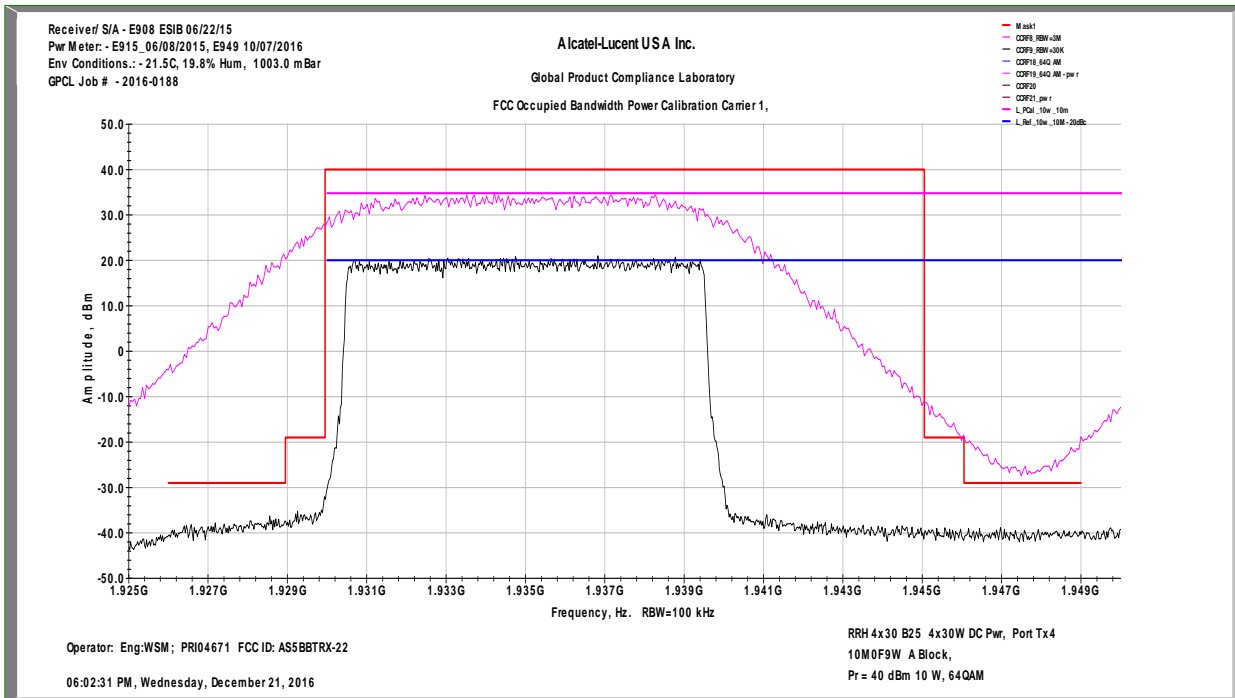

FCC Occupied Bandwidth / Power Calibration

Test Configuration 12 Carrier Right

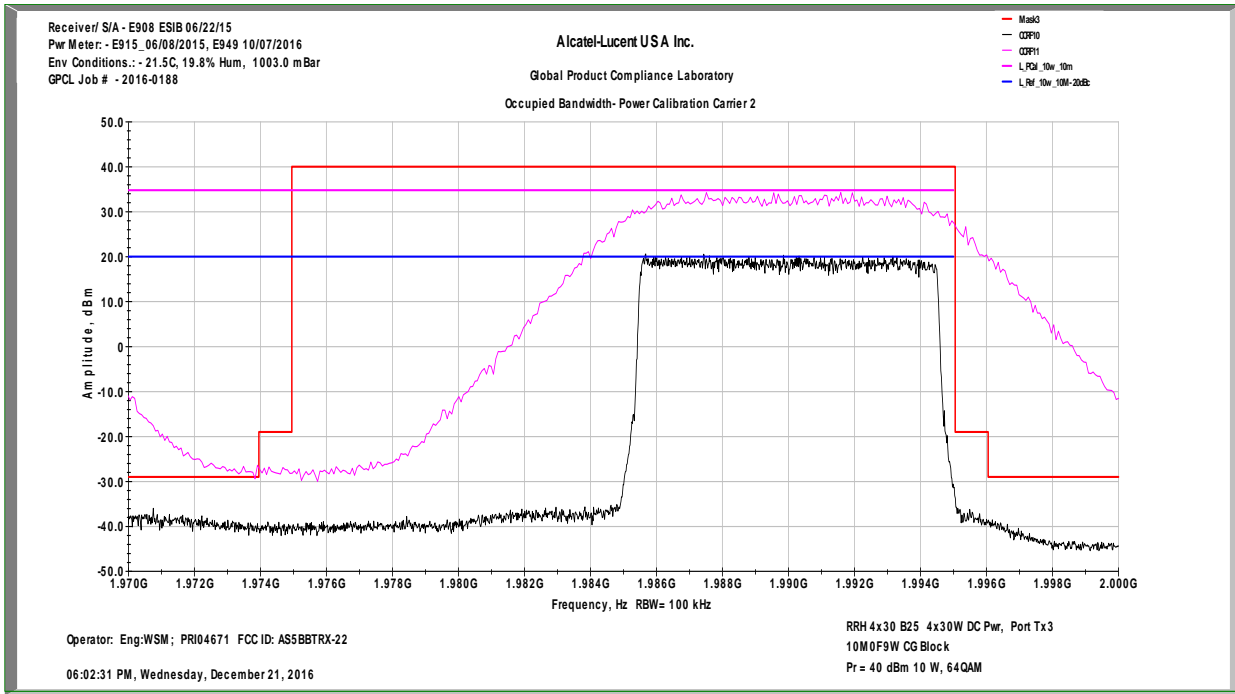

FCC Occupied Bandwidth / Power Calibration

Test Configuration 12 Carrier Middle

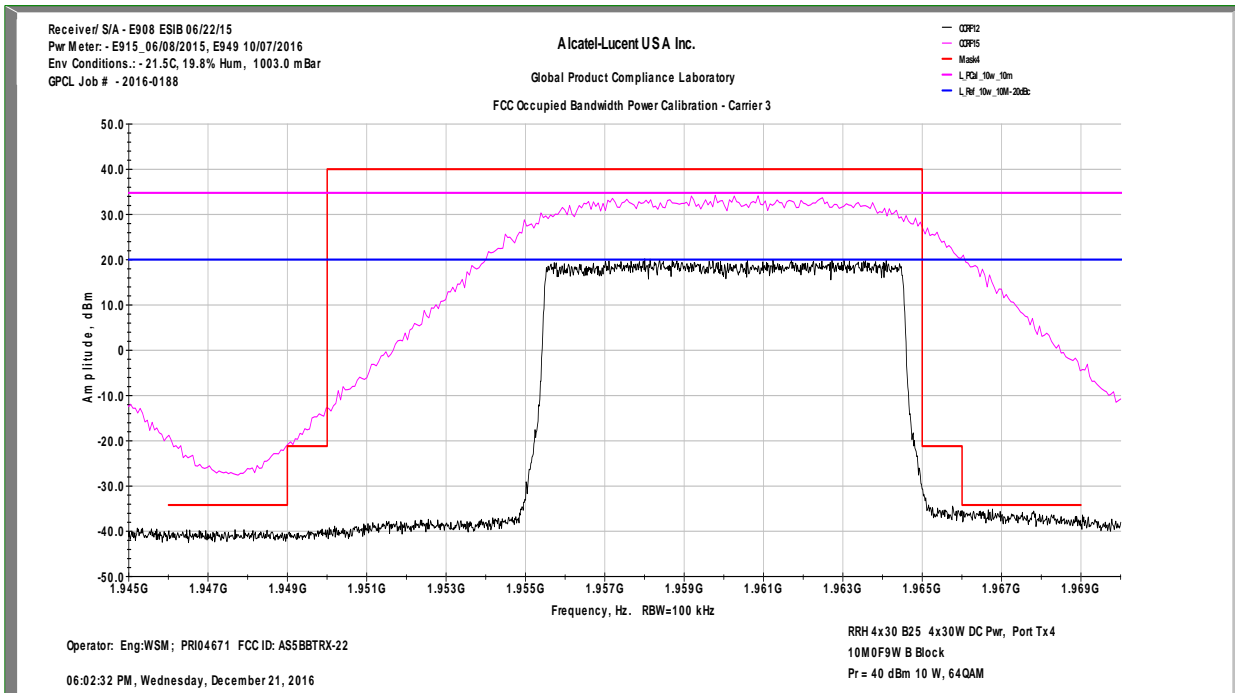

Test Configuration 13

FCC Occupied Bandwidth Whole Band View Test Configuration 13

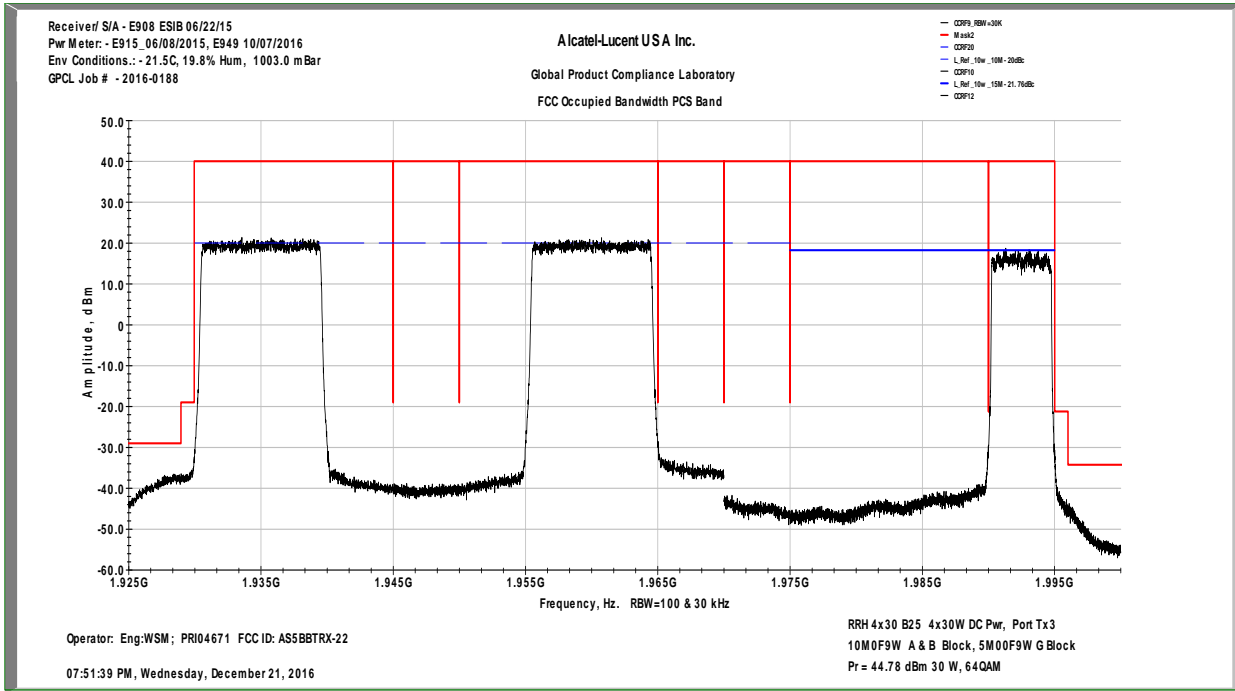

FCC Occupied Bandwidth / Power Calibration Test Configuration 13 Carrier Left

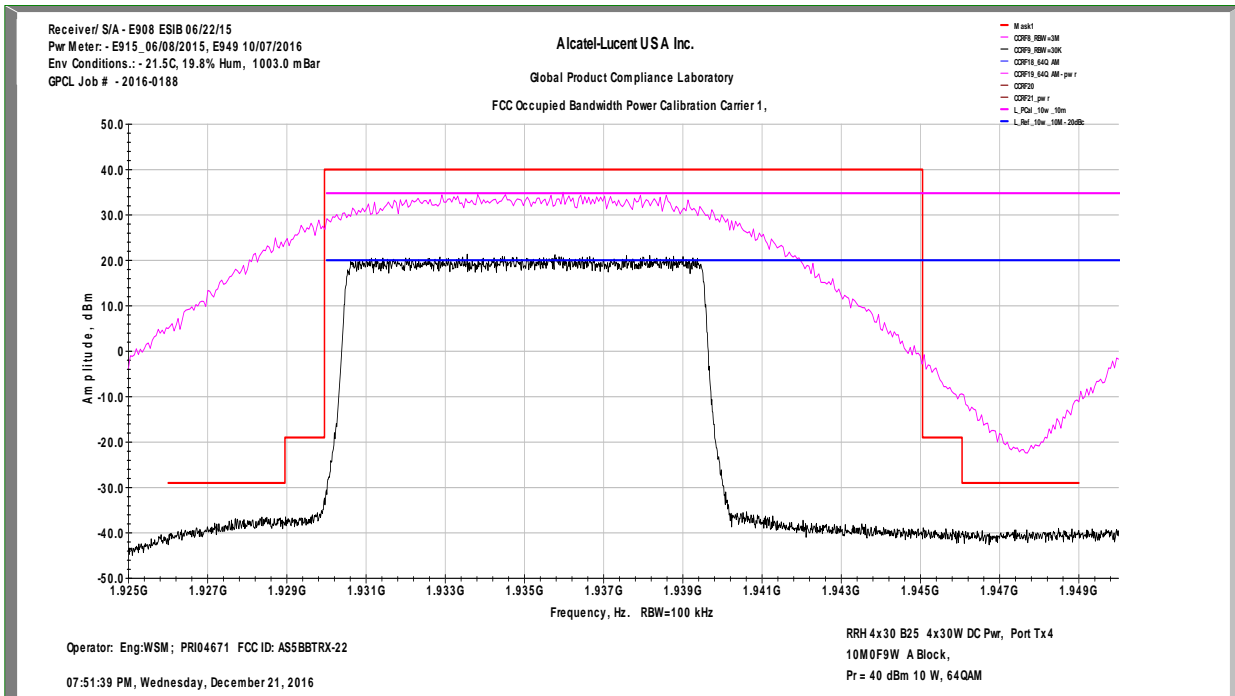

FCC Occupied Bandwidth / Power Calibration

Test Configuration 13 Carrier Right

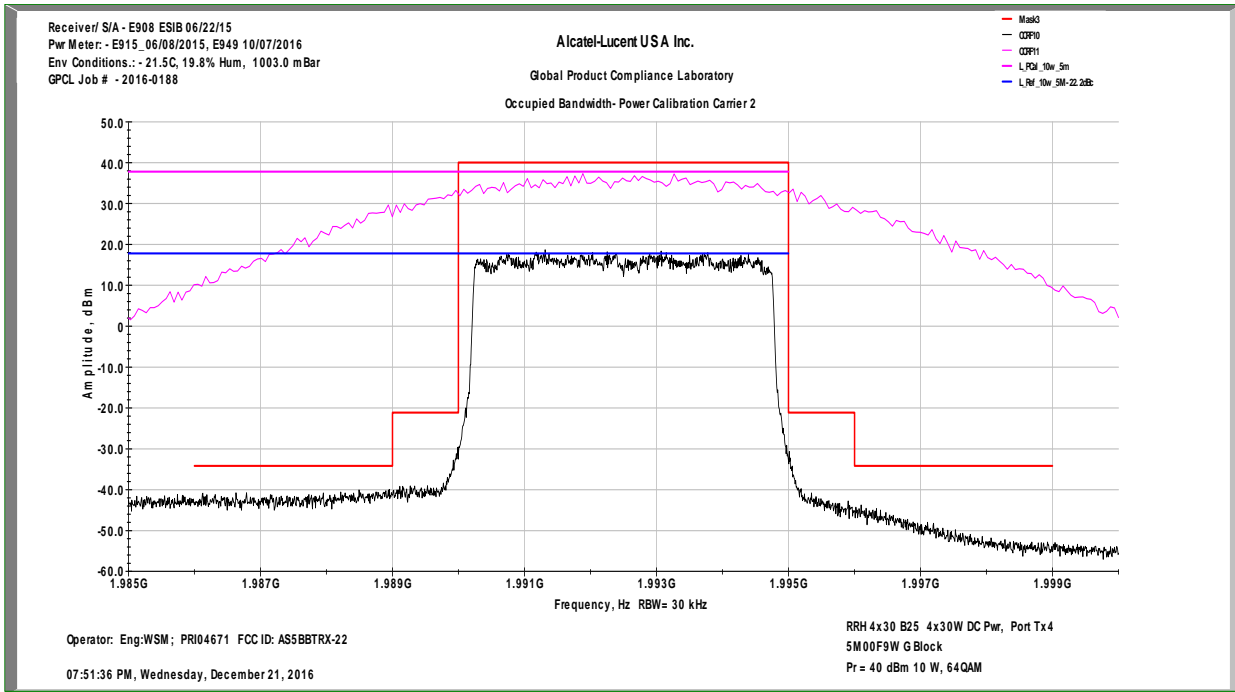

FCC Occupied Bandwidth / Power Calibration

Test Configuration 13 Carrier Middle

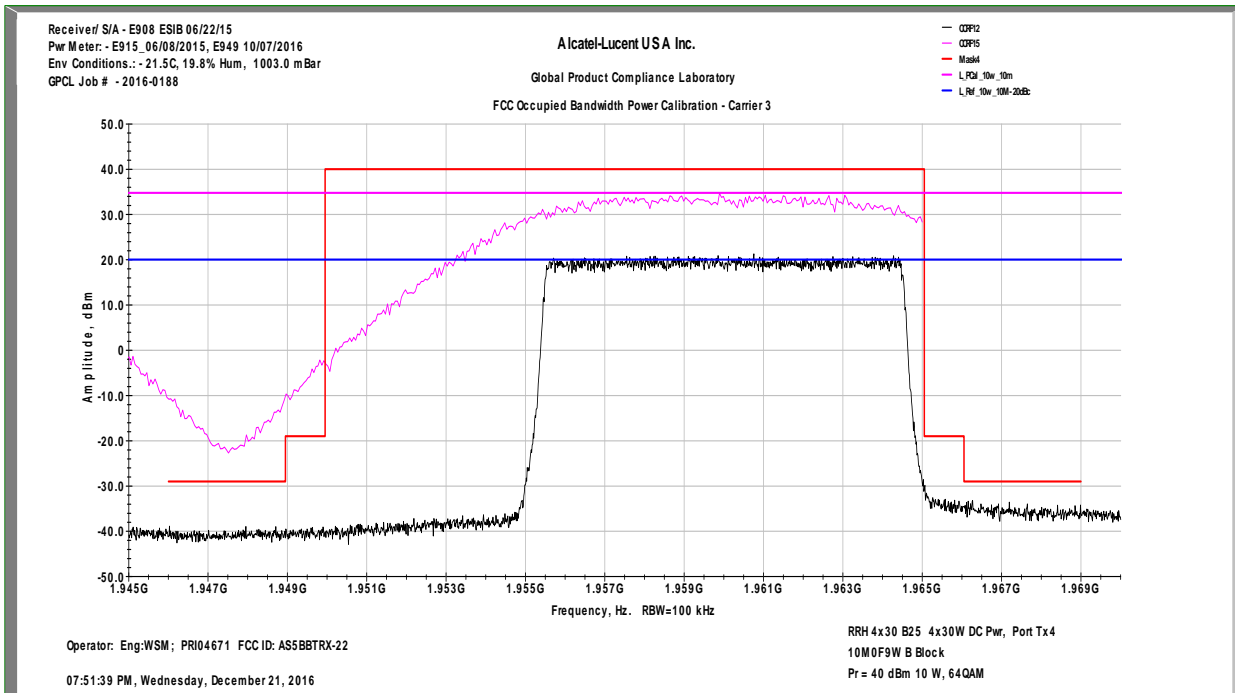

Test Configuration 14

FCC Occupied Bandwidth Whole Band View Test Configuration 14

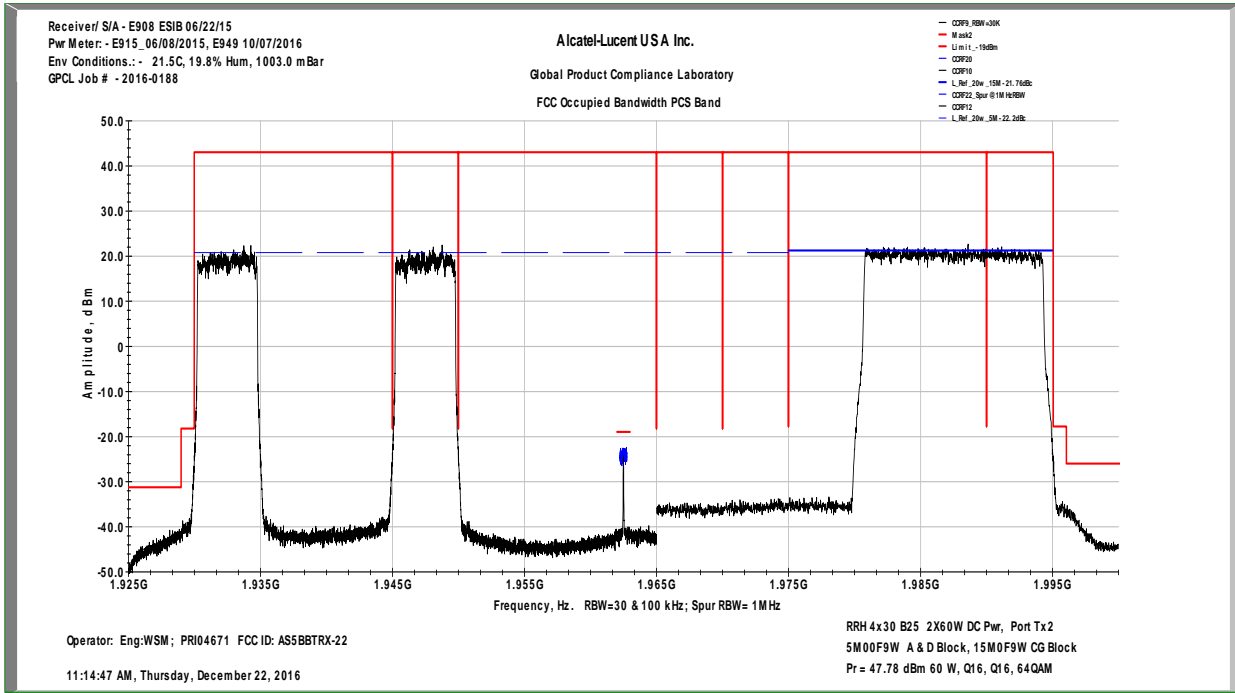

FCC Occupied Bandwidth / Power Calibration Test Configuration 14 Carrier Left

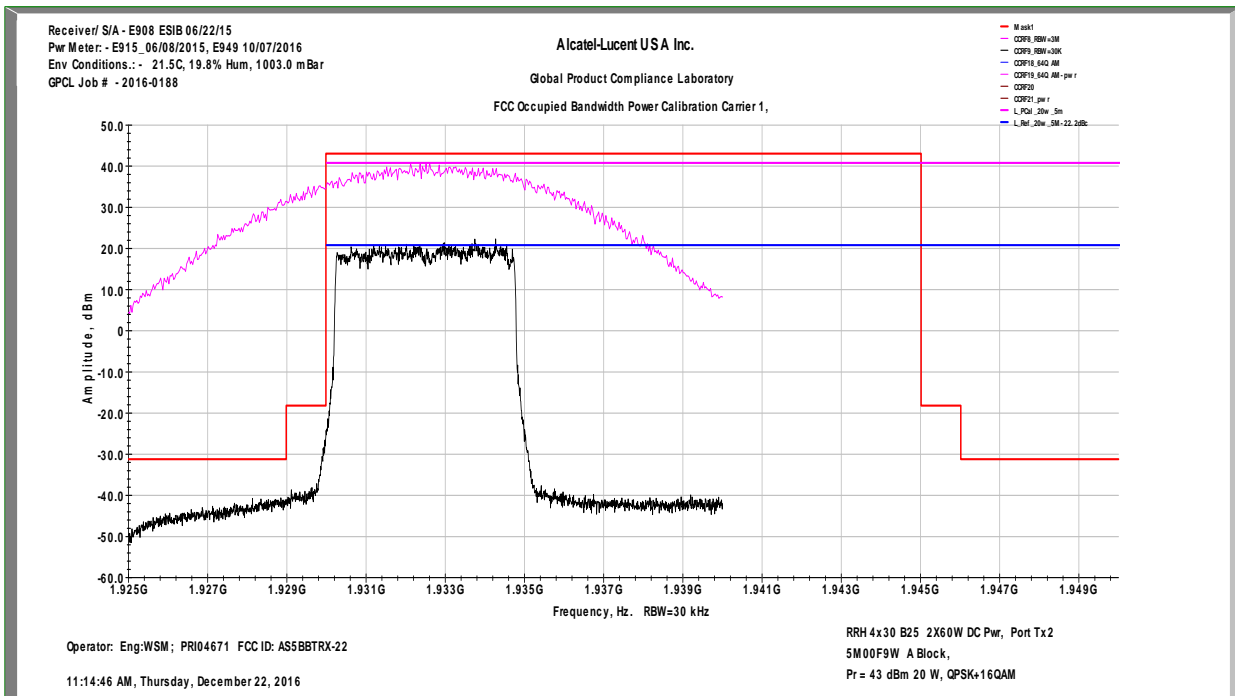

FCC Occupied Bandwidth / Power Calibration

Test Configuration 14 Carrier Right

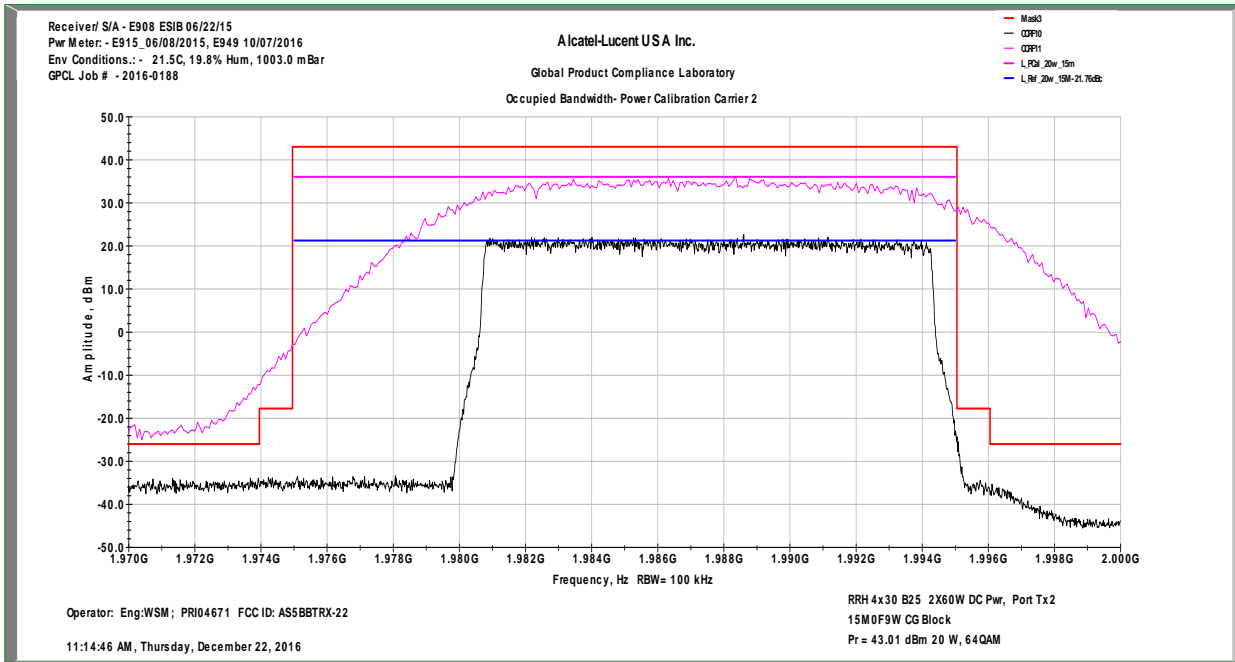

FCC Occupied Bandwidth / Power Calibration

Test Configuration 14 Carrier Middle

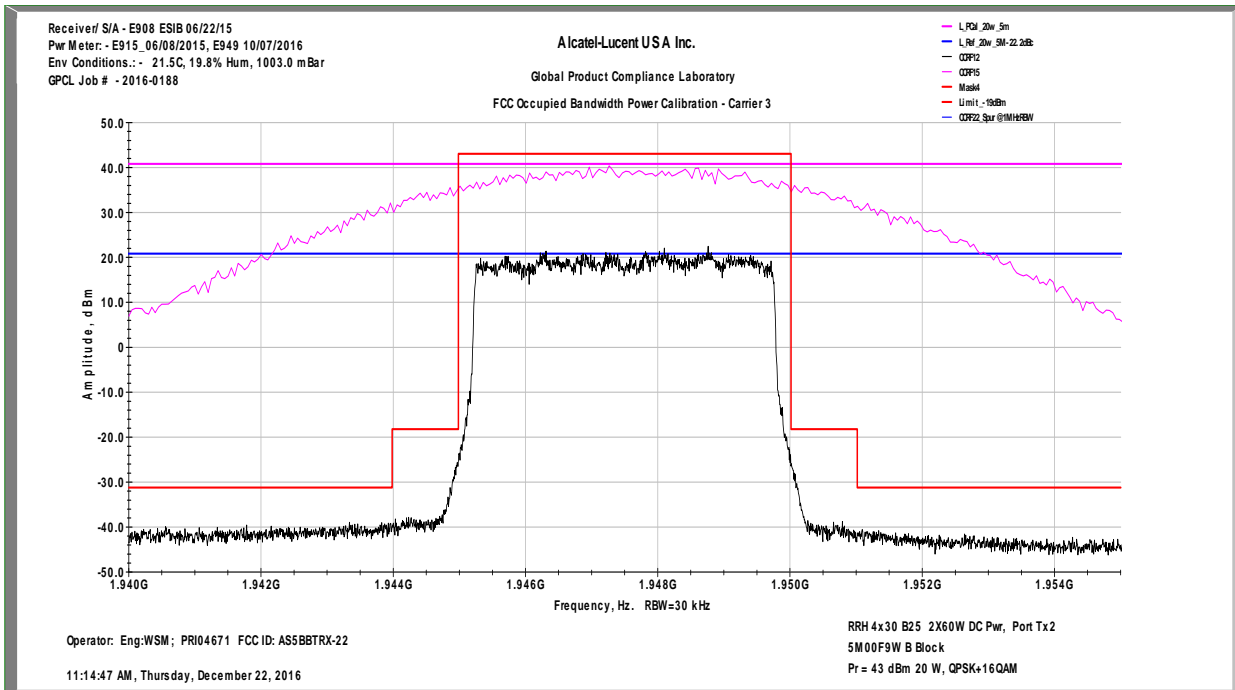

Test Configuration 15

FCC Occupied Bandwidth Whole Band View Test Configuration 15

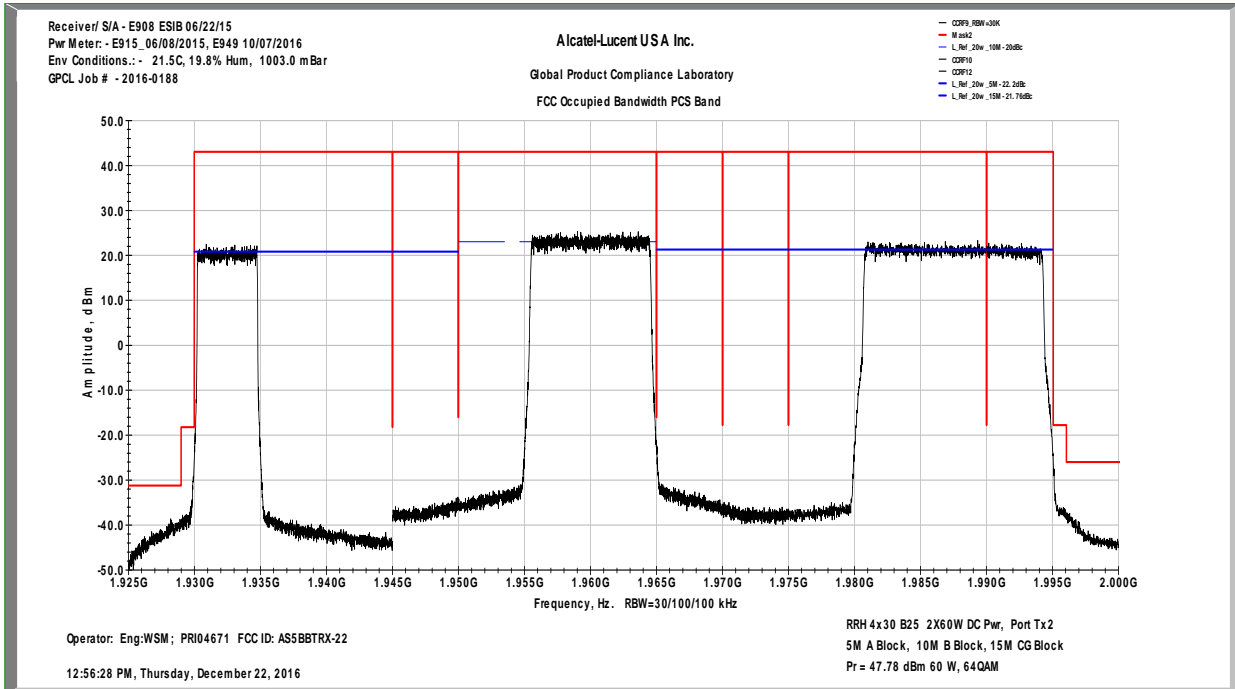

FCC Occupied Bandwidth / Power Calibration Test Configuration 15 Carrier Left

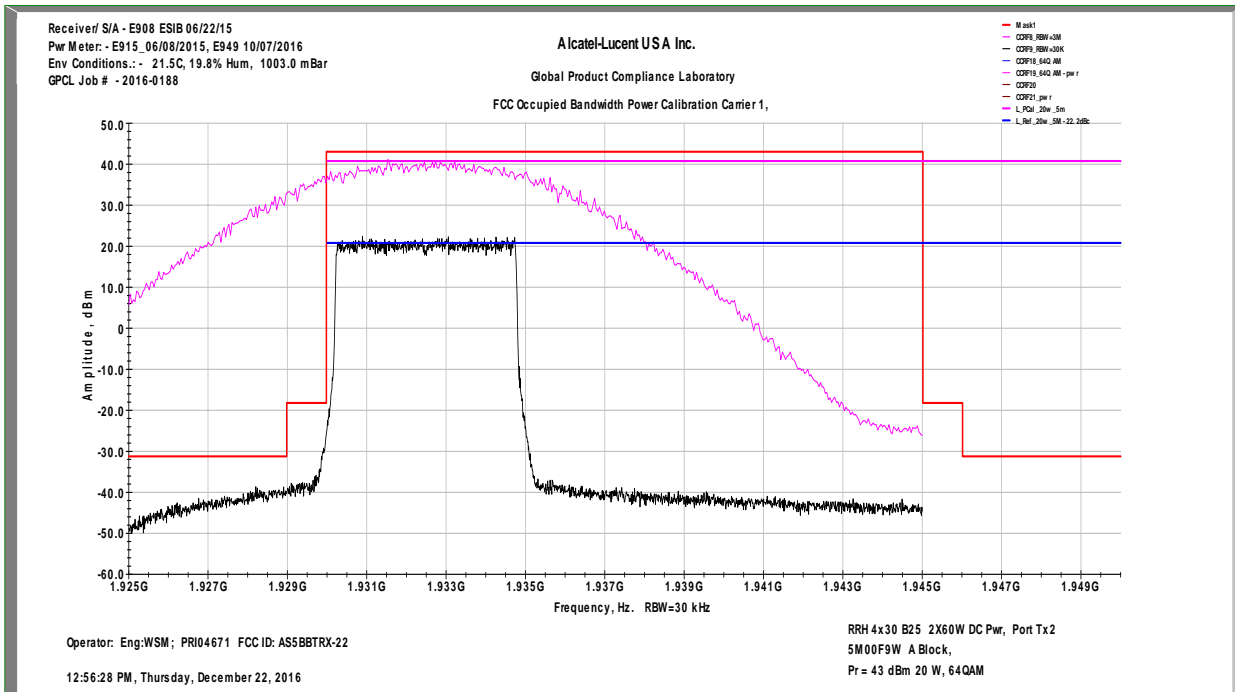

FCC Occupied Bandwidth / Power Calibration

Test Configuration 15 Carrier Right

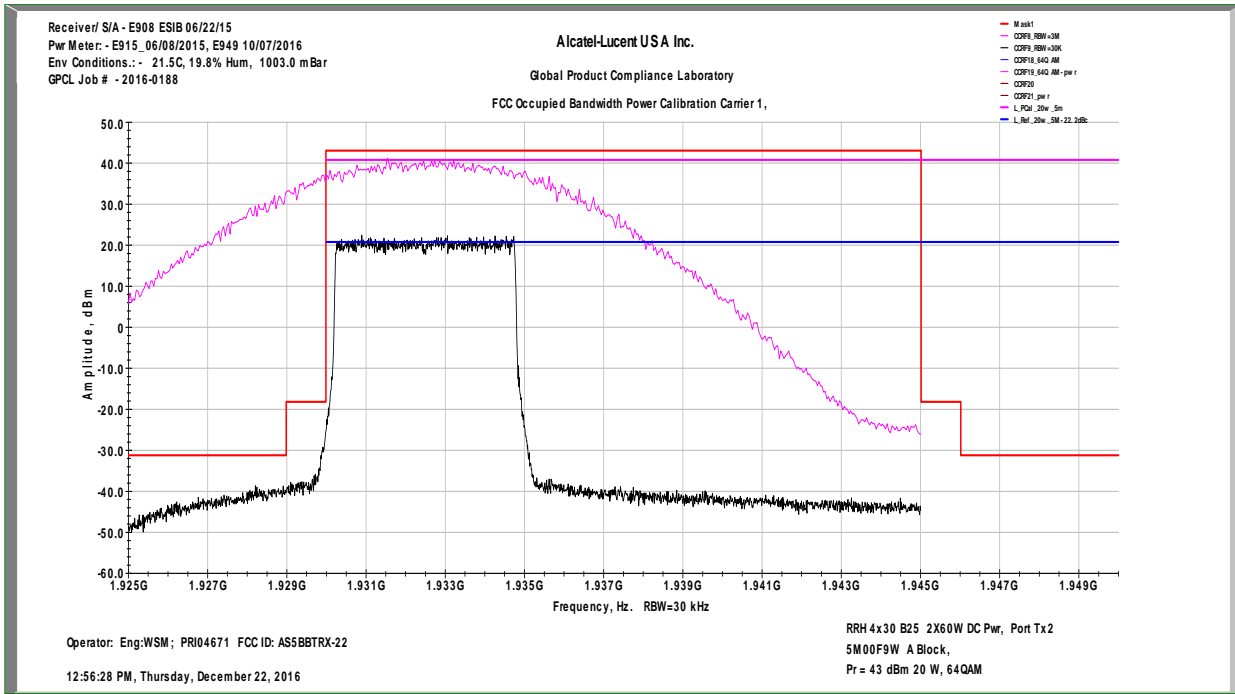

FCC Occupied Bandwidth / Power Calibration

Test Configuration 15 Carrier Middle

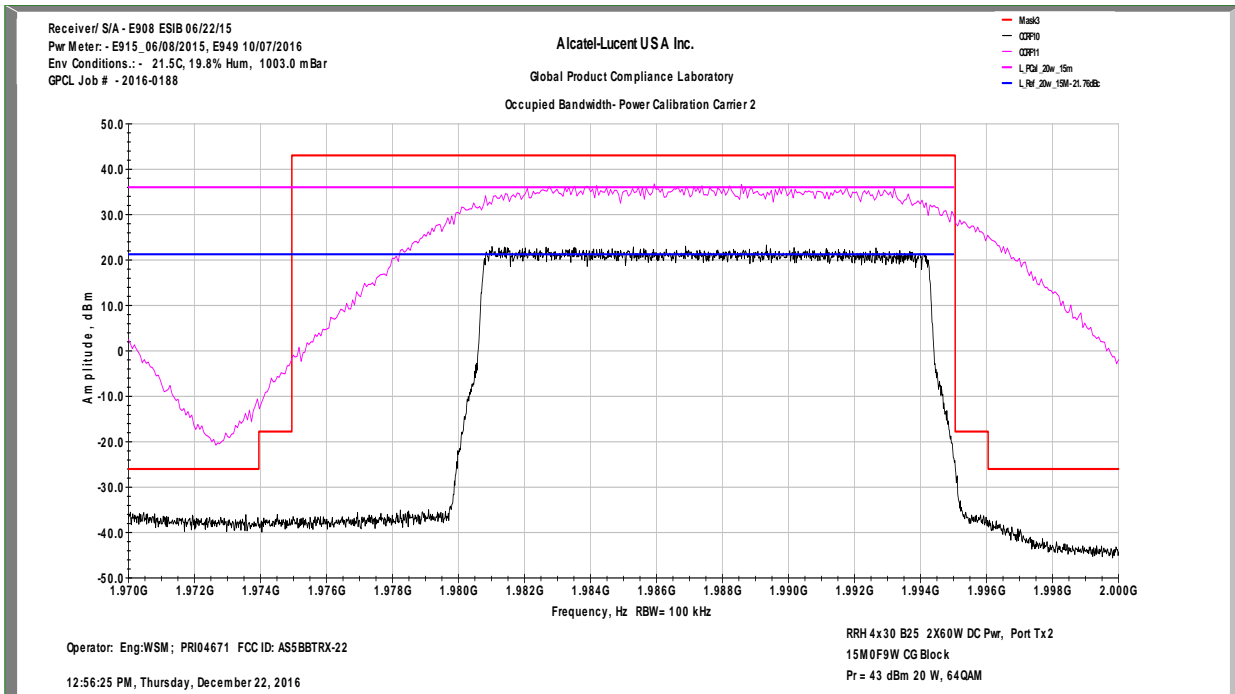

Test Configuration 16

FCC Occupied Bandwidth Whole Band View Test Configuration 16

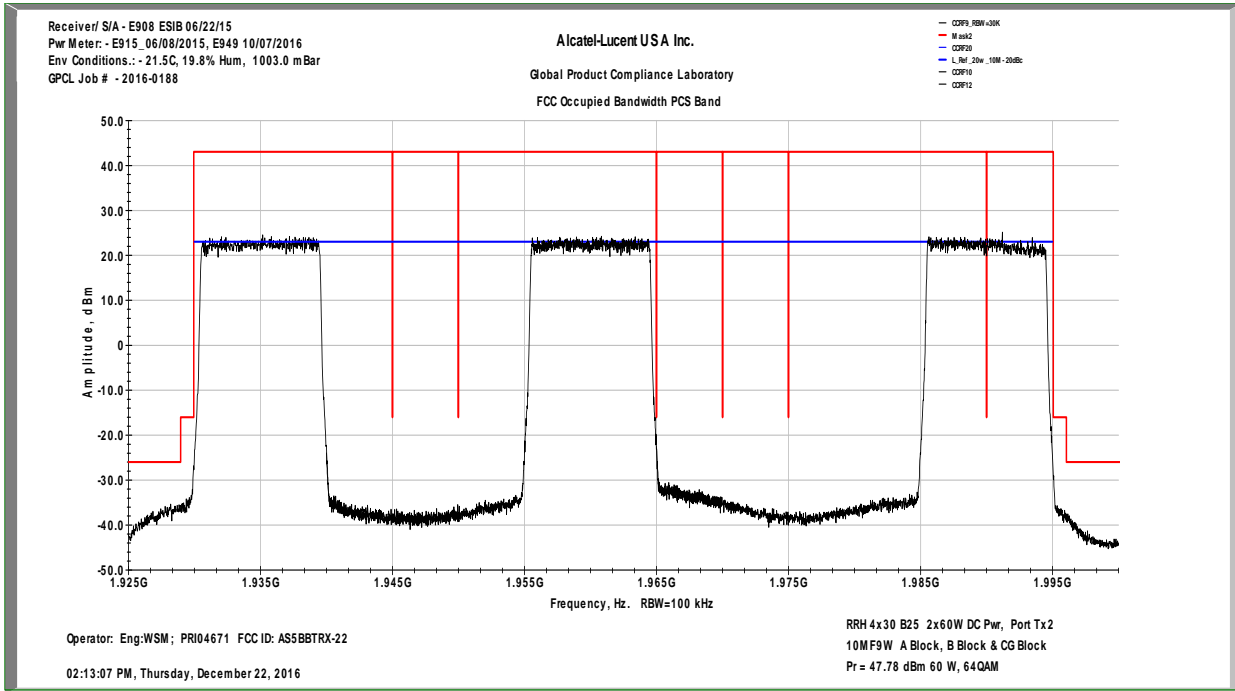

FCC Occupied Bandwidth / Power Calibration Test Configuration 16 Carrier Left

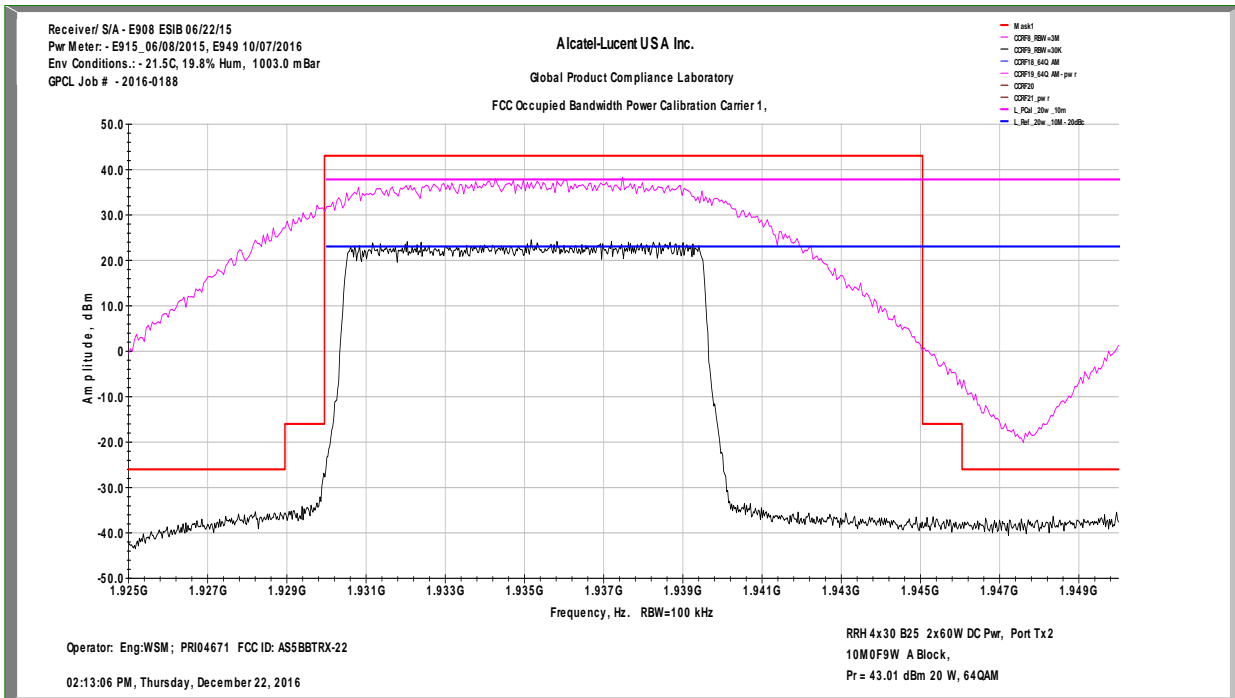

FCC Occupied Bandwidth / Power Calibration

Test Configuration 16 Carrier Right

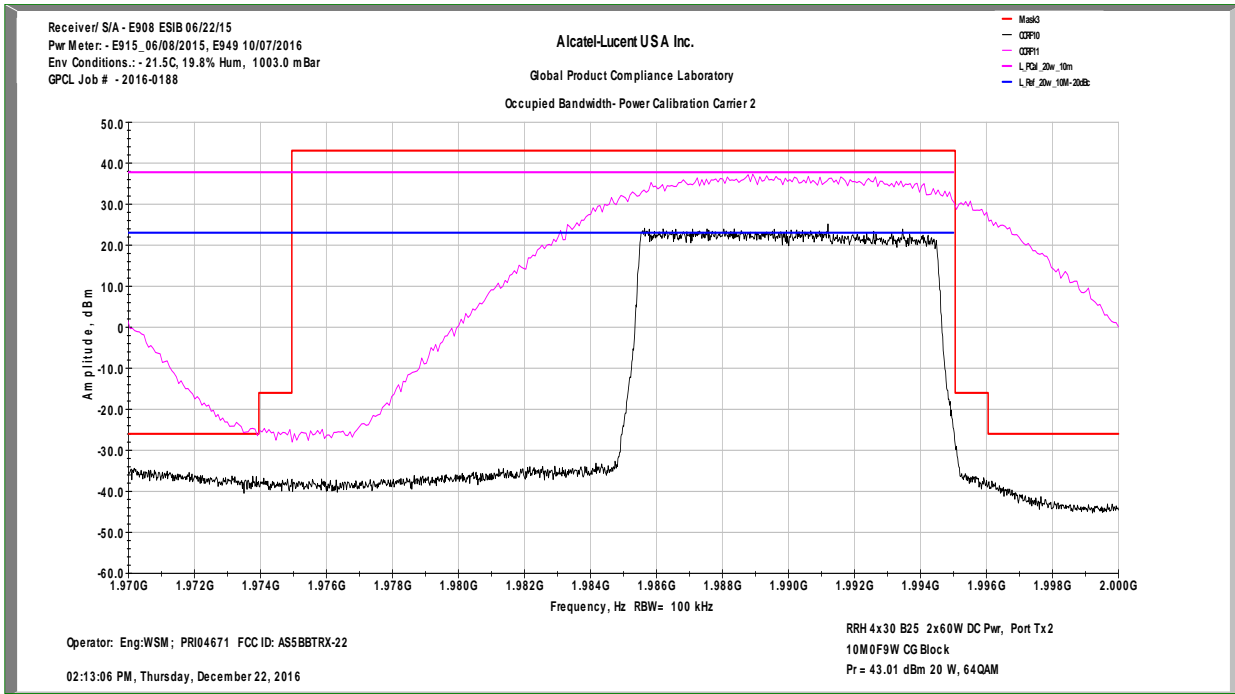

FCC Occupied Bandwidth / Power Calibration

Test Configuration 16 Carrier Middle

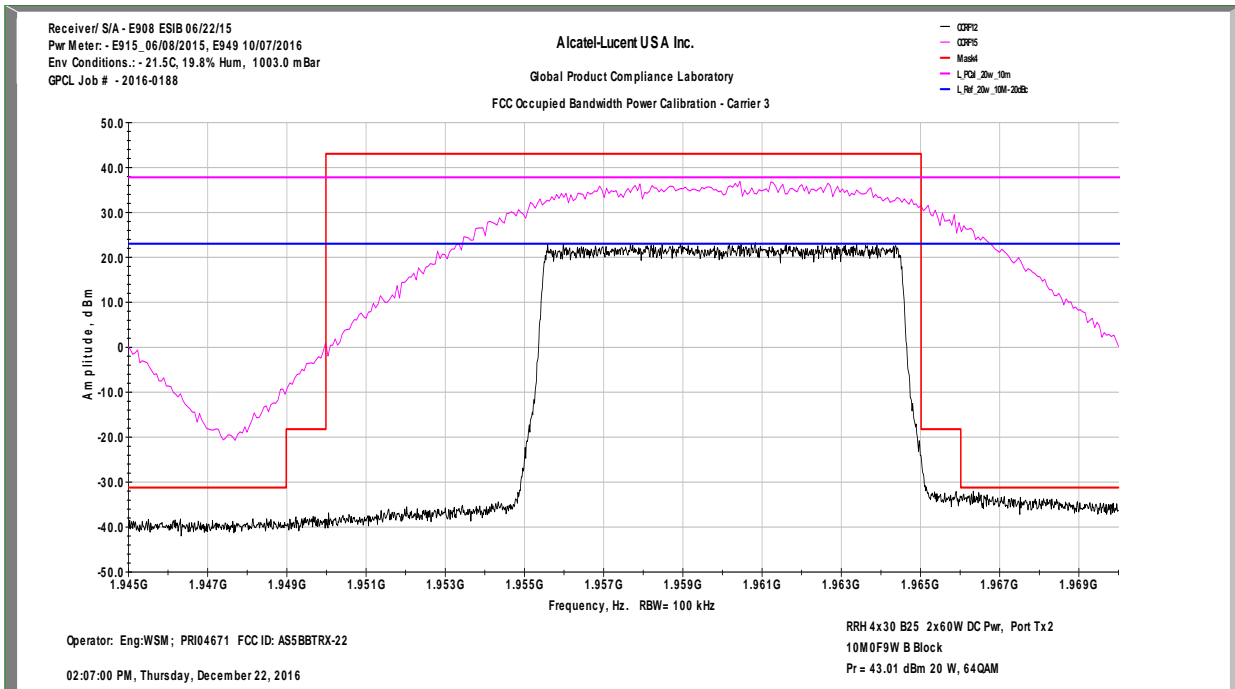

Test Configuration 17

FCC Occupied Bandwidth Whole Band View Test Configuration 17

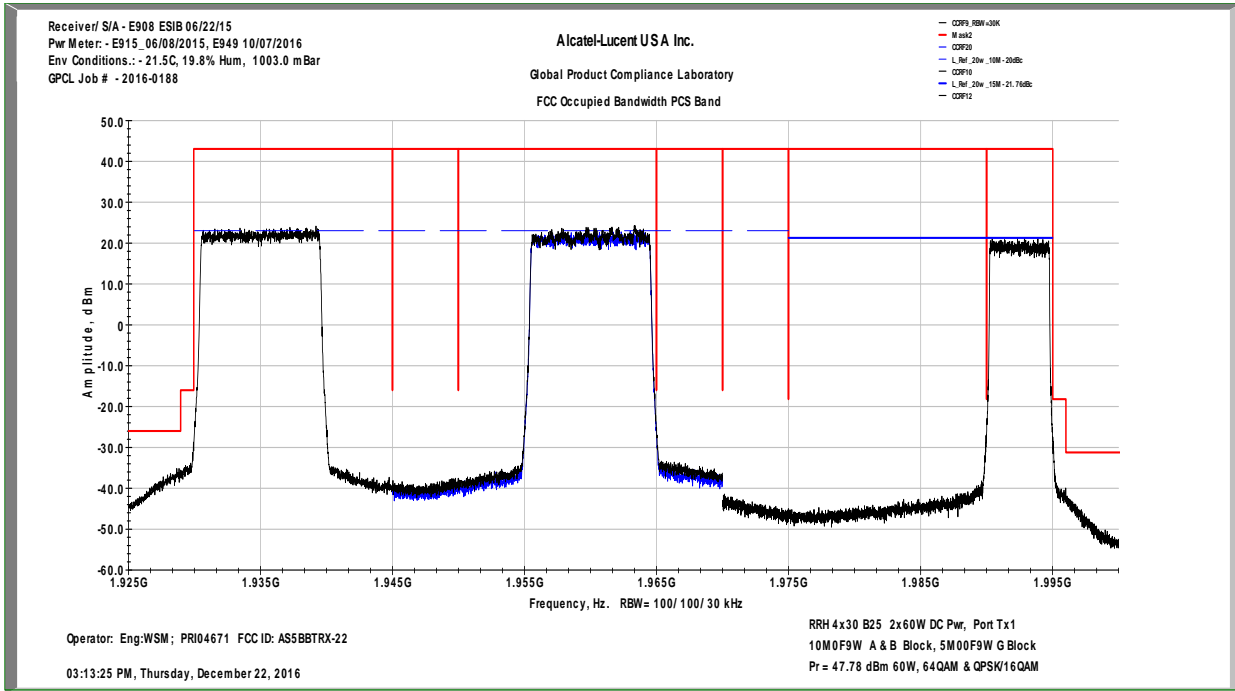

FCC Occupied Bandwidth / Power Calibration Test Configuration 17 Carrier Left

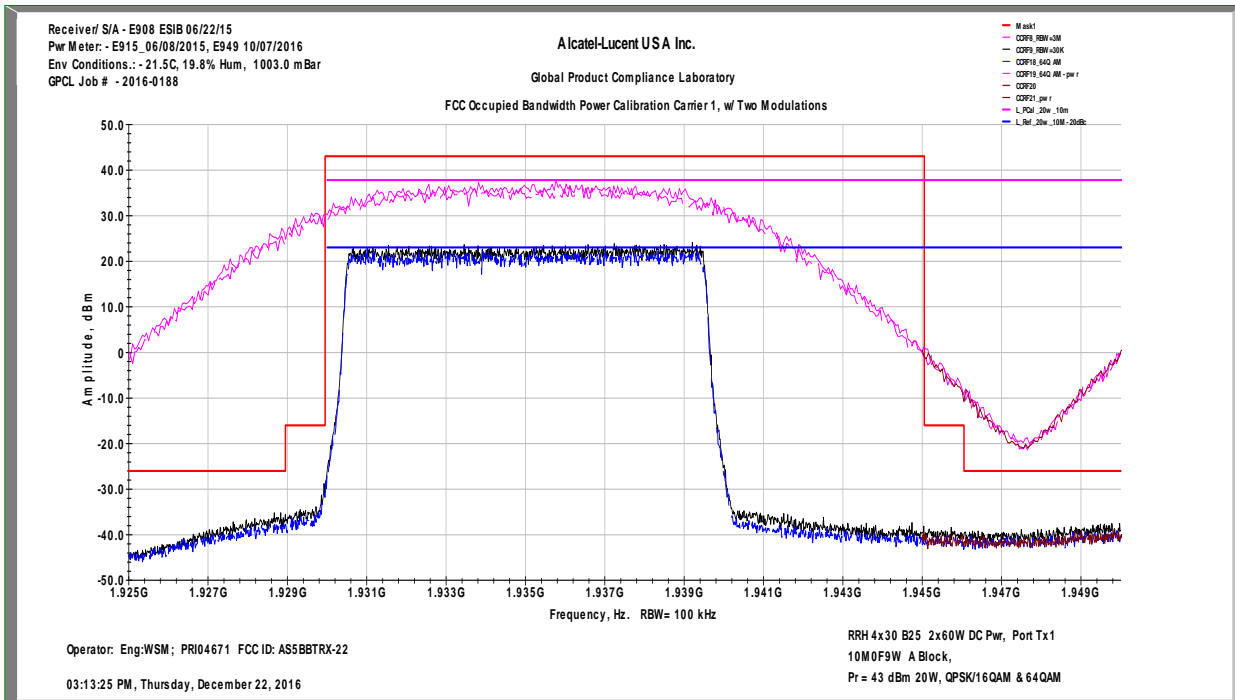

FCC Occupied Bandwidth / Power Calibration

Test Configuration 17 Carrier Right

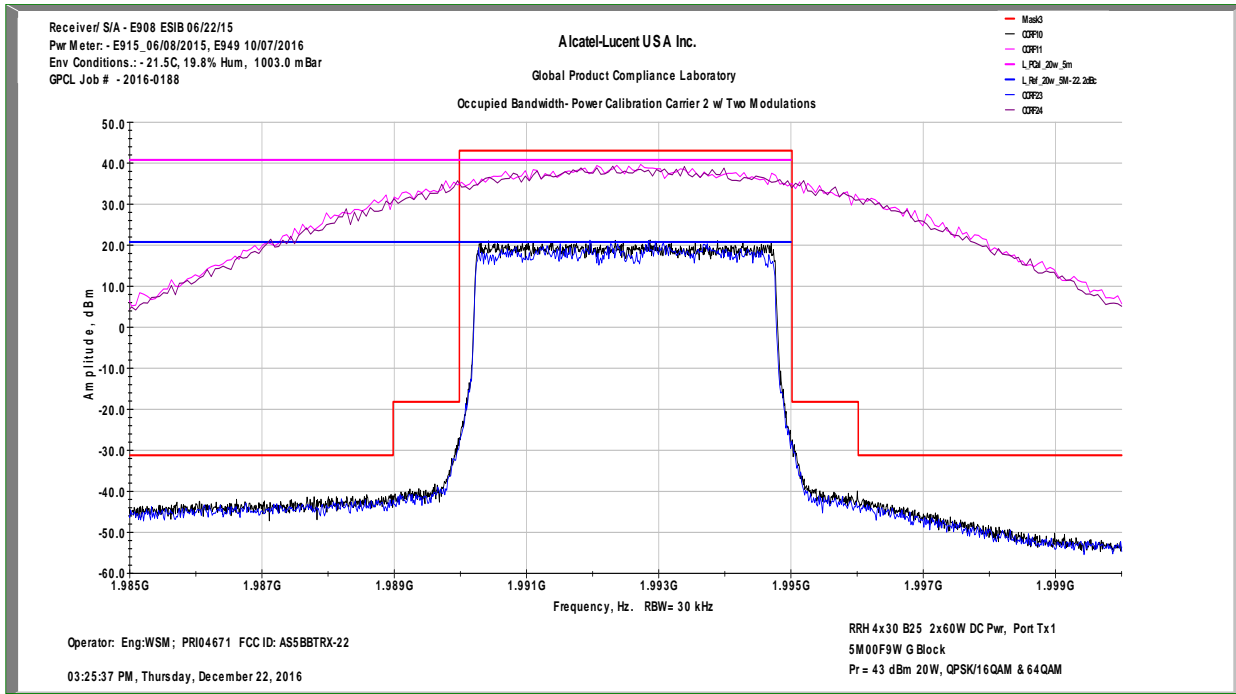

FCC Occupied Bandwidth / Power Calibration

Test Configuration 17 Carrier Middle

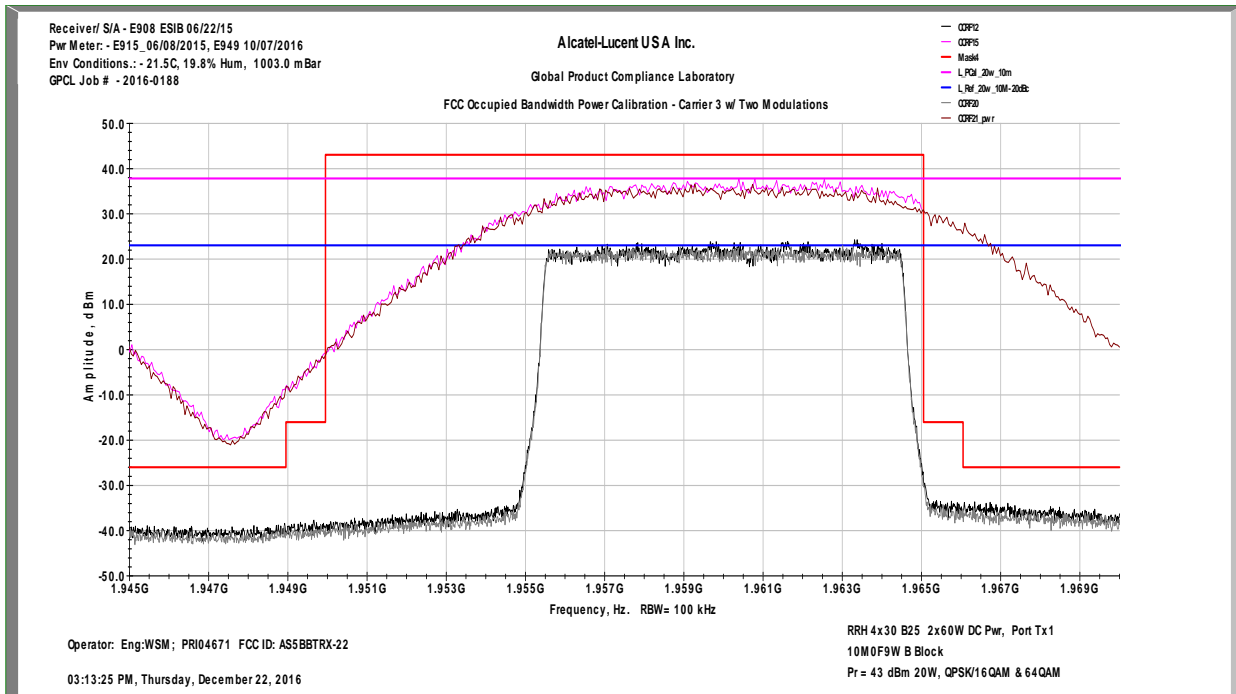

Test Configuration 18

FCC Occupied Bandwidth Whole Band View Test Configuration 18

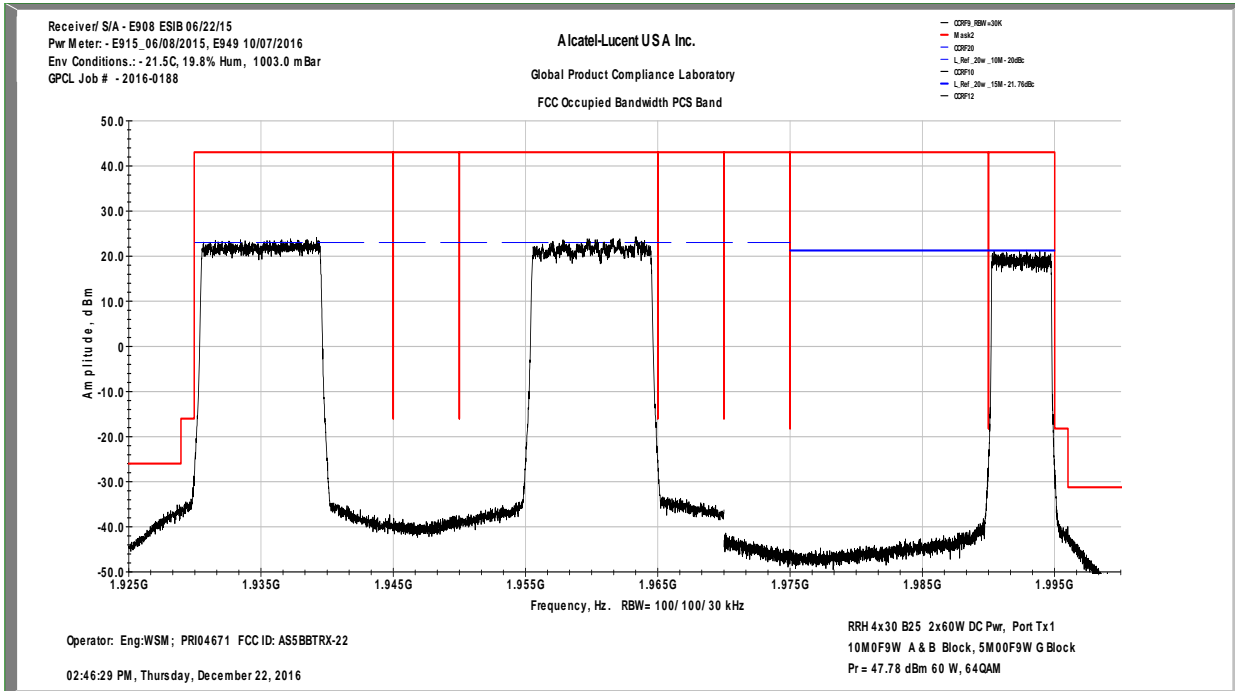

FCC Occupied Bandwidth / Power Calibration Test Configuration 18 Carrier Left

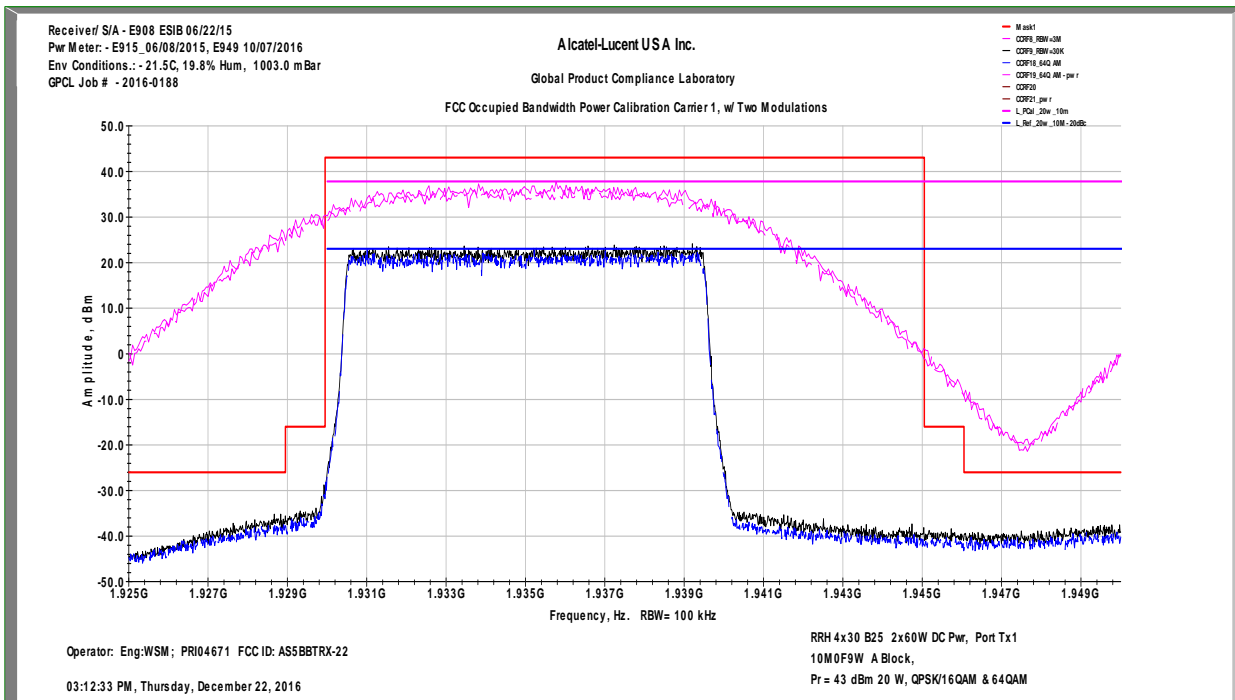

FCC Occupied Bandwidth / Power Calibration

Test Configuration 18 Carrier Right

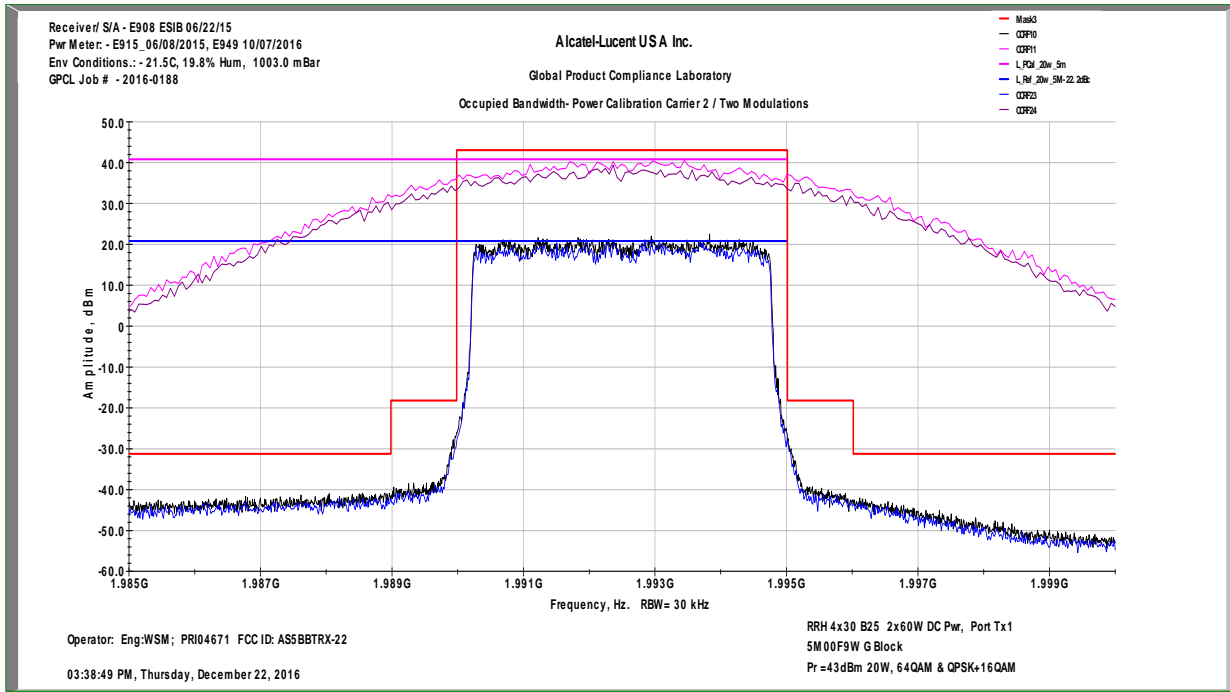

FCC Occupied Bandwidth / Power Calibration

Test Configuration 18 Carrier Middle

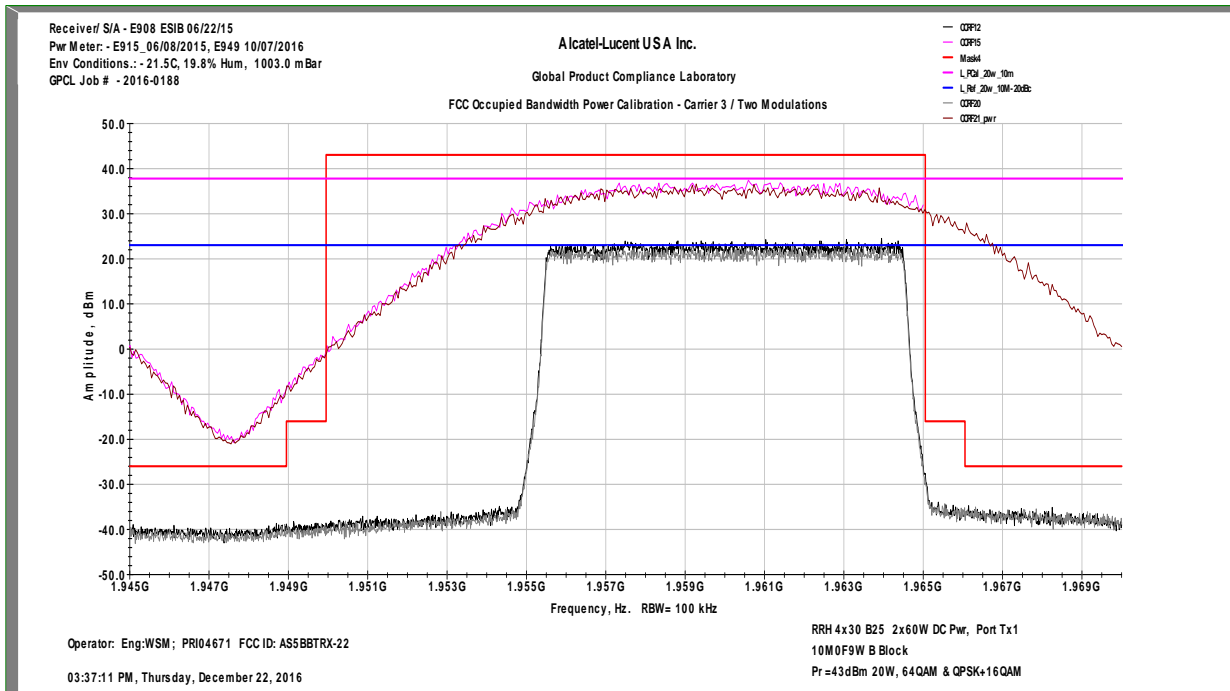

4.4 Section 2.1051 MEASUREMENT REQUIRED: SPURIOUS EMISSIONS AT THE ANTENNA TERMINALS

This test measures the emissions of spurious signals which may come from harmonic, parasitic, intermodulation and frequency conversion products and are outside the necessary bandwidth but excludes Edge-of-Band emissions.

4.4.1 Section 2.1051 Spurious Emissions at Antenna Terminals

Spurious Emissions at the antenna terminals were investigated per Section 2.1057(a)(1) over the frequency range of 10 MHz to 20 GHz which is beyond the 10th harmonic of the carrier frequency. A test coupler which incorporates a low inter-mod broadband RF attenuator was used to reduce the transceiver's amplitude to a level usable by the spectrum analyzer. The test configuration is shown in Figure 4.4.1 which documents the test set up used for the measurements. In this set up the complete RF test path was calibrated over the 10 MHz-20 GHz range and it allows for RF power to be measured and monitored during the test.

The spurious measurements were made using an automated test system. The test system consists of a Rohde & Schwarz ESIB-40 Test Receiver/ Spectrum Analyzer, a PC based computer test controller, calibrated test hardware and a TILE™ software program to acquire the test data. This system provides for measurements to be performed in compliance with ANSI C63.26 and our ISO17025 process. The measurement meets the ANSI C63.26 requirements in paragraphs 5.2.4.4.1 and 5.7 which requires that the number of points in the sweep be $> 2 \times \text{Span}/\text{RBW}$. The volume of collected data is greater than 1×10^5 data points over the frequency range of 10 MHz to 20 GHz. The automated test system provides for a presentation of the data in an accurate and compact form for FCC review.

Measurements were performed for all of the test configurations in Table 4.4.4 and these match the test configurations used for Occupied Bandwidth / Edge of Band Emissions, RF Power and modulation.

4.4.2 Required Limit

The required emission limitation specified in **47CFR 24.238 1-Oct-2010** was applied to these tests. Based upon the criterion given in Section 24.238 of the Code and as developed in Exhibit 14, the required emission limit in 47 CFR 24.238(a) for emissions outside a licensee's frequency block is:

Emissions >1 MHz outside the Block, *when measured with a RBW of 1 MHz*, shall be attenuated by :

$$-\{43+10\log(\text{mean power output in watts})\} = -13 \text{ dBm.}$$

In order to account for the spectral adding of identical signals from the primary and diversity ports, per KDB 662911 D01 Multiple Transmitter Output v01r01, the level needs to be adjusted by $10\text{LOG}(n)$ where n = number of outputs.

The adjustment for $n=2$ is: $3.01 \text{ dB} = 10\text{LOG}(2)$

The adjustment for $n=4$ is: $6.02 \text{ dB} = 10\text{LOG}(4)$

Therefore the limit for emissions >1 MHz outside a licensee's frequency block when measured with a RBW of 1 MHz is:

$$-13 \text{ dBm} - 3.01 \text{ dB} = -16.01 \text{ dBm} \text{ for } 2\text{x MIMO}$$

and

$$-13 \text{ dBm} - 6.02 \text{ dB} = -19.02 \text{ dBm} \text{ for } 4\text{x MIMO}$$

The carrier signal shown on these plots was measured at a resolution Bandwidths of 3 MHz. This was done so that the carrier plot correctly and accurately depicts the carrier output power in relation to the spurious signals and the defined limit.

4.4.3 Operational Configuration

The modulation used in this evaluation are described in the pertinent standards documents which include **3GPP TS 36.211 V9.1.0 (2010-03)** titled: 3rd Generation Partnership Project; Technical Specification Group Radio Access Network; Evolved Universal Terrestrial Radio Access (E-UTRA); Physical Channels and Modulation (Release 9). The modulation is Orthogonal Frequency Division Multiple Access (OFDMA) which is processed into an uplink IF signal. The input data stream is divided into several parallel sub-streams of reduced data rate and each sub-stream is transmitted on a separate orthogonal sub-carrier. The sub-carriers are modulated using either QPSK, or 64QAM. There is no single measure of the modulation quality other than to verify that the subcarrier modulation constellations visual orientation match the symbol and amplitude criteria is consistent with QPSK and 64QAM.

4.4.4 Results:

Over the required frequency spectrum investigated for the EUT, no reportable out-of-block spurious emissions were detected. The out-of-block spurious emissions in the entire spectrum investigated are under the required reportable emission limit and are tabulated in Table 4.4.4 below. Two sets of data which represent the two MIMO configurations tested are attached below. The measurement results demonstrate that the subject of the application is in full compliance with the Rules of the Commission.

Table 4.4.4 Compliance Tabulation of Conducted Spurious Emissions Measurements

Test #	PCS Blocks	Port	Signal Bandwidth, MHz	Modulation Q16=qpsk+16qam 64=64QAM	Total per Port Power, Watts	Antenna Port Conducted Spurious Emissions Pass / Fail
1	A+CG	Tx1	5+10	QPSK+16QAM	30	Pass
2	A+CG	Tx1	5+10	64QAM	30	Pass
3	A+CG	Tx3	10+10	Q16, 64QAM	30	Pass
4	A+B	Tx3	10+10	64QAM, Q16	30	Pass
5	A+CG	Tx3	15+10	64QAM	30	Pass
6	A+CG	Tx3	10+15	64QAM	30	Pass
7	A+E+G	Tx3	10+5+5	64QAM	30	Pass
8	A+E+G	Tx3	5+5+5	QPSK+16QAM	30	Pass
9	A+E+G	Tx3	5+5+5	64QAM	30	Pass
10	A+D+CG	Tx4	5+5+15	Q16, Q16, 64QAM	30	Pass
11	A+B+CG	Tx4	5+10+15	64QAM	30	Pass
12	A+B+CG	Tx4	10+10+10	64QAM	30	Pass
13	A+B+G	Tx4	10+10+5	64, 64, Q16	30	Pass
14	A+B+CG	Tx1	5+5+15	Q16, Q16, 64QAM	60	Pass
15	A+B+CG	Tx1	5+10+15	64QAM	60	Pass
16	A+B+CG	Tx2	10+10+10	64QAM	60	Pass
17	A+B+G	Tx2	10+10+5	QPSK+16QAM	60	Pass
18	A+B+G	Tx2	10+10+5	64QAM	60	Pass

Figure 4.4.1 Test Set-Up for Measurement of Conducted Spurious Emissions

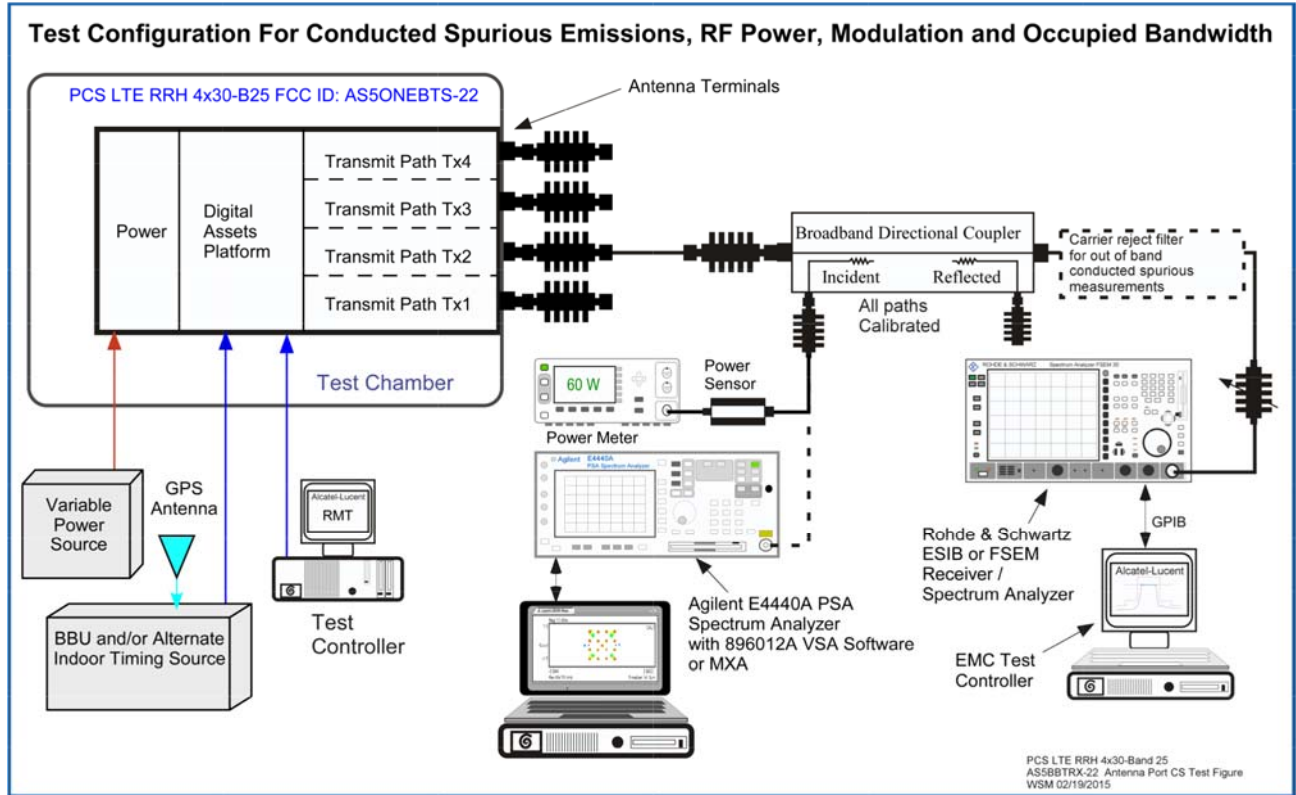

**Transmitter Measurements
of
Conducted Spurious Emissions
for
Alcatel-Lucent USA Inc.**

**PCS LTE RRH 4x30 Band 25
Outdoor Transceiver System
FCC ID: AS5BBTRX-22**

Test Configuration 11
FCC Part 24 Conducted Spurious Emissions 10 MHz – 10 GHz Test Configuration 11

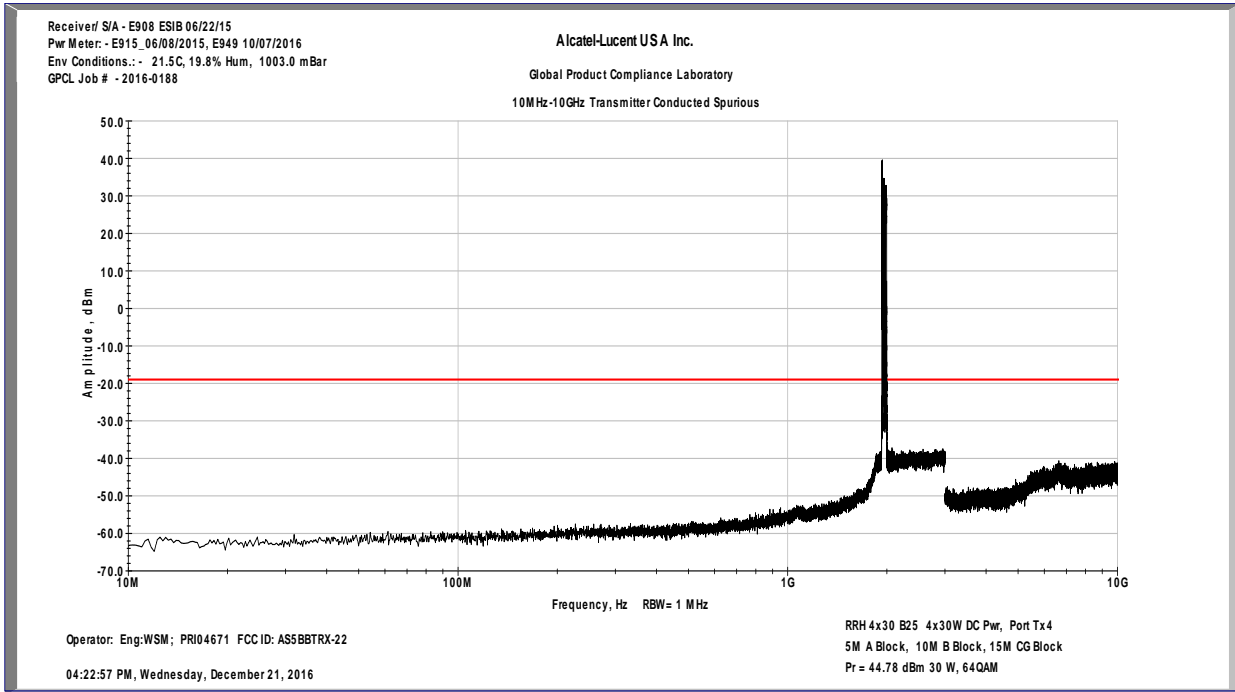

FCC Part 24 Conducted Spurious Emissions 1 GHz – 20 GHz Test Configuration 11

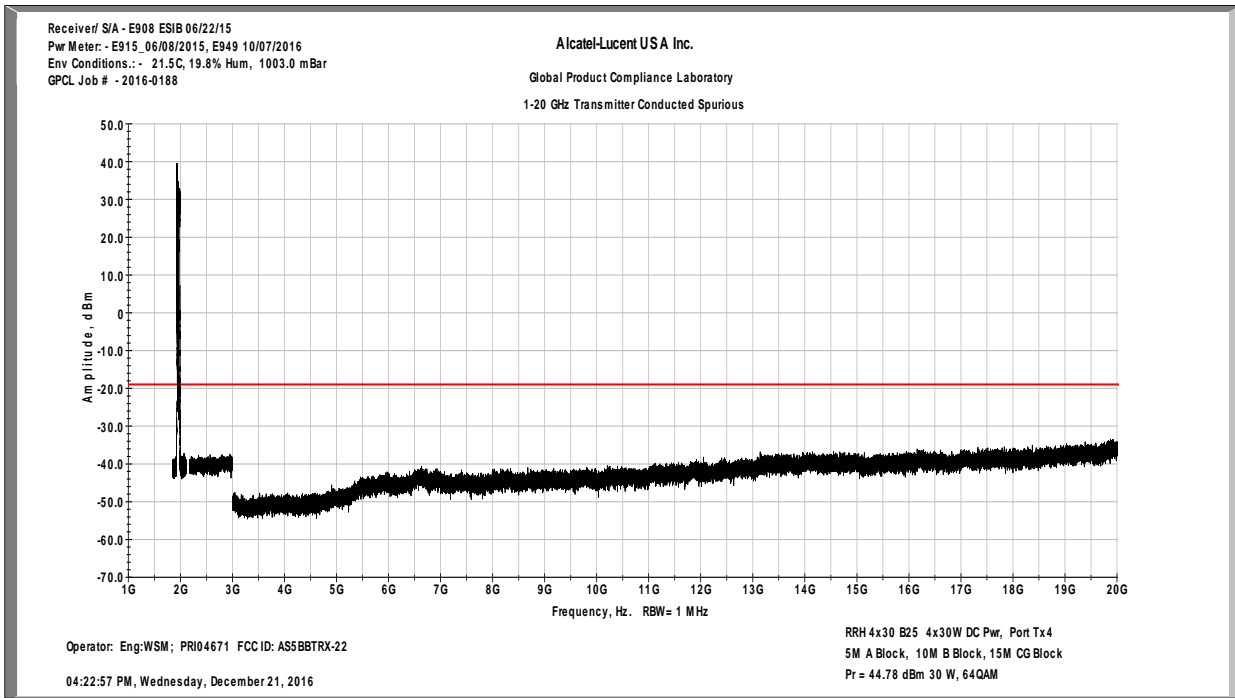

Test Configuration 15
FCC Part 24 Conducted Spurious Emissions 10 MHz – 10 GHz Test Configuration 15

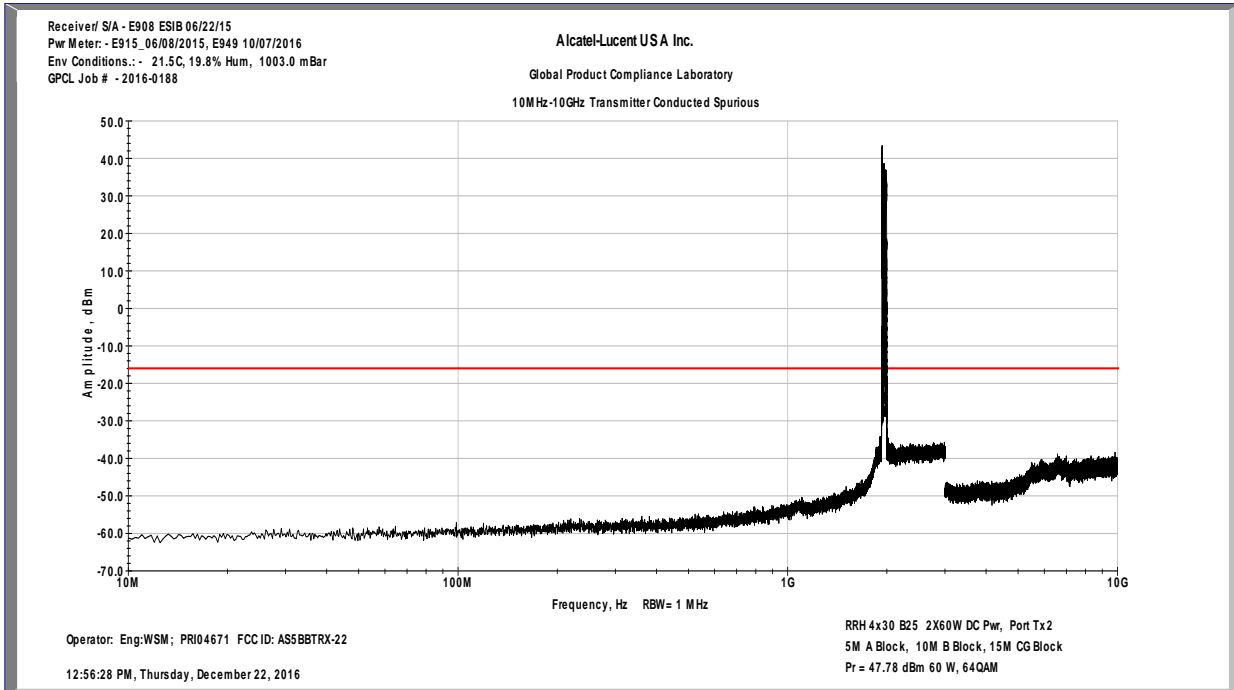

FCC Part 24 Conducted Spurious Emissions 1 GHz – 20 GHz Test Configuration 15

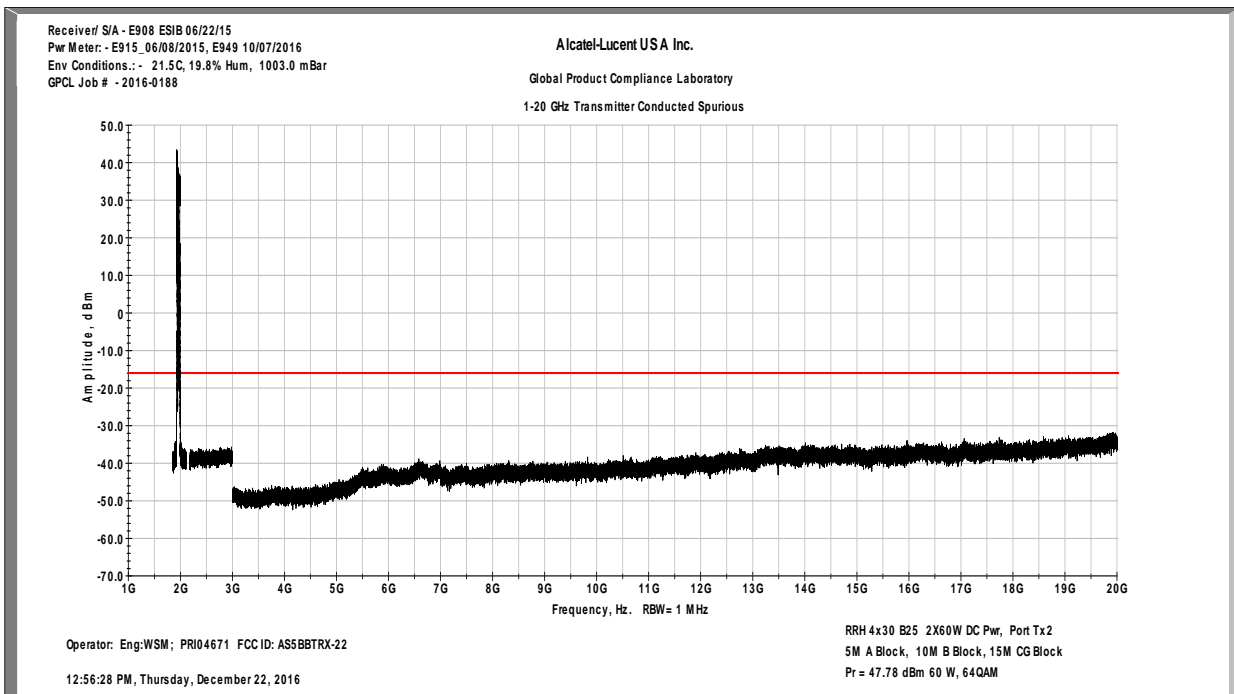

4.5 Section 2.1055 MEASUREMENT REQUIRED: FREQUENCY STABILITY

This measurement evaluates the frequency difference between the actual transmit carrier frequency and the specified transmit frequency assignment. Only the portion of the transmitter system containing the frequency determining and stabilizing circuitry need be put in an environmental chamber and subjected to the temperature variation test per FCC Section 2.1055. The unit which provides baseband signals, such as BBU (baseband unit), can be located outside the chamber if it is a separated unit.

4.5.1 Frequency Stability Results:

**This EUT was previously tested during the original filing process. There were no changes to the frequency generating or stabilizing circuitry of this product.
For this Class II Permissive Change, new data is not required.**

4.6 Section 2.1053 MEASUREMENT REQUIRED: FIELD STRENGTH OF SPURIOUS RADIATION

The field strength measurements of radiated spurious emissions were made in a FCC registered three meter semi-anechoic chamber AR-6, (Site Registration Number: 909064) and IC (Filing Number: 6933F-6) which is maintained by Nokia Bell Labs in Murray Hill, New Jersey.

The **B25 RRH 4X30** (EUT) was configured in semi-anechoic chamber AR-9 as in the normal field installation and the recommendations of ANSI C63.4–2009 were followed for EUT testing setup and cabling. The EUT was configured to operate per the E-UTRA test model specified in 3GPP TS 36.141.

The base station was configured to transmit a 4x MIMO 5 + 10 + 15 MHz LTE carrier per Test Configuration 19 with the total transmit power of 120W (50.79 dBm). All ports were terminated into non-radiating 50 Ω resistive loads. The product in the below configurations was evaluated over the 30 MHz to 20 GHz frequency range.

Table 4.5.1 EUT Configurations

Test Configuration	PCS Blocks	Active Ports	Signal Bandwidth, MHz	Modulation Q16=qpsk+16qam 64=64QAM	Total per Port Power, Watts	Radiated Emissions Pass / Fail
19	A+B+CG	Tx1-4	5+10+15	64QAM	30	Pass

Section 24.238 and 2.1053 contains the requirements for the levels of spurious radiation as a function of the EIRP of the unmodulated carrier. The reference level for the unmodulated carrier is calculated as the field produced by an isotropic radiator excited by the transmitter output power according to the following relation taken from Reference Data for Radio Engineers, page 27-7, 6th edition, IT&T Corp.

$$E = (120\pi P)^{1/2} = [(30 * P)^{1/2}] / R$$

$$20 \log (E * 10^6) - (43 + 10 \log P) = 82.23 \text{ dB } \mu\text{V/meter}$$

Where: E = Field Intensity in Volts/ meter R = Distance in meters = 3 m

P = Transmitted Power in watts = 60 W

The field strength of radiated spurious emissions measured was determined by

$$E(\text{dB}\mu\text{V/m}) = V_{\text{meas}}(\text{dB}\mu\text{V}) + \text{Cable Loss (dB)} + \text{Antenna Factor (dBi/m)}$$

Field strength measurements of radiated spurious emissions were made at a semi anechoic room of Global Product Compliance Laboratories of Nokia Bell Laboratories in Murray Hill NJ which was detailed in Section 6. The recommendations of ANSI C63.4 and ANSI C63.26 were followed for EUT testing setup, cabling, and measurement approach and procedures. All the measurement equipment used, including antennas, was calibrated in accordance with ISO 9001 process. The EUT setup diagram is given in the Figure 4.6.1. The minimum margin measured per Table 4.6.2 is more than 20dB.

4.6.1 Field Strength of Radiated Emissions Results:

For this particular test, the field strength of any spurious radiation, measured at 3m, is required to be less than 82.23 dBμV/meter. Emissions equal to or less than 62.23 dBμV/meter are not reportable and may be verified using field strength measurements with broadband antennas. Over the out of band spectrum investigated from 10 MHz to beyond the tenth harmonic of the carrier (20GHz), no reportable spurious emissions were detected. This demonstrates that the B25 RRH 4X30 / FCC ID: AS5BBTRX-22, the subject of this application, complies with Sections 2.1053, 24.238 and 2.1057 of the Rules.

Figure 4.6.1 Test Set-Up for Measurement of Radiated Spurious Emissions
Radiated Emissions Setup RRH4x30-B25 PCS

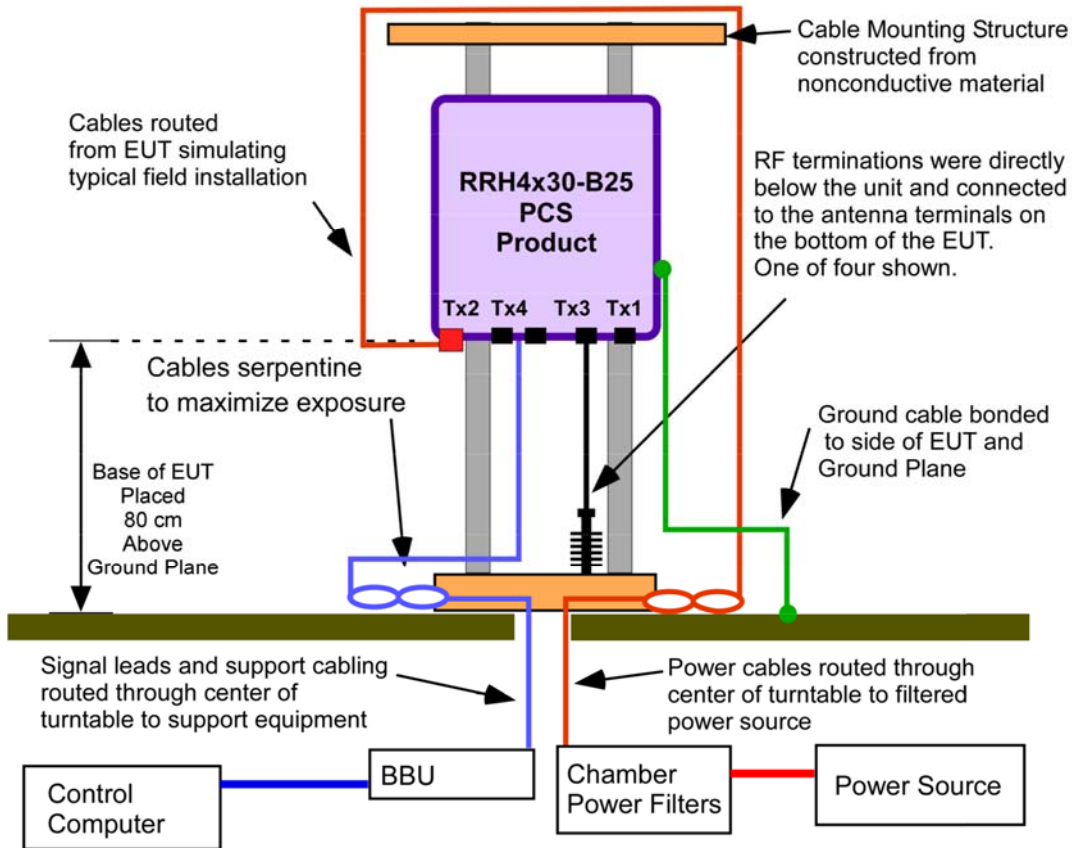

RRH 4x30-B25 PCS RE Setup
W.S. Majkowski 11-14-2016

Radiated Emissions Data

T4 Radiated Emissions 30MHz to 1 GHz Transmit Configuration 19

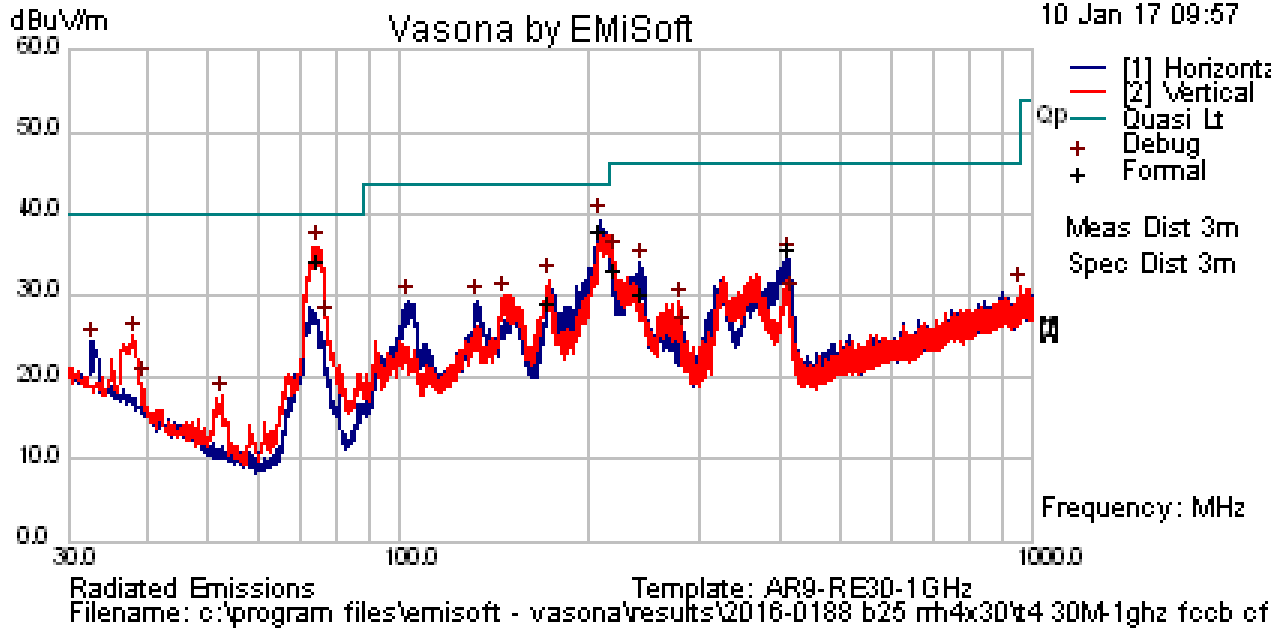

Results Title:	AR9-RE30-1GHz
File Name:	c:\program files\emisoft - vasona\results\2016-0188 b25 rrh4x30\t4 30M-1ghz fccb cf19.emi
Test Laboratory:	GPCL MH#28 AR9 22C, 28% 1004mB
Test Engineer:	MJS /FEC
Test Software:	Vasona by EMISoft, version 2.161
Equipment:	NOKIA
EUT Details:	Asset 1.0 B25 RRH-4x30 AR1.0 2x60W 5 MHz operation. (LTE RF-Assets) 3JR53349ABAA 01M
Configuration:	Powered by -48Vdc at 11.7Amps, Test Setup 19, Blocks A+B+CG, BW=5+10+15 MHz, Pwr=10W/c 4x30W MIMO, Mod= Q16, + 64 +64= Fc=1932.5+1955+1987.5MHz. SA -E907, Preamp E812, Antenna E758, 6 dB Pad E176. Tested to FCC Class B limits RE 30M-1GHz @ 3-meters Distance
Date:	2017-01-10 09:57:48

FORMAL DATA

Freq. MHz	Raw dBuV	Cable dB	Factor dB	Level dBuV/m	Emission Type	Pol H/V	Ht cm	Az deg	Limit dBuV/m	Margin dB	Pass /Fail	Comments
74.192	50.67	6.38	-24.8	32.26	Quasi Max	V	126	107	40	-7.74	Pass	
208.274	50.01	6.67	-20.6	36.12	Quasi Max	H	108	28	43.5	-7.38	Pass	46 dB of margin to Pt 24
218.428	45.11	6.7	-20.4	31.46	Quasi Max	V	121	156	46	-14.54	Pass	
411.695	42.02	7.08	-15.3	33.78	Quasi Max	H	108	327	46	-12.22	Pass	
171.998	37.86	6.61	-17.4	27.1	Quasi Max	V	112	232	43.5	-16.4	Pass	
240.484	38.82	6.76	-17.3	28.32	Quasi Max	H	132	124	46	-17.68	Pass	

PREVIEW DATA

Freq. MHz	Raw dBuV	Cable dB	Factor dB	Level dBuV/m	Emission Type	Pol H/V	Ht cm	Az deg	Limit dBuV/m	Margin dB	Pass /Fail	Comments
74.2485	54.39	6.38	-24.8	35.99	Preview	V	100	135	40	-4.01	Pass	
208.244	53.16	6.67	-20.6	39.28	Preview	H	100	45	43.5	-4.22	Pass	
218.441	48.71	6.7	-20.4	35.06	Preview	V	100	135	46	-10.94	Pass	
411.884	42.81	7.08	-15.3	34.58	Preview	H	100	315	46	-11.42	Pass	
171.98	42.71	6.61	-17.4	31.95	Preview	V	100	225	43.5	-11.55	Pass	
240.469	44.37	6.76	-17.3	33.87	Preview	H	100	90	46	-12.13	Pass	
76.8457	44.99	6.39	-24.4	27.04	Preview	V	100	180	40	-12.96	Pass	
146.008	37.24	6.56	-13.9	29.96	Preview	V	100	315	43.5	-13.54	Pass	
103.01	40.93	6.47	-18	29.4	Preview	H	300	0	43.5	-14.1	Pass	
132.926	37.09	6.54	-14.3	29.37	Preview	H	200	45	43.5	-14.13	Pass	
37.984	37	6.2	-18	25.17	Preview	V	100	0	40	-14.83	Pass	
958.16	31.58	7.73	-8.29	31.02	Preview	V	100	270	46	-14.98	Pass	
32.6934	33.51	6.16	-15.3	24.42	Preview	H	385	0	40	-15.58	Pass	
419.387	37.8	7.09	-15.1	29.77	Preview	H	100	315	46	-16.23	Pass	
277.599	40.56	6.84	-18.2	29.19	Preview	V	100	225	46	-16.81	Pass	
281.062	37.09	6.85	-18.2	25.74	Preview	H	200	315	46	-20.26	Pass	
39.2345	31.87	6.21	-18.7	19.41	Preview	V	185	90	40	-20.59	Pass	
52.3166	35.33	6.29	-23.8	17.79	Preview	V	100	225	40	-22.21	Pass	

Note: Preview data was measured using a peak detector to identify frequencies of interest for formal measurement. Formal data consist of all frequencies in the preview list within 6 dB of specification limit or the top six frequencies. Failure in preview data does not necessarily constitute failure in formal data.

T1b Radiated Emissions 1GHz to 3 GHz Transmit Configuration 19

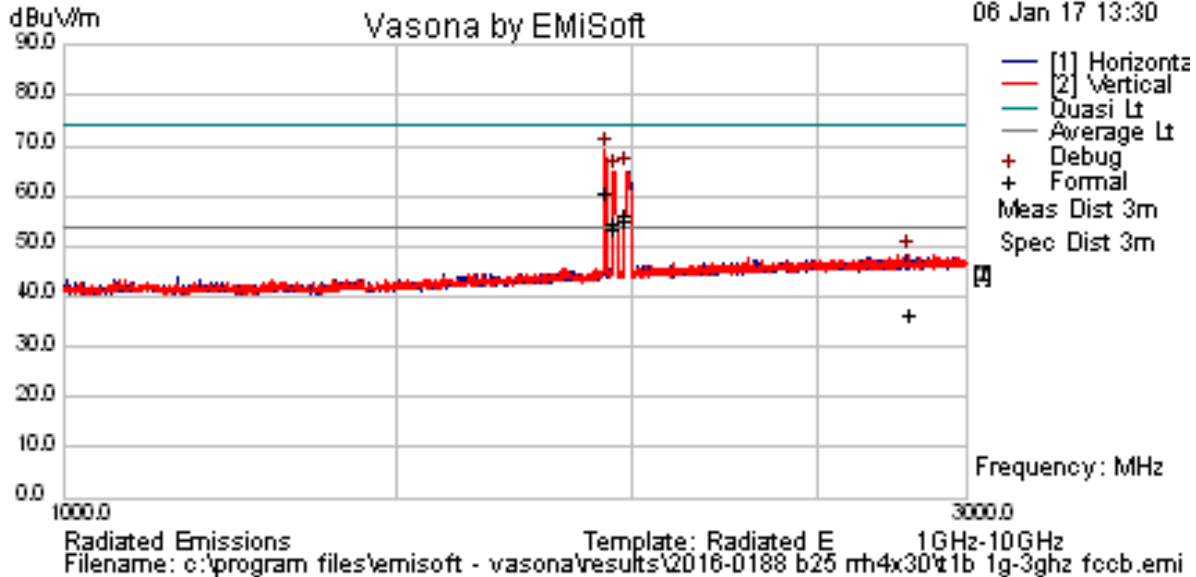

Results Title:	Radiated E 1GHz-10GHz
File Name:	c:\program files\emisoft - vasona\results\2016-0188 b25 rrh4x30\t1b 1g-3ghz fccb.emi
Test Laboratory:	GPCL MH#28 AR9 22C, 28% 1004mB
Test Engineer:	MJS
Test Software:	Vasona by EMISoft, version 2.161
Equipment:	NOKIA
EUT Details:	Asset 1.0 B25 RRH-4x30 AR1.0 2x60W 5 MHz operation. (LTE RF-Assets) 3JR53349ABAA 01M
Configuration:	Powered by -48Vdc at 11.7Amps, Test Setup 19, Blocks A+B+CG, BW=5+10+15 MHz, Pwr= 10W/c 4x30W MIMO, Mod= Q16, + 64 +64= Fc=1932.5+1955+1987.5MHz. SA -E736, Preamp E447.6 dB Pad E176. Tested to FCC Class B limits RE 1G-3GHz @ 3-meters, Pre Scan and Formals 1M BW's.
Date:	2017-01-06 13:30:52

FORMAL DATA

Freq. MHz	Raw dBuV	Cable dB	Factor dB	Level dBuV/m	Emission Type	Pol H/V	Ht cm	Az deg	Limit dBuV/m	Margin dB	Pass /Fail	Comments
1933.89	59.41	7.88	-9.22	58.06	AvgMax	V	119	171	54	4.06	N/A	TX
1984.93	53.79	7.89	-8.94	52.73	AvgMax	H	99	154	54	-1.27	N/A	TX
1955.03	51.91	7.88	-9.1	50.69	AvgMax	V	208	181	54	-3.31	N/A	TX
1933.89	59.4	7.88	-9.22	58.06	Quasi Max	V	119	171	74	-15.94	N/A	TX
1984.93	54.57	7.89	-8.94	53.52	Quasi Max	H	99	154	74	-20.48	N/A	TX
2801.26	31.82	8.7	-7.02	33.5	AvgMax	V	273	309	54	-20.5	Pass	
1955.03	53.23	7.88	-9.1	52	Quasi Max	V	208	181	74	-22	N/A	TX
2801.26	32.28	8.7	-7.02	33.96	Quasi Max	V	273	309	74	-40.04	Pass	

PREVIEW DATA

Freq. MHz	Raw dBuV	Cable dB	Factor dB	Level dBuV/m	Emission Type	Pol H/V	Ht cm	Az deg	Limit dBuV/m	Margin dB	Pass /Fail	Comments
1955.66	65.98	7.88	-9.1	64.76	Preview	V	200	176	54	10.76	N/A	TX
1933.95	70.36	7.88	-9.22	69.01	Preview	V	200	176	54	15.01	N/A	TX
1981.38	66.16	7.89	-8.96	65.08	Preview	H	100	308	54	11.08	N/A	TX
2800.95	46.65	8.7	-7.02	48.34	Preview	V	200	44	54	-5.66	Pass	

Note: Preview data was measured using a peak detector to identify frequencies of interest for formal measurement. Formal data consist of all frequencies in the preview list within 6 dB of specification limit or the top six frequencies. Failure in preview data does not necessarily constitute failure in formal data.

T2a Radiated Emissions 3 to 18 GHz Transmit Configuration 19

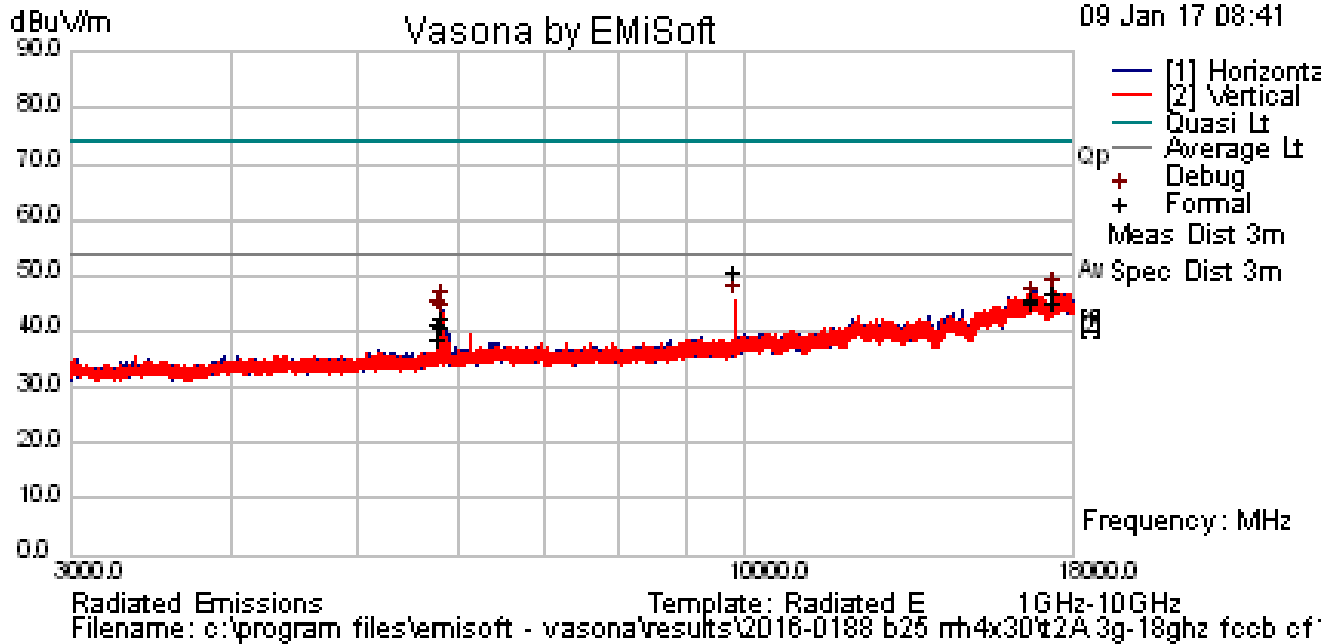

Results Title:	Radiated E 3GHz-18GHz
File Name:	c:\program files\emisoft - vasona\results\2016-0188 b25 rrh4x30\t2A 3g-18ghz fccb cf19.emi
Test Laboratory:	GPCL MH#28 AR9 22C, 28% 1004mB
Test Engineer:	MJS /FEC
Test Software:	Vasona by EMISoft, version 2.161
Equipment:	NOKIA
EUT Details:	Asset 1.0 B25 RRH-4x30 AR1.0 2x60W 5 MHz operation. (LTE RF-Assets) 3JR53349ABAA 01M
Configuration:	Powered by -48Vdc at 11.7Amps, Test Setup 19, Blocks A+B+CG, BW=5+10+15 MHz, Pwr= 10W/c 4x30W MIMO, Mod= Q16, + 64 +64= Fc=1932.5+1955+1987.5MHz. SA -E736, Preamp E447,PCS HPF E986. Tested to FCC Class B limits RE 3G-18GHz @ 3-meters, Pre Scan lower BW's and Formals 1M BW's.
Date:	2017-01-09 08:41:27

FORMAL DATA

Freq. MHz	Raw dBuV	Cable dB	Factor dB	Level dBuV/m	Emission Type	Pol H/V	Ht cm	Az deg	Limit dBuV/m	Margin dB	Pass /Fail	Comments
9830.41	44.37	6.12	-2.64	47.85	AvgMax	V	100	239	54	-6.15	Pass	>34 dB of margin to Pt 24
16807.5	29.4	8.98	4.14	42.52	AvgMax	H	372	179	54	-11.48	Pass	
17441.1	28.92	9.24	4.16	42.32	AvgMax	V	275	19	54	-11.68	Pass	
5818.97	37.96	5.05	-3.42	39.59	AvgMax	V	233	330	54	-14.41	Pass	
5846.87	36.58	5.07	-3.39	38.25	AvgMax	H	194	34	54	-15.75	Pass	
5796.72	34.08	5.04	-3.44	35.68	AvgMax	H	111	220	54	-18.32	Pass	
9830.41	44.51	6.12	-2.64	47.98	Quasi Max	V	100	239	74	-26.02	Pass	
17441.1	30.96	9.24	4.16	44.36	Quasi Max	V	275	19	74	-29.64	Pass	
16807.5	30.14	8.98	4.14	43.26	Quasi Max	H	372	179	74	-30.74	Pass	
5818.97	37.96	5.05	-3.42	39.59	Quasi Max	V	233	330	74	-34.41	Pass	
5796.72	36.91	5.04	-3.44	38.51	Quasi Max	H	111	220	74	-35.49	Pass	
5846.87	36.58	5.07	-3.39	38.25	Quasi Max	H	194	34	74	-35.75	Pass	

PREVIEW DATA

Freq. MHz	Raw dBuV	Cable dB	Factor dB	Level dBuV/m	Emission Type	Pol H/V	Ht cm	Az deg	Limit dBuV/m	Margin dB	Pass /Fail	Comments
19755.7	43.5	7.3	7.91	58.71	Debug	V	100	0	63.5	-4.79	Pass	
18572.4	42.13	7	7.4	56.52	Debug	V	203	352	63.5	-6.98	Pass	
18281.8	42.22	6.91	6.98	56.11	Debug	V	203	352	63.5	-7.39	Pass	
19339.6	41.81	7.2	8.13	57.14	Debug	V	203	352	63.5	-6.36	Pass	
19573.7	43	7.26	8.07	58.33	Debug	V	203	352	63.5	-5.17	Pass	
19253.8	42.17	7.18	8.12	57.47	Debug	V	203	352	63.5	-6.03	Pass	

Note: Preview data was measured using a peak detector to identify frequencies of interest for formal measurement. Formal data consist of all frequencies in the preview list within 6 dB of specification limit or the top six frequencies. Failure in preview data does not necessarily constitute failure in formal data.

4.7 List of Test Equipment

4.7.1 List of Radiated Emissions Test Equipment

The following equipment was used for the measurement of Radiated Emissions.

Asset ID	Manufacturer	Type	Details	Model	Serial	Calibration Date	Calibration Due
E766	A.H. Systems Inc.	Biological Antenna	25 - 2000 MHz	SAS-521-2	457	12/29/14	1/29/17
E513	EMC Test Systems	Horn Antenna	Double Ridged Horn 18-40 GHz	3116	2539	3/19/15	3/19/17
E489	EMC Test Systems	Multi-Device Controller	Controller	2090	0004-1507	N/A	N/A
E1074	ETS Lindgren	Horn Antenna	Double-Ridged Waveguide Horn 1-18 GHz	3117	135194	11/25/14	1/25/17
E447	Hewlett Packard	Pre-Amplifier	Preamplifier 1-26.5 GHz	8449B	3008A01384	12/17/15	12/17/17
E907	Rohde & Schwarz	Test Receiver	EMI (20Hz to 40 GHz)- 150 +30dBm	ESIB40	100101	9/22/15	9/22/17
E812	Sonoma Instrument Co.	Amplifier	9kHz-1GHz	310N	186744	8/10/16	8/10/18
E986	Trilithic	High Pass Filter	PCS	5HC2850/18 050-1.8-KK	PCS-HPF-5	11/5/16	11/5/17
E176	Weinschel	Attenuator	6 dB , 2 Watt DC-12.5 GHz	6-Feb	BC0255	10/28/15	10/28/17

4.7.2 List of Antenna Port Test Equipment

The following equipment was used for measurement performed at the products Antenna Port.

Asset ID▼	Manufacturer	Type	Details	Model	Serial	Calibration Date	Calibration. Due Date
E908	Rohde & Schwarz	Test Receiver	EMI (20Hz to 40 GHz) -150 +30dBm	ESIB40	100100	6/22/15	6/22/17
E915	Agilent Technologies	Power Meter	P-Series Dual Channel	N1912A	GB44440226	6/8/16	6/8/18
E949	Agilent Technologies	Power Sensor	-35 - +20 dBm 50 MHz -18 GHz	N1921A	MY45242502	10/7/16	10/7/17
	Keysight	MXA Signal Analyzer	20 Hz-3.6 GHz	N9020A	MY50510383	5/7/15	5/7/17
E980	Trilithic	Low Pass Filter	PCS	10LC1790-3-AA	PCS-LPF-12	11/5/16	11/5/17
E988	Trilithic	High Pass Filter	PCS	5HC2850/180 50-1.8-KK	PCS-HPF-11	11/5/16	11/5/17

Antenna Port Test Coupler-White Mule LP (Verified as a unit)

E1220	Hewlett Packard	Attenuator	70dB Digital Attenuator	8495B	157170	11/5/16	11/5/17
E1221	Hewlett Packard	Attenuator	11 dB Digital Attenuator	8494B	157171	11/5/16	11/5/17
E1222	Hewlett Packard	Directional Coupler	Dual directional coupler 2-18GHz	772D	02839A0073	11/5/16	11/5/17
E1223	Weinschel	Attenuator	DC-18GHz 30dB 150W	6528-30-34-LIM	BN4170	11/5/16	11/5/17
E1229	Weinschel	Attenuator	6dB Attenuator 25W	46-6-34	BH9330	11/5/16	11/5/17
E1258	Weinschel	Directional Coupler	Directional coupler 1-6 GHz	1540R-10	1027	11/5/16	11/5/17

4.8 PHOTOGRAPHS OF THE TEST SETUPS

Response:

The photographs of the test setups for the B25 RRH 4x30W, FCC ID; FCC ID: AS5BBTRX-22 are attached below.

4.8.1 Transmitter Antenna Port Measurements

Test Setup for RF Power, Modulation, PAR, Occupied Bandwidth and Conducted Spurious Emissions.

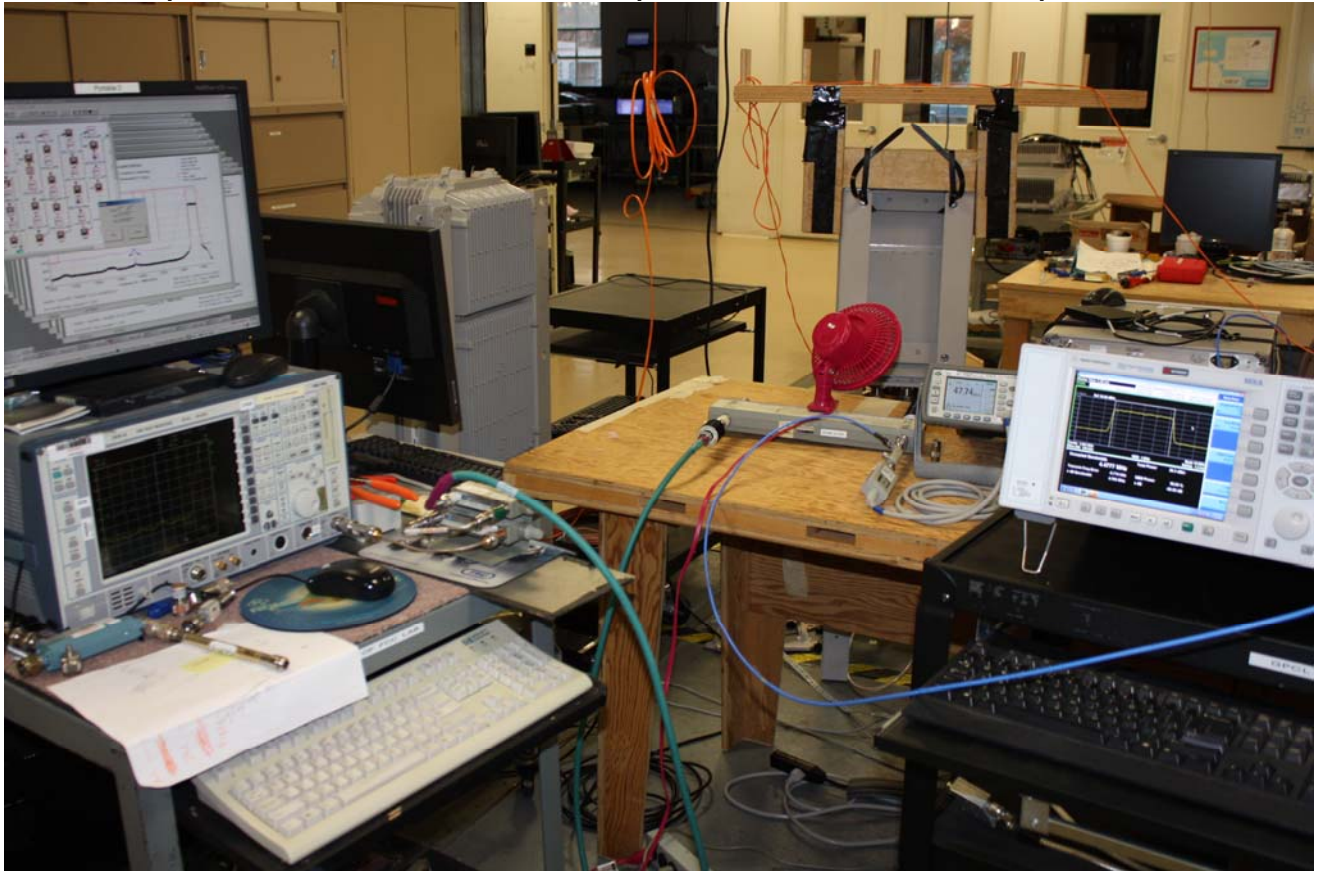

4.8.2 Radiated Test Setup

Radiated Test Setup 30 MHz – 1 GHz

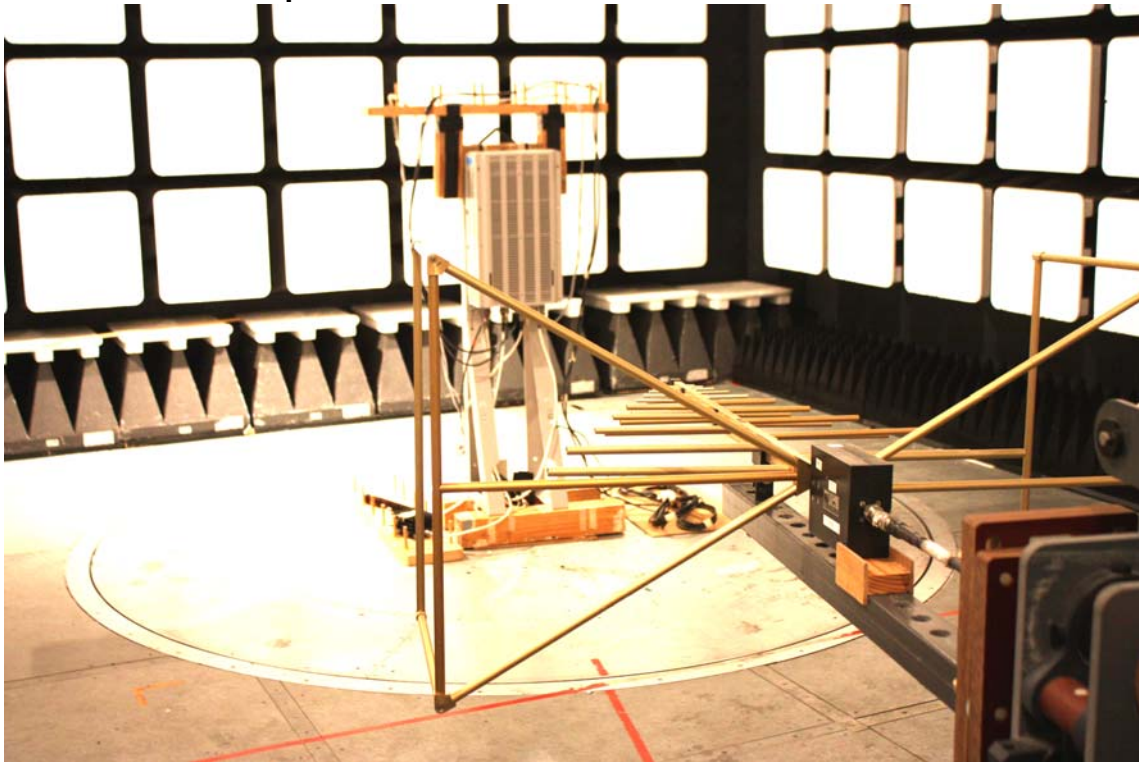

Radiated Test Setup 1 GHz – 18 GHz

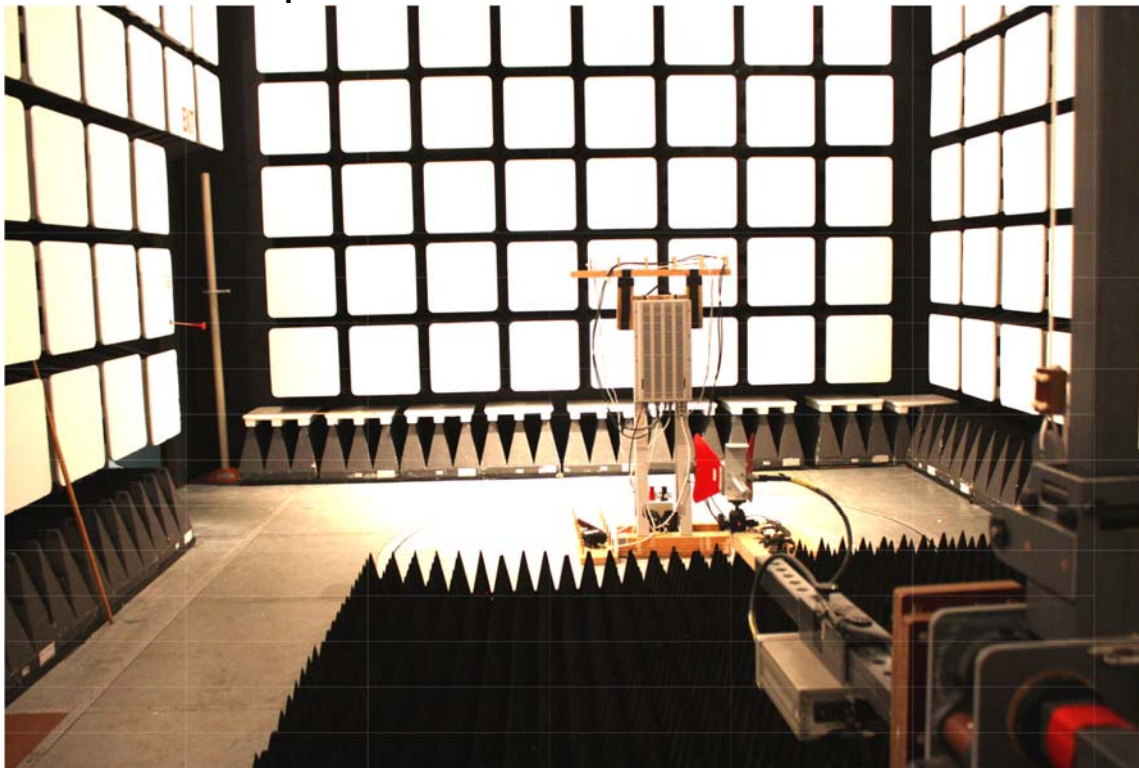

Radiated Test Setup 18 GHz- 20 GHz

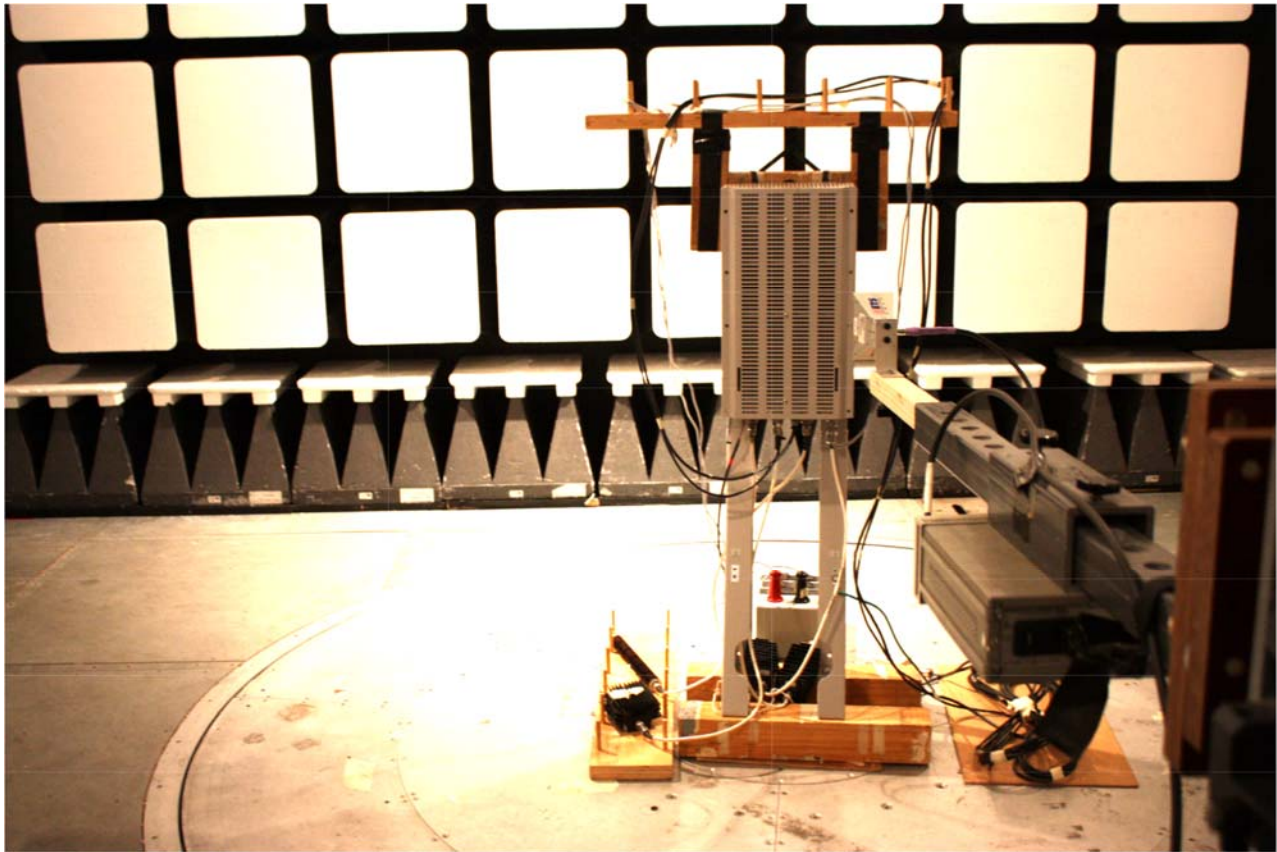

4.9 FACILITIES AND ACCREDITATION

All measurement facilities at Nokia, Global Product Compliance Laboratory (GPCL) used to collect the measurement data in the test report are located at 600-700 Mountain Avenue, Murray Hill, New Jersey 07974-0636 USA.

The field strength measurements of radiated spurious emissions were made in a FCC registered three meter semi-anechoic chamber AR-9, (**Registration Number: US5302**) and IC (Filing Number: 6933F) which is maintained in Murray Hill, New Jersey. The sites were constructed and are continuously in conformance with the requirements of ANSI C63.4 and CISPR Publication 22.

Nokia Global Product Compliance Laboratory is accredited with the US Department of Commerce National Institute of Standards and Technology's National Voluntary Laboratory Accreditation Program (NVLAP) (NVLAP LAB Code 100275-0) for satisfactory compliance with criteria established in Title 15, Part 7 Code of Federal Regulations for offering test services for selected test methods in Electromagnetic Compatibility; Voluntary Control Council for Interference (VCCI), Japan; Australian Communications and Media Authority (ACMA). The laboratory is ISO 9001:2008 Certified.

United States Department of Commerce
National Institute of Standards and Technology



Certificate of Accreditation to ISO/IEC 17025:2005

NVLAP LAB CODE: 100275-0

Nokia, Global Product Compliance Lab
Murray Hill, NJ

*is accredited by the National Voluntary Laboratory Accreditation Program for specific services,
listed on the Scope of Accreditation, for:*

Electromagnetic Compatibility & Telecommunications

*This laboratory is accredited in accordance with the recognized International Standard ISO/IEC 17025:2005.
This accreditation demonstrates technical competence for a defined scope and the operation of a laboratory quality
management system (refer to joint ISO-ILAC-IAF Communique dated January 2009).*

2016-09-09 through 2017-09-30
Effective Dates



For the National Voluntary Laboratory Accreditation Program