

FCC Test Report

Alcatel-Lucent PCS LTE 9764 Metro Cell Metro Dock Outdoor Transceiver System

FCC ID: AS5BBTRX-21

11. Exhibit 11 FCC Filing Test Report

11.1 Listing of Required Measurements

The data required by Section 2.1046 through 2.1057, inclusive, measured in accordance with the procedures set out in Section 2.1041.

Response: In Alcatel-Lucent’s PCS LTE 9764 Metro Cell Outdoor Transceiver System / FCC ID: AS5BBTRX-21, the lowest clock frequency is the 10 MHz reference oscillator. Conducted spurious measurements were performed over the range of 10 MHz to 20 GHz which is above the tenth harmonic of the transmit frequency range.

The following pages document the data required for the Product Certification authorization of the PCS LTE 9764 Metro Cell Outdoor Transceiver System / FCC ID: AS5BBTRX-21, measured in accordance with the procedures set out in Section 2.1041 of the Rules. The Unit under Test, UUT Herein, was identified as serial number ALLU-ST143440030.

Each required measurement and its corresponding exhibit number are:

<u>FCC Filing Exhibit</u>	<u>FCC Regulation</u>	<u>Description</u>
Exhibit 12	Section 2.1046	Measurement of Radio Frequency Power Output
Exhibit 13	Section 2.1047	Measurement of Modulation Characteristics
Exhibit 14	Section 2.1049	Measurement of Occupied Bandwidth
Exhibit 15	Section 2.1051	Measurement of Spurious Emissions at Antenna
Exhibit 16	Section 2.1053	Field Strength of Spurious Radiation
Exhibit 17	Section 2.1055	Measurement of Frequency Stability

11.2 Test Equipment

11.2.1 Antenna Port Measurements Test Equipment

The following Equipment used for RF Power, Modulation, Occupied bandwidth, Conducted Spurious and Radiated Spurious Measurements. Antenna Port Measurements Test Equipment

<u>Equipment</u>	<u>Description</u>	<u>Reference Num</u>	<u>Calibration Date</u>
Power Meter:	Agilent N1912A P Series Power Meter	E949	03/26/2014
Power Head	Agilent N1921A 0.05-18 GHz Wideband Power Sensor	E950	02/12/2014
EMC Receiver / SA	Rohde & Schwarz ESIB-40	E907 / 1000101	09/20/2013 (2yr)
Code Domain Analyzer	Agilent E4440A PSA with 896012A VSA Software.	E935/ MY45304655	09/16/2014
Computer Controller:	EG Technology, Intel Pentium PC w/WIN 2000 OS	POR-2, 4 & 6	N/A
Low Pass Filter:	10 MHz-1.93 GHz, Custom manufactured	E980 LPF-12	08/25/14
High Pass Filters:	3.99-20 GHz, Custom manufactured	E988 PCS HPF-12	10/17/14

11.2.2 Antenna Port Measurements Test Coupler

The RF Test coupler used for antenna port conducted testing is maintained calibration verified as a unit. The individual components are listed below. It is identified as White LP 50W-Mule-Lim for White-Low Power-50W- Multi Use Laboratory Equipment (MULE)-Low Intermod.

<u>Equipment</u>	<u>Description</u>	<u>Reference Num</u>	<u>Calibration Date</u>
Directional Coupler:	HP 772D 2-18 GHz	s/n 772D	08/25/14
Attenuator, Variable	HP 8494B DC-18 GHz digital attenuator	MY42140028	08/25/14
Attenuator, Variable	HP 8495B DC-18 GHz digital attenuator	MY42140034	08/25/14
Attenuator, Fixed	MCE/Weinschel 6528-30-34 LIM 150W	BN4170	08/25/14
Test Cables:	Low loss test cables custom mfg.	White A, B & C	08/25/14

11.2.3 Radiated Spurious Emissions Equipment

Manufacturer	Model Number	Serial Number	Type	Description	GPCL ID	Last Cal	Interval
A.H. Systems Inc.	SAS-521-2	457	Biological Antenna	25 - 2000 MHz	E766	12/26/2012	24
Hewlett Packard	8593E	3911A04009	Spectrum Analyzer	9 KHz-22 GHz	E375	2/18/2013	24
Sonoma Instrument Co.	310N	186744	Amplifier	9 kHz-1GHz	E812	8/21/2013	12
Weinschel	2-6	BW2239	Attenuator	6 dB DC-18GHz 5 Watt	E890	6/5/2013	24
Hewlett Packard	8449B	3008A01270	Pre-Amplifier	Preamplifier 1-26.5 GHz	E376	12/22/2013	24
Rohde & Schwarz	ESIB40	100100	Test Receiver	20Hz to 40 GHz	E908	6/12/2013	24
EMCO	3115	9903-5769	Horn Antenna	Double Ridged Horn 1-18 GHz	E393	1/30/2013	24
ETS Lindgren	3117	135194	Horn Antenna	Double-Ridged Waveguide Horn 1-18 GHz	E1074	11/19/2012	24
EMC Test Systems	3116	2539	Horn Antenna	Double Ridged Horn 18-40 GHz	E513	3/22/2013	24

12. Exhibit 12 MEASUREMENT OF RADIO FREQUENCY POWER OUTPUT

12.1 SECTION 2.1046 Measurements required: RF power output

For 5 MHz LTE transmit carrier operation, the **PCS LTE 9764 Metro Cell Outdoor Transceiver System** is specified to provide a continuous maximum power output of 2 Watt at each of its two transmit antenna terminals (33 dBm +2/-4 dB for each of the carriers). It also has a minimum power output at the antenna terminals of 0.02 Watts (13.0 dBm +2 / -4 dB). This power capability was demonstrated across the PCS downlink Band of 1930 MHz to 1990 MHz.

In order to adequately evaluate performance, the occupied bandwidth was measured with each of the sub-carrier modulation factors and co-plotted. The applied signal from an **PCS LTE 9764 Metro Cell Outdoor Transceiver System / AS5BBTRX-21**, met the recommended characteristics as defined in **3GPP TS 36.211 V9.1.0 (2010-03) titled: 3rd Generation Partnership Project; Technical Specification Group Radio Access Network; Evolved Universal Terrestrial Radio Access (E-UTRA); Physical Channels and Modulation (Release 9)**.

The power was set to the specified 2 W maximum at each measurement frequency to verify the spectral performance at that power level at each specific frequency of interest. Power was also verified for the QPSK and 64QAM modulation configurations. The 99%/-26dB signal bandwidth was measured using the setup of Figure 14A for channels **50**. The measurement performed with a resolution bandwidth of 300 kHz verified the signal is within the parameters of the emissions designator and is documented below.

The test arrangements used to measure the radio frequency power output of the **Alcatel-Lucent's PCS LTE 9764 Metro Cell Outdoor Transceiver System / AS5BBTRX-21** is on the following page. Measurements were made respectively at each frequency where Occupied Bandwidth measurements were performed and compliance was documented.

12.2 Test Equipment

The test equipment used was as listed in section 11.2.1 for Antenna Port Measurements Test Equipment.

Exhibit 12 RF Power Test Configuration

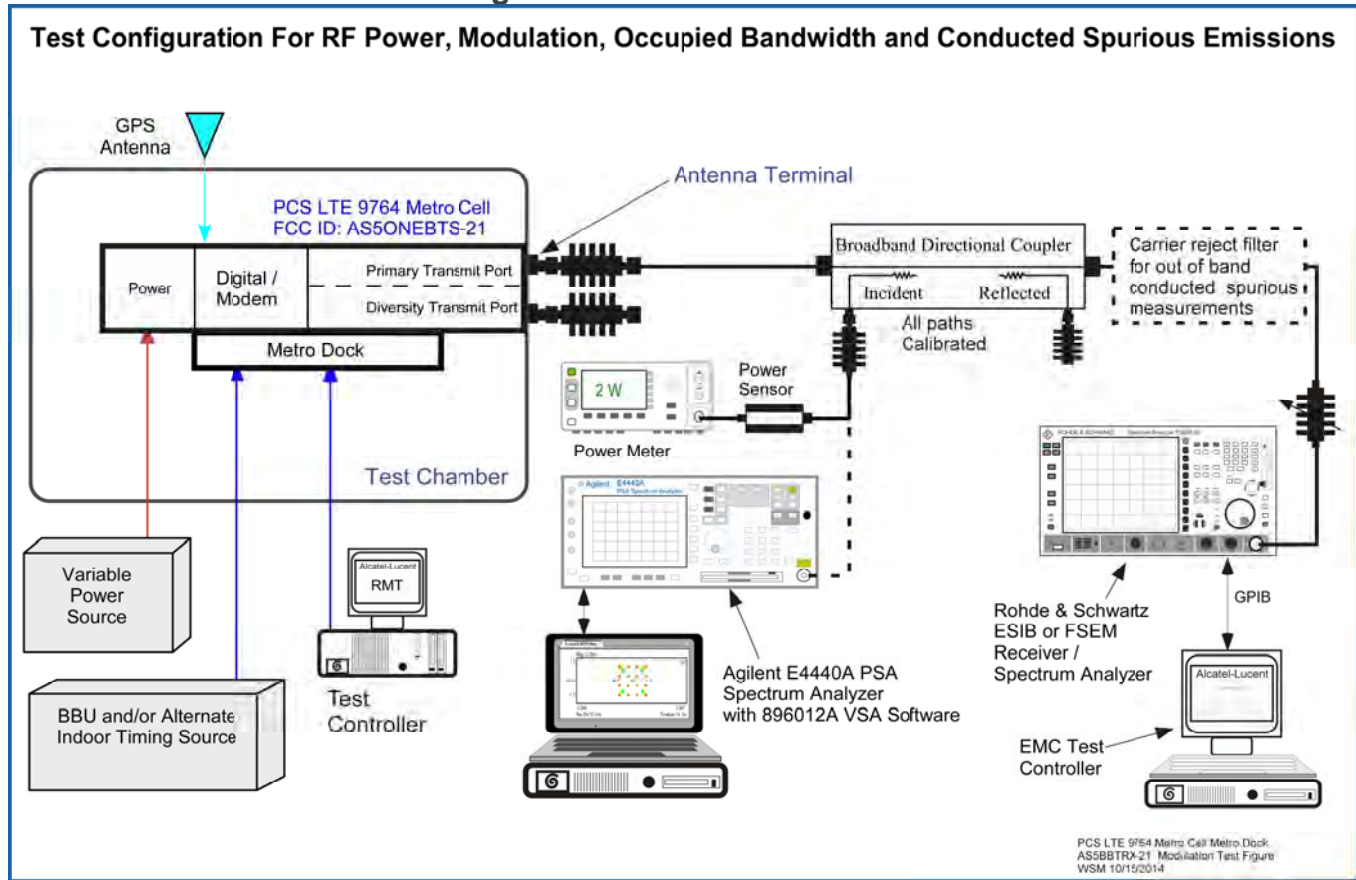

PCS - Block	PCS - Channels	Number of Primary carriers	Power, W	Results Primary Terminal RF Power	Number of Diversity carriers	Power, W	Results Diversity Terminal RF Power
A	50	1	2	Compliant	1	2	Compliant
A	250	1	2	Compliant	1	2	Compliant
D	350	1	2	Compliant	1	2	Compliant
B	450	1	2	Compliant	1	2	Compliant
B	650	1	2	Compliant	1	2	Compliant
E	750	1	2	Compliant	1	2	Compliant
F	850	1	2	Compliant	1	2	Compliant
C	950	1	2	Compliant	1	2	Compliant
C	1150	1	2	Compliant	1	2	Compliant

RESULTS:

The **PCS LTE 9764 Metro Cell Outdoor Transceiver System / AS5BBTRX-21** was configured in the test setup shown in Figure 12A. For the Primary and Diversity antenna ports the **LTE 9764 Metro Cell** delivered a minimum of 2 Watts +2/-0 dB when measured at the antenna output connection. This data is tabulated above and was recorded on the Occupied Bandwidth Data Sheets for “Left edge” and “Right Edge” of each frequency Block.

13. Exhibit 13 MEASUREMENT OF MODULATION CHARACTERISTICS

The modulation characteristics and accuracy of the **PCS LTE 9764 Metro Cell Outdoor Transceiver System / AS5BBTRX-21** output signal is a function its **Digital Analog and Power Amplifier** assembly.

13.1 SECTION 2.1047 Measurements required: Modulation

The LTE spectrum while appearing similar to CDMA differs greatly in complexity . The modulation used in evaluating the **PCS LTE 9764 Metro Cell / AS5BBTRX-21** are described in the pertinent standards documents which include **3GPP TS 36.211 V9.1.0 (2010-03) titled: 3rd Generation Partnership Project; Technical Specification Group Radio Access Network; Evolved Universal Terrestrial Radio Access (E-UTRA); Physical Channels and Modulation (Release 9)**. The modulation is Orthogonal Frequency Division Multiple Access (OFDMA) which is processed into an uplink IF signal. The input data stream is divided into several parallel sub-streams of reduced data rate and each sub-stream is transmitted on a separate orthogonal sub-carrier. The sub-carriers are modulated using either QPSK, 16QAM or 64QAM. There is no single measure of the modulation quality other than to verify that the subcarrier modulation constellations visual orientation match the symbol and amplitude criteria is consistent with QPSK, 16QAM and 64QAM.

Measurements

13.2 Results

The **PCS LTE 9764 Metro Cell Outdoor Transceiver System** was configured in the test setup shown in Figure 13A. The antenna connection output was evaluated with an Agilent Transmitter Analyzer consisting of an Agilent E4440A PSA Spectrum Analyzer with 896012A VSA Software. Measurements were performed at the PCS Channels shown in table 13.2.

The 99%/-26 dB Occupied Signal Bandwidth was also measured at 30 kHz and 300 kHz and is documented below.

13.2.1 Results Summary

For each of the PCS channels tested, the **PCS LTE 9764 Metro Cell Outdoor Transceiver System** modulated sub-carriers constellations were consistent for the modulation type. All of the modulation plots include the CCDF plot which indicates the Peak to Average Ratio (PAR) of the transmitted signal. For all measurements the PAR was between 8 and 11 dB which is compliant with the CFR which specifies that the PAR be less than 13 dB. The **PCS LTE 9764 Metro Cell Outdoor Transceiver System** transmit signal modulation parameters and constellation for PCS channel 50 is shown in Figures 13B and 13C below for QPSK, and 64QAM.

Figure 13A

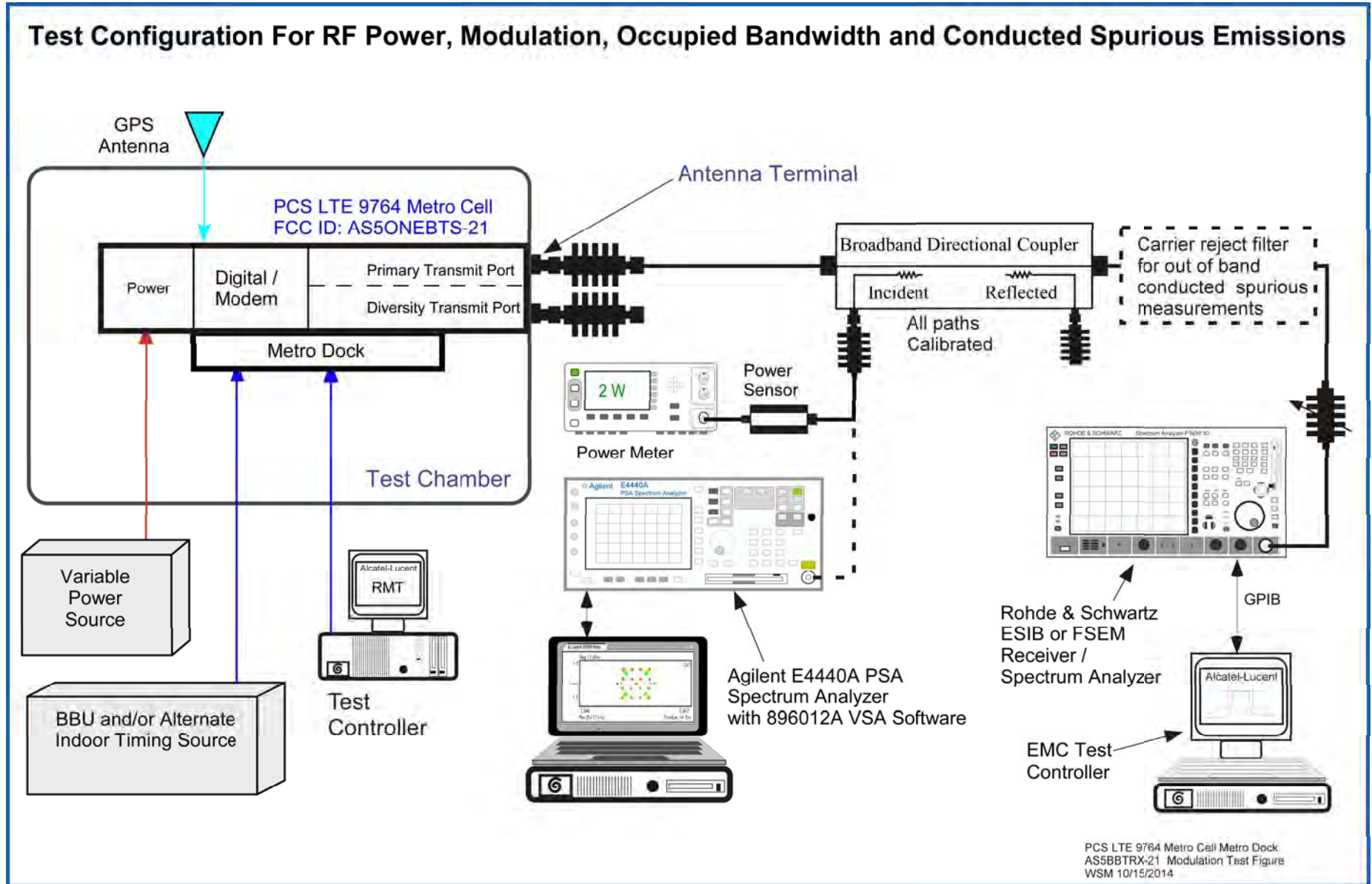

Figure 13B Code Domain A Block, Channel 50 QPSK

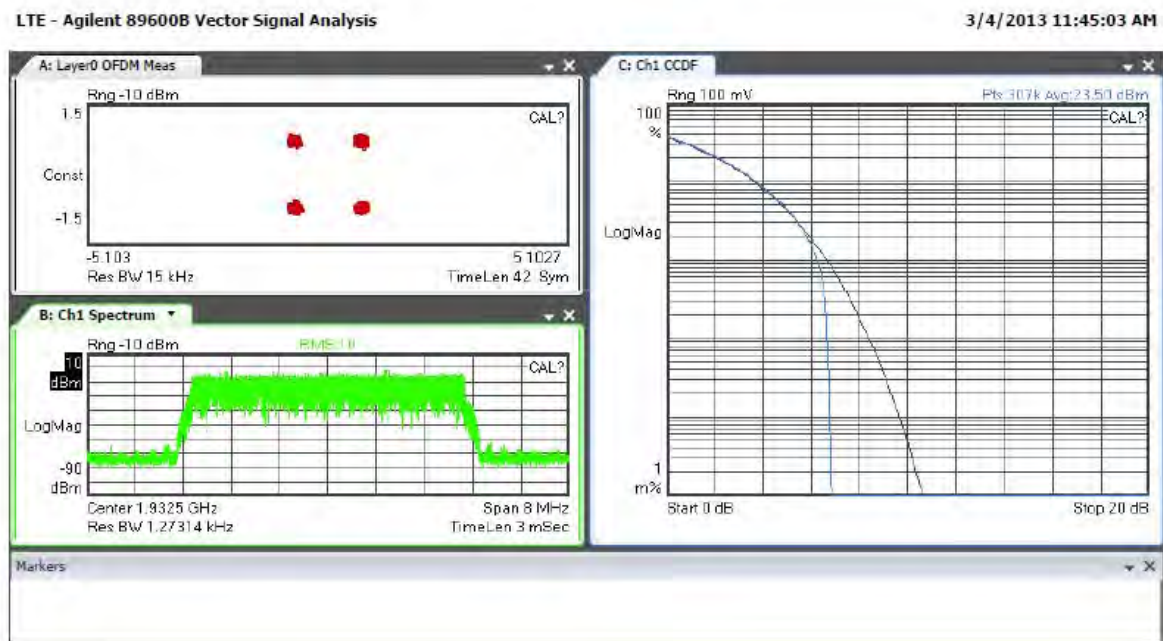
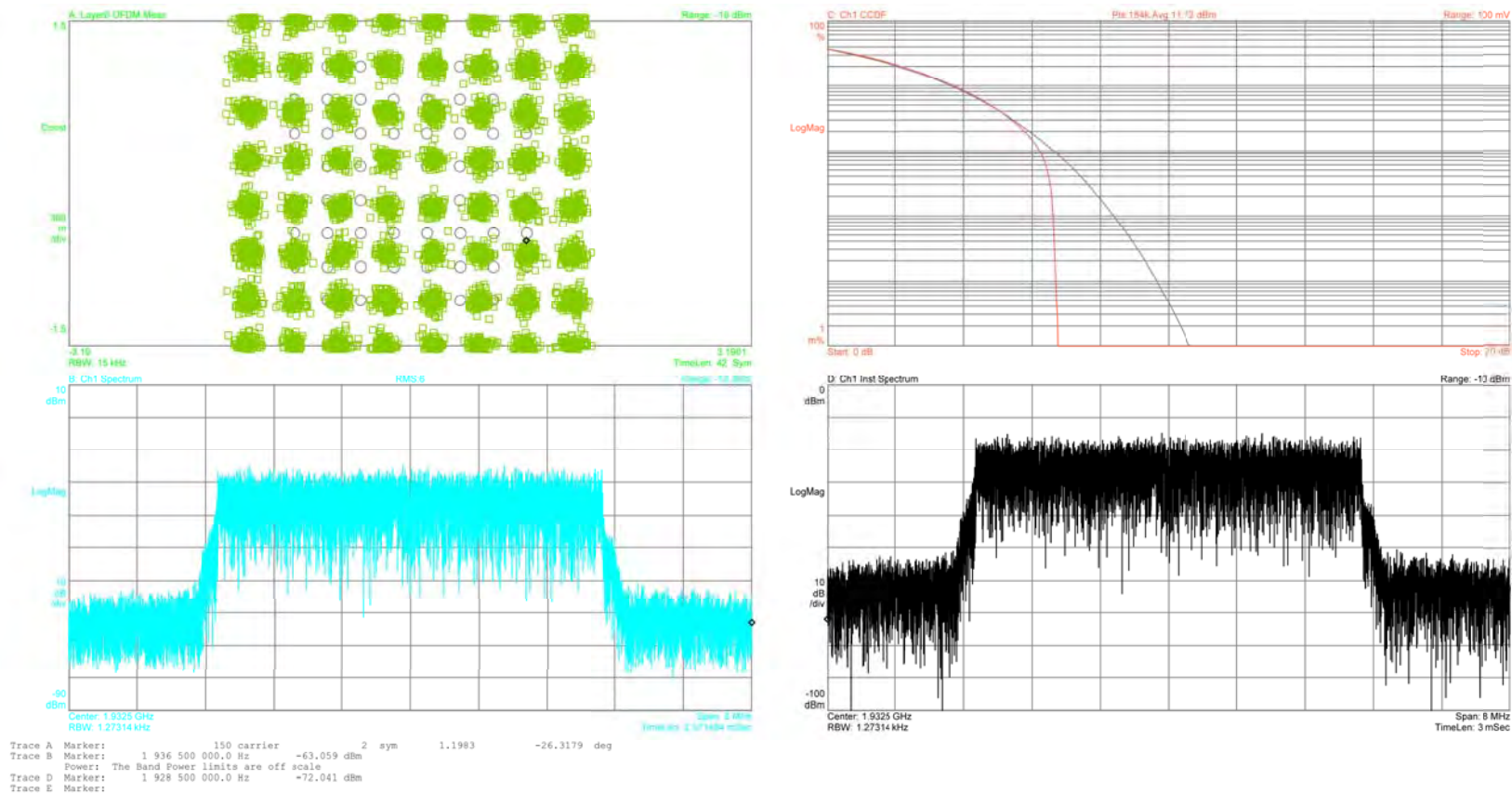
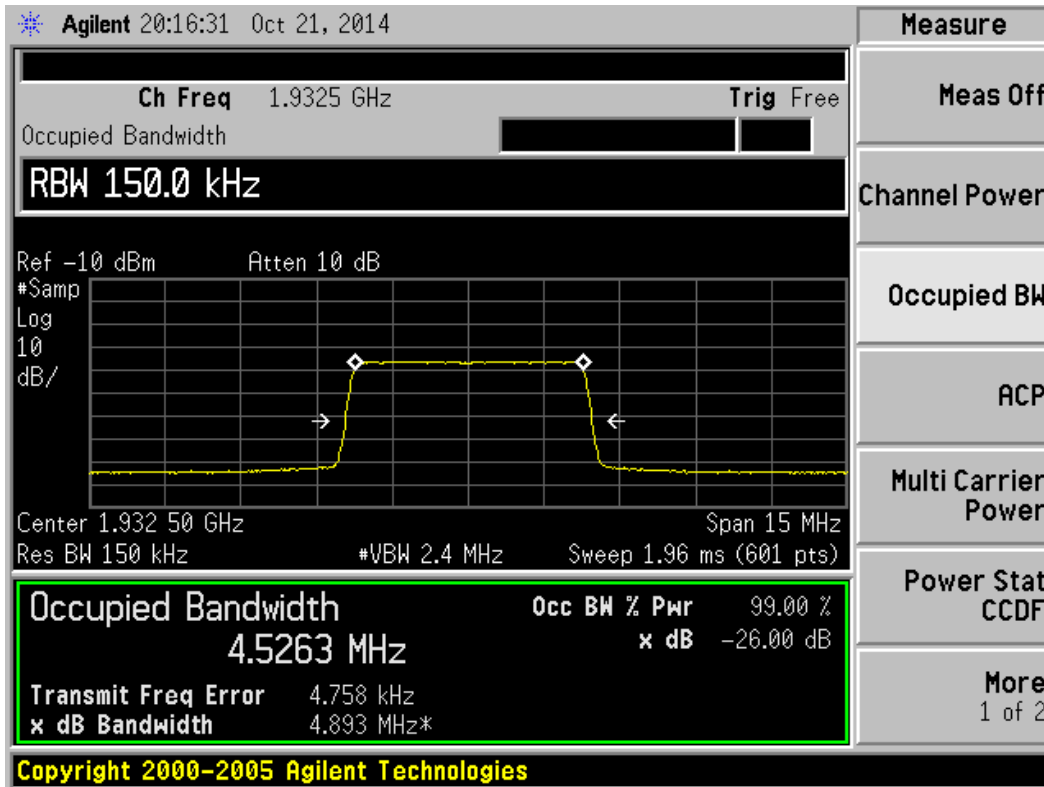

Figure 13C Code Domain A Block, Channel 50 4QAM



The 99%/-26 dB Occupied Signal Bandwidth at 150 kHz RBW



The 99%/-26 dB Occupied Signal Bandwidth at 300 kHz RBW

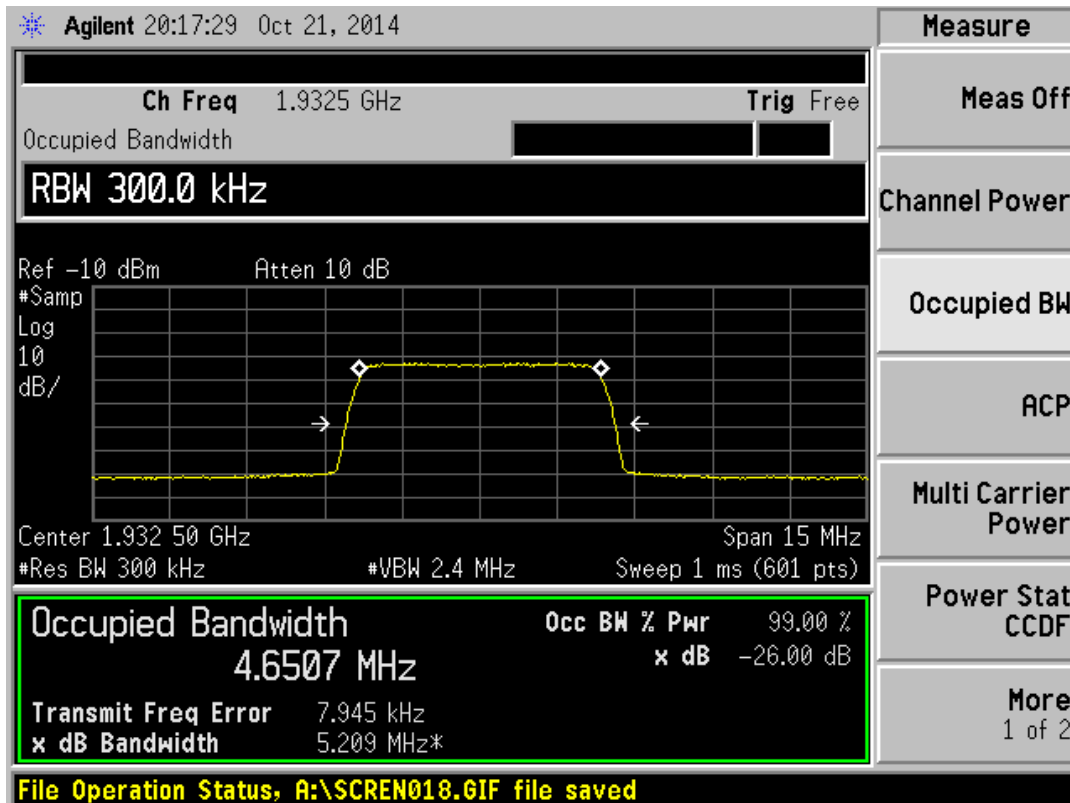

14. Exhibit 14 MEASUREMENT OF OCCUPIED BANDWIDTH

14.1 SECTION 2.1049 Measurement Of Occupied Bandwidth

Occupied bandwidth measurements were performed for the test configurations pertinent to full bandwidth A through G Block operation of the **PCS LTE 9764 Metro Cell Outdoor Transceiver System / AS5BBTRX-21**. This documents the typical performance of the **PCS LTE 9764 Metro Cell** while operating with one 5MHz LTE carrier. All power adjustments were performed prior to other measurements. The measurements are described below.

The occupied bandwidth of the **PCS LTE 9764 Metro Cell Outdoor Transceiver System / AS5BBTRX-21** was measured using a Rohde & Schwarz FSEM-30 Spectrum Analyzer, a PC based instrumentation controller using TILE™ software and calibrated RF attenuation and coupled signal path. The RF power level was measured and adjusted via the test setup in Figure 14A. The set RF output from the transmitter was reduced by calibrated broadband attenuators to amplitudes usable by the spectrum analyzer and power meter. The attenuation factors are reflected in the displayed values of the charts. The typical occupied bandwidth measurement displays the signal adjusted to the -22.22 dBc level corresponding to the corrected RF power level for a 30 kHz resolution bandwidth (RBW). This set-point was performed as follows:

For each test the power calibration was individually verified at the transmitter antenna connection (J4) with a power meter by using the test setup depicted in Figure 14A. The power calibration was performed to calibrate the setting power meter measurement as a reference for both the measured 30 kHz Occupied Bandwidth signal at the -22.22 dBc line and a 3 MHz RBW measurement against the power calibration line which is -2.218 dB below the “Top of Mask” limit. The “Top of Mask” limit corresponds to a single carrier signal at the specified power level of 2W / 33 dBm if measured with an RBW of ≥ 5 MHz. Since the power calibration measurements was performed with a 3 MHz RBW a power calibration line equal to $10 \log(3\text{MHz}/5\text{MHz}) = -2.218$ dB below the top of mask at 30.78 dBm is used as the power set point.

The transmitter output has a single 5 MHz 2W / 33 dBm LTE carrier. In each occupied bandwidth measurement there are two traces which track each other a given distance apart in amplitude. One trace is the power calibration trace and this carrier is set to the power calibration line. The second trace is the occupied bandwidth measurement. These power calibration measurements is performed along with each Occupied Bandwidth measurement. The signals measured at RBW's of 3 MHz and 30 kHz were corrected for path loss and were plotted against the mask limit. As part of the calibration between the power meter measurement and the test analyzer, software was used to place the 3 MHz RBW signal either at the “Top of Mask” for carriers $\leq 3\text{MHz}$ or at the carrier power calibration line for single or multi carriers signals $\geq 3\text{MHz}$. The carrier as measured with 3 MHz and 30 kHz RBW were corrected with the same attenuation factors. The two measurements are co-plotted on the same graph. A typical single carrier example is shown in Figure 14B which depicts a single carrier (350 D Block) inside the mask for the 5MHz wide D Block.

The test procedure above, calibrates the carrier power against the Mask and accurately places the occupied bandwidth measured carrier at the -22.22 dBc reference line. All of the plots are presented with a sufficiently wide frequency span for the specific signals or Block of interest. This allows for ease of comparison of the multi-carrier performance. This data was electronically recorded using the TILE™ software and electronically placed in the Occupied Bandwidth Data Sheets. These sheets contain data for “Left Edge of Block”, and “Right Edge of Block” for each PCS frequency Block.

14.2 Block Organization and Tests Performed

The 9764 Metro Cell product line uses a 65 MHz bandwidth transmit filter. The use of EDPD provides the in band spurious control which allows the use of a wide bandwidth filter while demonstrating compliance within the PCS band at all individual block edges.. The testing of the product documented herein was performed with a single 65 MHz PCS band filters.

The demonstrations of compliance for the 5 MHz LTE carrier configurations were performed for operation in all PCS Blocks. The presented data for this initial product certification demonstrates the configurations compliance.

In order to adequately evaluate performance the modulation factors were used from the governing documents. Thus, the applied signal, from **PCS LTE 9764 Metro Cell Outdoor Transceiver System / AS5BBTRX-21**, met the recommended characteristics

The modulation used in evaluating the **PCS LTE 9764 Metro Cell Outdoor Transceiver System / AS5BBTRX-21** are described in the pertinent standards documents which include **3GPP TS 36.211 V9.1.0 (2010-03) titled: 3rd Generation Partnership Project; Technical Specification Group Radio Access Network; Evolved Universal Terrestrial Radio Access (E-UTRA); Physical Channels and Modulation (Release 9)**. The modulation is Orthogonal Frequency Division Multiple Access (OFDMA) which is processed into an uplink IF signal. The input data stream is divided into several parallel sub-streams of reduced data rate and each sub-stream is transmitted on a separate orthogonal sub-carrier. The sub-carriers are modulated using either QPSK, 16QAM or 64QAM. There is no single measure of the modulation quality other than to verify that the subcarrier modulation constellations visual orientation match the symbol and amplitude criteria is consistent with QPSK, 16QAM and 64QAM.

14.3 Measurement Offset

The spectrum analysis output plots shows the peak of the LTE channel signal 22.22 dB below the top of Mask reference of the spectrum analyzer for the following reason: For the LTE system there is no carrier without modulation. Since the LTE signal is broadband and 5 MHz wide, all measurements performed at narrower resolution bandwidths need be adjusted for the reduction in signal energy. The following relationship was used to provide the correct level for an unmodulated carrier vs. the modulated signal.

$$10 \cdot \log(\text{Resolution Bandwidth} / \text{Transmit Bandwidth}) = \text{Signal Offset} \quad (1)$$

For the peak of the 5 MHz LTE signal measured with a RBW of 30 kHz the signal offset is:

$$\text{Signal Offset} = 10 \cdot \log(30 \text{ kHz} / 5 \text{ MHz}) = -22.22 \text{ dB}$$

Since the 5 MHz LTE signal is wider than the 3 MHz spectrum analyzer setting used for power calibration a power calibration line must be placed below the top of mask. The offset for the power calibration line is:

$$\text{Power Calibration Offset} = 10 \cdot \log(3 \text{ MHz} / 5 \text{ MHz}) = -2.218 \text{ dB}$$

Limits which are specified as appropriate at a given RBW can be measured and evaluated at other RBW's if the limit is adjusted per equation (1)

14.4 Require Levels

The Limit in 47 CFR 24.238(a)(b) for emissions in the 1 MHz band immediately outside and adjacent to a licensee's frequency block is:

Emissions ≤ 1 MHz outside the Block *when measured with a RBW of 1%* of the emissions Bandwidth shall be attenuated by :

$$-\{43 + 10 \log(\text{mean power output in watts})\} = -13 \text{ dBm}$$

The Limit in 47 CFR 24.238(a) for emissions outside a licensee's frequency block is:

Emissions > 1 MHz outside the Block, *when measured with a RBW of 1 MHz*, shall be attenuated by :

$$-\{43 + 10 \log(\text{mean power output in watts})\} = -13 \text{ dBm}$$

14.5 Adjustment for 2x MIMO

In order to account for the spectral adding of identical signals from the primary and diversity ports, per KDB 662911 D01 Multiple Transmitter Output v01r01, the level needs be adjusted by 10LOG(n) where n= number of outputs. The adjustment for n=2 is: 3.01 dB = 10LOG(2)

Therefore the limit for emissions >1 MHz outside a licensees frequency block when measured with a RBW of 1 MHz is:

$$-13 \text{ dBm} - 3.01 \text{ dB} = -16.01 \text{ dBm}$$

14.6 Adjusted Levels

The following levels apply when measurement of the above limits are performed with an RBW of 30 kHz. And are performed to appropriately apply the correct mask. Measurement at a Resolution Bandwidth of 30 kHz is based on our experience with 47 CFR 24.238 and test preferences.

1. On any frequency removed from the carrier center frequency by greater than 2.5 MHz to 3.5 MHz the level shall not exceed -18.22 dBm when measured in a 30 kHz resolution bandwidth (Note 2 below).
For a 2 Watts MIMO output the required level is -18.22 dBm/ -51.22 dBc.
2. For any frequency > 1MHz from the edge of the Block to the 10th harmonic of the carrier the spurious shall not exceed 31.24 dBm when measured in a 30 kHz resolution bandwidth (Note 3 below)
For a 2 Watts MIMO output the required level is -31.24dBm / -64.24 dBc

+++++
Note 2: The -18.22 dBm/ -48.22 dBc level was computed as follows: The limit is specified as

$$-\{43+10\log(\text{mean power output in watts})\} \text{ dB} = -13 \text{ dBm}$$

Within the 1st MHz outside the band the limit of -13 dBm is specified when measured with a 1% bandwidth. When measured with a different bandwidth the adjustment is made against 1% of the signal bandwidth. Since the carrier is a 5 MHz bandwidth signal and the 1% signal bandwidth is 50 kHz, the limit is adjusted to

$$-13 + 10\text{LOG}(30\text{kHz}/50 \text{ kHz}) \text{ dBm} = -15.21 \text{ dBm}$$

When accounting for a 2x MIMO signal, (per KDB 662911 D01 Multiple Transmitter Output v01r01), the level needs be adjusted by 10LOG(n) where n= number of outputs. The adjustment for n=2 is:
3.01 dB = 10LOG(2)

The resultant limit for MIMO operation is -15.21dBm - 3.01 dB = -18.22 dBm;
which given a 33 dBm carrier (2W) equals - 51.22 dBc

Note 3: The -31.24 dBm/ -75.04 dBc level is computed from -13 dBm measured with a 1 MHz resolution bandwidth adjusted by :

$$-13 + 10\text{LOG}(30\text{kHz}/1.0 \text{ MHz}) \text{ dBm} = -28.23 \text{ dBm}$$

When accounting for a 2x MIMO signal, (per KDB 662911 D01 Multiple Transmitter Output v01r01), the level needs be adjusted by 10LOG(n) where n= number of transmitter outputs. The adjustment for n=2 is:
3.01 dB = 10LOG(2)

The resultant limit for MIMO operation is -28.23 dBm - 3.01 dB = -31.24 dBm ;
which given a 33 dBm carrier (2W) equals - 64.24 dBc

14.7 Trace Description and Power Calibration

Figure 14B shows the single carrier channel 50 LTE signal measured with two different resolution bandwidths. The additional upper magenta trace displays the signal as measured with a resolution bandwidth of 3 MHz. The black trace is the same signal as measured with a 30 kHz resolution bandwidth and is the appropriate trace for the mask evaluation. The wider resolution bandwidth allows for a true power calibration of the measured signal against the power calibration line.

14.8 Mask Description for a Single 2 W Carrier application.

The Mask limits are identical for the left and right side of the AWS Blocks and are as follows:

Figure 14B shows the 5 MHz LTE Mask limit for PCS Block A (1930-1945) for PCS channel 50. The horizontal line from a to aa (a-aa) is the 33 dBm/ 0 dBc reference level. The Power Calibration reference line g-gg is below the top of mask reference line as the 3 MHz power calibration resolution bandwidth differs from the 5 MHz signal bandwidth. The g-gg line is at $33 - 2.218 = 30.78$ dBm. The peak of the 3 MHz magenta power calibration trace is shown set to this value.

The top of a typical 33.0 dBm single 5 MHz LTE 64QAM carrier signal viewed at a resolution bandwidth of 30 kHz is shown at the 10.78 dBm/ -22.22 dBc line t-tt. This line is based on equations 1 and 2, and the ratio of the 5 MHz signal bandwidth and the 30 kHz resolution bandwidth of the spectrum analyzer.

The vertical line from a to b (i.e. a-b) and aa-bb are at the block edge for A Block. The horizontal lines c-b and bb-cc represent the limit for the 1st MHz outside the block. The placement of lines c-b and bb-cc is derived from evaluation of 1% of the signal bandwidth, the 30 kHz resolution bandwidth and adjustments for MIMO using the suggested value in of the rules.

Per Note 2 above, the limit for the 1st MHz outside the band with MIMO operation is **-18.22 dBm / - 51.22 dBc**

The vertical line, c-d and cc-dd are the transitions at 1MHz outside the specified Block.

The horizontal line d-e and dd-ee are placed at the **-31.24 dBm / -64.24 dBc** level below the 33 dBm / 0 dBc reference per Note 3 above. The rules require a 1 MHz resolution bandwidth for measurements 1 MHz or greater outside the AWS band. Again, equation (1) and the ratio of 1 MHz to 30 kHz provides this value. The same logic was used in determining the other block and band edge tolerances. Figure 14C depicts all off the PCS blocks. Performing the OBW measurement across all of the blocks evaluates intermodulation and performance outside the block but inside the band.

14.9 Measurement

In order to depict the tolerance lines that are required by Sec 24.238 of the FCC Rules and **3GPP TS 36.211 V9.1.0 (2010-03)**, all measurements were made with a resolution bandwidth of 30 kHz and the limits were adjusted as described above using equation (1).

The measurement was performed using a automated data collection system which eliminates variability and operator error. The test profile deliberately and consistently measures the occupied bandwidth using a resolution bandwidth of 30 kHz and a sample detector with 25X averaging. The entire 75 MHz span of measurement (65 MHz +/- 5 MHz outside the band) was broken up into 14 individual 5.36 MHz span of measurement. Each of the individual spans are less than 256 times the resolution bandwidth to eliminate aliasing. The use of smaller spans and longer sweep times are the best settings to acquire all spurious signal with the equipment used. This is based on our experience with 47 CFR 24.238, the measurements performed and lacking other guidance.

All of the tolerance lines for the output are referenced to the top of the Occupied Bandwidth mask, which is defined as 33.0 dBm/ zero dBc. For all measurements of the **PCS LTE 9764 Metro Cell Outdoor Transceiver System / AS5BBTRX-21** Occupied Bandwidth, the output power was measured / adjusted individually to the 2 W level for each carrier and this is the 33.0 dBm value at the 0 dBc reference line.

Exhibit 14 *continued*

TABLE 14.2 PCS Occupied Bandwidth Compliance Tabulation

PCS - Block	PCS - Channel #	Number of Primary carriers	Primary Port Power, W	Results Primary Terminal Occupied Bandwidth	Number of Diversity carriers	Diversity Port Power, W	Results Primary Terminal Occupied Bandwidth
A	50	1	1.0	Compliant	1	1.0	Compliant
A	250	1	1.0	Compliant	1	1.0	Compliant
D	350	1	1.0	Compliant	1	1.0	Compliant
B	450	1	1.0	Compliant	1	1.0	Compliant
B	650	1	1.0	Compliant	1	1.0	Compliant
E	750	1	1.0	Compliant	1	1.0	Compliant
F	850	1	1.0	Compliant	1	1.0	Compliant
C	950	1	1.0	Compliant	1	1.0	Compliant
C	1150	1	1.0	Compliant	1	1.0	Compliant

14.10 Results

Identical measurement were performed for Primary and Diversity Transmit ports. In each case the transmitter output Occupied Bandwidth measurement was performed for the Left Edge and the Right Edge of each PCS Block. Measurements were performed for QPSK and for 64QAM operation. Modulation parameters were measured and recorded prior to OBW measurement. A minimum margin of 10 dB was documented on each plot. The Block designation, PCS channels, frequencies and Measured RF Power were also tabulated on each Occupied Bandwidth plot. The signals are plotted for each frequency/ channel of interest. These frequencies were chosen to show the occupied bandwidth for the closest block edge channels for which this product can be operated specifically to document compliance with Section 24.229 and 24.238 (c) of the Commission code. The signal used to show the occupied bandwidth is defined in table 14.1. This is the signal recommended in **3GPP TS 36.211 V9.1.0 (2010-03)**. The power output level was adjusted to provide the documented value on each chart.

RESULTS: The following exhibits illustrate the spectrums investigated and document compliance.

W. Steve Majkowski NCE

Figure 14A Test Setup for Antenna Port Measurements of RF Power, Occupied Bandwidth & Conducted Spurious Emissions

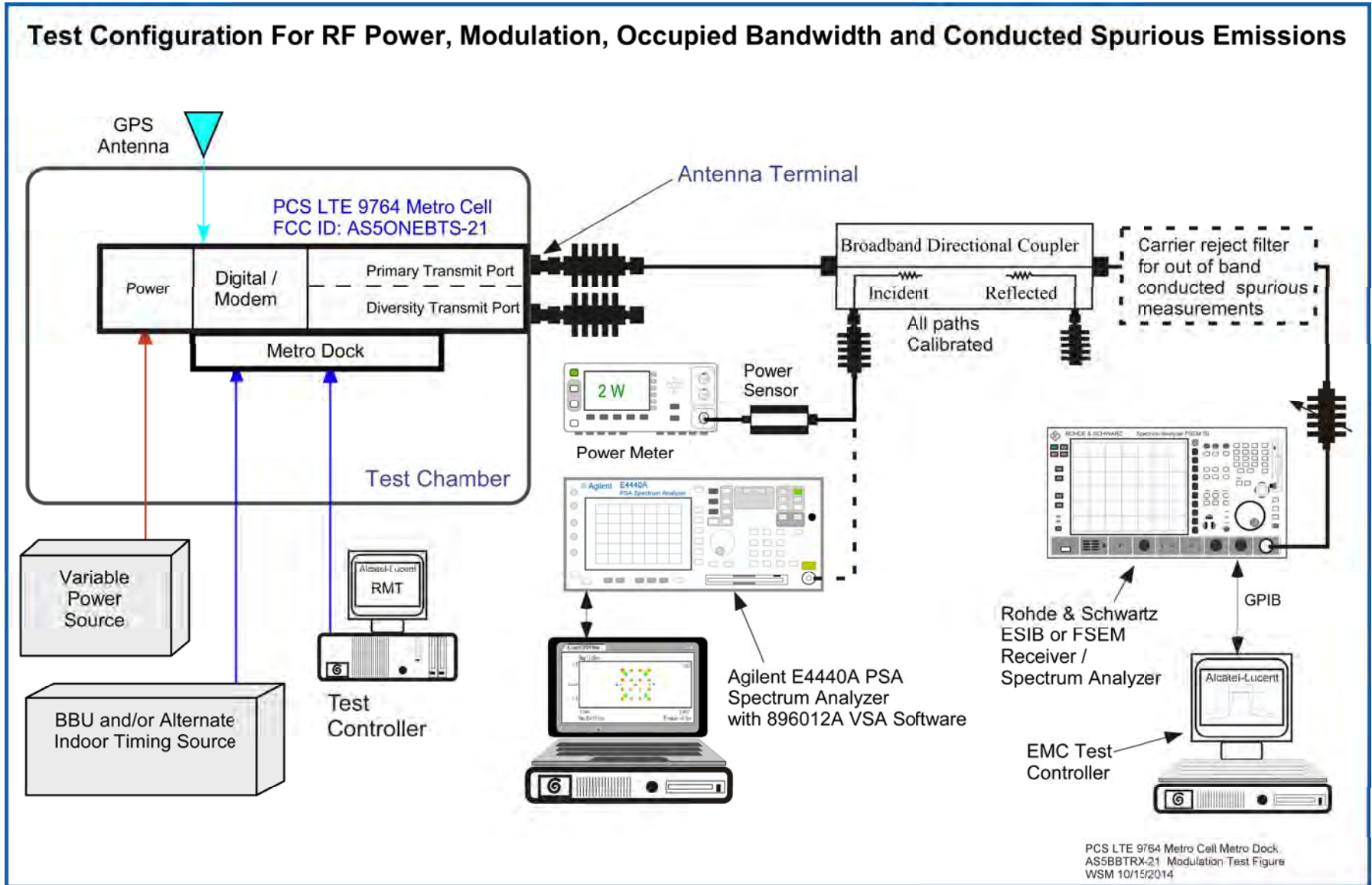

Figure 14B Occupied Bandwidth Mask for PCS Block Operation at D Block Channel 350

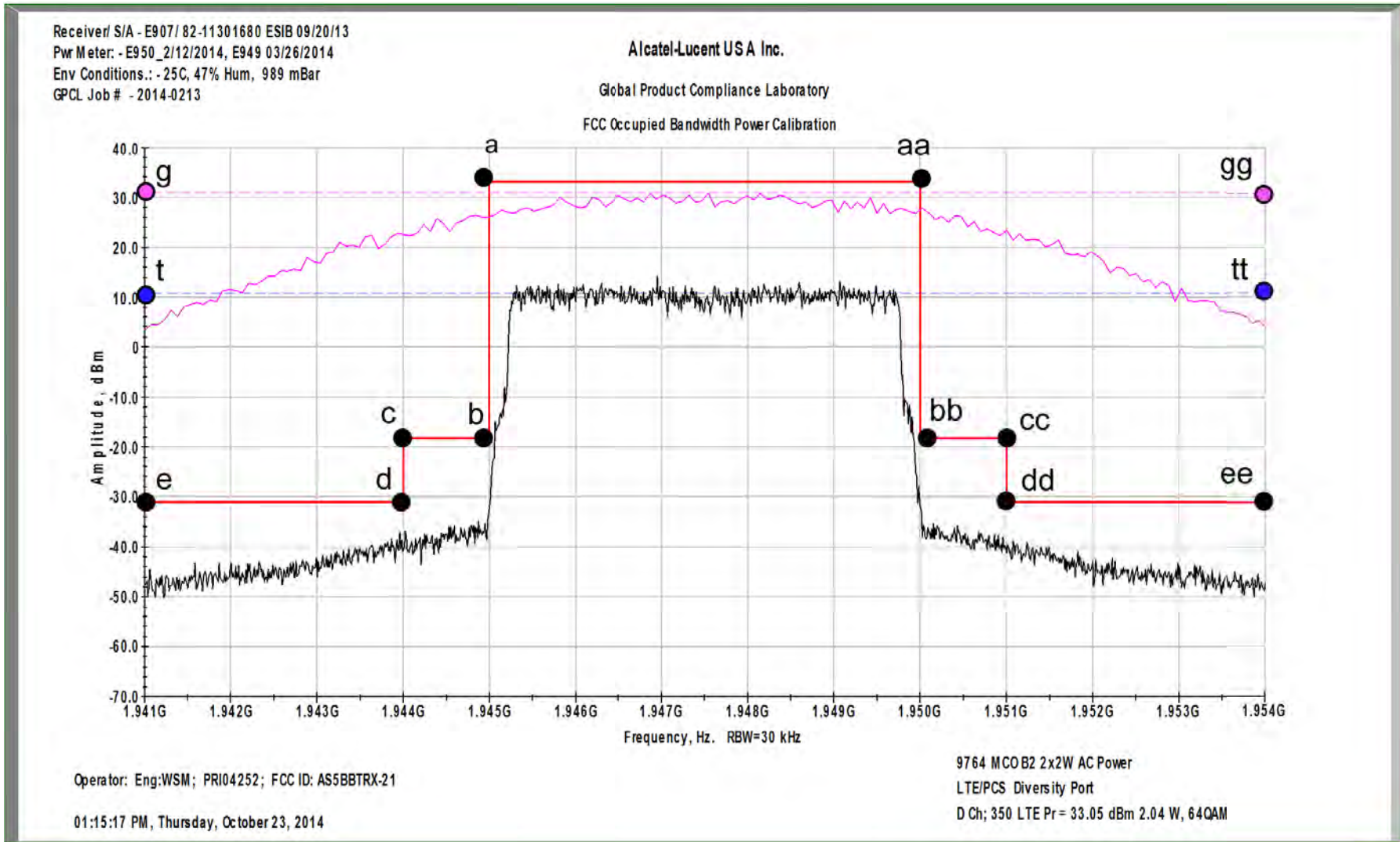
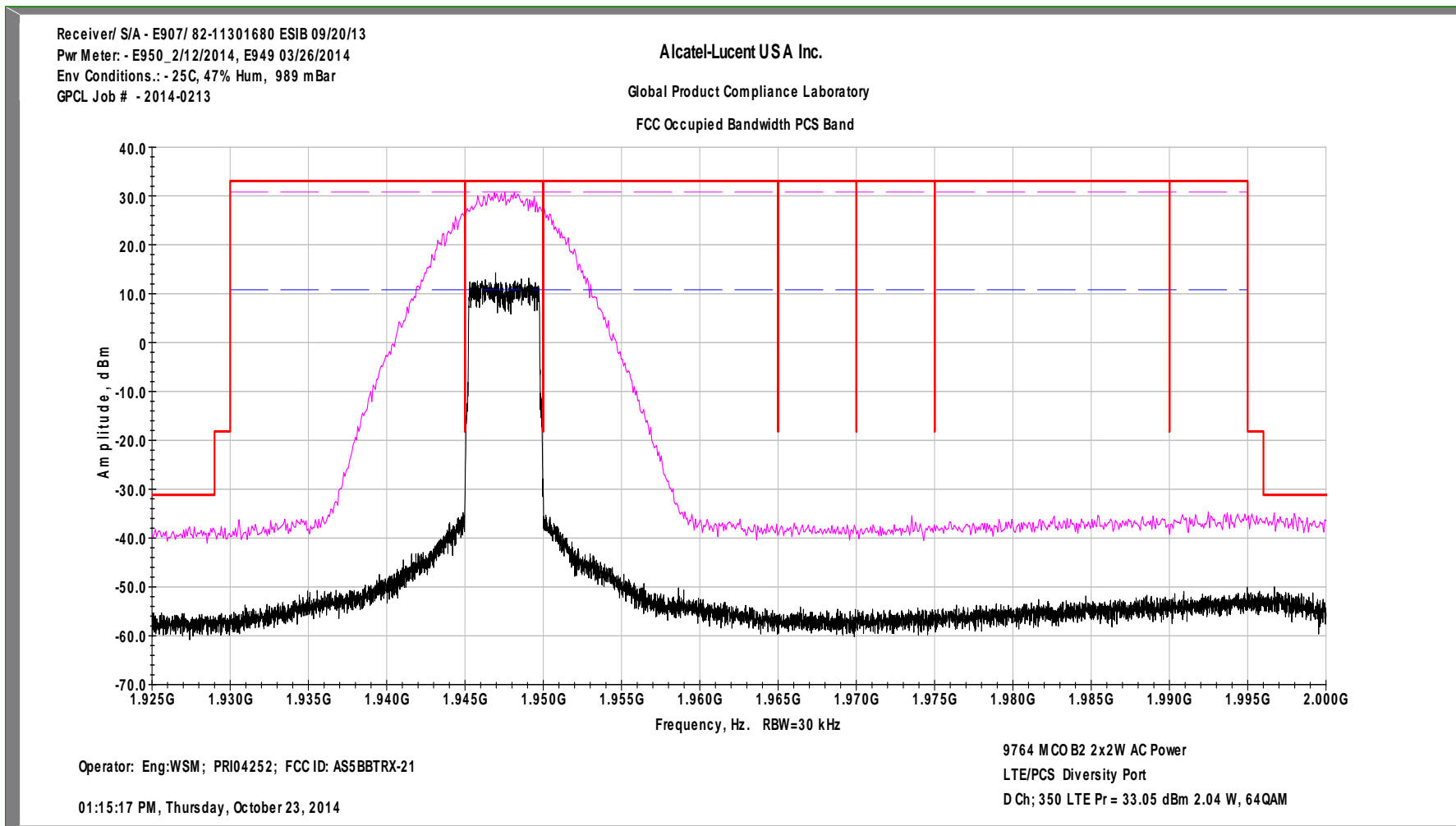

Figure 14 C Occupied Bandwidth Whole Band View



**Transmitter Measurements
of
Occupied Bandwidth
for
Alcatel-Lucent USA Inc.
PCS LTE 9764 Metro Cell Outdoor
Transceiver System
FCC ID: AS5BBTRX-21**

W. Steve Majkowski NCE

FCC Wireless Compliance, Filing Lead

Alcatel-Lucent USA Inc.

Global Product Compliance Laboratory

Building 5B-103

600-700 Mountain Avenue, P.O. Box 636

New Providence, NJ 07974-0636

Office: 908-582-3782

email: steve.majkowski@alcatel-lucent.com

Occupied Bandwidth PCS 2x2W 64QAM Block A1 Primary

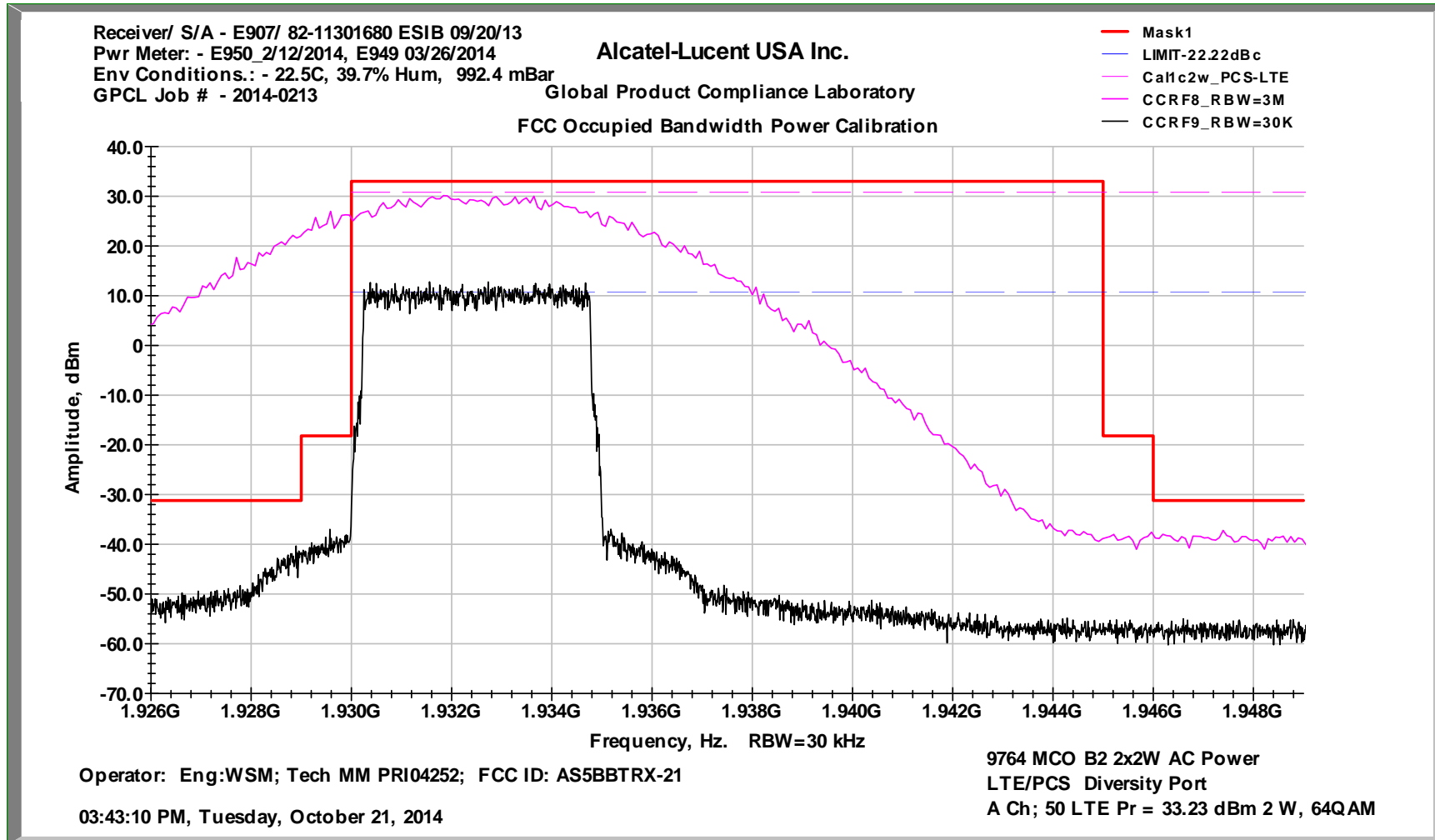

Occupied Bandwidth PCS 2x2W 3 Modulations 64QAM 16QAM QPSK Block A1 Primary

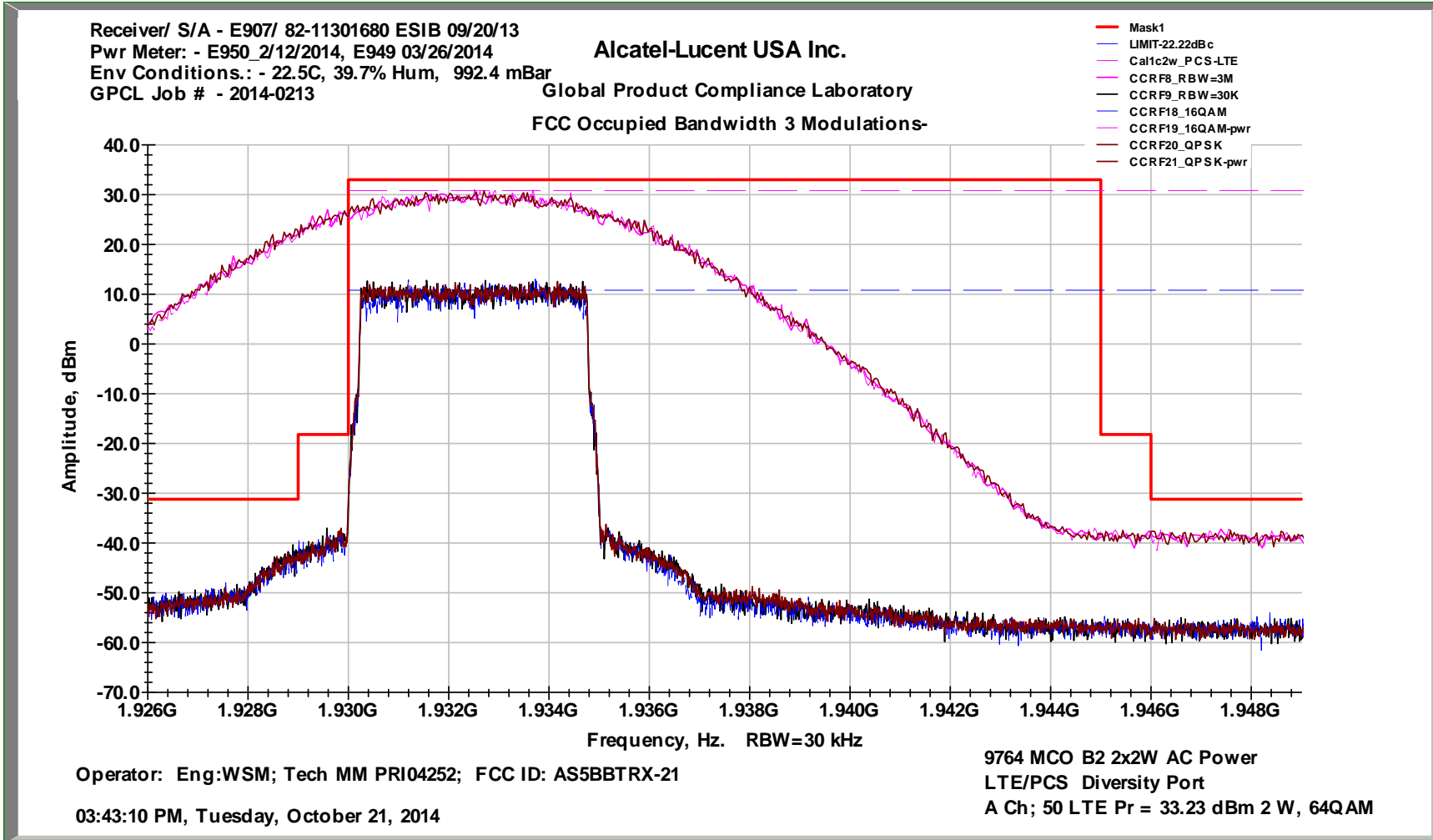

Occupied Bandwidth PCS 2x2W 64QAM Block A1 Edge of Block Primary

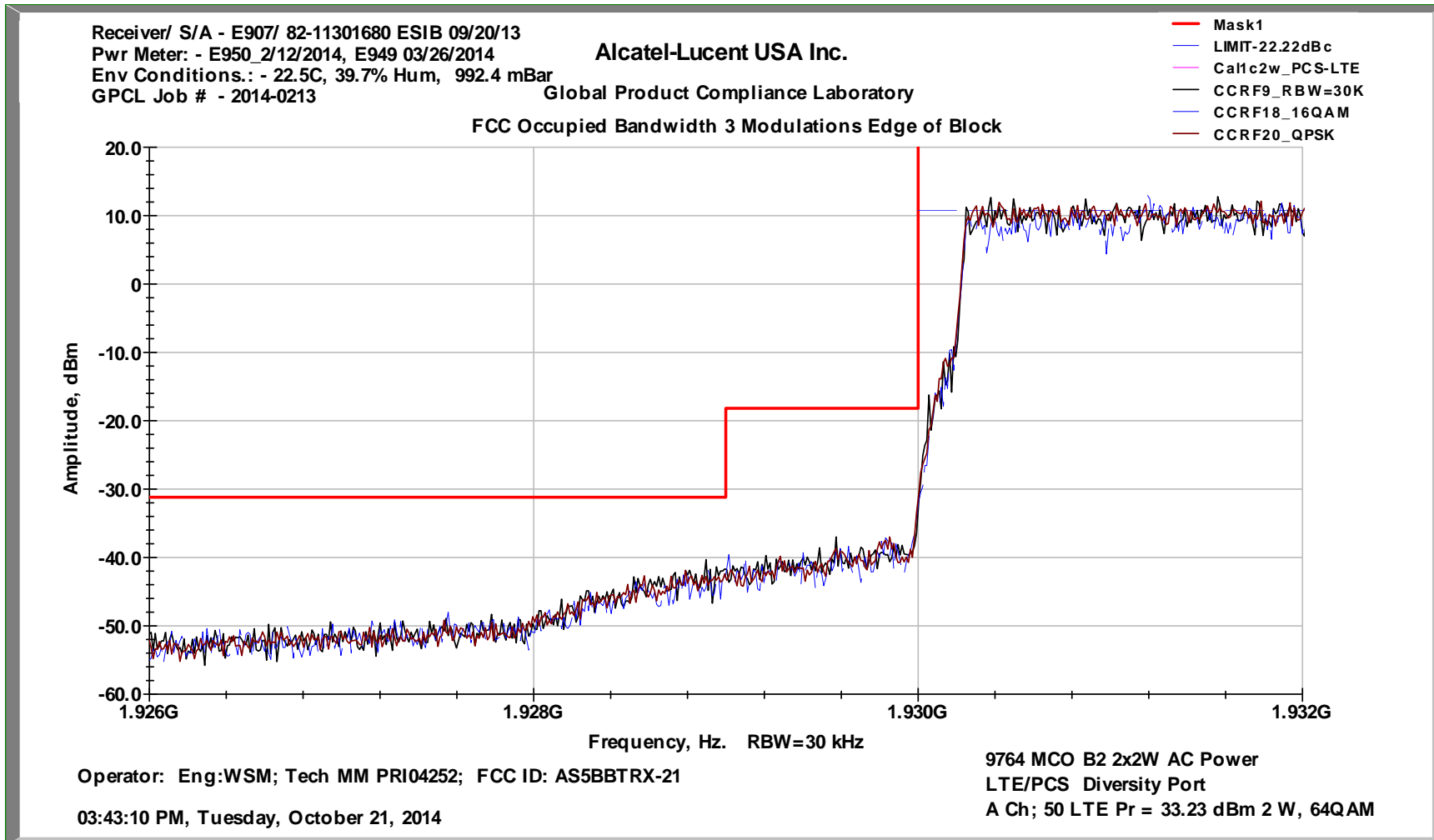

Occupied Bandwidth PCS 2x2W 64QAM Block A1 Diversity

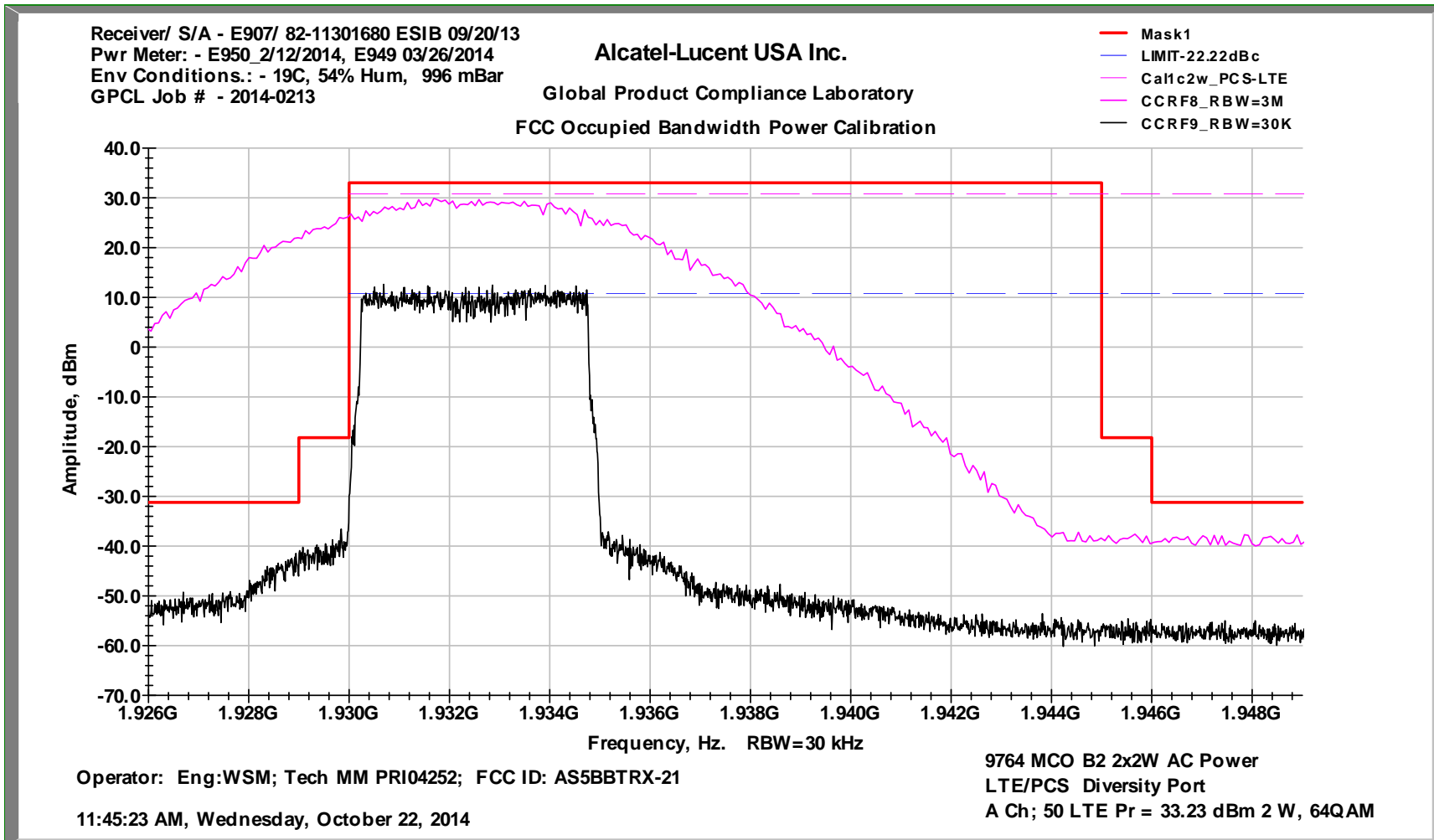

Occupied Bandwidth PCS 2x2W 64QAM Block A1 Edge of Block Diversity

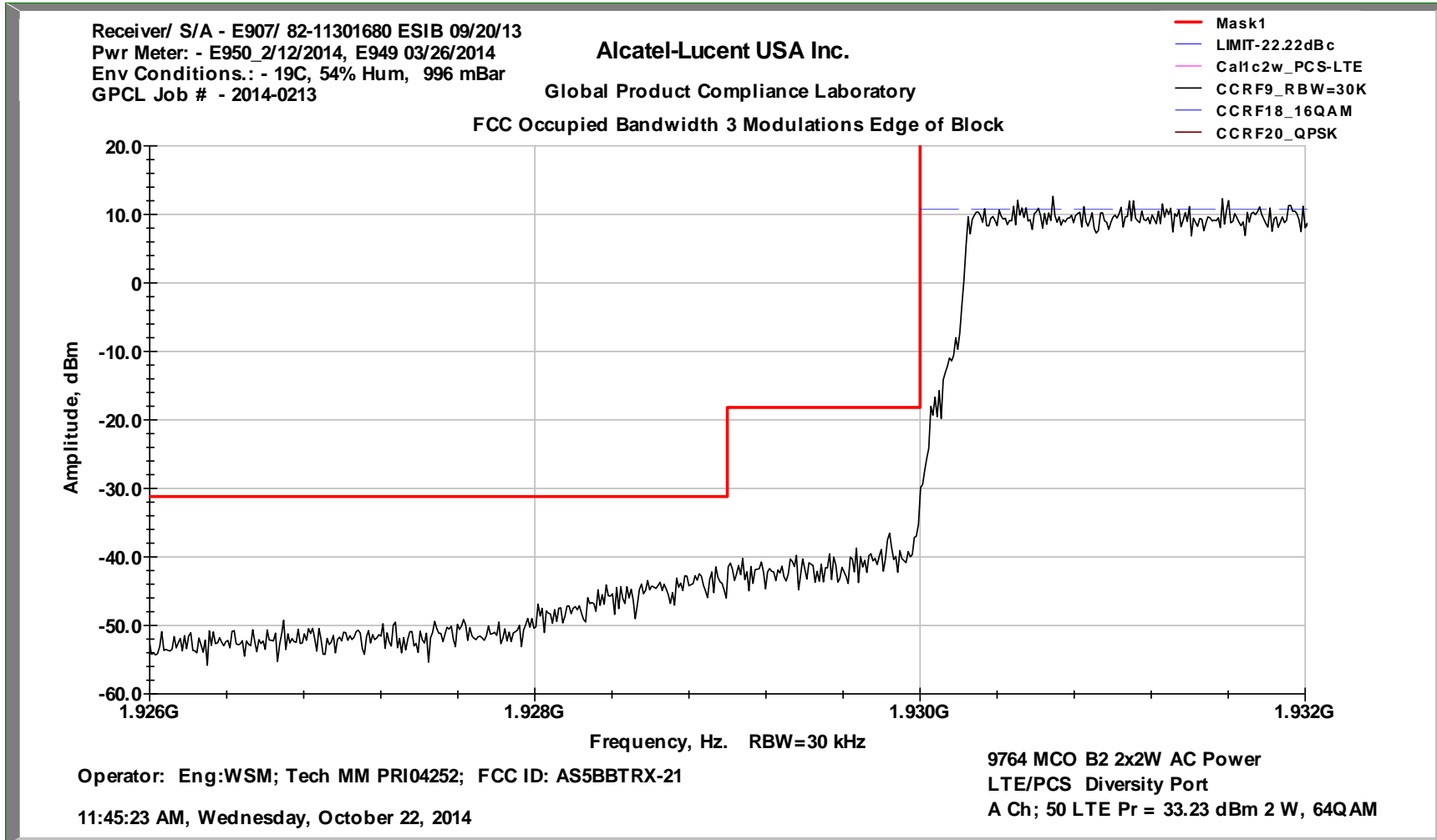

Occupied Bandwidth PCS 2x2W 64QAM Block A5 Primary

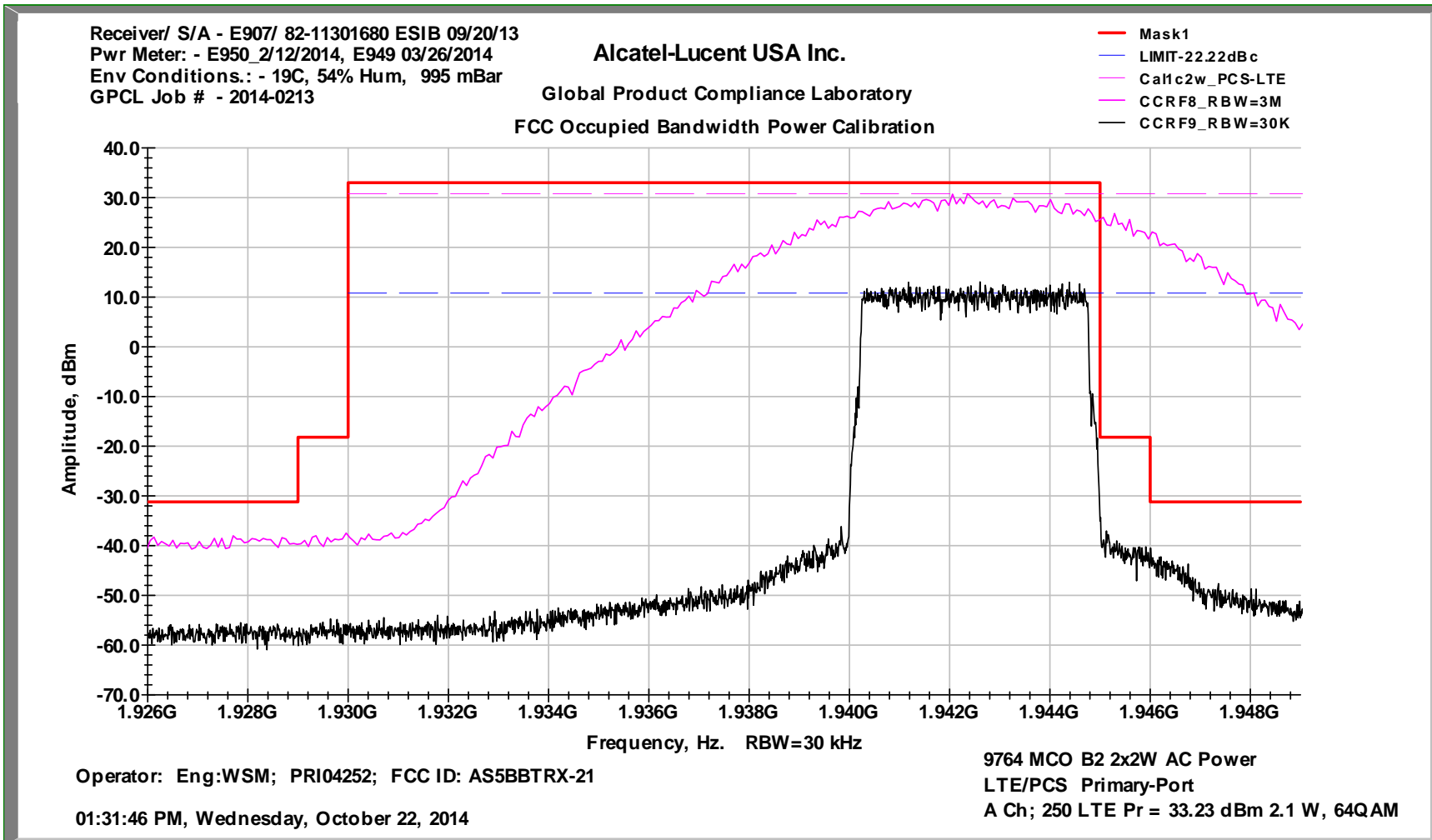

Occupied Bandwidth PCS 2x2W 3 Modulations 64QAM 16QAM QPSK Block A5 Primary

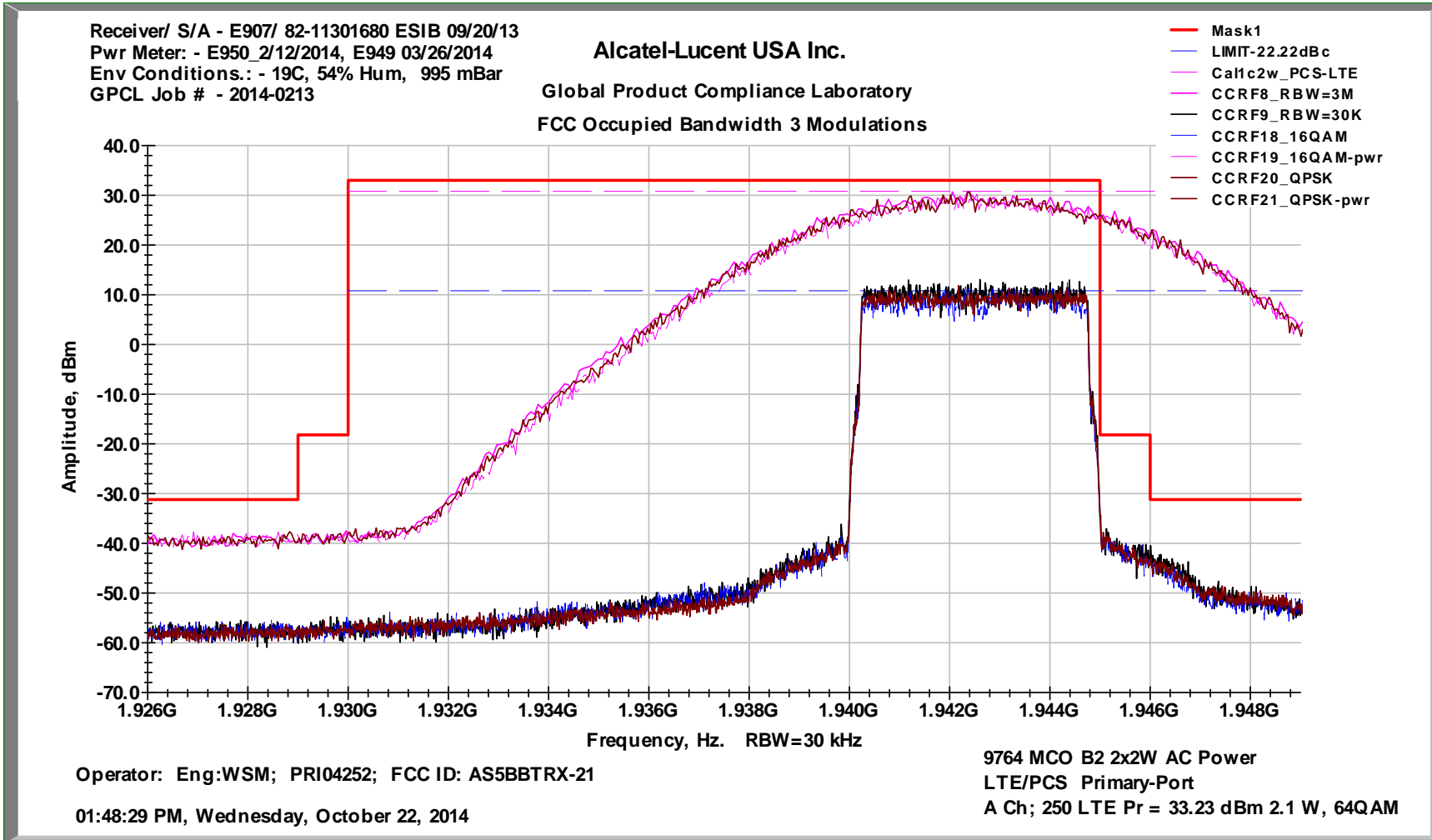

Occupied Bandwidth PCS 2x2W 64QAM Block A5 Edge of Block Primary

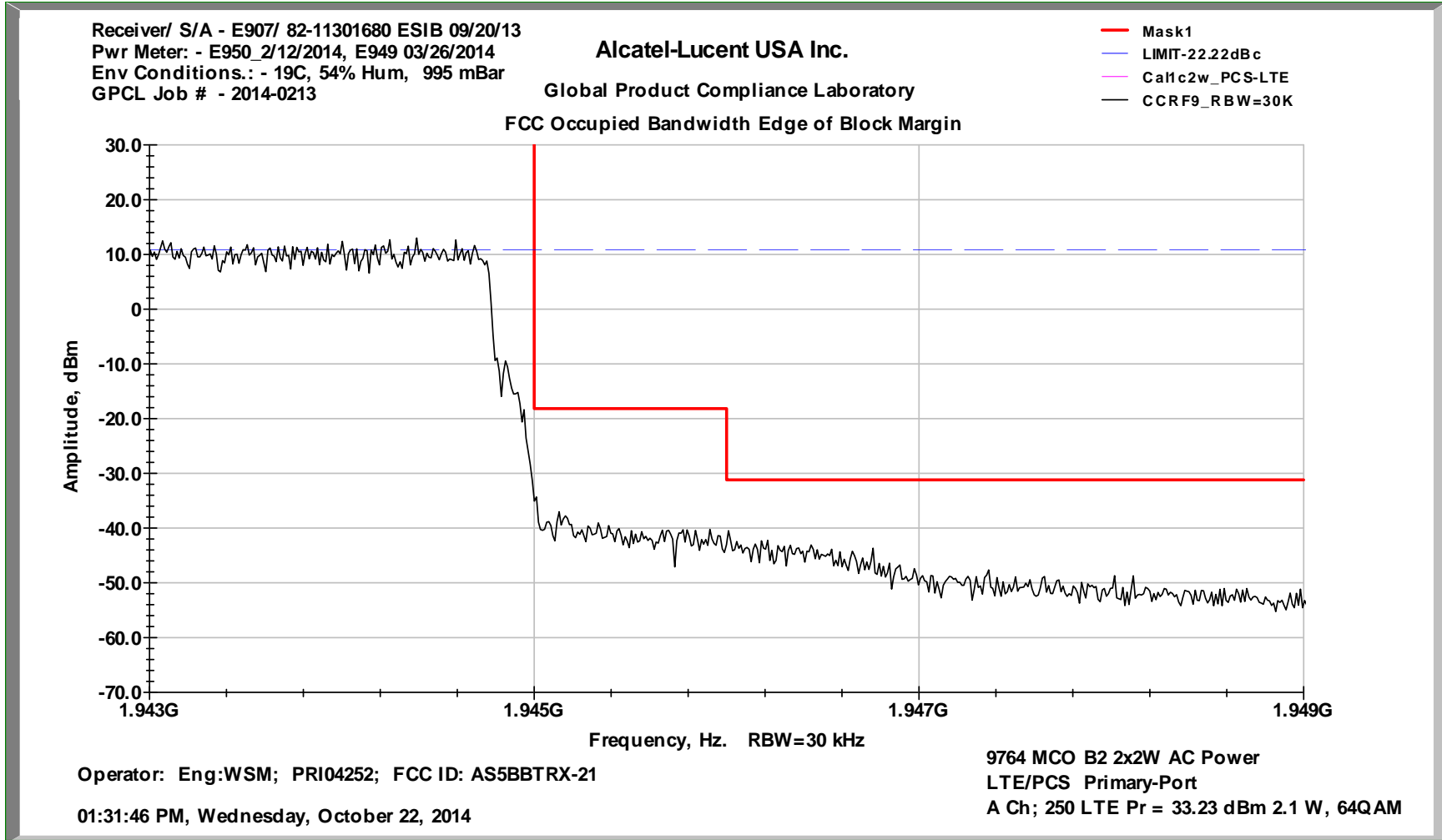

Occupied Bandwidth PCS 2x2W 64QAM Block A5 Diversity

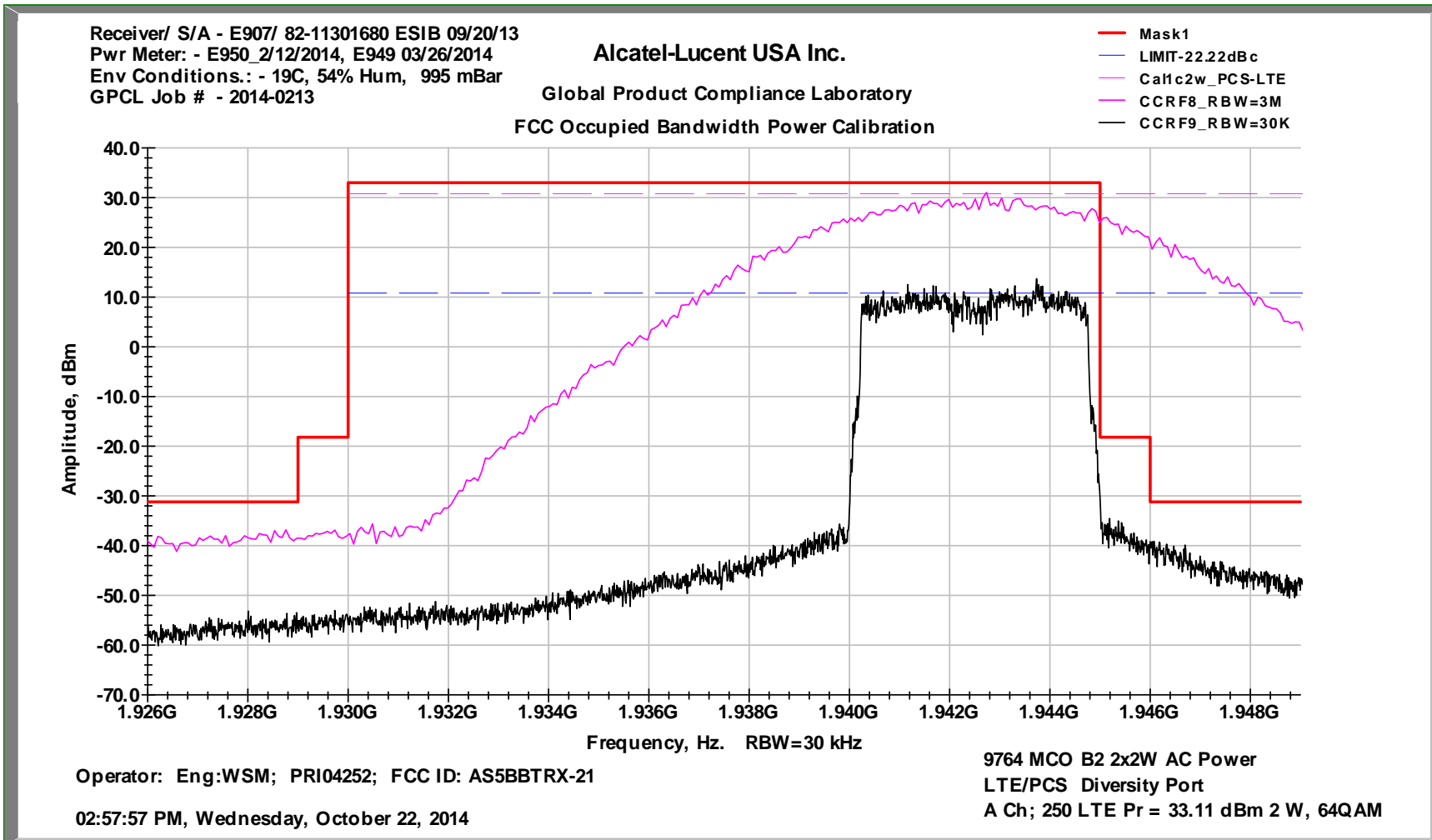

Occupied Bandwidth PCS 2x2W 64QAM Block A5 Edge of Block Diversity

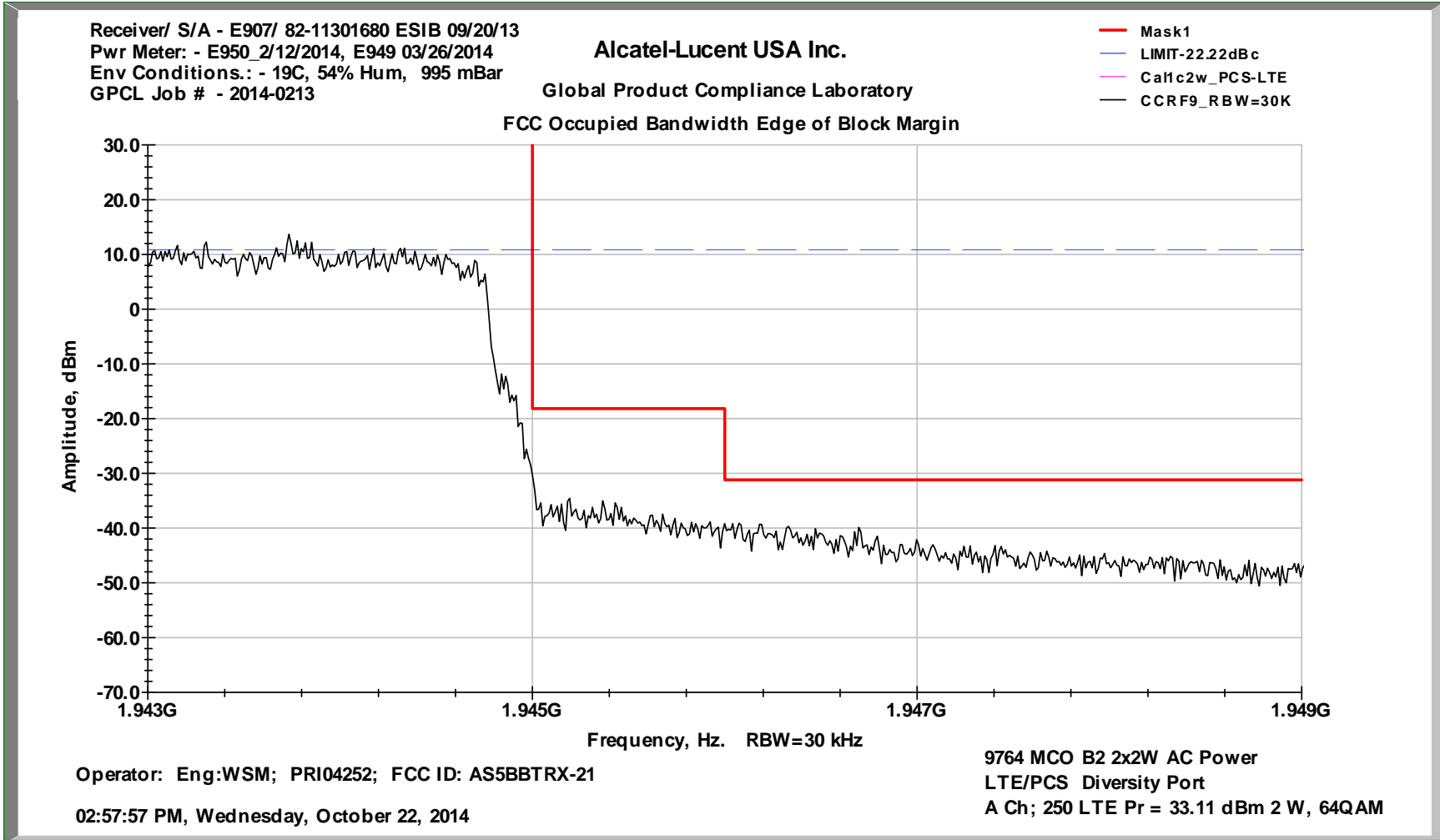

Occupied Bandwidth PCS 2x2W 64QAM Block D Primary

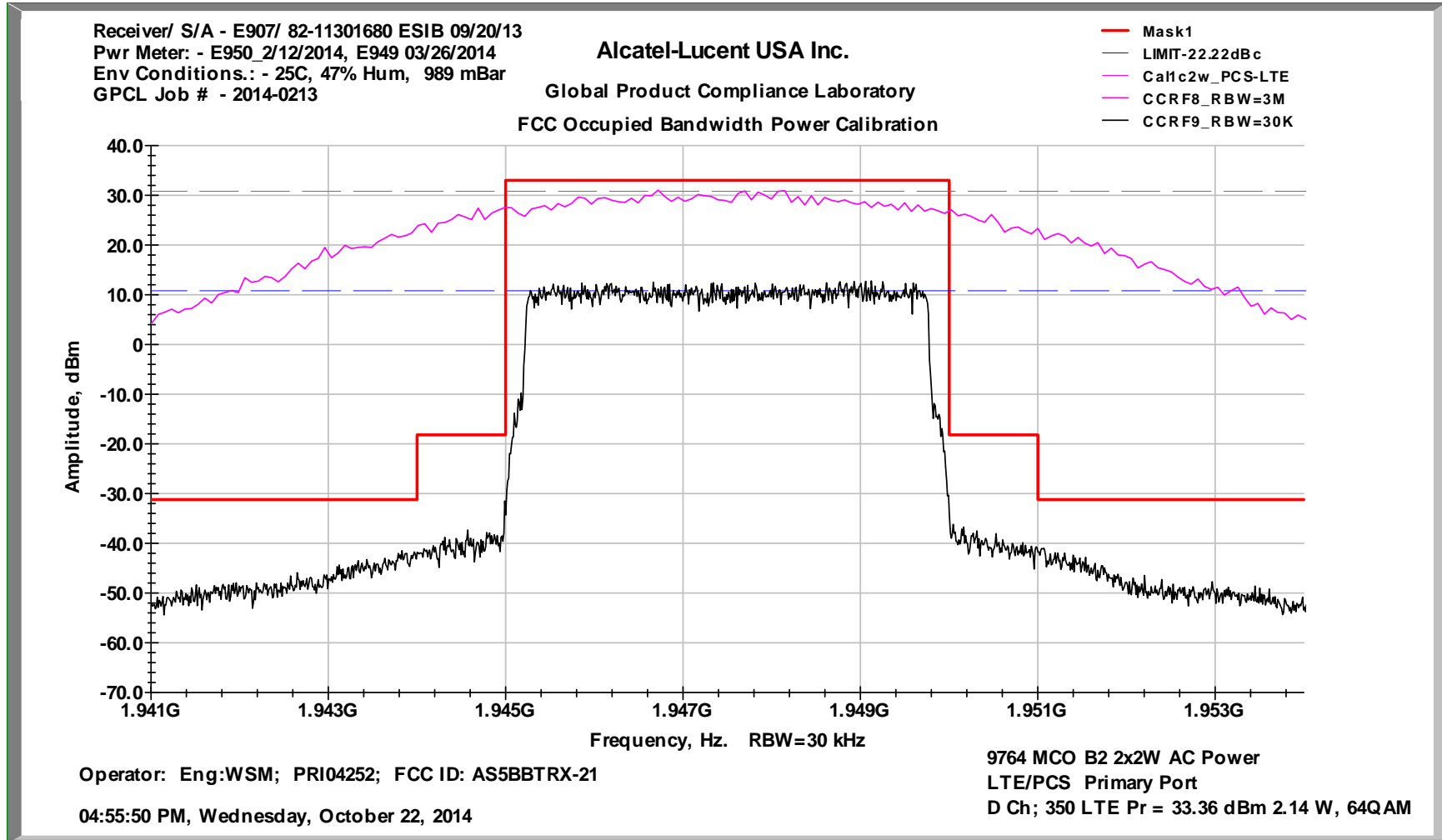

Occupied Bandwidth PCS 2x2W 64QAM Block D Edge of Block Primary

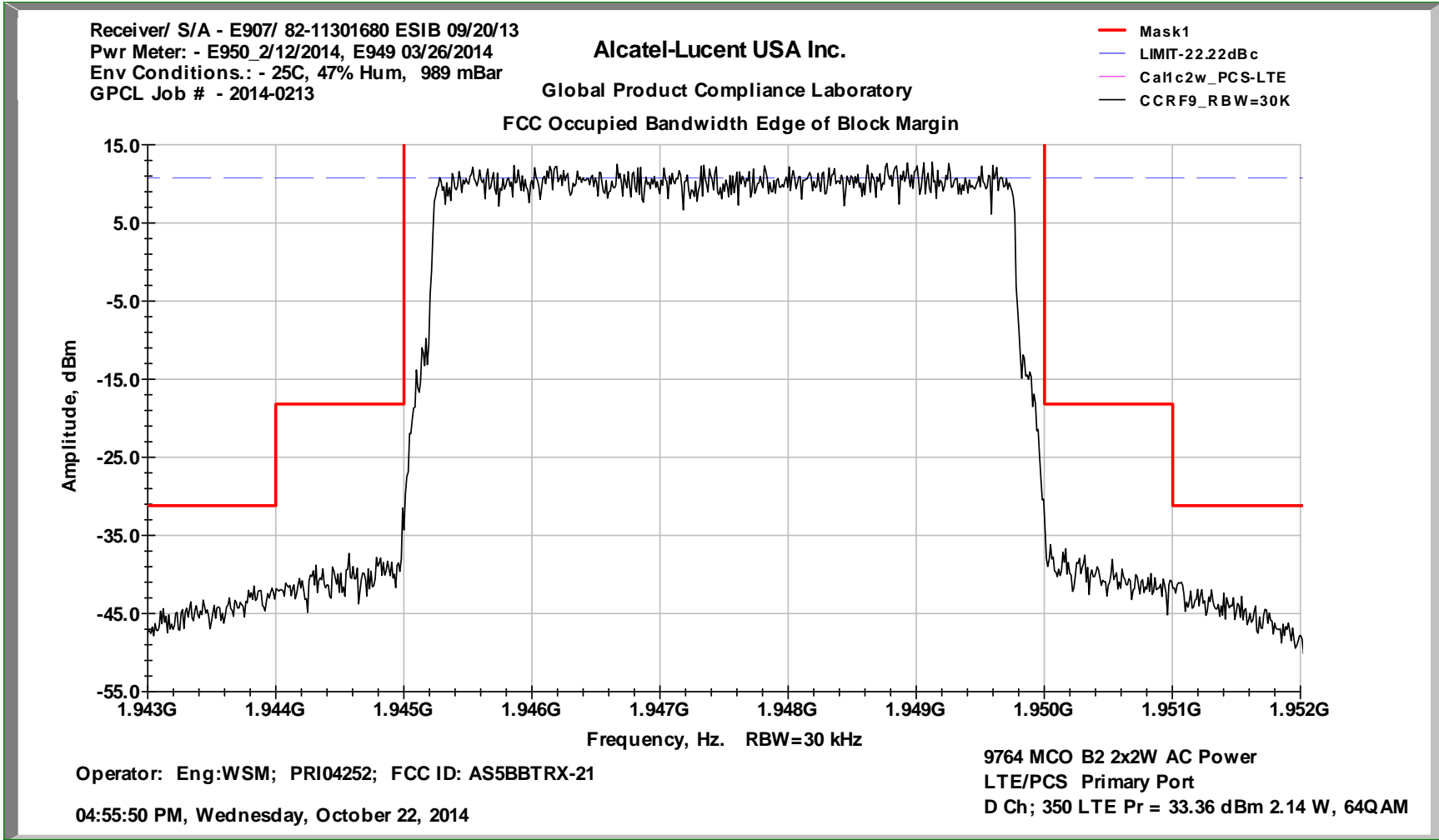

Occupied Bandwidth PCS 2x2W 64QAM Block D Diversity

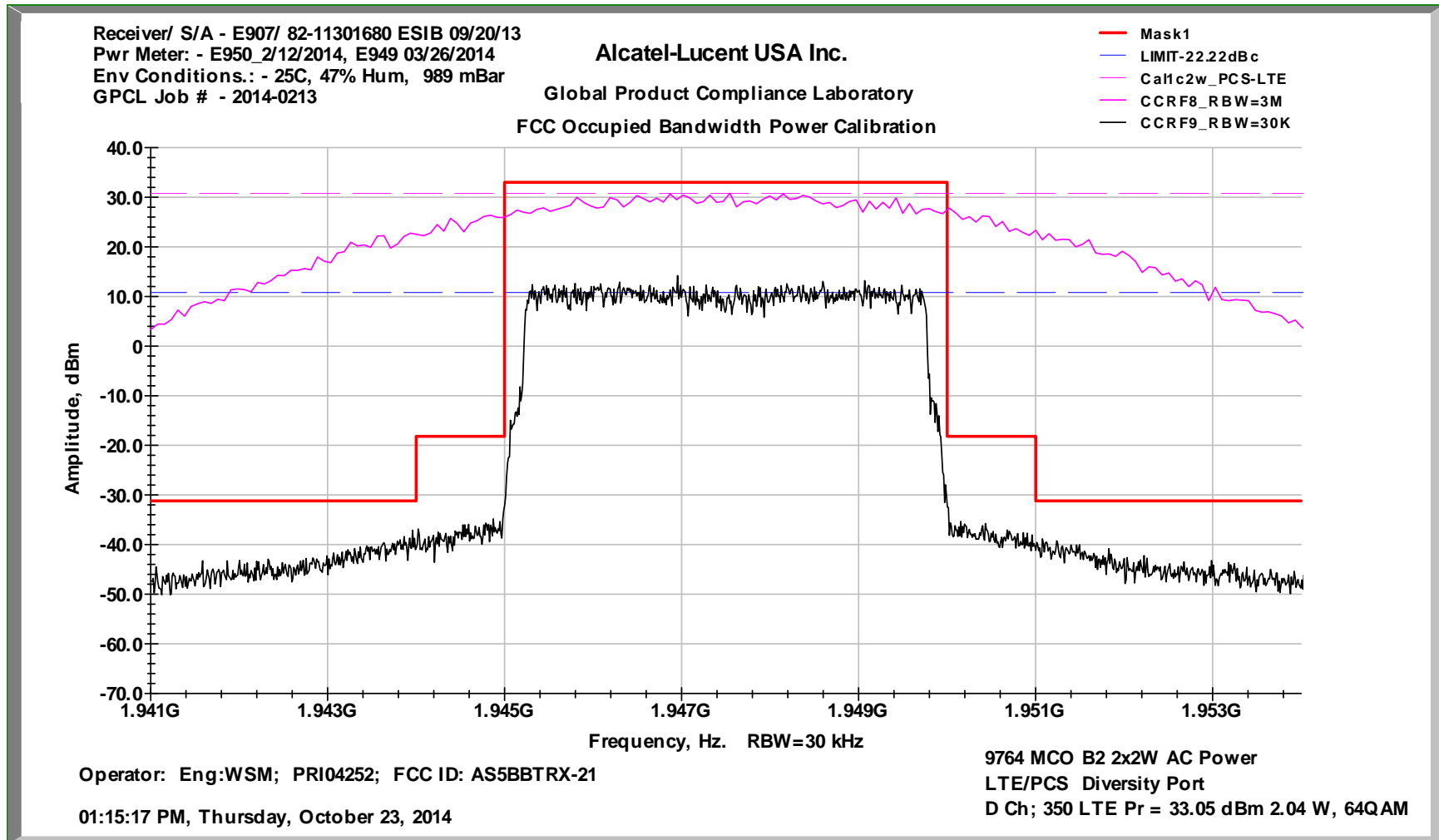

Occupied Bandwidth PCS 2x2W 3 Modulations 64QAM 16QAM QPSK Block D Diversity

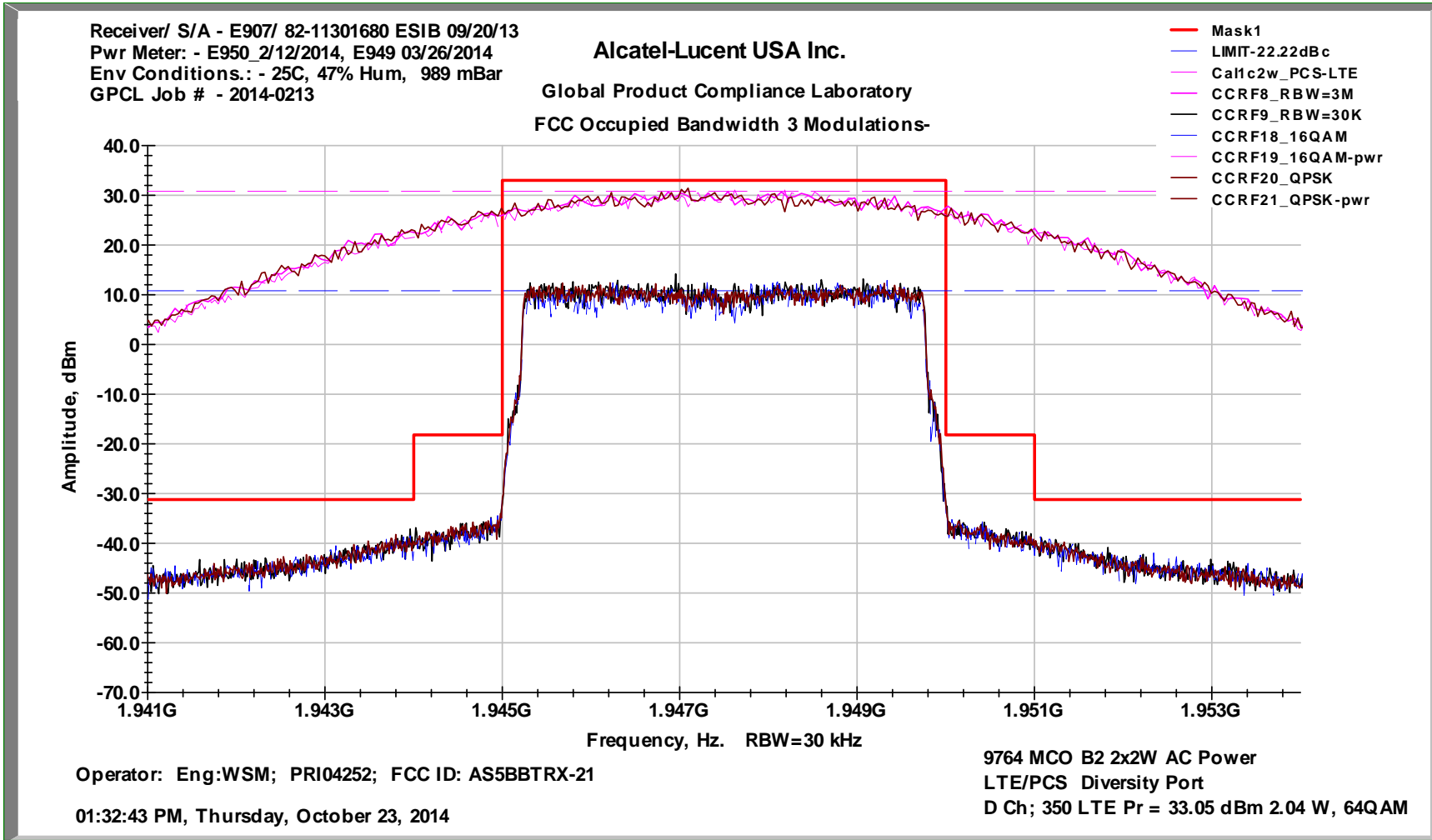

Occupied Bandwidth PCS 2x2W 64QAM Block D Edge of Block Diversity

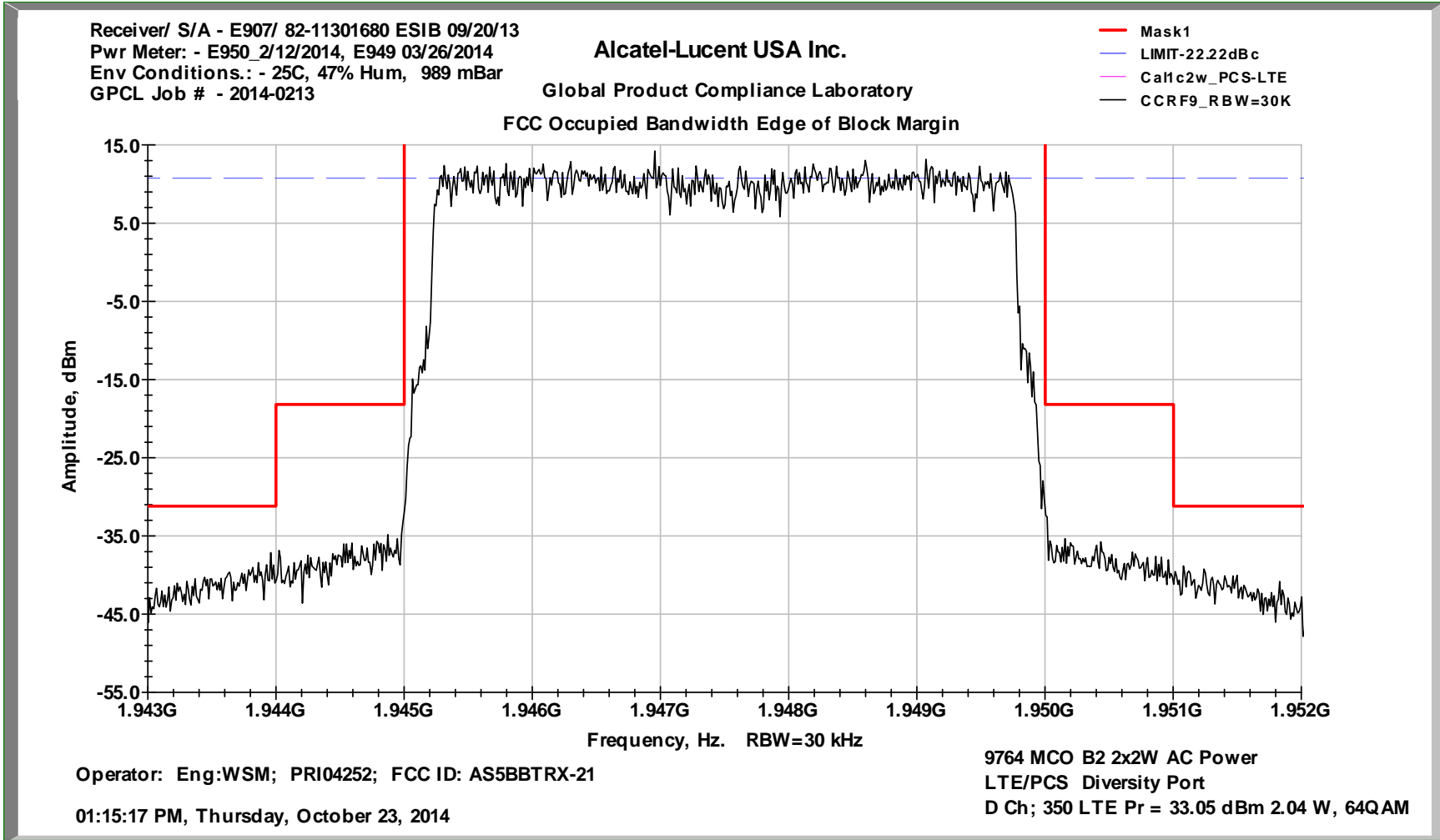

Occupied Bandwidth PCS 2x2W 64QAM Block B1 Primary

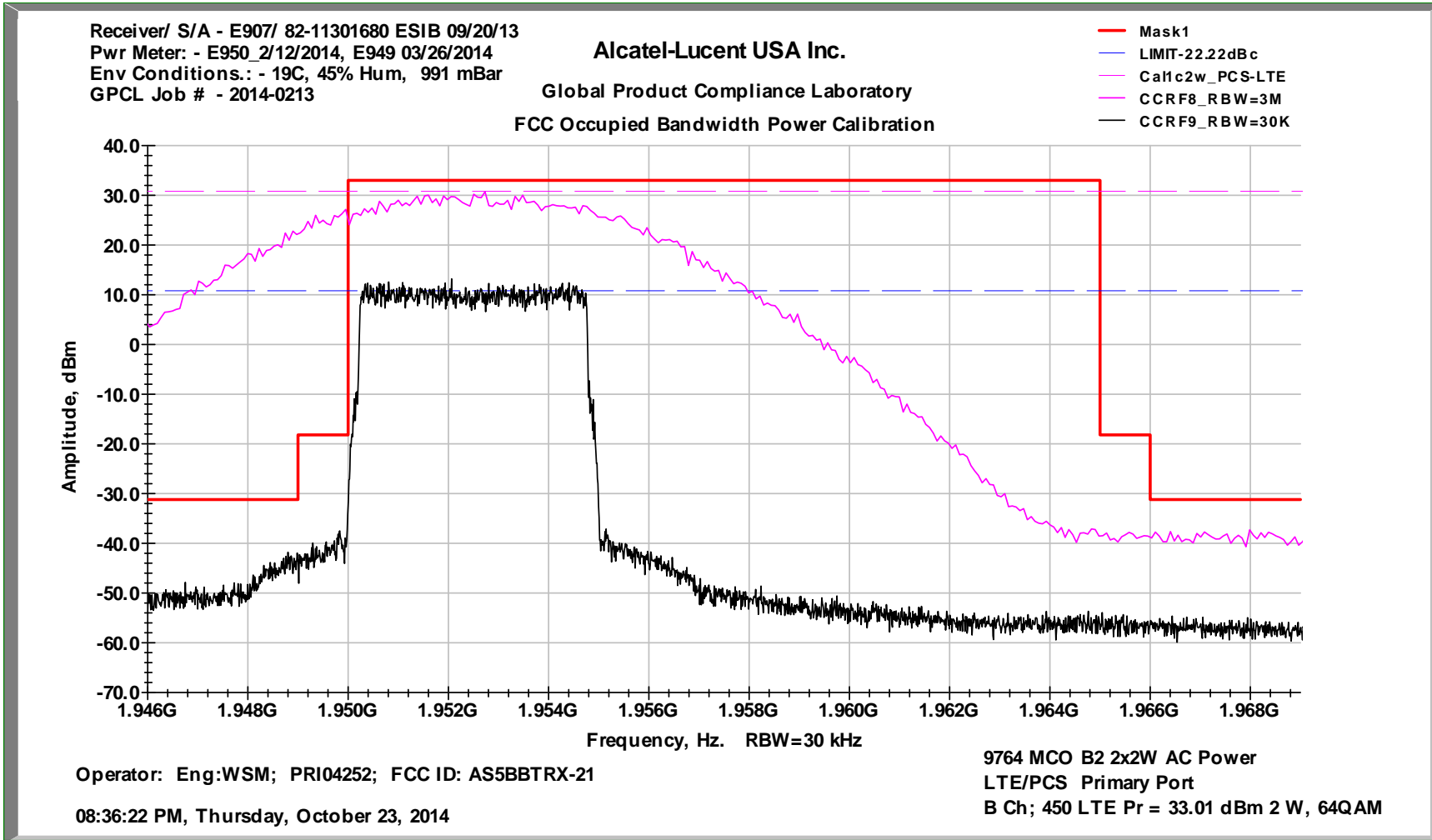

Occupied Bandwidth PCS 2x2W 3 Modulations 64QAM 16QAM QPSK Block B1 Primary

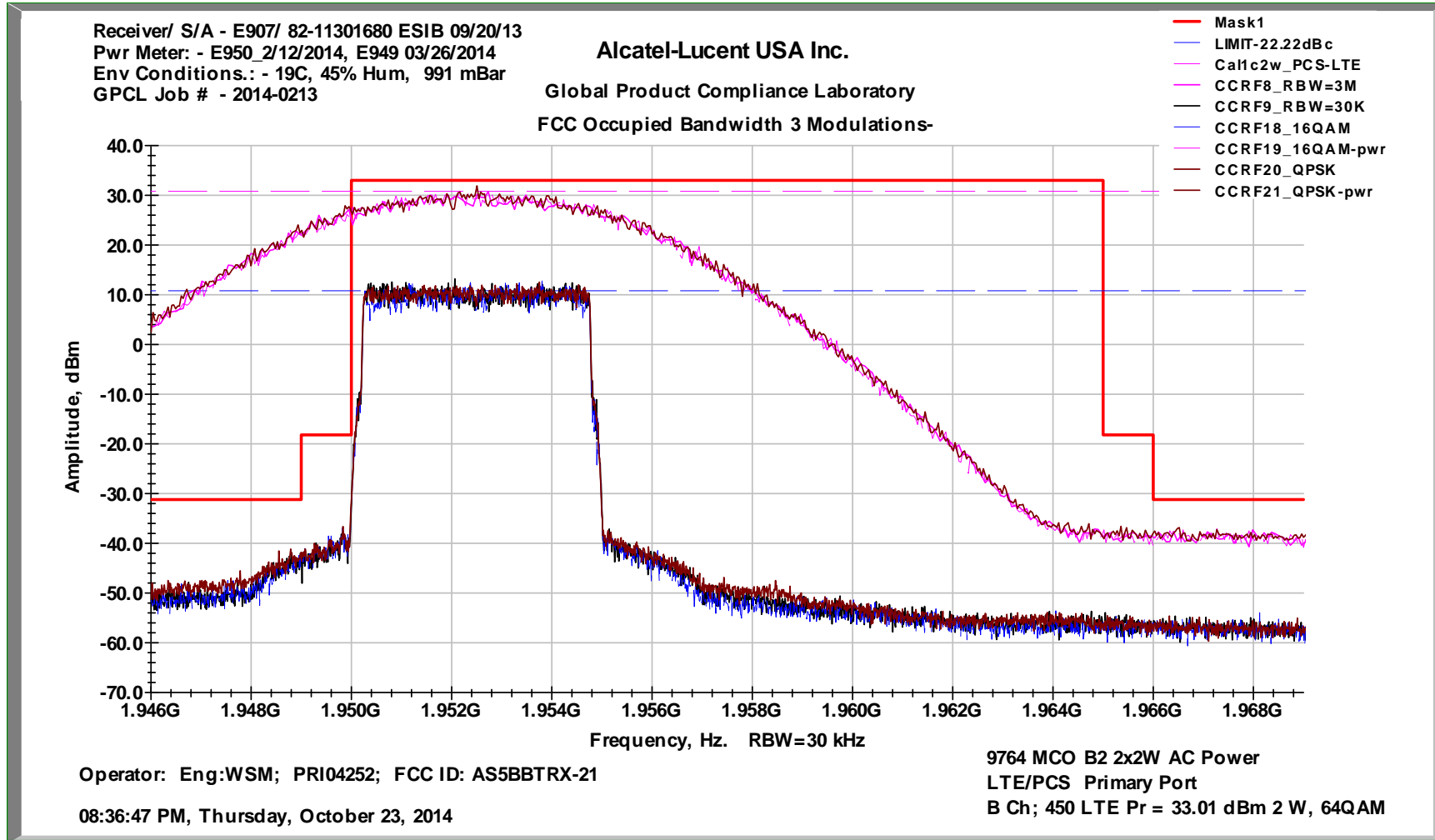

Occupied Bandwidth PCS 2x2W 64QAM Block B1 Edge of Block Primary

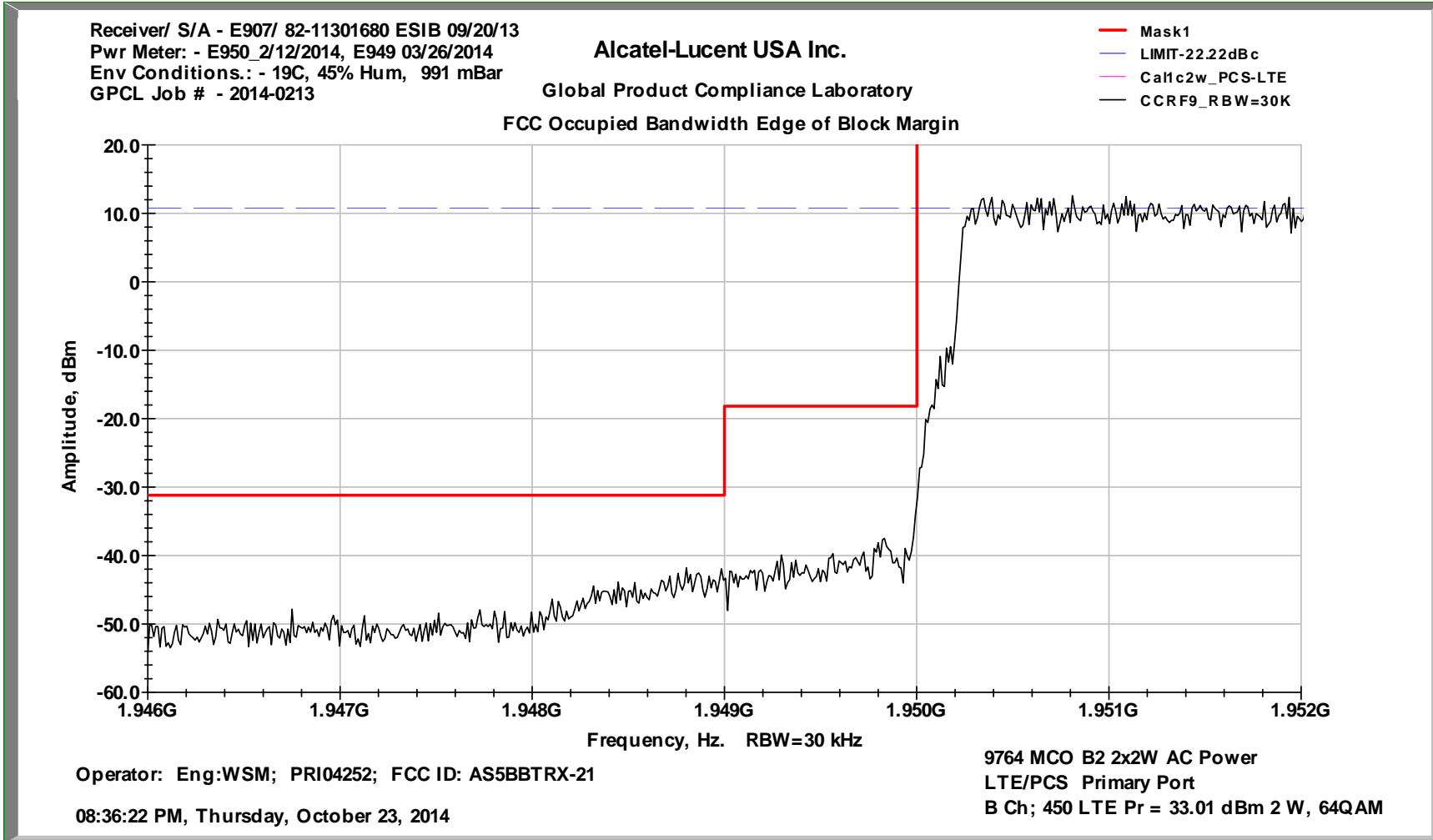

Occupied Bandwidth PCS 2x2W 64QAM Block B1 Diversity

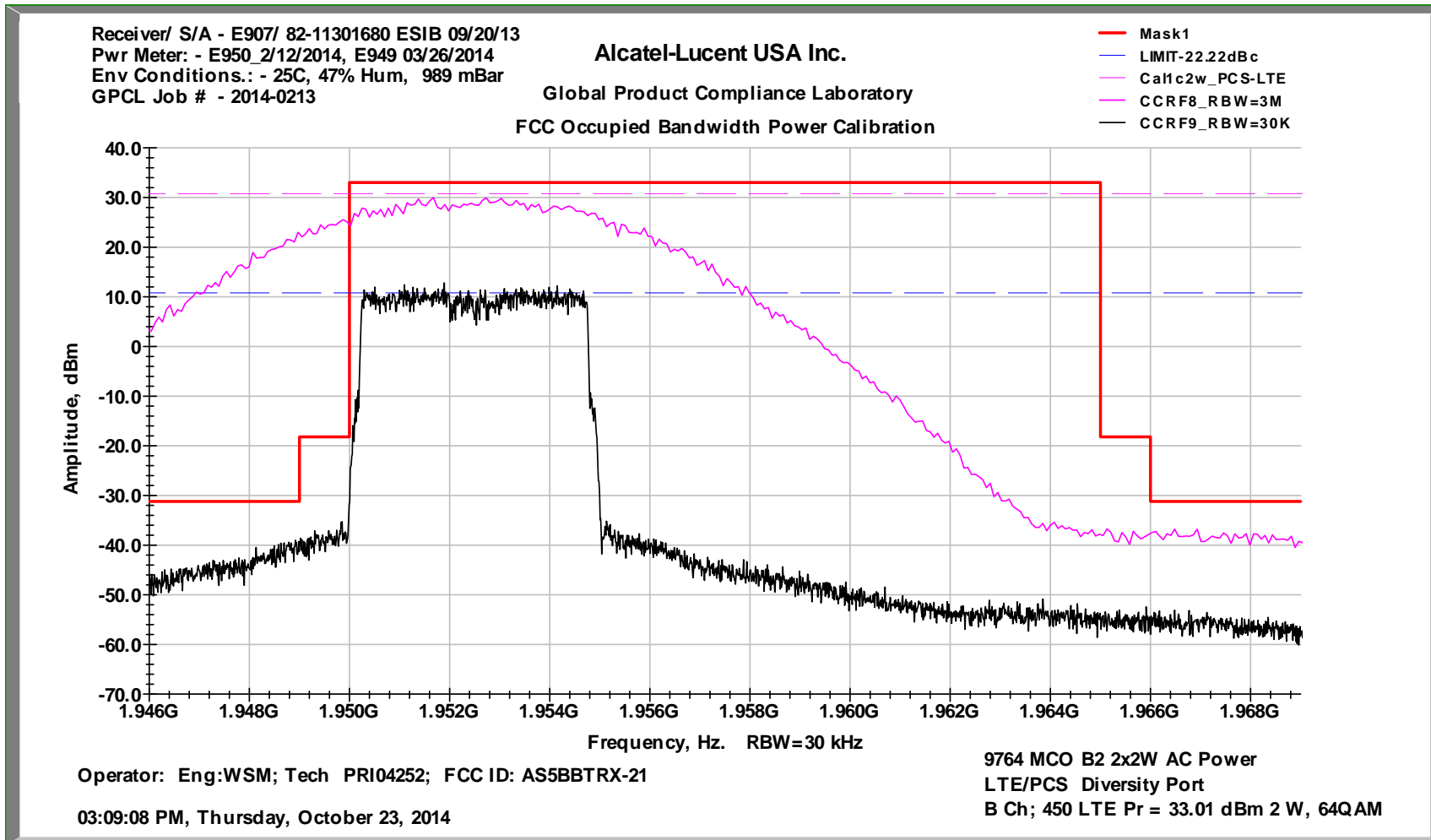

Occupied Bandwidth PCS 2x2W 3 Modulations 64QAM 16QAM QPSK Block B1 Diversity

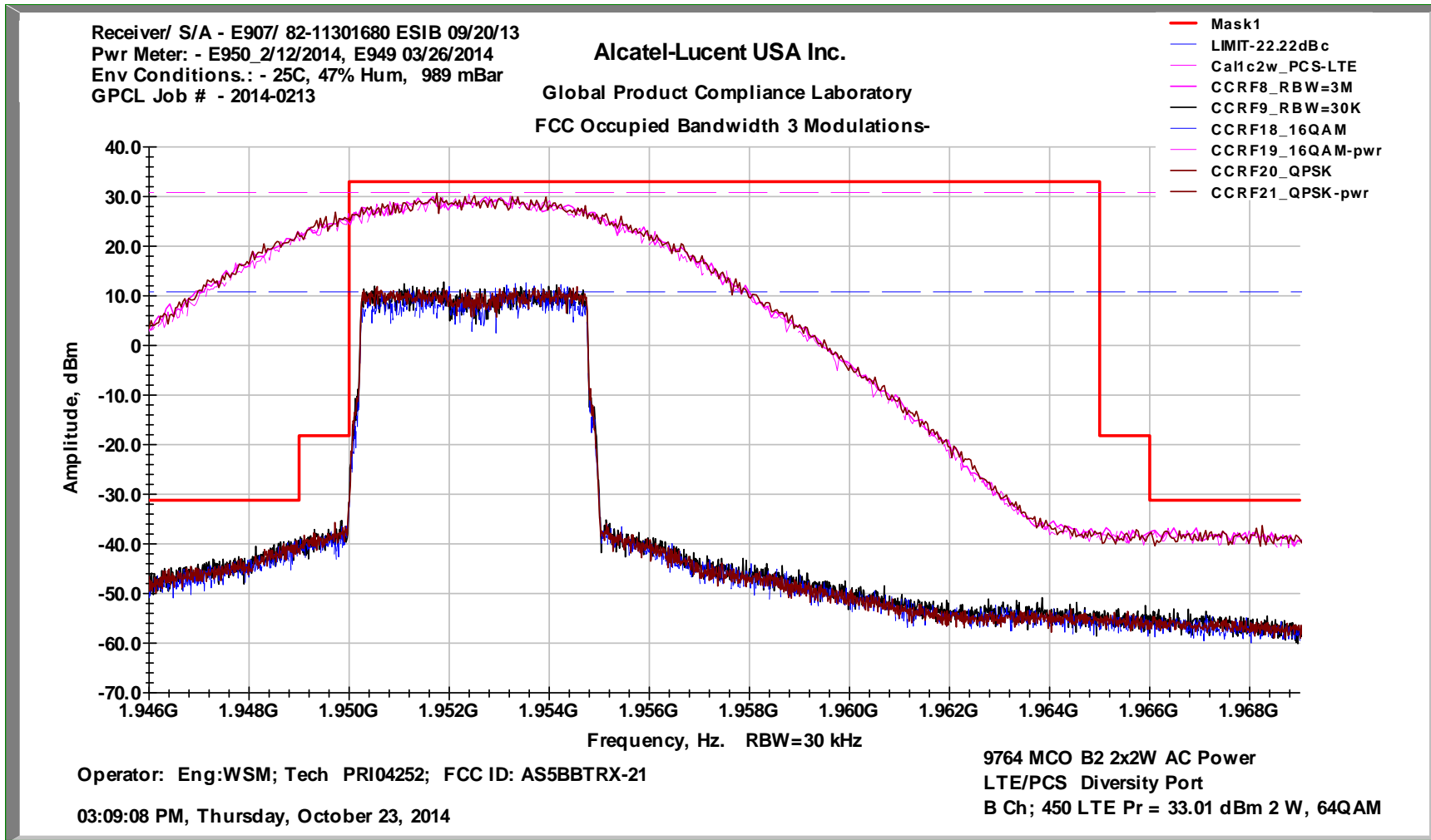

Occupied Bandwidth PCS 2x2W 64QAM Block B1 Edge of Block Diversity

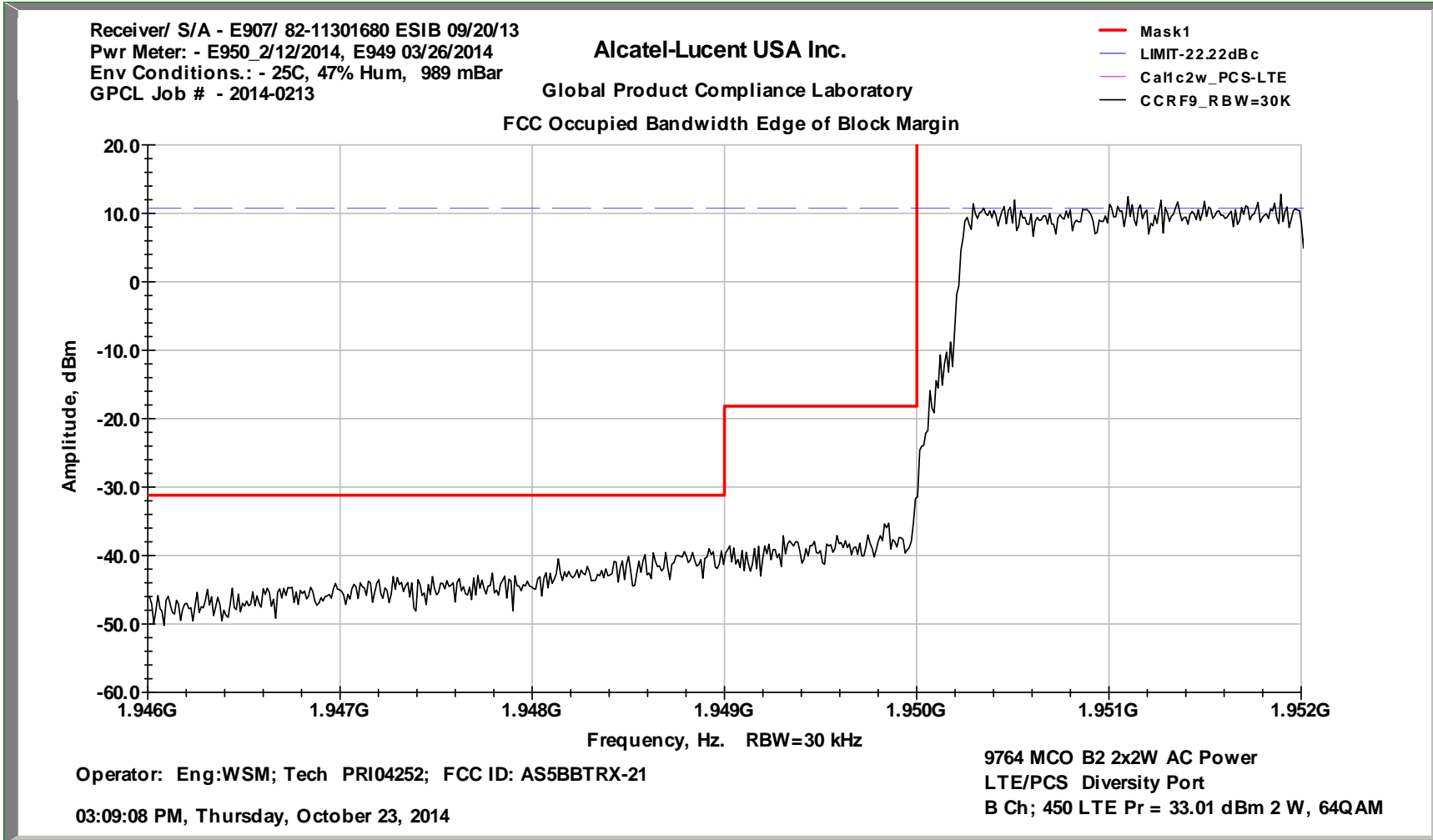

Occupied Bandwidth PCS 2x2W 64QAM Block B5 Primary

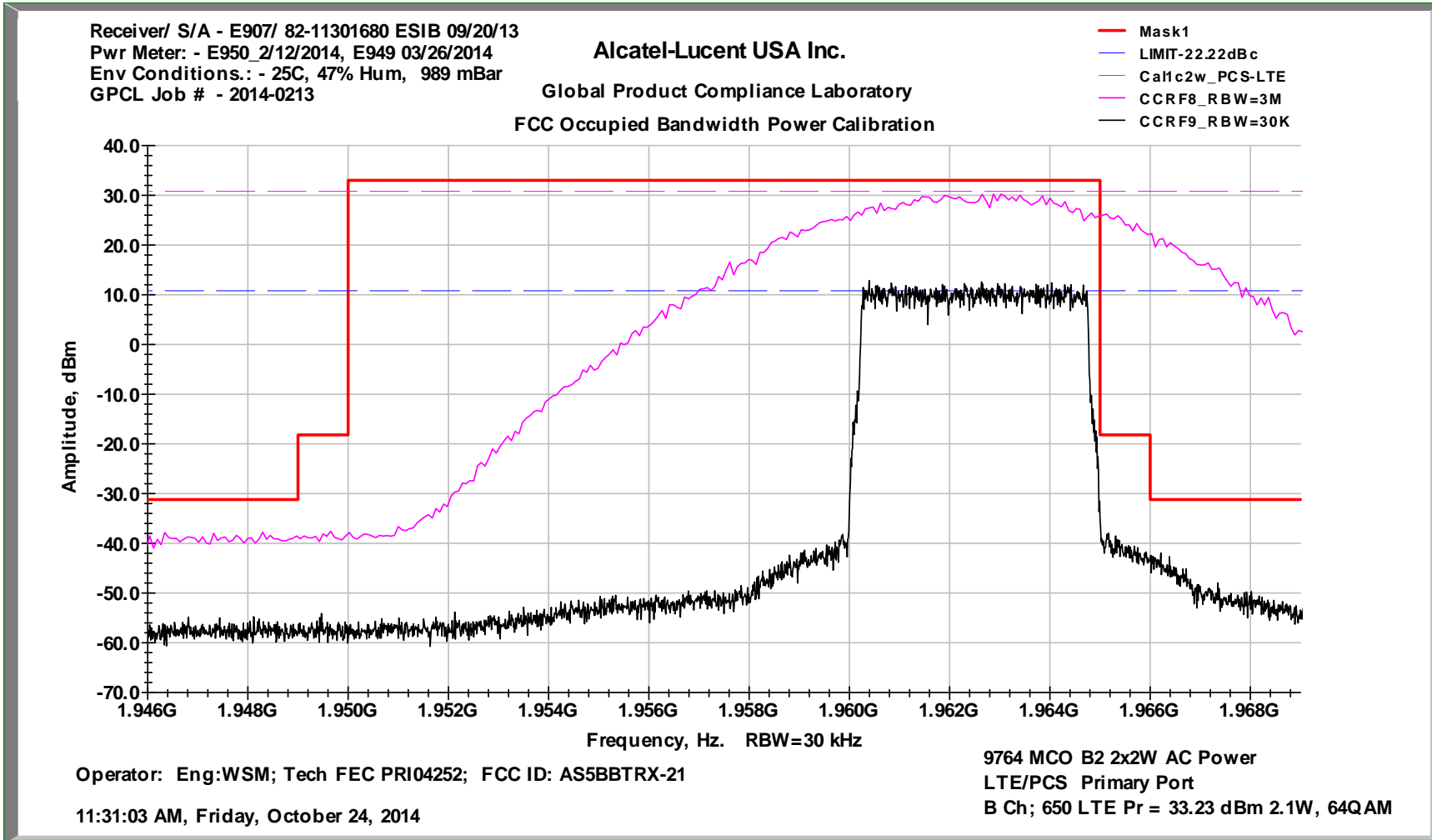

Occupied Bandwidth PCS 2x2W 3 Modulations 64QAM 16QAM QPSK Block B5 Primary

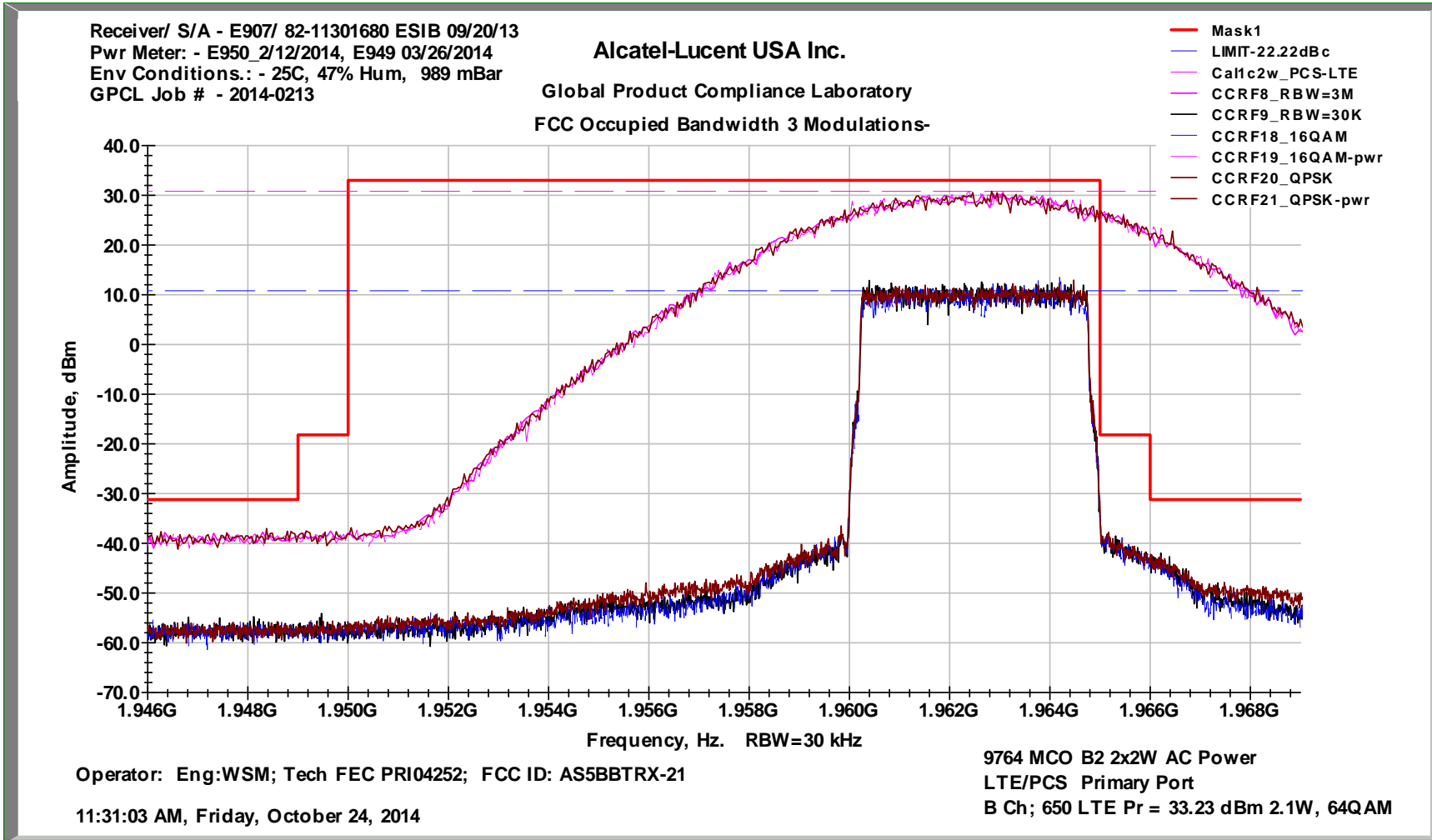

Occupied Bandwidth PCS 2x2W 64QAM Block B5 Edge of Block Primary

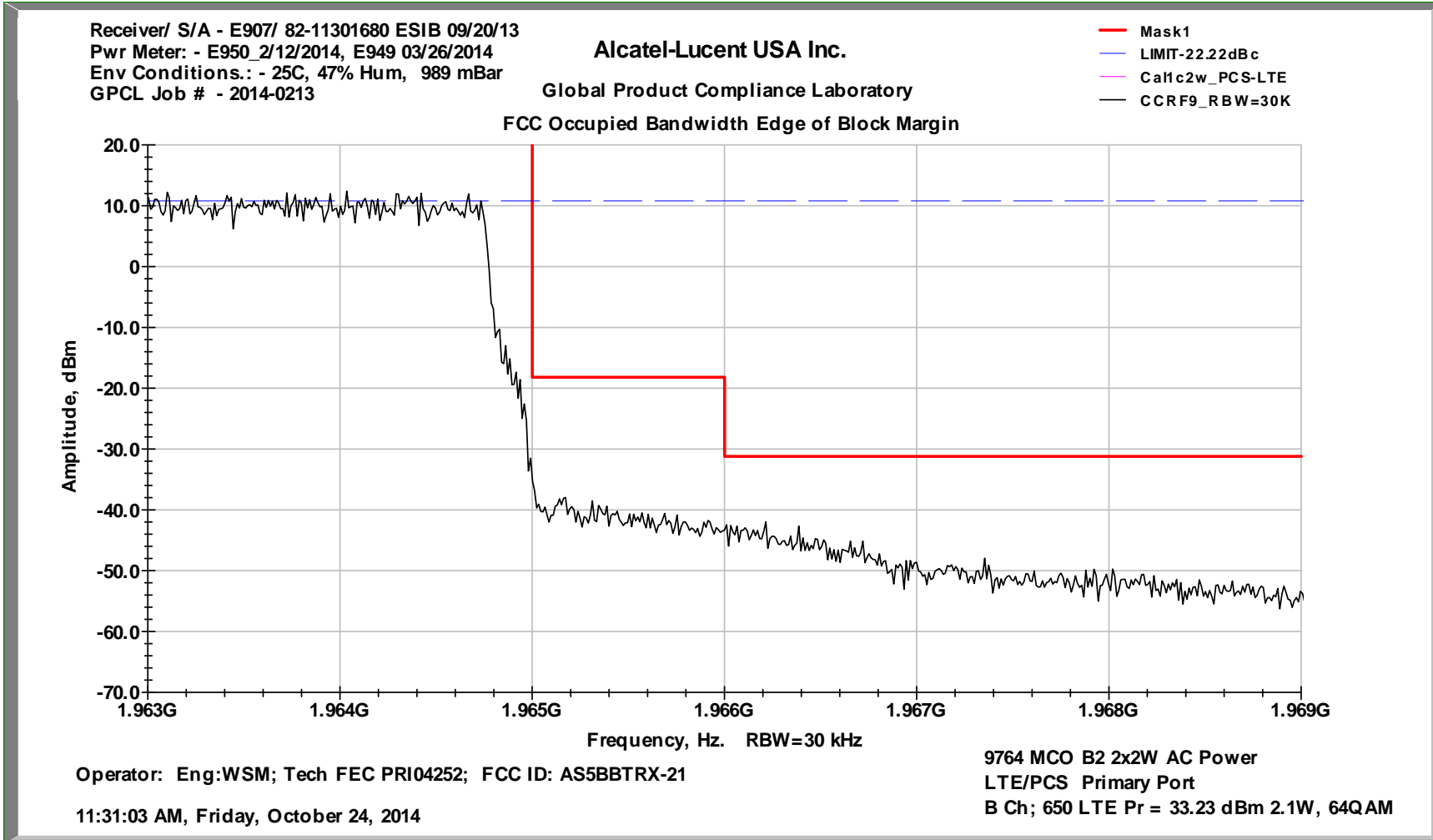

Occupied Bandwidth PCS 2x2W 64QAM Block B5 Diversity

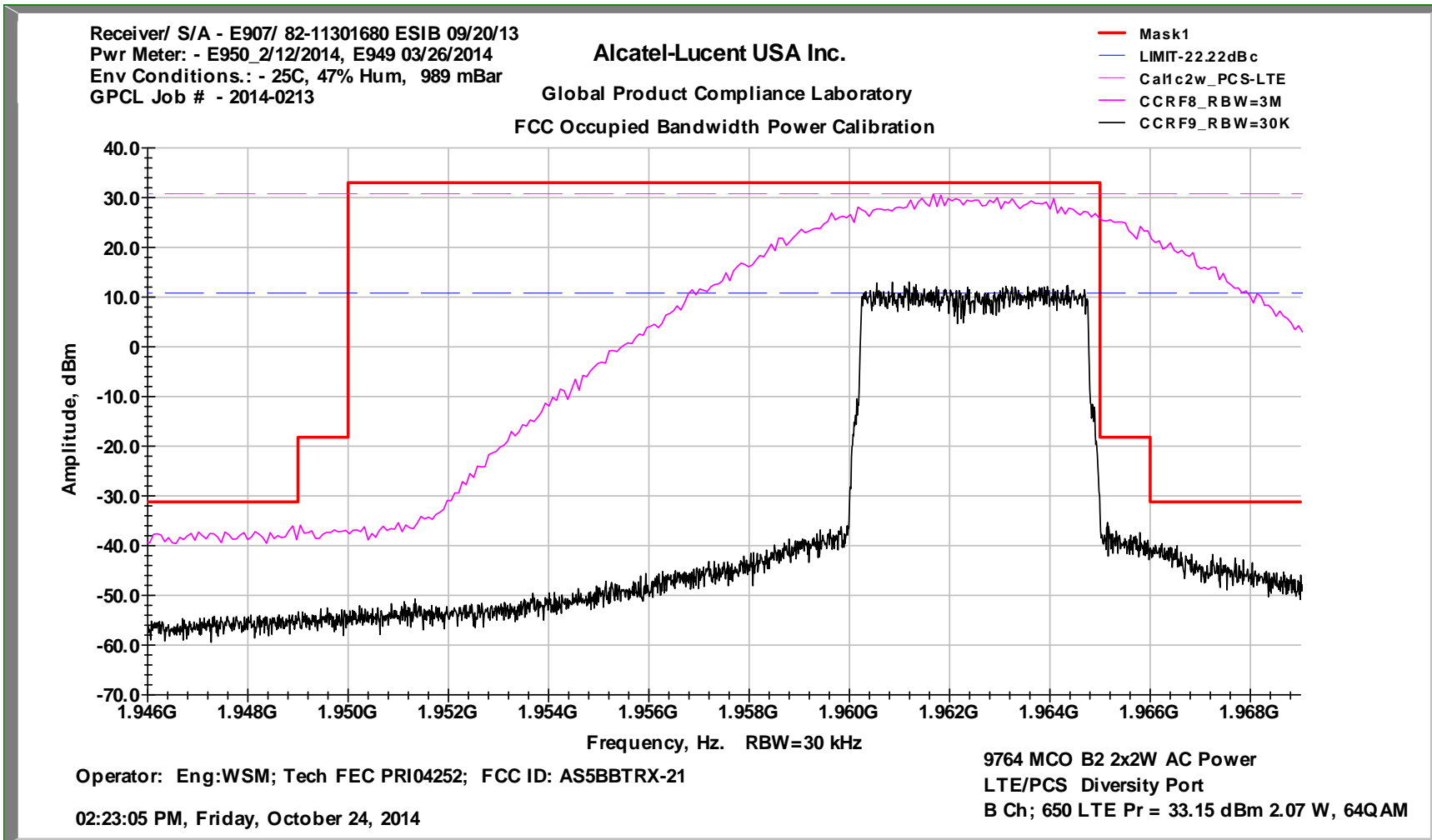

Occupied Bandwidth PCS 2x2W 64QAM Block B5 Edge of Block Diversity

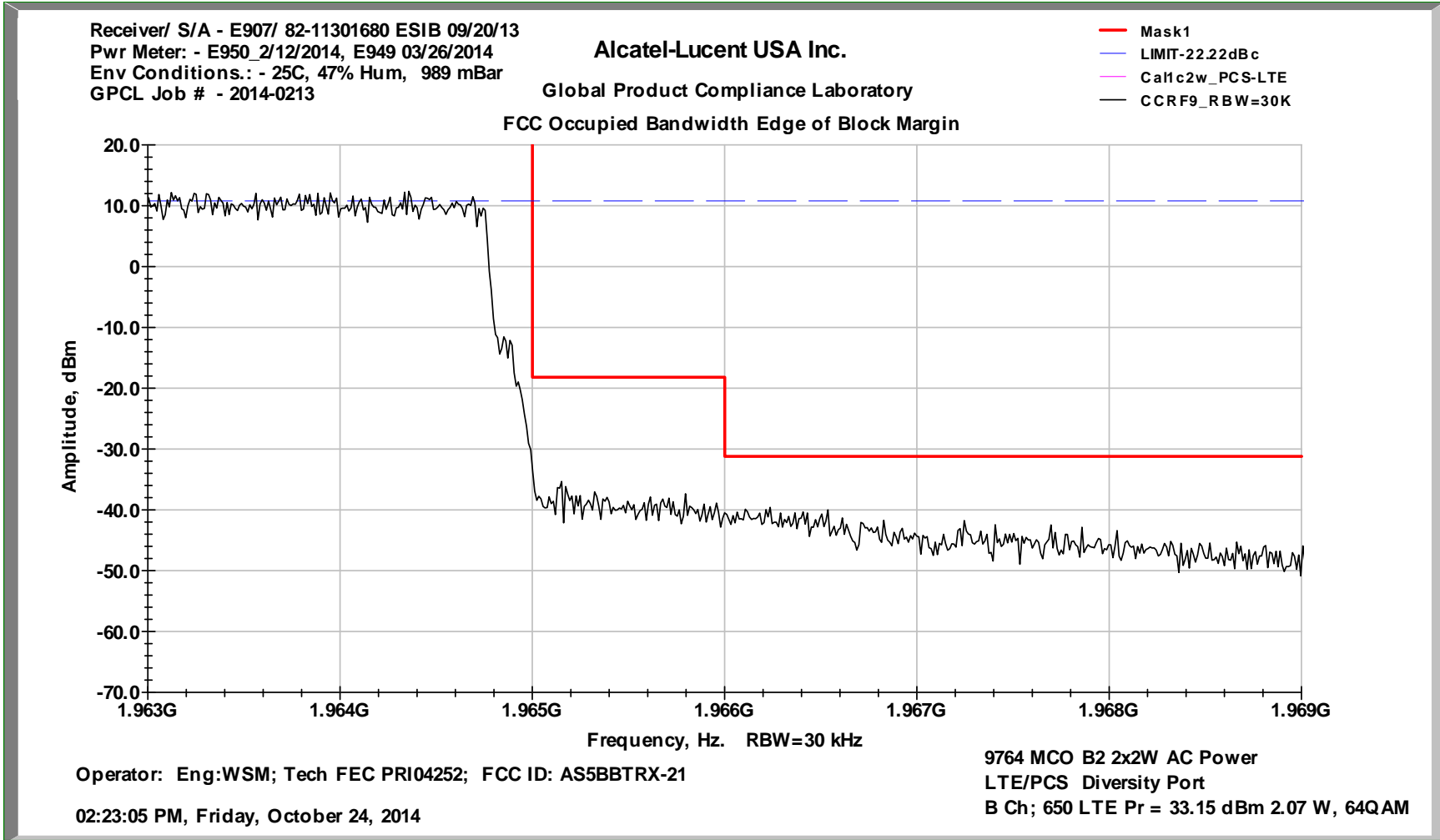

Occupied Bandwidth PCS 2x2W 64QAM Block E Primary

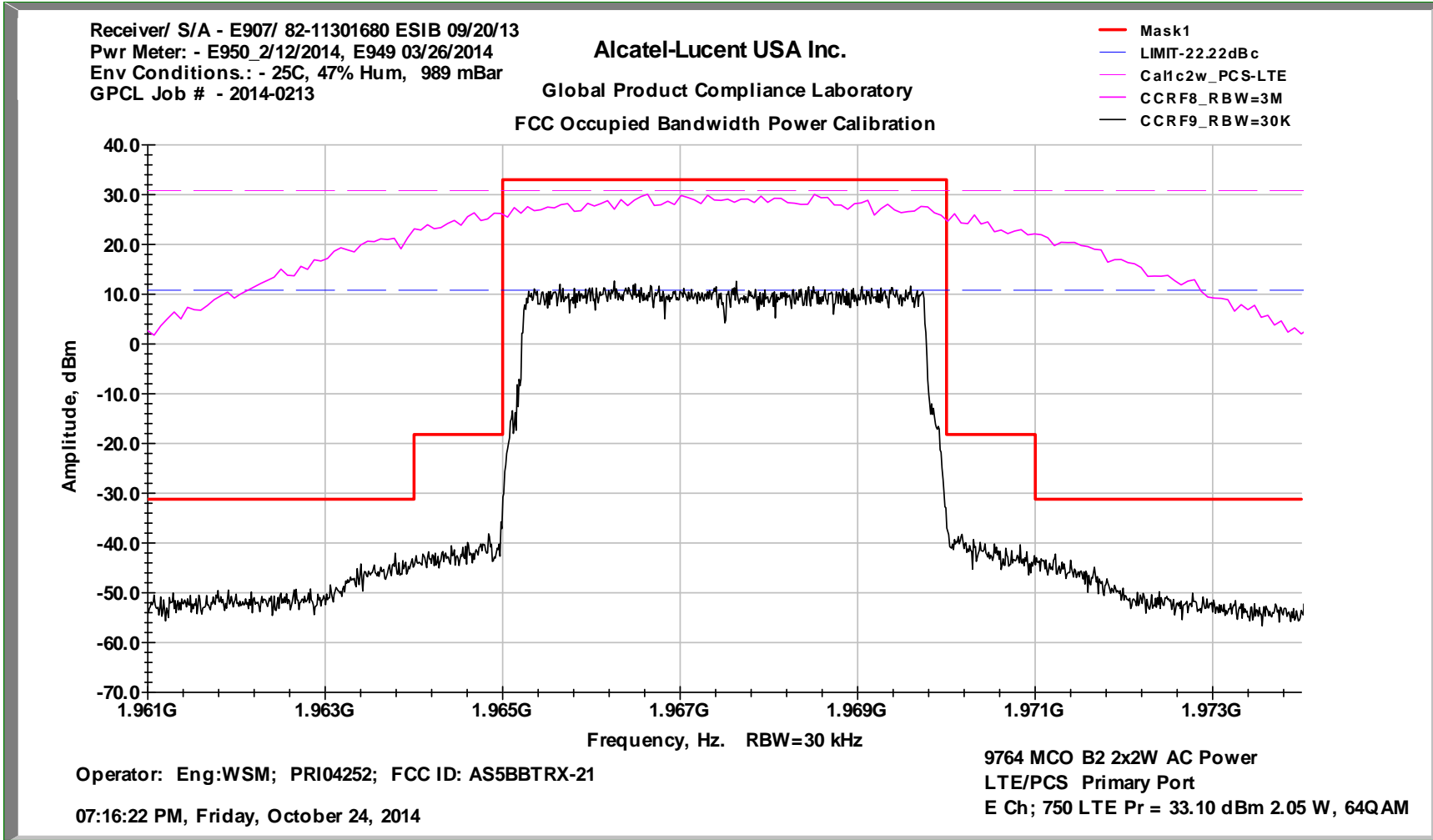

Occupied Bandwidth PCS 2x2W 3 Modulations 64QAM 16QAM QPSK Block E Primary

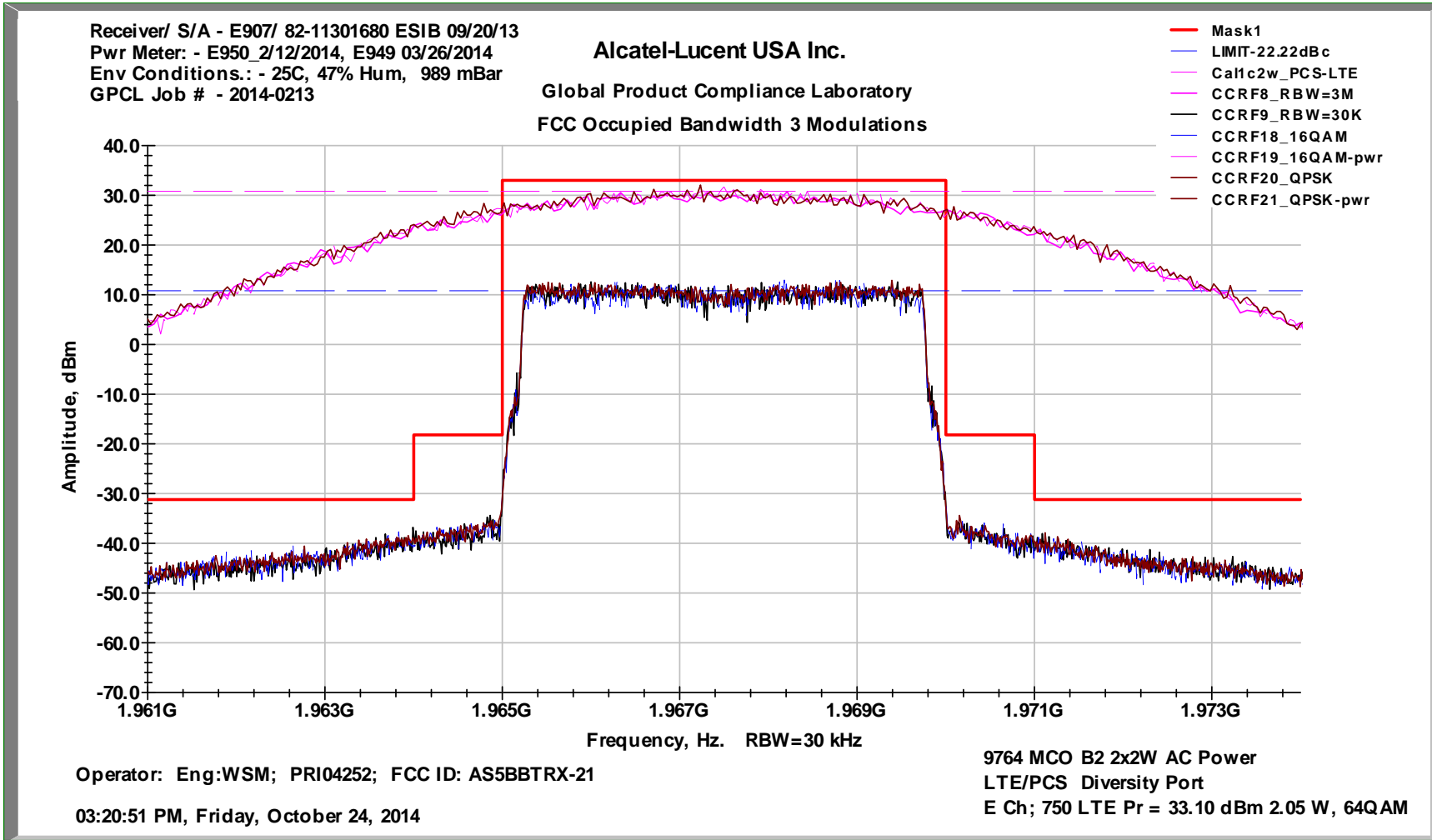

Occupied Bandwidth PCS 2x2W 64QAM Block E Edge of Block Primary

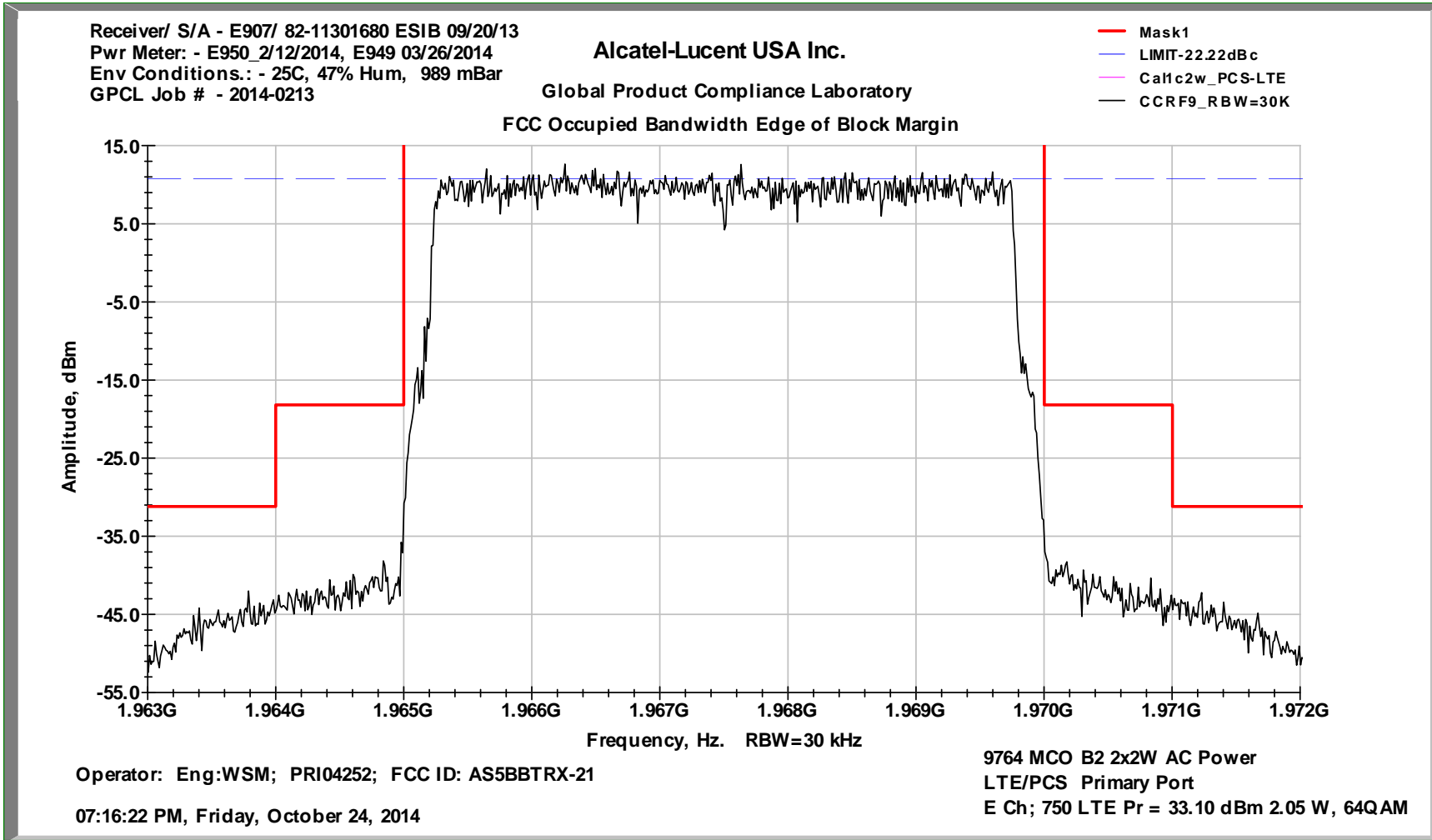

Occupied Bandwidth PCS 2x2W 64QAM Block E Diversity

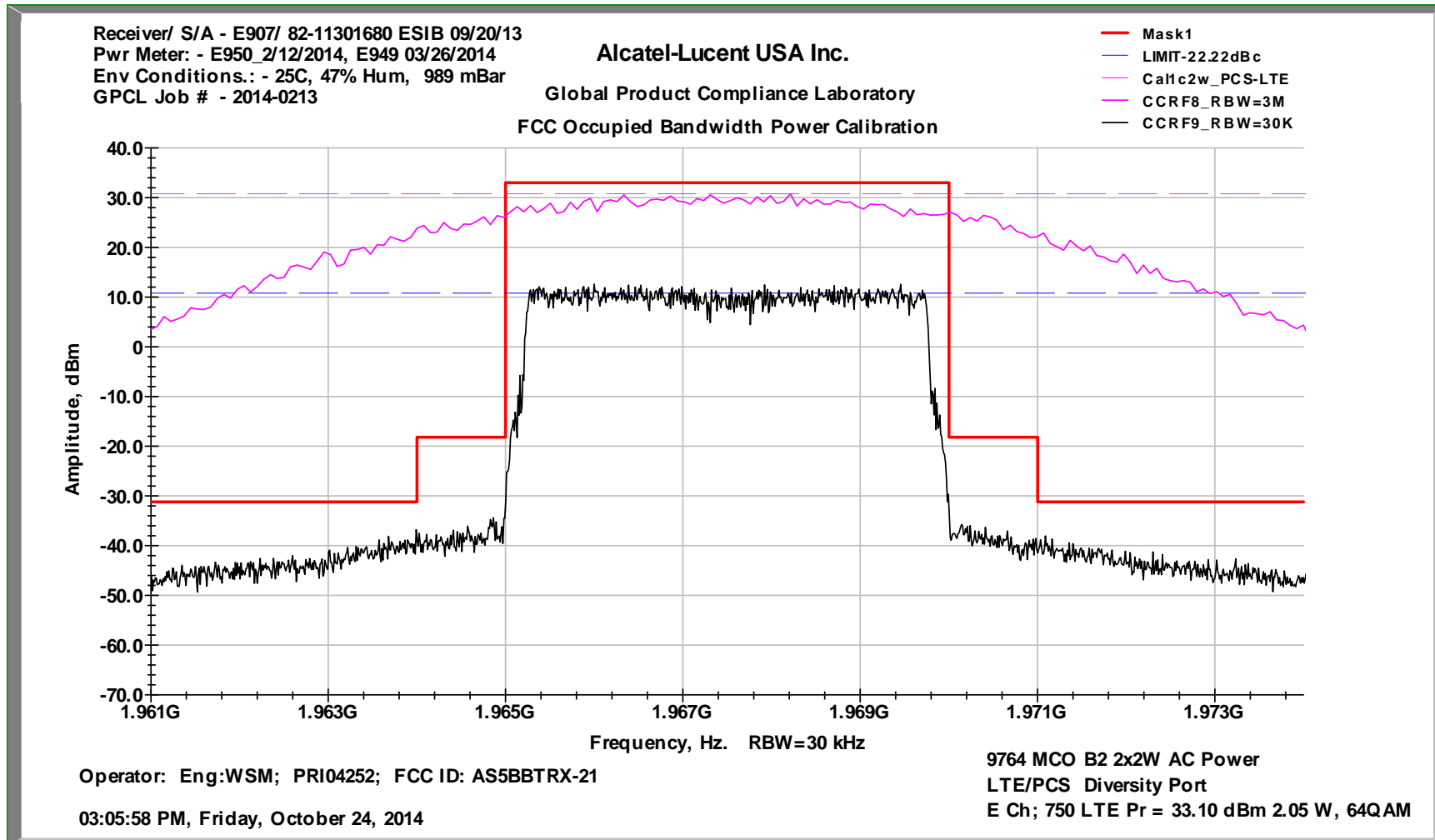

Occupied Bandwidth PCS 2x2W 3 Modulations 64QAM 16QAM QPSK Block E Diversity

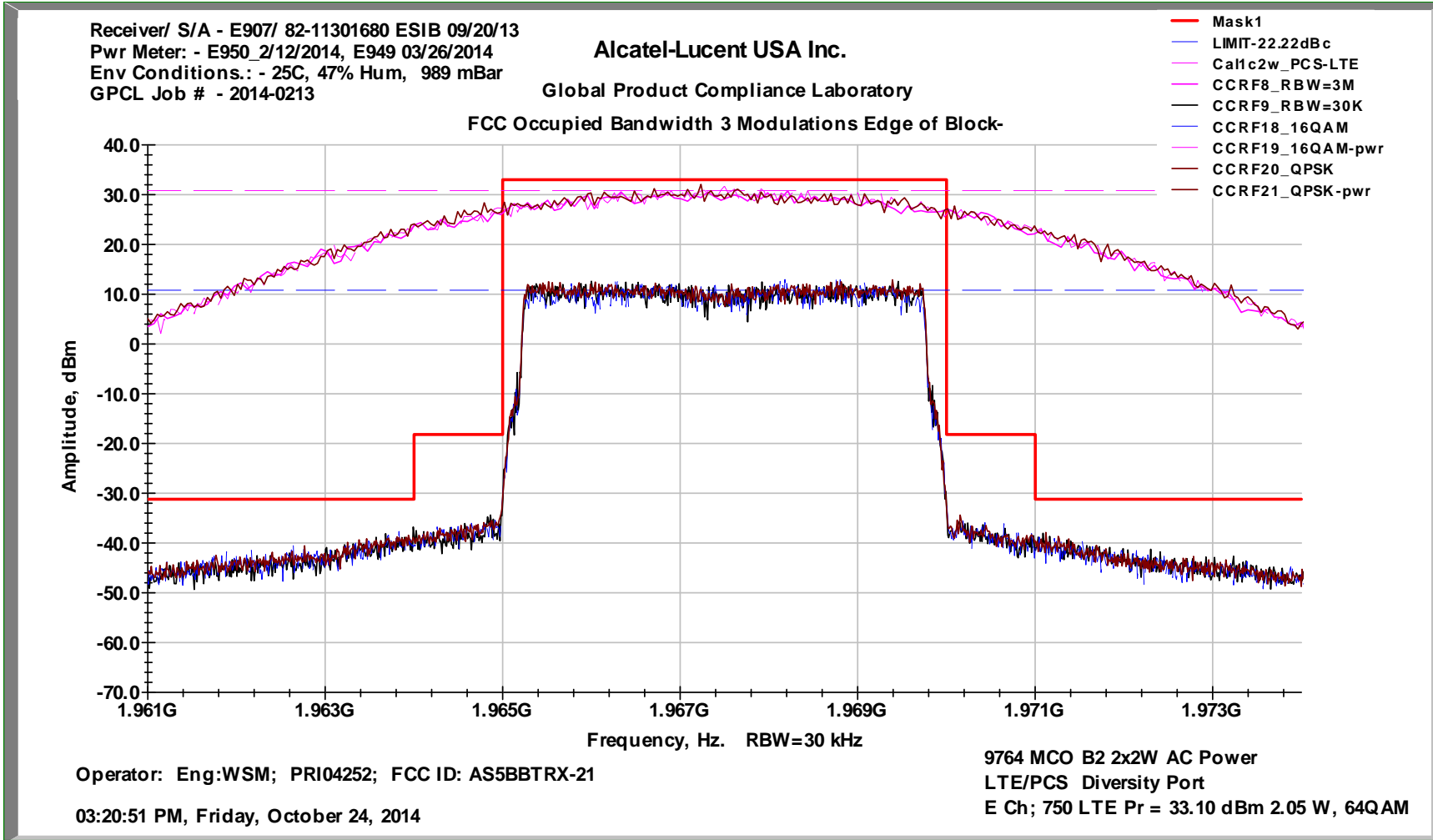

Occupied Bandwidth PCS 2x2W 64QAM Block E Edge of Block Diversity

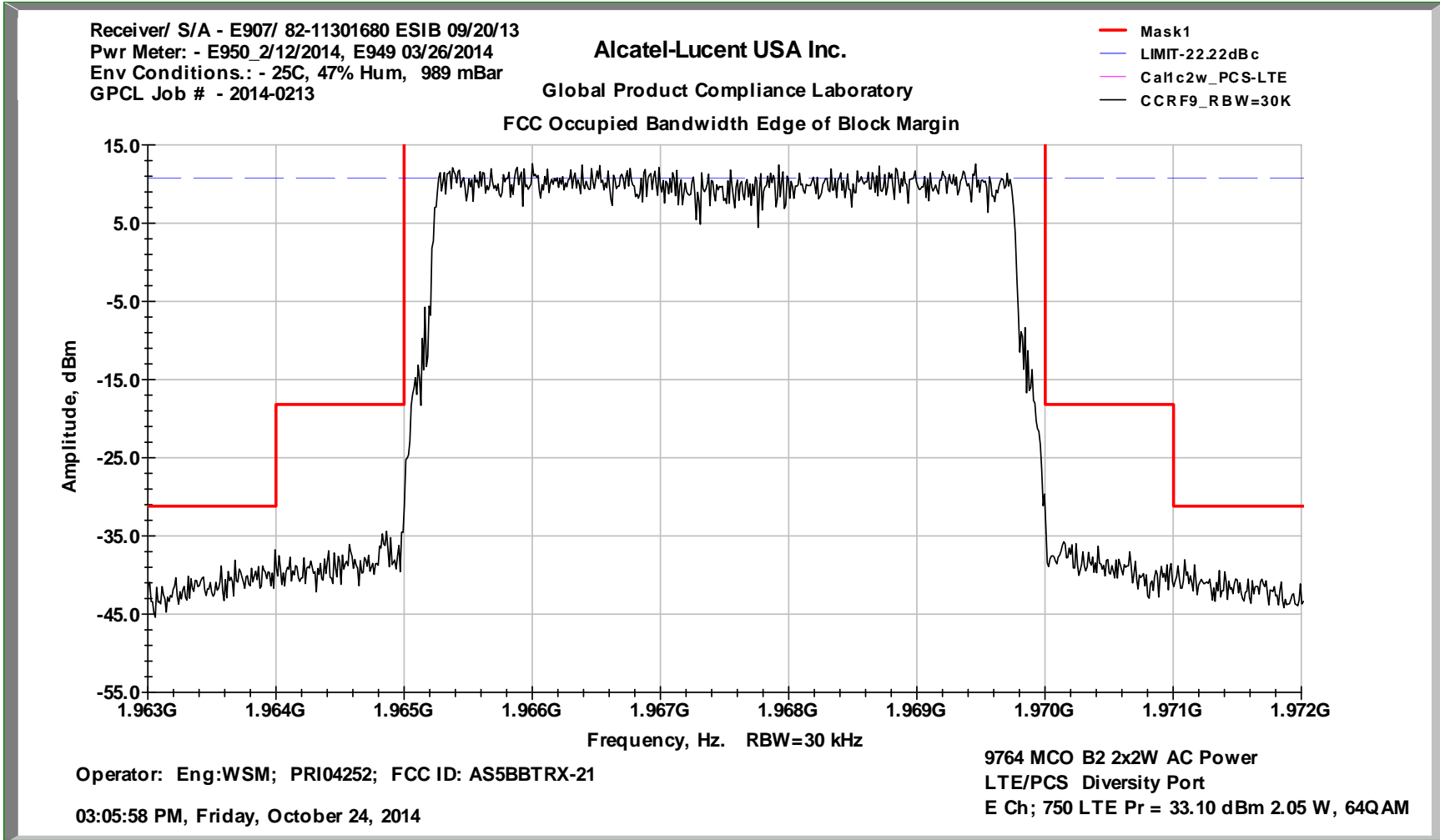

Occupied Bandwidth PCS 2x2W 64QAM Block F Primary

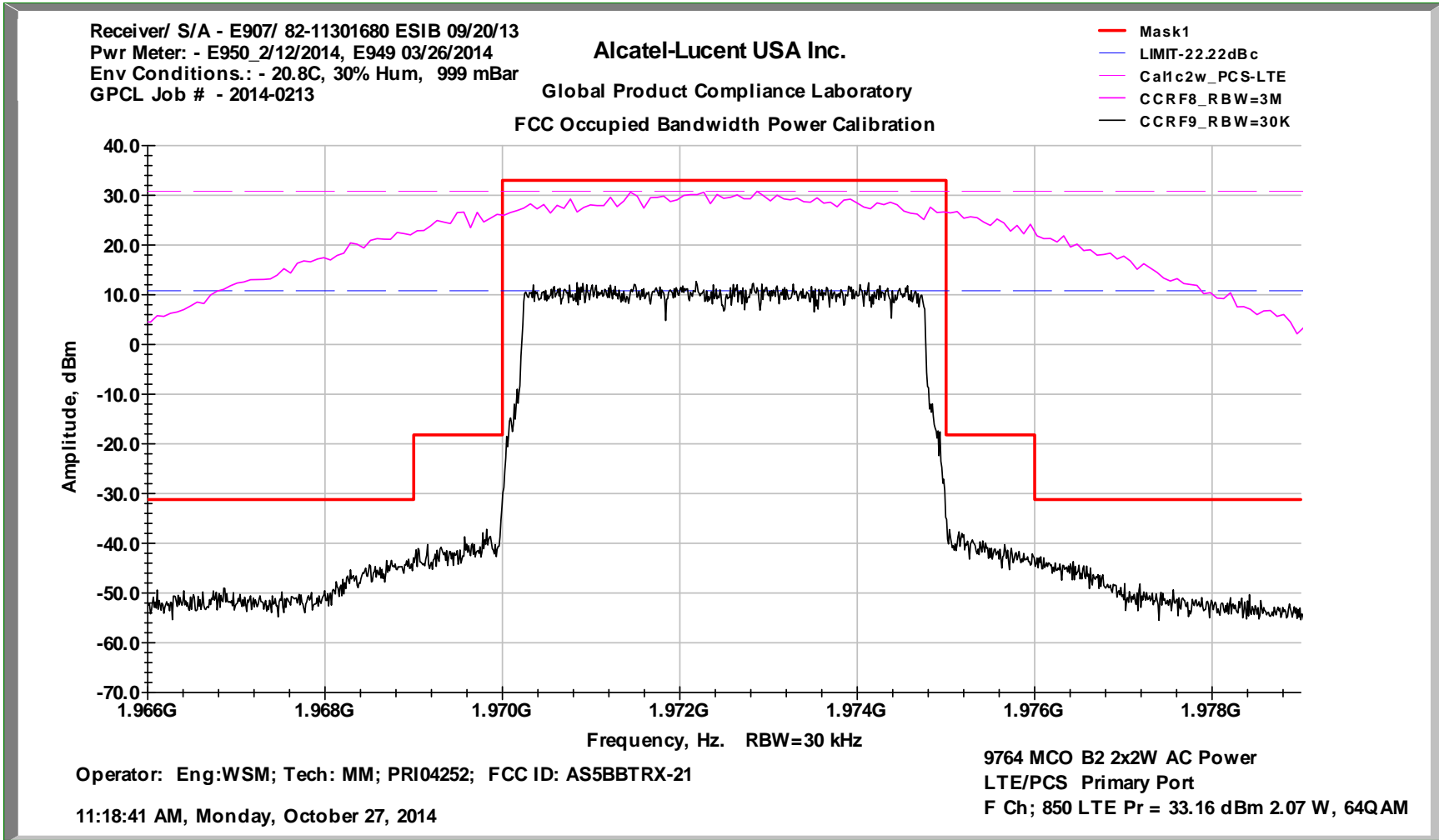

Occupied Bandwidth PCS 2x2W 3 Modulations 64QAM 16QAM QPSK Block F Primary

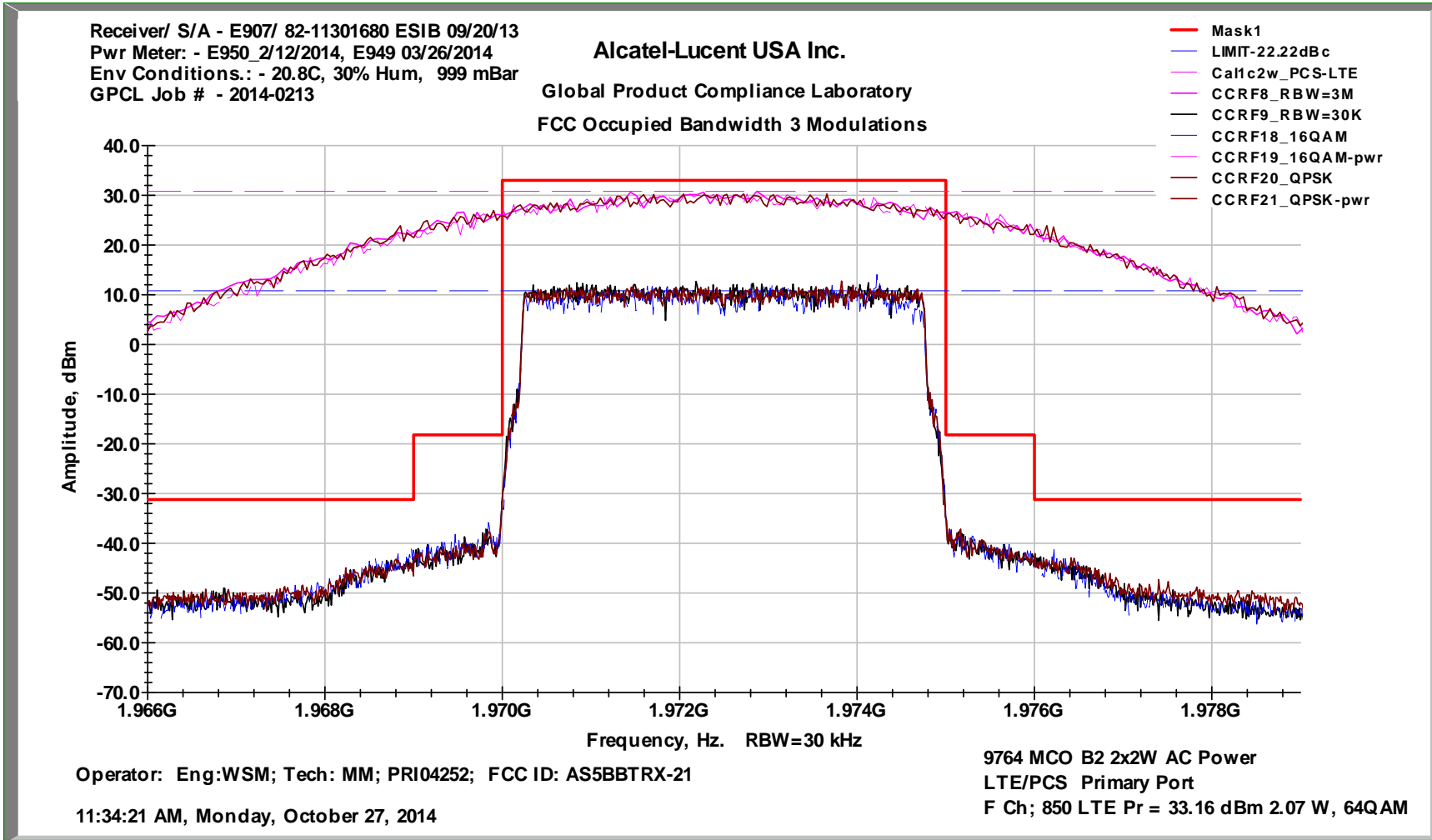

Occupied Bandwidth PCS 2x2W 64QAM Block F Edge of Block Primary

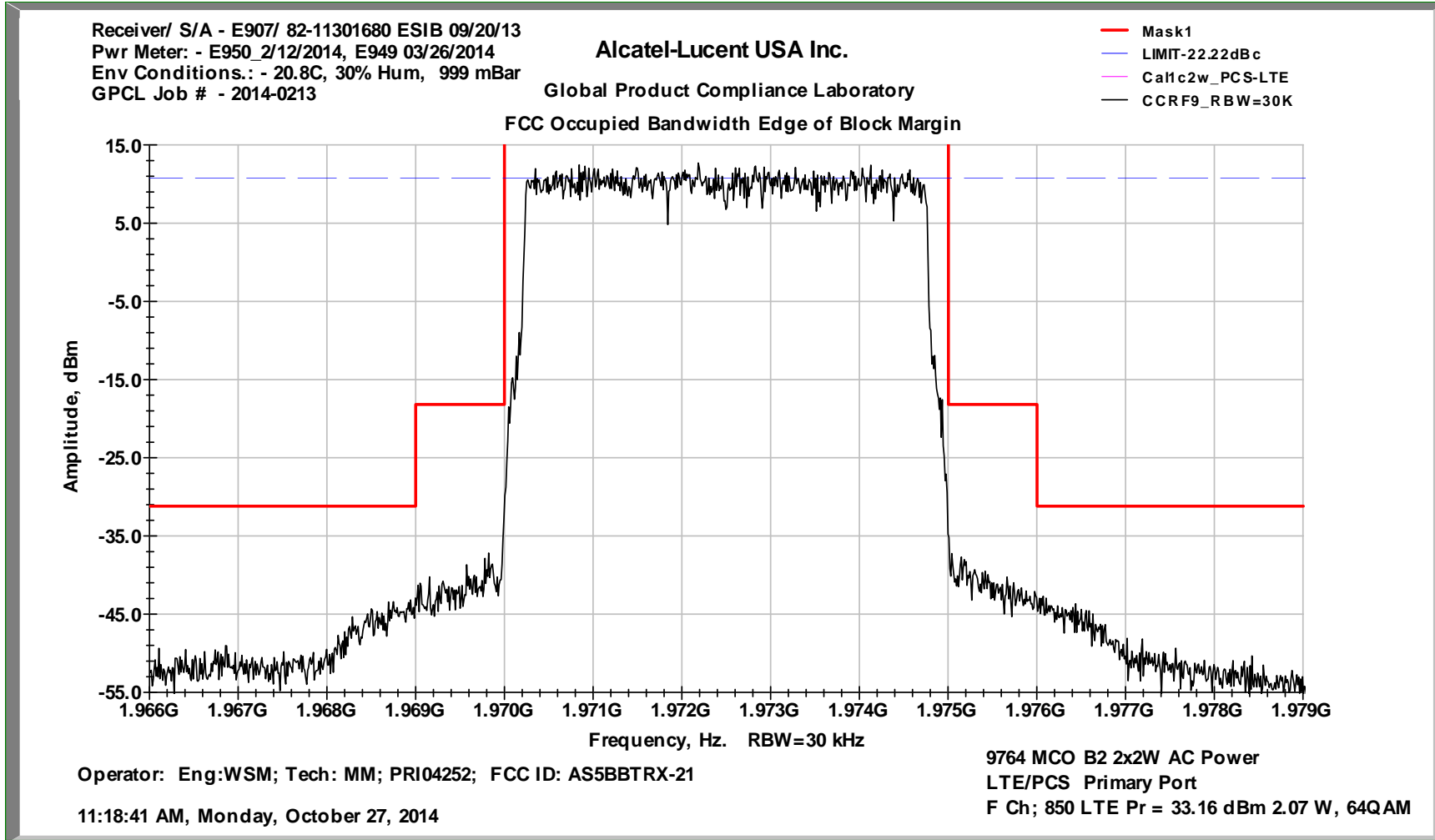

Occupied Bandwidth PCS 2x2W 64QAM Block F Diversity

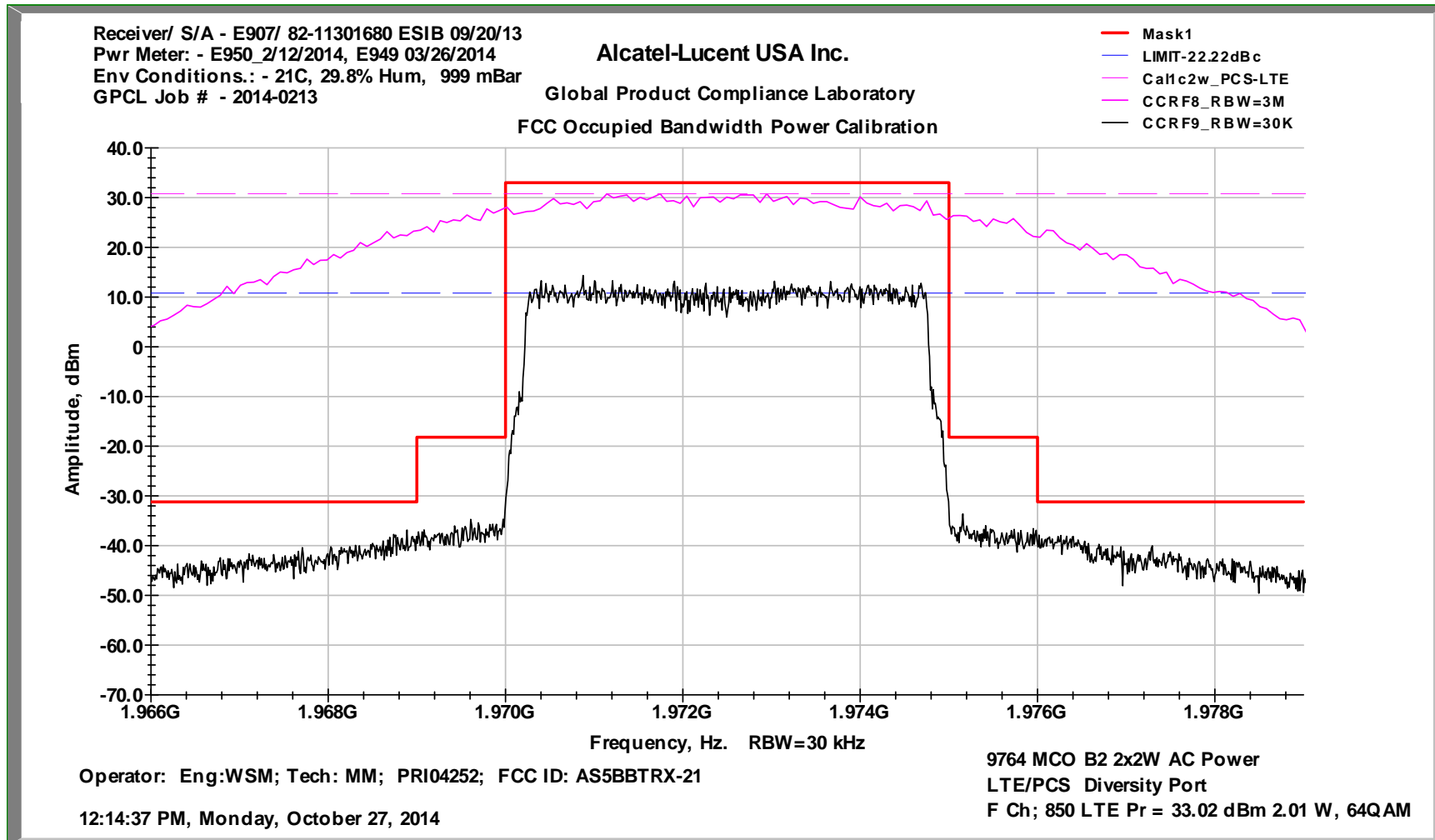

Occupied Bandwidth PCS 2x2W 3 Modulations 64QAM 16QAM QPSK Block F Diversity

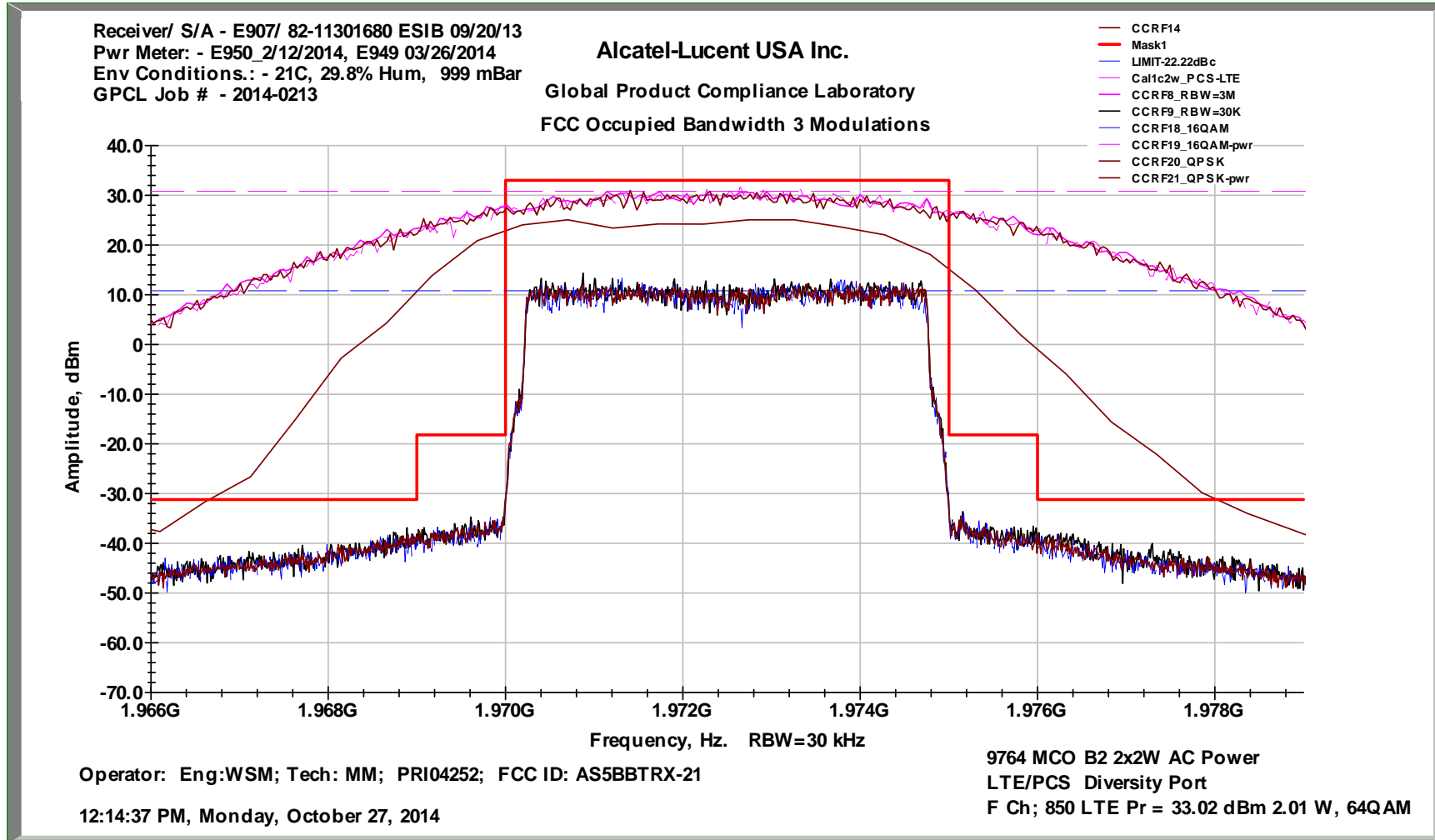

Occupied Bandwidth PCS 2x2W 64QAM Block F Edge of Block Diversity

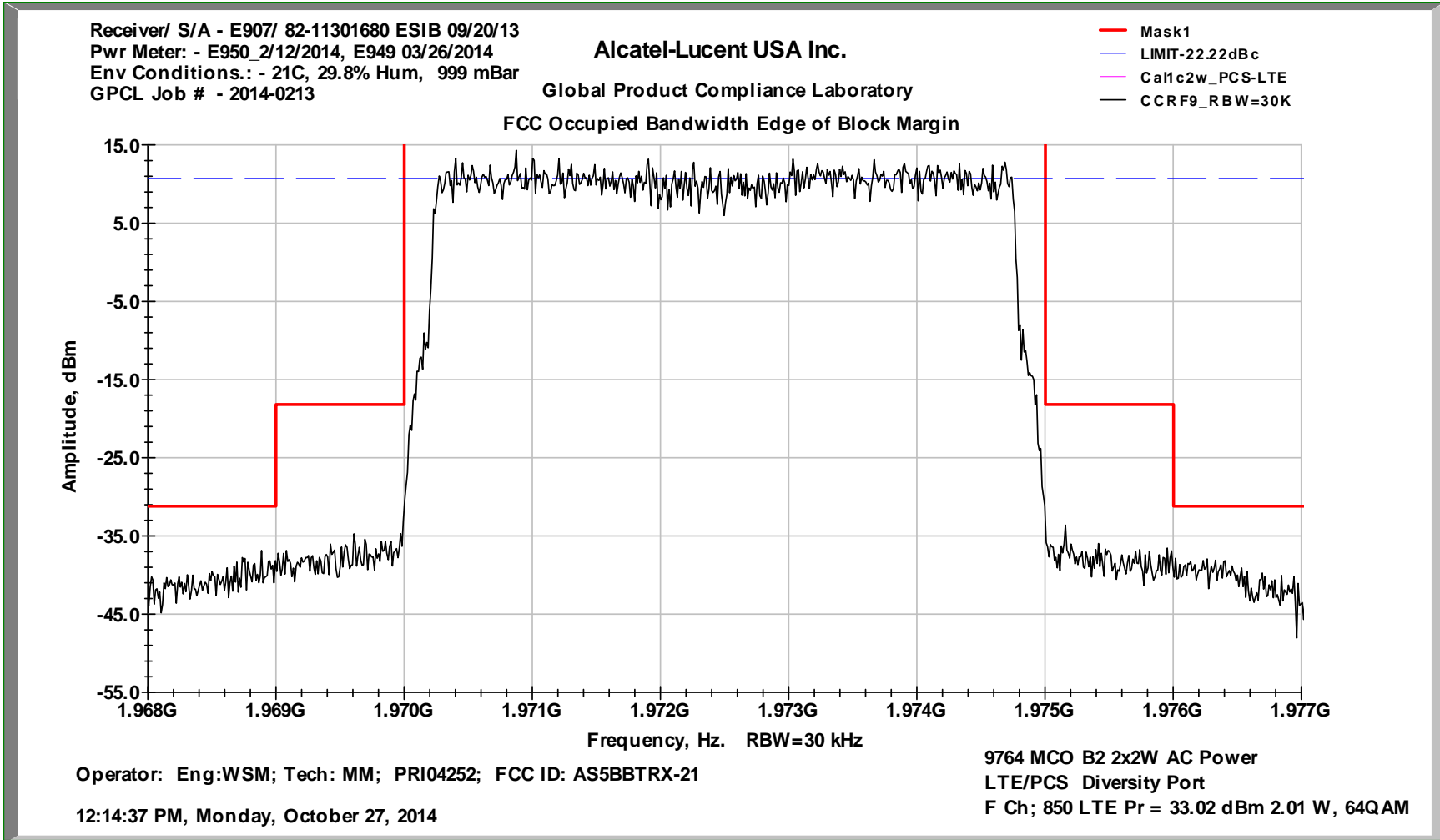

Occupied Bandwidth PCS 2x2W 64QAM Block C1 Primary

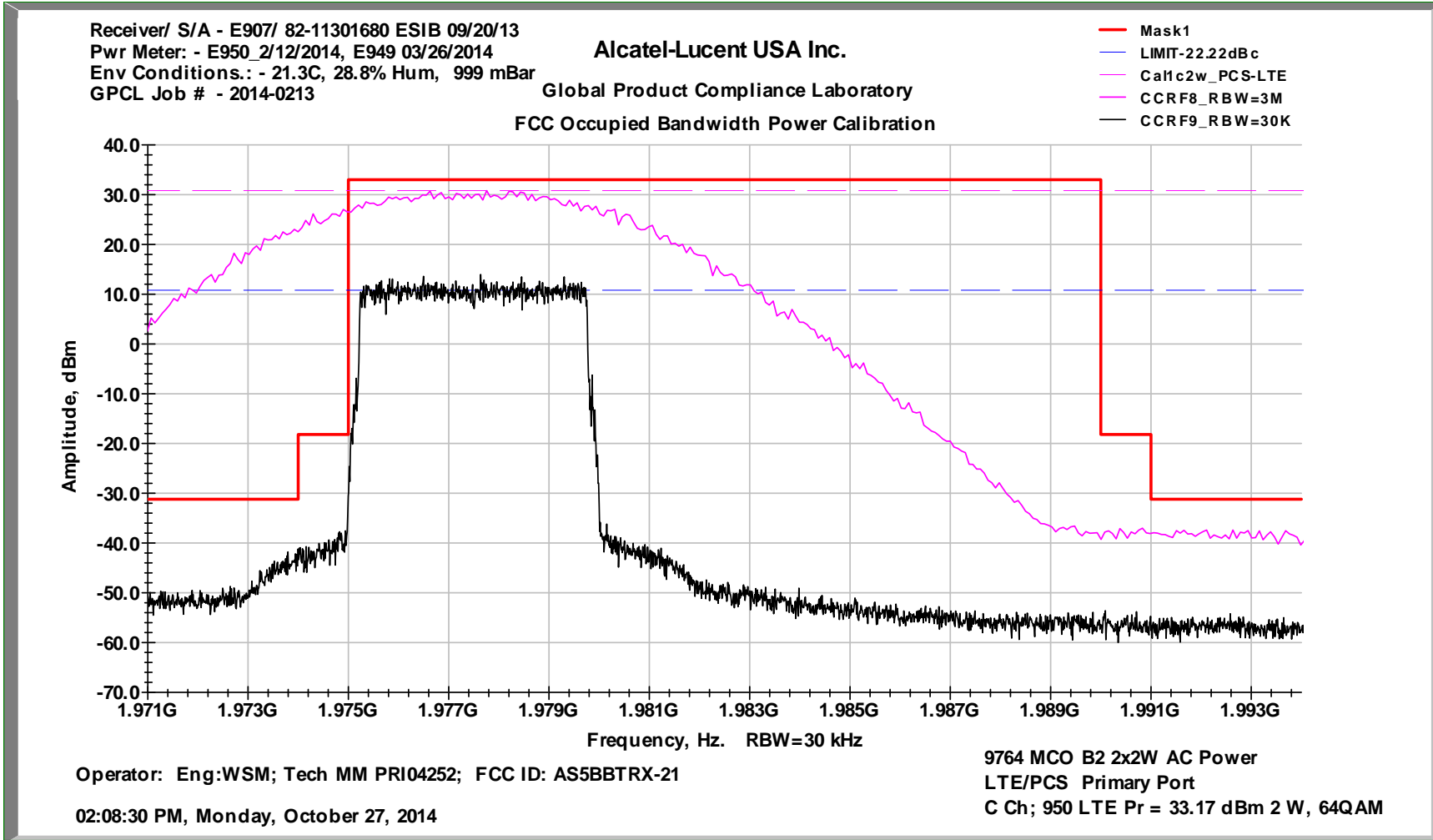

Occupied Bandwidth PCS 2x2W 3 Modulations 64QAM 16QAM QPSK Block C1 Primary

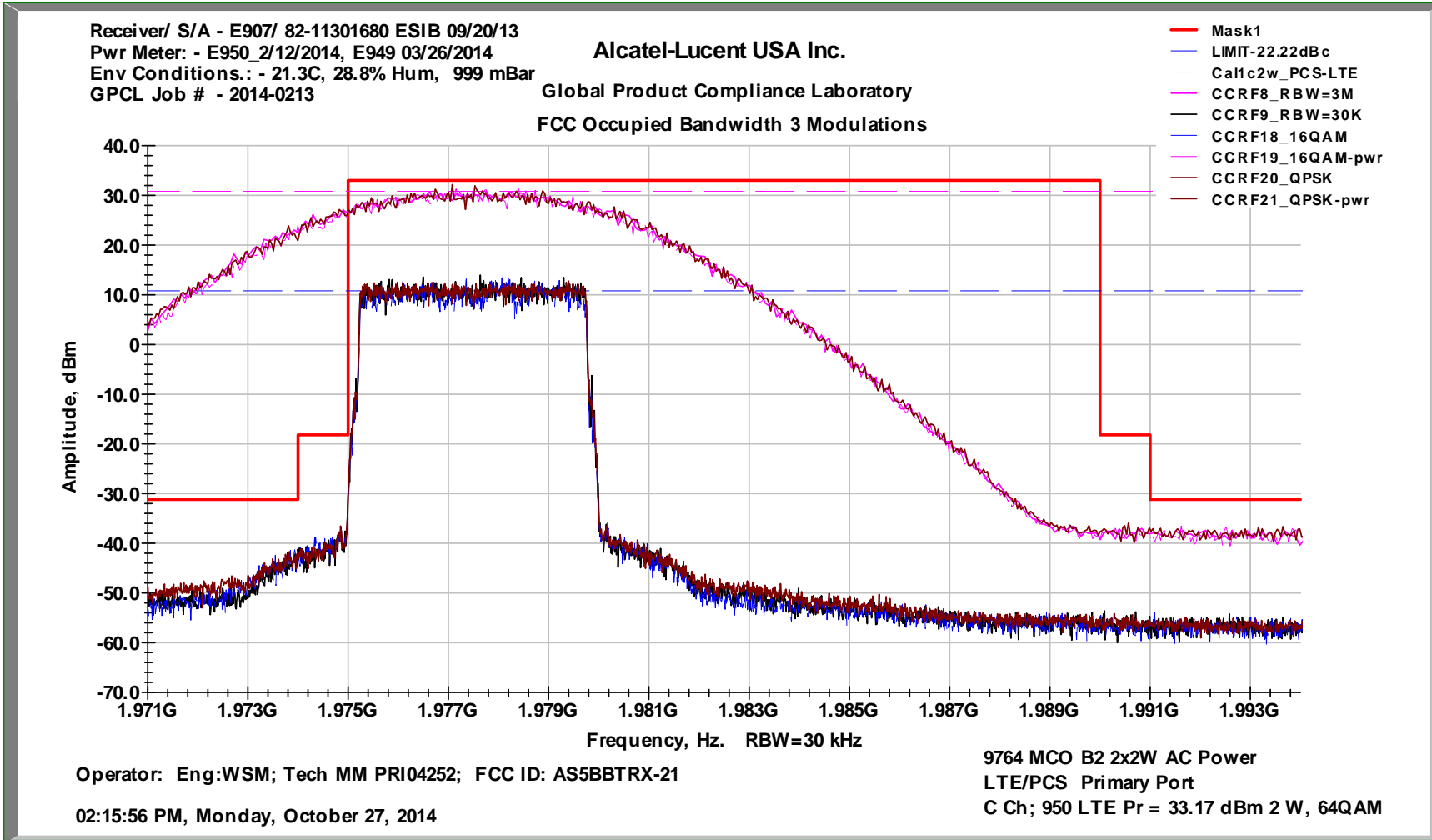

Occupied Bandwidth PCS 2x2W 64QAM Block C1 Edge of Block Primary

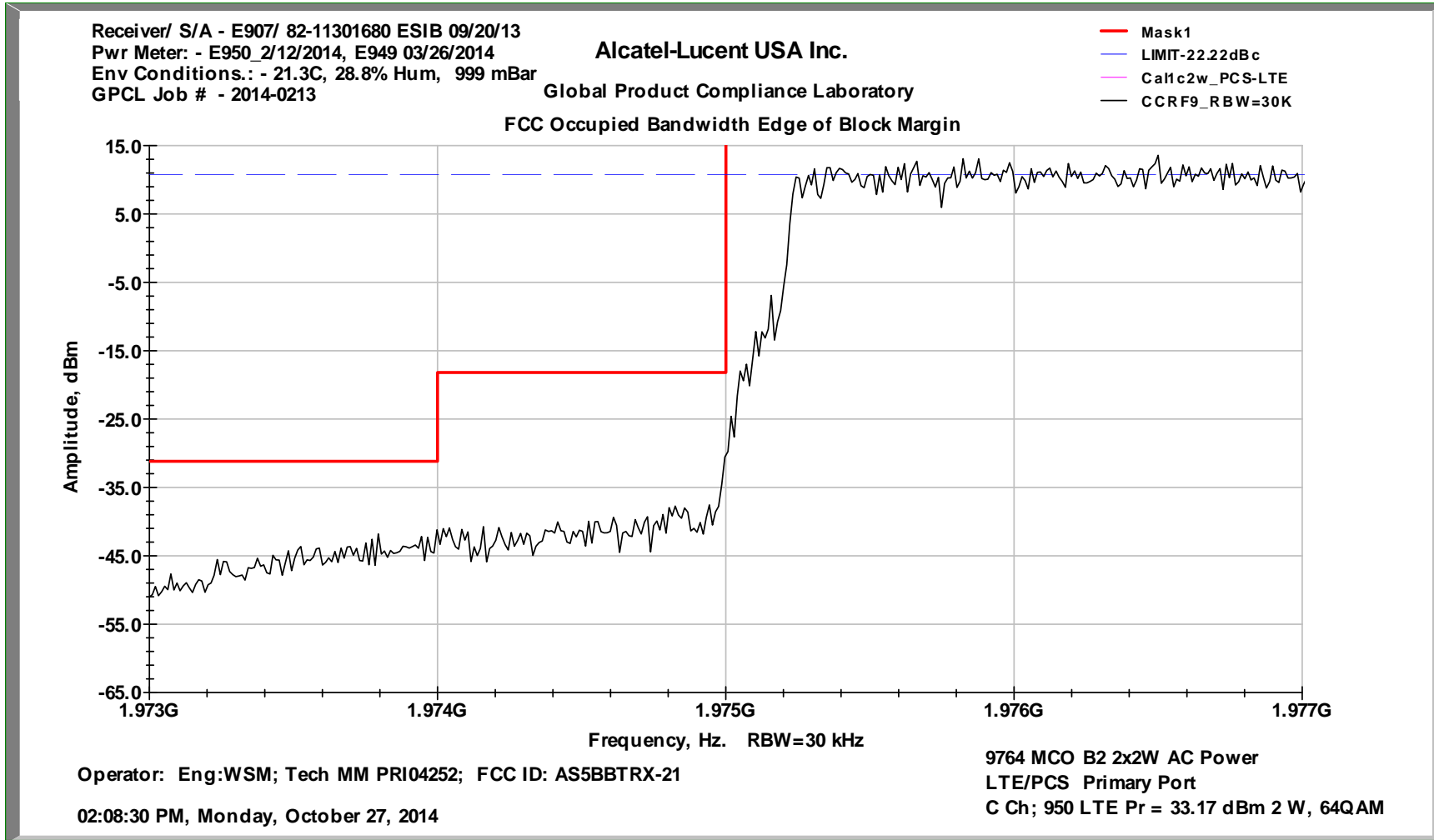

Occupied Bandwidth PCS 2x2W 64QAM Block C1 Diversity

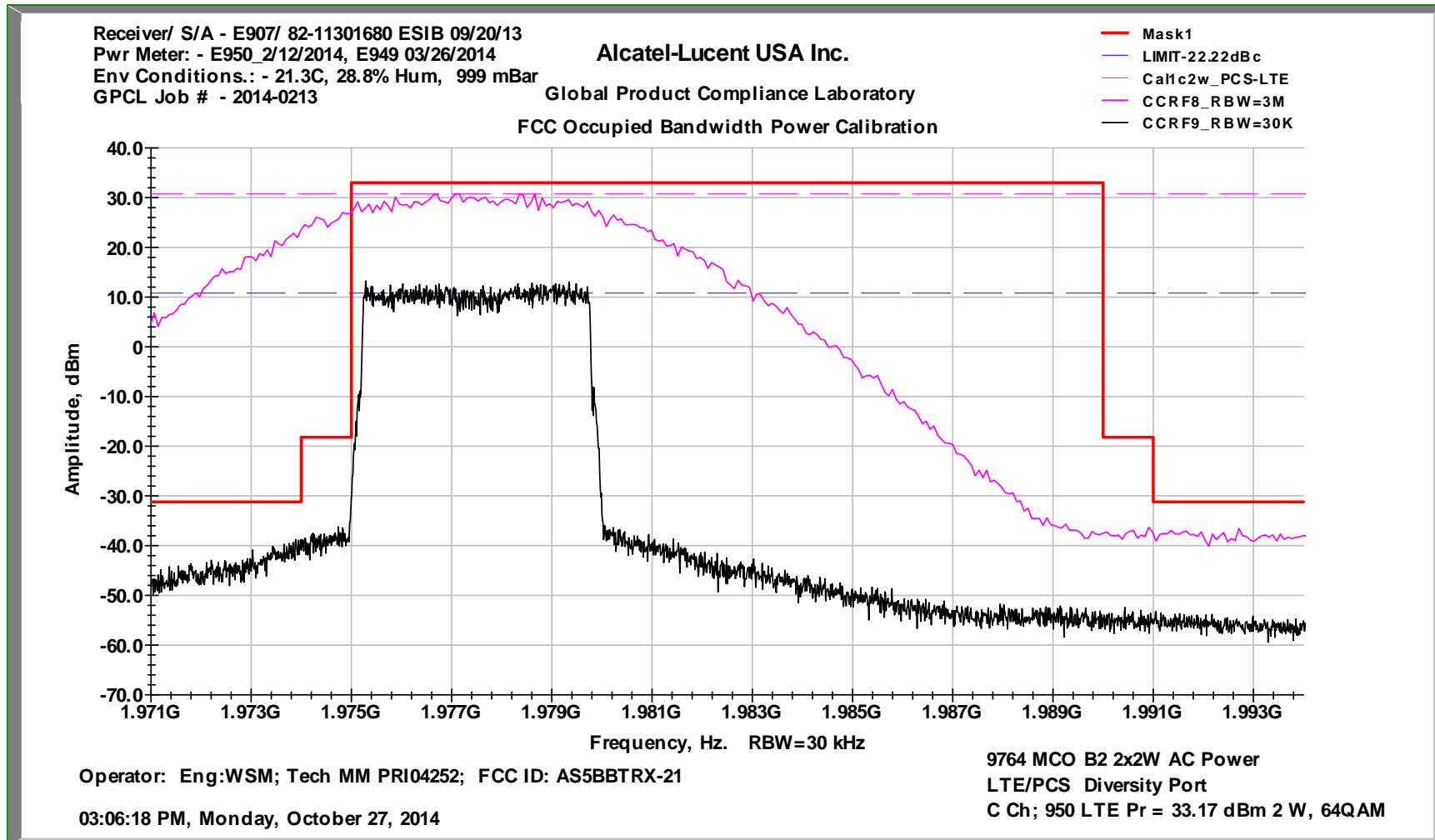

Occupied Bandwidth PCS 2x2W 3 Modulations 64QAM 16QAM QPSK Block C1 Diversity

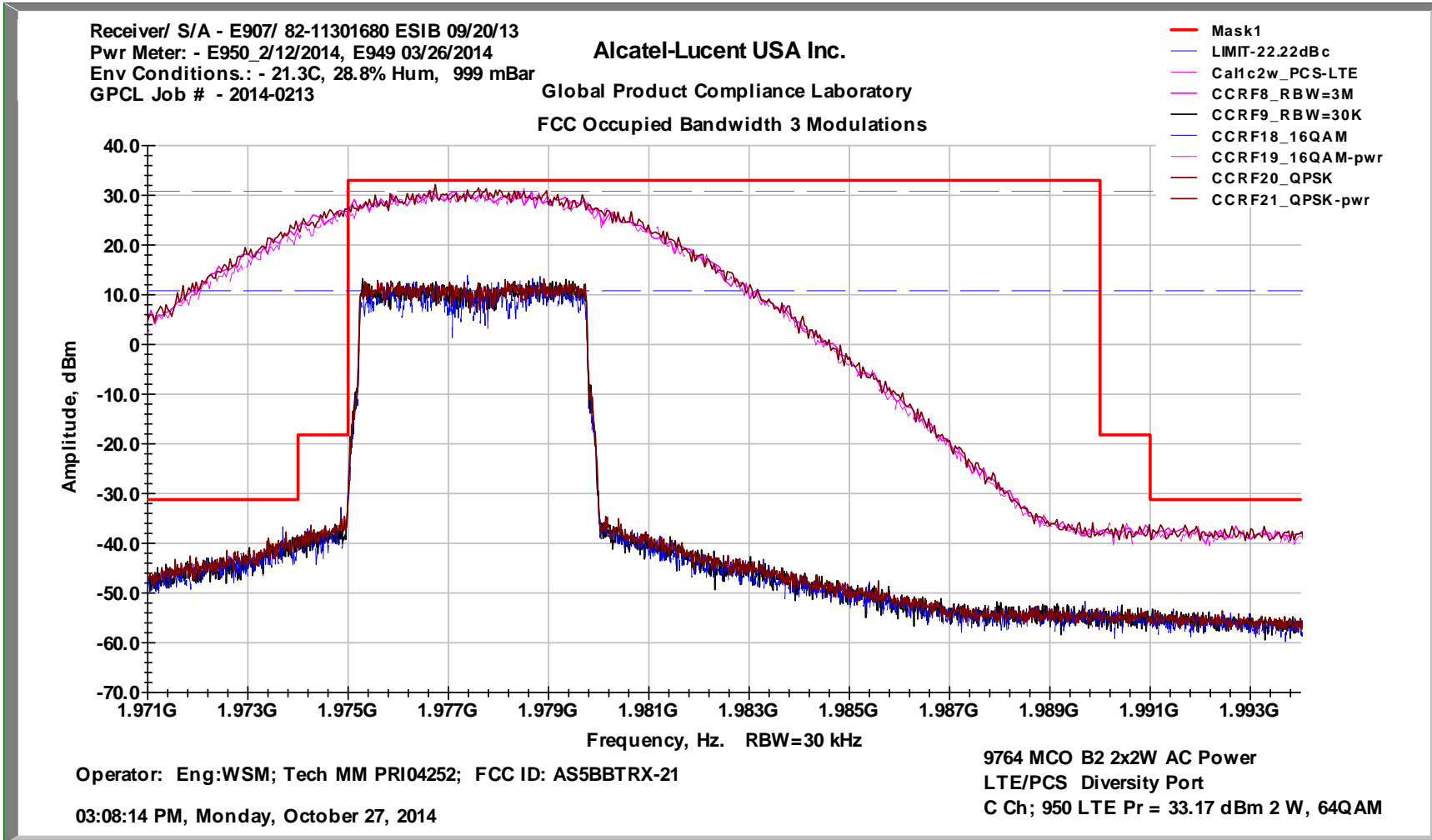

Occupied Bandwidth PCS 2x2W 64QAM Block C1 Edge of Block Diversity

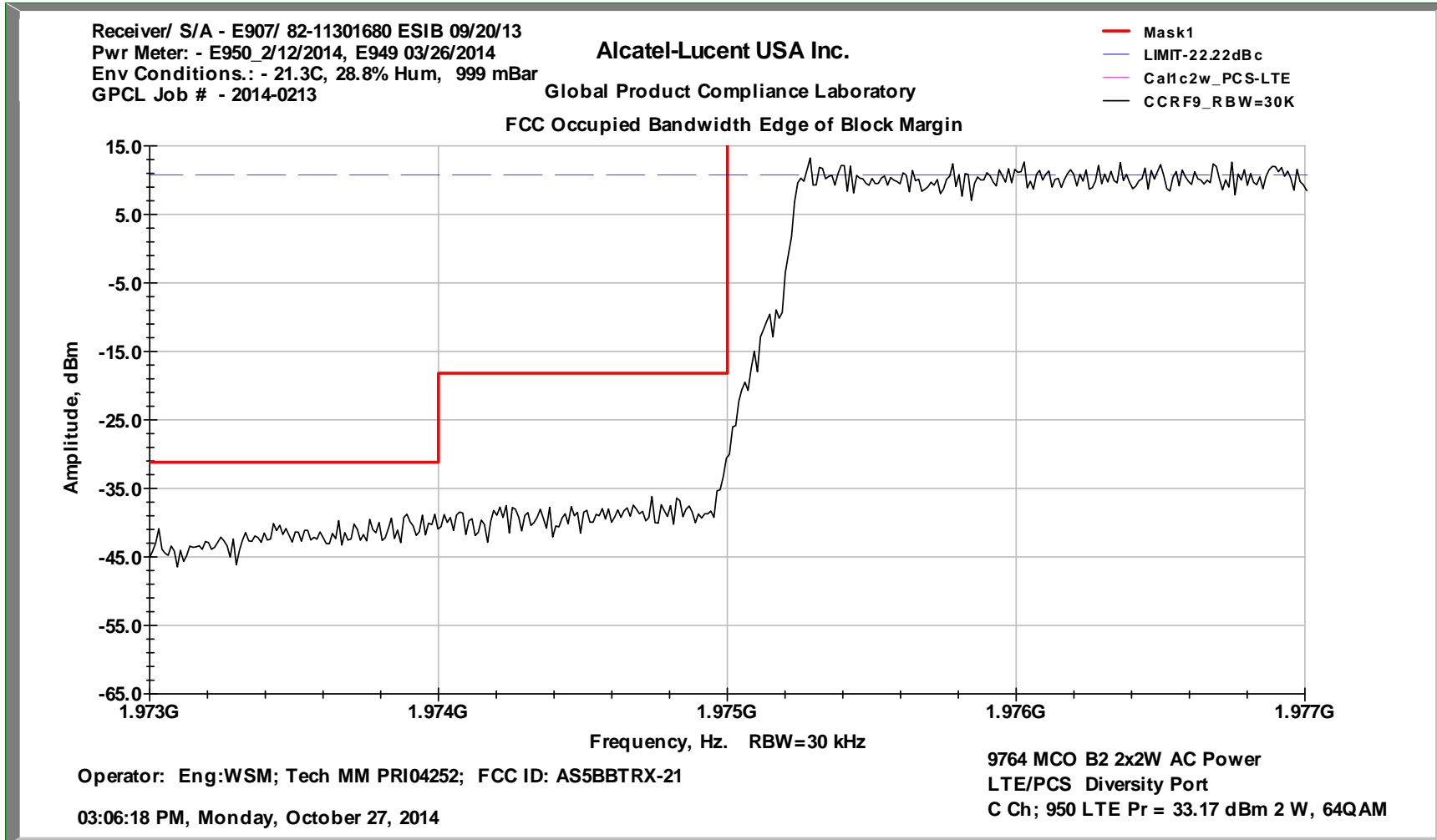

Occupied Bandwidth PCS 2x2W 64QAM Block C5 Primary

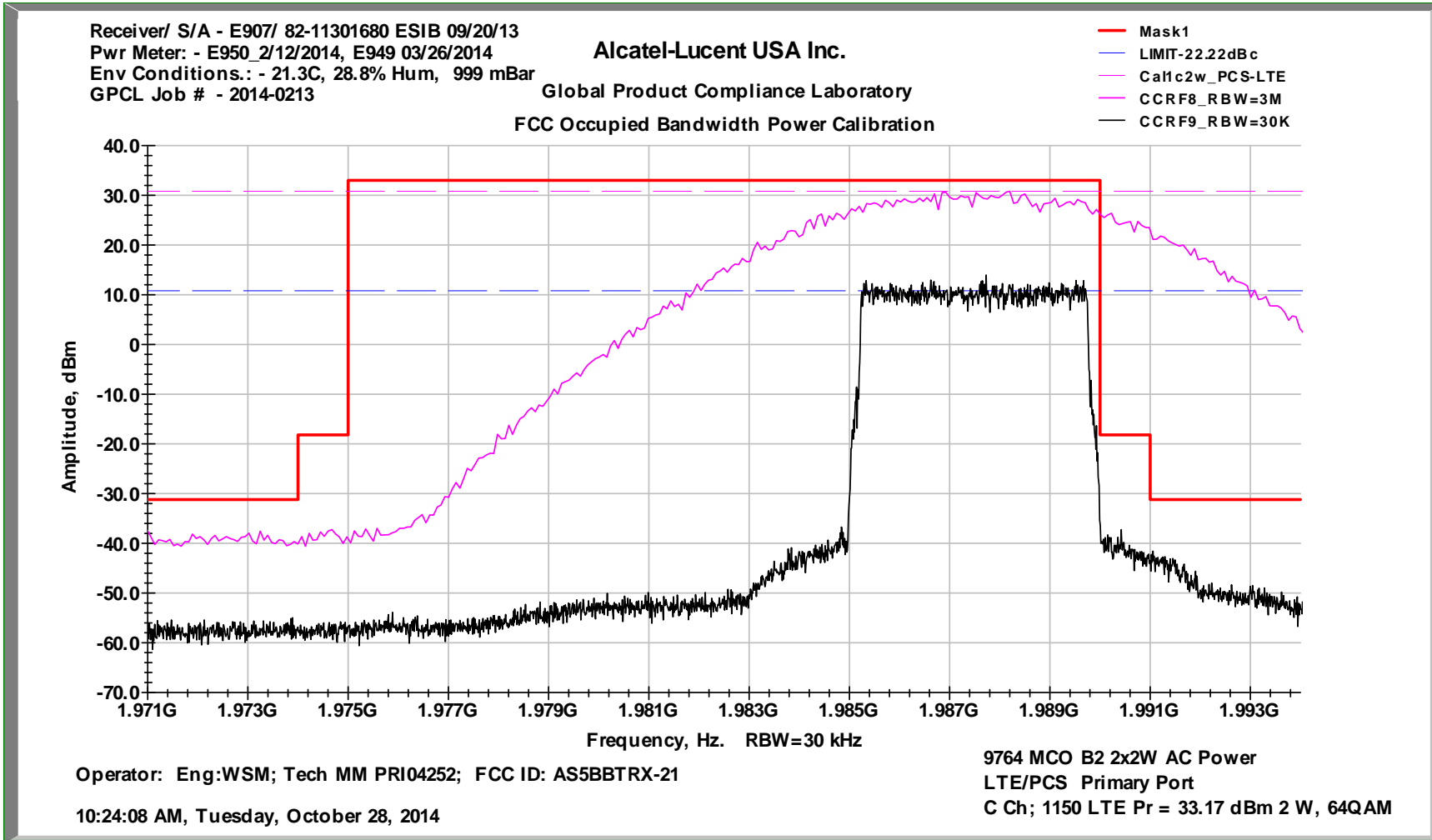

Occupied Bandwidth PCS 2x2W 3 Modulations 64QAM 16QAM QPSK Block C5 Primary

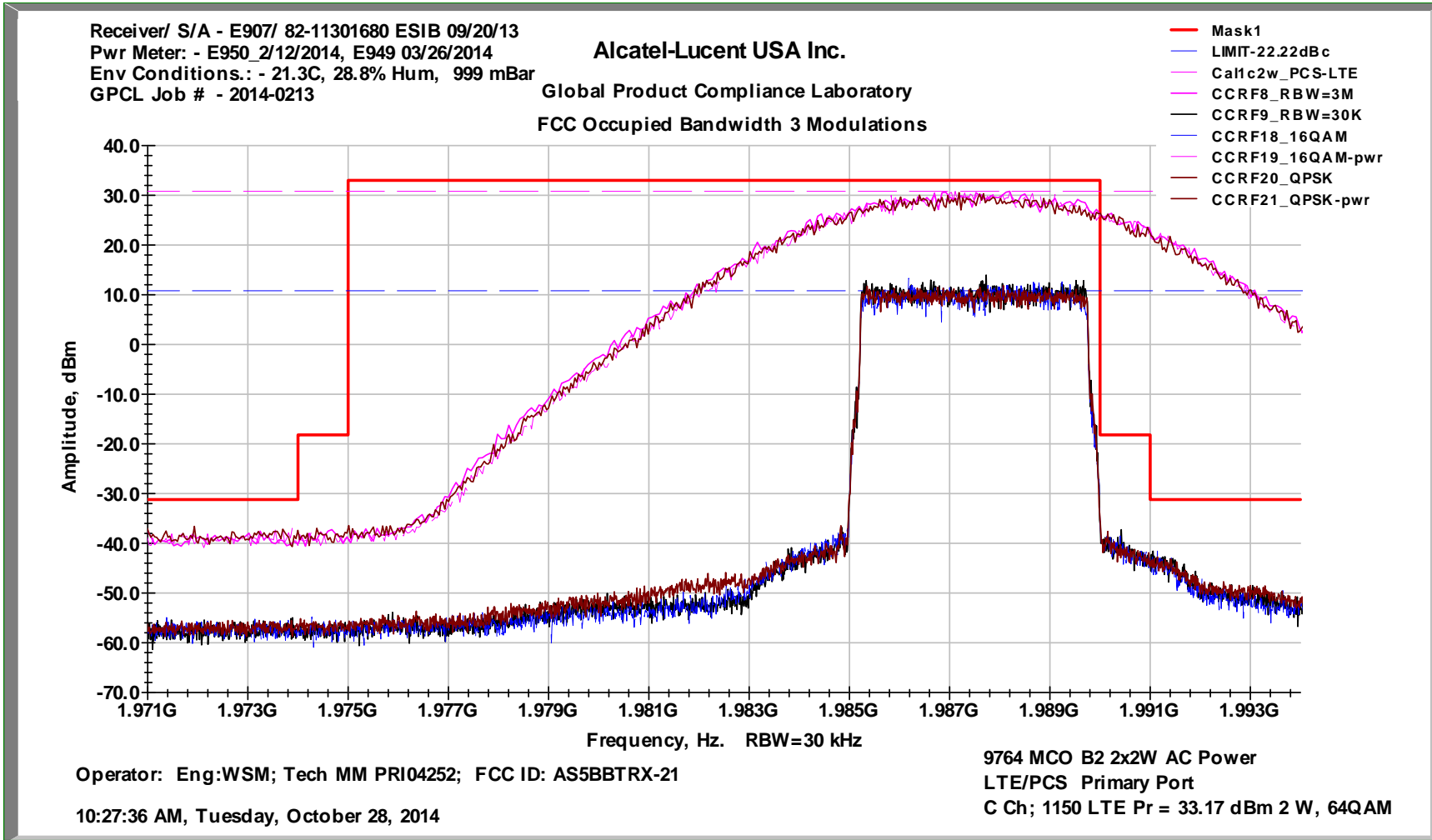

Occupied Bandwidth PCS 2x2W 64QAM Block C5 Edge of Block Primary

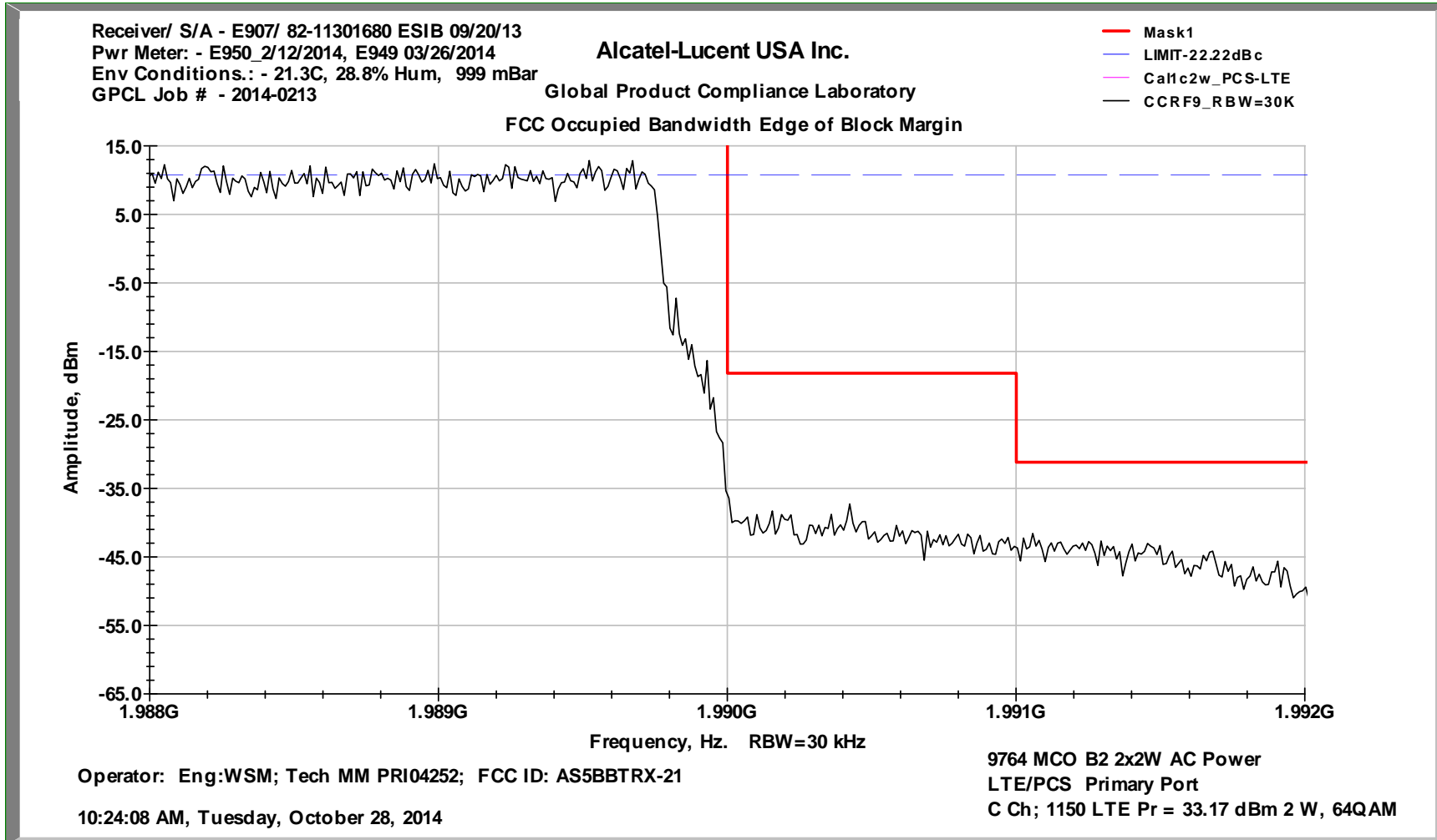

Occupied Bandwidth PCS 2x2W 64QAM Block C5 Diversity

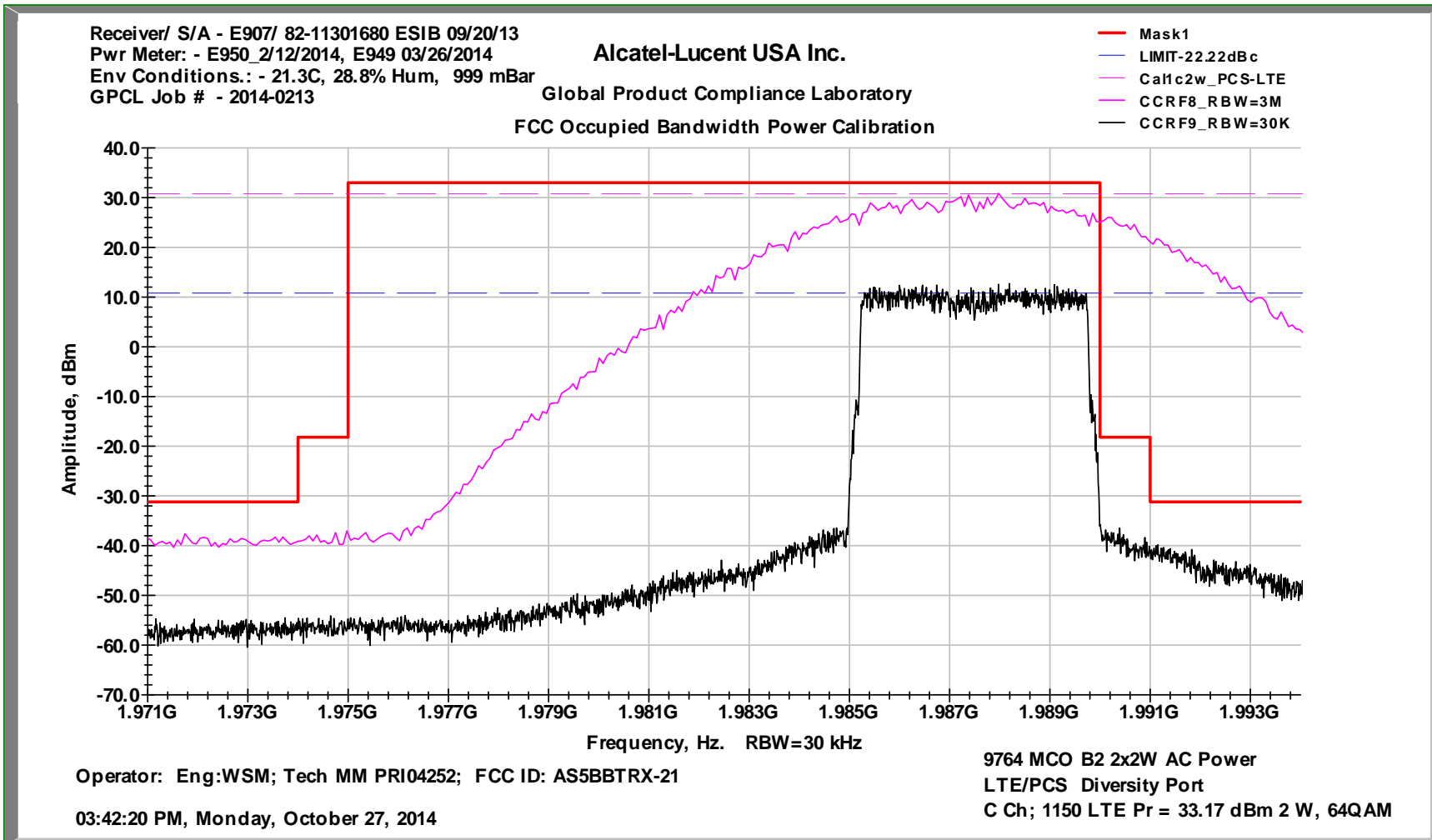

Occupied Bandwidth PCS 2x2W 3 Modulations 64QAM 16QAM QPSK Block C5 Diversity

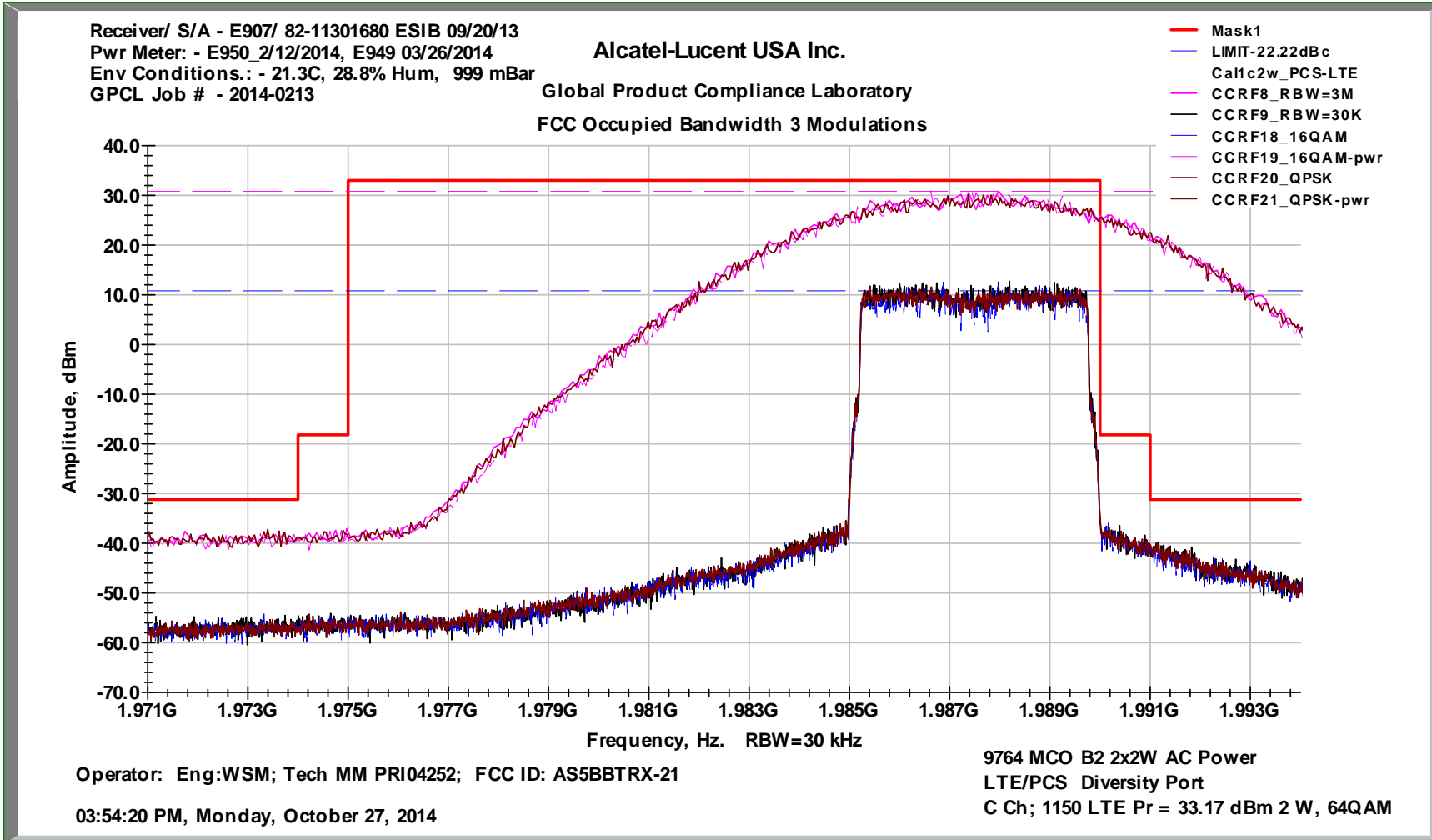

Occupied Bandwidth PCS 2x2W 64QAM Block C5 Edge of Block Diversity

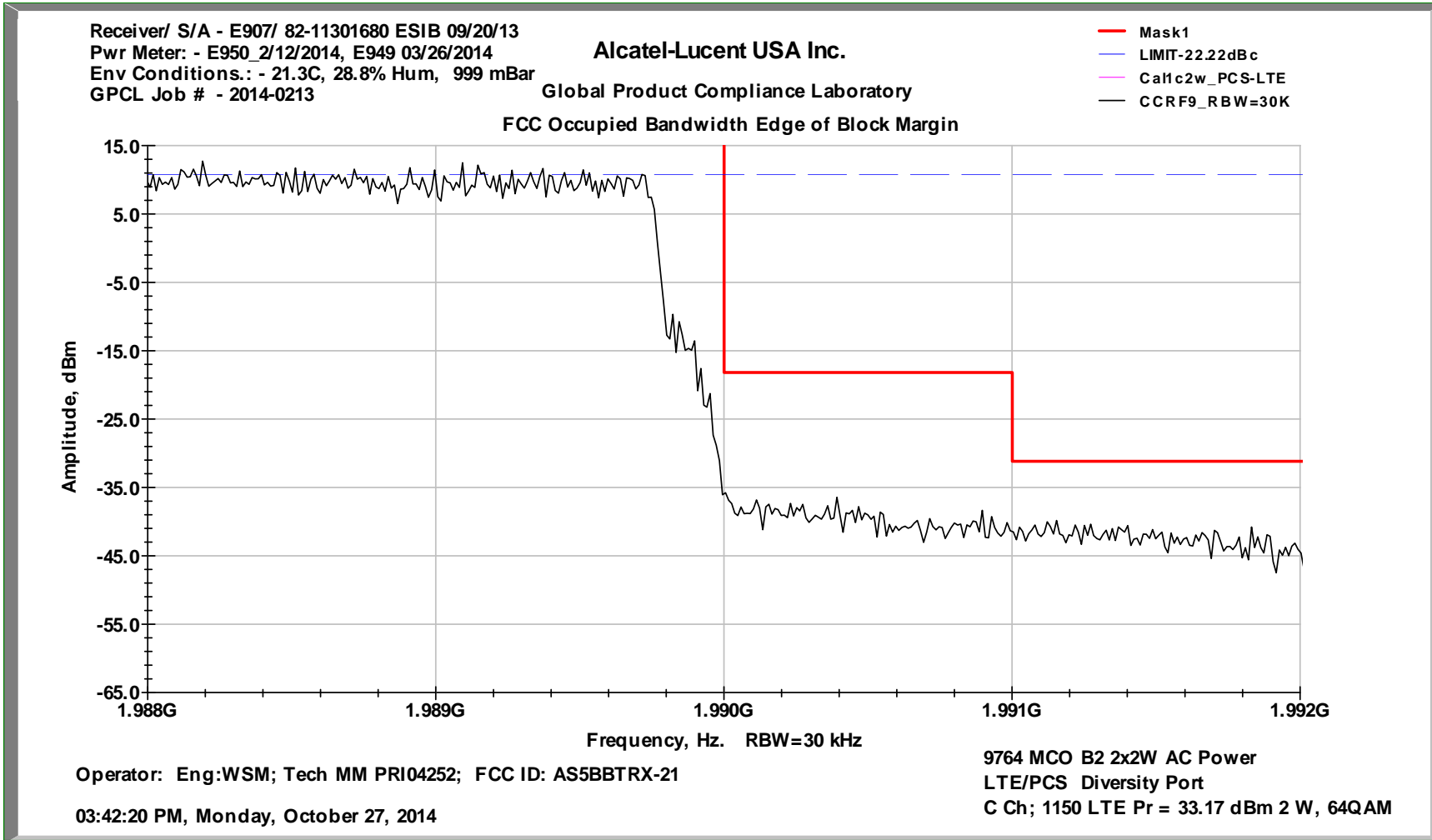

15. Exhibit 15: SPURIOUS EMISSIONS AT ANTENNA TERMINALS

15.1 Section 2.1051 Spurious Emissions at Antenna Terminals

Spurious Emissions at the antenna terminals were investigated over the frequency range of 10 MHz to 20 GHz which is beyond the 10th harmonic of the carrier frequency. A test coupler which incorporates a low inter-mod broadband RF attenuator was used to reduce the transceiver’s amplitude to a level usable by the spectrum analyzer. The test coupler is shown in Figure 15A which documents the test configuration used for the measurements. In this set up the complete RF test path was calibrated over the 10 MHz-20 GHz range and it allows for RF power to be measured and monitored during the test.

The spurious measurements were made using an automated test system. The test system consists of a Rohde & Schwarz FSEM30 Spectrum Analyzer (or ESIB Test Receiver), a PC based computer test controller, calibrated test hardware and a TILE™ software program to acquire the test data. This system allows measurement and presentation of the data in an accurate and compact form for FCC review. The volume of collected data is greater than 2×10^5 data points over the frequency range of 10 MHz to 20 GHz.

15.2 Required Limit

The required emission limitation specified in **47CFR 24.238 1-Oct-2010** was applied to these tests. Based upon the criterion given in Section 24.238 of the Code and as developed in Exhibit 14, the required emission limit in 47 CFR 24.238(a) for emissions outside a licensee’s frequency block is:

Emissions >1 MHz outside the Block, *when measured with a RBW of 1 MHz*, shall be attenuated by :

$$-\{43+10\log(\text{mean power output in watts})\} = -13 \text{ dBm.}$$

In order to account for the spectral adding of identical signals from the primary and diversity ports, per KDB 662911 D01 Multiple Transmitter Output v01r01, the level needs be adjusted by $10\text{LOG}(n)$ where n = number of outputs.

$$\text{The adjustment for } n=2 \text{ is: } 3.01 \text{ dB} = 10\text{LOG}(2)$$

Therefore the limit for emissions >1 MHz outside a licensee’s frequency block when measured with a RBW of 1 MHz is:

$$-13 \text{ dBm} - 3.01 \text{ dB} = -16.01 \text{ dBm}$$

The carrier signal shown on these plots was measured at a resolution Bandwidths of 3 MHz. This was done so that the carrier plot correctly and accurately depicts the carrier output power in relation to the spurious signals and the defined limit.

15.3 Operational Configuration

The modulation used in this evaluation are described in the pertinent standards documents which include **3GPP TS 36.211 V9.1.0 (2010-03) titled:** 3rd Generation Partnership Project; Technical Specification Group Radio Access Network; Evolved Universal Terrestrial Radio Access (E-UTRA); Physical Channels and Modulation (Release 9). The modulation is Orthogonal Frequency Division Multiple Access (OFDMA) which is processed into an uplink IF signal. The input data stream is divided into several parallel sub-streams of reduced data rate and each sub-stream is transmitted on a separate orthogonal sub-carrier. The sub-carriers are modulated using either QPSK, or 64QAM. There is no single measure of the modulation quality other than to verify that the subcarrier modulation constellations visual orientation match the symbol and amplitude criteria is consistent with QPSK and 64QAM.

Exhibit 15 *continued*

TABLE 15.2 PCS Conducted Spurious Compliance Tabulation

PCS - Block	PCS Channel Number	EARFCN	Frequency, MHz	Modulation	Tx1	Tx2	Results Conducted Spurious
A	50	625	1932.5	64QAM	X	X	Compliant
A	250	725	1942.5	64QAM	X	X	Compliant
D	350	775	1947.5	64QAM	X	X	Compliant
B	450	825	1952.5	64QAM	X	X	Compliant
B	650	925	1962.5	64QAM	X	X	Compliant
E	750	975	1967.5	64QAM	X	X	Compliant
F	850	1025	1972.5	64QAM	X	X	Compliant
C	950	1075	1977.5	QPSK,	X	X	Compliant
C	1150	1175	1987.5	64QAM	X	X	Compliant

15.4 Test Results Summary:

Conducted Spurious measurements were performed for the Primary (Tx1) and Diversity (Tx2) antenna ports of the **PCS LTE 9764 Metro Cell Outdoor Transceiver System / FCC ID: AS5BBTRX-21**. The PCS LTE 9764 Metro Cell was configured with an output power of two watts at each of its transmit ports. Conducted Transmit Spurious measurements were performed as part of the automated test profile for Occupied bandwidth. Every PCS Block Edge measurements configuration therefore included a Conducted Spurious measurements at the antenna transmit port as documented in Table 15.2.

The attached spectral plots are representative of the Conducted Spurious compliance performance of the **PCS LTE 9764 Metro Cell Outdoor Transceiver System / FCC ID: AS5BBTRX-21**. The compliance for all of the representative transmit configurations are documented in Table 15.2. This Table lists PCS Blocks/ Channels tested the amplifier configuration and the status of the performance. The performance data, charts and tables all show that there are no “Out of Block” harmonics or spurious emissions above the applicable limit of -16.01 dBm. The attached table and sample data plots document the results.

Figure 15A Test Setup for Antenna Port Measurement of Transmit Power, Occupied Bandwidth and Conducted Spurious Emissions

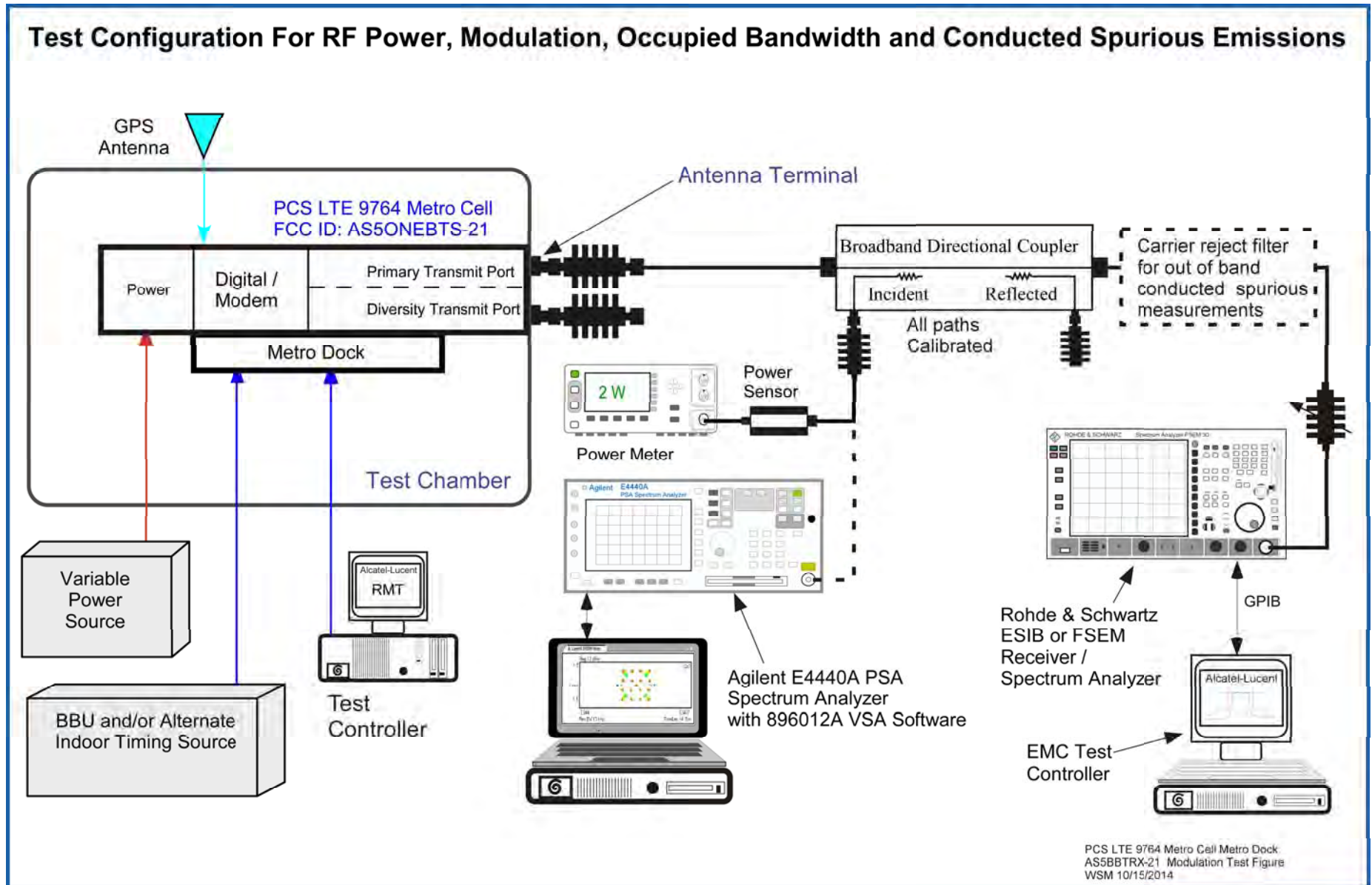

**Transmitter Measurements
of
Conducted Spurious Emissions
for
Alcatel-Lucent USA Inc.**

**PCS LTE 9764 Metro Cell Outdoor Transceiver System
FCC ID: AS5BBTRX-21**

W. Steve Majkowski NCE

FCC Wireless Compliance, Filing Lead

Alcatel-Lucent USA Inc.

Global Product Compliance Laboratory

Building 5B103

600-700 Mountain Avenue, P.O. Box 636

New Providence, NJ 07974-0636

Office: 908-582-3782

email: steve.majkowski@alcatel-lucent.com

Conducted Spurious 10MHz- 10 GHz PCS 2x2W 64QAM Block A1 Primary

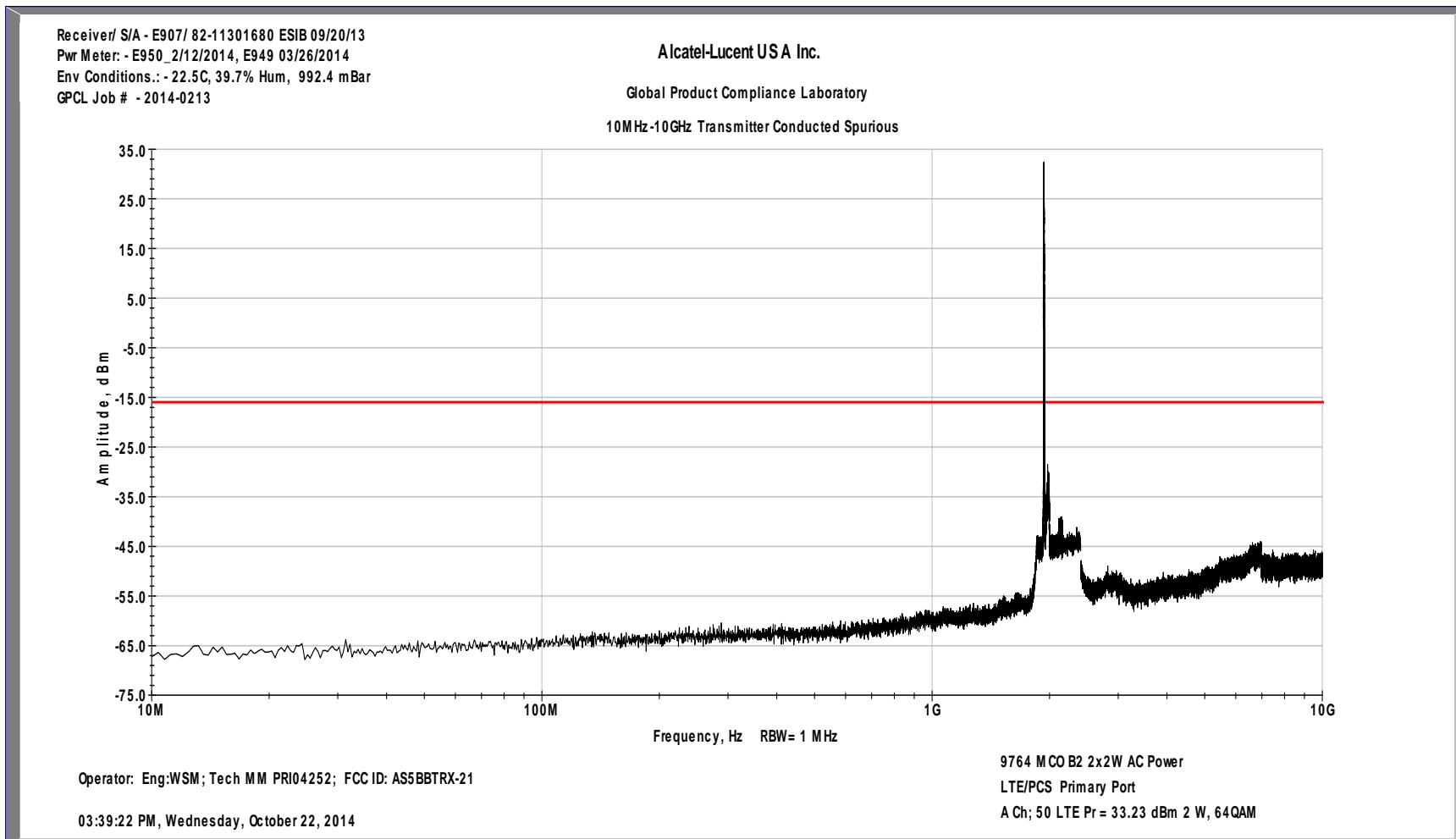

Conducted Spurious 1 GHz- 20 GHz PCS 2x2W 64QAM Block A1 Primary

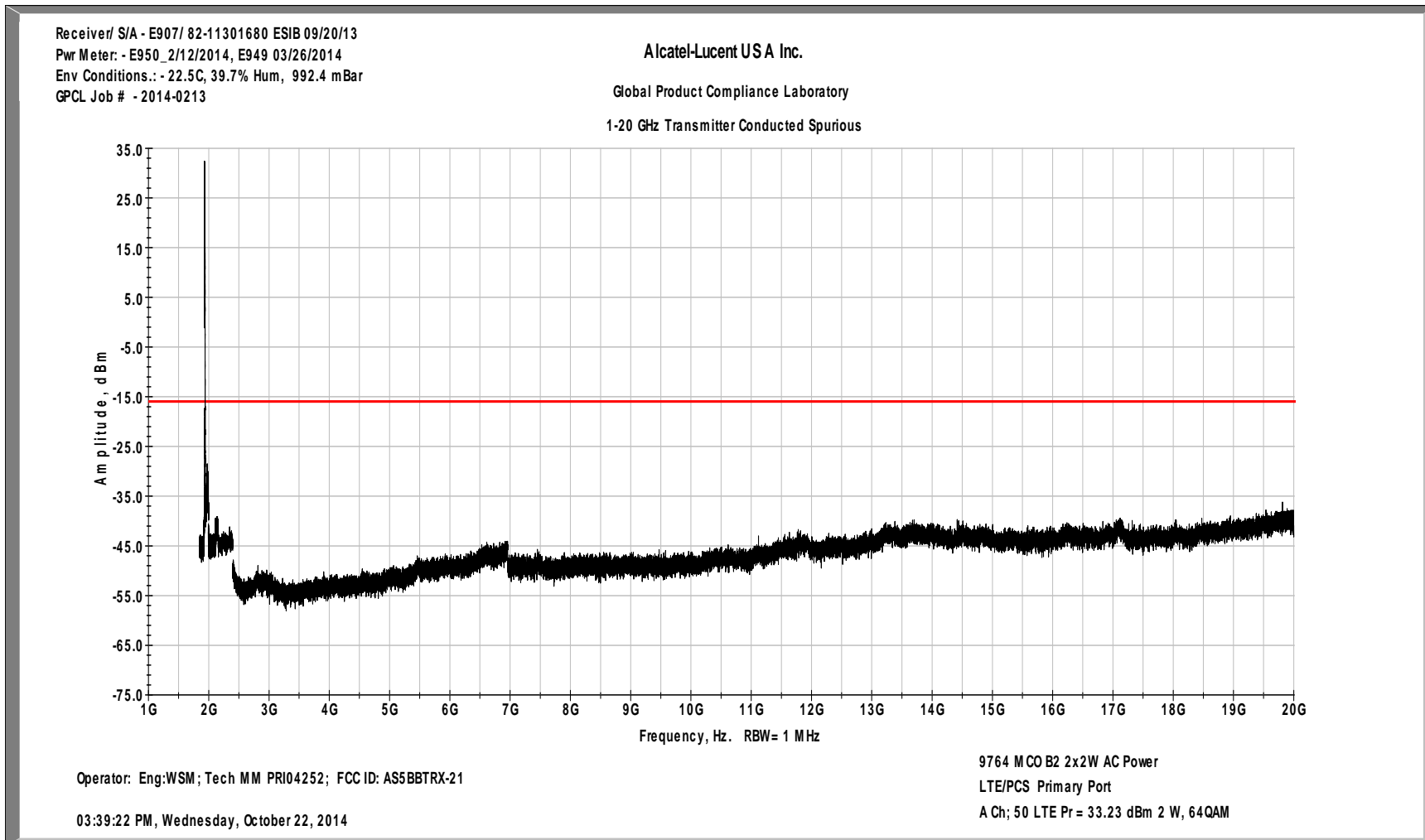

Conducted Spurious 10MHz- 10 GHz PCS 2x2W 64QAM Block C5 Diversity

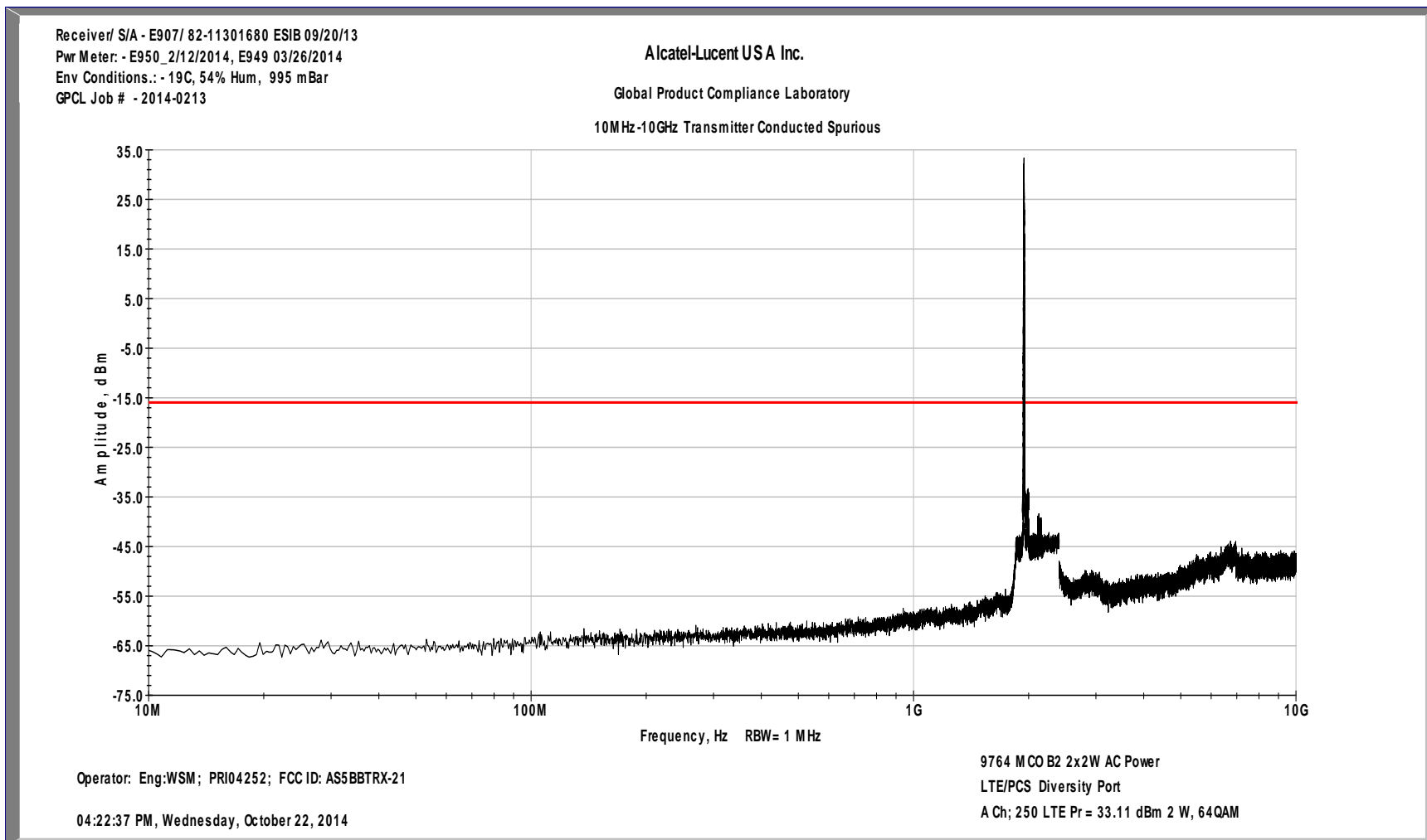

Conducted Spurious 1 GHz- 20 GHz PCS 2x2W 64QAM Block C5 Diversity

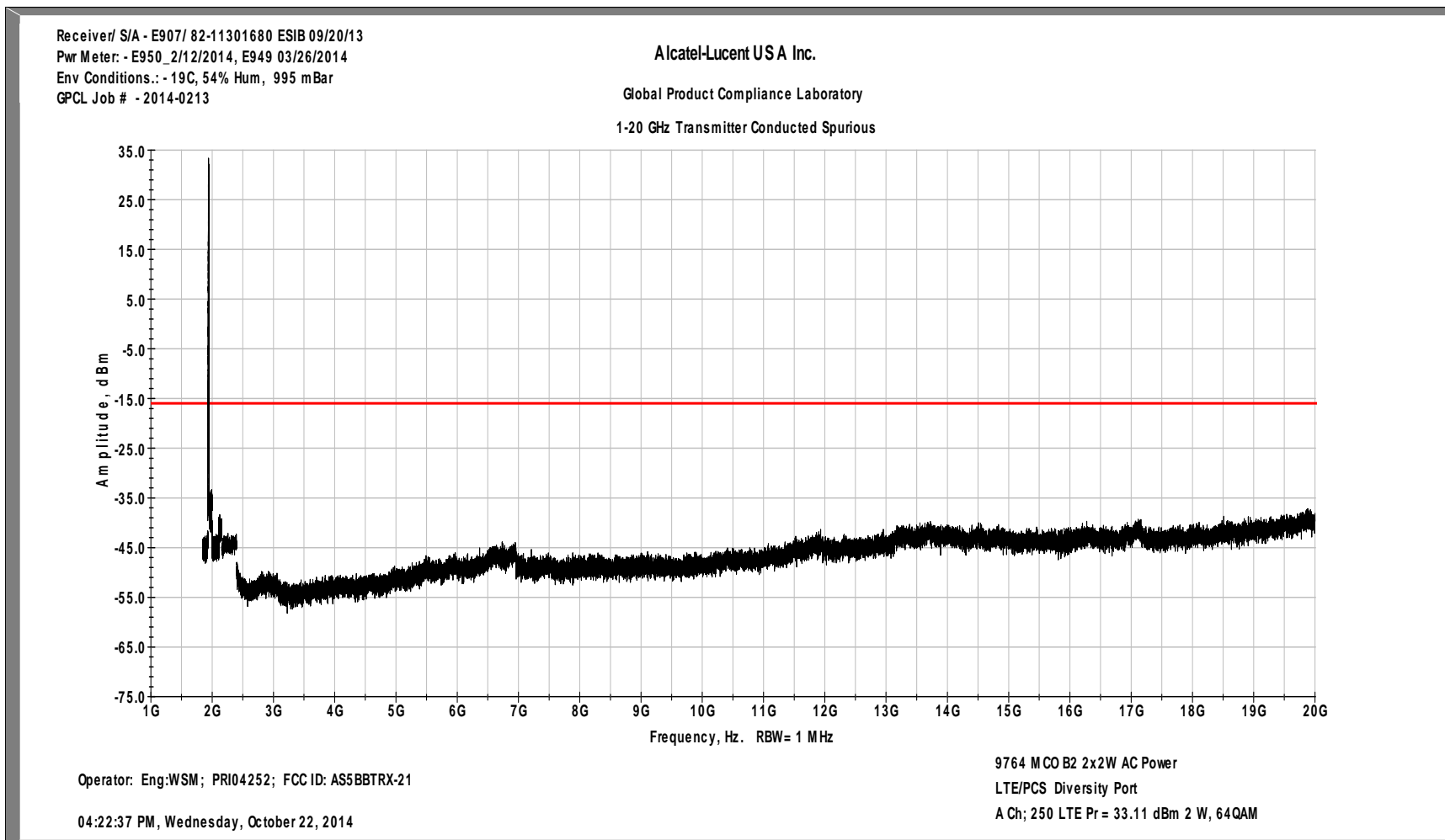

16. Exhibit 16 FIELD STRENGTH OF SPURIOUS RADIATION

16.1 SECTION 2.1053 Field Strength Of Spurious Radiation

Field strength measurements of radiated spurious emissions were evaluated in the AR9 Semi-Anechoic 3m Full Compliance Chamber maintained by Alcatel-Lucent USA Inc. Global Product Compliance Laboratory in Murray Hill, New Jersey. A complete description and full measurement data for the site have been placed on file with the Commission.

The **PCS LTE 9764 Metro Cell Outdoor Transceiver System / FCC ID: AS5BBTRX-21** was configured into a representative field installation and was tested when operating in each PCS block. The spectrum from 10 MHz to the tenth harmonic of the carrier (20 GHz) was searched for spurious radiation. Measurements were made using both horizontally and vertically polarized broadband antennas. Per FCC regulations, the comparison of out of band spurious emissions directly to the limit is appropriately made using the substitution method. However, when the emissions are more than 20 dB below the specification limit, the use of field strength measurements for compliance determination is acceptable and those emissions are considered not reportable (Section 2.1053 and the FCC Interpretive database for 2.1053). For this case the evaluation of acceptable radiated field strength is as follows.

The calculated emission levels were found by:

$$P_{meas} \text{ (dBm)} + \text{Cable Loss (dB)} + \text{Antenna Factor (dB)} + 107 \text{ (dB}\mu\text{V/dBm)} - \text{Amplifier Gain (dB)} \\ = \text{Field Strength (dB}\mu\text{V/m)}$$

Section 24.238 and 2.1053 contains the requirements for the levels of spurious radiation as a function of the EIRP of the unmodulated carrier. The reference level for the unmodulated carrier is calculated as the field produced by an isotropic radiator excited by the transmitter output power according to the following relation taken from Reference Data for Radio Engineers, page 27-7, 6th edition, IT&T Corp.

$$E = (120\pi P)^{1/2} = [(30 * P)^{1/2}] / R$$

$$20 \log (E * 10^6) - (43 + 10 \log P) = 71.77 \text{ dB } \mu\text{V/meter}$$

Where: E = Field Intensity in Volts/ meter
 P = Transmitted Power in watts = 2 W
 R = Distance in meters = 10 m

16.2 RESULTS:

For this particular test, the field strength of any spurious radiation, measured at 10m, is required to be less than 71.8 dBμV/meter. Emissions equal to or less than 51.8 dBμV/meter are not reportable and may be verified using field strength measurements and broadband antennas. Over the out of band spectrum investigated from 10 MHz to beyond the tenth harmonic of the carrier (20GHz), no reportable spurious emissions were detected. This demonstrates that the **PCS LTE 9764 Metro Cell Outdoor Transceiver System / FCC ID: AS5BBTRX-21**, the subject of this application, complies with Sections 2.1053, 24.238 and 2.1057 of the Rules.

Although not required for certification, additional testing to 47CFR Part 15 documented compliance with the Class B requirements for radiated emissions.

17. Exhibit 17 MEASUREMENT OF FREQUENCY STABILITY

17.1 SECTION 2.1055 Measurement of Frequency Stability

The following frequency stability test data for the **PCS LTE 9764 Metro Cell, FCC ID: AS5BBTRX-21** was measured as installed and tested, per Figure 17A.

An AC powered **PCS LTE 9764 Metro Cell Outdoor** was tested over its specified temperature range of -30 deg C to +50 deg C while operating at full rated power. Software and hardware controls internal to the **PCS LTE 9764 Metro Cell** will disable the transmitter should either the internal temperatures exceed the maximum range or the frequency stability of the transmitter be compromised.

17.2 Testing

Frequency Stability Testing was performed on a system level using the **PCS LTE 9764 Metro Cell Outdoor** with a transmit frequency of 1952.5 MHz. The testing was performed from 11/12/2014 through 11/13/2014 on a **9764 MCO B2 2x2W-AC**, S/N: LBALLU-ST143440027 at the T-16 Thermal chamber of the Alcatel-Lucent GPCL test facility located in Bldg 4, Room 4-280, Murray Hill, NJ. The temperatures to which the UUT were subjected to comprised high temperature (+50°C, system ambient) and low temperature (-30°C system ambient). The system level Frequency Stability testing of the UUT yielded results in compliance with established design criteria. Frequency Stability performance was verified by measuring Frequency Tolerance at EAC using an MXA Signal Analyzer. Frequency Tolerance is a measurement of the difference between the actual transmit frequency and the assigned frequency (1952.500 MHz).

The frequency stability performance of the **9764 Metro Cell Outdoor Transceiver System**, was also investigated over the voltage range of 85% to 115% of nominal line voltage. (280 VAC and 115 VAC +/- 15%) .

The frequency stability performance of the **9764 Metro Cell Outdoor Transceiver System, FCC ID: AS5BBTRX-21**, complies with the 0.05 ppm performance criteria as stated in the 731 form and it meets the requirements of 47 CFR Part 24.235. The summary of the results are below followed by the data.

17.3 Results Summary:

The test data documented that the maximum frequency deviation of the **PCS LTE 9764 Metro Cell** 1950 MHz transmit carrier, when measured over voltage and temperature, was +0.00014 ppm (2.716 Hz). The specification for conformance with the 731 form is +/- 0.05 ppm (+/- 97.50 Hz). The product also conform with Part 24.235 requirements.

Instrument Used for Measurement

Instrument Type	Serial Number	Vendor	Expiration Date
MXA Signal Analyzer	MY52091035	Agilent N9020A	10/30/2015
Power Meter	US38260780	HP E4419A	03/12/2015
Power Sensor	MY51020039	Agilent E9301A	09/17/2015
Thermal Logger	S5JC04072	YOKOGAWA MV2000	03/24/2015
Multimeter	JP35001820	HP 971A	06/10/2015
Power supply	04243	BEHLMAN AC Source Model BL1350	Cal Not Required

Figure 17A

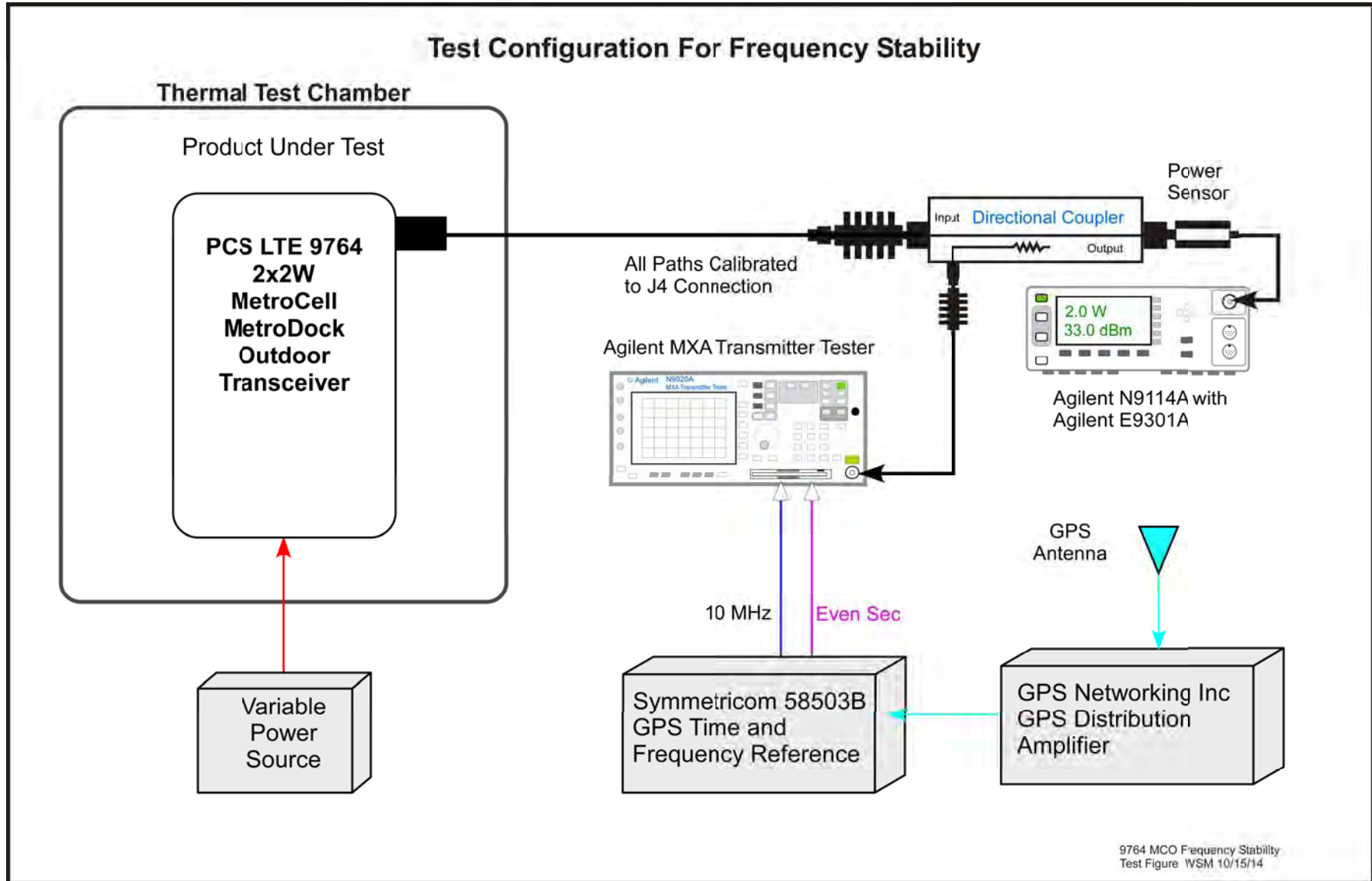

Frequency Block Tested: PRI04252 - 9764 MCO B2 2x2W-AC (CF = 1952.50MHz)

Baseline Measurement at +25°C

Transmit Frequency Deviation at +25°C at 100% of Nominal Voltage, 208VAC	
Time (minutes)	Transmit Carrier Deviation (Hz)
0	0.561
0.5	0.209
1.0	0.964
1.5	0.805
2.0	1.621
2.5	2.716
3.0	1.213
FCC SPECIFICATION	±1952.50 MHz (±0.05ppm) ±0.05ppm = ±97.625Hz
FCC RESULT	PASS

Baseline Measurement at +25°C

Transmit Frequency Deviation at +25°C at 100% of Nominal Voltage, 115VAC	
Time (minutes)	Transmit Carrier Deviation (Hz)
0	0.697
0.5	1.967
1.0	1.831
1.5	0.402
2.0	0.777
2.5	1.171
3.0	0.858
FCC SPECIFICATION	±1952.50 MHz (±0.05ppm) ±0.05ppm = ±97.625Hz
FCC RESULT	PASS

Transmit Frequency Deviation at +50°C at 100% of Nominal Voltage, 208VAC	
Time (minutes)	Transmit Carrier Deviation (Hz)
0	0.648
0.5	0.936
1.0	1.172
1.5	0.616
2.0	0.480
2.5	1.152
3.0	0.635
FCC SPECIFICATION	±1952.50 MHz (±0.05ppm) ±0.05ppm = ±97.625Hz
FCC RESULT	PASS

Transmit Frequency Deviation at +50°C at 100% of Nominal Voltage, 115VAC	
Time (minutes)	Transmit Carrier Deviation (Hz)
0	0.902
0.5	1.993
1.0	0.675
1.5	1.141
2.0	0.959
2.5	0.835
3.0	1.321
FCC SPECIFICATION	±1952.50 MHz (±0.05ppm) ±0.05ppm = ±97.625Hz
FCC RESULT	PASS

Transmit Frequency Deviation at +40°C at 100% of Nominal Voltage, 208VAC	
Time (minutes)	Transmit Carrier Deviation (Hz)
0	0.724
0.5	0.578
1.0	0.249
1.5	0.365
2.0	1.532
2.5	1.113
3.0	0.754
FCC SPECIFICATION	±1952.50 MHz (±0.05ppm) ±0.05ppm = ±97.625Hz
FCC RESULT	PASS

Transmit Frequency Deviation at +40°C at 100% of Nominal Voltage, 115VAC	
Time (minutes)	Transmit Carrier Deviation (Hz)
0	1.682
0.5	1.088
1.0	0.437
1.5	0.958
2.0	0.927
2.5	1.211
3.0	0.881
FCC SPECIFICATION	±1952.50 MHz (±0.05ppm) ±0.05ppm = ±97.625Hz
FCC RESULT	PASS

Transmit Frequency Deviation at +30°C at 100% of Nominal Voltage, 208VAC	
Time (minutes)	Transmit Carrier Deviation (Hz)
0	1.372
0.5	0.436
1.0	0.535
1.5	0.338
2.0	0.735
2.5	0.814
3.0	1.514
FCC SPECIFICATION	±1952.50 MHz (±0.05ppm) ±0.05ppm = ±97.625Hz
FCC RESULT	PASS

Transmit Frequency Deviation at +30°C at 100% of Nominal Voltage, 115VAC	
Time (minutes)	Transmit Carrier Deviation (Hz)
0	0.766
0.5	1.218
1.0	0.838
1.5	0.975
2.0	0.370
2.5	1.612
3.0	0.759
FCC SPECIFICATION	±1952.50 MHz (±0.05ppm) ±0.05ppm = ±97.625Hz
FCC RESULT	PASS

Transmit Frequency Deviation at +20°C at 100% of Nominal Voltage, 208VAC	
Time (minutes)	Transmit Carrier Deviation (Hz)
0	1.117
0.5	0.892
1.0	0.586
1.5	0.612
2.0	0.375
2.5	0.833
3.0	0.980
FCC SPECIFICATION	±1952.50 MHz (±0.05ppm) ±0.05ppm = ±97.625Hz
FCC RESULT	PASS

Transmit Frequency Deviation at +20°C at 100% of Nominal Voltage, 115VAC	
Time (minutes)	Transmit Carrier Deviation (Hz)
0	0.617
0.5	0.724
1.0	0.577
1.5	0.961
2.0	1.227
2.5	0.856
3.0	0.416
FCC SPECIFICATION	±1952.50 MHz (±0.05ppm) ±0.05ppm = ±97.625Hz
FCC RESULT	PASS

Transmit Frequency Deviation at +10°C at 100% of Nominal Voltage, 208VAC	
Time (minutes)	Transmit Carrier Deviation (Hz)
0	0.708
0.5	0.679
1.0	1.221
1.5	0.710
2.0	0.894
2.5	0.666
3.0	0.391
FCC SPECIFICATION	±1952.50 MHz (±0.05ppm) ±0.05ppm = ±97.625Hz
FCC RESULT	PASS

Transmit Frequency Deviation at +10°C at 100% of Nominal Voltage, 115VAC	
Time (minutes)	Transmit Carrier Deviation (Hz)
0	0.448
0.5	0.782
1.0	0.576
1.5	0.490
2.0	1.129
2.5	0.894
3.0	0.943
FCC SPECIFICATION	±1952.50 MHz (±0.05ppm) ±0.05ppm = ±97.625Hz
FCC RESULT	PASS

Transmit Frequency Deviation at 0°C at 100% of Nominal Voltage, 208VAC	
Time (minutes)	Transmit Carrier Deviation (Hz)
0	0.966
0.5	0.887
1.0	0.734
1.5	0.907
2.0	0.541
2.5	1.117
3.0	0.874
FCC SPECIFICATION	±1952.50 MHz (±0.05ppm) ±0.05ppm = ±97.625Hz
FCC RESULT	PASS

Transmit Frequency Deviation at 0°C at 100% of Nominal Voltage, 115VAC	
Time (minutes)	Transmit Carrier Deviation (Hz)
0	0.518
0.5	1.076
1.0	0.743
1.5	1.116
2.0	0.749
2.5	0.572
3.0	0.653
FCC SPECIFICATION	±1952.50 MHz (±0.05ppm) ±0.05ppm = ±97.625Hz
FCC RESULT	PASS

Transmit Frequency Deviation at -10°C at 100% of Nominal Voltage, 208VAC	
Time (minutes)	Transmit Carrier Deviation (Hz)
0	0.687
0.5	1.108
1.0	0.341
1.5	0.764
2.0	0.786
2.5	0.409
3.0	0.960
FCC SPECIFICATION	±1952.50 MHz (±0.05ppm) ±0.05ppm = ±97.625Hz
FCC RESULT	PASS

Transmit Frequency Deviation at -10°C at 100% of Nominal Voltage, 115VAC	
Time (minutes)	Transmit Carrier Deviation (Hz)
0	0.650
0.5	0.437
1.0	0.631
1.5	1.113
2.0	0.576
2.5	1.070
3.0	0.783
FCC SPECIFICATION	±1952.50 MHz (±0.05ppm) ±0.05ppm = ±97.625Hz
FCC RESULT	PASS

Transmit Frequency Deviation at -20°C at 100% of Nominal Voltage, 208VAC	
Time (minutes)	Transmit Carrier Deviation (Hz)
0	0.645
0.5	0.776
1.0	0.626
1.5	0.984
2.0	0.877
2.5	0.340
3.0	0.813
FCC SPECIFICATION	±1952.50 MHz (±0.05ppm) ±0.05ppm = ±97.625Hz
FCC RESULT	PASS

Transmit Frequency Deviation at -20°C at 100% of Nominal Voltage, 115VAC	
Time (minutes)	Transmit Carrier Deviation (Hz)
0	0.967
0.5	0.741
1.0	0.826
1.5	1.013
2.0	0.958
2.5	0.815
3.0	0.394
FCC SPECIFICATION	±1952.50 MHz (±0.05ppm) ±0.05ppm = ±97.625Hz
FCC RESULT	PASS

Transmit Frequency Deviation at -30°C at 100% of Nominal Voltage, 208VAC	
Time (minutes)	Transmit Carrier Deviation (Hz)
0	0.874
0.5	1.061
1.0	0.576
1.5	0.761
2.0	0.975
2.5	0.352
3.0	0.513
FCC SPECIFICATION	±1952.50 MHz (±0.05ppm) ±0.05ppm = ±97.625Hz
FCC RESULT	PASS

Transmit Frequency Deviation at -30°C at 100% of Nominal Voltage, 115VAC	
Time (minutes)	Transmit Carrier Deviation (Hz)
0	0.444
0.5	0.908
1.0	0.762
1.5	0.849
2.0	1.012
2.5	0.547
3.0	0.869
FCC SPECIFICATION	±1952.50 MHz (±0.05ppm) ±0.05ppm = ±97.625Hz
FCC RESULT	PASS

Upon return to +25°C.

Transmit Frequency Deviation at +25°C at 100% of Nominal Voltage, 208VAC	
Time (minutes)	Transmit Carrier Deviation (Hz)
0	0.785
0.5	1.024
1.0	0.621
1.5	0.705
2.0	0.860
2.5	0.813
3.0	0.438
FCC SPECIFICATION	±1952.50 MHz (±0.05ppm) ±0.05ppm = ±97.625Hz
FCC RESULT	PASS

Transmit Frequency Deviation at +25°C at +15% of Nominal Voltage, 239.20VAC	
Time (minutes)	Transmit Carrier Deviation (Hz)
0	0.383
0.5	0.866
1.0	0.541
1.5	0.799
2.0	0.335
2.5	0.952
3.0	0.907
FCC SPECIFICATION	±1952.50 MHz (±0.05ppm) ±0.05ppm = ±97.625Hz
FCC RESULT	PASS

Transmit Frequency Deviation at +25°C at -15% of Nominal Voltage, 176.80VAC	
Time (minutes)	Transmit Carrier Deviation (Hz)
0	1.035
0.5	0.769
1.0	0.875
1.5	0.447
2.0	0.736
2.5	0.587
3.0	1.002
FCC SPECIFICATION	±1952.50 MHz (±0.05ppm) ±0.05ppm = ±97.625Hz
FCC RESULT	PASS

Upon return to +25°C.

Transmit Frequency Deviation at +25°C at 100% of Nominal Voltage, 115VAC	
Time (minutes)	Transmit Carrier Deviation (Hz)
0	0.898
0.5	0.583
1.0	0.329
1.5	0.409
2.0	0.591
2.5	0.394
3.0	1.021
FCC SPECIFICATION	±1952.50 MHz (±0.05ppm) ±0.05ppm = ±97.625Hz
FCC RESULT	PASS

Transmit Frequency Deviation at +25°C at +15% of Nominal Voltage, 132.25VAC	
Time (minutes)	Transmit Carrier Deviation (Hz)
0	0.651
0.5	0.973
1.0	1.012
1.5	0.685
2.0	0.555
2.5	0.306
3.0	0.682
FCC SPECIFICATION	±1952.50 MHz (±0.05ppm) ±0.05ppm = ±97.625Hz
FCC RESULT	PASS

Transmit Frequency Deviation at +25°C at -15% of Nominal Voltage, 97.75VAC	
Time (minutes)	Transmit Carrier Deviation (Hz)
0	0.703
0.5	0.420
1.0	0.594
1.5	0.921
2.0	0.622
2.5	0.706
3.0	0.483
FCC SPECIFICATION	±1952.50 MHz (±0.05ppm) ±0.05ppm = ±97.625Hz
FCC RESULT	PASS

18. Exhibit 18 Photographs of the Test Setups

The following photographs document the test setups.

Radiated Emissions Test Photograph A 9764 MetroCell Configured for 30 MHz-1 GHz Measurement

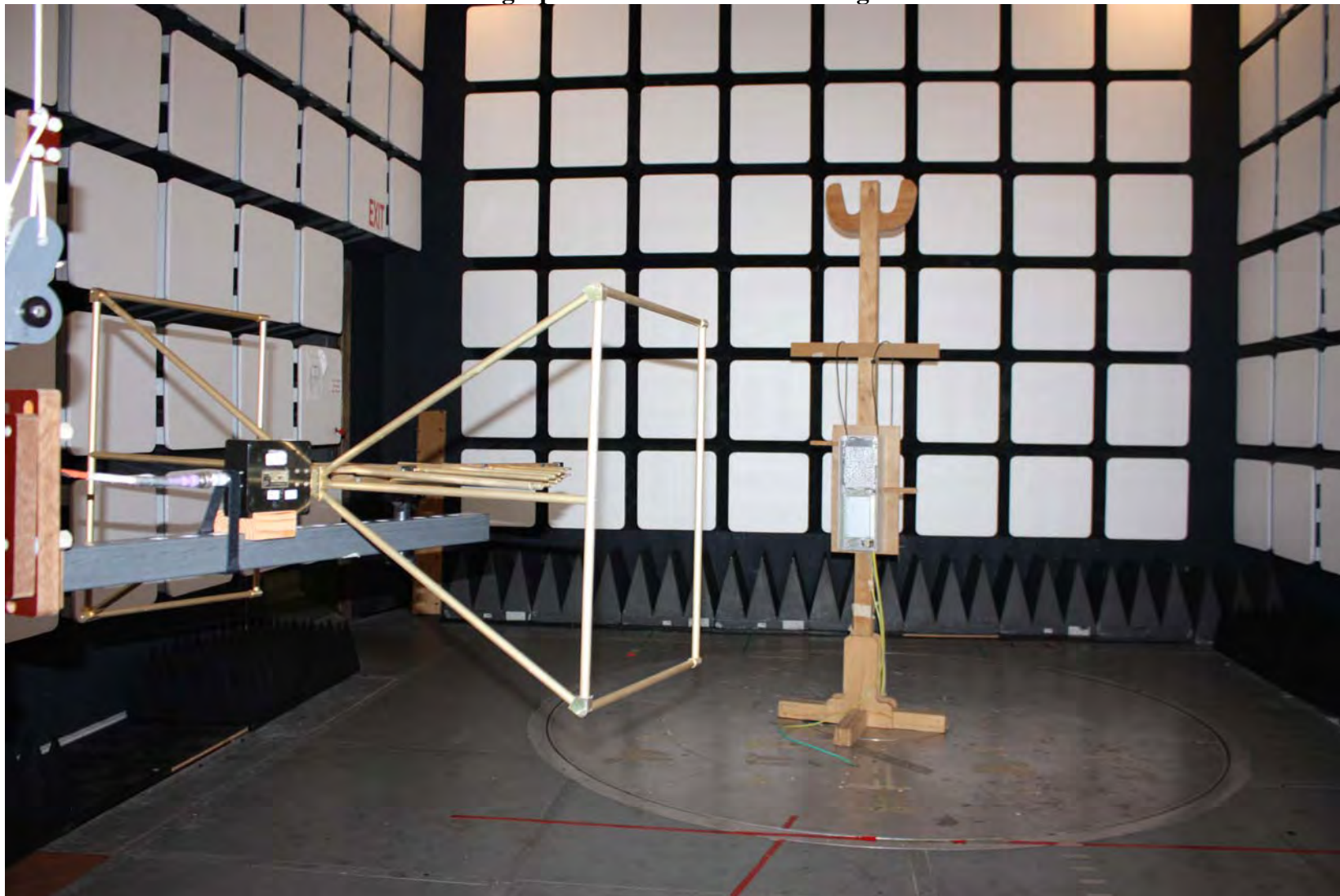

Radiated Emissions Test Photograph B

9764 MetroCell Configured for 1-18 GHz Measurement

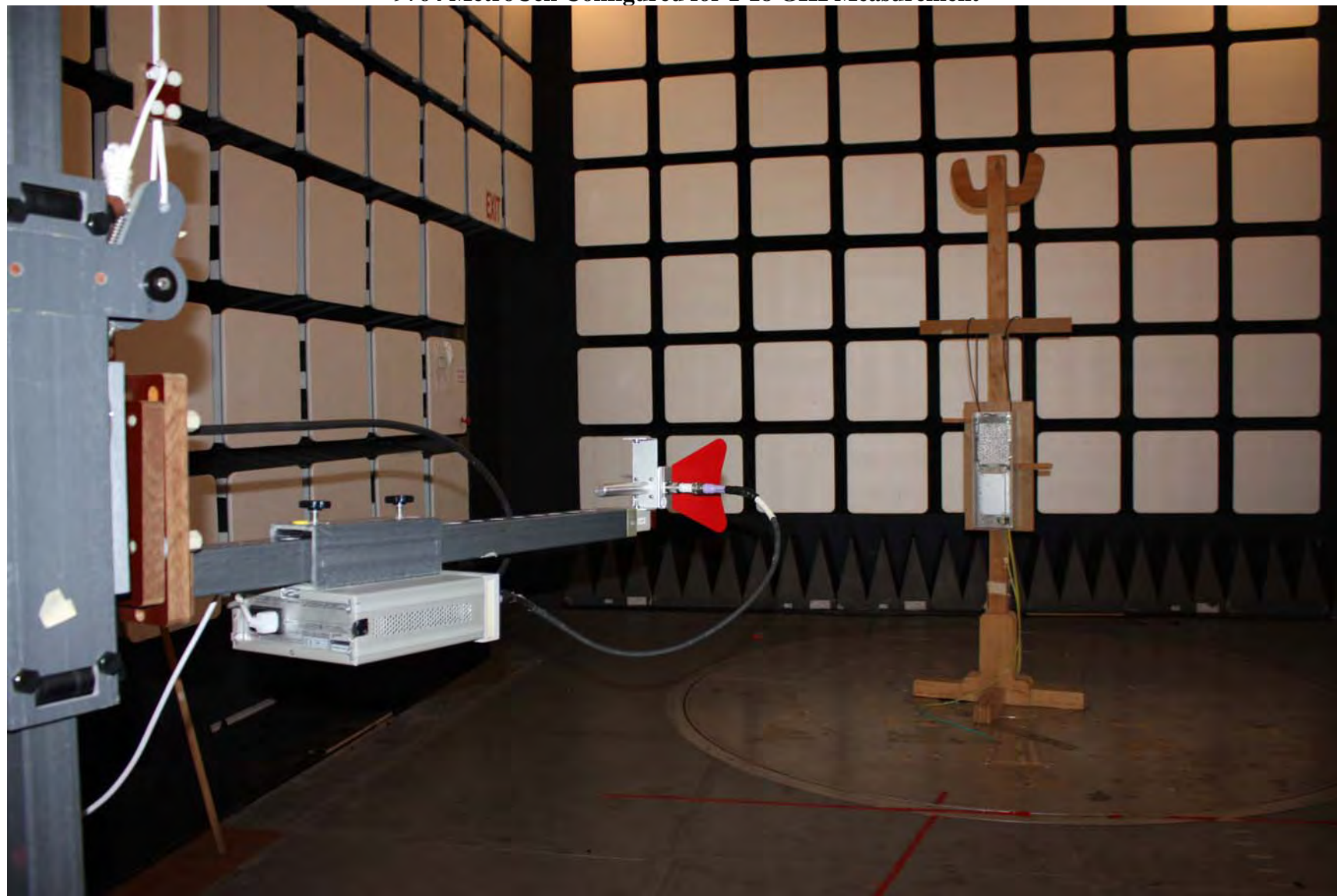

Radiated Emissions Test Photograph C

9764 MetroCell Configured for 18-20 GHz Measurement

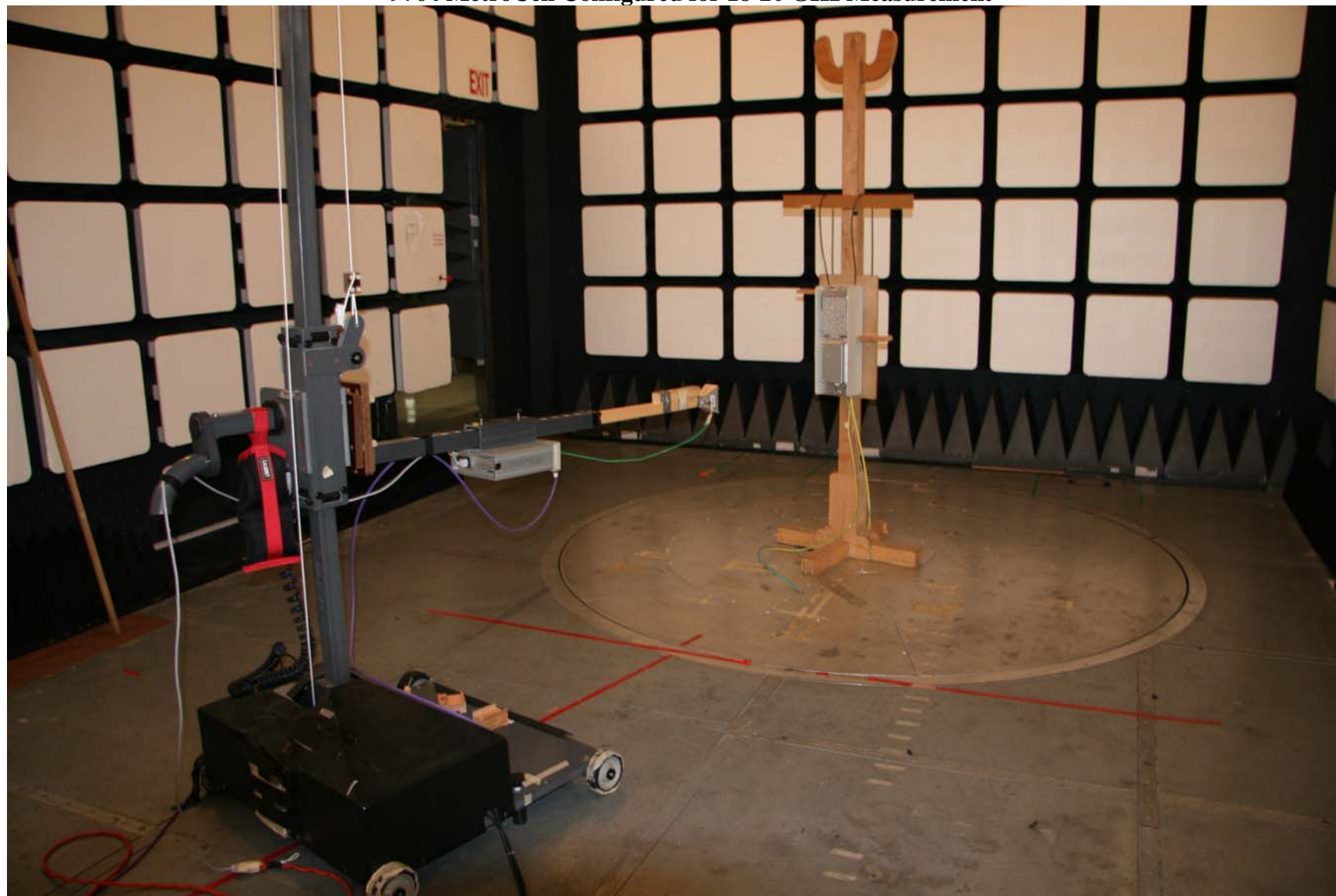

Conducted Test Setup Photograph for RF Power, OBW, Conducted Spurious and Modulation

