

Global Product Compliance Laboratory  
600-700 Mountain Avenue  
Room 5B-108  
Murray Hill, New Jersey 07974-0636 USA



# **Title 47 Code of Federal Regulations Test Report**

Regulation:  
FCC Part 2 and 27

Client:  
Nokia of America Corporation

Product Evaluated:  
NB IoT IB and GB UHBC MTI Additional GB Carriers

Report Number:  
TR-2019-0169-FCC2-27

Date Issued:  
December 10, 2019

This report shall not be reproduced, in whole or in part without the approval of Nokia Global Product Compliance Laboratory. This report must not be used by the recipient to claim product endorsement by NVLAP or any other agency of the U.S. Government.

# Table of Contents

- 1. SYSTEM INFORMATION AND REQUIREMENTS..... 4**
  - 1.1 INTRODUCTION ..... 5
  - 1.2 PURPOSE AND SCOPE ..... 5
  - 1.3 EUT DETAILS ..... 5
  - 1.4 TEST REQUIREMENTS..... 7
  - 1.5 STANDARDS & PROCEDURES ..... 7
  - 1.6 EXECUTIVE SUMMARY ..... 9
  - 1.7 TEST CONFIGURATION FOR ALL ANTENNA PORT MEASUREMENTS. .... 9
- 2. FCC SECTION 2.1046 - RF POWER OUTPUT ..... 10**
  - 2.1 RF POWER OUTPUT..... 10
- 3. FCC SECTION 2.1047 - MODULATION CHARACTERISTICS ..... 12**
  - 3.1 MODULATION CHARACTERISTICS ..... 12
- 4. FCC SECTION 2.1049 – OCCUPIED BANDWIDTH/EDGE OF BAND EMISSIONS..... 13**
  - 4.1 OCCUPIED BANDWIDTH..... 13
  - 4.2 EDGE OF BAND EMISSIONS..... 14
- 5. FCC SECTION 2.1051 - SPURIOUS EMISSIONS AT TRANSMIT ANTENNA PORT..... 16**
  - 5.1 MEASUREMENT OF SPURIOUS EMISSIONS AT TRANSMIT ANTENNA PORT..... 16
- 6. FCC SECTION 2.1053 - FIELD STRENGTH OF SPURIOUS RADIATION ..... 20**
  - 6.1 SECTION 2.1053 FIELD STRENGTH OF SPURIOUS EMISSIONS ..... 20
  - 6.2 FIELD STRENGTH OF SPURIOUS EMISSIONS - LIMITS ..... 20
- 7. NVLAP CERTIFICATE OF ACCREDITATION ..... 21**

**Revisions**

Date	Revision	Section	Change
12/10/19	0		Initial Release

*Nokia Global Product Compliance Laboratories is accredited by the National Voluntary Laboratory Accreditation Program (NVLAP®) for specific services, listed on the Scope of Accreditation, for: Electromagnetic Compatibility and Telecommunications. This laboratory is accredited in accordance with the recognized International Standard ISO/IEC 17025:2005. This accreditation demonstrates technical competence for a defined scope and the operation of a laboratory quality management system (refer to joint ISO-ILAC-IAF Communiqué dated January 2009). NVLAP LAB CODE: 100275-0.*

*Nokia Global Product Compliance Laboratory represents to the client that the laboratory’s accreditation or any of its calibration or test reports in no way constitutes or implies product certification, approval, or endorsement by NVLAP, NIST, or any agency of the federal government.*

Prepared By:   
 Signed: \_\_\_\_\_ 12/10/2019  
 Ann Chang  
 Compliance Engineer  
 NVLAP Signatory  
 Ann.chang@nokia-bell-labs.com

Approved By:   
 Signed: \_\_\_\_\_ 12/10/2019  
 Raymond Johnson  
 Technical Manager  
 NVLAP Signatory  
 ray.johnson@nokia-bell-labs.com

Reviewed By:   
 Signed: \_\_\_\_\_ 12/10/2019  
 Steve Gordon  
 EMC Engineer  
 NVLAP Signatory  
 steve.gordon@nokia-bell-labs.com

## 1. System Information and Requirements

Report copies and other information not contained in this report are held by either the product engineer or in an identified file at the Global Product Compliance Laboratory in Murray-Hill, NJ.

<b>Equipment Under Test (EUT):</b>	NB IoT IB and GB UHBC MTI Additional GB Carriers
<b>FCC ID:</b>	AS5BBTRX-01
<b>Serial Number:</b>	LBALLU-GP121311664
<b>Hardware Version:</b>	KS24817L1 1:1
<b>Software Version:</b>	FL19A
<b>Frequency Range:</b>	Transmit: 746 – 756 MHz; Receive: 777 – 787 MHz
<b>GPCL Project Number:</b>	2019-0169
<b>Manufacturer:</b>	NOKIA SOLUTIONS AND NETWORKS OY KARAPORTTI 3, FI-02610 ESPOO FINLAND
<b>Test Requirement(s):</b>	Title 47 CFR Parts 2 and 27
<b>Test Standards:</b>	<ul style="list-style-type: none"> <li>• Title 47 CFR Parts 2 and 27</li> <li>• KDB 971168 D01 Power Measurement License Digital Systems v03r01 April 9, 2018.</li> <li>• KDB 662911 D01 Multiple Transmitter Output v02r01 Oct 2013</li> <li>• ANSI C63.26 (2015)</li> <li>• ANSI C63.4 (2014)</li> </ul>
<b>Measurement Procedure(s):</b>	<ul style="list-style-type: none"> <li>• FCC-IC-OB - GPCL Occupied Bandwidth and Power Measurement Test Procedure 12-4-2017</li> <li>• FCC-IC-SE - GPCL Spurious Emissions Test Procedure 12-4-2017</li> </ul>
<b>Test Date(s):</b>	October 2019
<b>Test Performed By:</b>	Nokia Global Product Compliance Laboratory 600-700 Mountain Ave. P.O. Box 636 Murray Hill, NJ 07974-0636
<b>Product Engineer(s):</b>	Ron Remy
<b>Lead Engineer:</b>	Steve Gordon
<b>Test Engineer (s):</b>	Steve Gordon
<b>Test Results:</b> The EUT, <i>as tested</i> met the above listed requirements. Report copies and other information not contained in this report are held by either the product engineer or in an identified file at the Global Product Compliance Laboratory in New Providence, NJ.	

## 1.1 Introduction

This Conformity test report applies to the NB IoT IB and GB UHBC MTI Additional GB Carriers, hereinafter referred to as the Equipment Under Test (EUT).

## 1.2 Purpose and Scope

The purpose of this document is to provide the testing data required for qualifying the EUT in compliance with FCC Parts 2 and 27 measured in accordance with the procedures set out in Section 2.1033 (c) (14) of the Rules.

This testing demonstrates compliance for an additional NB-IoT channel operation of the product for both In Band and Guard Band operation. This product was previously qualified for single channel NB-IoT Guard Band operation on either side of the carrier. This testing is required for the Class II permissive change to FCC ID AS5BBTRX-01 due to increases in bandwidth for the addition of the second simultaneous Guard Band channel.

## 1.3 EUT Details

### 1.3.1 Specifications

Specification Items	Description
Radio Access Technology	LTE
Duplex Mode	Frequency Division Duplex (FDD)
Modulation Type(s)	QPSK
Operation Frequency Range	746 MHz – 756 MHz
Channel Bandwidth	10 MHz
Number of Tx Ports per Unit	2
Number of Rx Ports Per Unit	2
MIMO	Yes
Deployment Environment	Outdoor
Supply Voltage	-48.0 VDC

### 1.3.2 Photographs

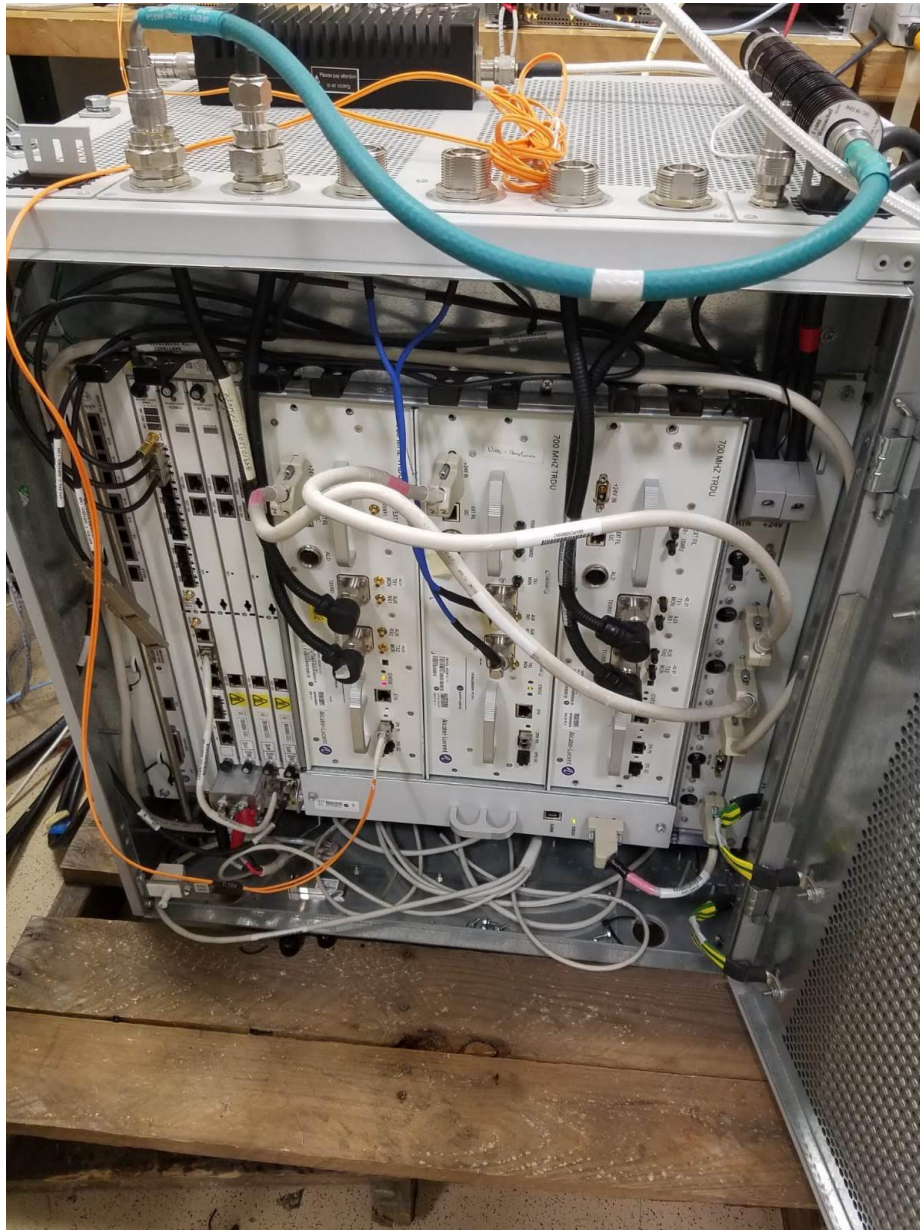

## 1.4 Test Requirements

Each required measurement is listed below:

47 CFR FCC Sections	Description of Tests	Test Required
2.1046, 27.53	RF Power Output	Yes
2.1047, 27.53	Modulation Characteristics	Yes
2.1049, 27.53	(a) Occupied Bandwidth (b) Out-of-Band Emissions	Yes
2.1051, 27.53	Spurious Emissions at Antenna Terminals	Yes
2.1053, 27.53	Field Strength of Spurious Radiation	Yes
2.1055, 27.53	Frequency Stability	No

## 1.5 Standards & Procedures

### 1.5.1 Standards

- Title 47 Code of Federal Regulations, Federal Communications Commission Part 2.
- Title 47 Code of Federal Regulations, Federal Communications Commission Part 27.
- ANSI C63.26, American National Standard for Compliance Testing of Transmitters Used in Licensed Radio Services

### 1.5.2 Procedures

1. FCC-IC-0B and FCC-IC-SE
2. ANSI C63.4 (2014) entitled: “American National Standard for Methods of Measurement of Radio-Noise Emissions from Low Voltage Electrical and Electronic Equipment in the Range of 9kHz to 40 GHz”, American National Standards Institute, Institute of Electrical and Electronic Engineers, Inc., New York, NY 10017-2394, USA.
3. FCC KDB 971168 D01 Power Measurement License Digital Systems v03r01 April 9, 2018.  
 FCC KDB 662911 D01 Multiple Transmitter Output v02r01 Oct 2013

### 1.5.3 MEASUREMENT UNCERTAINTY

The results of the calculations to estimate uncertainties for the several test methods and standards are shown in the Table below. These are the worst-case values.

**Worst-Case Estimated Measurement Uncertainties**

Standard, Method or Procedure	Condition	Frequency MHz	Expanded Uncertainty (k=2)
a. Classical Emissions, (e.g., ANSI C63.4, CISPR 11, 14, 22, etc., using ESHS 30,	Conducted Emissions	0.009 - 30	±3.5 dB
	Radiated Emissions (AR-6 Semi-Anechoic Chamber)	30 MHz – 200MHz H 30 MHz – 200 MHz V 200 MHz – 1000 MHz H 200 MHz – 1000 MHz V 1 GHz - 18 GHz	±5.1 dB ±5.1 dB ±4.7 dB ±4.7 dB ±3.3 dB

Antenna Port Test	Signal Bandwidth	Frequency Range	Expanded Uncertainty (k=2), Amplitude
Occupied Bandwidth, Edge of Band, Conducted Spurious Emissions	10 Hz	9 kHz to 20 MHz	1.78 dB
	100 Hz	20 MHz to 1 GHz	
	10 kHz to 1 MHz	1 GHz to 10 GHz	
	1MHz	10 GHz to 40 GHz:	
RF Power	10 Hz to 20 MHz	50 MHz to 18 GHz	0.5 dB



### 1.6 Executive Summary

Requirement	Description	Result
47 CFR FCC Parts 2 and 27		
2.1046, 27.53	RF Power Output Peak to Average Power Ratio	COMPLIES
2.1047, 27.53	Modulation Characteristics	COMPLIES
2.1049, 27.53	(a) Occupied Bandwidth (b) Edge of Band Emissions	COMPLIES
2.1051, 27.53	Spurious Emissions at Antenna Terminals	COMPLIES
2.1053, 27.53	Field Strength of Spurious Radiation	COMPLIES
2.1055, 27.53	Frequency Stability	NT

1. **COMPLIES** - Passed all applicable tests.
2. **N/A** – Not Applicable.
3. **NT** – Not Tested.

### 1.7 Test Configuration for all Antenna Port Measurements.

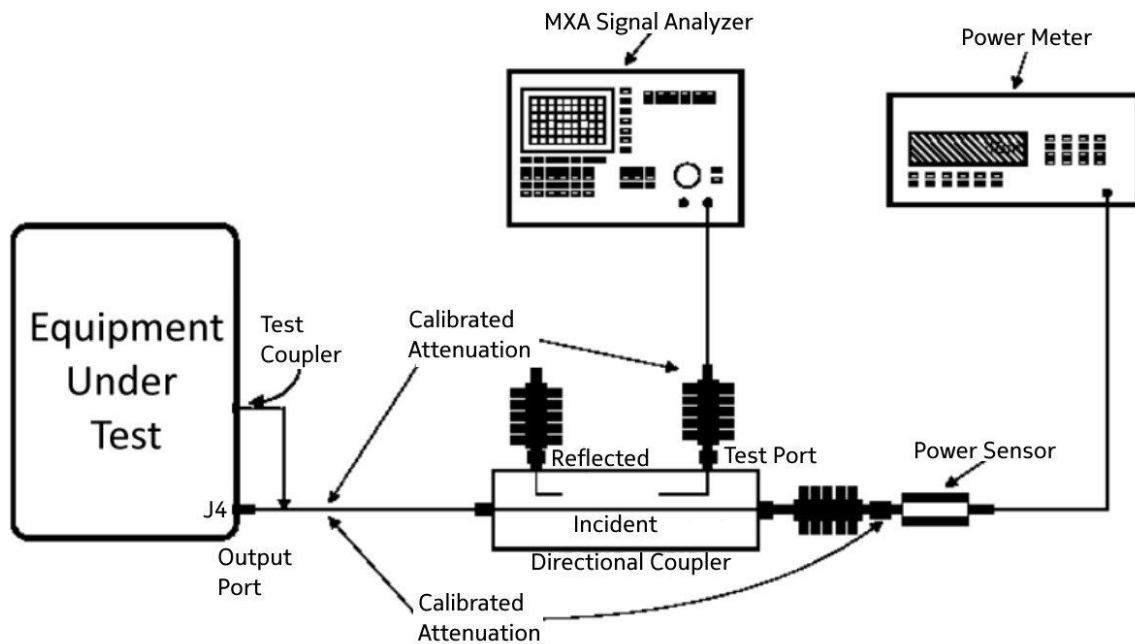

## 2. FCC Section 2.1046 - RF Power Output

### 2.1 RF Power Output

This test is a measurement of the total RF power level transmitted at the antenna-transmitting terminal. The product was configured for test as shown in section above and allowed to warm up and stabilize per KDB 971168 D01 and ANSI C63.26.

Power measurements were made with an MXA Signal Analyzer.

Tabular Data – Channel RF Power

Channel Frequency MHz	Signal BW MHz	Modulation	Channel Power dBm
751	10	QPSK	46.48

#### 2.1.1 Channel RF Power - Plots

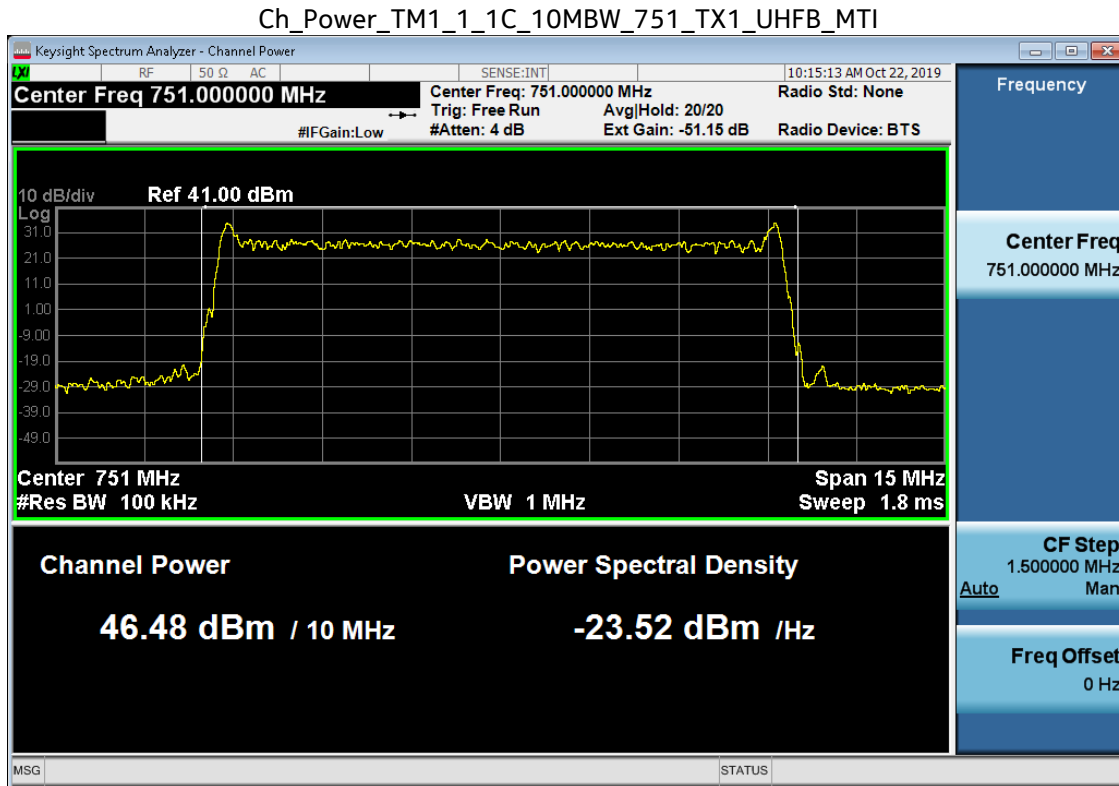

### 2.1.2 Peak-to-Average Power Ratio (PAPR) – Plots

The Peak-to-Average Power Ratio (PAPR) was evaluated per KDB 971168 for 10MHz bandwidths with QPSK modulation for In Band and Guard Band. The PAPR values of all carriers measured are below 13dB.

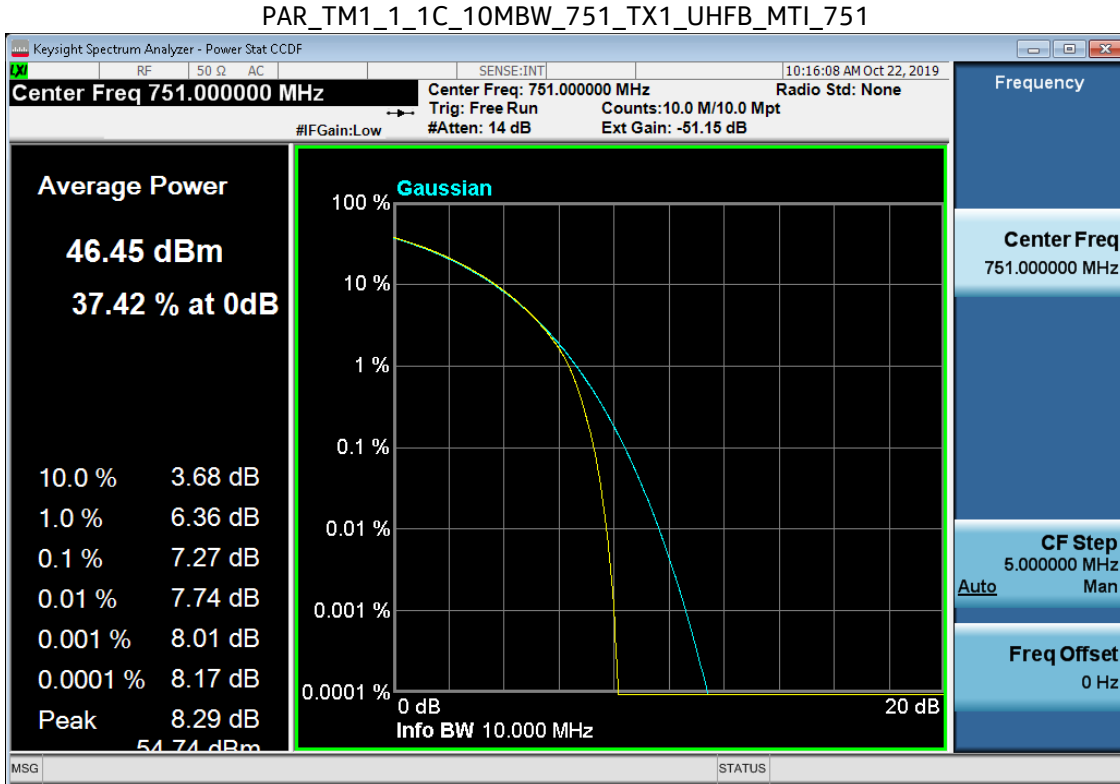

### 3. FCC Section 2.1047 - Modulation Characteristics

#### 3.1 Modulation Characteristics

The RF signal at the antenna port was demodulated and verified for correctness of the modulation signal used before each test was performed. For this product the operation with QPSK modulation was evaluated and verified to demonstrate proper operation before testing.

##### 3.1.1 Modulation Characteristics – Plots

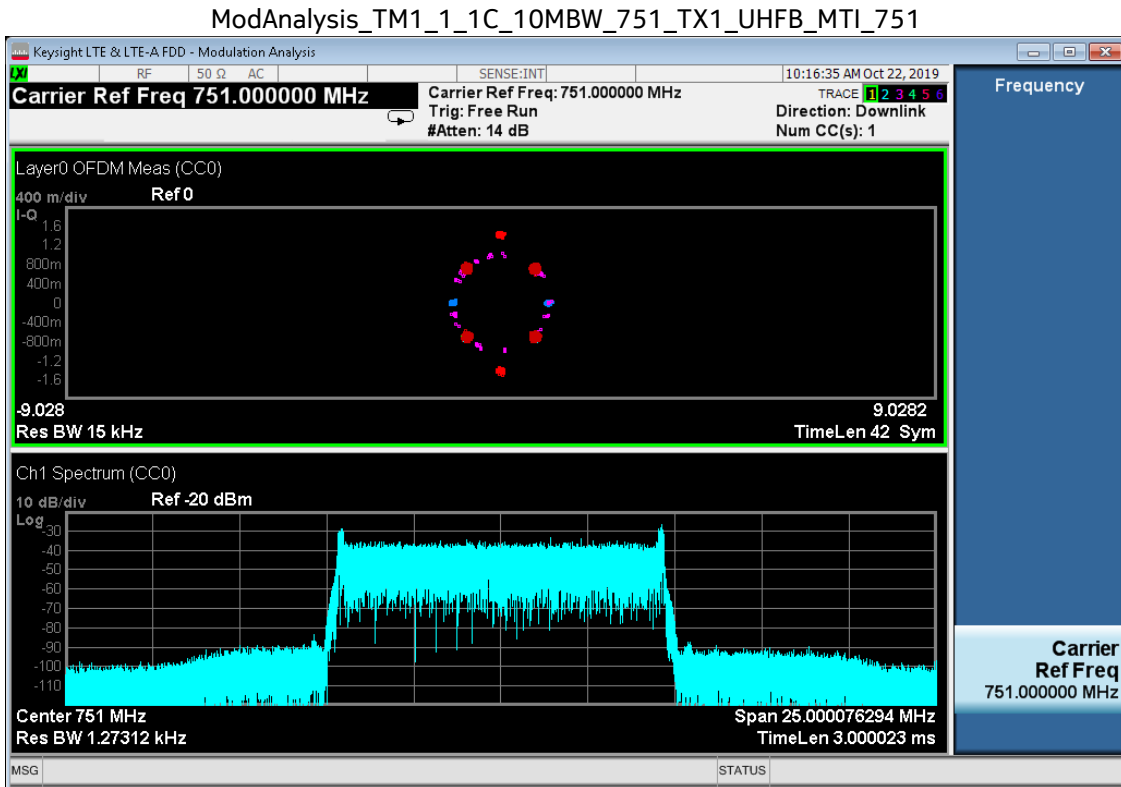

## 4. FCC Section 2.1049 – Occupied Bandwidth/Edge of Band Emissions

### 4.1 Occupied Bandwidth

In 47CFR 2.1049 the FCC requires:

“The occupied bandwidth, that is the frequency bandwidth such that, below its lower and above its upper frequency limits, the mean powers radiated are each equal to 0.5 percent of the total mean power radiated by a given emission shall be measured under the following conditions as applicable.”

This required measurement is the 99% Occupied Bandwidth, also called the designated signal bandwidth and needs to be within the parameters of the products specified emissions designator. During these measurements it is customary to evaluate the Edge of Band emissions at block/band edges.

The transmitted signal occupied bandwidth was measured using a Keysight MXA Signal Analyzer. All emissions were within the parameters as required.

Tabular Data – Occupied Bandwidth

Channel Frequency MHz	Signal BW MHz	Modulation	Occupied BW MHz
751	10	QPSK	9.4143

#### 4.1.1 Occupied Bandwidth – Plots

OBW\_TM1\_1\_1C\_10MBW\_751\_TX1\_UHFB\_MTI\_751

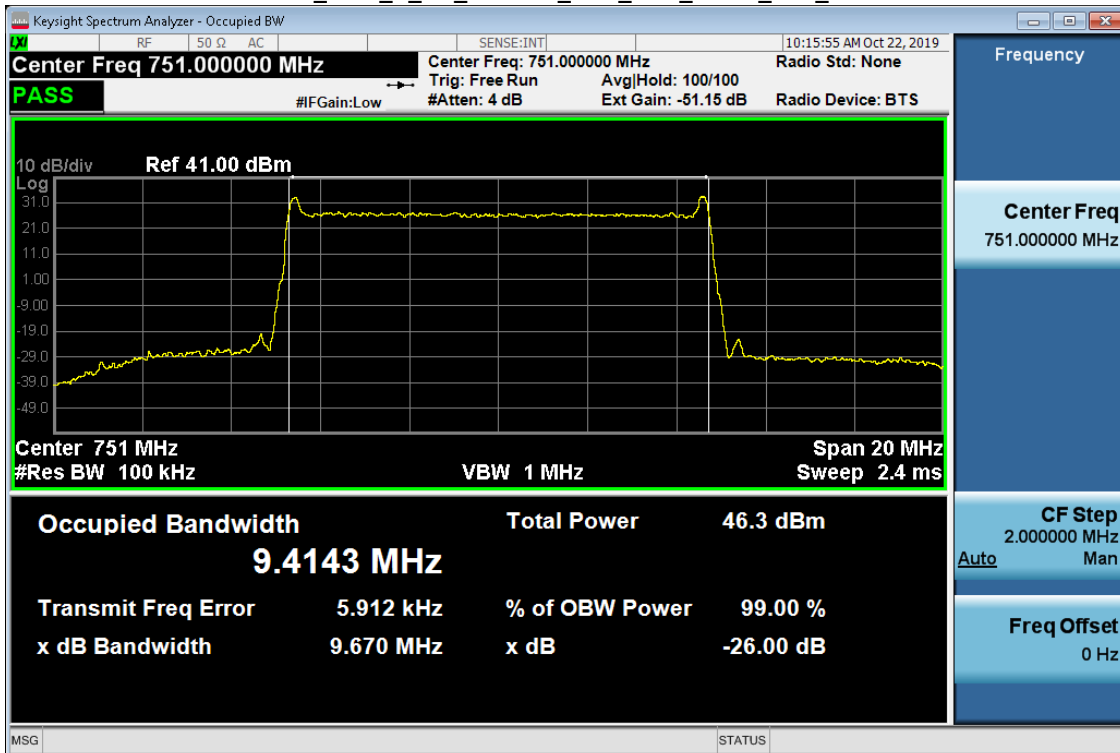

### 4.2 Edge of band Emissions

The Edge of Band emissions of the EUT at the external antenna connector (EAC) were measured using a Keysight MXA Signal Analyzer. The RF power level was continuously measured using a RF broadband power meter. The RF output from the EAC port to signal analyzer was reduced (to an amplitude usable by the signal analyzer) by using a calibrated attenuator and test coupler. The path attenuation was offset on the display and the signal for the carrier was adjusted to the corrected RF power level for the resolution bandwidth used for the transmit signal. All mask values were adjusted based upon the designated signal bandwidth and measurement bandwidths. The Top of Mask corresponds to the set rated power level as confirmed by the RF power meter.

#### 4.2.1 Edge of Band Emissions - Plots.

All of the measurements met the requirements of Part 27.53 when measured per Part 2.1049.

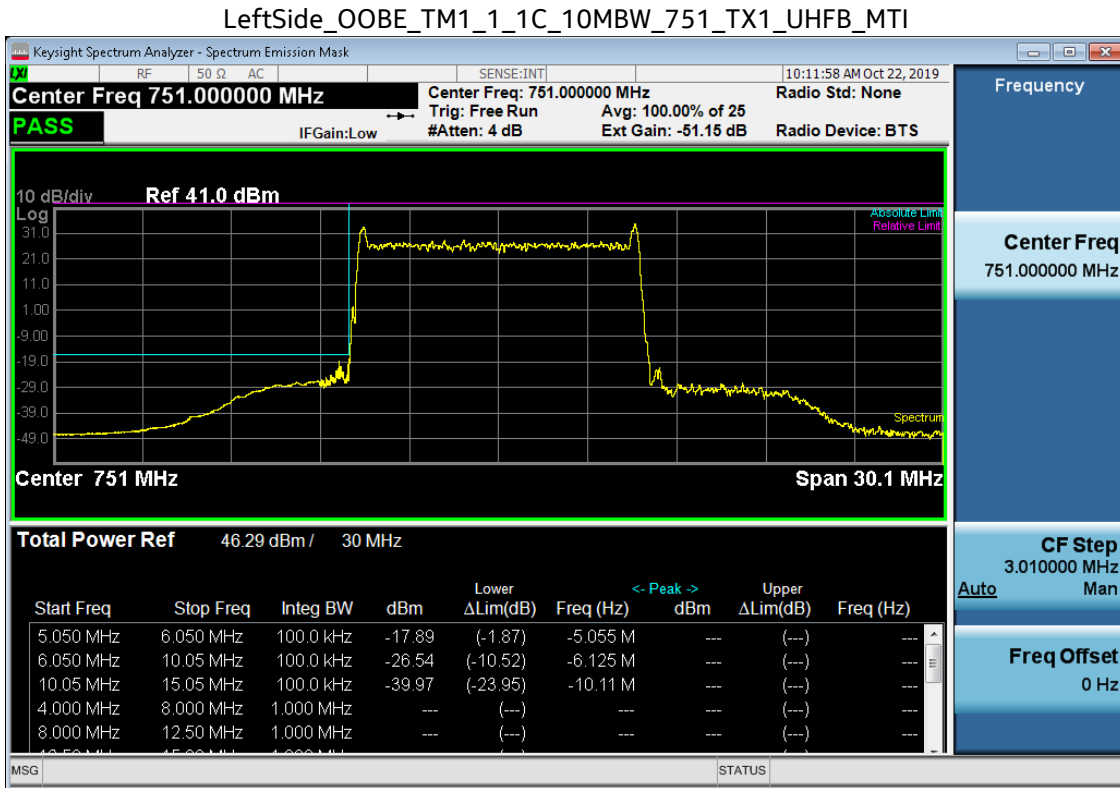

RightSide\_OOBE\_TM1\_1\_1C\_10MBW\_751\_TX1\_UHFB\_MTI

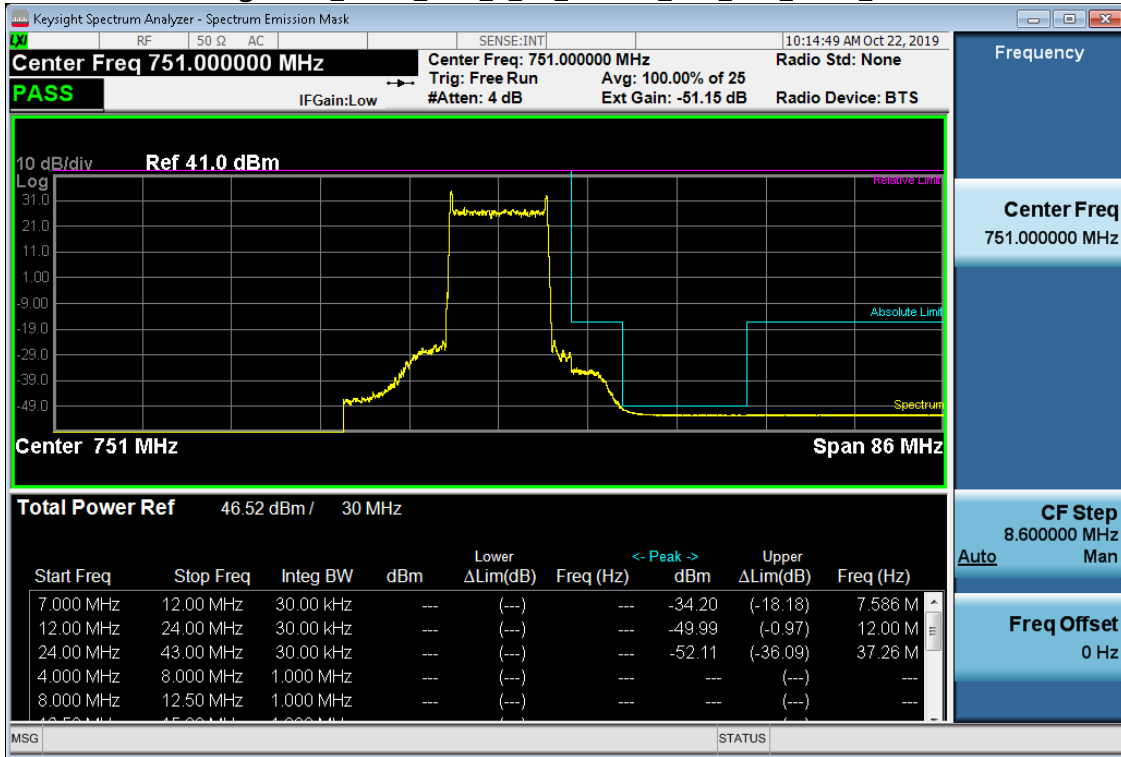

## 5. FCC Section 2.1051 - Spurious Emissions at Transmit Antenna Port

### 5.1 Measurement of Spurious Emissions at Transmit Antenna Port

Spurious Emissions at the transmit-antenna terminals were investigated over the frequency range of 10 MHz to beyond the 10th harmonic of the specific transmit band. For this band of operation, the measurements were performed up to 10 GHz. Measurements were made using a Keysight MXA Signal Analyzer. The RF output from the transmitter was reduced (to an amplitude usable by the receivers) using calibrated attenuators. The RF power level was continuously monitored via a coupled RF Power Meter.

The required emission limitation is specified as appropriate in 27.53. The measured spurious emission levels were plotted for the frequency range as specified in 2.1057. There were no reportable emissions. Data below documents performance up to 10 GHz.

#### 5.1.1 Spurious Emissions at Tx Port - Plots

NOTE: Only a sample of the plots are used in this report. The full suite of raw data resides at the MH, New Jersey location.

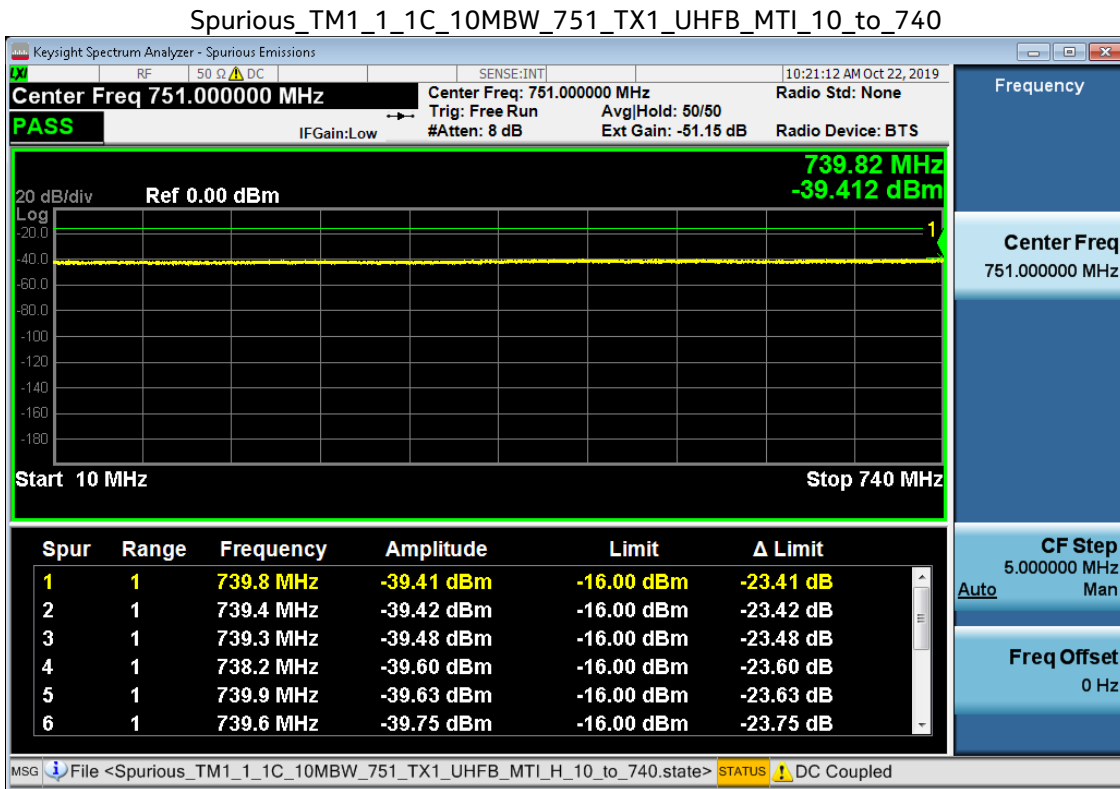



Spurious\_TM1\_1\_1C\_10MBW\_751\_TX1\_UHFB\_MTI\_760\_to\_1000

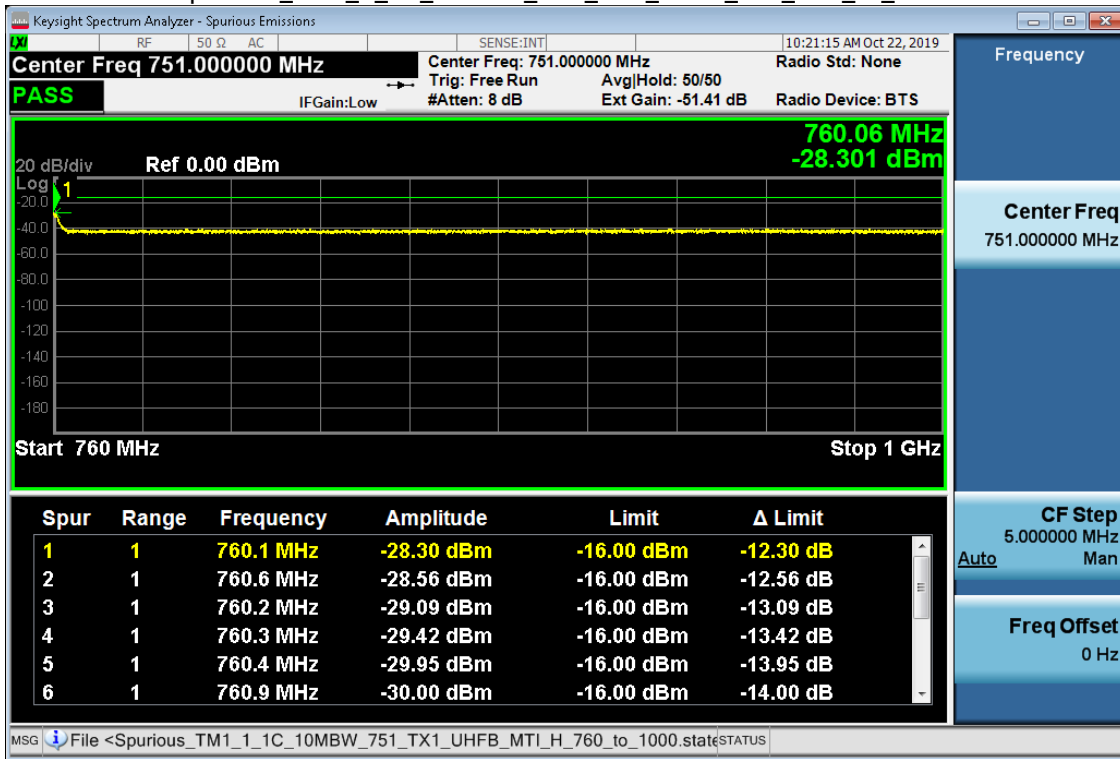

Spurious\_TM1\_1\_1C\_10MBW\_751\_TX1\_UHFB\_MTI\_1000\_to\_10000

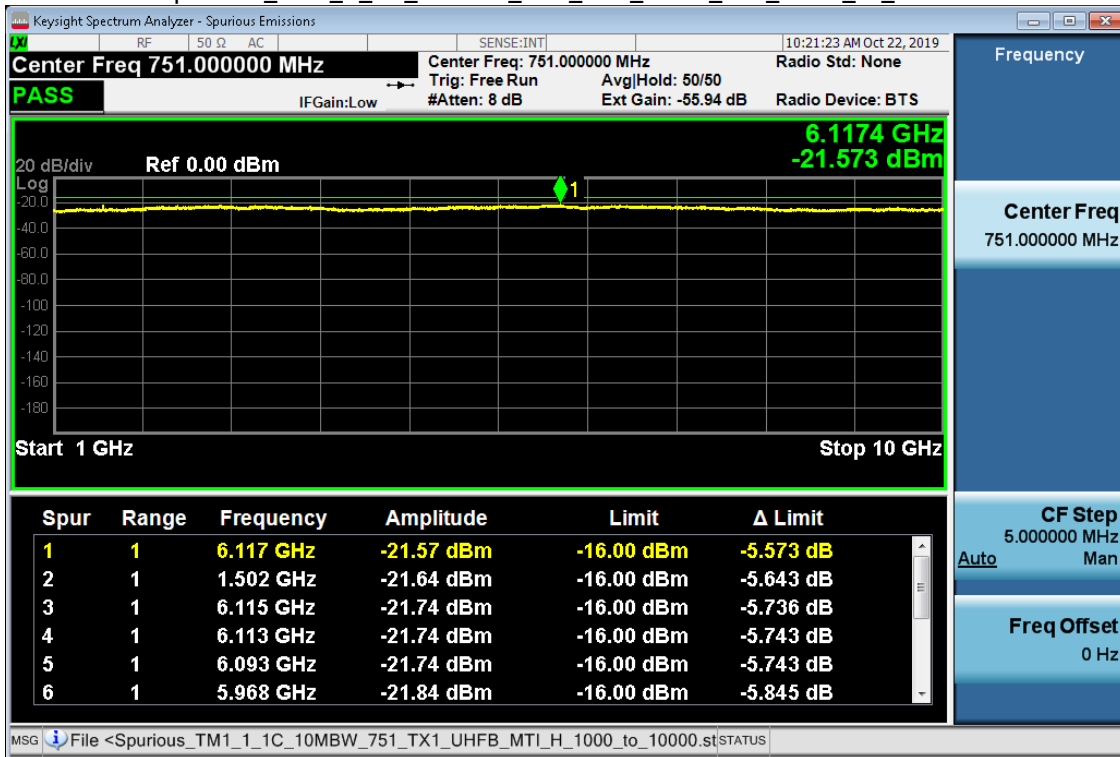

## Photographs

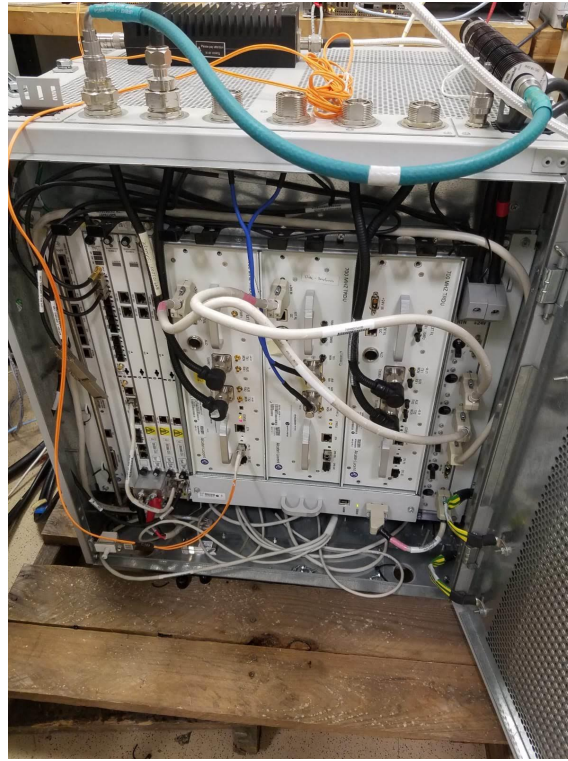

**Test Equipment**

Asset ID	Manufacturer	Type	Description	Model	Serial	Calibration Date	Calibration Due
E1152	Agilent Technologies	MXA Signal Analyzer	20Hz-26.5GHz Analyzer	N9020A	MY53420147	2019-04-24	2021-04-24
E1006	Weinschel	Attenuator	30 dB DC-18GHz 150W	6528-30-34-LIM	BN4172	CNR	CNR
E896	Agilent Technologies	Network Analyzer	10 MHz - 40 GHz	N5230C	MY49000897	2019-01-31	2021-01-31
E1120	Extech	Data Logger	Pressure Humidity Temp Data Logger	SD700	Q673552	2019-01-16	2021-01-16

CNR: Calibration Not Required

Environmental Conditions: RH= 21.9%, Temp=23.2 degree C, Pressure=981.1hPa

## 6. FCC Section 2.1053 - Field strength of spurious radiation

### 6.1 Section 2.1053 Field Strength of Spurious Emissions

Field strength measurements of radiated spurious emissions were made in an FCC registered 3m Semi-Anechoic Chamber which is maintained by Nokia Bell Labs in Murray Hill, New Jersey. A complete description and full measurement data for the site is on file with the Commission (Site Registration Number: 515091).

The spectrum from 30 MHz to beyond the tenth harmonic of the carrier, 10 GHz, was searched for spurious radiation. Measurements were made using both horizontally and vertically polarized broadband antennas. Per FCC regulations, the comparison of out of band spurious emissions directly to the limit is appropriately made using the substitution method. However, when the emissions are more than 20 dB below the specification limit, the use of field strength measurements for compliance determination is acceptable and those emissions are considered not reportable (Section 2.1053 and the FCC Interpretive database for 2.1053). For this case the evaluation of acceptable radiated field strength is as follows.

### 6.2 Field Strength of Spurious Emissions - Limits

Sections 2.1053 and 27.53 contain the requirements for the levels of spurious radiation as a function of the level of the unmodulated carrier. The reference level for the unmodulated carrier is calculated as the field produced by an ideal dipole excited by the transmitter output power according to the following relation taken from Reference Data for Radio Engineers, page 676, 4<sup>th</sup> edition, IT&T Corp.

$$E = [(30 \cdot P)^{1/2}] / R$$

$$20 \log (E \cdot 10^6) - (43 + 10 \log P) = 82.23 \text{ dB}\mu\text{V}/\text{meter}$$

Where:

E = Field Intensity in Volts/meter

P = Transmitted Power in Watts

R = Measurement distance in meters = 3 m

The Part 27 Limit is 82.23 dBuV/m at 3m and 91.77 dBuV/m at 1m

The Part 27 non-report level is 62.23 dBuV/m at 3m.

The calculated emission levels were found by:

$$\text{Measured level (dB}\mu\text{V)} + \text{Cable Loss(dB)} + \text{Antenna Factor(dB)} = \text{Field Strength (dB}\mu\text{V}/\text{m)}$$

#### RESULTS:

For compliance with 47CFR Parts 2 and 27, the field strength of any spurious radiation, measured at 3m, is required to be less than 82.23 dBuV/meter (82.23 @ 3m). Emissions equal to or less than 62.23 dBuV/meter at 3m are not reportable and may be verified using field strength measurements and broadband antennas. Over the out of band spectrum investigated from 30 MHz to beyond the tenth harmonic of the carrier (up to 10 GHz), no reportable spurious emissions were detected.

## 7. NVLAP Certificate of Accreditation

United States Department of Commerce  
National Institute of Standards and Technology



---

**Certificate of Accreditation to ISO/IEC 17025:2005**

---

NVLAP LAB CODE: 100275-0

**Nokia, Global Product Compliance Lab**  
Murray Hill, NJ

*is accredited by the National Voluntary Laboratory Accreditation Program for specific services,  
listed on the Scope of Accreditation, for:*

**Electromagnetic Compatibility & Telecommunications**

*This laboratory is accredited in accordance with the recognized International Standard ISO/IEC 17025:2005.  
This accreditation demonstrates technical competence for a defined scope and the operation of a laboratory quality  
management system (refer to joint ISO-ILAC-IAF Communique dated January 2009).*

---

2019-09-20 through 2020-09-30  
*Effective Dates*



  
*For the National Voluntary Laboratory Accreditation Program*