

# MST8011 / 8111 SCHEMATIC

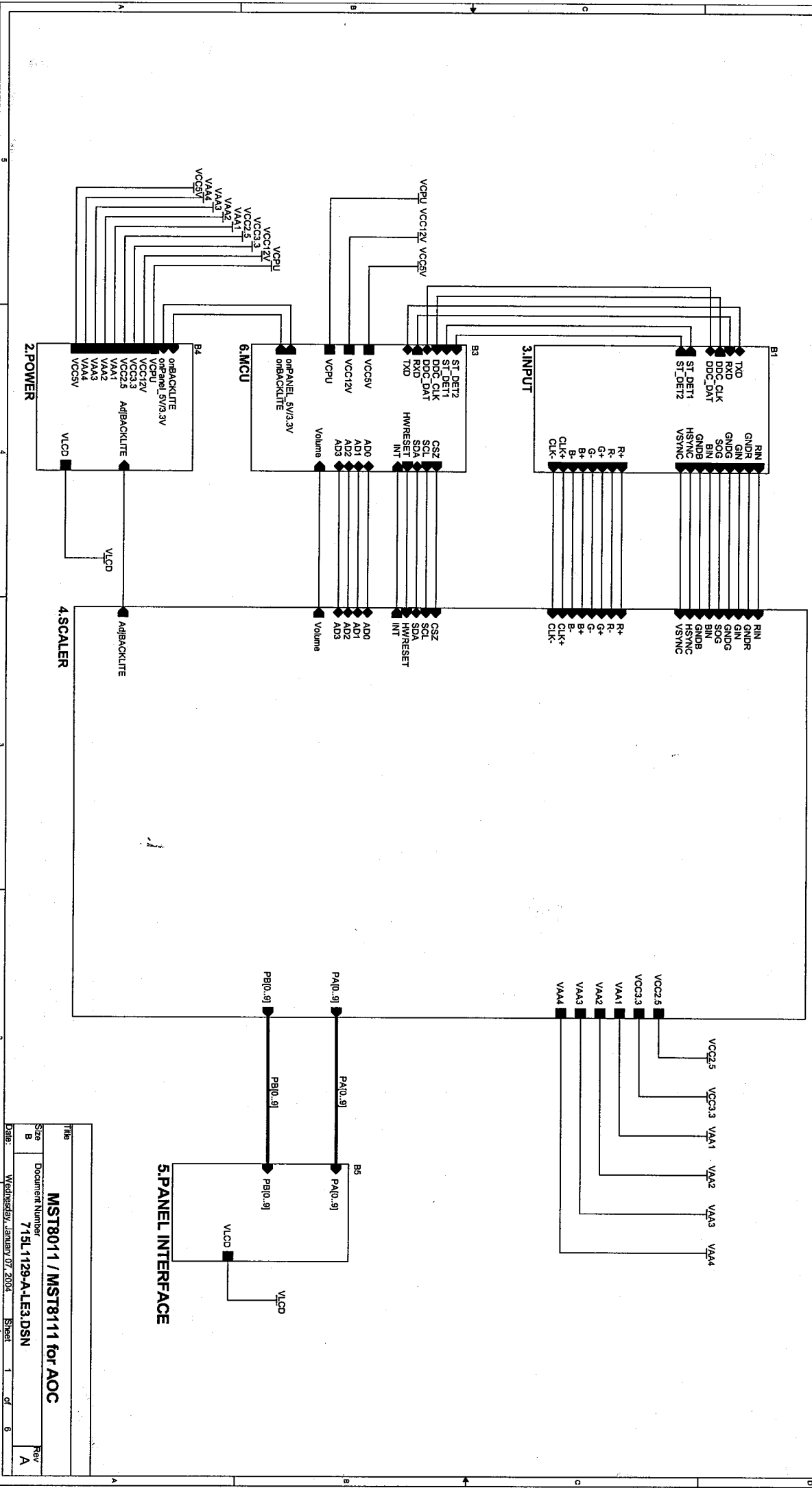

Title		MST8011 / MST8111 for AOC	
Step	Document Number	715L1129-A-LE3.DSN	Rev
B			A
Date	Wednesday, January 07, 2004	Sheet	1 of 6

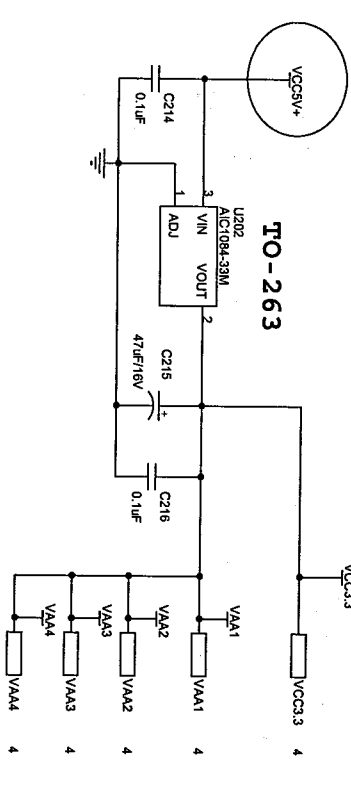
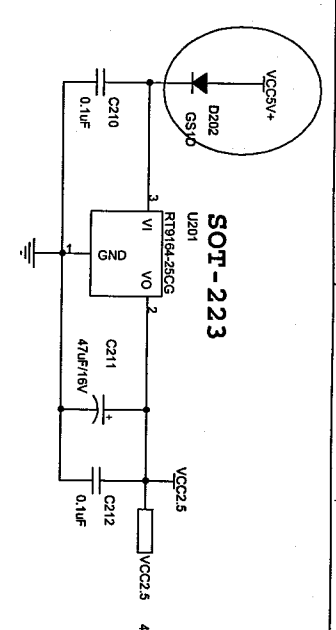
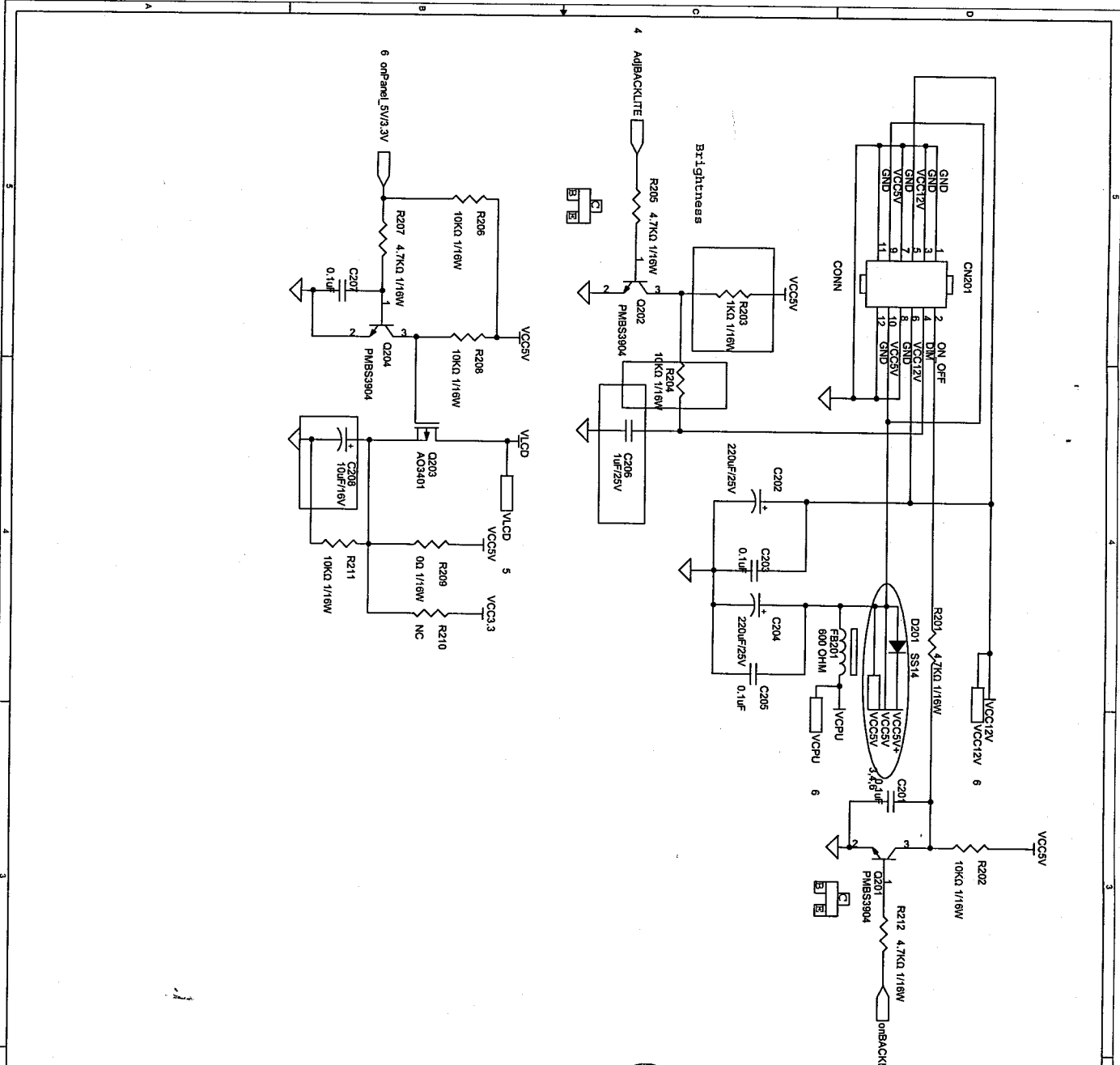

Title		MST8011 / MST8111 for AOC	
Size	Document Number	715L1129-A-LE3.DSN	Rev
B			A
Date:	Wednesday, January 07, 2009	Sheet	2 of 6

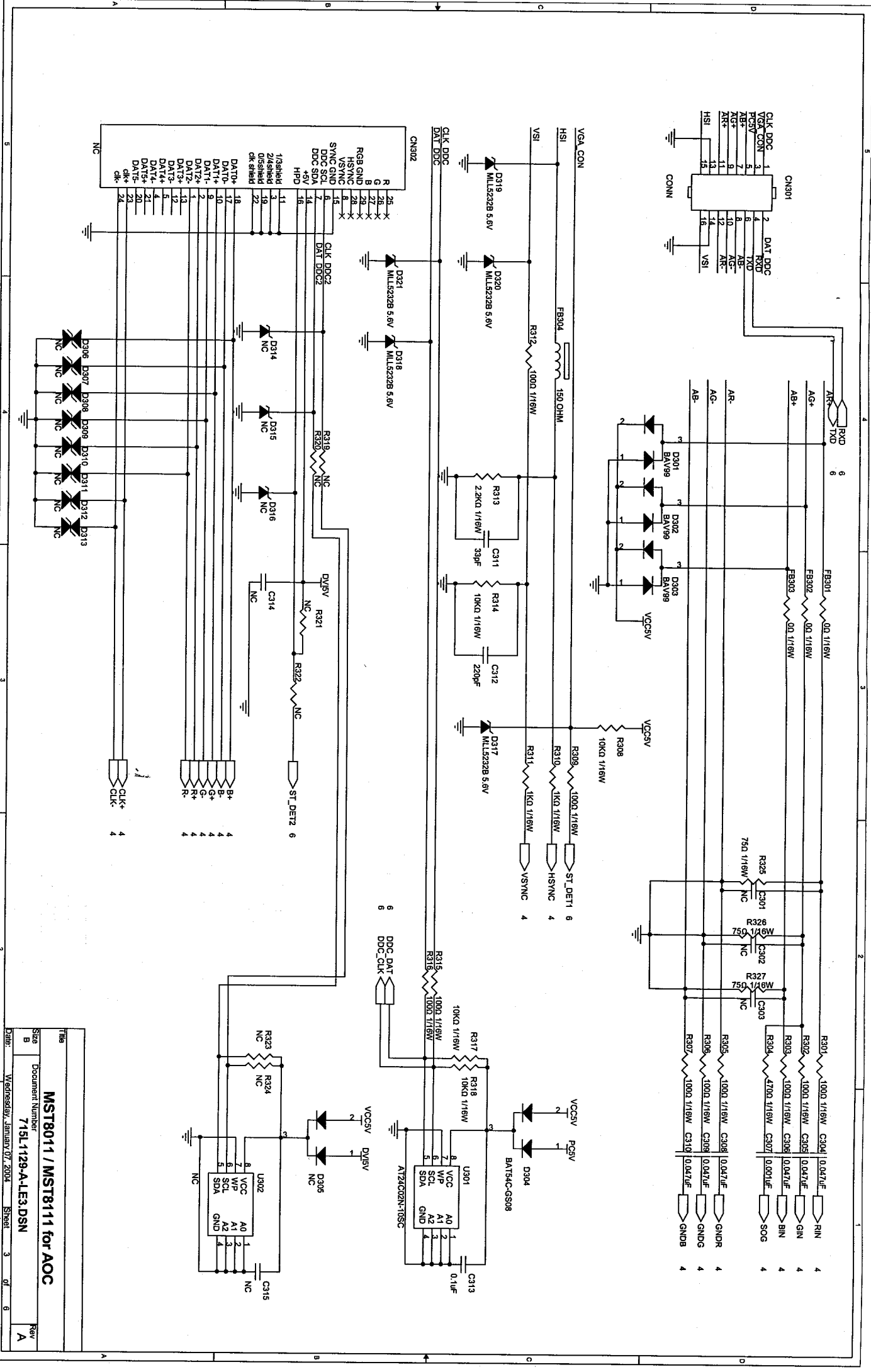

Title		MST8011 / MST8111 for AOC	
Size	Document Number	715L1129-A-LE3.DSN	Rev
B	Widgesteif, lamina, 07.2004	Sheet	3 of 6
			A

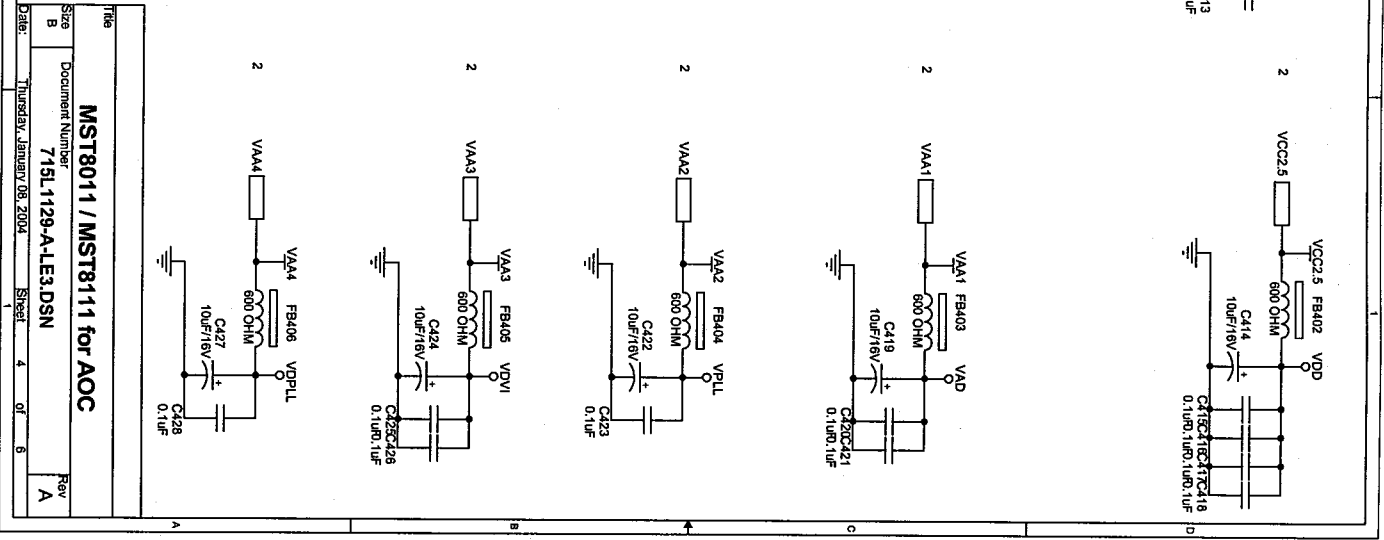
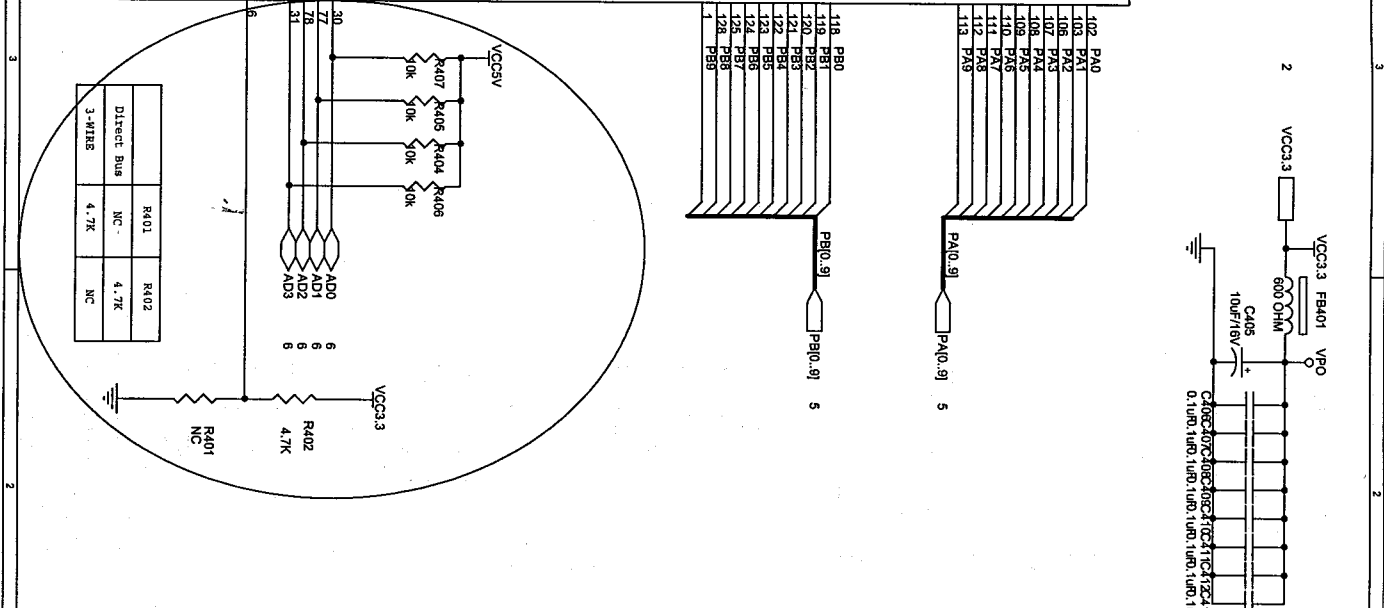
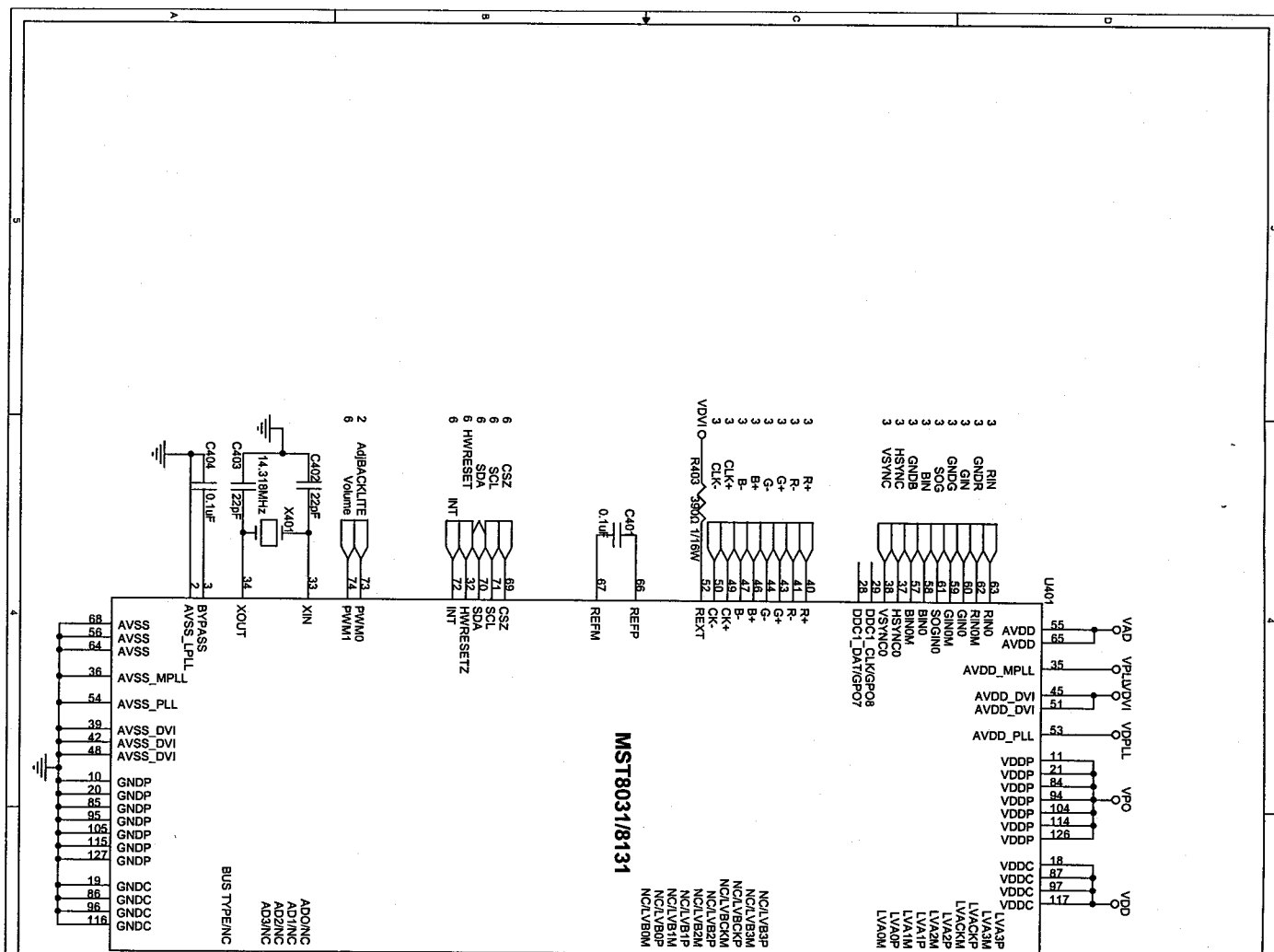

Title: **MST8011 / MST8111 for AOC**  
 Document Number: **715L1129-A-LE3.DSN**  
 Date: **Thursday, January 08, 2004**  
 Sheet: **4** of **6**  
 Rev: **A**

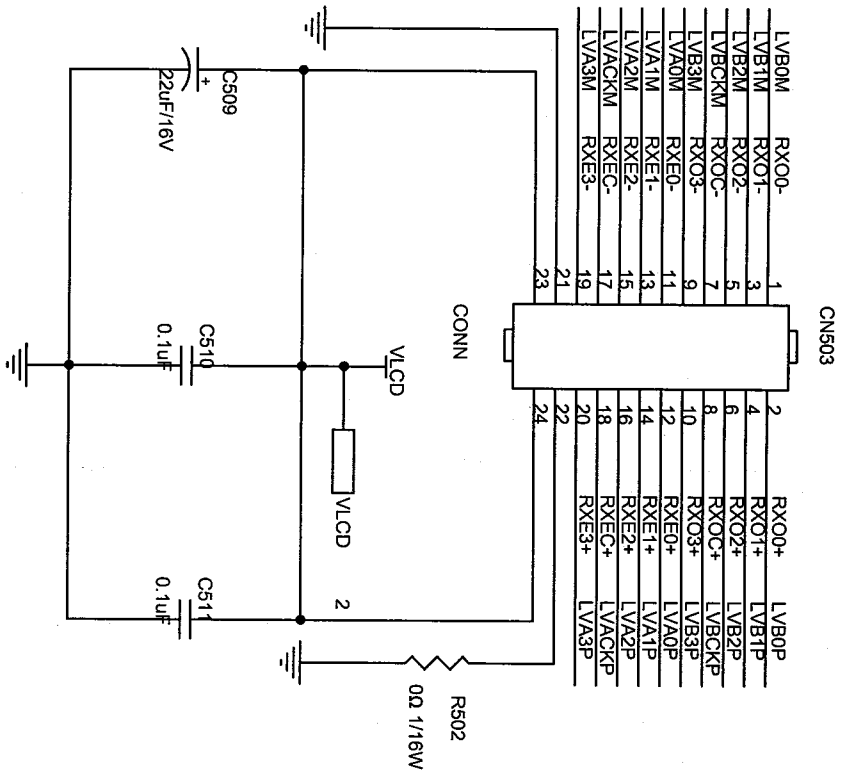
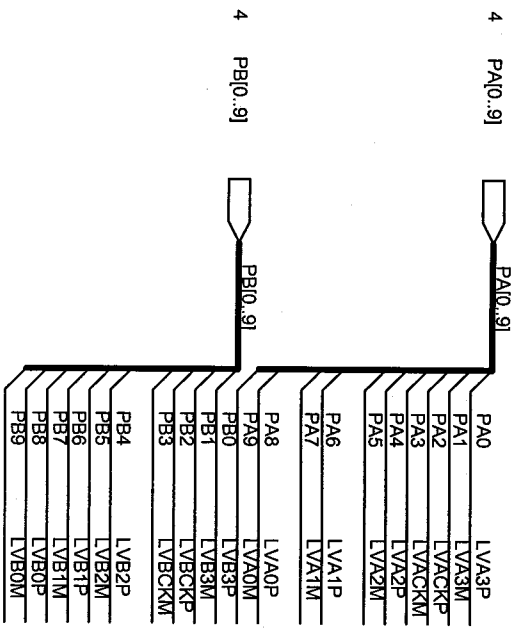

Title		MST8011 / MST8111 for AOC	
Size	Document Number	715L1129-A-LE3.DSN	
A			
Date:	Wednesday, January 07, 2004	Sheet	5 of 6
Rev		A	

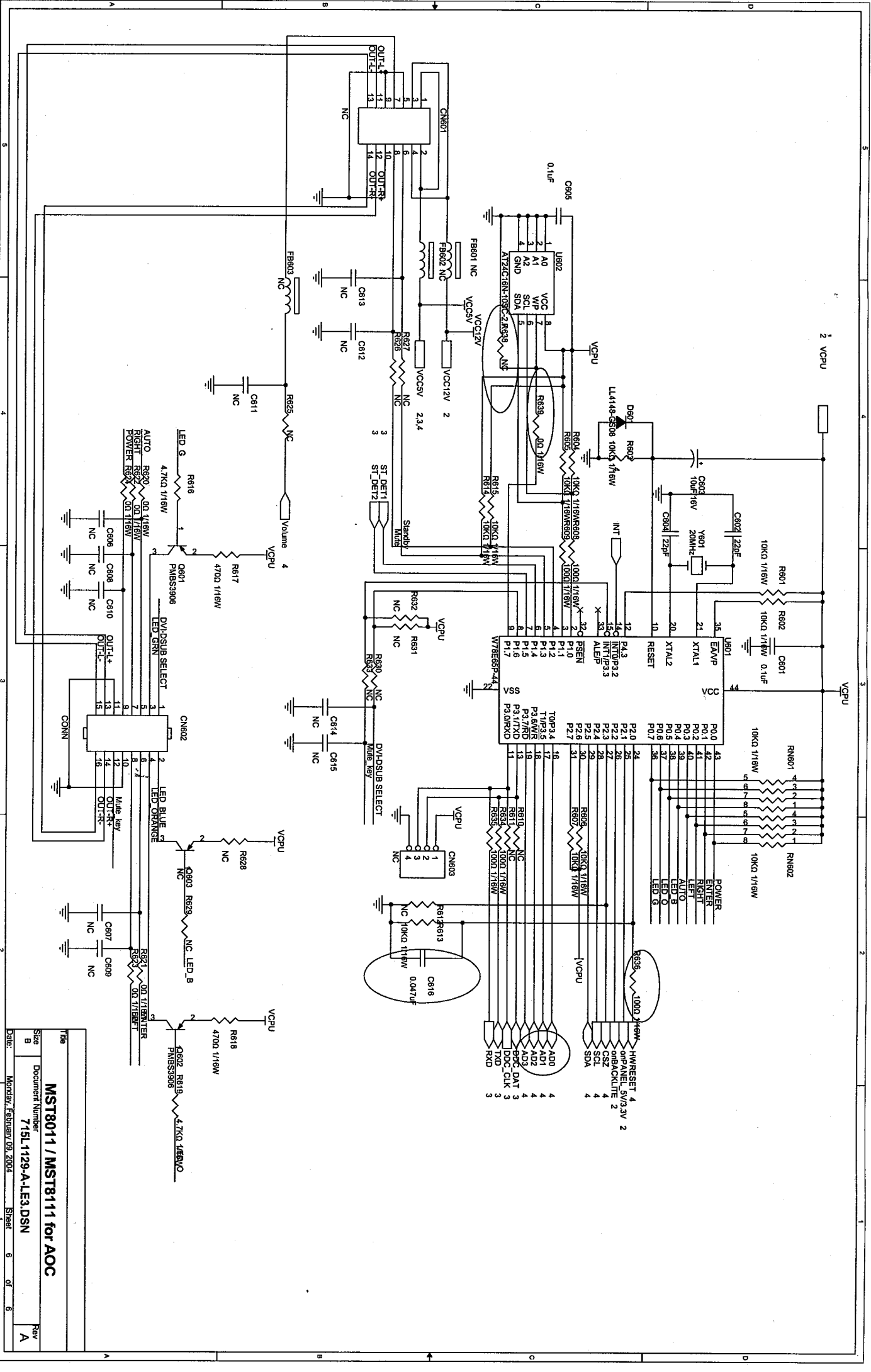

Title: **MST8011 / MST8111 for AOC**  
 Size: Document Number  
 B: 715L1129-A-LE3.DSN  
 Date: Monday, February 09, 2004  
 Sheet: 5 of 6  
 Rev: A

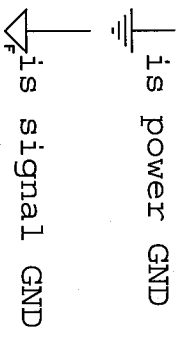
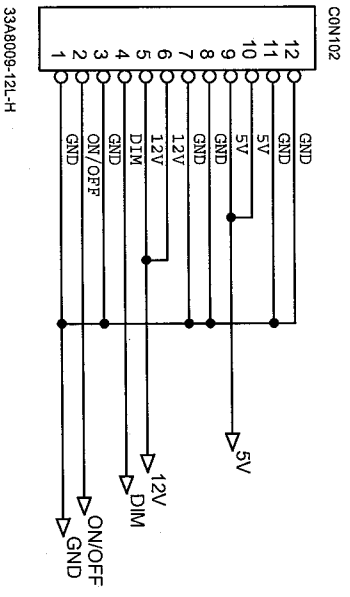
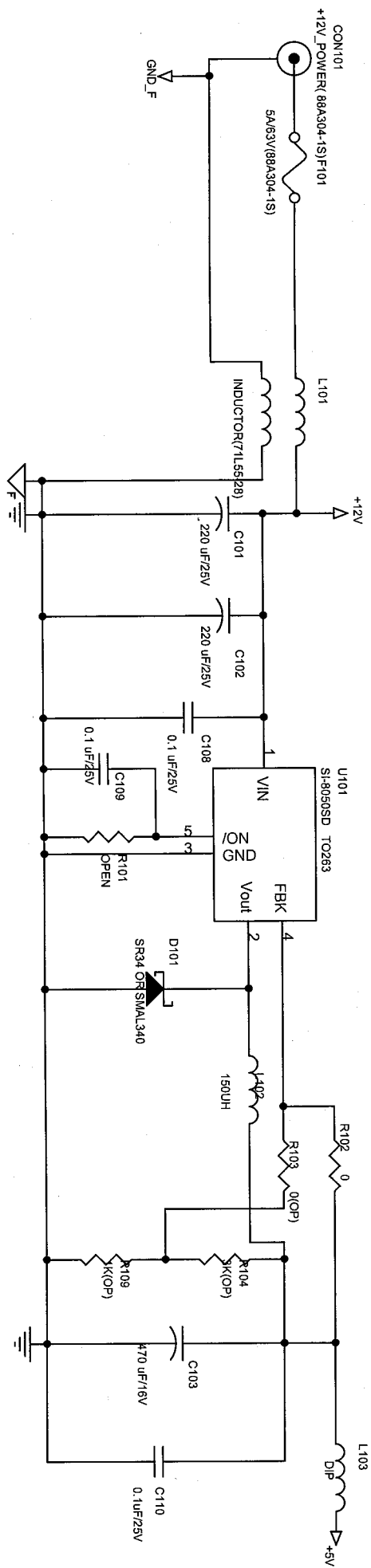

**1. POWER**

Title		<b>A0C (Top Victory) Electronics Co., Ltd.</b>	
Size	Document Number	Rev	
A	IDPC7425D3(715L1085-1)	A	A
Date:	星期三, 八月 27, 2003	Sheet	2 of 1

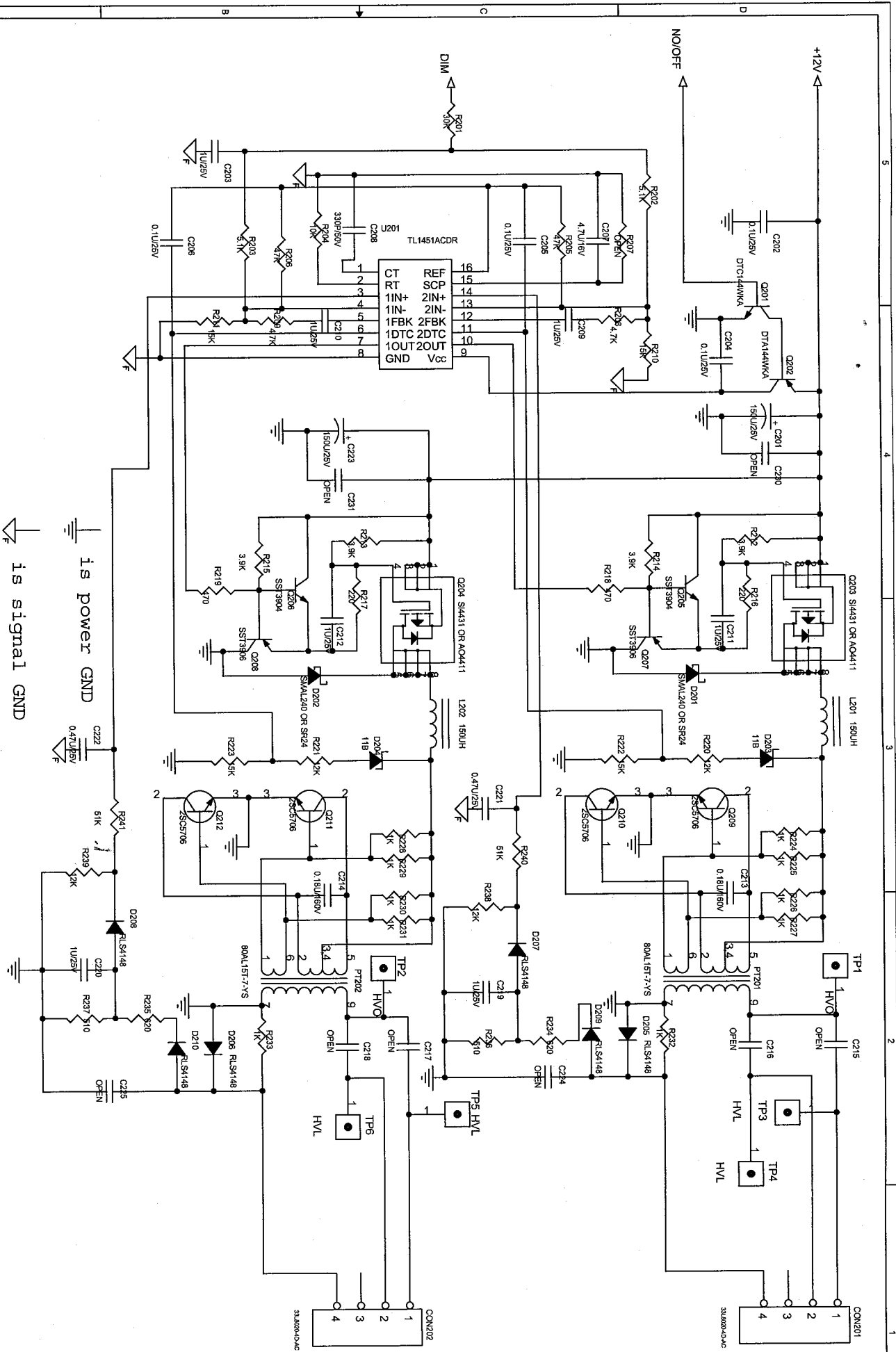

is power GND  
is signal GND

AOC (Top Victory) Electronics Co., Ltd.	
2. FOR 17" & 15" 4 LAMPS INVERTER	
Size	Document Number IDPC7425D3(715L1085-A)
Date:	星期三, 八月 27, 2003
Sheet	2 of 2
Rev	A