

ACSCM569E *Jan 20 2003*

EXHIBIT 4

Test Report

Test Report

ACS-F98019

APPLICATION FOR CERTIFICATION
On Behalf of
Top Victory Electronics (Taiwan) Co., Ltd.
15" Color Monitor

Model : 5GLR⁺

Prepared for : Top Victory Electronics (Taiwan) Co., Ltd.
6F, 168 Lien Chen Rd., Chung-Ho 235,
Taipei Hsien, Taiwan, R. O. C.

Prepared By : Audix Technology (Shenzhen) Co., Ltd.
No. 6 Ke Feng Rd., 52 Block,
Shenzhen Science & Industrial Park,
Nantou, Shenzhen, Guangdong, China

Tel: (0755)663-9495

Report Number : ACS-F98019
Date of Test : Jun. 24 ~ 25, 1998
Date of Report : Jul. 01, 1998

TABLE OF CONTENTS

Description	Page
Test Report Certification	
1. GENERAL INFORMATION.....	1-1
1.1. Description of Device (EUT).....	1-1
1.2. Tested System Details.....	1-1
1.3. Description of Test Facility	1-3
2. POWER LINE CONDUCTED MEASUREMENT	2-1
2.1. Test Equipment	2-1
2.2. Block Diagram of Test Setup.....	2-1
2.3. Conducted Power Line Emission Limit.....	2-2
2.4. EUT Configuration on Measurement.....	2-2
2.5. Operating Condition of EUT.....	2-2
2.6. Test Procedure.....	2-3
2.7. Line Conducted RF Voltage Measurement Results.....	2-4
3. RADIATED EMISSION MEASUREMENT.....	3-1
3.1. Test Equipment	3-1
3.2. Block Diagram of Test Setup.....	3-1
3.3. Radiation Limit.....	3-2
3.4. EUT Configuration on Measurement.....	3-2
3.5. Operating Condition of EUT.....	3-2
3.6. Test Procedure.....	3-3
3.7. Radiated Emission Noise Measurement Results.	3-3
4. PHOTOGRAPH	4-1
4.1. Photos of Power Line Conducted Measurement.....	4-1
4.2. Photos of Radiated Measurement	4-2
4.3. Photos of Power Line Conducted Measurement.....	4-3
4.4. Photos of Radiated Measurement	4-4
 APPENDIX I	 (7 Pages)
APPENDIX II	(13 Pages)

TEST REPORT CERTIFICATION

Applicant : Top Victory Electronics (Taiwan) Co., Ltd.
 Manufacturer : Top Victory Electronics (Fujian) Co., Ltd.
 FCC ID : ARSCM569E
 EUT Description : 15" Color Monitor
 (A) MODEL NO. : 5GLR⁺
 (B) SERIAL NO. : N/A
 (C) POWER SUPPLY : AC 120V/60Hz

Measurement Procedure Used:

FCC Rules and Regulations Part 15 Subpart B Class B August 1997 & FCC / ANSI C63.4-1992

One Model (5GLR⁺) had been chose in the series for EMC Test and the device described above is tested by AUDIX TECHNOLOGY (SHENZHEN) CO., LTD.to determine the maximum emission levels emanating from the device. The maximum emission levels are compared to the FCC Part 15 Subpart Class B limits both radiated and conducted emissions.

The measurement results are contained in this test report and AUDIX TECHNOLOGY (SHENZHEN) CO., LTD. is assumed full responsibility for the accuracy and completeness of these measurements. Also, this report shows that the Equipment Under Test (EUT) is to be technically compliant with the FCC requirements.

This report applies to above tested sample only. This report shall not be reproduced in part without written approval of AUDIX TECHNOLOGY (SHENZHEN) CO., LTD.

Date of Test : Jun. 24 ~ 25, 1998

Prepared by : Mabel Liu 7/3
 (MABEL LIU)

Project Engineer : Martin Lu 7/9
 (MARTIN LU)

Approve & Authorized Signer : Leon Liu July, 10 1998
 (LEON LIU)

1. GENERAL INFORMATION

1.1. Description of Device (EUT)

Description	:	15" Color Monitor
Model Number	:	5GLR+
Applicant	:	Top Victory Electronics (Taiwan) Co., Ltd. 6F, 168 Lien Chen Rd., Chung-Ho 235, Taiwan Hsien, Taiwan, R.O.C.
Manufacturer	:	Top Victory Electronics (Fujian) Co., Ltd. Yuan Hong Rd., Sung-Zhen, Fuqing City, Fujian
CRT	:	Manufacturer: Orion Korea M/N: LR101200 S/N: 1038321162 M36K×0110××51
Data Cable	:	Shielded, Undetachable, 1.5m with ferrite core
Power Cord	:	Unshielded, Detachable, 1.5m
Date of Test	:	Jun. 24 ~ 25, 1998

1.2. Tested System Details

1.2.1. PERSONAL COMPUTER

Model Number	:	IPV3120400
Serial Number	:	N/A
FCC ID	:	EYM410G586IPV
Manufacturer	:	DFI
Switching Power Supply	:	Model DEV200W
Floppy Driver	:	NEC. Model FD1138H
Hard Disk Driver	:	Quantum, Model1700AT
Disk Ctrl Card	:	Within Mother Board
Serial/Parallel Card	:	Within Mother Board
Power Cord	:	Nonshielded, Detachable, 1.8m

1.2.2. VGA CARD (For DFI G586IPV)

Model Number : DSV3365
 Serial Number : E700217416
 FCC ID : LUT-DSV3365
 Manufacturer : Dataexpert Co., Ltd.

1.2.3. KEYBOARD

Model Number : DFK171M
 Serial Number : 43902222
 FCC ID : FBX5E9
 Manufacturer : Datacomp Electronics Co., Ltd.
 Power Cable : Shielded, Undetachable, 1.9m

1.2.4. PRINTER

Model Number : 2225C+
 Serial Number : 2937S56660
 FCC ID : DS16XU2225
 Manufacturer : Hewlett Packard
 Power Adapter : Hewlett Packard, Model 82241A
 Power Cord : Nonshielded, Undetachable, 1.8m
 Data Cable : Shielded, Detachable, 1.5m

1.2.5. MODEM # 1

Model Number : AT-1200CK
 Serial Number : 07-317798
 FCC ID : E205OV1200CK
 Manufacturer : Datatronics Technology, Inc.
 Data Cable : Shielded, Detachable, 1.5m
 Power Adapter : Datatronics, Model 48C
 Power Cord : Nonshielded, Undetachable, 1.5m

1.2.6. MODEM # 2

Model Number : 1200T
 Serial Number : AT 122257
 FCC ID : EF56A5 1200AT
 Manufacturer : Team Technology, Inc.
 Data Cable : Shielded, Detachable, 1.5m
 Power Adapter : Kaming, Model AD-09
 Power Cord : Nonshielded, Undetachable, 1.8m

1.2.7. MOUSE

Model Number : M-S34
 Serial Number : LZA81403347
 FCC ID : DZL211029
 Manufacturer : LOGITECH
 Data Cable : Nonshielded, Undetachable, 2.5m

1.3. Description of Test Facility

Site Description	:	
3m Anechoic Chamber	:	Certificated by FCC, U.S.A. Aug. 18, 1997
3m & 10m Open Site	:	Certificated by FCC, U.S.A. Feb. 13, 1998
EMC Lab.	:	Certificated by TUV Rheinland Taiwan Dec. 05, 1995
		Certificated by COMMERCE, New Zealand May 19, 1997
		Certificated by NEMKO, Norway Feb. 28, 1998
Name of Firm	:	Audix Technology (Shenzhen) Co., Ltd.
Site Location	:	No. 6 Ke Feng Rd., 52 Block, Shenzhen Science & Industrial Park, Nantou, Shenzhen, Guangdong, China

2. POWER LINE CONDUCTED MEASUREMENT

2.1. Test Equipment

The following test equipments are used during the power line conducted measurement:

Item	Type	Manufacturer	Model No.	Serial No.	Last Cal.	Cal. Interval
1.	Test Receiver	Rohde & Schwarz	ESHS20	836600/006	Jun. 07, 98	1 Year
2.	L.I.S.N. # 1	Kyoritsu	KNW-407	8-541-4	Jun. 07, 98	1 Year
3.	L.I.S.N. # 2	EMCO	3825/2	9006-1660	Jun. 07, 98	1 Year
4.	Coaxial Switch	Anritsu	MP59B	M29242	N/A	N/A

2.2. Block Diagram of Test Setup

2.2.1. Power Line Link to L.I.S.N.

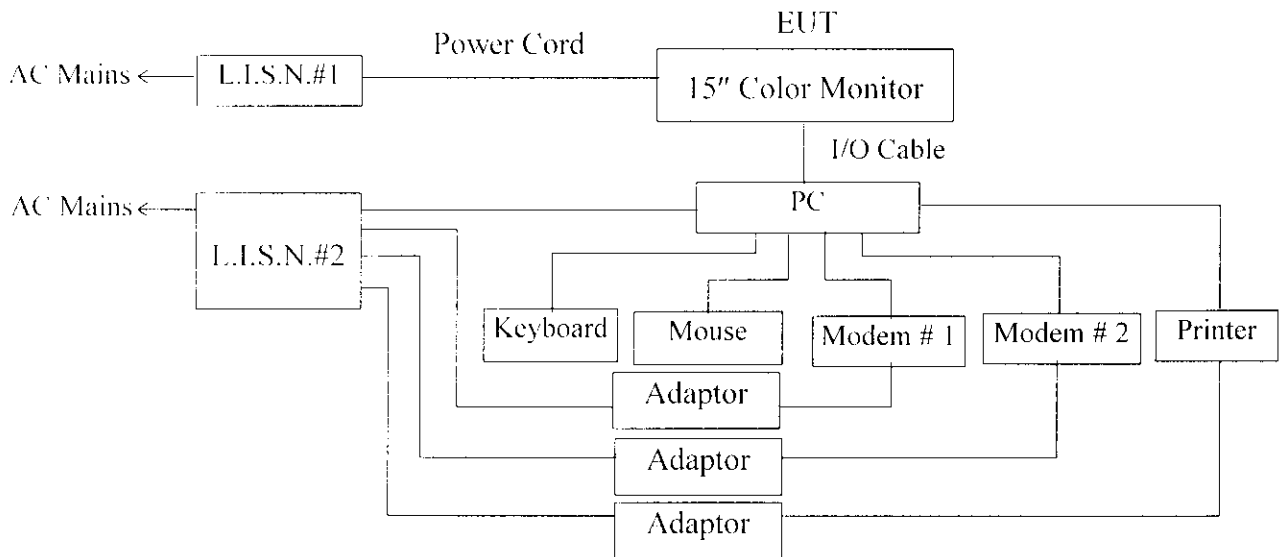

2.2.2. Power Line Link to PC.

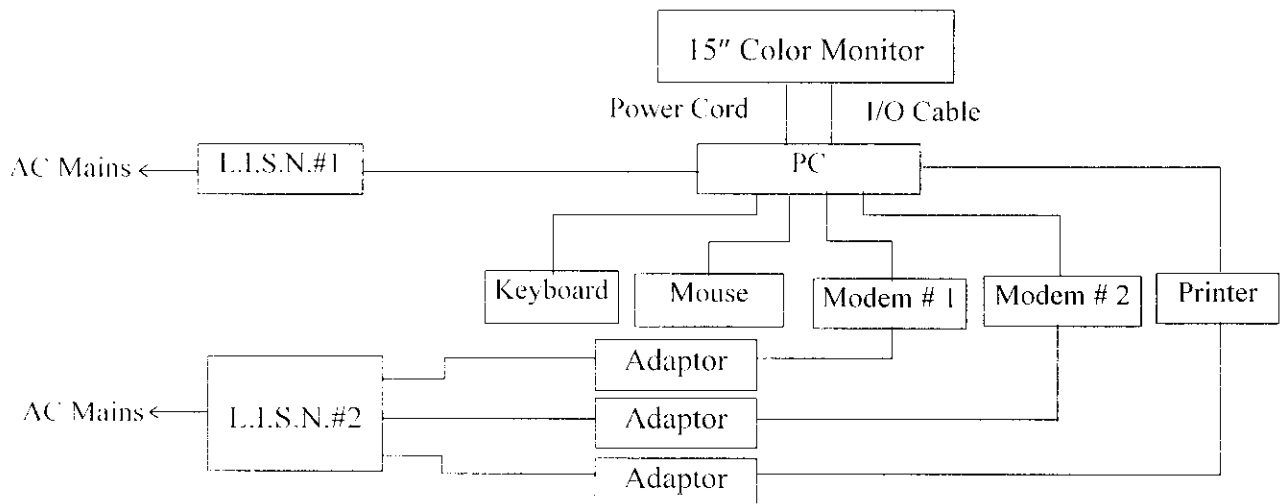

2.3. Conducted Power Line Emission Limit

Frequency MHz	Maximum RF Line Voltage	
	μV	$\text{dB}(\mu\text{V})$
0.45 ~ 30.00	250	48

Remarks: RF LINE VOLTAGE ($\text{dB}(\mu\text{V})$) = $20 \log \text{RF LINE VOLTAGE } (\mu\text{V})$

2.4. EUT Configuration on Measurement

The following equipments are installed on RF LINE VOLTAGE measurement to meet the Commission requirement and operating regulations in a manner which tends to maximize its emission characteristics in a normal application.

2.4.1. Monitor (EUT)

Model Number : 5GLR⁺
 Serial Number : N/A
 FCC ID : ARSCM569E
 Manufacturer : Top Victory Electronics (Fujian) Co., Ltd.
 CRT : Manufacturer: Orion Korea
 M/N: LR101200
 S/N: 1038321162 M36K×0110××51
 Data Cable : Shielded, Undetachable, 1.5m
 with ferrite core
 Power Cord : Unshielded, Detachable, 1.5m

2.4.2. Support Equipments

As in Section 1.2. Test System Details

2.5. Operating Condition of EUT

2.5.1. Setup the EUT and simulator as shown on Section 2.2.

2.5.2. Turn on the power of all equipments.

2.5.3. Personal Computer reads data from disk.

2.5.4. Personal Computer sends "H" character to monitor (EUT) and the screen will display and full with "H" pattern.

2.5.5. Personal Computer reads "H" character to printer, the printer will print "H" pattern on paper.

2.5.6. Personal Computer reads data from floppy disk and then writes data into floppy disk.

2.5.7. Personal Computer reads data from modem.

2.6. Test Procedure

The EUT is put on table which is 0.8m above the ground and away from other metallic surface at least 0.4m. The EUT is connected to the power mains through a line impedance stabilization network (L.I.S.N.). This provides a 50 ohm coupling impedance for the testing equipments. Please reference the block diagram of the test setup and photographs. Both sides of AC line(Line & Neutral) are checked for maximum conducted interference. In order to find the maximum emission levels, the relative positions of equipments and all of the interface cables must be changed according to FCC ANSI C63.4-1992 on conducted measurement.

The bandwidth of the field strength meter (R & S Test Receiver ESHS20) is set at 10KHz.

The frequency range from 450KHz to 30MHz is checked.

Three kinds of horizontal working frequency are investigated during pre-scanning and are reported in Section 2.7.. Please reference to Appendix I.

The details of test modes are the followings:

- (1) 31.5KHz/640*480 Power Line Link to L.I.S.N
- (2) 53.67KHz/800*600 Power Line Link to L.I.S.N
- (3) 68.6KHz/1024*768 Power Line Link to L.I.S.N
- (4) 31.5KHz/640*480 Power Line Link to PC
- (5) 53.67KHz/800*600 Power Line Link to PC
- (6) 68.6KHz/1024*768 Power Line Link to PC

2.7. Line Conducted RF Voltage Measurement Results

PASS.

The frequency range from 450KHz to 30 MHz is investigated.

All emissions not reported below are too low against the prescribed limits.

Date of Test : Jun. 25, 1998 Temperature : 25 °CEUT : 15" Color Monitor Humidity : 55 %Model No. : 5GLR+ Working Condition : 31.5KHz/640*480
Power Line Link to L.I.S.N

Frequency MHz	Reading		Limit dB(μ V)
	Phase VA dB(μ V)	Phase VB dB(μ V)	
0.472	*	29.6	48.0
0.660	29.4	*	48.0
3.600	36.5	*	48.0
3.890	*	36.5	48.0
8.990	36.1	*	48.0
18.800	28.8	29.1	48.0

- Remark :
1. All readings are Quasi-Peak values.
 2. The worst emission is detected at 3.600 and 3.890 MHz with corrected signal level of 36.5 dB(μ V) (limit is 48 dB(μ V)) when the VA , VB side of the EUT is connected to L.I.S.N.

Date of Test : Jun. 25, 1998 Temperature : 25 °C
 EUT : 15" Color Monitor Humidity : 55 %
 Model No. : 5GLR⁺ Working Condition : 53.67KHz/800*600
Power Line Link to L.I.S.N

Frequency MHz	Reading		Limit dB(μV)
	Phase VA dB(μV)	Phase VB dB(μV)	
0.487	*	31.7	48.0
0.703	33.1	*	48.0
3.780	41.0	*	48.0
3.890	*	40.5	48.0
5.610	*	27.0	48.0
9.280	32.3	*	48.0

Remark : 1. All readings are Quasi-Peak values.
 2. The worst emission is detected at 3.780 MHz with corrected signal level of 41.0 dB(μV) (limit is 48 dB(μV)) when the VA side of the EUT is connected to L.I.S.N.

Date of Test : Jun. 25, 1998 Temperature : 25 °C
 EUT : 15" Color Monitor Humidity : 55 %
 Model No. : 5GLR⁺ Working Condition : 68.6KHz/1024*768
Power Line Link to L.I.S.N

Frequency MHz	Reading		Limit dB(μV)
	Phase VA dB(μV)	Phase VB dB(μV)	
0.618	*	32.0	48.0
0.619	33.3	*	48.0
1.650	*	35.5	48.0
2.130	35.5	*	48.0
3.780	42.7	*	48.0
3.990	*	42.5	48.0
7.080	*	31.9	48.0
9.140	38.2	*	48.0

Remark : 1. All readings are Quasi-Peak values.
 2. The worst emission is detected at 3.780 MHz with corrected signal level of 42.7 dB(μV) (limit is 48 dB(μV)) when the VA side of the EUT is connected to L.I.S.N.

Date of Test : Jun. 25, 1998 Temperature : 25 °CEUT : 15" Color Monitor Humidity : 55 %Model No. : 5GLR+ Working Condition : 31.5KHz/640*480
Power Line Link to PC

Frequency MHz	Reading		Limit dB(μV)
	Phase VA dB(μV)	Phase VB dB(μV)	
0.476	12.8	*	48.0
0.503	*	10.6	48.0
13.930	*	19.4	48.0
14.000	24.9	*	48.0
18.800	28.4	29.1	48.0

- Remark : 1. All readings are Quasi-Peak values.
2. The worst emission is detected at 18.800 MHz with corrected signal level of 29.1 dB(μV) (limit is 48 dB(μV)) when the VB side of the EUT is connected to L.I.S.N.

Date of Test : Jun. 25, 1998 Temperature : 25 °CEUT : 15" Color Monitor Humidity : 55 %Model No. : 5GLR+ Working Condition : 53.67KHz/800*600
Power Line Link to PC

Frequency MHz	Reading		Limit dB(μV)
	Phase VA dB(μV)	Phase VB dB(μV)	
0.511	*	12.8	48.0
0.590	5.3	*	48.0
8.640	23.1	*	48.0
13.930	32.4	*	48.0
14.000	*	24.9	48.0
20.570	*	24.4	48.0
29.500	27.4	26.6	48.0

- Remark : 1. All readings are Quasi-Peak values.
2. The worst emission is detected at 13.930 MHz with corrected signal level of 32.4 dB(μV) (limit is 48 dB(μV)) when the VA side of the EUT is connected to L.I.S.N.

Date of Test : Jun. 25, 1998 Temperature : 25 °C
 EUT : 15" Color Monitor Humidity : 55 %
 Model No. : 5GLR+ Working Condition : 68.6KHz/1024*768
Power Line Link to PC

Frequency MHz	Reading		Limit dB(μV)
	Phase VA dB(μV)	Phase VB dB(μV)	
8.100	22.4	22.2	48.0
14.700	32.9	32.9	48.0
29.900	30.2	29.8	48.0

- Remark : 1. All readings are Quasi-Peak values.
 2. The worst emission is detected at 14.700 MHz with corrected signal level of 32.9 dB(μV) (limit is 48 dB(μV)) when the EUT is connected to L.I.S.N.

3. RADIATED EMISSION MEASUREMENT

3.1. Test Equipment

The following test equipments are used during the radiated emission measurement:

3.1.1. In Chamber # 3

Item	Equipment	Manufacturer	Model No.	Serial No.	Last Cal.	Cal. Interval
1.	EMI Test Receiver	HP	85422E	3625A00181	Jun. 07, 98	1 Year
2.	Amplifier	HP	8447D	2944A07794	Jun. 07, 98	1/2 Year
3.	Bilog Antenna	Chase	CBI.6112A	2176	Sep. 26, 97	1 Year
4.	Computer	N/A	N/A	N/A	N/A	N/A
5.	Printer	NEC	P3800	568101448	N/A	N/A

3.2. Block Diagram of Test Setup

3.2.1. Power Line Link to AC Mains

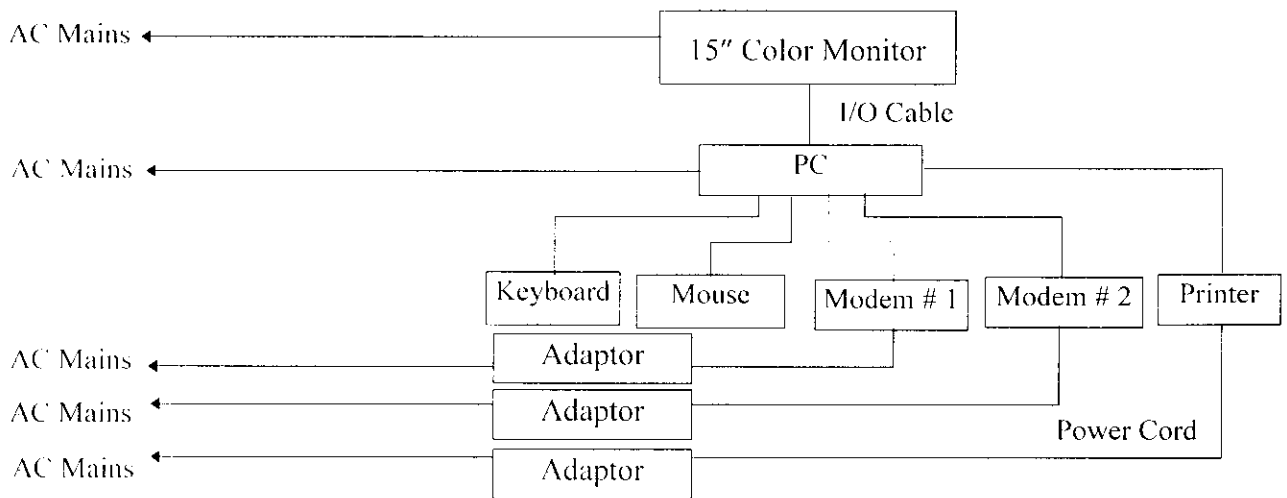

3.2.2. Power Line Link to PC

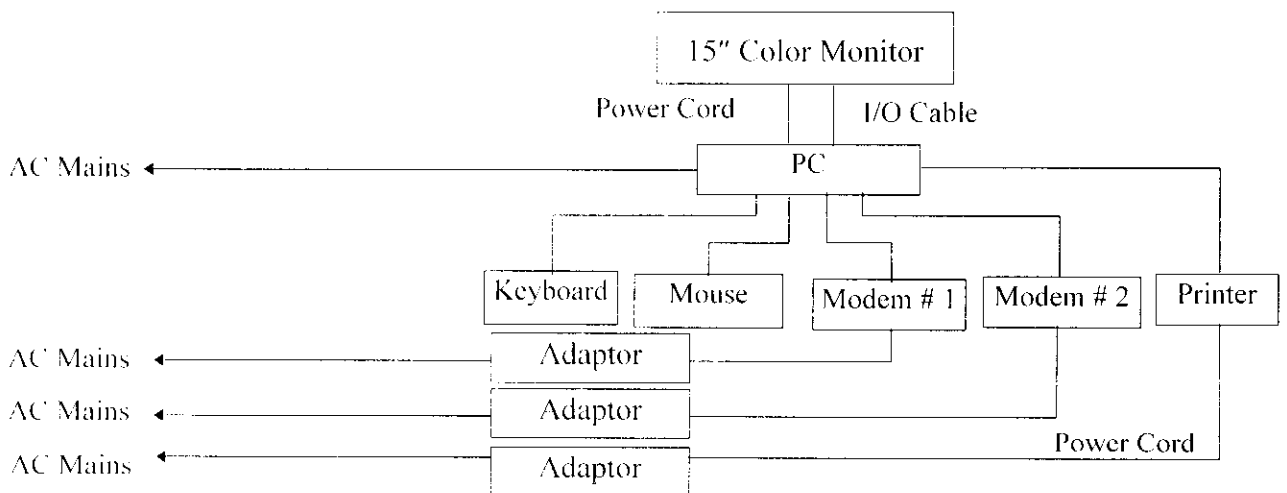

3.2.3. Chamber # 3 Test Setup Diagram

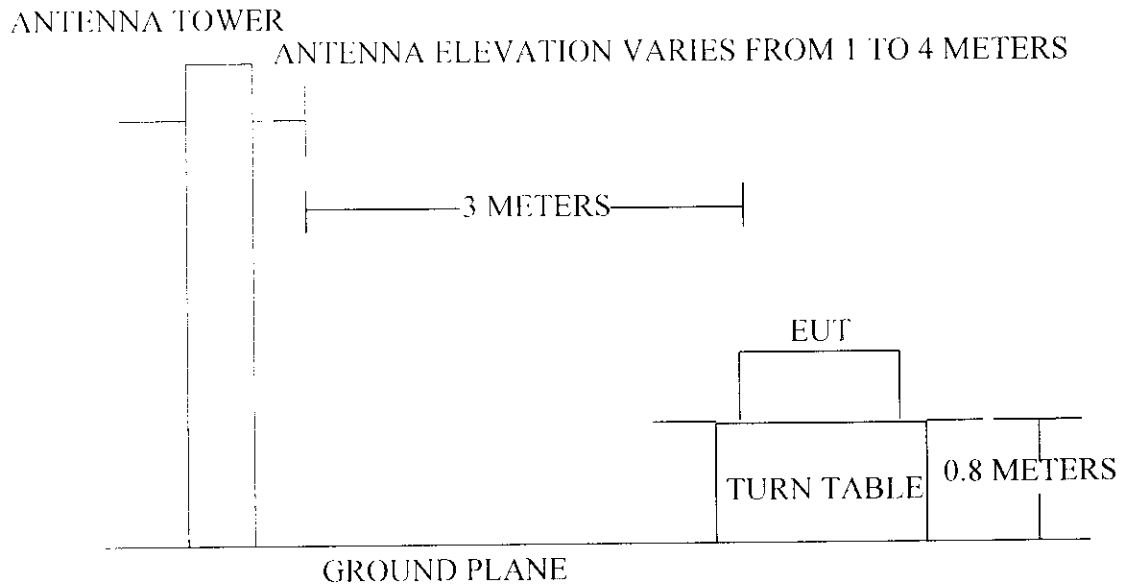

3.3. Radiation Limit

FREQUENCY MHz	DISTANCE Meters	FIELD STRENGTHS LIMITS dB(μV)/m
30 ~ 88	3	40.0
88 ~ 216	3	43.5
216 ~ 960	3	46.0
960 ~ 1000	3	54.0

- Remark :
- (1) Emission level (dB(μV)/m) = 20 log Emission level (μV/m)
 - (2) The smaller limit shall apply at the cross point between two frequency bands.
 - (3) Distance refers to the distance in meters between the measuring instrument, antenna and the closed point of any part of the device or system.

3.4. EUT Configuration on Measurement

The configuration of EUT and its simulators are same as those used in conducted measurement. Please refer to Section 2.4.

3.5. Operating Condition of EUT

Same as conducted measurement which is listed in Section 2.5.

3.6. Test Procedure

The EUT and its simulators are placed on a turn table which is 0.8 meter above ground. The turn table can rotate 360 degrees to determine the position of the maximum emission level. The EUT is set 3 meters away from the receiving antenna which is mounted on a antenna tower. The antenna can move up and down between 1 meter and 4 meters to find out the maximum emission level. Broadband antenna (calibrated biconical and log periodical antenna) and dipole antenna are used as receiving antenna. Both horizontal and vertical polarization of the antenna are set on measurement. In order to find the maximum emission levels, all of the interface cables must be manipulated according to ANSI C63.4-1992 on radiated emission measurement.

The bandwidth setting on the field strength meter (R & S Test Receiver ESVS 20) is set at 120KHz.

The frequency range from 30MHz to 1000MHz is checked.

The following two test modes are measured in Chamber # 3, all the test results are listed in Section 3.7, and all the scanning waveform are attached within Appendix II, which include:

- (1) 31.5KHz/640*480 Power Line link to AC Mains
- (2) 53.67KHz/800*600 Power Line Link to AC Mains
- (3) 68.6KHZ/1024*768 Power Line Link to AC Mains
- (4) 31.5KHz/640*480 Power Line Link to PC
- (5) 53.67KHz/800*600 Power Line Link to PC
- (6) 68.6KHz/1024*768 Power Line Link to PC

We chosen the worst case (Power Line Link to AC Mains) check the Qusi-peak value in 3# Chamber and all the test results are listed in Section 3.7.

3.7. Radiated Emission Noise Measurement Results.

PASS.

The frequency range from 30MHz to 1000MHz is investigated. All the emission levels not reported below are too low against the Limit.

Please see the attached pages.

Date of Test : Jun. 24, 1998 Temperature : 25 °C
 EUT : 15" Color Monitor Humidity : 55%
 Model No. : 5GLR+ Test Site : 3# Chamber
 Working Frequency : 31.5KHz Display Pattern : 31.5KHz / 640*480
 Power Line Link to AC Mains

Frequency MHz	Antenna Factor dB	Cable Loss dB	Meter Reading Horizontal dB	Emission Level Horizontal dBµV/m	Limits dBµV/m	Limits Over dBµV/m
34.560	16.92	0.98	5.60	23.50	40.00	-16.50
66.840	5.56	1.43	19.40	26.39	40.00	-13.61
92.300	10.08	1.69	10.40	22.17	43.50	-21.33
182.620	89.87	2.41	14.60	26.88	43.50	-16.62
216.080	9.67	2.66	14.50	26.83	46.00	-19.17
300.860	13.59	3.19	12.60	29.38	46.00	-16.62
365.664	16.11	3.55	20.90	40.56	46.00	-5.44
644.378	18.91	4.79	14.30	37.99	46.00	-8.01
673.022	18.69	5.07	17.40	41.16	46.00	-4.84
687.353	18.90	5.00	16.80	40.70	46.00	-5.30
831.053	20.53	5.64	8.90	35.07	46.00	-10.93

Calculation: Emission Level = Antenna Factor + Cable Loss + Meter Reading

Date of Test : Jun. 24, 1998 Temperature : 25 °C
 EUT : 15" Color Monitor Humidity : 55%
 Model No. : 5GLR+ Test Site : 3# Chamber
 Working Frequency : 31.5KHz Display Pattern : 31.5KHz / 640*480
 Power Line Link to AC Mains

Frequency MHz	Antenna Factor dB	Cable Loss dB	Meter Reading Vertical dB	Emission Level Vertical dBµV/m	Limits dBµV/m	Limits Over dBµV/m
37.250	10.34	1.02	7.30	18.65	40.00	-21.35
67.370	7.04	1.43	13.50	21.98	40.00	-18.02
124.348	12.69	1.95	11.60	26.24	43.00	-17.26
182.651	8.71	2.41	14.80	25.92	43.00	-17.58
216.040	8.81	2.66	12.60	24.07	46.00	-21.93
300.078	13.76	3.19	11.60	28.55	46.00	-17.45
365.664	15.27	3.55	15.80	34.62	46.00	-11.38
644.378	18.83	4.79	16.20	39.81	46.00	-6.19
673.000	19.06	5.07	14.60	38.73	46.00	-7.27
687.336	19.04	5.00	13.40	37.44	46.00	-8.56

Calculation: Emission Level = Antenna Factor + Cable Loss + Meter Reading

Date of Test : Jun. 24, 1998 Temperature : 25 °C
 EUT : 15" Color Monitor Humidity : 55%
 Model No. : 5GLR+ Test Site : 3# Chamber
 Working Frequency : 53.67KHz Display Pattern : 53.67KHz / 800*600
 Power Line Link to AC Mains

Frequency MHz	Antenna Factor dB	Cable Loss dB	Meter Reading Horizontal dB	Emission Level Horizontal dBµV/m	Limits dBµV/m	Limits Over dBµV/m
48.600	8.00	1.18	9.80	18.98	40.00	-21.02
65.780	5.46	1.41	12.20	19.06	40.00	-20.94
90.840	9.62	1.67	10.40	21.69	43.00	-21.81
182.640	9.87	2.41	14.30	26.58	43.00	-16.92
216.076	9.67	2.66	14.80	27.13	46.00	-18.87
300.848	13.59	3.19	15.30	32.08	46.00	-13.92
365.665	16.11	3.55	21.40	41.06	46.00	-4.94
644.380	18.91	4.79	13.50	37.19	46.00	-8.81
673.023	18.69	5.07	17.50	41.26	46.00	-4.74
687.353	18.90	5.00	15.90	39.80	46.00	-6.20
831.052	20.53	5.64	9.80	35.97	46.00	-10.03

Calculation: Emission Level = Antenna Factor + Cable Loss + Meter Reading

Date of Test : Jun. 24, 1998 Temperature : 25 °C
 EUT : 15" Color Monitor Humidity : 55%
 Model No. : 5GLR+ Test Site : 3# Chamber
 Working Frequency : 53.67KHz Display Pattern : 53.67KHz / 800*600
 Power Line Link to AC Mains

Frequency MHz	Antenna Factor dB	Cable Loss dB	Meter Reading Vertical dB	Emission Level Vertical dBµV/m	Limits dBµV/m	Limits Over dBµV/m
35.640	10.83	0.99	7.30	19.12	40.00	-20.88
65.520	6.65	1.41	13.40	21.45	40.00	-18.55
89.260	9.94	1.66	12.30	23.90	43.00	-19.60
182.654	8.71	2.41	16.50	27.62	43.00	-15.88
216.046	8.81	2.66	12.80	24.27	46.00	-21.73
300.079	13.76	3.19	9.60	26.55	46.00	-19.45
365.670	15.27	3.55	15.10	33.92	46.00	-12.08
615.743	17.68	4.71	16.30	38.69	46.00	-7.31
673.020	19.06	5.07	14.10	38.23	46.00	-7.77
687.340	19.04	5.00	13.60	37.64	46.00	-8.36

Calculation: Emission Level = Antenna Factor + Cable Loss + Meter Reading

Date of Test : Jun. 24, 1998 Temperature : 25 °C
 EUT : 15" Color Monitor Humidity : 55%
 Model No. : 5GLR+ Test Site : 3# Chamber
 Working Frequency : 68.6KHz Display Pattern : 68.6KHz / 1024*768
 Power Line Link to AC Mains

Frequency MHz	Antenna Factor dB	Cable Loss dB	Meter Reading Horizontal dB	Emission Level Horizontal dBµV/m	Limits dBµV/m	Limits Over dBµV/m
48.200	8.23	1.18	10.30	19.71	40.00	-20.29
65.900	5.48	1.41	12.30	19.19	40.00	-20.81
91.200	9.80	1.68	9.30	20.78	43.00	-22.72
182.640	9.87	2.41	13.60	25.88	43.000	-17.62
216.078	9.67	2.66	15.90	28.23	46.00	-17.77
300.850	13.59	3.19	14.50	31.28	46.00	-14.72
365.663	16.11	3.55	21.60	41.26	46.00	-4.74
644.380	18.91	4.79	13.20	36.89	46.00	-9.11
673.023	18.69	5.07	17.90	41.66	46.00	-4.34
687.353	18.90	5.00	16.60	40.50	46.00	-5.50
831.053	20.53	5.64	9.60	35.77	46.00	-10.23

Calculation: Emission Level = Antenna Factor + Cable Loss + Meter Reading

Date of Test : Jun. 24, 1998 Temperature : 25 °C
 EUT : 15" Color Monitor Humidity : 55%
 Model No. : 5GLR+ Test Site : 3# Chamber
 Working Frequency : 68.6KHz Display Pattern : 68.6KHz / 1024*768
 Power Line Link to AC Mains

Frequency MHz	Antenna Factor dB	Cable Loss dB	Meter Reading Vertical dB	Emission Level Vertical dBµV/m	Limits dBµV/m	Limits Over dBµV/m
35.430	10.91	0.99	6.80	18.70	40.00	-21.30
64.680	6.50	1.40	12.60	20.50	40.00	-19.50
88.180	9.68	1.66	11.80	23.14	43.00	-20.36
182.653	8.71	2.41	15.60	26.72	43.00	-16.78
216.050	8.81	2.66	11.60	23.07	46.00	-22.93
300.800	13.80	3.19	10.80	27.79	46.00	-18.21
365.668	15.27	3.55	14.30	33.12	46.00	-12.88
615.745	17.68	4.71	16.70	39.09	46.00	-6.91
673.018	19.06	5.07	13.80	37.93	46.00	-8.07
687.338	19.04	5.00	12.90	36.94	46.00	-9.06

Calculation: Emission Level = Antenna Factor + Cable Loss + Meter Reading

FCW/RELEAS

JUL 20 1998

APPENDIX I

Conduction Test FCC Class B

25. Jun 98 10:10

EUT: Color Monitor M/N:5GLR+
Manuf: AOC
Op Cond: 640*480 31.5KHz (Line to PC)
Operator: Houny
Test Spec: Va 120V/60Hz
Comment: Temp:26°C
Humi:61%

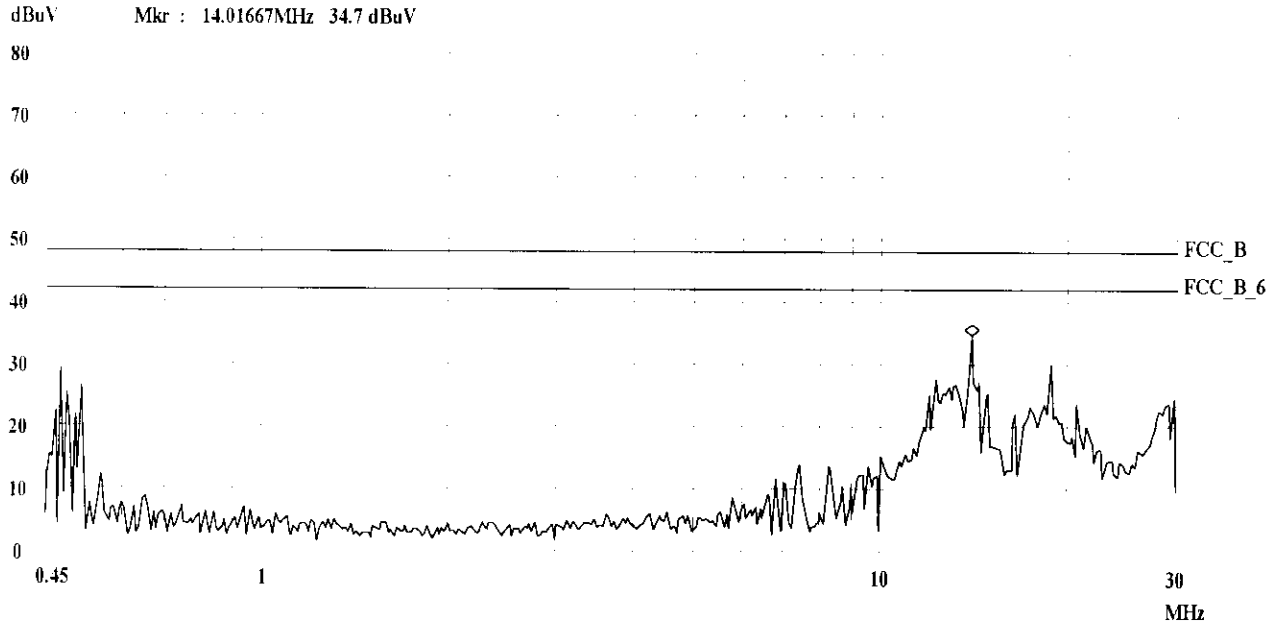

Conduction Test FCC Class B

25. Jun 98 10:17

EUT: Color Monitor M/N:5GLR+
Manuf: AOC
Op Cond: 640*480 31.5KHz (Line to PC)
Operator: Houny
Test Spec: Vb 120V/60Hz
Comment: Temp:26°C
Humi:61%

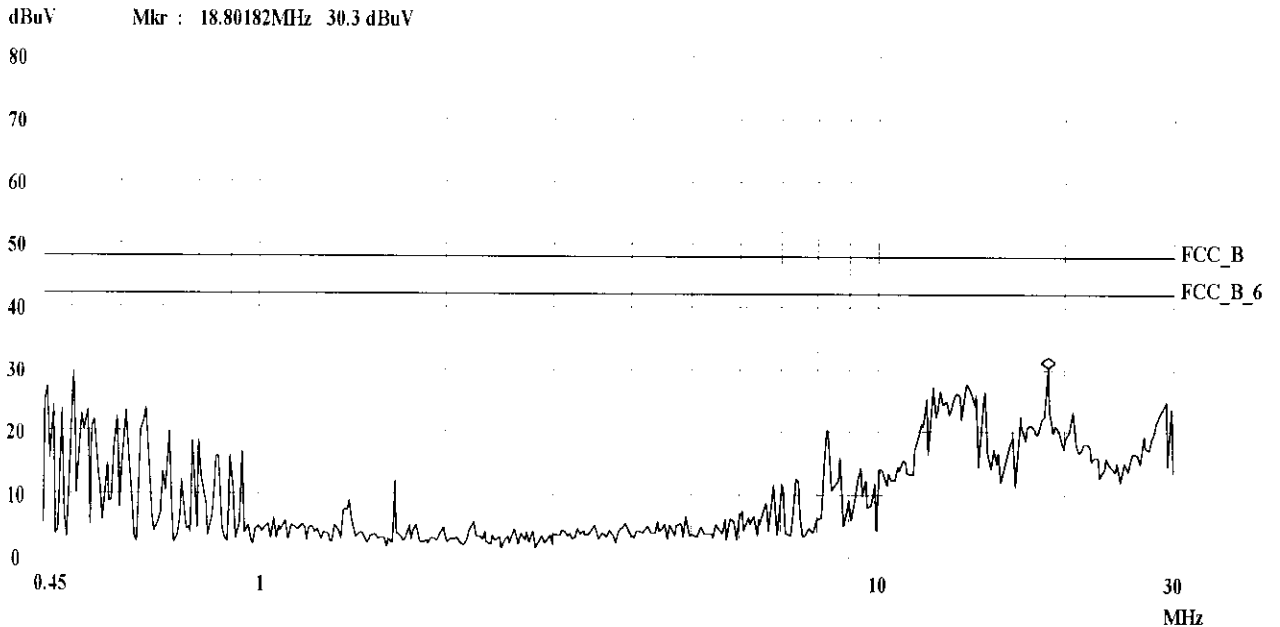

Conduction Test FCC Class B

25. Jun 98 10:26

EUT: Color Monitor M/N:5GLR+
Manuf: AOC
Op Cond: 800*600 53.67kHz (Line to PC)
Operator: Houny
Test Spec: Va 120V/60Hz
Comment: Temp:26°C
Humi:61%

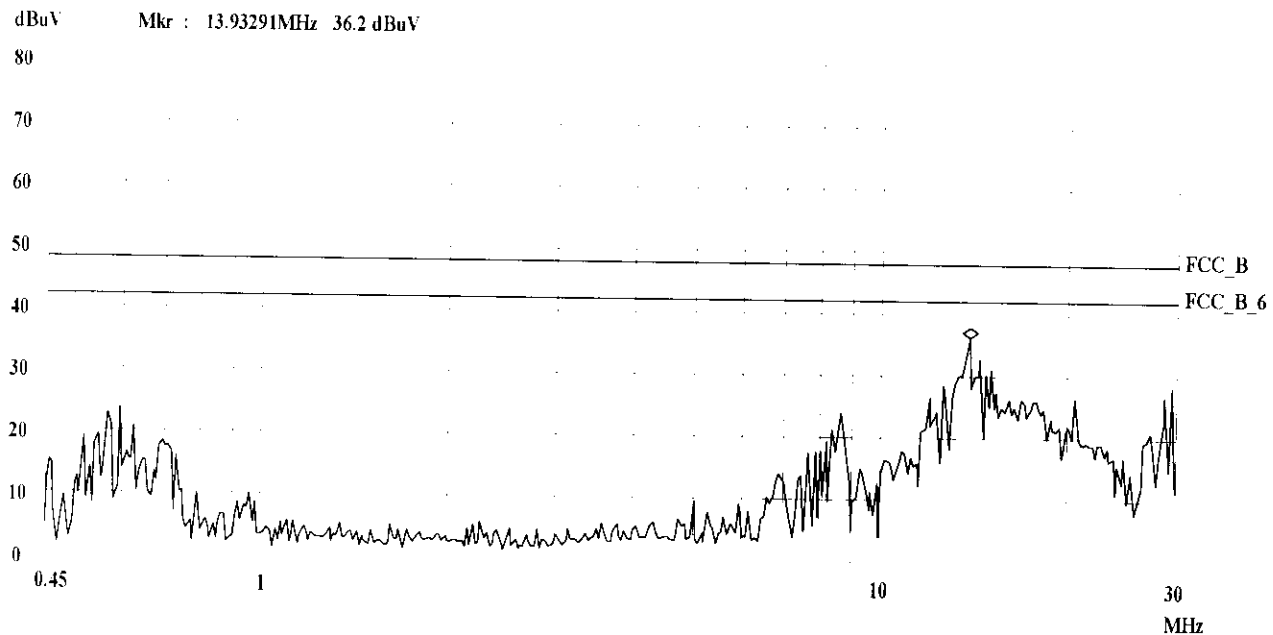

Conduction Test FCC Class B

25. Jun 98 10:22

EUT: Color Monitor M/N:5GLR+
Manuf: AOC
Op Cond: 800*600 53.67kHz (Line to PC)
Operator: Houny
Test Spec: Vb 120V/60Hz
Comment: Temp:26°C
Humi:61%

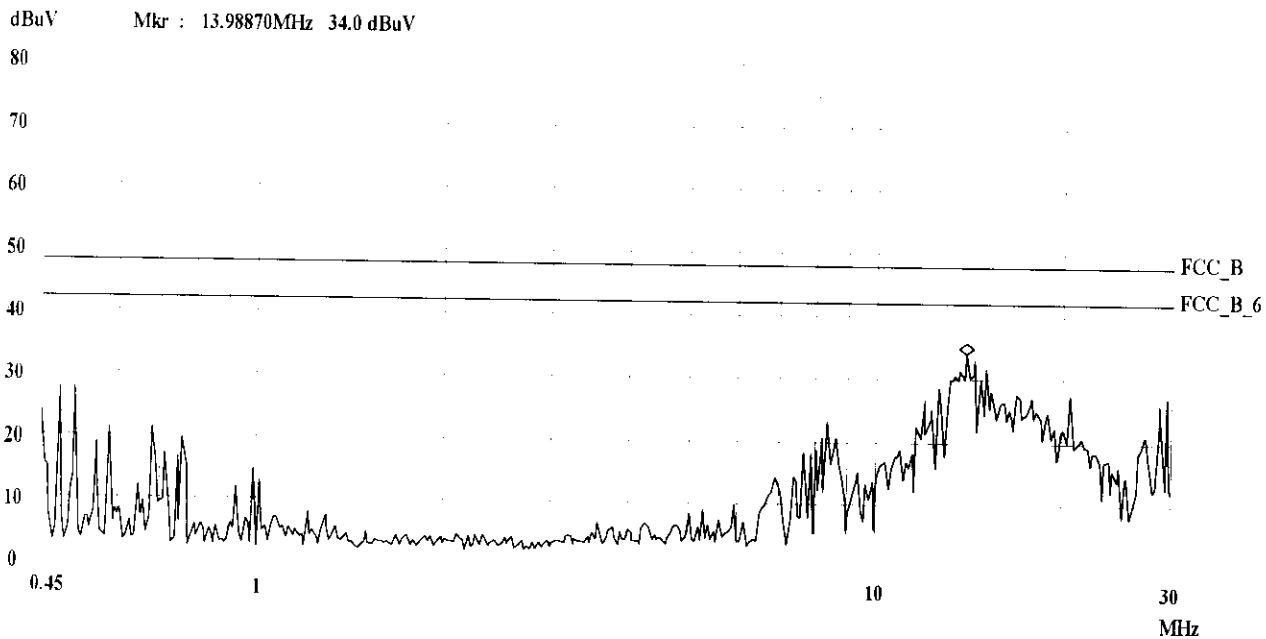

Conduction Test FCC Class B

25. Jun 98 10:29

EUT: Color Monitor M/N:5GLR+
Manuf: AOC
Op Cond: 1024*768 68.6kHz (Line to PC)
Operator: Houny
Test Spec: Va 120V/60Hz
Comment: Temp:26°C
Humi:61%

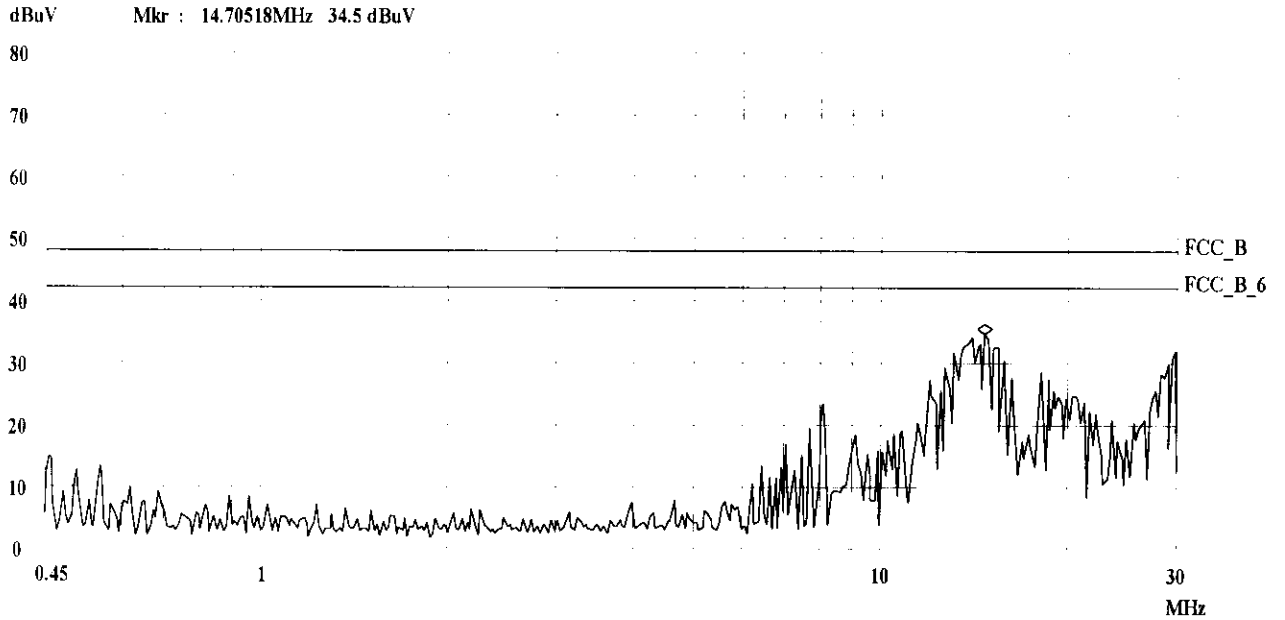

Conduction Test FCC Class B

25. Jun 98 10:32

EUT: Color Monitor M/N:5GLR+
Manuf: AOC
Op Cond: 1024*768 68.6kHz (Line to PC)
Operator: Houny
Test Spec: Vb 120V/60Hz
Comment: Temp:26°C
Humi:61%

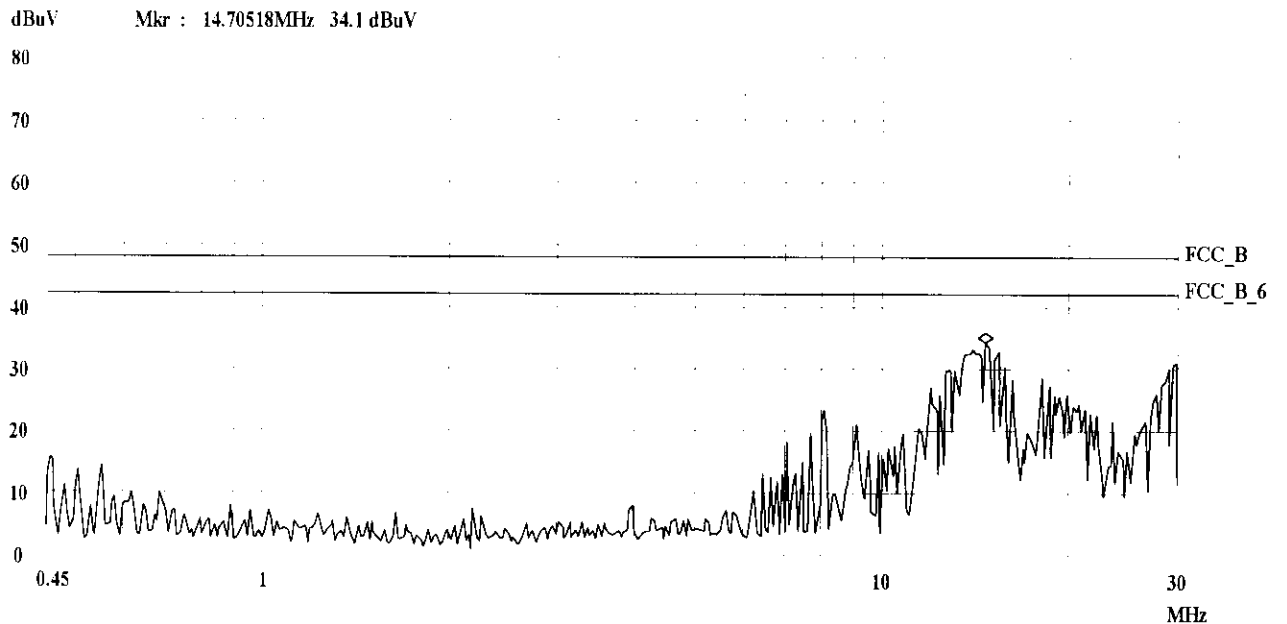

Conduction Test FCC Class B

25. Jun 98 10:59

EUT: Color Monitor M/N:5GLR+
Manuf: AOC
Op Cond: 640*480 31.5kHz (Line to LISN)
Operator: Houny
Test Spec: Va 120V/60Hz
Comment: Temp:26°C
Humi:61%

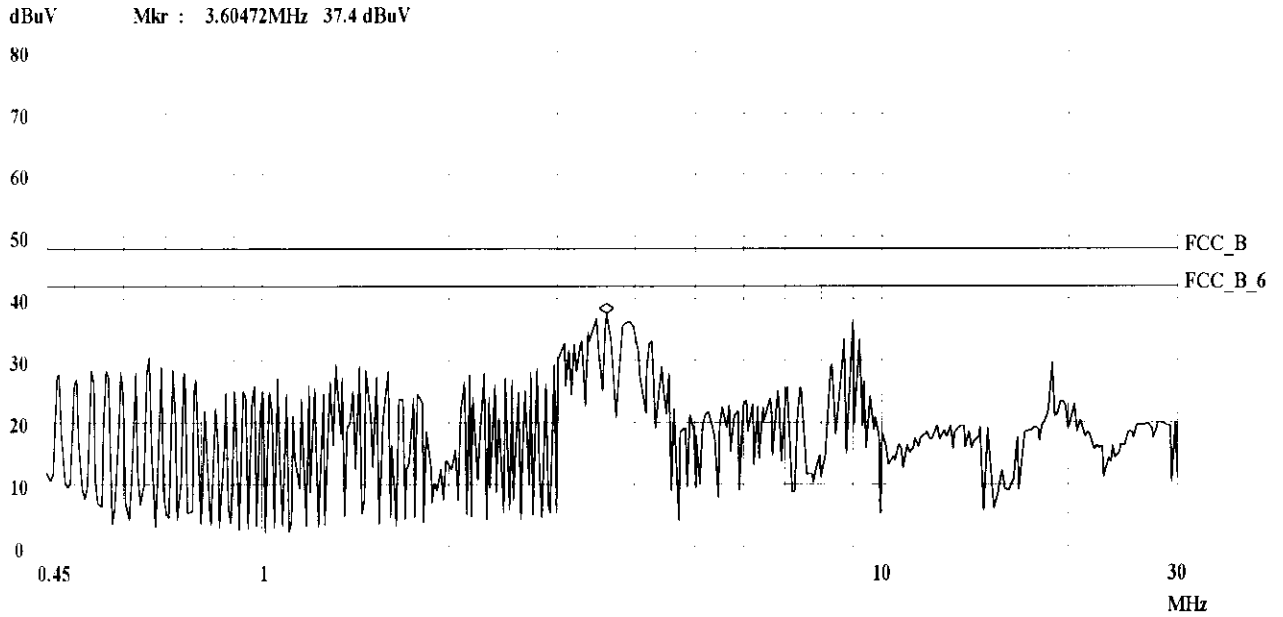

Conduction Test FCC Class B

25. Jun 98 10:56

EUT: Color Monitor M/N:5GLR+
Manuf: AOC
Op Cond: 640*480 31.5kHz (Line to LISN)
Operator: Houny
Test Spec: Vb 120V/60Hz
Comment: Temp:26°C
Humi:61%

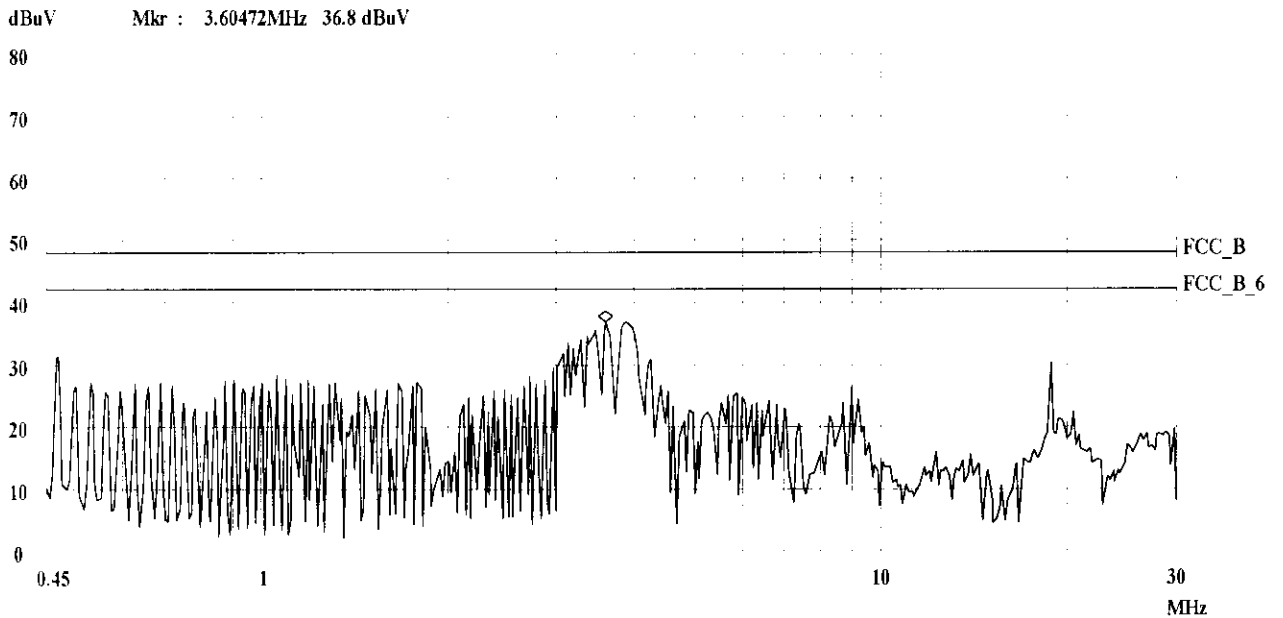

Conduction Test FCC Class B

25. Jun 98 10:49

EUT: Color Monitor M/N:5GLR+
Manuf: AOC
Op Cond: 800*600 53.67kHz (Line to LISN)
Operator: Houny
Test Spec: Va 120V/60Hz
Comment: Temp:26°C
Humi:61%

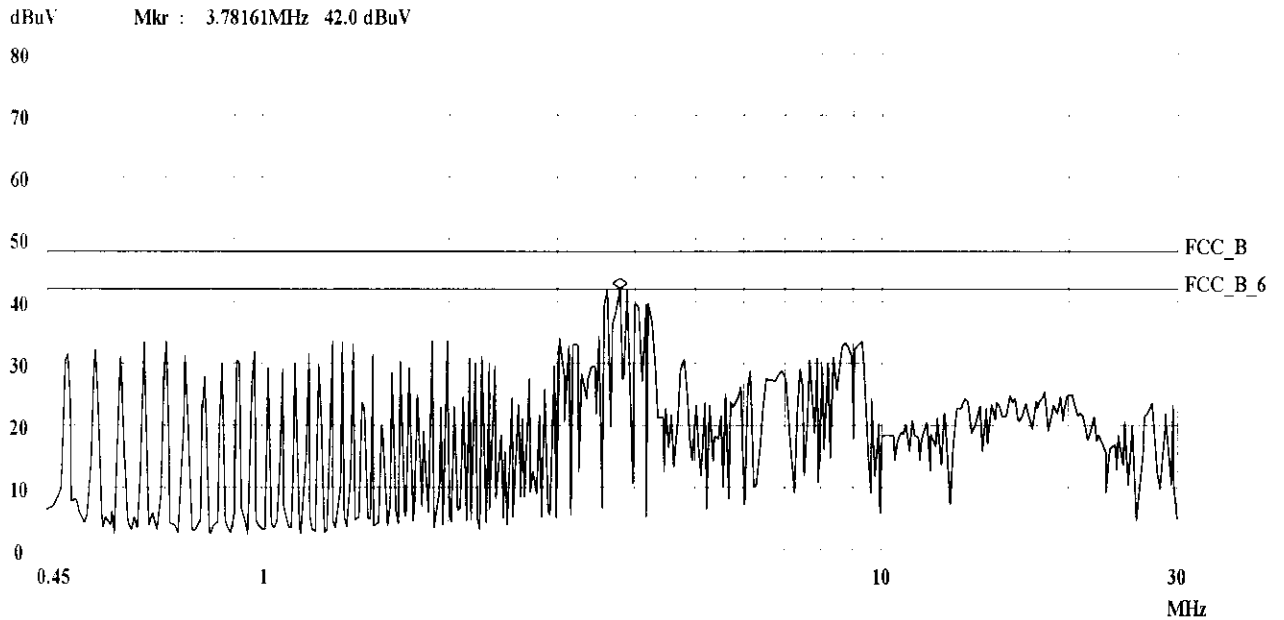

Conduction Test FCC Class B

25. Jun 98 10:53

EUT: Color Monitor M/N:5GLR+
Manuf: AOC
Op Cond: 800*600 53.67kHz (Line to LISN)
Operator: Houny
Test Spec: Vb 120V/60Hz
Comment: Temp:26°C
Humi:61%

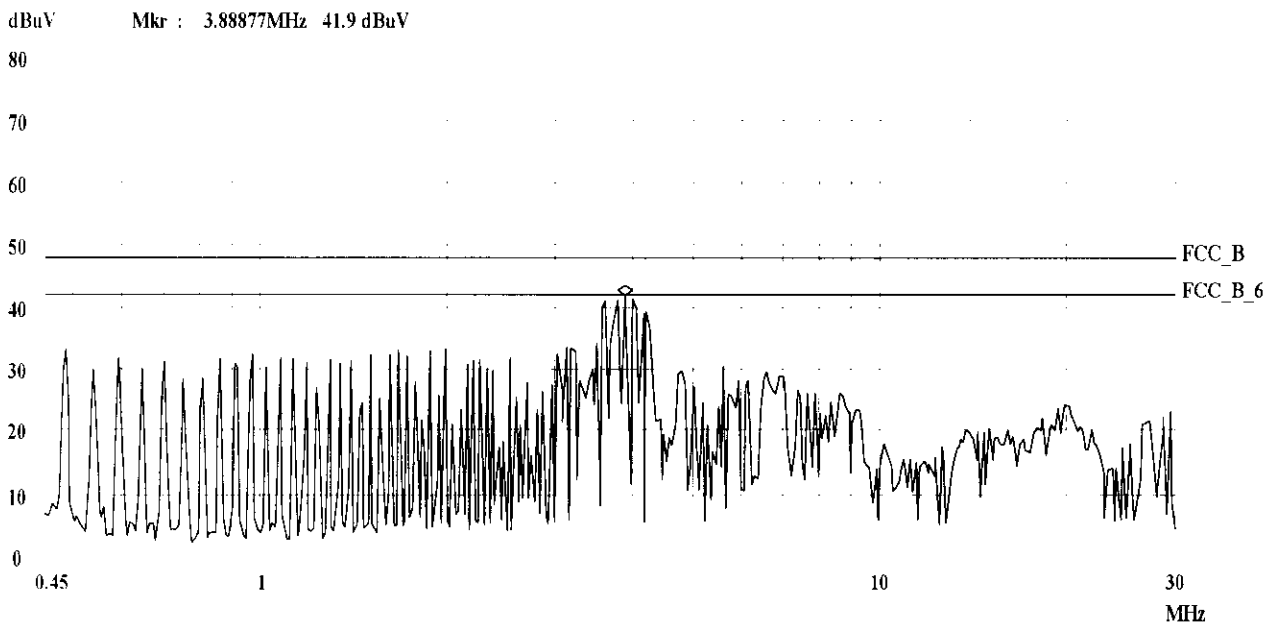

Conduction Test FCC Class B

25. Jun 98 10:46

EUT: Color Monitor M/N:5GLR+
Manuf: AOC
Op Cond: 1024*768 68.6kHz (Line to LISN)
Operator: Houny
Test Spec: Va 120V/60Hz
Comment: Temp:26°C
Humi:61%

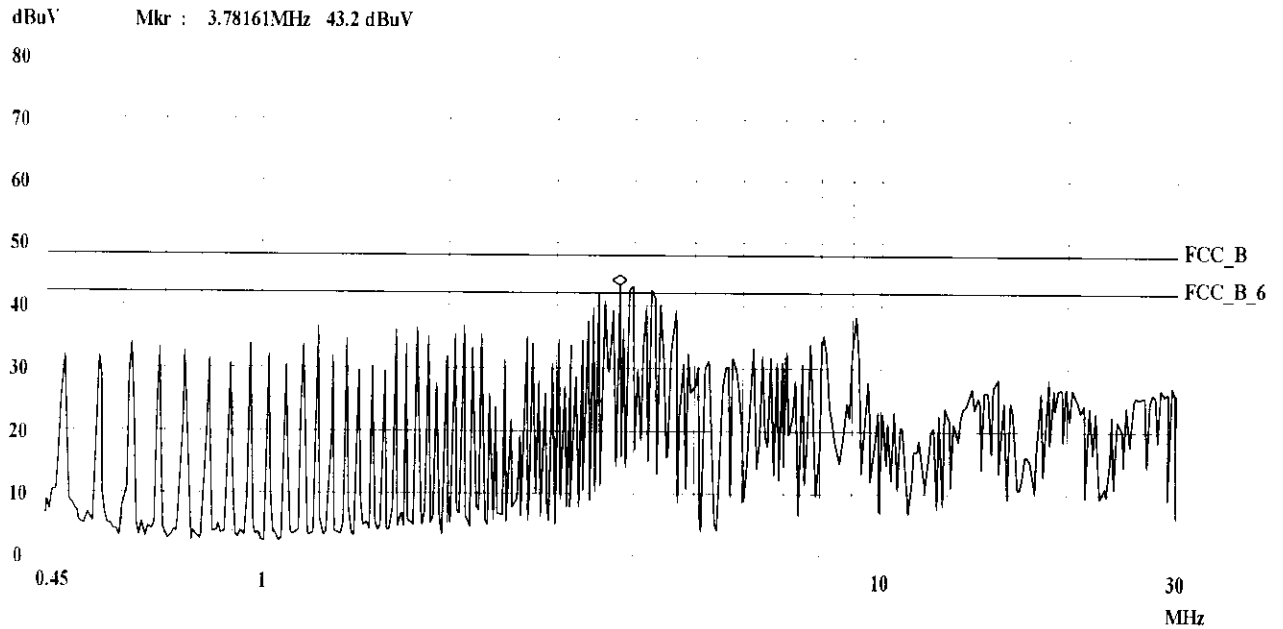

Conduction Test FCC Class B

25. Jun 98 10:42

EUT: Color Monitor M/N:5GLR+
Manuf: AOC
Op Cond: 1024*768 68.6kHz (Line to LISN)
Operator: Houny
Test Spec: Vb 120V/60Hz
Comment: Temp:26°C
Humi:61%

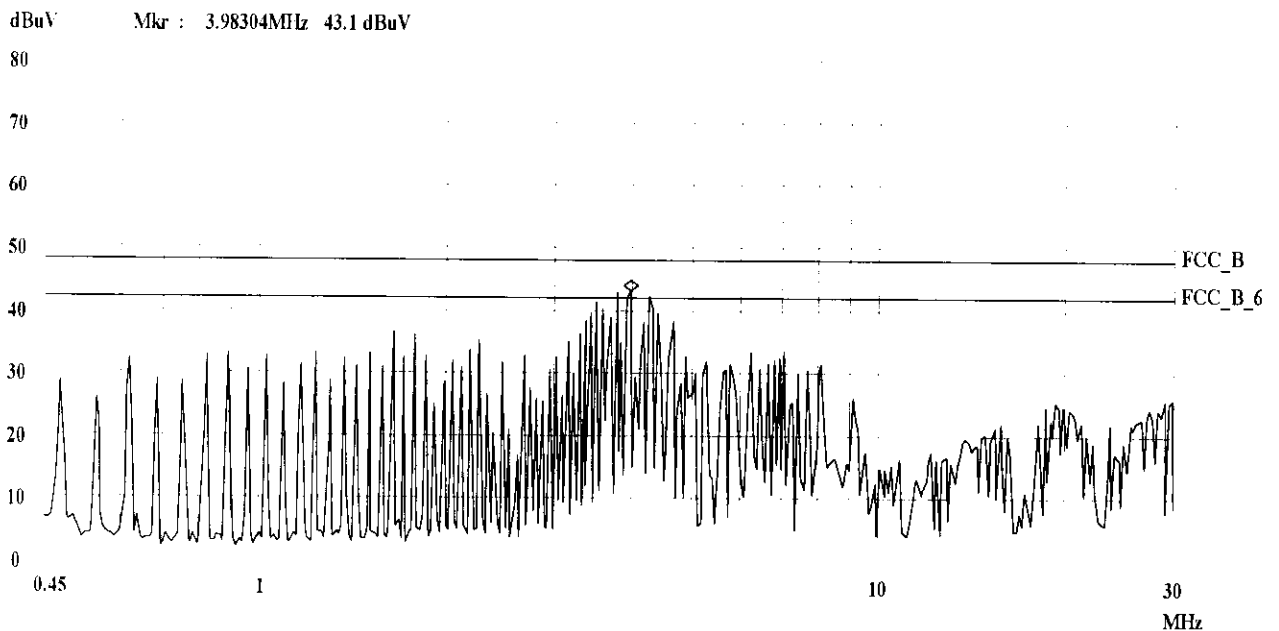

APPENDIX II

Data#: 111 File#: AOC.EMI
dBuV/m ACS Standard Chamber

Date: 06-24-1998 Time: 10:06:15
AUDIX Technology (Shenzhen) Co., Ltd.

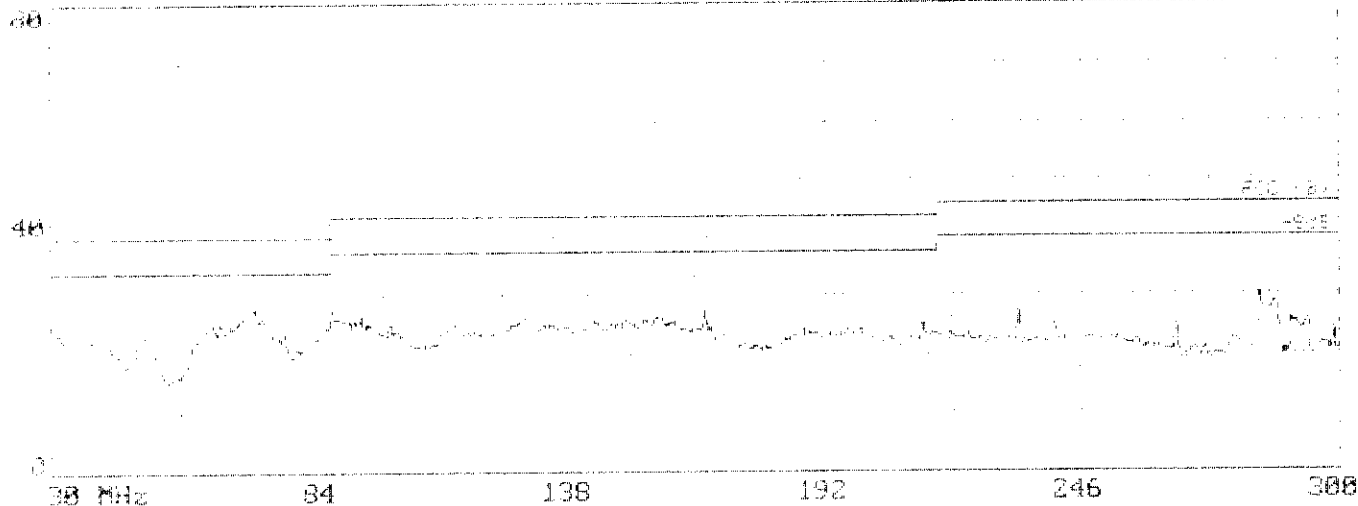

Trace 1
Unit: dBuV/m
Scale: 100
Marker: 100
Power: 100
View: 100

Data#: 112 File#: AOC.EMI
dBuV/m ACS Standard Chamber

Date: 06-24-1998 Time: 10:07:28
AUDIX Technology (Shenzhen) Co., Ltd.

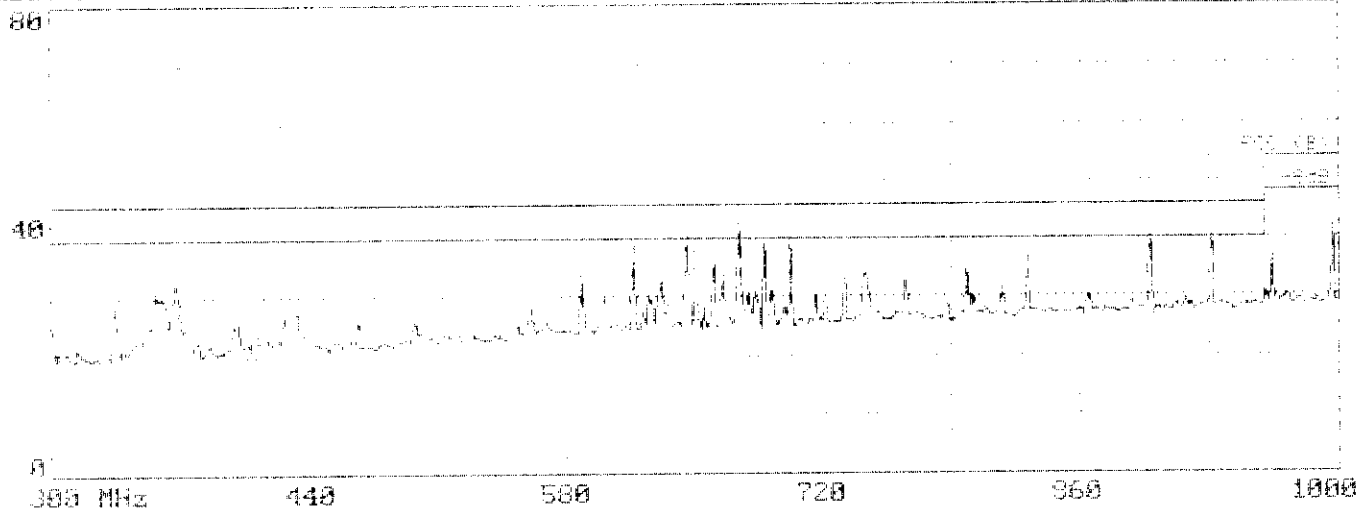

Trace 1
Unit: dBuV/m
Scale: 100
Marker: 100
Power: 100
View: 100

Data# 113 File# AOC.EMI
dBu/m ACS Standard Chamber

Date: 86-24-1998 Time: 10:09:15
AUDIX Technology (Shenzhen) Co., Ltd.

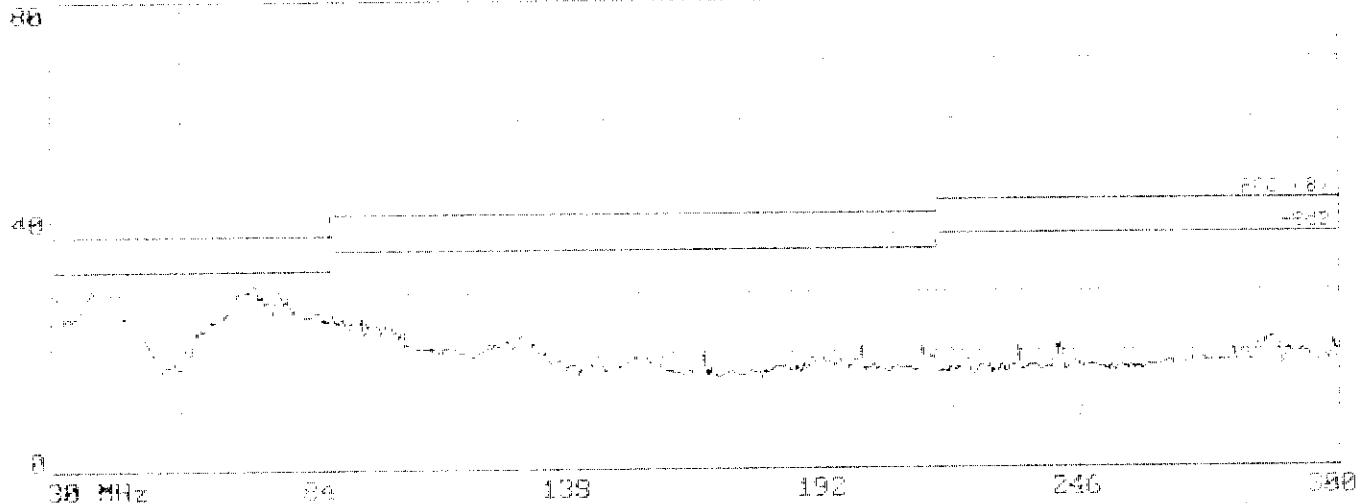

Trace 1

Unit: dBu/m
Range: 0-80
Max: 80
Min: 0
Power: 1000 Hz
Name: 113-86-24-1998-10-09-15-A-Yan

Data# 114 File# AOC.EMI
dBu/m ACS Standard Chamber

Date: 86-24-1998 Time: 10:11:15
AUDIX Technology (Shenzhen) Co., Ltd.

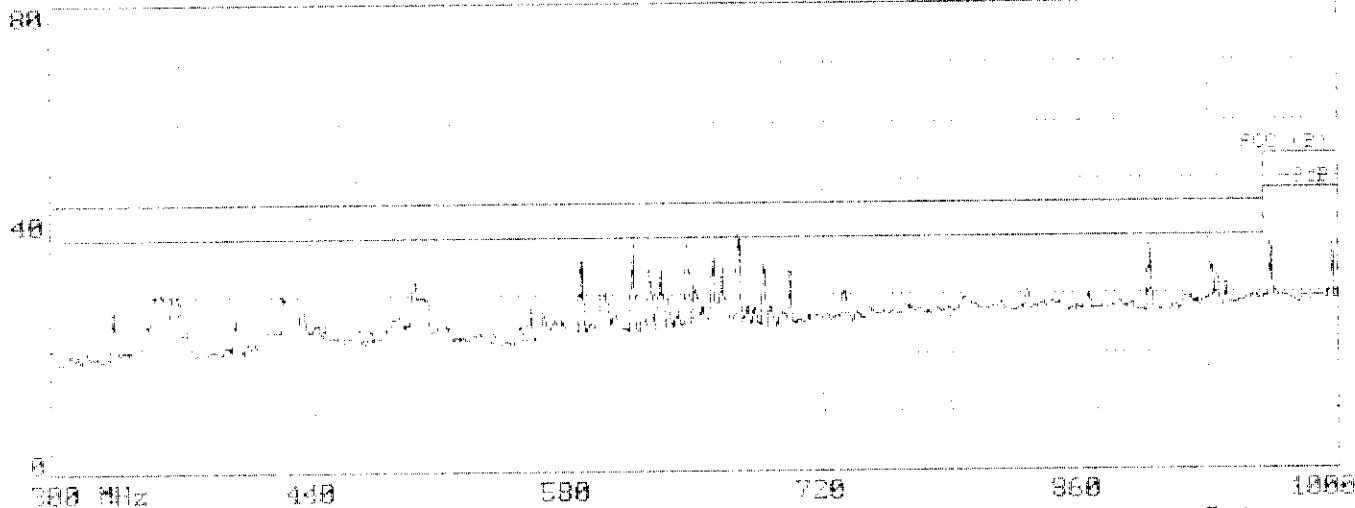

Trace 1

Unit: dBu/m
Range: 0-80
Max: 80
Min: 0
Power: 1000 Hz
Name: 114-86-24-1998-10-11-15-A-Yan

Data#: 109 File#: AOC.EMI
dBuV/m ACS Standard Chamber

Date: 06-24-1998 Time: 18:02:18
AUDIX Technology (Shenzhen) Co., Ltd.

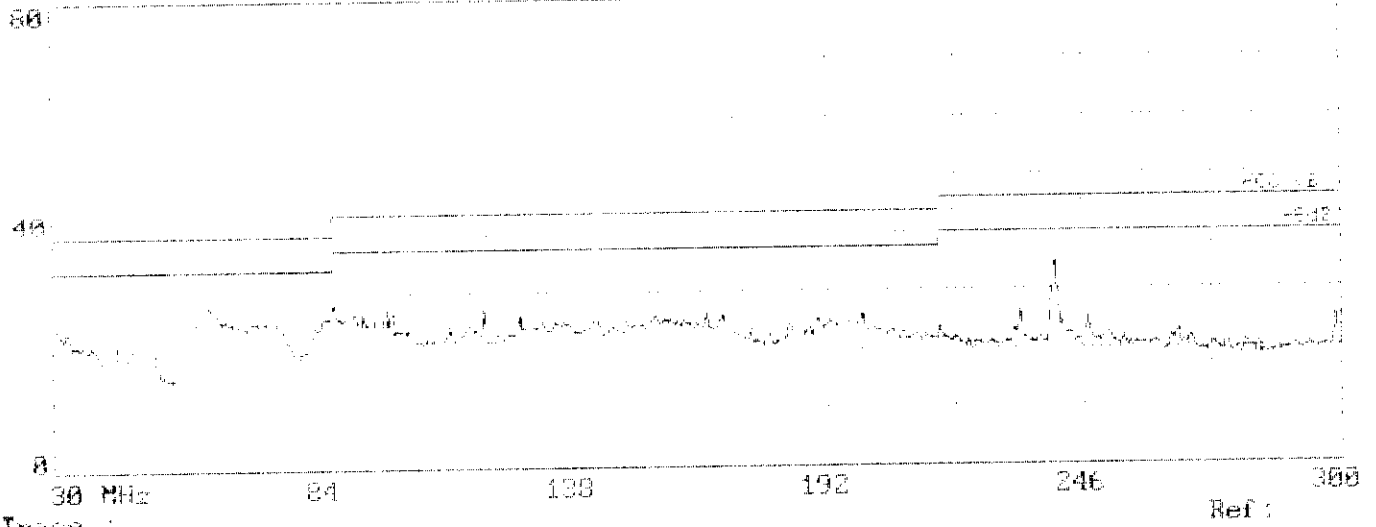

Data#: 110 File#: AOC.EMI
dBuV/m ACS Standard Chamber

Date: 06-24-1998 Time: 18:03:26
AUDIX Technology (Shenzhen) Co., Ltd.

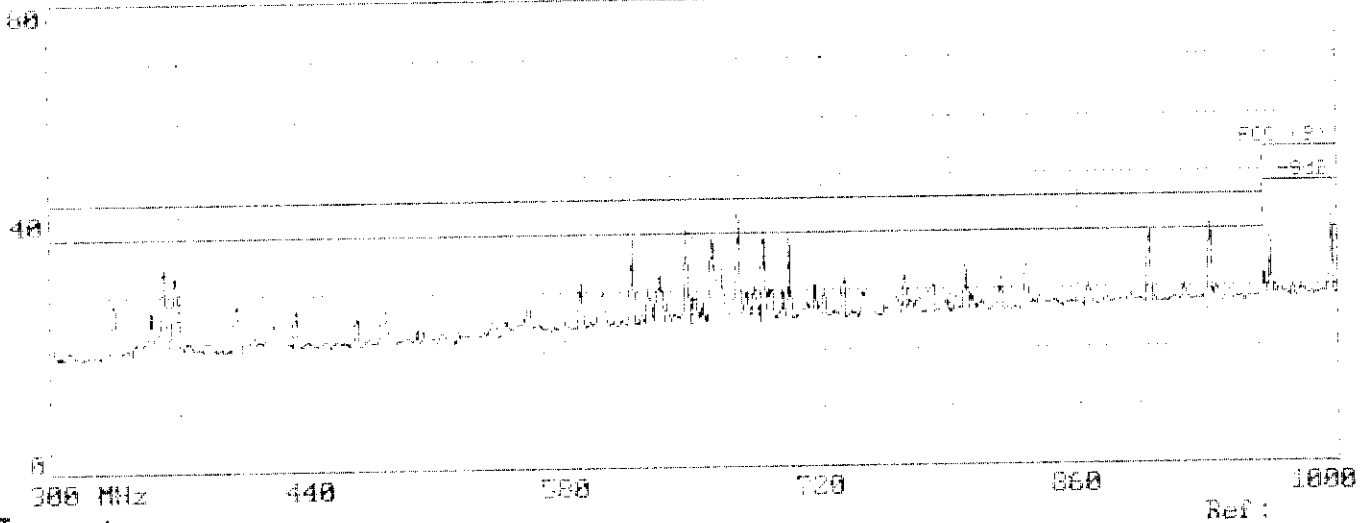

Data# 187 File#: AOC.EMI
3Bu0/n ACS Standard Chamber

Date: 06-24-1998 Time: 09:58:40
AUDIX Technology (Shenzhen) Co., Ltd.

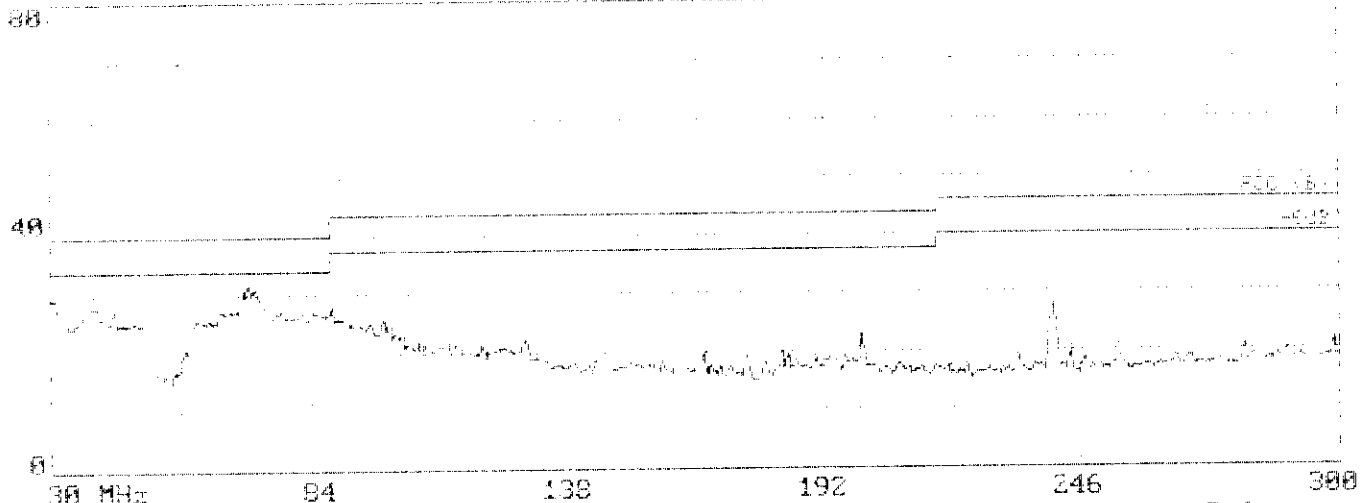

Trace 1
Unit: dB
Scale: 10 VERTICAL
Margin: 6dB
Ext: 1000 MHz (1000 MHz)
Power: 10W (0dB)
Mod: 1000Hz (1000Hz) Power: 1000W (30dB) Mod: 1

Data# 188 File#: AOC.EMI
3Bu0/n ACS Standard Chamber

Date: 06-24-1998 Time: 10:00:01
AUDIX Technology (Shenzhen) Co., Ltd.

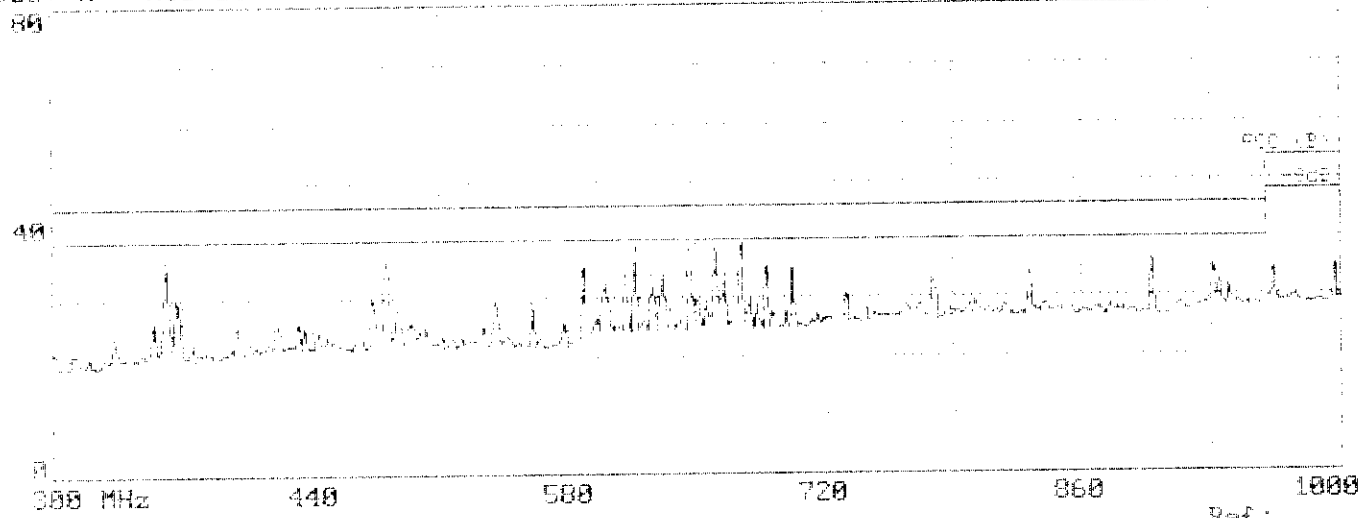

Trace 1
Unit: dB
Scale: 10 VERTICAL
Margin: 6dB
Ext: 1000 MHz (1000 MHz)
Power: 10W (0dB)
Mod: 1000Hz (1000Hz) Power: 1000W (30dB) Mod: 1

Data#: 183 File#: AOC.EMI
dBu/n ACS Standard Chamber

Date: 06-24-1998 Time: 09:49:41
AUDIX Technology (Shenzhen) Co., Ltd.

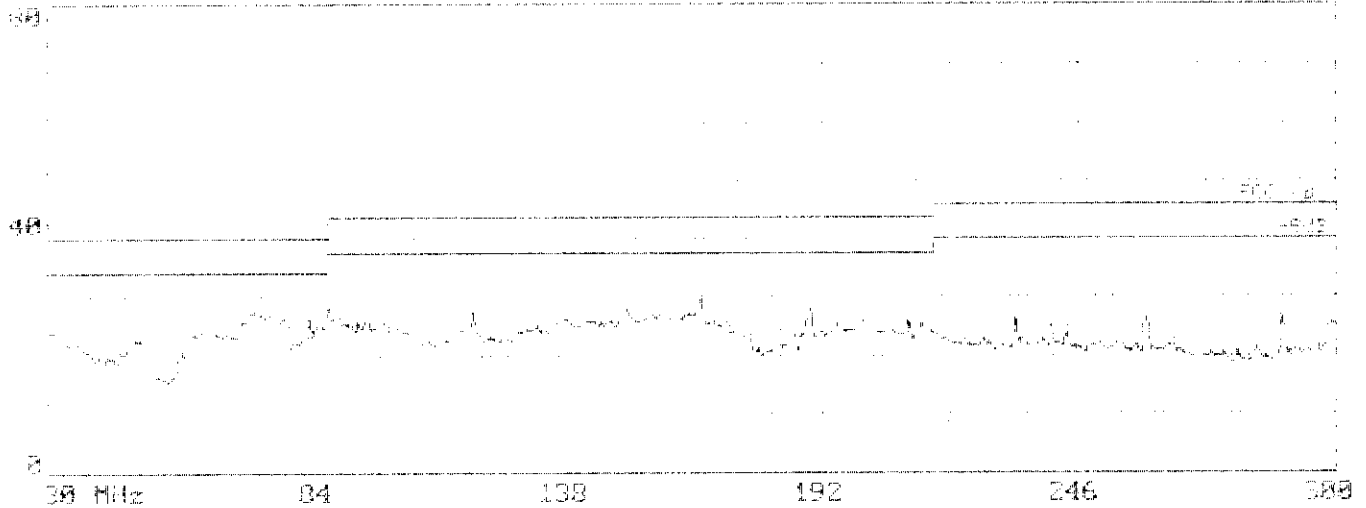

Trace : Ref:
Unit : dB
Filter : 120 Hz (NF=1)
Marker : 0.00
Port : Y (Yield) X (Loss)
Power : 100.00 W
Ref : 100.00 dB (100.00 W) (1.00 mV) (1.00 m)

Data#: 184 File#: AOC.EMI
dBu/n ACS Standard Chamber

Date: 06-24-1998 Time: 09:51:06
AUDIX Technology (Shenzhen) Co., Ltd.

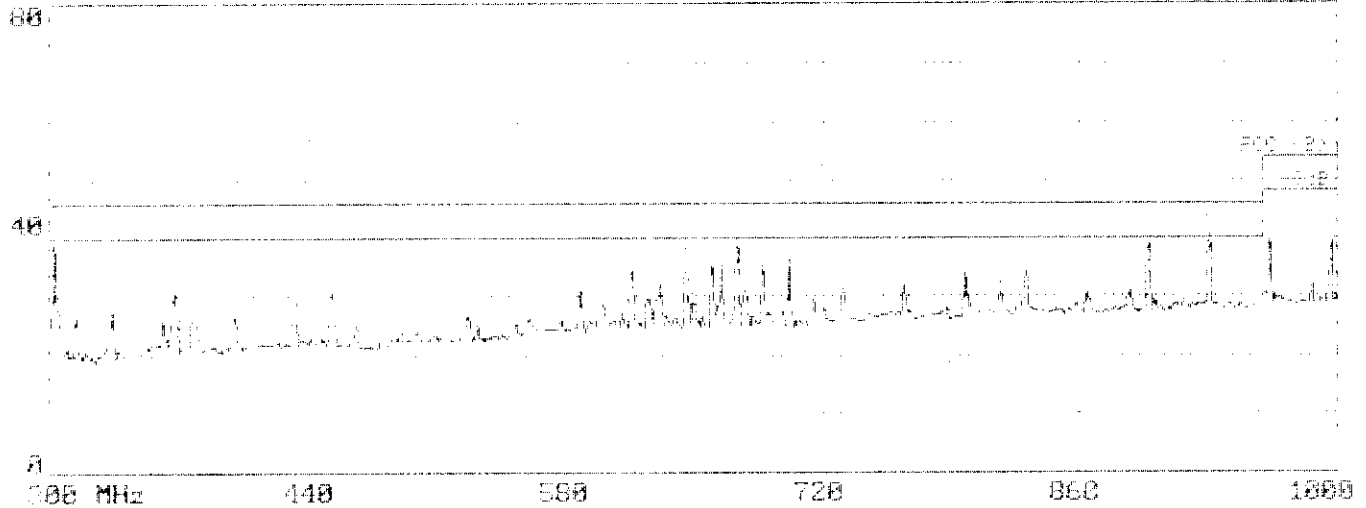

Trace : Ref:
Unit : dB
Filter : 120 Hz (NF=1)
Marker : 0.00
Port : Y (Yield) X (Loss)
Power : 100.00 W
Ref : 100.00 dB (100.00 W) (1.00 mV) (1.00 m)

Data#: 105 File#: AOC.EMI
dBuV/m ACS Standard Chamber

Date: 06-24-1998 Time: 09:53:06
AUDIX Technology (Shenzhen) Co., Ltd.

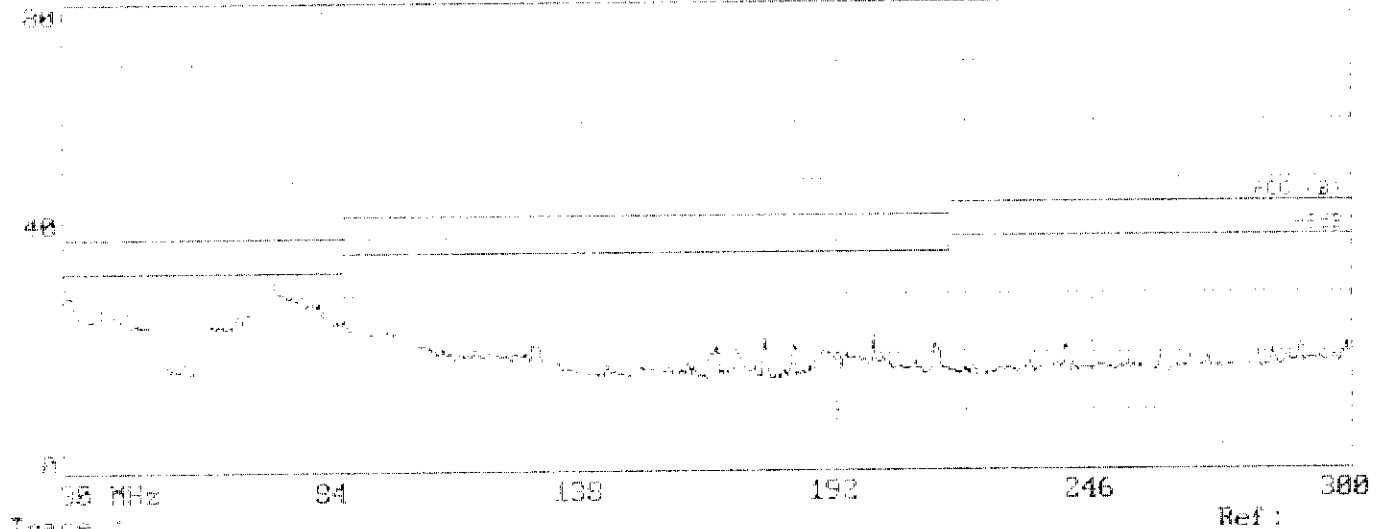

Trace :
Limit : 100 dB
Filter : 100 kHz
Weighting : 1/3
Sweep : 100 kHz
Power : 100 mW
Modulation : 100 kHz 100% Power

Data#: 106 File#: AOC.EMI
dBuV/m ACS Standard Chamber

Date: 06-24-1998 Time: 09:54:46
AUDIX Technology (Shenzhen) Co., Ltd.

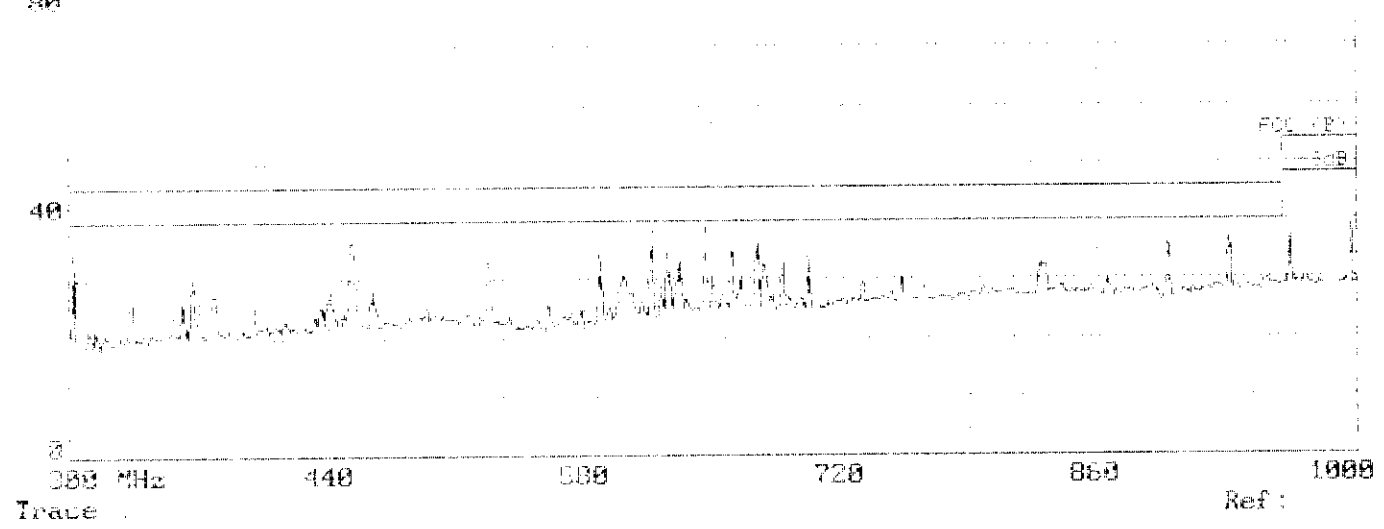

Trace :
Limit : 100 dB
Filter : 100 kHz
Weighting : 1/3
Sweep : 100 kHz
Power : 100 mW
Modulation : 100 kHz 100% Power

Data#: 117 File#: AOC.EMI
dBuV/m ACS Standard Chamber

Date: 86-24-1998 Time: 10:28:32
AUDIX Technology (Shenzhen) Co., Ltd.

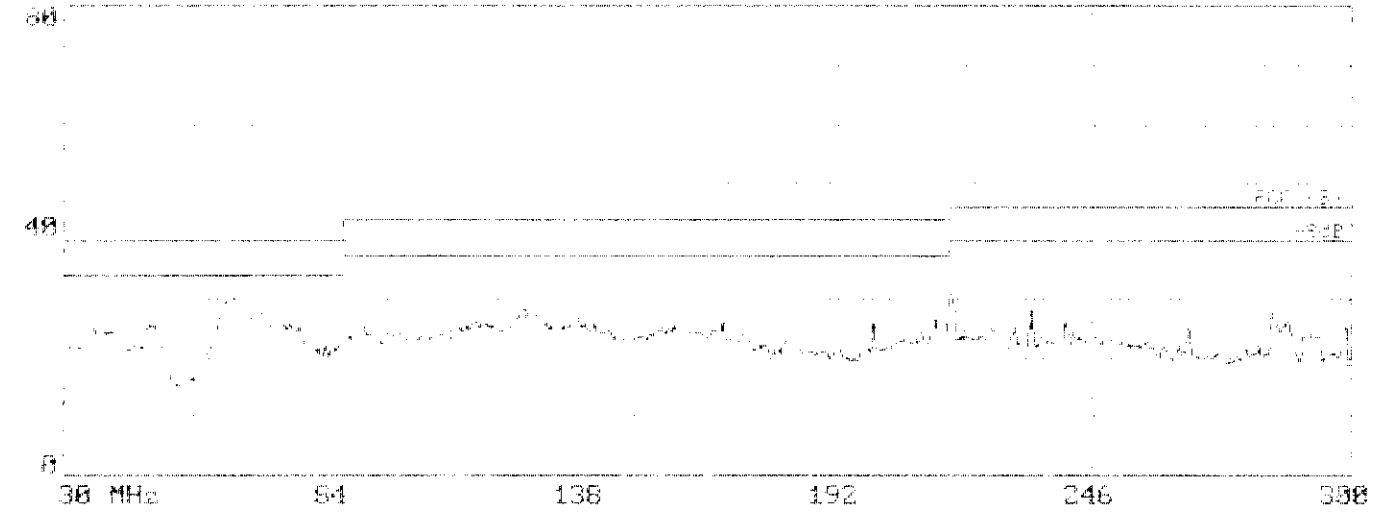

Trace : Ref :

File: AOC.EMI
Title: AOC.EMI
Date: 86-24-1998
Time: 10:28:32
User: XIE BRIGHT
Printer: XIE BRIGHT

Data#: 118 File#: AOC.EMI
dBuV/m ACS Standard Chamber

Date: 86-24-1998 Time: 10:38:48
AUDIX Technology (Shenzhen) Co., Ltd.

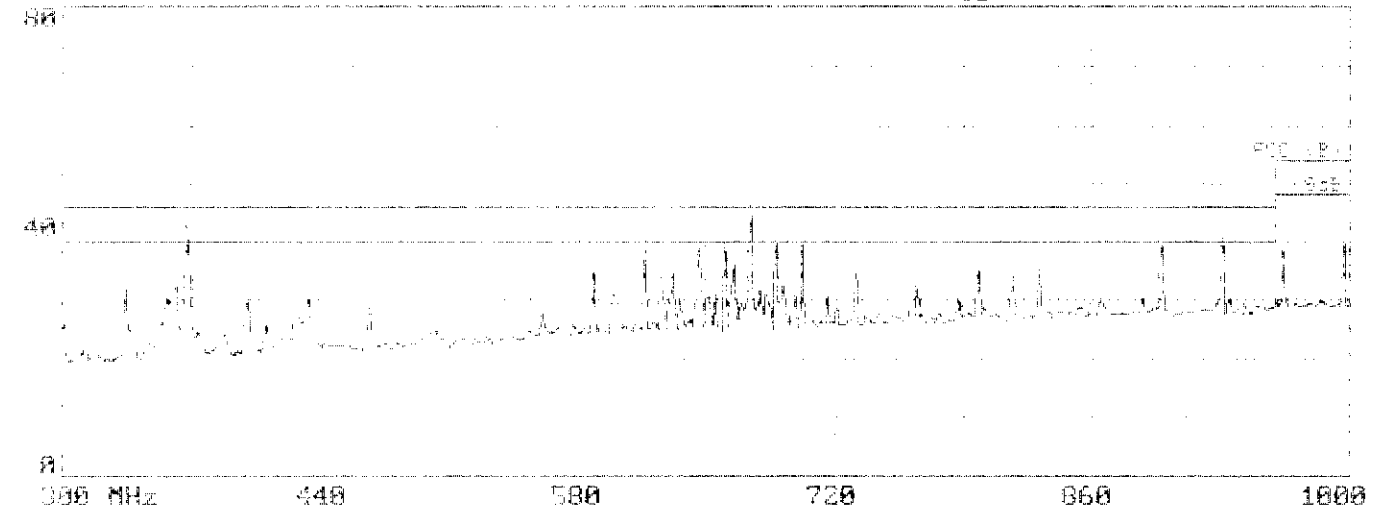

Trace : Ref :

File: AOC.EMI
Title: AOC.EMI
Date: 86-24-1998
Time: 10:38:48
User: XIE BRIGHT
Printer: XIE BRIGHT

Bright Xie 6/24/98

Data#: 115 File#: ACC.EMI
dBu/m ACS Standard Chamber

Date: 06-24-1998 Time: 10:23:58
AUDIX Technology (Shenzhen) Co., Ltd.

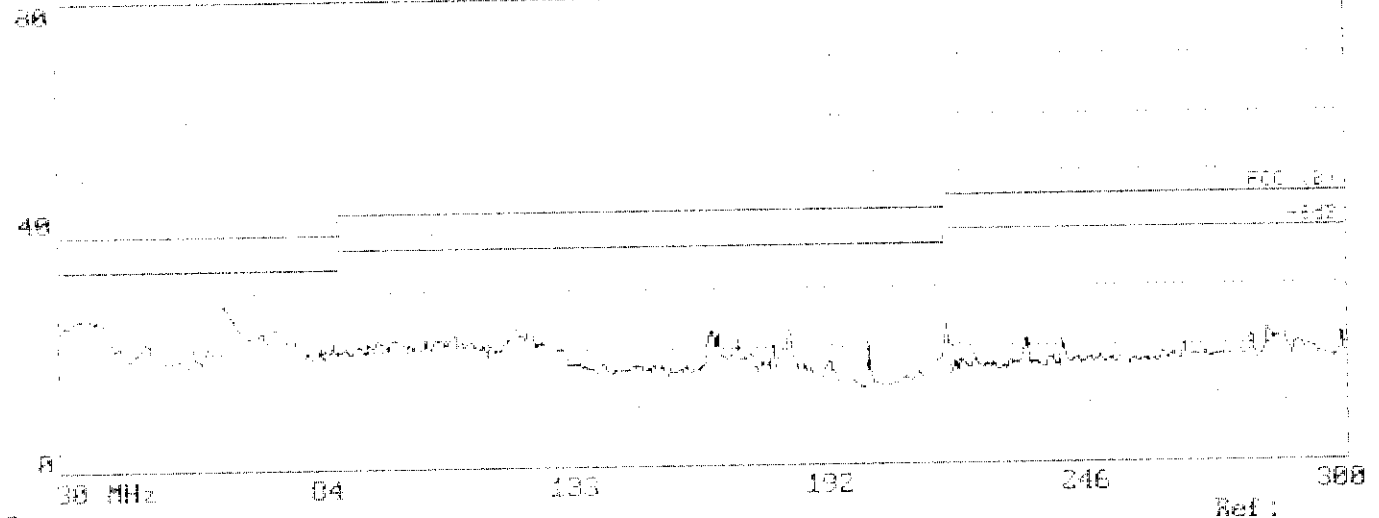

Trace 1
Type: Full Band
Filter: 120 Hz
Range: 60dB
Sweep: 100V/6MHz
Power: 100mW

Data#: 116 File#: ACC.EMI
dBu/m ACS Standard Chamber

Date: 06-24-1998 Time: 10:25:56
AUDIX Technology (Shenzhen) Co., Ltd.

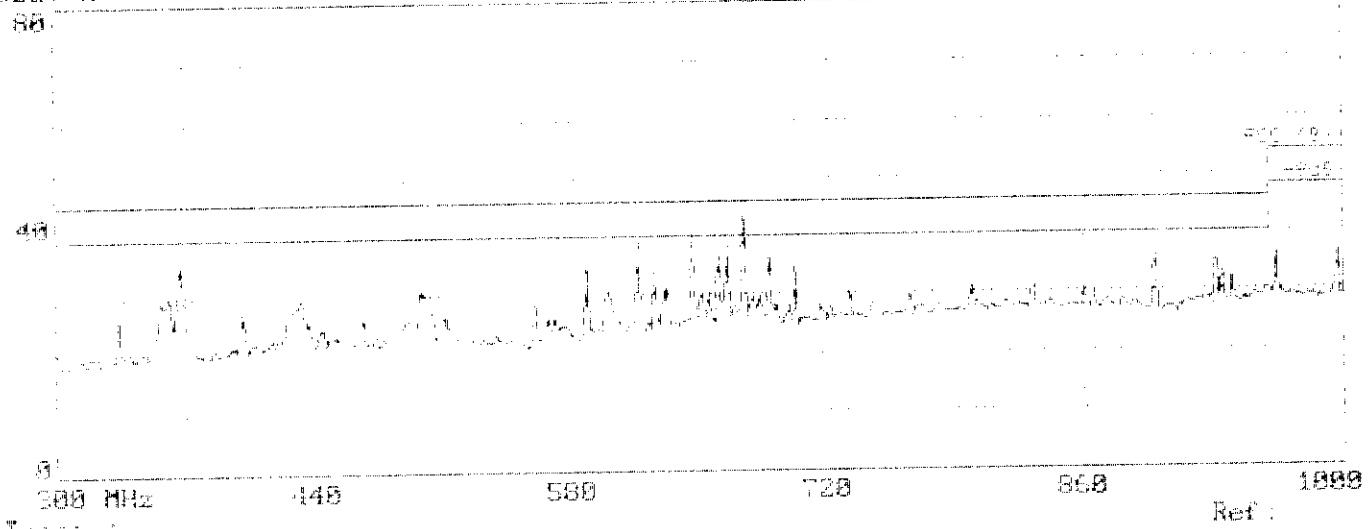

Trace 1
Type: Full Band
Filter: 120 Hz
Range: 60dB
Sweep: 100V/6MHz
Power: 100mW

Bright Xie 6/24/98

Date# 119 File# AOC.EMI
dBu/m ACS Standard Chamber

Date: 86-24-1998 Time: 18:34:02
AUDIX Technology (Shenzhen) Co., Ltd.

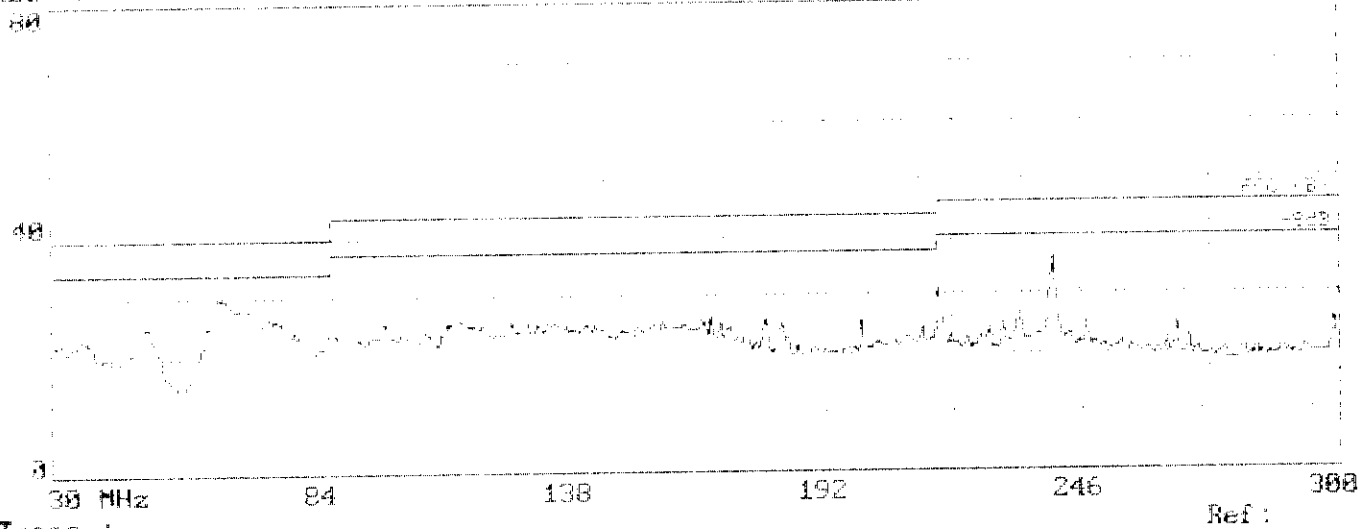

Trace 1
Unit: dBu/m
Scope: 1176 HORIZONTAL
Marker: 640
Start: 30.000 MHz
Power: 100.000 dBm
View: Freq 70Hz 101.000; Power Low to P1

Date# 120 File# AOC.EMI
dBu/m ACS Standard Chamber

Date: 86-24-1998 Time: 18:35:52
AUDIX Technology (Shenzhen) Co., Ltd.

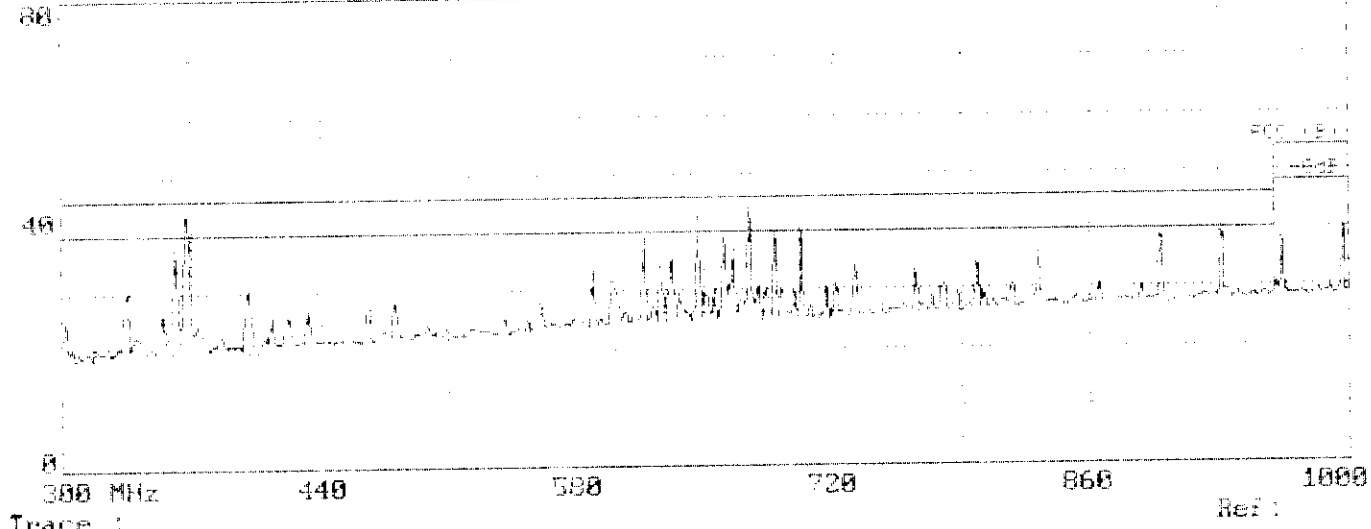

Trace 1
Unit: dBu/m
Scope: 1176 HORIZONTAL
Marker: 640
Start: 300.000 MHz
Power: 100.000 dBm
View: Freq 70Hz 101.000; Power Low to P1

Bright Xie 6/24/98

Data#: 121 File#: AOC.EMI
#BuU/n ACS Standard Chamber

Date: 06-24-1998 Time: 10:37:51
AUDIX Technology (Shenzhen) Co., Ltd.

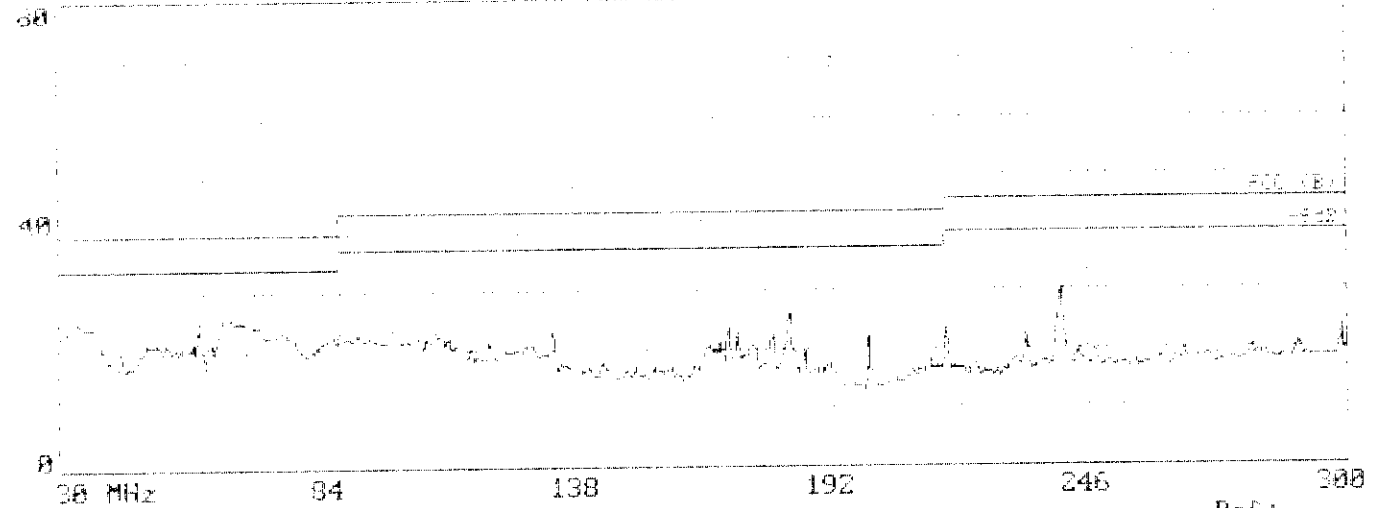

Trace 1
Unit: 1000 Hz
Filter: 1200 Hz
Range: 40 dB
Sweep: 1000 Hz
Power: 100 mW
Mod: 1000 Hz

Data#: 122 File#: AOC.EMI
#BuU/n ACS Standard Chamber

Date: 06-24-1998 Time: 10:40:04
AUDIX Technology (Shenzhen) Co., Ltd.

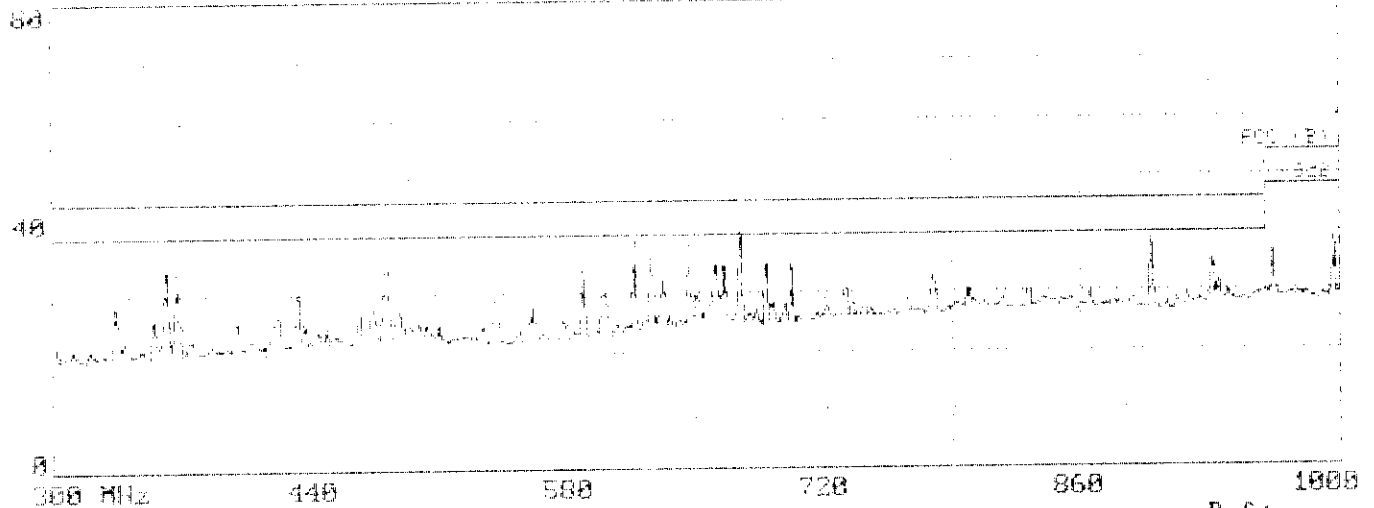

Trace 1
Unit: 1000 Hz
Filter: 1200 Hz
Range: 40 dB
Sweep: 1000 Hz
Power: 100 mW
Mod: 1000 Hz

Data#: 125 File#: AOC.EMI

Date: 06-24-1998 Time: 10:50:39
AUDIX Technology (Shenzhen) Co., Ltd.

dBu/m ACS Standard Chamber

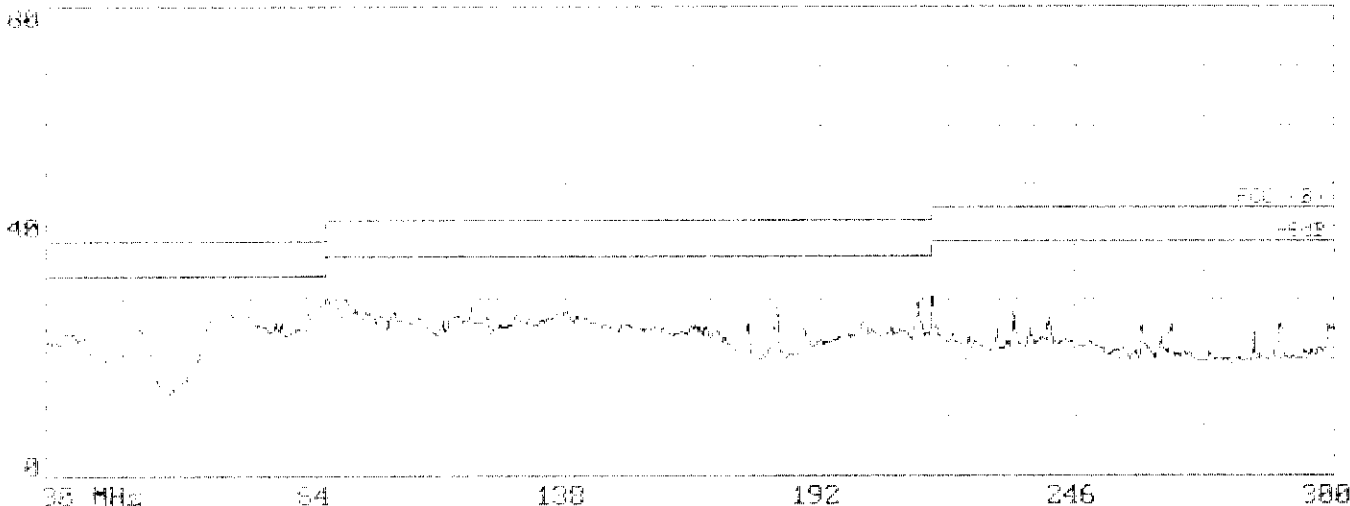

Trace 1 Ref :

Unit : dBu/m
 Power : 100W (0dB)
 Mod : AM
 BW : 100W (0dB)
 Mod : AM
 Power : 100W (0dB)
 Mod : AM

Data#: 126 File#: AOC.EMI

Date: 06-24-1998 Time: 10:53:02
AUDIX Technology (Shenzhen) Co., Ltd.

dBu/m ACS Standard Chamber

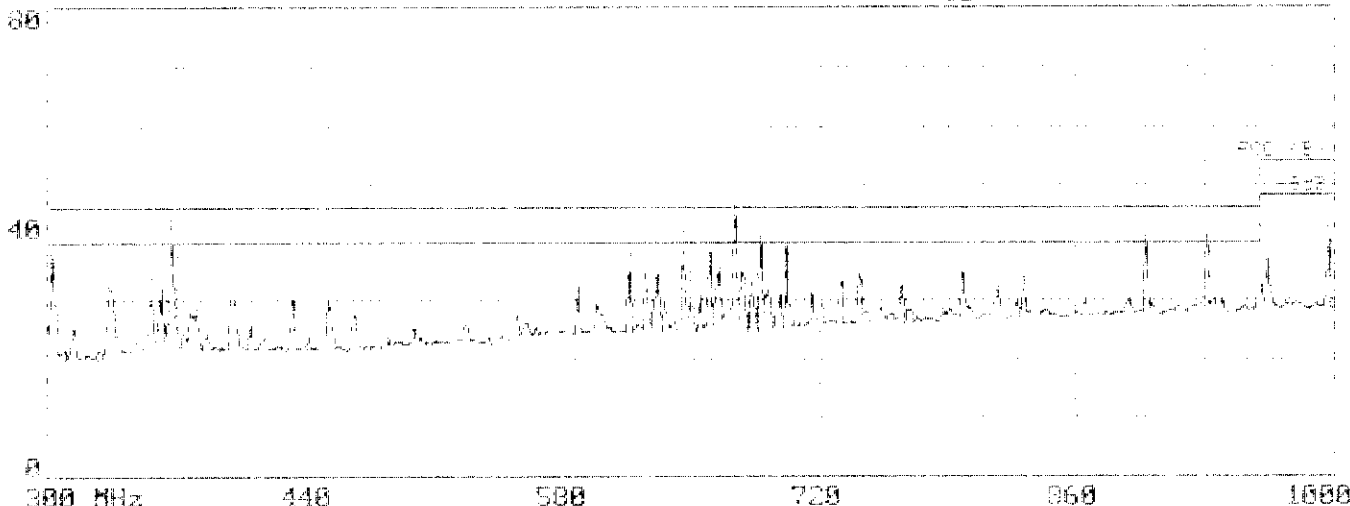

Trace 1 Ref :

Unit : dBu/m
 Power : 100W (0dB)
 Mod : AM
 BW : 100W (0dB)
 Mod : AM
 Power : 100W (0dB)
 Mod : AM

Data#: 123 File#: AOC.EMI

Date: 96-24-1998 Time: 10:43:32

JBuV/m ACS Standard Chamber

AUDIX Technology (Shenzhen) Co., Ltd.

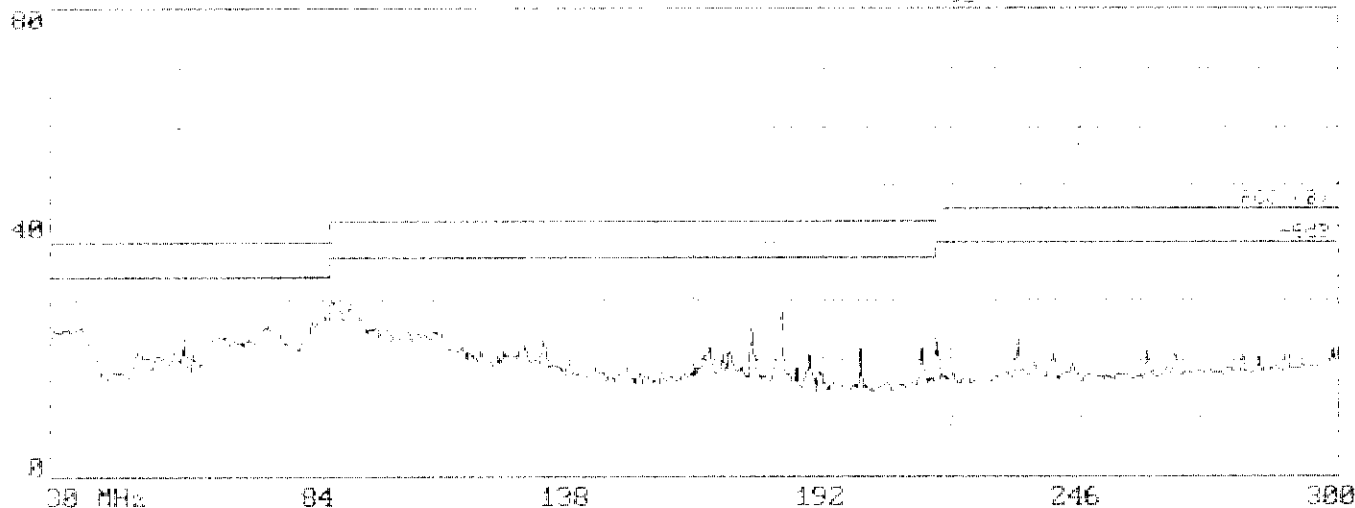

Trace : Ref :

Unit : F001 (dB)
 Probe : 1176 VERTICAL
 Marker : 84.0
 Freq : 84.0 MHz
 Power : 11.0 dBm
 Marker : 84.0 MHz 11.0 dBm Power Line to 0

Data#: 124 File#: AOC.EMI

Date: 96-24-1998 Time: 10:47:09

JBuV/m ACS Standard Chamber

AUDIX Technology (Shenzhen) Co., Ltd.

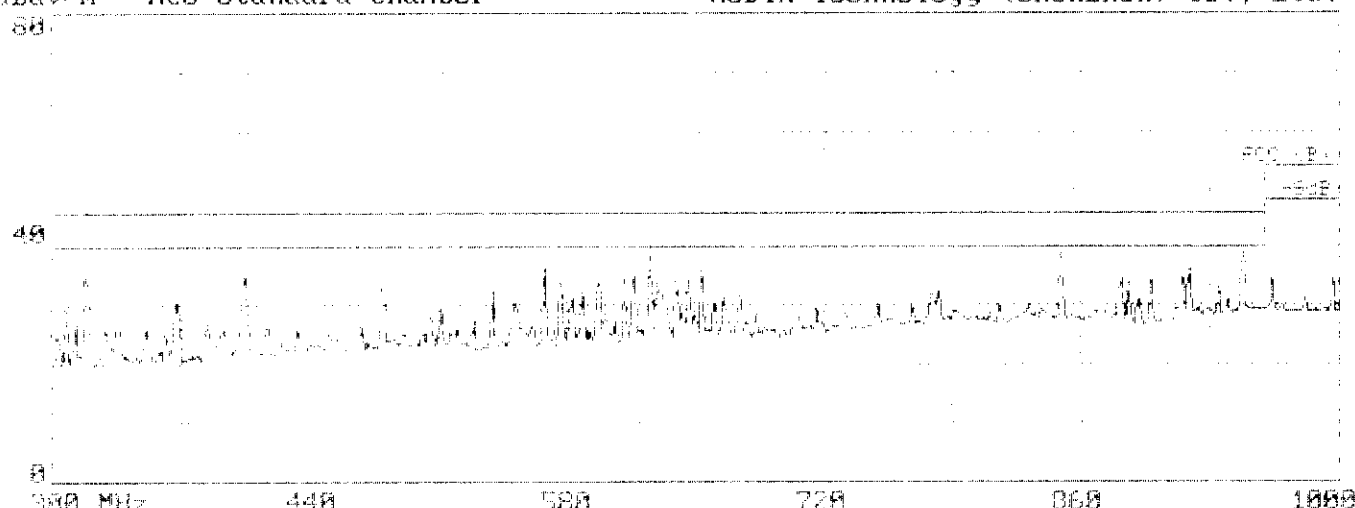

Trace : Ref :

Unit : F001 (dB)
 Probe : 1176 VERTICAL
 Marker : 440.0
 Freq : 440.0 MHz
 Power : 11.0 dBm
 Marker : 440.0 MHz 11.0 dBm Power Line to 0