



FCC TEST REPORT (BLUETOOTH+EDR)

REPORT NO.: RF130614D02-3

MODEL NO.: WSDB-675GN

FCC ID: ARS-WSDB675GN

RECEIVED: Jun. 14, 2013

TESTED: Jun. 21 ~ Jul. 15, 2013

ISSUED: Aug. 2, 2013

APPLICANT: TOP VICTORY ELECTRONICS (TAIWAN) CO., LTD.

ADDRESS: 10F., No 230, Liancheng Rd., Zhonghe Dist., New Taipei City 23553, Taiwan

ISSUED BY: Bureau Veritas Consumer Products Services (H.K.) Ltd., Taoyuan Branch

LAB ADDRESS: No. 47, 14th Ling, Chia Pau Vil., Lin Kou Dist., New Taipei City, Taiwan

This report should not be used by the client to claim product certification, approval, or endorsement by TAF or any government agencies.



This report is for your exclusive use. Any copying or replication of this report to or for any other person or entity, or use of our name or trademark, is permitted only with our prior written permission. This report sets forth our findings solely with respect to the test samples identified herein. The results set forth in this report are not indicative or representative of the quality or characteristics of the lot from which a test sample was taken or any similar or identical product unless specifically and expressly noted. Our report includes all of the tests requested by you and the results thereof based upon the information that you provided to us. You have 60 days from date of issuance of this report to notify us of any material error or omission caused by our negligence, provided, however, that such notice shall be in writing and shall specifically address the issue you wish to raise. A failure to raise such issue within the prescribed time shall constitute your unqualified acceptance of the completeness of this report, the tests conducted and the correctness of the report contents. Unless specific mention, the uncertainty of measurement has been explicitly taken into account to declare the compliance or non-compliance to the specification.



Table of Contents

RELEASE CONTROL RECORD	4
1. CERTIFICATION.....	5
2. SUMMARY OF TEST RESULTS	6
2.1 MEASUREMENT UNCERTAINTY	6
3. GENERAL INFORMATION	7
3.1 GENERAL DESCRIPTION OF EUT	7
3.2 DESCRIPTION OF TEST MODES	8
3.2.1 TEST MODE APPLICABILITY AND TESTED CHANNEL DETAIL.....	9
3.3 DESCRIPTION OF SUPPORT UNITS	12
3.3.1 CONFIGURATION OF SYSTEM UNDER TEST.....	12
3.4 GENERAL DESCRIPTION OF APPLIED STANDARDS.....	13
4. TEST TYPES AND RESULTS	14
4.1 RADIATED EMISSION AND BANDEDGE MEASUREMENT	14
4.1.1 LIMITS OF RADIATED EMISSION AND BANDEDGE MEASUREMENT	14
4.1.2 TEST INSTRUMENTS.....	15
4.1.3 TEST PROCEDURES	16
4.1.4 DEVIATION FROM TEST STANDARD.....	16
4.1.5 TEST SETUP.....	17
4.1.6 EUT OPERATING CONDITIONS	17
4.1.7 TEST RESULTS	18
4.2 CONDUCTED EMISSION MEASUREMENT.....	25
4.2.1 LIMITS OF CONDUCTED EMISSION MEASUREMENT	25
4.2.2 TEST INSTRUMENTS.....	25
4.2.3 TEST PROCEDURES	26
4.2.4 DEVIATION FROM TEST STANDARD.....	26
4.2.5 TEST SETUP.....	27
4.2.6 EUT OPERATING CONDITIONS	27
4.2.7 TEST RESULTS	28
4.3 NUMBER OF HOPPING FREQUENCY USED.....	30
4.3.1 LIMIT OF HOPPING FREQUENCY USED	30
4.3.2 TEST SETUP.....	30
4.3.3 TEST INSTRUMENTS.....	30
4.3.4 TEST PROCEDURES	30
4.3.5 DEVIATION FROM TEST STANDARD.....	30
4.3.6 TEST RESULTS	30
4.4 DWELL TIME ON EACH CHANNEL.....	32
4.4.1 LIMIT OF DWELL TIME USED	32
4.4.2 TEST SETUP.....	32
4.4.3 TEST INSTRUMENTS.....	32
4.4.4 TEST PROCEDURES	32
4.4.5 DEVIATION FROM TEST STANDARD.....	32
4.4.6 TEST RESULTS	33
4.5 CHANNEL BANDWIDTH	35
4.5.1 LIMITS OF CHANNEL BANDWIDTH.....	35
4.5.2 TEST SETUP.....	35
4.5.3 TEST INSTRUMENTS.....	35
4.5.4 TEST PROCEDURE	35
4.5.5 DEVIATION FROM TEST STANDARD.....	35
4.5.6 EUT OPERATING CONDITION.....	35
4.5.7 TEST RESULTS	36



A D T

4.6	HOPPING CHANNEL SEPARATION	37
4.6.1	LIMIT OF HOPPING CHANNEL SEPARATION	37
4.6.2	TEST SETUP	37
4.6.3	TEST INSTRUMENTS	37
4.6.4	TEST PROCEDURES	37
4.6.5	DEVIATION FROM TEST STANDARD	37
4.6.6	TEST RESULTS	38
4.7	MAXIMUM OUTPUT POWER	39
4.7.1	LIMITS OF MAXIMUM OUTPUT POWER MEASUREMENT	39
4.7.2	TEST SETUP	39
4.7.3	TEST INSTRUMENTS	39
4.7.4	TEST PROCEDURES	39
4.7.5	DEVIATION FROM TEST STANDARD	39
4.7.6	EUT OPERATING CONDITION	39
4.7.7	TEST RESULTS	40
4.8	CONDUCTED OUT OF BAND EMISSION MEASUREMENT	41
4.8.1	LIMITS OF CONDUCTED OUT OF BAND EMISSION MEASUREMENT	41
4.8.2	TEST INSTRUMENTS	41
4.8.3	TEST PROCEDURE	41
4.8.4	DEVIATION FROM TEST STANDARD	41
4.8.5	EUT OPERATING CONDITION	41
4.8.6	TEST RESULTS	41
5.	PHOTOGRAPHS OF THE TEST CONFIGURATION	44
6.	INFORMATION ON THE TESTING LABORATORIES	45
7.	APPENDIX A - MODIFICATIONS RECORDERS FOR ENGINEERING CHANGES TO THE EUT BY THE LAB	46



A D T

RELEASE CONTROL RECORD

ISSUE NO.	REASON FOR CHANGE	DATE ISSUED
RF130614D02-3	Original release	Aug. 2, 2013



1. CERTIFICATION

PRODUCT: 802.11a/b/g/n +Bluetooth 4.0(HS) 1T1R SDIO Module
BRAND NAME: TPV
MODEL NO.: WSDB-675GN
APPLICANT: TOP VICTORY ELECTRONICS (TAIWAN) CO., LTD.
TESTED: Jun. 21 ~ Jul. 15, 2013
TEST SAMPLE: R&D SAMPLE
STANDARDS: **FCC Part 15, Subpart C (Section 15.247)**
ANSI C63.10-2009

The above equipment has been tested by **Bureau Veritas Consumer Products Services (H.K.) Ltd., Taoyuan Branch**, and found compliance with the requirement of the above standards. The test record, data evaluation & Equipment Under Test (EUT) configurations represented herein are true and accurate accounts of the measurements of the sample's EMC characteristics under the conditions specified in this report.

PREPARED BY : Annie Chang , **DATE:** Aug. 2, 2013
(Annie Chang / Supervisor)

APPROVED BY : Ken Liu , **DATE:** Aug. 2, 2013
(Ken Liu / Senior Manager)

2. SUMMARY OF TEST RESULTS

The EUT has been tested according to the following specifications:

APPLIED STANDARD: FCC Part 15, Subpart C			
STANDARD SECTION	TEST TYPE AND LIMIT	RESULT	REMARK
15.207	AC Power Conducted Emission	PASS	Meet the requirement of limit. Minimum passing margin is -7.02dB at 16.89523MHz.
15.247(a)(1) (iii)	Number of Hopping Frequency Used	PASS	Meet the requirement of limit.
15.247(a)(1) (iii)	Dwell Time on Each Channel	PASS	Meet the requirement of limit.
15.247(a)(1)	1. Hopping Channel Separation 2. Spectrum Bandwidth of a Frequency Hopping Sequence Spread Spectrum System	PASS	Meet the requirement of limit.
15.247(b)	Maximum Peak Output Power	PASS	Meet the requirement of limit.
15.247(d)	Transmitter Radiated Emissions	PASS	Meet the requirement of limit. Minimum passing margin is -5.1dB at 2400.00MHz.
15.247(d)	Band Edge Measurement	PASS	Meet the requirement of limit.
15.203	Antenna Requirement	PASS	Antenna connector is I-PEX not a standard connector.

NOTE: If The Frequency Hopping System operating in 2400-2483.5MHz band and the output power less than 125mW. The hopping channel carrier frequencies separated by a minimum of 25kHz or two-thirds of the 20dB bandwidth of hopping channel whichever is greater.

2.1 MEASUREMENT UNCERTAINTY

Where relevant, the following measurement uncertainty levels have been estimated for tests performed on the EUT as specified in CISPR 16-4-2:

This uncertainty represents an expanded uncertainty expressed at approximately the 95% confidence level using a coverage factor of k=2.

MEASUREMENT	FREQUENCY	UNCERTAINTY
Conducted emissions	150kHz ~ 30MHz	2.41 dB
Radiated emissions	30MHz ~ 1GHz	4.30 dB
	Above 1GHz	3.36 dB

3. GENERAL INFORMATION

3.1 GENERAL DESCRIPTION OF EUT

EUT	802.11a/b/g/n +Bluetooth 4.0(HS) 1T1R SDIO Module
MODEL NO.	WSDB-675GN
POWER SUPPLY	5.0Vdc from host equipment
MODULATION TYPE	GFSK, $\pi/4$ -DQPSK, 8DPSK
MODULATION TECHNOLOGY	FHSS
TRANSFER RATE	1/2/3Mbps
OPERATING FREQUENCY	2402 ~ 2480MHz
NUMBER OF CHANNEL	79
MAX. OUTPUT POWER	28.7mW
ANTENNA TYPE	PIFA antenna with 1.52dBi gain
ANTENNA CONNECTOR	I-PEX connector
I/O PORTS	N/A
DATA CABLE	N/A
ACCESSORY DEVICES	N/A

NOTE:

1. The EUT is a 802.11a/b/g/n +Bluetooth 4.0(HS) 1T1R SDIO Module.
2. The above EUT information is declared by manufacturer and for more detailed features description, please refer to the manufacturer's specifications or User's Manual.



3.2 DESCRIPTION OF TEST MODES

79 channels are provided to this EUT:

CHANNEL	FREQ. (MHz)	CHANNEL	FREQ. (MHz)	CHANNEL	FREQ. (MHz)	CHANNEL	FREQ. (MHz)
0	2402	20	2422	40	2442	60	2462
1	2403	21	2423	41	2443	61	2463
2	2404	22	2424	42	2444	62	2464
3	2405	23	2425	43	2445	63	2465
4	2406	24	2426	44	2446	64	2466
5	2407	25	2427	45	2447	65	2467
6	2408	26	2428	46	2448	66	2468
7	2409	27	2429	47	2449	67	2469
8	2410	28	2430	48	2450	68	2470
9	2411	29	2431	49	2451	69	2471
10	2412	30	2432	50	2452	70	2472
11	2413	31	2433	51	2453	71	2473
12	2414	32	2434	52	2454	72	2474
13	2415	33	2435	53	2455	73	2475
14	2416	34	2436	54	2456	74	2476
15	2417	35	2437	55	2457	75	2477
16	2418	36	2438	56	2458	76	2478
17	2419	37	2439	57	2459	77	2479
18	2420	38	2440	58	2460	78	2480
19	2421	39	2441	59	2461		



3.2.1 TEST MODE APPLICABILITY AND TESTED CHANNEL DETAIL

EUT CONFIGURE MODE	APPLICABLE TO					DESCRIPTION
	RE≥1G	RE<1G	PLC	APCM	OB	
-	√	√	√	√	√	-

Where **RE≥1G**: Radiated Emission above 1GHz **RE<1G**: Radiated Emission below 1GHz
PLC: Power Line Conducted Emission **APCM**: Antenna Port Conducted Measurement
OB: Conducted Out-Band Emission Measurement

NOTE: The EUT had been pre-tested on the positioned of each 3 axis. The worst case was found when positioned on Z-plane.

RADIATED EMISSION TEST (ABOVE 1 GHz):

- Pre-Scan has been conducted to determine the worst-case mode from all possible combinations between available modulations, antenna ports (if EUT with antenna diversity architecture) and packet type.
- Following channel(s) was (were) selected for the final test as listed below.

EUT CONFIGURE MODE	AVAILABLE CHANNEL	TESTED CHANNEL	MODULATION TECHNOLOGY	MODULATION TYPE	PACKET TYPE
-	0 to 78	0, 39, 78	FHSS	GFSK	DH5
	0 to 78	0, 39, 78	FHSS	8DPSK	DH5

RADIATED EMISSION TEST (BELOW 1 GHz):

- Pre-Scan has been conducted to determine the worst-case mode from all possible combinations between available modulations, antenna ports (if EUT with antenna diversity architecture) and packet type.
- Following channel(s) was (were) selected for the final test as listed below.

EUT CONFIGURE MODE	AVAILABLE CHANNEL	TESTED CHANNEL	MODULATION TECHNOLOGY	MODULATION TYPE	PACKET TYPE
-	0 to 78	39	FHSS	GFSK	DH5



POWER LINE CONDUCTED EMISSION TEST:

- Pre-Scan has been conducted to determine the worst-case mode from all possible combinations between available modulations, antenna ports (if EUT with antenna diversity architecture), and packet types.
- Following channel(s) was (were) selected for the final test as listed below.

EUT CONFIGURE MODE	AVAILABLE CHANNEL	TESTED CHANNEL	MODULATION TECHNOLOGY	MODULATION TYPE	PACKET TYPE
-	0 to 78	39	FHSS	GFSK	DH5

CONDUCTED OUT-BAND EMISSION MEASUREMENT:

- Pre-Scan has been conducted to determine the worst-case mode from all possible combinations between available modulations, antenna ports (if EUT with antenna diversity architecture), and packet types.
- Following channel(s) was (were) selected for the final test as listed below.

EUT CONFIGURE MODE	AVAILABLE CHANNEL	TESTED CHANNEL	MODULATION TECHNOLOGY	MODULATION TYPE	PACKET TYPE
-	0 to 78	0, 78	FHSS	GFSK	DH5
	0 to 78	0, 78	FHSS	8DPSK	DH5

ANTENNA PORT CONDUCTED MEASUREMENT:

- This item includes all test value of each mode, but only includes spectrum plot of worst value of each mode.
- Pre-Scan has been conducted to determine the worst-case mode from all possible combinations between available modulations, antenna ports (if EUT with antenna diversity architecture), and packet types.
- Following channel(s) was (were) selected for the final test as listed below.

EUT CONFIGURE MODE	AVAILABLE CHANNEL	TESTED CHANNEL	MODULATION TECHNOLOGY	MODULATION TYPE	PACKET TYPE
-	0 to 78	0, 39, 78	FHSS	GFSK	DH5
	0 to 78	0, 39, 78	FHSS	8DPSK	DH5



A D T

TEST CONDITION:

APPLICABLE TO	ENVIRONMENTAL CONDITIONS	INPUT POWER (SYSTEM)	TESTED BY
RE \geq 1G	27deg. C, 76% RH	120Vac, 60Hz	Saxon Lee
RE<1G	27deg. C, 76% RH	120Vac, 60Hz	Saxon Lee
PLC	25deg. C, 75% RH	120Vac, 60Hz	Dalen Dai
OB	23deg. C, 80% RH	120Vac, 60Hz	Chad Lee
APCM	23deg. C, 80% RH	120Vac, 60Hz	Chad Lee

3.3 DESCRIPTION OF SUPPORT UNITS

The EUT has been tested as an independent unit together with other necessary accessories or support units. The following support units or accessories were used to form a representative test configuration during the tests.

NO.	PRODUCT	BRAND	MODEL NO.	SERIAL NO.	FCC ID
1	PERSONAL COMPUTER	ASUS	P5KPL	N/A	FCC DoC Approved
2	LCD MONITOR	DELL	U2410	CN082WXD728 720CC0LGL	FCC DoC Approved
3	USB KEYBOARD	BTC	5200U	G09302046358	E5XKB5122U
4	USB Mouse	Microsoft	1113	9170515772221	FCC DoC Approved

NO.	SIGNAL CABLE DESCRIPTION OF THE ABOVE SUPPORT UNITS
1	1.0m shielded USB cable x2 (Provided by client)
2	1.8m braid shielded wire, terminated with VGA connector via metallic frame, w/. 2 cores
3	1.5 m braid shielded wire, terminated with USB connector via drain wire, w/o core.
4	1.5 m braid shielded wire, terminated with USB connector via drain wire, w/. 1 core.

NOTE: 1. All power cords of the above support units are non shielded (1.8m).
2. The support unit 1 was provided by client.

3.3.1 CONFIGURATION OF SYSTEM UNDER TEST

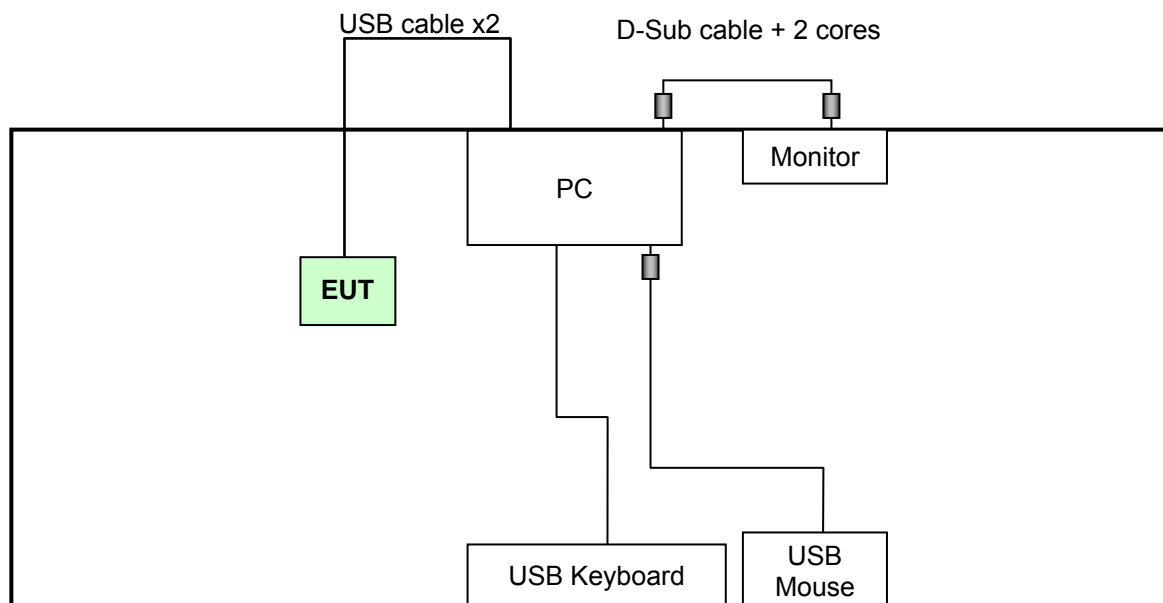



3.4 GENERAL DESCRIPTION OF APPLIED STANDARDS

The EUT is a RF Product. According to the specifications of the manufacturer, it must comply with the requirements of the following standards:

FCC Part 15, Subpart C. (15.247)

ANSI C63.10-2009

All test items have been performed and recorded as per the above standards.

NOTE: The product has been verified to comply with the requirements of FCC Part 15, Subpart B, Class B (DoC). The test report has been issued separately.

4. TEST TYPES AND RESULTS

4.1 RADIATED EMISSION AND BANDEDGE MEASUREMENT

4.1.1 LIMITS OF RADIATED EMISSION AND BANDEDGE MEASUREMENT

Radiated emissions which fall in the restricted bands must comply with the radiated emission limits specified as below table. Other emissions shall be at least 20dB below the highest level of the desired power:

FREQUENCIES (MHz)	FIELD STRENGTH (microvolts/meter)	MEASUREMENT DISTANCE (meters)
0.009 ~ 0.490	2400/F(kHz)	300
0.490 ~ 1.705	24000/F(kHz)	30
1.705 ~ 30.0	30	30
30 ~ 88	100	3
88 ~ 216	150	3
216 ~ 960	200	3
Above 960	500	3

NOTE:

1. The lower limit shall apply at the transition frequencies.
2. Emission level (dBuV/m) = 20 log Emission level (uV/m).
3. For frequencies above 1000MHz, the field strength limits are based on average detector, however, the peak field strength of any emission shall not exceed the maximum permitted average limits, specified above by more than 20dB under any condition of modulation.



4.1.2 TEST INSTRUMENTS

DESCRIPTION & MANUFACTURER	MODEL NO.	SERIAL NO.	CALIBRATED DATE	CALIBRATED UNTIL
HP Preamplifier	8447D	2432A03504	Feb. 26, 2013	Feb. 25, 2014
HP Preamplifier	8449B	3008A01201	Feb. 26, 2013	Feb. 25, 2014
Agilent TEST RECEIVER	N9038A	MY51210129	Jan. 03, 2013	Jan. 02, 2014
Agilent Spectrum Analyzer	E4446A	MY46180403	Jun. 13, 2013	Jun. 12, 2014
Schwarzbeck Antenna	VULB 9168	137	Mar. 20, 2013	Mar. 19, 2014
Schwarzbeck Antenna	VHBA 9123	480	May 29, 2013	May 28, 2014
ADT. Turn Table	TT100	0306	NA	NA
ADT. Tower	AT100	0306	NA	NA
Software	ADT_Radiated_V 7.6.15.9.2	NA	NA	NA
SUHNER RF cable	SF102	CABLE-CH6	Aug. 19, 2012	Aug. 18, 2013
Schwarzbeck Horn Antenna	BBHA 9120-D1	D130	May 13, 2013	May 12, 2014
Highpass filter Wainwright Instruments	WHK 3.1/18G-10SS	SN 8	NA	NA
ROHDE & SCHWARZ Spectrum Analyzer	FSP 40	100036	May. 17, 2013	May. 16, 2014
Anritsu Power Sensor	MA2411B	0738404	Apr. 24, 2013	Apr. 23, 2014
Anritsu Power Meter	ML2495A	0842014	Apr. 25, 2013	Apr. 24, 2014

- NOTE:**
1. The calibration interval of the above test instruments is 12/24 months. And the calibrations are traceable to NML/ROC and NIST/USA.
 2. The horn antenna and HP preamplifier (model: 8449B) are used only for the measurement of emission frequency above 1GHz if tested.
 3. The test was performed in Chamber No. 6.
 4. The Industry Canada Reference No. IC 7450E-6.
 5. The FCC Site Registration No. is 447212.

4.1.3 TEST PROCEDURES

- a. The EUT was placed on the top of a rotating table 0.8 meters above the ground at a 3 meter semi-anechoic chamber. The table was rotated 360 degrees to determine the position of the highest radiation.
- b. The EUT was set 3 meters away from the interference-receiving antenna, which was mounted on the top of a variable-height antenna tower.
- c. The height is varied from one meter to four meters above the ground to determine the maximum value of the field strength. Both horizontal and vertical polarizations of the antenna are set to make the measurement.
- d. For each suspected emission, the EUT was arranged to its worst case and then the antenna was tuned to heights from 1 meter to 4 meters and the rotatable table was turned from 0 degrees to 360 degrees to find the maximum reading.
- e. The test-receiver system was set to Peak Detect Function and Specified Bandwidth with Maximum Hold Mode.
- f. If the emission level of the EUT in peak mode was lower than the limit specified, then testing could be stopped and the peak values of the EUT would be reported. Otherwise the emissions would be re-tested one by one using peak, quasi-peak or average method as specified and then reported in a data sheet.

NOTE:

1. The resolution bandwidth and video bandwidth of test receiver/spectrum analyzer is 120kHz for Quasi-peak detection at frequency below 1GHz.
2. The resolution bandwidth of test receiver/spectrum analyzer is 1 MHz and video bandwidth is 3MHz for Peak detection at frequency above 1GHz.
3. All modes of operation were investigated and the worst-case emissions are reported.

4.1.4 DEVIATION FROM TEST STANDARD

No deviation.

4.1.5 TEST SETUP

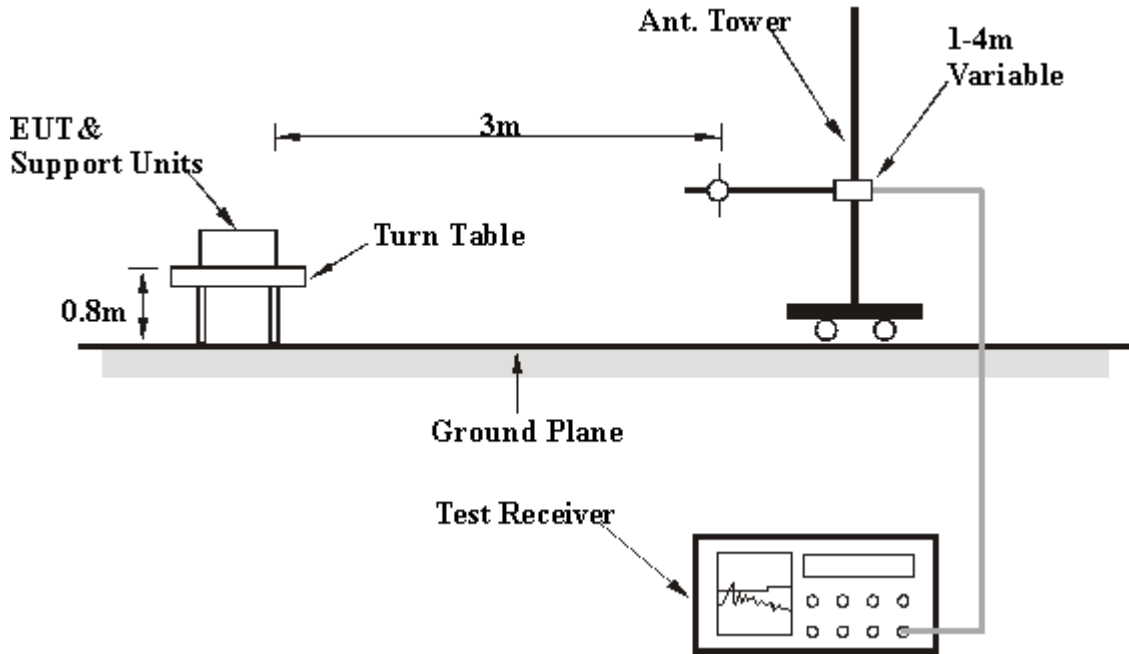

For the actual test configuration, please refer to the attached file (Test Setup Photo).

4.1.6 EUT OPERATING CONDITIONS

Set the EUT under transmission/receiving condition continuously at specific channel frequency and charging condition.

4.1.7 TEST RESULTS

ABOVE 1GHz DATA

BT_GFSK

CHANNEL	TX Channel 0	DETECTOR FUNCTION	Peak (PK)
FREQUENCY RANGE	1GHz ~ 25GHz		Average (AV)

ANTENNA POLARITY & TEST DISTANCE: HORIZONTAL AT 3 M								
NO.	FREQ. (MHz)	EMISSION LEVEL (dBuV/m)	LIMIT (dBuV/m)	MARGIN (dB)	ANTENNA HEIGHT (m)	TABLE ANGLE (Degree)	RAW VALUE (dBuV)	CORRECTION FACTOR (dB/m)
1	2390.00	46.1 PK	74.0	-27.9	1.00 H	24	49.87	-3.75
2	2390.00	32.3 AV	54.0	-21.7	1.00 H	24	36.01	-3.75
3	2400.00	52.7 PK	74.0	-21.3	1.00 H	24	56.35	-3.70
4	2400.00	41.2 AV	54.0	-12.8	1.00 H	24	44.86	-3.70
5	*2402.00	91.4 PK			1.00 H	24	95.10	-3.69
6	*2402.00	50.9 AV			1.00 H	24	54.57	-3.69
7	4804.00	44.7 PK	74.0	-29.3	1.00 H	141	40.96	3.70
8	4804.00	31.5 AV	54.0	-22.5	1.00 H	141	27.80	3.70
ANTENNA POLARITY & TEST DISTANCE: VERTICAL AT 3 M								
NO.	FREQ. (MHz)	EMISSION LEVEL (dBuV/m)	LIMIT (dBuV/m)	MARGIN (dB)	ANTENNA HEIGHT (m)	TABLE ANGLE (Degree)	RAW VALUE (dBuV)	CORRECTION FACTOR (dB/m)
1	2390.00	46.0 PK	74.0	-28.0	1.00 V	331	49.72	-3.75
2	2390.00	32.3 AV	54.0	-21.7	1.00 V	331	36.06	-3.75
3	2400.00	51.7 PK	74.0	-22.3	1.00 V	331	55.35	-3.70
4	2400.00	41.2 AV	54.0	-12.8	1.00 V	331	44.92	-3.70
5	*2402.00	91.7 PK			1.00 V	331	95.41	-3.69
6	*2402.00	51.3 AV			1.00 V	331	54.94	-3.69
7	4804.00	46.7 PK	74.0	-27.3	1.06 V	175	42.98	3.70
8	4804.00	37.8 AV	54.0	-16.2	1.06 V	175	34.13	3.70

REMARKS:

1. Emission Level(dBuV/m) = Raw Value(dBuV) + Correction Factor(dB/m)
2. Correction Factor(dB/m) = Antenna Factor(dB/m) + Cable Factor(dB) – Pre-Amplifier Factor(dB)
3. The other emission levels were very low against the limit.
4. Margin value = Emission Level – Limit value
5. " * ": Fundamental frequency.



A D T

CHANNEL	TX Channel 39	DETECTOR FUNCTION	Peak (PK)
FREQUENCY RANGE	1GHz ~ 25GHz		Average (AV)

ANTENNA POLARITY & TEST DISTANCE: HORIZONTAL AT 3 M

NO.	FREQ. (MHz)	EMISSION LEVEL (dBuV/m)	LIMIT (dBuV/m)	MARGIN (dB)	ANTENNA HEIGHT (m)	TABLE ANGLE (Degree)	RAW VALUE (dBuV)	CORRECTION FACTOR (dB/m)
1	*2441.00	90.0 PK			1.00 H	21	93.53	-3.51
2	*2441.00	49.5 AV			1.00 H	21	52.98	-3.51
3	4882.00	44.6 PK	74.0	-29.4	1.01 H	135	40.87	3.76
4	4882.00	31.4 AV	54.0	-22.6	1.01 H	135	27.65	3.76

ANTENNA POLARITY & TEST DISTANCE: VERTICAL AT 3 M

NO.	FREQ. (MHz)	EMISSION LEVEL (dBuV/m)	LIMIT (dBuV/m)	MARGIN (dB)	ANTENNA HEIGHT (m)	TABLE ANGLE (Degree)	RAW VALUE (dBuV)	CORRECTION FACTOR (dB/m)
1	*2441.00	91.8 PK			1.01 V	326	95.28	-3.51
2	*2441.00	50.9 AV			1.01 V	326	54.43	-3.51
3	4882.00	46.6 PK	74.0	-27.5	1.05 V	178	42.79	3.76
4	4882.00	37.7 AV	54.0	-16.3	1.05 V	178	33.98	3.76

REMARKS:

1. Emission Level(dBuV/m) = Raw Value(dBuV) + Correction Factor(dB/m)
2. Correction Factor(dB/m) = Antenna Factor(dB/m) + Cable Factor(dB) – Pre-Amplifier Factor(dB)
3. The other emission levels were very low against the limit.
4. Margin value = Emission Level – Limit value
5. " * " : Fundamental frequency.



A D T

CHANNEL	TX Channel 78	DETECTOR FUNCTION	Peak (PK)
FREQUENCY RANGE	1GHz ~ 25GHz		Average (AV)

ANTENNA POLARITY & TEST DISTANCE: HORIZONTAL AT 3 M								
NO.	FREQ. (MHz)	EMISSION LEVEL (dBuV/m)	LIMIT (dBuV/m)	MARGIN (dB)	ANTENNA HEIGHT (m)	TABLE ANGLE (Degree)	RAW VALUE (dBuV)	CORRECTION FACTOR (dB/m)
1	*2480.00	90.4 PK			1.02 H	56	93.77	-3.33
2	*2480.00	49.9 AV			1.02 H	56	53.22	-3.33
3	2483.50	46.7 PK	74.0	-27.3	1.02 H	56	50.02	-3.32
4	2483.50	33.0 AV	54.0	-21.0	1.02 H	56	36.34	-3.32
5	4960.00	44.6 PK	74.0	-29.4	1.02 H	150	40.94	3.70
6	4960.00	31.5 AV	54.0	-22.5	1.02 H	150	27.83	3.70
ANTENNA POLARITY & TEST DISTANCE: VERTICAL AT 3 M								
NO.	FREQ. (MHz)	EMISSION LEVEL (dBuV/m)	LIMIT (dBuV/m)	MARGIN (dB)	ANTENNA HEIGHT (m)	TABLE ANGLE (Degree)	RAW VALUE (dBuV)	CORRECTION FACTOR (dB/m)
1	*2480.00	92.5 PK			1.00 V	325	95.79	-3.33
2	*2480.00	51.3 AV			1.00 V	325	54.59	-3.33
3	2483.50	46.6 PK	74.0	-27.4	1.00 V	325	49.89	-3.32
4	2483.50	32.9 AV	54.0	-21.1	1.00 V	325	36.23	-3.32
5	4960.00	46.6 PK	74.0	-27.4	1.05 V	181	42.88	3.70
6	4960.00	38.0 AV	54.0	-16.0	1.05 V	181	34.26	3.70

REMARKS:

1. Emission Level(dBuV/m) = Raw Value(dBuV) + Correction Factor(dB/m)
2. Correction Factor(dB/m) = Antenna Factor(dB/m) + Cable Factor(dB) – Pre-Amplifier Factor(dB)
3. The other emission levels were very low against the limit.
4. Margin value = Emission Level – Limit value
5. " * ": Fundamental frequency.



A D T

BT_8DPSK

CHANNEL	TX Channel 0	DETECTOR FUNCTION	Peak (PK)
FREQUENCY RANGE	1GHz ~ 25GHz		Average (AV)

ANTENNA POLARITY & TEST DISTANCE: HORIZONTAL AT 3 M								
NO.	FREQ. (MHz)	EMISSION LEVEL (dBuV/m)	LIMIT (dBuV/m)	MARGIN (dB)	ANTENNA HEIGHT (m)	TABLE ANGLE (Degree)	RAW VALUE (dBuV)	CORRECTION FACTOR (dB/m)
1	2390.00	46.0 PK	74.0	-28.0	1.00 H	24	49.73	-3.75
2	2390.00	35.0 AV	54.0	-19.0	1.00 H	24	38.72	-3.75
3	2400.00	60.2 PK	74.0	-13.8	1.00 H	24	63.92	-3.70
4	2400.00	48.1 AV	54.0	-5.9	1.00 H	24	51.76	-3.70
5	*2402.00	92.3 PK			1.00 H	24	95.96	-3.69
6	*2402.00	48.2 AV			1.00 H	24	51.93	-3.69
7	4804.00	44.6 PK	74.0	-29.5	1.02 H	134	40.85	3.70
8	4804.00	31.4 AV	54.0	-22.6	1.02 H	134	27.74	3.70

ANTENNA POLARITY & TEST DISTANCE: VERTICAL AT 3 M								
NO.	FREQ. (MHz)	EMISSION LEVEL (dBuV/m)	LIMIT (dBuV/m)	MARGIN (dB)	ANTENNA HEIGHT (m)	TABLE ANGLE (Degree)	RAW VALUE (dBuV)	CORRECTION FACTOR (dB/m)
1	2390.00	46.5 PK	74.0	-27.5	1.00 V	329	50.23	-3.75
2	2390.00	32.3 AV	54.0	-21.7	1.00 V	329	36.04	-3.75
3	2400.00	60.8 PK	74.0	-13.2	1.00 V	329	64.49	-3.70
4	2400.00	48.9 AV	54.0	-5.1	1.00 V	329	52.57	-3.70
5	*2402.00	92.1 PK			1.00 V	329	95.83	-3.69
6	*2402.00	48.0 AV			1.00 V	329	51.65	-3.69
7	4804.00	46.5 PK	74.0	-27.5	1.03 V	182	42.77	3.70
8	4804.00	37.8 AV	54.0	-16.2	1.03 V	182	34.08	3.70

REMARKS:

1. Emission Level(dBuV/m) = Raw Value(dBuV) + Correction Factor(dB/m)
2. Correction Factor(dB/m) = Antenna Factor(dB/m) + Cable Factor(dB) – Pre-Amplifier Factor(dB)
3. The other emission levels were very low against the limit.
4. Margin value = Emission Level – Limit value
5. " * ": Fundamental frequency.
6. " # ": The radiated frequency is out of the restricted band.



A D T

CHANNEL	TX Channel 39	DETECTOR FUNCTION	Peak (PK)
FREQUENCY RANGE	1GHz ~ 25GHz		Average (AV)

ANTENNA POLARITY & TEST DISTANCE: HORIZONTAL AT 3 M

NO.	FREQ. (MHz)	EMISSION LEVEL (dBuV/m)	LIMIT (dBuV/m)	MARGIN (dB)	ANTENNA HEIGHT (m)	TABLE ANGLE (Degree)	RAW VALUE (dBuV)	CORRECTION FACTOR (dB/m)
1	*2441.00	90.3 PK			1.01 H	25	93.78	-3.51
2	*2441.00	45.9 AV			1.01 H	25	49.45	-3.51
3	4882.00	44.4 PK	74.0	-29.6	1.02 H	138	40.67	3.76
4	4882.00	31.3 AV	54.0	-22.7	1.02 H	138	27.56	3.76

ANTENNA POLARITY & TEST DISTANCE: VERTICAL AT 3 M

NO.	FREQ. (MHz)	EMISSION LEVEL (dBuV/m)	LIMIT (dBuV/m)	MARGIN (dB)	ANTENNA HEIGHT (m)	TABLE ANGLE (Degree)	RAW VALUE (dBuV)	CORRECTION FACTOR (dB/m)
1	*2441.00	91.5 PK			1.00 V	327	95.03	-3.51
2	*2441.00	47.2 AV			1.00 V	327	50.69	-3.51
3	4882.00	46.5 PK	74.0	-27.6	1.03 V	178	42.69	3.76
4	4882.00	37.7 AV	54.0	-16.3	1.03 V	178	33.95	3.76

REMARKS:

1. Emission Level(dBuV/m) = Raw Value(dBuV) + Correction Factor(dB/m)
2. Correction Factor(dB/m) = Antenna Factor(dB/m) + Cable Factor(dB) – Pre-Amplifier Factor(dB)
3. The other emission levels were very low against the limit.
4. Margin value = Emission Level – Limit value
5. " * " : Fundamental frequency.



A D T

CHANNEL	TX Channel 78	DETECTOR FUNCTION	Peak (PK)
FREQUENCY RANGE	1GHz ~ 25GHz		Average (AV)

ANTENNA POLARITY & TEST DISTANCE: HORIZONTAL AT 3 M

NO.	FREQ. (MHz)	EMISSION LEVEL (dBuV/m)	LIMIT (dBuV/m)	MARGIN (dB)	ANTENNA HEIGHT (m)	TABLE ANGLE (Degree)	RAW VALUE (dBuV)	CORRECTION FACTOR (dB/m)
1	*2480.00	90.2 PK			1.02 H	56	93.49	-3.33
2	*2480.00	45.7 AV			1.02 H	56	49.05	-3.33
3	2483.50	46.6 PK	74.0	-27.5	1.02 H	56	49.87	-3.32
4	2483.50	33.0 AV	54.0	-21.0	1.02 H	56	36.34	-3.32
5	4960.00	44.5 PK	74.0	-29.5	1.03 H	141	40.81	3.70
6	4960.00	31.4 AV	54.0	-22.6	1.03 H	141	27.69	3.70

ANTENNA POLARITY & TEST DISTANCE: VERTICAL AT 3 M

NO.	FREQ. (MHz)	EMISSION LEVEL (dBuV/m)	LIMIT (dBuV/m)	MARGIN (dB)	ANTENNA HEIGHT (m)	TABLE ANGLE (Degree)	RAW VALUE (dBuV)	CORRECTION FACTOR (dB/m)
1	*2480.00	93.0 PK			1.01 V	295	96.31	-3.33
2	*2480.00	48.5 AV			1.01 V	295	51.86	-3.33
3	2483.50	45.9 PK	74.0	-28.1	1.01 V	295	49.26	-3.32
4	2483.50	33.2 AV	54.0	-20.8	1.01 V	295	36.48	-3.32
5	4960.00	46.4 PK	74.0	-27.6	1.04 V	190	42.71	3.70
6	4960.00	37.8 AV	54.0	-16.2	1.04 V	190	34.11	3.70

REMARKS:

1. Emission Level(dBuV/m) = Raw Value(dBuV) + Correction Factor(dB/m)
2. Correction Factor(dB/m) = Antenna Factor(dB/m) + Cable Factor(dB) – Pre-Amplifier Factor(dB)
3. The other emission levels were very low against the limit.
4. Margin value = Emission Level – Limit value
5. " * ": Fundamental frequency.

BELOW 1GHz WORST-CASE DATA

BT_GFSK

CHANNEL	TX Channel 39	DETECTOR FUNCTION	Quasi-Peak (QP)
FREQUENCY RANGE	30MHz ~ 1GHz		

ANTENNA POLARITY & TEST DISTANCE: HORIZONTAL AT 3 M

NO.	FREQ. (MHz)	EMISSION LEVEL (dBuV/m)	LIMIT (dBuV/m)	MARGIN (dB)	ANTENNA HEIGHT (m)	TABLE ANGLE (Degree)	RAW VALUE (dBuV)	CORRECTION FACTOR (dB/m)
1	67.83	33.0 QP	40.00	-7.0	1.34 H	145	48.42	-15.42
2	127.97	36.7 QP	43.50	-6.8	1.09 H	213	51.58	-14.87
3	299.66	38.4 QP	46.00	-7.6	1.67 H	88	49.89	-11.46
4	375.32	37.5 QP	46.00	-8.5	1.27 H	3	47.46	-9.95
5	499.48	33.3 QP	46.00	-12.7	1.33 H	336	40.68	-7.37
6	632.37	33.2 QP	46.00	-12.8	1.00 H	189	37.68	-4.52

ANTENNA POLARITY & TEST DISTANCE: VERTICAL AT 3 M

NO.	FREQ. (MHz)	EMISSION LEVEL (dBuV/m)	LIMIT (dBuV/m)	MARGIN (dB)	ANTENNA HEIGHT (m)	TABLE ANGLE (Degree)	RAW VALUE (dBuV)	CORRECTION FACTOR (dB/m)
1	67.83	32.9 QP	40.00	-7.1	1.07 V	157	48.34	-15.42
2	127.97	35.8 QP	43.50	-7.7	1.26 V	222	50.71	-14.87
3	299.66	36.1 QP	46.00	-9.9	1.13 V	83	47.54	-11.46
4	335.55	38.4 QP	46.00	-7.6	1.03 V	112	49.11	-10.67
5	408.32	38.8 QP	46.00	-7.2	1.10 V	9	48.29	-9.47
6	936.95	36.4 QP	46.00	-9.6	1.00 V	94	36.29	0.10

REMARKS:

1. Emission Level(dBuV/m) = Raw Value(dBuV) + Correction Factor(dB/m)
2. Correction Factor(dB/m) = Antenna Factor(dB/m) + Cable Factor(dB) – Pre-Amplifier Factor(dB)
3. The other emission levels were very low against the limit.
4. Margin value = Emission Level – Limit value

4.2 CONDUCTED EMISSION MEASUREMENT

4.2.1 LIMITS OF CONDUCTED EMISSION MEASUREMENT

FREQUENCY OF EMISSION (MHz)	CONDUCTED LIMIT (dB μ V)	
	Quasi-peak	Average
0.15 ~ 0.5	66 to 56	56 to 46
0.5 ~ 5	56	46
5 ~ 30	60	50

- NOTE:** 1. The lower limit shall apply at the transition frequencies.
 2. The limit decreases in line with the logarithm of the frequency in the range of 0.15 to 0.50MHz.

4.2.2 TEST INSTRUMENTS

DESCRIPTION & MANUFACTURER	MODEL NO.	SERIAL NO.	CALIBRATED DATE	CALIBRATED UNTIL
ROHDE & SCHWARZ TEST RECEIVER	ESCS 30	100276	Jan. 07, 2013	Jan. 06, 2014
ROHDE & SCHWARZ Artificial Mains Network (for EUT)	ESH3-Z5	100219	Nov. 28, 2012	Nov. 27, 2013
LISN With Adapter (for EUT)	AD10	C10Ada-001	Nov. 28, 2012	Nov. 27, 2013
ROHDE & SCHWARZ Artificial Mains Network (for peripherals)	ESH3-Z5	100218	Dec. 05, 2012	Dec. 04, 2013
Software	ADT_Cond_V7.3.7	NA	NA	NA
Software	ADT_ISN_V7.3.7	NA	NA	NA
RF cable (JYEBAO)	5D-FB	Cable-C10.01	Feb. 19, 2013	Feb. 18, 2014
SUHNER Terminator (For ROHDE & SCHWARZ LISN)	65BNC-5001	E1-010773	Feb. 06, 2013	Feb. 05, 2014

- NOTE:** 1. The calibration interval of the above test instruments is 12 months and the calibrations are traceable to NML/ROC and NIST/USA.
 2. The test was performed in Shielded Room No. 10.
 3. The VCCI Site Registration No. C-1852.

4.2.3 TEST PROCEDURES

- a. The EUT was placed 0.4 meters from the conducting wall of the shielded room with EUT being connected to the power mains through a line impedance stabilization network (LISN). Other support units were connected to the power mains through another LISN. The two LISNs provide 50 ohm/ 50uH of coupling impedance for the measuring instrument.
- b. Both lines of the power mains connected to the EUT were checked for maximum conducted interference.
- c. The frequency range from 150kHz to 30MHz was searched. Emission levels under (Limit - 20dB) was not recorded.

NOTE: All modes of operation were investigated and the worst-case emissions are reported.

4.2.4 DEVIATION FROM TEST STANDARD

No deviation.

4.2.5 TEST SETUP

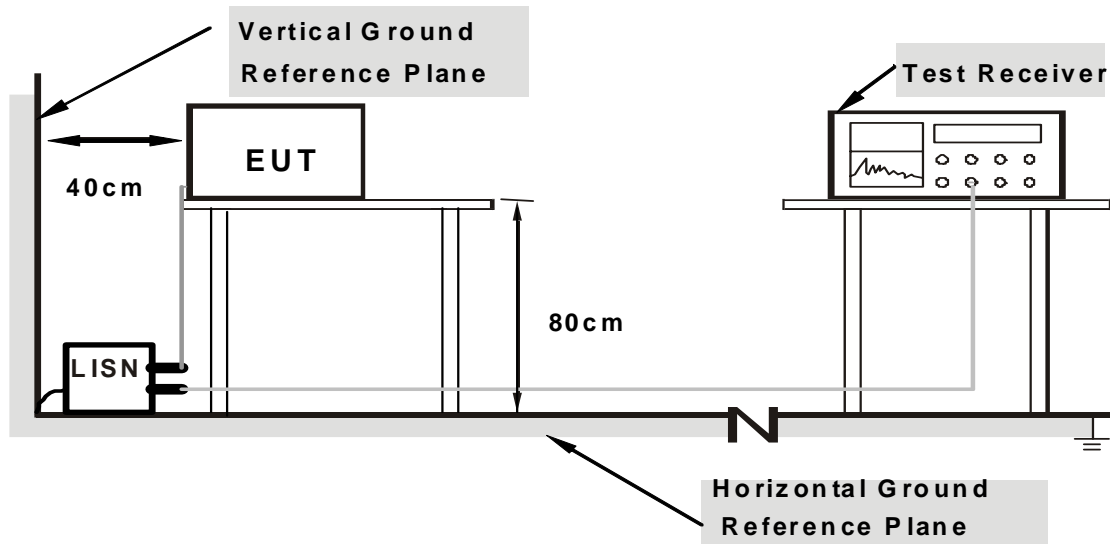

Note: Support units were connected to second LISN.

For the actual test configuration, please refer to the attached file (Test Setup Photo).

4.2.6 EUT OPERATING CONDITIONS

Same as item 4.1.6.

4.2.7 TEST RESULTS

CONDUCTED WORST-CASE DATA : 8DPSK

PHASE	Line 1	6dB BANDWIDTH	9kHz
--------------	--------	----------------------	------

No	Freq.	Corr. Factor	Reading Value		Emission Level		Limit		Margin	
	[MHz]		[dB (uV)]		[dB (uV)]		[dB (uV)]		(dB)	
			Q.P.	AV.	Q.P.	AV.	Q.P.	AV.	Q.P.	AV.
1	0.16825	0.14	39.09	36.72	39.23	36.86	65.05	55.05	-25.82	-18.19
2	0.19687	0.14	46.64	46.45	46.78	46.59	63.74	53.74	-16.96	-7.15
3	0.29453	0.15	31.92	30.80	32.07	30.95	60.40	50.40	-28.32	-19.44
4	13.82422	0.83	36.00	35.49	36.83	36.32	60.00	50.00	-23.17	-13.68
5	16.89523	1.00	43.09	41.98	44.09	42.98	60.00	50.00	-15.91	-7.02
6	19.96798	1.18	36.91	36.55	38.09	37.73	60.00	50.00	-21.91	-12.27

REMARKS:

1. Q.P. and AV. are abbreviations of quasi-peak and average individually.
2. The emission levels of other frequencies were very low against the limit.
3. Margin value = Emission Level – Limit value
4. Correction Factor = Insertion loss + Cable loss
5. Emission Level = Correction Factor + Reading Value

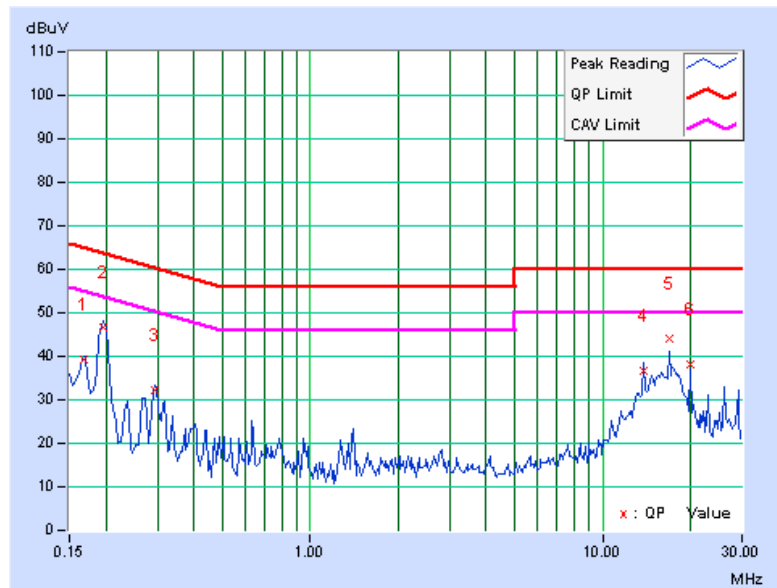

PHASE	Line 2	6dB BANDWIDTH	9kHz
--------------	--------	----------------------	------

No	Freq. [MHz]	Corr. Factor (dB)	Reading Value [dB (uV)]		Emission Level [dB (uV)]		Limit [dB (uV)]		Margin (dB)	
			Q.P.	AV.	Q.P.	AV.	Q.P.	AV.	Q.P.	AV.
			1	0.16767	0.11	44.14	40.38	44.25	40.49	65.08
2	0.19687	0.11	43.65	43.09	43.76	43.20	63.74	53.74	-19.98	-10.54
3	0.29844	0.12	32.31	27.79	32.43	27.91	60.29	50.29	-27.85	-22.37
4	13.82422	0.60	35.70	35.17	36.30	35.77	60.00	50.00	-23.70	-14.23
5	16.89581	0.70	42.50	41.52	43.20	42.22	60.00	50.00	-16.80	-7.78
6	19.96875	0.81	36.15	35.78	36.96	36.59	60.00	50.00	-23.04	-13.41

REMARKS:

1. Q.P. and AV. are abbreviations of quasi-peak and average individually.
2. The emission levels of other frequencies were very low against the limit.
3. Margin value = Emission Level – Limit value
4. Correction Factor = Insertion loss + Cable loss
5. Emission Level = Correction Factor + Reading Value

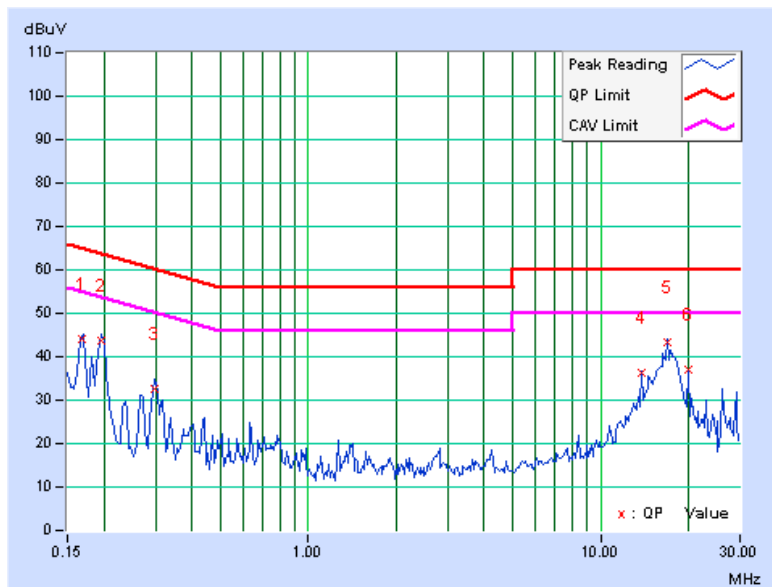

4.3 NUMBER OF HOPPING FREQUENCY USED

4.3.1 LIMIT OF HOPPING FREQUENCY USED

At least 15 channels frequencies, and should be equally spaced.

4.3.2 TEST SETUP

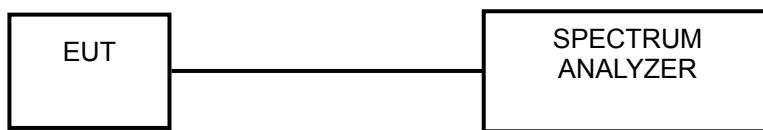

4.3.3 TEST INSTRUMENTS

Refer to section 4.1.2 to get information of above instrument.

4.3.4 TEST PROCEDURES

- a. Check the calibration of the measuring instrument (SA) using either an internal calibrator or a known signal from an external generator.
- b. Turn on the EUT and connect its antenna terminal to measurement via a low loss cable. Then set it to any one measured frequency within its operating range and make sure the instrument is operated in its linear range.
- c. Set the SA on MaxHold Mode, and then keep the EUT in hopping mode. Record all the signals from each channel until each one has been recorded.
- d. Set the SA on View mode and then plot the result on SA screen.
- e. Repeat above procedures until all frequencies measured were complete.

4.3.5 DEVIATION FROM TEST STANDARD

No deviation.

4.3.6 TEST RESULTS

There are 79 hopping frequencies in the hopping mode. Please refer to next two pages for the test result. On the plots, it shows that the hopping frequencies are equally spaced.



A D T

GFSK

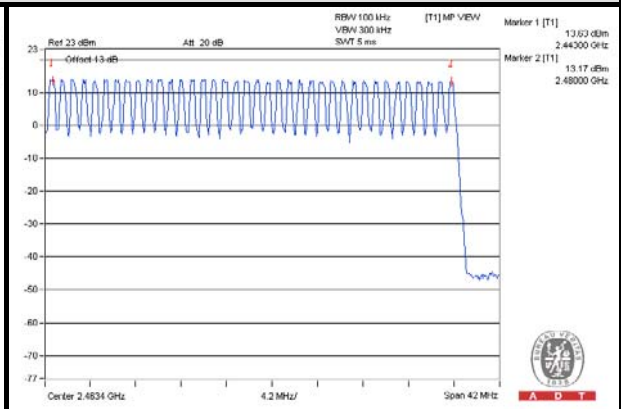
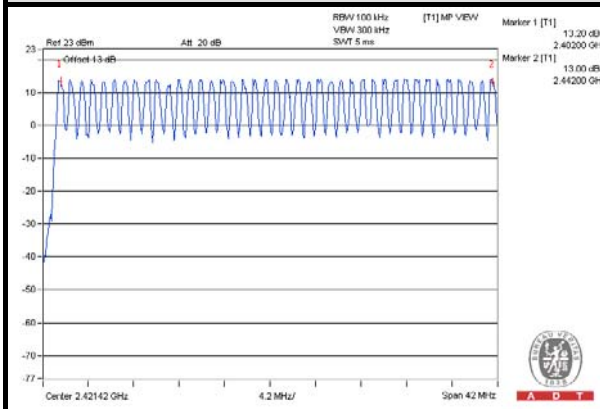

8DPSK

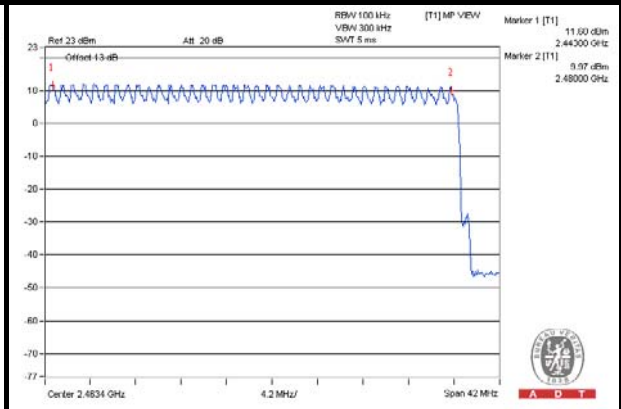
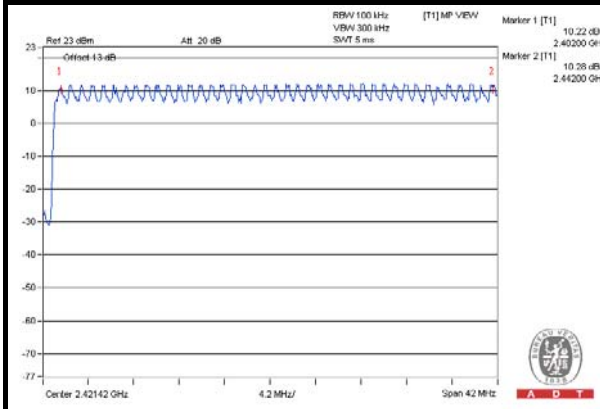

4.4 DWELL TIME ON EACH CHANNEL

4.4.1 LIMIT OF DWELL TIME USED

The average time of occupancy on any channel shall not be greater than 0.4 seconds within a period of 0.4 seconds multiplied by the number of hopping channels employed.

4.4.2 TEST SETUP

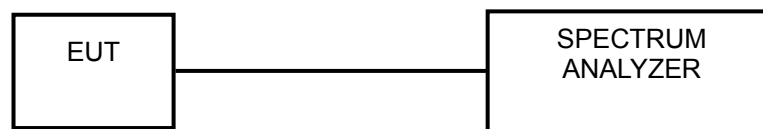

4.4.3 TEST INSTRUMENTS

Refer to section 4.1.2 to get information of above instrument.

4.4.4 TEST PROCEDURES

- a. Check the calibration of the measuring instrument (SA) using either an internal calibrator or a known signal from an external generator.
- b. Turn on the EUT and connect its antenna terminal to measurement via a low loss cable. Then set it to any one measured frequency within its operating range and make sure the instrument is operated in its linear range.
- c. Adjust the center frequency of SA on any frequency be measured and set SA to zero span mode. And then, set RBW and VBW of spectrum analyzer to proper value.
- d. Measure the time duration of one transmission on the measured frequency. And then plot the result with time difference of this time duration.
- e. Repeat above procedures until all different time-slot modes have been completed.

4.4.5 DEVIATION FROM TEST STANDARD

No deviation.



A D T

4.4.6 TEST RESULTS

GFSK

Mode	Number of transmission in a 31.6 (79Hopping*0.4)	Length of transmission time (msec)	Result (msec)	Limit (msec)
DH1	50 (times / 5 sec) * 6.32 = 316.00times	0.456	144.1	400
DH3	27 (times / 5 sec) * 6.32 = 170.64 times	1.674	285.7	400
DH5	18 (times / 5 sec) * 6.32 = 113.76 times	2.960	336.7	400

NOTE: Test plots of the transmitting time slot are shown as below.

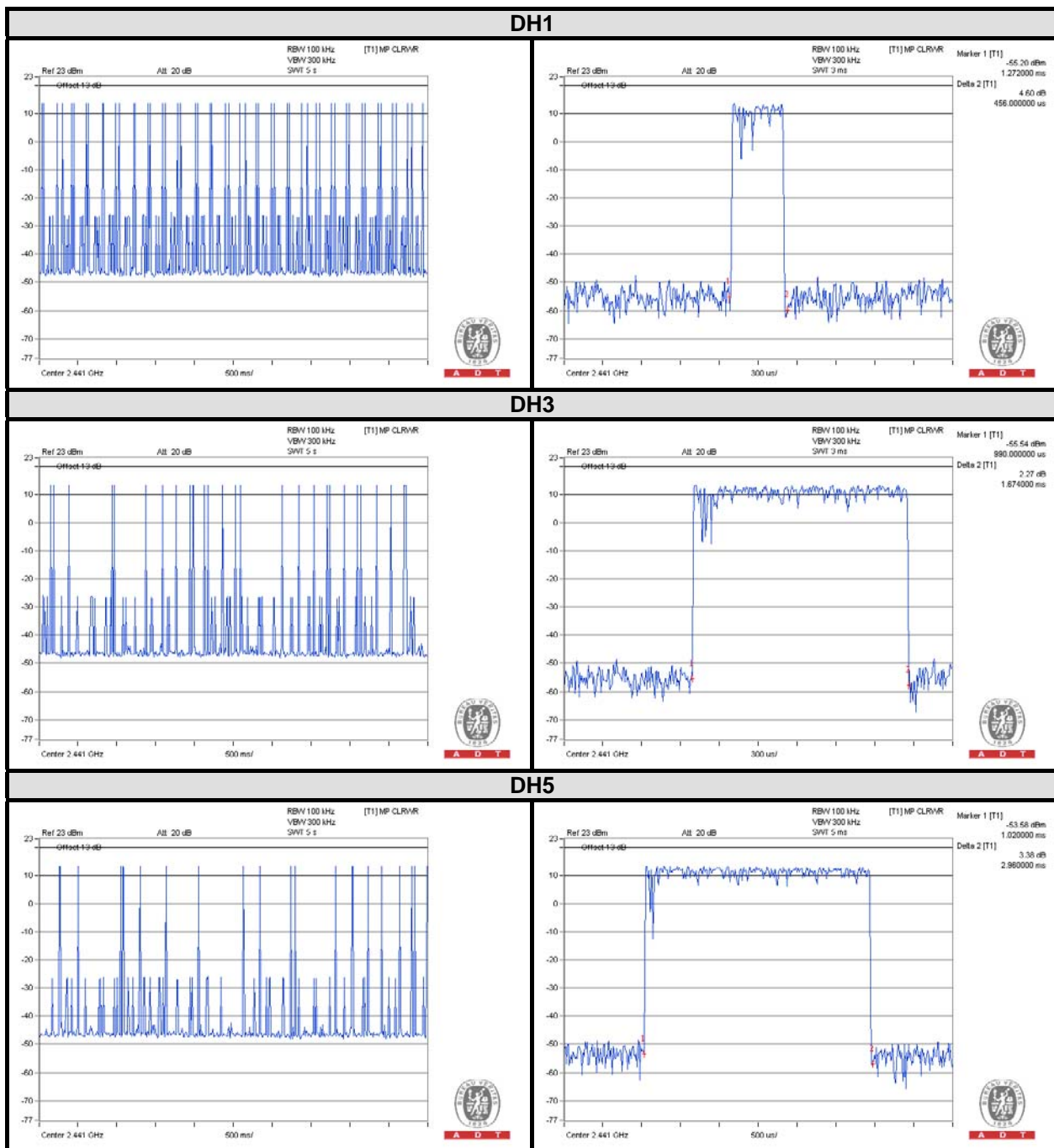



A D T

8DPSK

Mode	Number of transmission in a 31.6 (79Hopping*0.4)	Length of transmission time (msec)	Result (msec)	Limit (msec)
DH1	51 (times / 5 sec) * 6.32 = 322.32times	0.456	147.0	400
DH3	26 (times / 5 sec) * 6.32 = 164.32 times	1.680	276.1	400
DH5	16 (times / 5 sec) * 6.32 = 101.12 times	2.980	301.3	400

NOTE: Test plots of the transmitting time slot are shown as below.

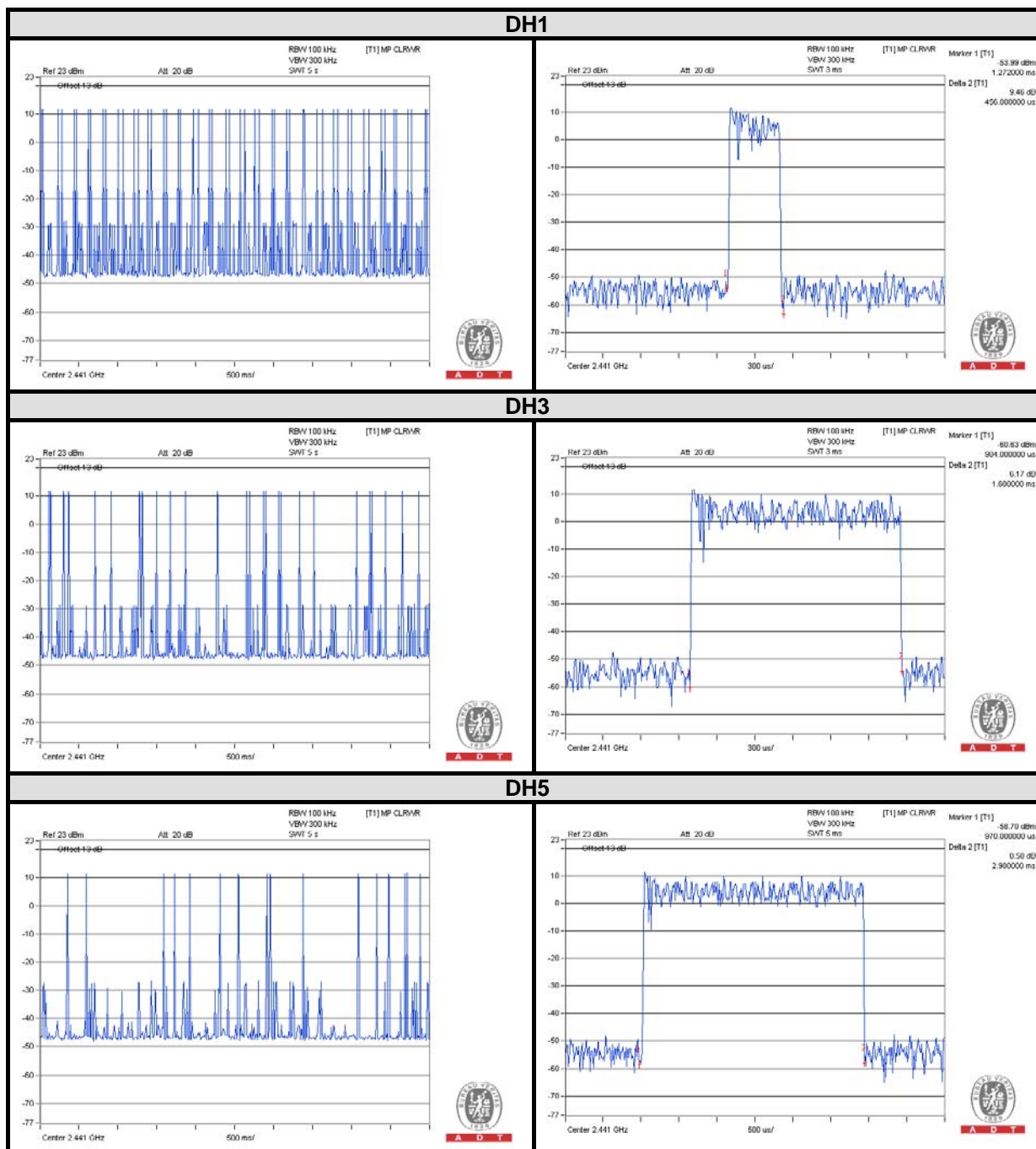

4.5 CHANNEL BANDWIDTH

4.5.1 LIMITS OF CHANNEL BANDWIDTH

For frequency hopping system operating in the 2400-2483.5MHz, If the 20dB bandwidth of hopping channel is greater than 25kHz, two-thirds 20dB bandwidth of hopping channel shall be a minimum limit for the hopping channel separation.

4.5.2 TEST SETUP

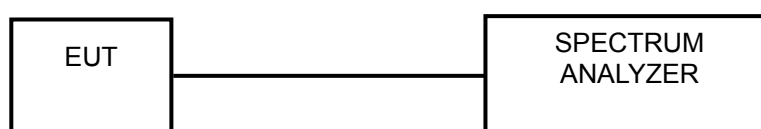

4.5.3 TEST INSTRUMENTS

Refer to section 4.1.2 to get information of above instrument.

4.5.4 TEST PROCEDURE

- a. Check the calibration of the measuring instrument using either an internal calibrator or a known signal from an external generator.
- b. Turn on the EUT and connect it to measurement instrument. Then set it to any one convenient frequency within its operating range. Set a reference level on the measuring instrument equal to the highest peak value.
- c. Measure the frequency difference of two frequencies that were attenuated 20dB from the reference level. Record the frequency difference as the emission bandwidth.
- d. Repeat above procedures until all frequencies measured were complete.

4.5.5 DEVIATION FROM TEST STANDARD

No deviation.

4.5.6 EUT OPERATING CONDITION

The software provided by client enabled the EUT to transmit and receive data at lowest, middle and highest channel frequencies individually.



A D T

4.5.7 TEST RESULTS

CHANNEL	FREQUENCY (MHz)	20dB BANDWIDTH (MHz)	
		GFSK	8DPSK
0	2402	0.840	1.310
39	2441	0.841	1.300
78	2480	0.844	1.300

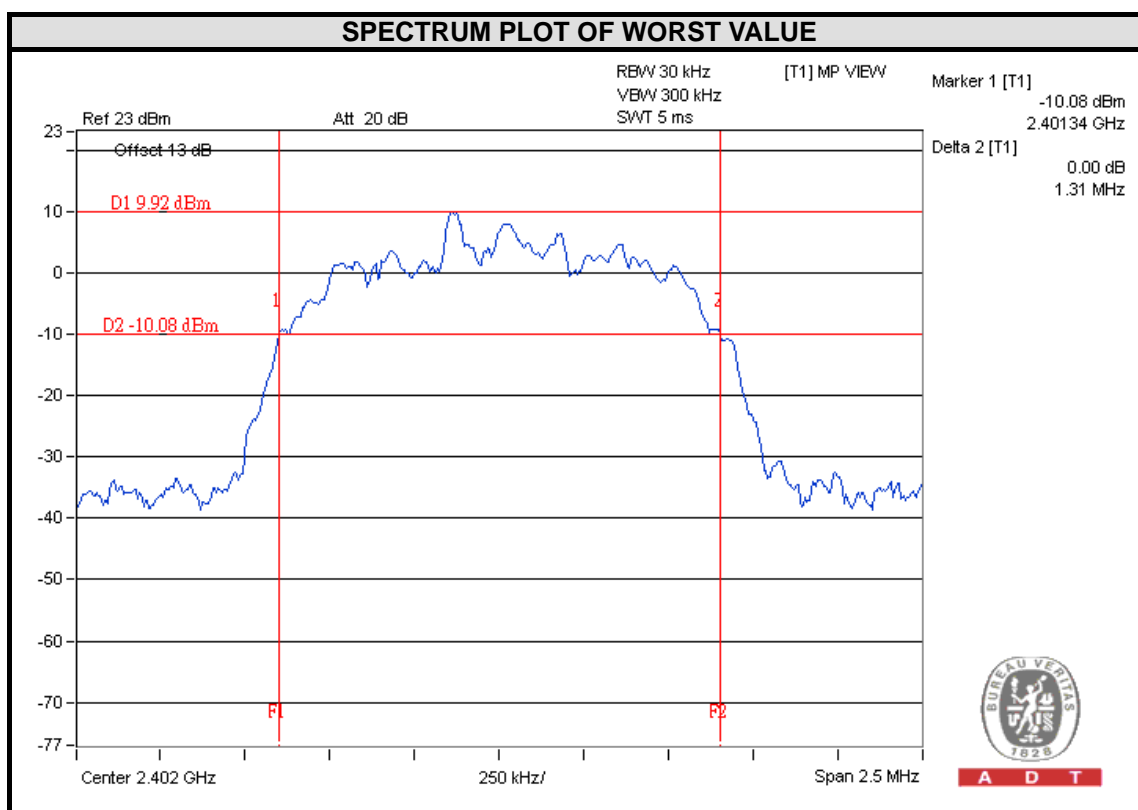

4.6 HOPPING CHANNEL SEPARATION

4.6.1 LIMIT OF HOPPING CHANNEL SEPARATION

At least 25kHz or two-third of 20dB hopping channel bandwidth (whichever is greater).

4.6.2 TEST SETUP

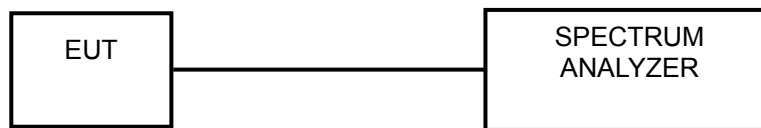

4.6.3 TEST INSTRUMENTS

Refer to section 4.1.2 to get information of above instrument.

4.6.4 TEST PROCEDURES

- a. Check the calibration of the measuring instrument using either an internal calibrator or a known signal from an external generator.
- b. Turn on the EUT and connect it to measurement instrument. Then set it to any one convenient frequency within its operating range.
- c. By using the MaxHold function record the separation of two adjacent channels.
- d. Measure the frequency difference of these two adjacent channels by SA MARK function. And then plot the result on SA screen.
- e. Repeat above procedures until all frequencies measured were complete.

4.6.5 DEVIATION FROM TEST STANDARD

No deviation.

4.6.6 TEST RESULTS

CHANNEL	FREQUENCY (MHz)	ADJACENT CHANNEL SEPARATION (MHz)		20dB BANDWIDTH (MHz)		MINIMUM LIMIT (MHz)		PASS / FAIL
		GFSK	8DPSK	GFSK	8DPSK	GFSK	8DPSK	
0	2402	1.010	1.010	0.840	1.310	0.560	0.873	PASS
39	2441	1.010	1.010	0.841	1.300	0.561	0.867	PASS
78	2480	1.010	1.000	0.844	1.300	0.563	0.867	PASS

NOTE: The minimum limit is two-third 20dB bandwidth.

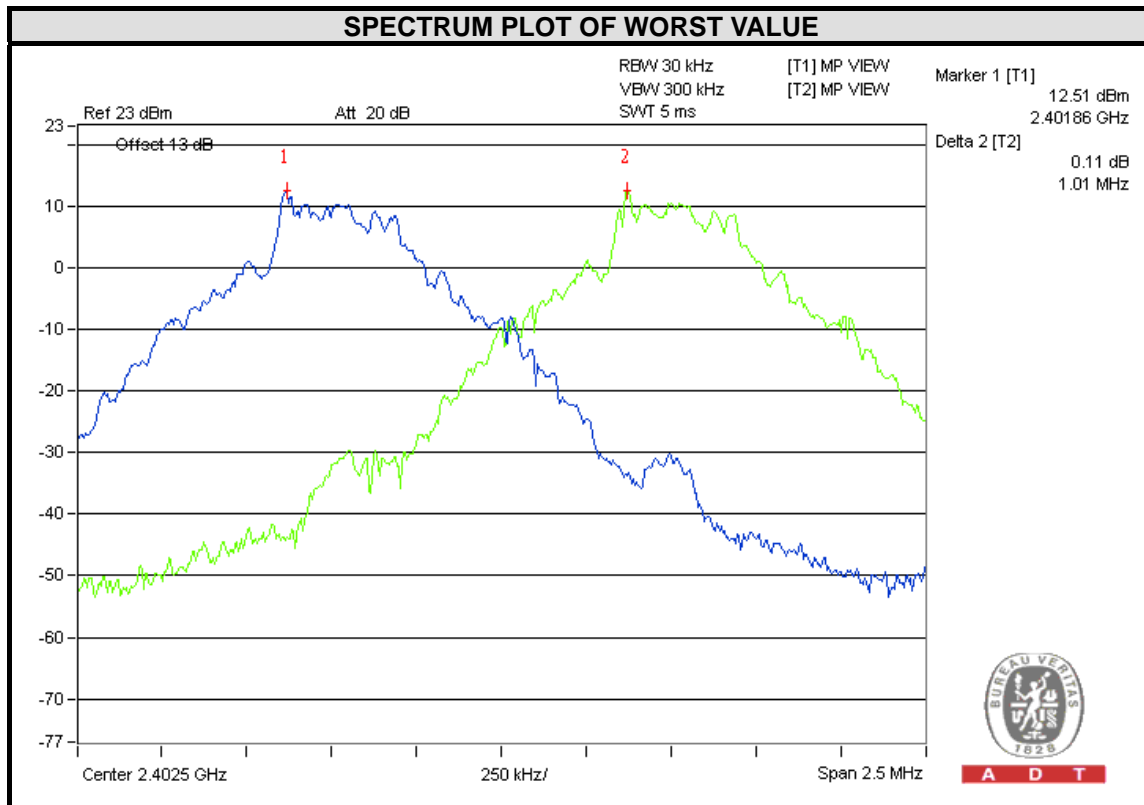

4.7 MAXIMUM OUTPUT POWER

4.7.1 LIMITS OF MAXIMUM OUTPUT POWER MEASUREMENT

The Maximum Output Power Measurement is 125mW.

4.7.2 TEST SETUP

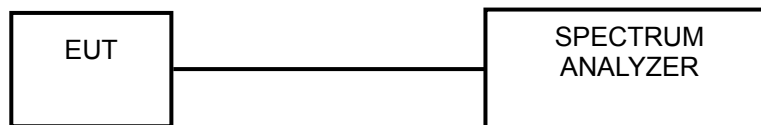

4.7.3 TEST INSTRUMENTS

Refer to section 4.1.2 to get information of above instrument.

4.7.4 TEST PROCEDURES

- a. Check the calibration of the measuring instrument using either an internal calibrator or a known signal from an external generator.
- b. Turn on the EUT and connect it to measurement instrument. Then set it to any one convenient frequency within its operating range. Set a reference level on the measuring instrument equal to the highest peak value.
- c. The center frequency of the spectrum analyzer is set to the fundamental frequency and using 3MHz RBW and 10 MHz VBW.
- d. Measure the captured power within the band and recording the plot.
- e. Repeat above procedures until all frequencies required were complete.

4.7.5 DEVIATION FROM TEST STANDARD

No deviation.

4.7.6 EUT OPERATING CONDITION

The software provided by client enabled the EUT to transmit and receive data at lowest, middle and highest channel frequencies individually.

4.7.7 TEST RESULTS

CHANNEL	FREQUENCY (MHz)	OUTPUT POWER (dBm)		OUTPUT POWER (mW)		POWER LIMIT (mW)	PASS / FAIL
		GFSK	8DPSK	GFSK	8DPSK		
0	2402	14.30	13.75	26.9	23.7	125	PASS
39	2441	14.58	14.21	28.7	26.4	125	PASS
78	2480	13.84	13.48	24.2	22.3	125	PASS

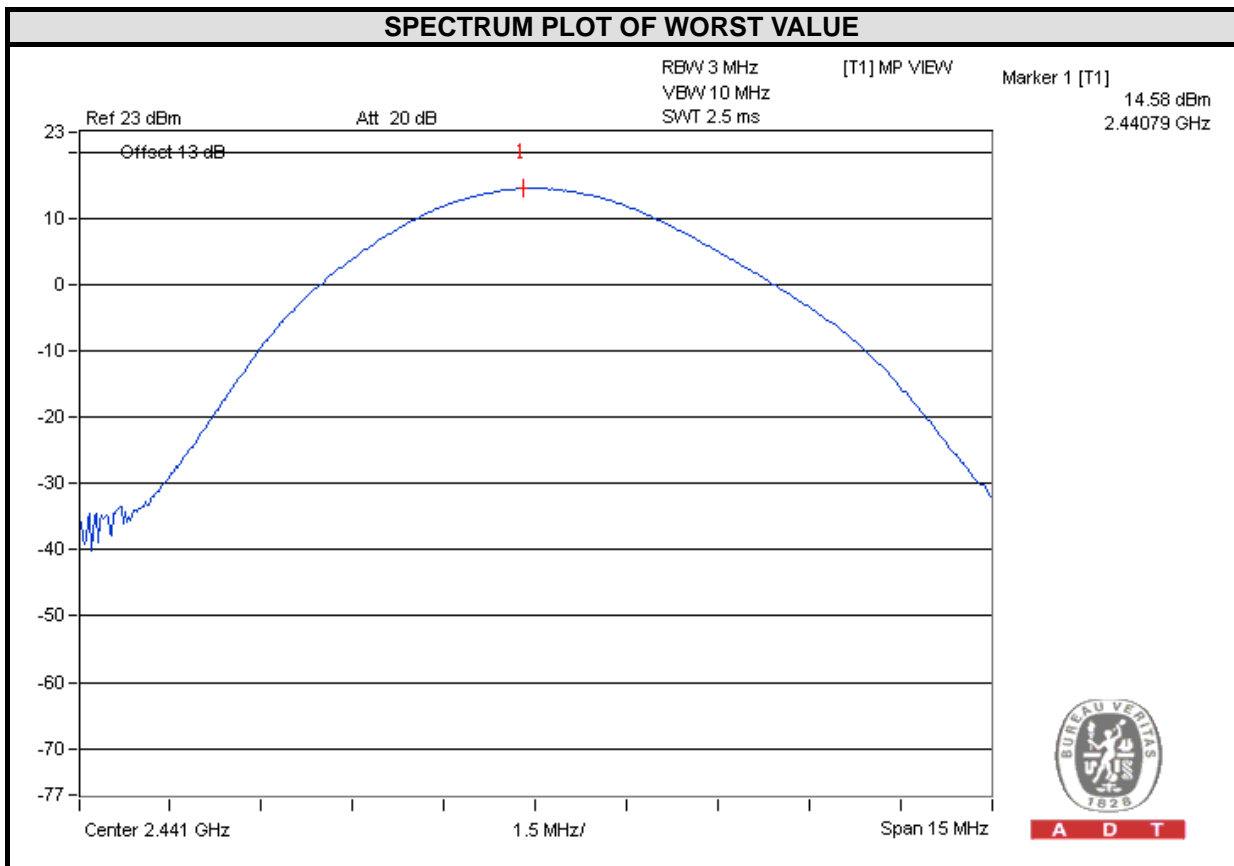

4.8 CONDUCTED OUT OF BAND EMISSION MEASUREMENT

4.8.1 LIMITS OF CONDUCTED OUT OF BAND EMISSION MEASUREMENT

Below -20dB of the highest emission level of operating band (in 100KHz RBW).

4.8.2 TEST INSTRUMENTS

Refer to section 4.1.2 to get information of above instrument.

4.8.3 TEST PROCEDURE

The transmitter output was connected to the spectrum analyzer via a low lose cable. Set both RBW and VBW of spectrum analyzer to 100 kHz and 300 kHz with suitable frequency span including 100 MHz bandwidth from band edge. The band edges was measured and recorded.

4.8.4 DEVIATION FROM TEST STANDARD

No deviation.

4.8.5 EUT OPERATING CONDITION

The software provided by client enabled the EUT to transmit and receive data at lowest, middle and highest channel frequencies individually.

4.8.6 TEST RESULTS

The spectrum plots are attached on the following images. D1 line indicates the highest level, D2 line indicates the 20dB offset below D1. It shows compliance with the requirement.



A D T

GFSK

Hopping disabled_ Low Channel

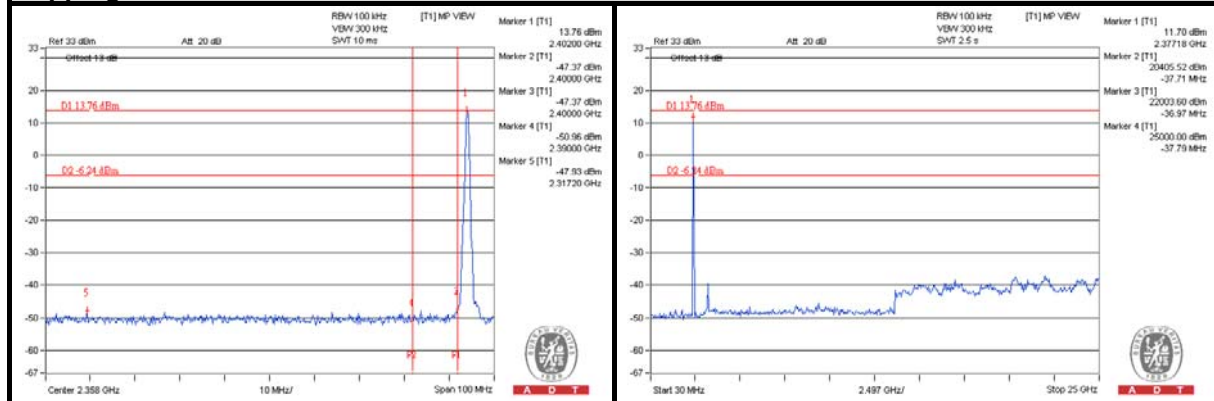

Hopping disabled_ High Channel

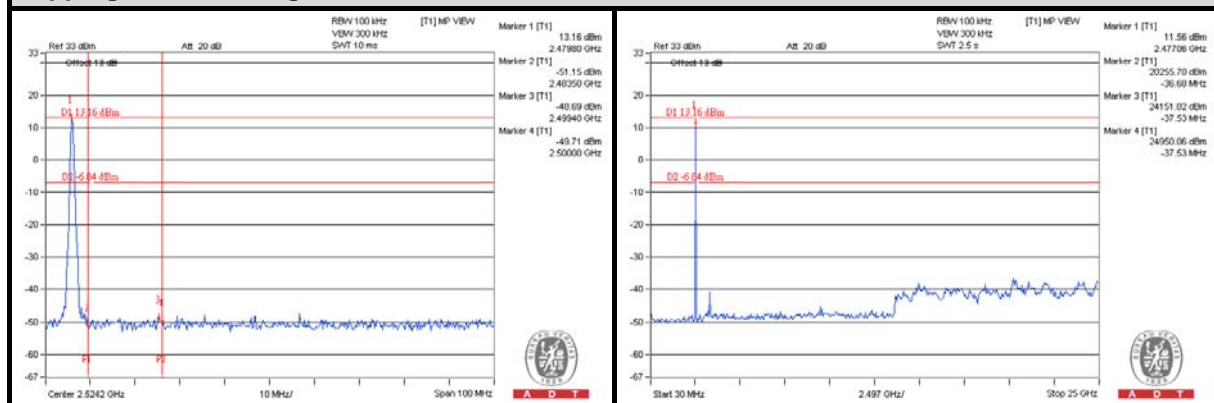

Hopping enabled_ Low Channel

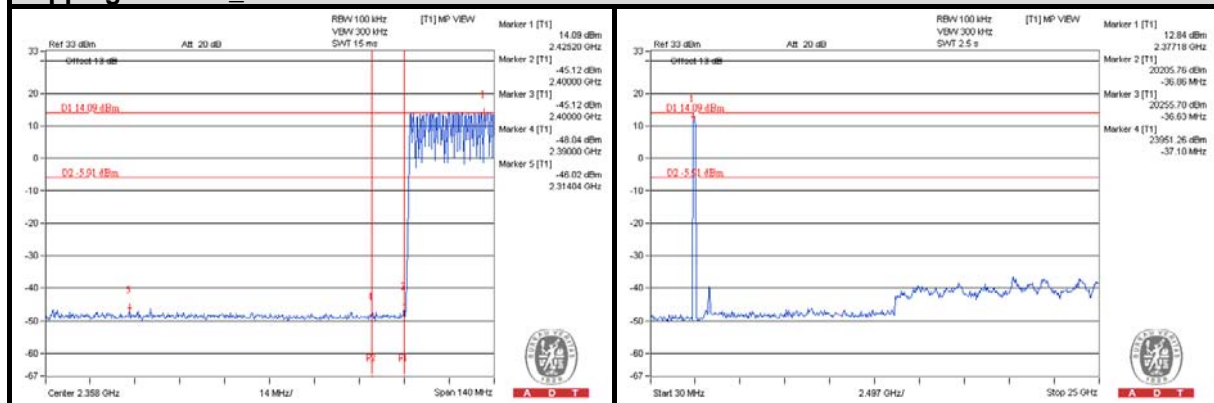

Hopping enabled_ High Channel

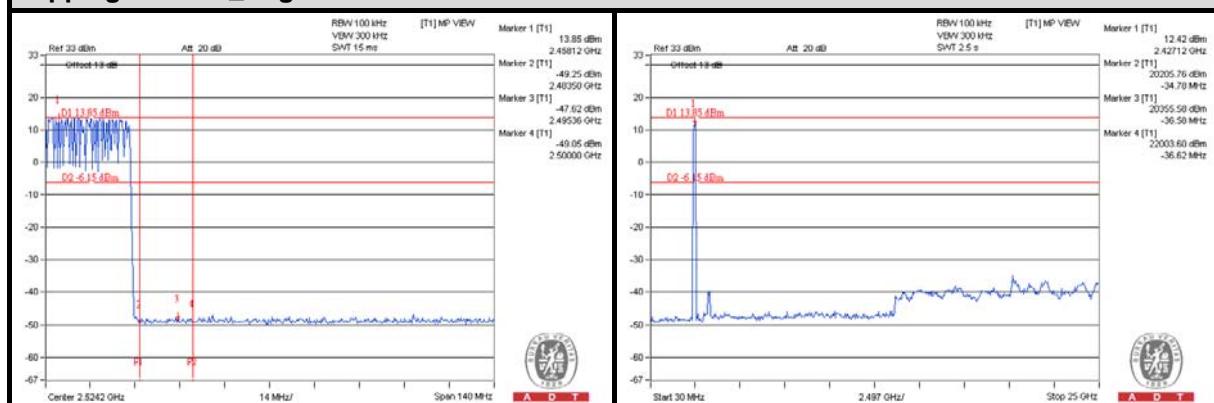



A D T

8DPSK

Hopping disabled _ Low Channel

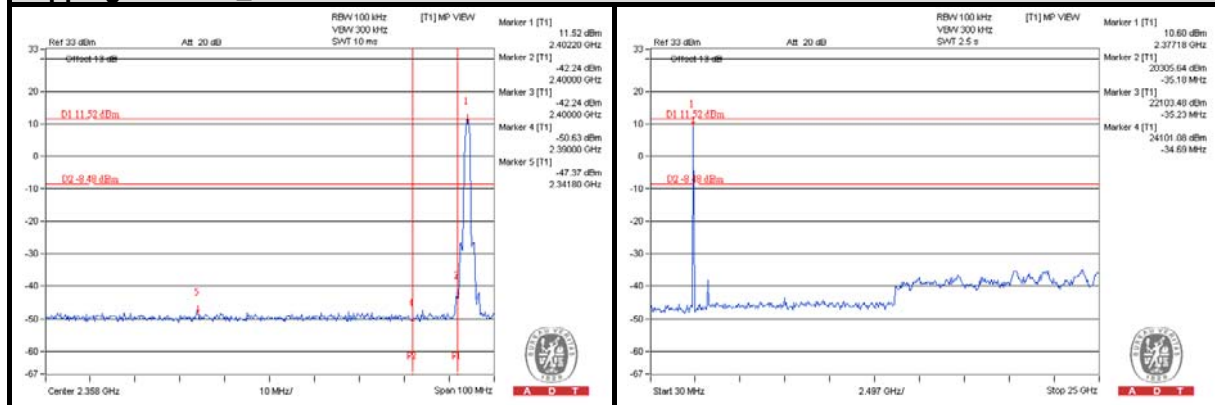

Hopping disabled _ High Channel

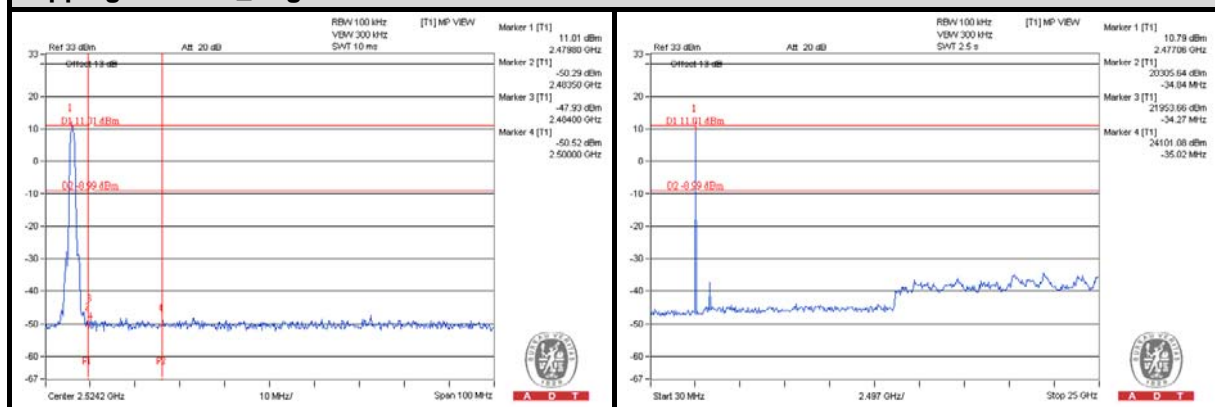

Hopping enabled _ Low Channel

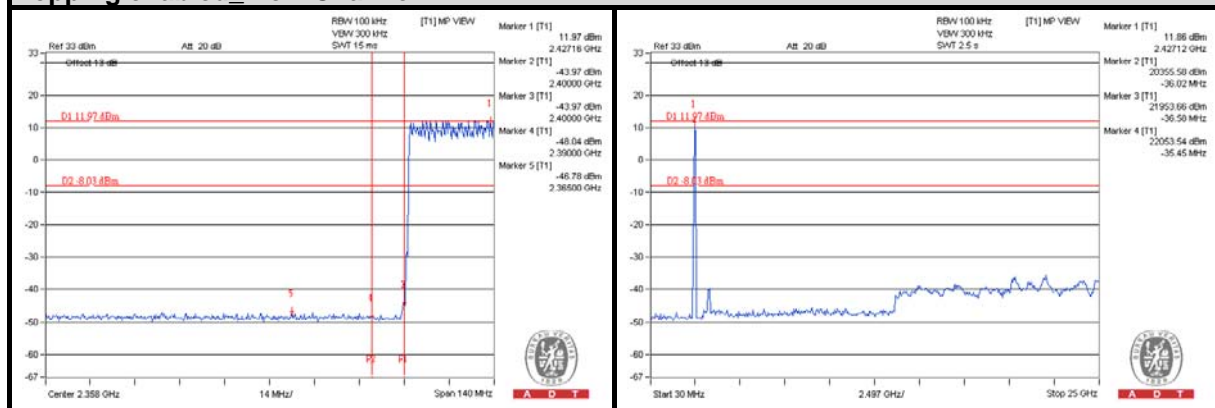

Hopping enabled _ High Channel

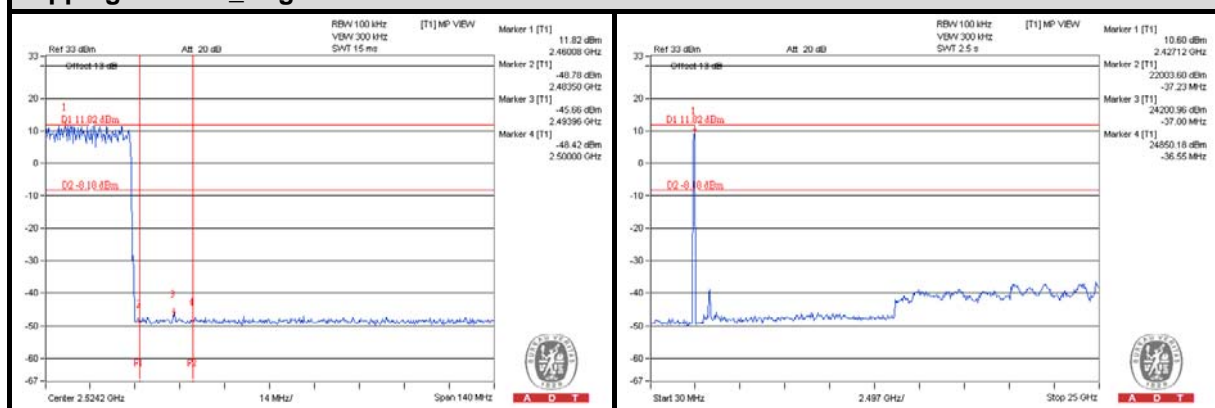

5. PHOTOGRAPHS OF THE TEST CONFIGURATION

Please refer to the attached file (Test Setup Photo).



6. INFORMATION ON THE TESTING LABORATORIES

We, Bureau Veritas Consumer Products Services (H.K.) Ltd., Taoyuan Branch, were founded in 1988 to provide our best service in EMC, Radio, Telecom and Safety consultation. Our laboratories are accredited and approved according to ISO/IEC 17025.

If you have any comments, please feel free to contact us at the following:

Linko EMC/RF Lab:

Tel: 886-2-26052180

Fax: 886-2-26051924

Hsin Chu EMC/RF Lab:

Tel: 886-3-5935343

Fax: 886-3-5935342

Hwa Ya EMC/RF/Safety/Telecom Lab:

Tel: 886-3-3183232

Fax: 886-3-3270892

Email: service.adt@tw.bureauveritas.com

Web Site: www.bureauveritas-adt.com

The address and road map of all our labs can be found in our web site also.



7. APPENDIX A - MODIFICATIONS RECORDERS FOR ENGINEERING CHANGES TO THE EUT BY THE LAB

No modifications were made to the EUT by the lab during the test.

--- END ---